

HP 8753B NETWORK ANALYZER SYSTEM OPERATING AND PROGRAMMING MANUAL

SERIAL NUMBERS

This manual applies directly to any HP 8753B network analyzer with the following serial prefix numbers:

2807A and 2828A

Later instrument versions - If the instrument serial prefix number is higher than that shown above, the instrument is different than that documented in this manual. If this is the case, a manual change supplement is supplied that documents the changes. To determine which manual changes apply to your instrument, refer to the History of Changes supplied with each change.

© Copyright HEWLETT-PACKARD COMPANY 1988
1400 FOUNTAINGROVE PARKWAY, SANTA ROSA, CA 95403 U.S.A.

MANUAL PART NO. 08753-90138
Microfiche Part Number 08753-90137

Printed: NOVEMBER 1988



**HEWLETT
PACKARD**

CERTIFICATION

Hewlett-Packard Company certifies that this product met its published specifications at the time of shipment from the factory. Hewlett-Packard further certifies that its calibration measurements are traceable to the United States National Bureau of Standards, to the extent allowed by the Bureau's calibration facility, and to the calibration facilities of other International Standards Organization members.

WARRANTY

This Hewlett-Packard system product is warranted against defects in materials and workmanship for a period corresponding to the individual warranty periods of its component products. Computer and computer peripherals are warranted for a period of 90 days. Instruments are warranted for a period of one year. During the warranty period, Hewlett-Packard Company will, at its option, either repair or replace products which prove to be defective.

Warranty service for products installed by HP and certain other products designated by HP will be performed at Buyer's facility at no charge within HP service travel areas. Outside HP service travel areas, warranty service will be performed at Buyer's facility only upon HP's prior agreement and Buyer shall pay HP's round trip travel expenses. In all other areas, products must be returned to a service facility designated by HP.

For products returned to HP for warranty service, Buyer shall prepay shipping charges to HP and HP shall pay shipping charges to return the product to Buyer. However, Buyer shall pay all shipping charges, duties, and taxes for products returned to HP from another country.

HP warrants that its software and firmware designated by HP for use with an instrument will execute its programming instructions when properly installed on that instrument. HP does not warrant that the operation of the instrument, or software, or firmware will be uninterrupted or error free.

LIMITATION OF WARRANTY

The foregoing warranty shall not apply to defects resulting from improper or inadequate maintenance by Buyer, Buyer-supplied software or interfacing, unauthorized modification or misuse, operation outside of the environmental specifications for the product, or improper site preparation or maintenance.

NO OTHER WARRANTY IS EXPRESSED OR IMPLIED. HP SPECIFICALLY DISCLAIMS THE IMPLIED WARRANTIES OR MERCHANTABILITY AND FITNESS FOR A PARTICULAR PURPOSE.

EXCLUSIVE REMEDIES

THE REMEDIES PROVIDED HEREIN ARE BUYER'S SOLE AND EXCLUSIVE REMEDIES. HP SHALL NOT BE LIABLE FOR ANY DIRECT, INDIRECT, SPECIAL, INCIDENTAL, OR CONSEQUENTIAL DAMAGES, WHETHER BASED ON CONTRACT, TORT, OR ANY OTHER LEGAL THEORY.

ASSISTANCE

Product maintenance agreements and other customer assistance agreements are available for Hewlett-Packard products.

For any assistance, contact your nearest Hewlett-Packard Sales and Service Office. Addresses are provided at the back of this manual.

HP 8753B Operating and Programming Manual

TABLE OF CONTENTS

GENERAL INFORMATION AND SPECIFICATIONS

About this Manual Set	2
System Operating and Programming	
Manual Description	2
On-Site System Service Manual Description	3
Test Sets and Accessories	
Manual Description	3
Instruments Covered by the Manual	4
Microfiche Copies of the Manual	4
HP 8753B Description	5
New Features	5
About Instrument Specifications	6
System Description	7
Hewlett-Packard Interface Bus (HP-IB)	7
Options Available	7
Option 002, Harmonic Mode	7
Option 006, 6 GHz Receiver Option	8
Option 010, Time Domain	8
Option 802, External Disc Drive	8
Option 908, Rack Mount Without Handles	8
Option 913, Rack Mount With Handles	8
Service and Support Options	8
Equipment Required	10
Test Sets Available	10
HP 85046A/B S-Parameter Test Sets	10
HP 85047A 6 GHz S-Parameter Test Set	10
HP 85044A/B Transmission/Reflection	
Test Sets	10
Measurement Accessories Available	11
Power Splitters	11
Calibration Kits	11
Verification Kit	12
Test Port Return Cables	13
Adapter Kits	13
Transistor Test Fixtures	13
System Accessories Available	
System Rack	14
Plotters and Printers	14
Mass Storage	14
HP-IB Cables	14
Computer	15
Sample Software	15
System Furniture	15
Discs and Disc Accessories	15
Recommended Test Equipment	15
Table 1. Instrument Specifications	17
Table 2. HP 8753B General Characteristics	27
System Performance	31

SYSTEM INSTALLATION

Site Preparation	1
Power Requirements	2
Environmental Requirements	2
Receiving and Inspection	2
Installation	3
Setting Up the Instruments	5
Bench-Top Systems	5
Rack-Mounted Systems	6
Automatic (Computer-Controlled Systems)	6
Power Considerations	9
Line Voltage and Fuse Selection	9
Power Cables	10
HP-IB Considerations	12
Other System Interconnections	15
Systems Using the HP 85046A/B or 85047A	
S-Parameter Test Set	15
Systems Using the HP 85044A/B Transmission/	
Reflection Test Set	15
Rear Panel BNC Connectors	16
Storage and Shipment	17
Installation Checklist	17
Service Tags	

OPERATOR'S CHECK

Operator's Check	1
In Case of Difficulty	3
Routine Maintenance	5
Cleaning the Fan Filter	5
Cleaning the CRT and Glass Filter	5
Connector Care	5

USER'S GUIDE

Operating the HP 8753B	4
Transmission Measurements with	
the HP 8753B	18
Reflection Measurements with the HP 8753B	27
Time Domain Analysis with the HP 8753B	35
Harmonic Measurements with the HP 8753B	39
Test Sequencing with the HP 8753B	41
Operation up to 6 GHz	44

HP-IB INTRODUCTORY PROGRAMMING GUIDE

Basic Instrument Control	3
Basic Programming Examples	7
Performing a measurement calibration	8
Data transfer from analyzer to computer	14
Advanced Programming Examples	19
Using limit lines to perform limit testing	22
Storing and recalling instrument states	25
Miscellaneous Programming Examples	28
Transferring disc data files	32
Appendix A: Status Reporting	33

HP-IB QUICK REFERENCE GUIDE

HP-IB Capabilities	2
General Information	2
Input Data	3
Output	5
Error Reporting	6
HP-IB Information	6

OPERATING AND PROGRAMMING REFERENCE

Chapter 1. System Overview

Guide to the Chapters in this Document	1-1
HP 8753B System Overview	1-2
HP 8753B Data Processing	1-3

Chapter 2. Front Panel and Softkey Operation

Active Function	2-1
Front Panel Keys and Softkey Menus	2-1
Front Panel Features	2-4
CRT Display	2-6
Status Notations	2-7
Active Channel Keys	2-8
Entry Block Keys	2-9
Rear Panel Features and Connections	2-11

Chapter 3. Stimulus Function Block

Test Set Attenuator, Test Port Transfer Switch, and Doubler Switch Protection	3-2
[START], [STOP], [CENTER], and [SPAN] keys	3-3
[MENU] Key (Stimulus, Power, Trigger, Sweep Type, and Frequency List)	3-4

Chapter 4. Response Function Block

[MEAS] Key (S-Parameter, Input Port, and Conversion)	4-3
[FORMAT] Key (Display Format and Group Delay)	4-8
[SCALE REF] Key (Scale Reference)	4-16
[DISPLAY] Key (Dual Channel, Split Display, CRT control, Data and Memory Functions, Beep Control, D2/D1 to D2, Frequency Blank, and Titles)	4-18
[AVG] Key	4-24

Chapter 5. Measurement Calibration

Accuracy Enhancement	5-2
Sources of Measurement Errors	5-2
Correcting for Measurement Errors	5-5
Why, After Calibration, Does the Frequency Response of Some Calibration Standards Appear as a Curve Rather Than a Dot? ...	5-8
Menus and Softkeys	5-10
[CAL] Key (Calibration Menus and Procedures) .	5-10
Purpose and Use of Different Calibration Procedures (Table)	5-20
Response Calibration for Reflection Measurements	5-21
Response Calibration for Transmission Measurements	5-22
Response and Isolation Calibration for Reflection Measurements	5-22
Response and Isolation Calibration for Transmission Measurements	5-23
S ₁₁ 1-Port Calibration for Reflection Measurements	5-24
S ₂₂ 1-Port Calibration	5-25
Full 2-Port Calibration for Reflection and Transmission Measurements	5-25
One-Path 2-Port Calibration for Reflection and Transmission Measurements	5-27
Power Meter Calibration	5-28
Using Power Meter Calibration	5-34
Modifying Calibration Kits	5-41
Verify Performance	5-51
Example Procedure	5-52
Appendix: Accuracy Enhancement Fundamentals	5-53

Chapter 6. Using Markers

[MKR] Key (Delta, Fixed, Mode, Polar, and Smith)	6-1
[MKR FCTN] Key (Marker Function and Search)	6-11

Chapter 7. Instrument State Function Block

Instrument State Features and Where They Are Described	7-2
[LOCAL] Key (HP-IB Menu and Address Menu) .	7-2
[SYSTEM] Key (Limit Lines Description Only) ...	7-7
See <i>Instrument State Features and Where They Are Described</i> to determine where other [SYSTEM] Key features are described	

Chapter 8. Time and Frequency

Domain Transforms

General Theory	8-2
Time Domain Concepts	8-12
Transforming CW Time Measurements Into the Frequency Domain	8-19

Chapter 9. Making a Hard Copy Output	
[COPY] Key	9-2
Chapter 10. Saving Instrument States	
Types of Memory	10-1
Internal Save	10-4
External Store	10-5
[SAVE] and [RECALL] Keys	
(With Associated Menus)	10-5
Chapter 11. HP-IB Remote Programming	
How HP-IB Works	11-2
HP-IB Bus Structure	11-3
HP-IB Requirements	11-5
HP 8753B HP-IB Capabilities	11-5
Bus Mode	11-6
Setting Addresses	11-7
Valid Characters	11-7
Units and Terminators	11-8
HP-IB Debug Mode	11-8
CRT Graphics	11-8
Chapter 12. Error Messages	
Error Messages in Alphabetic Order	12-1
Error Messages in Numerical Order	12-9
Chapter 13. Test Sequence Function	
What is Test Sequencing?	13-1
Creating a Sequence	13-2
Running a Sequence	13-2
Stopping a Sequence	13-2
Changing the Sequence Title	13-3
Editing a Sequence	13-3

Clearing a Sequence from Memory	13-4
Storing a Sequence to Disc	13-4
Loading a Sequence from Disc	13-5
Purging a Sequence from Disc	13-6
Printing a Sequence	13-6
In-Depth Sequencing Information	13-6
Basic Sequencing Menus	13-8
Sequencing Special Functions	13-15
Important Concepts	13-15
Autostarting Sequences	13-16
Sequencing Special Function Menus	13-16
HP-GL Considerations	13-20
Entering Sequences Using HP-IB	13-21
Reading Sequences Using HP-IB	13-21
Decision-Making Example Sequences	13-21
Chapter 14. Instrument Modes, 6 GHz, Frequency Offset, and Harmonic Operation	
Instrument Modes	14-2
Instrument Mode Overview	14-2
Network Analyzer Mode	14-4
External Source Mode	14-4
Tuned Receiver Mode	14-6
Other Features Available Under	
the System Key	14-8
Feature Overview	14-8
Frequency Offset Operation	14-8
6 GHz Operation (Option 006 Only)	14-12
Harmonic Operation (Option 002 Only)	14-14
Spurious Signal Passbands in External Source Mode, Tuned Receiver Mode, and Frequency Offset Operation	14-17



SAFETY CONSIDERATIONS

GENERAL

This product and related documentation must be reviewed for familiarization with safety markings and instructions before operation. This product has been designed and tested in accordance with international standards.

SAFETY SYMBOLS



Instruction manual symbol: the product will be marked with this symbol when it is necessary for the user to refer to the instruction manual (refer to Table of Contents).



Indicates hazardous voltages.



Indicates earth (ground) terminal.

WARNING

The WARNING sign denotes a hazard. It calls attention to a procedure, practice, or the like, which, if not correctly performed or adhered to, could result in personal injury. Do not proceed beyond a WARNING sign until the indicated conditions are fully understood and met.

CAUTION

The CAUTION sign denotes a hazard. It calls attention to an operating procedure, practice, or the like, which, if not correctly performed or adhered to, could result in damage to or destruction of part or all of the product. Do not proceed beyond a CAUTION sign until the indicated conditions are fully understood and met.

SAFETY EARTH GROUND

This is a Safety Class I product (provided with a protective earthing terminal). An uninterruptible safety earth ground must be provided from the main power source to the product input wiring terminals, power, cord, or supplied power cord set. Whenever it is likely that the protection has been impaired, the product must be made inoperative and secured against any unintended operation.

BEFORE APPLYING POWER

Verify that the product is configured to match the available main power source per the input power configuration instructions provided in this manual.

If this product is to be energized via an auto-transformer make sure the common terminal is connected to the neutral (grounded side of the mains supply).

SERVICING

WARNING

Any servicing, adjustment, maintenance, or repair of this product must be performed only by qualified personnel.

Adjustments described in this manual may be performed with power supplied to the product while protective covers are removed. Energy available at many points may, if contacted, result in personal injury.

Capacitors inside this product may still be charged even when disconnected from their power source.

To avoid a fire hazard, only fuses with the required current rating and of the specified type (normal blow, time delay, etc.) are to be used for replacement.

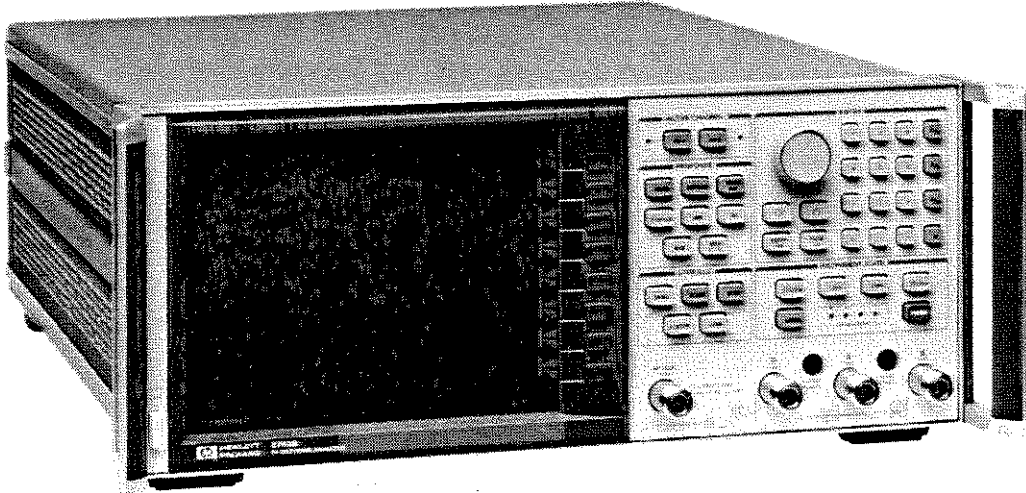

HP 8753B RF Network Analyzer

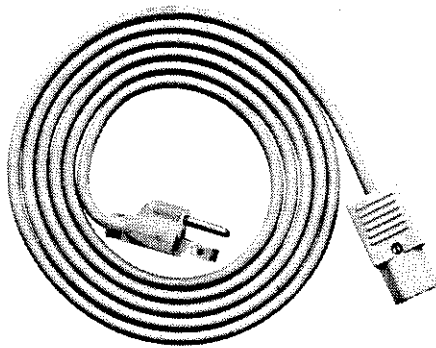

Power Cable*

* Power Cable/Plug Supplied Depends on Country of Destination

Figure 1-1. HP 8753B Network Analyzer with Power Cable Supplied

General Information and Specifications

CONTENTS

2	About This Manual Set
2	System Operating and Programming Manual Description
3	On-Site System Service Manual Description
3	Test Sets and Accessories Manual Description
4	Instruments Covered by the Manual
4	Microfiche Copies of the Manual
5	HP 8753B Description
5	New Features
6	About Instrument Specifications
7	System Description
7	Hewlett-Packard Interface Bus (HP-IB)
7	Options Available
10	Equipment Required
10	Test Sets Available
11	Measurement Accessories Available
14	System Accessories Available
17	Instrument Specifications
27	General Characteristics
31	System Performance
31	Introduction
31	Comparison of Typical Error-Corrected Measurement Uncertainty
36	Sources of Measurement Errors
37	System Error Model
38	Reflection Uncertainty Equations
39	Transmission Uncertainty Equations
40	Dynamic Accuracy
44	Effects of Temperature Drift
47	System Performance with Different Test Sets and Connector Types
55	Determining Expected System Performance
56	Reflection Measurement Uncertainty Worksheet
57	Transmission Measurement Uncertainty Worksheet

ABOUT THIS MANUAL SET

This *Hewlett-Packard 8753B Network Analyzer System Operating and Programming Manual* is a complete guide to operating the HP 8753B vector network analyzer alone or in a system. It is part of a three manual set, which also includes the *On-Site System Service Manual* and the *Test Sets and Accessories Manual* binder.

The *System Operating and Programming Manual* contains instructions for setting up and operating the HP 8753B network analyzer with related test sets and accessories, or in an automated system configuration with a controller. Information required to test, adjust, and service the HP 8753B is provided in the *On-Site System Service Manual*. The *Test Sets and Accessories Manual* binder is provided to hold the manuals supplied with the test sets and measurement accessories used with the HP 8753B. Figure 1 illustrates the HP 8753B with power cable supplied.

System Operating and Programming Manual Description

This manual consists of tabbed sections which provide the following information:

- **GENERAL INFORMATION AND SPECIFICATIONS** provides an outline of the manual set. It includes a description of the instrument and its available options, as well as the test sets and accessories available. In addition it provides tables of specifications and supplemental performance characteristics for the HP 8753B alone or in a system configuration.
- **SYSTEM INSTALLATION** provides information for site preparation and installation, including line voltage and fuse selection, bench-top and rack-mount configurations, connectors and cables, and HP-IB address selection. Checklists are supplied for site preparation and installation.
- **OPERATOR'S CHECK** is a brief procedure that provides reasonable confidence that the instrument or system is functional. It can be used following system installation, and is also appropriate for regular daily or weekly use. Also included in this section are instructions for routine operator's maintenance, and information to use in case of difficulty. This supplies solutions to operating problems, and references more detailed information in the service manual for cases when the problem cannot immediately be resolved.
- **USER'S GUIDE** is a step-by-step tutorial guide for making measurements with the HP 8753B using front panel controls.
- **HP-IB INTRODUCTORY PROGRAMMING GUIDE** describes remote operation of the HP 8753B with an HP 9000 series 200 or 300 computer as a controller. It includes examples of remote measurements using HP BASIC programming. These examples are also stored on the example programs disc provided with the HP 8753B. Familiarity with front panel operation of the HP 8753B is assumed.
- **HP-IB QUICK REFERENCE GUIDE** is a reference synopsis for remote operation of the HP 8753B with a controller. This programming note is intended for use by those familiar with HP-IB programming and the basic functions of the HP 8753B.
- **OPERATING AND PROGRAMMING REFERENCE** is a complete reference for both local and remote operation of the HP 8753B, organized functionally. It lists the instrument preset condition and provides illustrations and descriptions of all front and rear panel features. It shows a complete pictorial representation of the softkey menu structure. The purpose and use of all the front panel keys and softkeys are listed, together with their HP-IB equivalents and the expected indications and results. All HP-IB functions and commands are listed and explained.
- **QUICK OPERATING GUIDE**, packaged separately, is a pocket-sized reference book that contains a synopsis of the information likely to be needed most often by an operator using front panel controls. This guide assumes familiarity with the operation of a network analyzer.

On-Site System Service Manual Description

The *On-Site System Service Manual* supplied with every HP 8753B is divided into sections that provide the following information:

- **SERVICE AND EQUIPMENT OVERVIEW** is a brief outline of the service documentation, together with cross-references to the information in the *Operating and Programming Manual* and the *Test Sets and Accessories Manual*.
- **PREVENTIVE MAINTENANCE** provides procedures to maintain system components in peak operating condition. This section provides procedures for cleaning connectors, glass bezels, fan filters, etc. This section suggests that the user periodically print error terms used by the instrument. Error terms provide an indication of system errors the HP 8753B is correcting for internally. A history of this data can be used to show the condition of the system, and if any areas of performance have degraded.
- **ON-SITE VERIFICATION** provides two types of checks:

System Verification, is designed to verify system-level error-corrected measurement performance. Known traceable standards are measured and compared with recorded data. This automated procedure is contained in firmware internal to the HP 8753B, and does not require an external controller. A disc drive and power meter are required.

On-Site Tests, which verify selected performance parameters of the HP 8753B.

- **PERFORMANCE TESTS** provide tests to verify that HP 8753B instrument performance is in accordance with the individual listed specifications. Each of the performance tests provides traceability to known standards. Some tests are semi-automated and require the use of an external controller. The test software is supplied on a 3.5 inch disc with single-sided format, packaged inside the manual. The entire sequence of performance tests takes about four hours to run, not including instrument warm-up time.
- **ADJUSTMENTS** provide instructions for correct adjustment and alignment of the instrument after repair or replacement of an assembly. Procedures are given for reloading correction constants after replacement of one or more specified assemblies. Software for these semi-automated adjustment procedures is provided on disc with the performance test software.
- **SERVICE** explains how to troubleshoot and repair the HP 8753B to the assembly level. It provides step-by-step procedures to isolate a problem to the defective assembly. Theory of operation is provided, together with troubleshooting block diagrams and a complete list of all signal mnemonics and wiring connections.
- **REPLACEABLE PARTS** provides part numbers and illustrations of the HP 8753B replaceable assemblies and miscellaneous chassis parts, together with ordering information.

Test Sets and Accessories Manual Description

The *HP 8753B Test Sets and Accessories Manual* is a binder provided for convenient storage and organization of the manuals for the accessory products used with the HP 8753B. When it is shipped it is empty except for divider tabs, instructions, and a connector care manual. It is intended to be assembled by the user, using the tabs to divide the accessory manuals into groups according to type (test sets, power splitters, calibration kits, etc.). The measurement accessories available for use with the HP 8753B are listed and described later in this section.

The connector care manual describes all the types of connectors used in HP 8753B measurement accessories. It documents the considerations specific to each connector, and provides instructions for care and cleaning, as well as special techniques for prolonging connector life.

Instruments Covered by the Manual

Attached to the rear panel of the instrument is a serial number plate (illustrated in Figure 2). The serial number is in two parts. The first four digits followed by a letter comprise the serial number prefix; the last five digits are the suffix. The prefix is the same for all identical instruments; it changes only when a change is made to the instrument. The suffix, however, is assigned sequentially and is different for each instrument. This manual applies directly to instruments with the serial number prefix or prefixes listed on the title page.

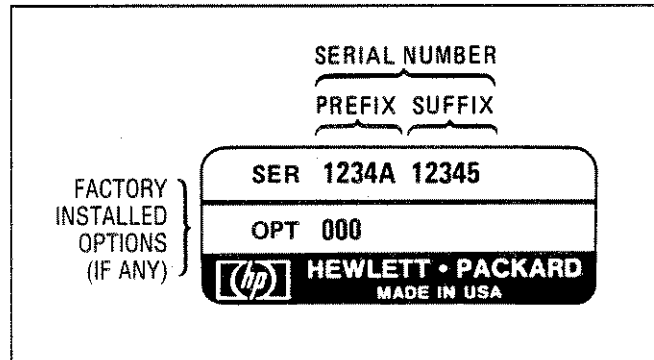

Figure 2. Typical Serial Number Plate

An instrument manufactured after the printing of this manual may have a serial number prefix that is not listed on the title page. An unlisted serial prefix indicates that the instrument is different from those documented in this manual. In this case, the manual for the newer instrument is accompanied by a yellow manual change supplement. This supplement contains serial-specific change information that explains how to adapt the manual for the newer instrument. In addition to change information, the supplement may contain replacement information that applies to all instruments regardless of their serial numbers.

To keep this manual as current as possible, Hewlett-Packard recommends that you periodically request the latest manual change supplement. The part number for the supplement is listed on the front page of the supplement's index. In addition, the supplement for this manual is identified with the manual's print date and part number, both of which appear on the title page of the manual.

Microfiche Copies of the Manual

On the title page of this volume is a microfiche part number. This number can be used to order a package of 10 x 15 centimeter (4 x 6 inch) microfilm transparencies of the manual.

Refer any questions regarding this manual, the manual change supplement, or the instrument to the nearest Hewlett-Packard Sales/Service Office. Always identify the instrument by model number, complete name, and complete serial number in all correspondence. A worldwide listing of HP Sales/Service Offices is provided at the back of this volume.

HP 8753B DESCRIPTION



A properly grounded AC outlet is mandatory when operating the HP 8753B. Operating the instrument with an improperly grounded or floating ground prong WILL DAMAGE THE INSTRUMENT!

The HP 8753B is a high performance vector network analyzer for laboratory or production measurements of reflection and transmission parameters. It integrates a high resolution synthesized RF source and a dual channel three-input receiver to measure and display magnitude, phase, and group delay responses of active and passive RF networks. Option 002 provides swept harmonic measurements of RF amplifiers. Option 006 extends the frequency range of the three-input receiver to 6 GHz. Option 010 provides the capability of transforming measured data from the frequency domain to the time domain. For information on other options, refer to *Options Available* later in this section.

Two independent display channels and a large screen CRT display the measured results of one or both channels, in rectangular or polar/Smith chart formats.

Digital signal processing and microprocessor controls combine to provide easy operation and measurement improvement. Measurement functions are selected with front panel keys and softkey menus. Displayed measurement results can be printed or plotted directly to a compatible peripheral without the use of an external computer. Instrument states can be saved in internal memory for at least three days. In addition, the instrument can control a compatible disc drive for external storage capability. Built-in service diagnostics are available to simplify troubleshooting procedures.

Trace math, data averaging, trace smoothing, electrical delay, and accuracy enhancement provide performance improvement and flexibility. Accuracy enhancement methods range from normalizing data to complete one or two port vector error correction. Vector error correction reduces the effects of system directivity, frequency response, source and load match, and crosstalk.

In combination with its compatible test sets and accessories, the HP 8753B has the ability to make complete reflection and transmission measurements in both 50 and 75 ohm impedance environments.

New Features

In addition to the above capabilities, the HP 8753B has several new features not included in the HP 8753A. The new features include:

1601 Error Corrected Measurement Points. The HP 8753B allows full two-port error correction with 1601 measurement points.

Automatic Sweep Time. The HP 8753B can automatically adjust sweep time to sweep as fast as possible for the given IF bandwidth, number of points, averaging mode, frequency range, number of points, and sweep type.

External Source Capability. External Source Mode allows you to phase lock the HP 8753B receiver to an external source. Refer to *Operating and Programming Reference* Chapter 14.

Independent Receiver Use. The Tuned Receiver Mode allows you to use the receiver as a stand-alone device. CW measurements are possible with a synthesized external source. This mode is used in non-phase-locked applications which require great speed, or that require arbitrary measurements at certain frequencies. Refer to *Operating and Programming Reference* Chapter 14.

Receiver/Source Frequency Offset. For mixer test applications, the HP 8753B's receiver and source may be programmed with a fixed frequency offset. The HP 8753B will maintain phase-lock with a mixer placed between its RF output and R input port. An external source is required as a local oscillator. Refer to *Operating and Programming Reference* Chapter 14.

Power Meter Calibration. The HP 8753B uses an HP-IB compatible power meter to monitor and correct its output power at each point. A power correction table stores the correction values. This feature may be used in either of two ways:

- The power meter measures and corrects every sweep (continuous correction). This method should be used in applications where high speed is not a critical factor.
- The instrument measures and corrects power in a sample sweep. Subsequent sweeps are corrected by the values in the power correction table. This method is much faster than continuous correction.

Refer to the *Operating and Programming Reference* Chapter 5.

Interpolated Error Correction. This allows the operator to perform any type of calibration, and then display any subset of that frequency range or use a different number of points. If the operator changes only the frequency range, interpolated error correction uses the same number of points as the original calibration. New error coefficients are interpolated from the coefficients of the original calibration. Interpolated error correction provides a great improvement over uncorrected measurements, but is not specified. Refer to *Operating and Programming Reference* Chapter 5.

Segmented Error Correction in Frequency List Mode. Frequency list mode now allows the operator to select any frequency segment from the list — and retain full specified calibration. Refer to *Operating and Programming Reference* Chapter 3.

Automated Operation Without an External Computer Controller. The test sequence function allows the operator to save all keystrokes in a particular measurement task, and have the HP 8753B perform them automatically at a later time. This feature combines simple operation with many advanced features, such as; sequence stacking, conditional jumps, user-defined prompts, and many others. Sequences may be stored to an optional external disc drive. Refer to *Operating and Programming Reference* Chapter 13.

Harmonic Measurements (Option 002). This displays the second or third harmonic of the fundamental while sweeping either frequency or power. The fundamental may be displayed simultaneously. The minimum fundamental frequency is 16 MHz, and harmonics can not be measured if they exceed the upper frequency range of the instrument. Refer to *Operating and Programming Reference* Chapter 14.

Plotter/Printer Buffer. The buffer allows a single plot or print-out to be made while the instrument continues to make measurements.

About Instrument Specifications

Table 1 in this section lists HP 8753B instrument specifications. These are coded in four levels, ranging from performance standards or limits that are tested by the performance tests in the service manual, to typical but non-warranted instrument performance parameters. Table 2 lists supplemental characteristics.

SYSTEM DESCRIPTION

An HP 8753B system consists of the HP 8753B with one of the following test sets/accessories:

- HP 85046A/B or 85047A S-parameter test set
- HP 85044A/B transmission/reflection test set
- HP 11850C/D or 11667A power splitter

In addition to one of the above, an HP 8753B system requires a compatible Hewlett-Packard calibration kit and the necessary cables. The compatible test sets, power splitters, calibration kits, and cables are described under *Test Sets Available* and *Measurement Accessories Available* later in this section.

The system may also include other compatible peripherals such as a printer, plotter, or optional disc drive. The printer and plotter are described under *Other Accessories Available*. The optional disc drive is described under *Options Available*.

The system can be automated with the addition of an HP 9000 series 200 or 300 computer. This allows all of the HP 8753B's measurement capabilities to be programmed over the Hewlett-Packard Interface Bus (HP-IB).

HEWLETT-PACKARD INTERFACE BUS (HP-IB)

The HP 8753B is factory-equipped with a remote programming interface using the Hewlett-Packard Interface Bus (HP-IB). HP-IB is Hewlett-Packard's hardware, software, documentation, and support for IEEE-488.1 and IEC-625, worldwide standards for interfacing instruments. This provides a remote operator with the same control of the instrument available to the local operator, except for control of the power line switch and some internal tests. Remote control is maintained by a controlling computer that sends commands or instructions to and receives data from the HP 8753B using the HP-IB. Several output modes are available for outputting data. Through a subset of HP-GL (Hewlett-Packard Graphics Language), user graphics can be plotted on the HP 8753B CRT. A complete general description of HP-IB is available in *Condensed Description of the Hewlett-Packard Interface Bus* (HP part number 59401-90030), and in *Tutorial Description of the Hewlett-Packard Interface Bus* (HP literature number 5952-0156).

The HP 8753B itself can use HP-IB to output measurement results directly to a compatible printer or plotter, to store instrument states using an optional disc drive, without the use of an external computer. It can also control a power meter for power calibration.

OPTIONS AVAILABLE

Option 002, Harmonic Mode

The HP 8753B, when equipped with this option, can measure second or third harmonics of the DUT's fundamental output signal. Frequency and power sweep are supported in this mode. Harmonic frequencies may be measured up to the maximum frequency of the receiver. However, the fundamental frequency may not be lower than 16 MHz.

Option 006, 6 GHz Receiver Operation

This option extends the maximum receiver frequency of the HP 8753B to 6 GHz, although it does not extend the maximum frequency of the built-in RF source. When used with the HP 85047A S-parameter test set, the HP 8753B option 006 provides high performance vector measurement capability to 6 GHz.

Option 010, Time Domain

The HP 8753B option 010 has the capability of displaying the time domain response of a network by computing the inverse Fourier transform of the frequency domain response. This provides the ability to view the response of a test device as a function of time or distance. Displaying the reflection coefficient of a network versus time determines the magnitude and location of each discontinuity, or displaying the transmission coefficient of a network versus time determines the characteristics of individual transmission paths. Time domain operation retains all accuracy inherent with the calibration that is active in the frequency domain. The time domain capability is useful for the design and characterization of such devices as SAW filters, SAW delay lines, RF cables, and RF antennas.

Option 802, External Disc Drive

This provides an HP 9122 dual 3.5 inch microfloppy disc drive. This double-sided drive provides a total of 1420 kbytes of formatted capacity. Ordering numbers for discs and disc holders are provided in *Other Accessories Available*, later in this section. The one-year on-site warranty provided with the HP 8753B (where available) also applies to this disc drive.

Option 908, Rack Mount Without Handles

Option 908 is a rack mount kit containing a pair of flanges and the necessary hardware to mount the instrument, with handles detached, in an equipment rack with 482.6 mm (19 inches) horizontal spacing. Refer to the System Installation section of this manual for instructions on removing the handles and preparing the instrument for rack mounting with this option kit.

Option 913, Rack Mount With Handles

Option 913 is a rack mount kit containing a pair of flanges and the necessary hardware to mount the instrument with handles attached in an equipment rack with 482.6 mm (19 inches) spacing. Refer to *System Installation* for instructions.

Service and Support Options

The HP 8753B automatically includes a one-year on-site service warranty, where available. The following service and support products are available with an HP 8753B system at any time during or after the time of purchase. The "system" consists of an HP 8753B with either a 85044A, 85046A, or 85047A test set; either an HP 11851B or 11857D cable kit; and an HP 85031B 7 mm calibration kit. Some restrictions apply to 75 ohm systems, i.e. those with an HP 85044B or 85046B test set. Consult your local HP customer engineer for details.

On-Site Installation and System Verification (+23N) provides installation of the HP 8753B system by a Hewlett-Packard customer engineer, and performance of the system verification procedure described below.

On-Site System Verification (+23G), performed by a Hewlett-Packard customer engineer, confirms the system's error-corrected uncertainty performance by measuring traceable 7 mm devices. It provides a hardcopy listing of both ideal and actual data, together with a certificate of traceability. Preventive maintenance is performed at the time of system verification. Travel through Zone 3 (up to 100 miles/160 km from Hewlett-Packard's nearest service-responsible office) is included.

On-Site Service and System Verification (+02A) provides four-hour on-site response through Travel Zone 3 on all service requests for the HP 8753B and a 50 ohm test set by a Hewlett-Packard customer engineer. Two on-site system verification procedures (described above) are included per year. Preventive maintenance is performed at the time of system verification.

On-Site Service and System Verification (+02B) provides next day on-site response through Travel Zone 3 on all service requests for the HP 8753B and a 50 ohm test set by a Hewlett-Packard customer engineer. Two on-site system verification procedures with preventive maintenance are included per year.

Return to HP Full Service Agreement (+22A) is a one-year service contract that provides for any repair of the HP 8753B at a Hewlett-Packard repair facility. One complete calibration procedure is included.

Return to HP Repair Agreement (+22B) provides repair of the HP 8753B at a Hewlett-Packard repair facility for a period of one year. Following repair, the instrument is tested functionally but is not fully calibrated.

Return to HP Calibration Agreement (+22C) provides a once-a-year complete calibration procedure at a Hewlett-Packard facility.

Return to HP Calibration (+22G) is a one-time complete calibration procedure performed at a Hewlett-Packard facility. The procedure verifies that the HP 8753B is performing according to its published specifications.

Tool Kit: a dedicated tool kit is available for HP 8753B troubleshooting, consisting of extender boards, extender cables, and adapters. The contents of the tool kit are listed in the *On-Site System Service Manual*.

Option 910, Extra Manual Set provides an additional *Operating and Programming Manual*, *On-Site System Service Manual*, and *Test Sets and Accessories Manual*. After initial shipment, order extra manuals by part number. The numbers are listed on the title page and rear cover of the manuals and in the *Replaceable Parts* section of the *On-Site System Service* manual.

NOTE: Because the *Test Sets and Accessories Manual* is essentially an empty binder for holding separate accessory manuals, it has not been made separately available. It is suggested that any commonly available binder be used instead. However, if the entire manual set is ordered as a unit, it will contain the *Test Sets and Accessories Manual*.

EQUIPMENT REQUIRED

In order to make measurements, the HP 8753B requires a portion of the RF signal to be routed to the reference input for proper network analyzer phase-locked operation. Therefore, a test set or power splitter is required for signal separation. In addition, connecting cables and standard devices for calibration are required. The compatible Hewlett-Packard devices are described under *Test Sets Available and Measurement Accessories Available*.

For automatic operation, an HP 9000 series 200/300 computer is recommended. This computer is also required to run automated performance tests or adjustment procedures.

TEST SETS AVAILABLE

HP 85046A/B S-Parameter Test Sets

The HP 85046A/B S-parameter test sets provide the signal separation devices, RF path switching, and external connectors to enable the HP 8753B to measure all four S-parameters of a two-port 50 or 75 ohm device with a single connection. The HP 85046A measures the responses of 50 ohm devices from 300 kHz to 3.0 GHz, and the HP 85046B measures the responses of 75 ohm devices from 300 kHz to 2.0 GHz. The test sets are totally controlled from the HP 8753B and include a 0 to 70 dB step attenuator programmable in 10 dB steps. Each test set also contains two internal DC bias tees for biasing of active devices.

The test port connectors for the HP 85046A are precision 7 mm connectors, and the HP 85046B test port connectors are 75 ohm type-N (f). Both connectors can be adapted to other interfaces with the appropriate precision adapters. Four interconnect cables are included to connect the test set to the HP 8753B. In addition, test port return cables are required: HP 11857D cables with the HP 85046A, or HP 11857B 75 ohm cables with the HP 85046B.

HP 85047A 6 GHz S-Parameter Test Set

The HP 85047A is similar to the 50 Ω HP 85046A test set, but operates up to 6 GHz. This test set includes a frequency doubler that can be switched in to measure 3 MHz to 6 GHz in a single sweep or switched out to measure 300 kHz to 3 GHz in a single sweep. The HP 85047A is equipped with a 70 dB step attenuator and internal DC bias tees. The test port connectors are precision 7 mm. Four interconnect cables are included to connect the test set to the HP 8753B. HP 11857D test port return cables must be ordered separately.

HP 85044A/B Transmission/Reflection Test Sets

The HP 85044A/B transmission/reflection test sets provide the signal separation devices and external connectors that enable the HP 8753B to simultaneously measure the reflection and transmission characteristics of a 50 or 75 ohm device in one direction. The HP 85044A measures the responses of 50 ohm devices from 300 kHz to 3.0 GHz, and the HP 85044B measures the responses of 75 ohm devices from 300 kHz to 2.0 GHz. Both test sets include a 0 to 70 dB step attenuator manually controllable in 10 dB steps, and the circuitry necessary to allow biasing of active devices through the test set.

The test port connectors are precision 7 mm on the HP 85044A and 75 ohm type-N (f) on the HP 85044B, and they can be adapted to other interfaces with the appropriate precision adapters. A 7 mm to 50 ohm type-N (f) adapter is included with the HP 85044A. An HP 11852B 50 to 75 ohm minimum loss pad is included with the HP 85044B, to provide a low SWR impedance match between the output port of the device under test and the return cable to the network analyzer. The HP 11851B 50 ohm type-N RF cable set is required for use with either of these transmission/reflection test sets.

MEASUREMENT ACCESSORIES AVAILABLE

Power Splitters

HP 11850C/D Three-Way Power Splitters. These are four-port, three-way power splitters. One output arm is used as the reference for the network analyzer in making ratio measurements and the other two output arms are test channels. The HP 11850C has a frequency range of DC to 3 GHz and an impedance of 50 ohms; the HP 11850D has a frequency range of DC to 2 GHz and an impedance of 75 ohms. Three HP 11852A 50 to 75 ohm minimum loss pads are supplied with the HP 11850D power splitter, to provide a low SWR impedance match between the power splitter and the 50 ohm ports of the network analyzer.

HP 11667A Power Splitter. This is a two-way power splitter with one output arm used for reference and one for test. It has a frequency range of DC to 18 GHz and an impedance of 50 ohms.

Calibration Kits

Vector error correction (measurement calibration) procedures require that the systematic errors of a measurement system be characterized by measuring known devices (standards) on the system over the frequency range of interest. The following calibration kits contain precision standard devices with different connector types, to characterize the systematic errors of an HP 8753B measurement system. The part numbers for the devices in each calibration kit are listed in the manual supplied with the calibration kit.

HP 85031B 7 mm Calibration Kit. The precision standards in this kit are used to calibrate the HP 8753B with an HP 85046A/47A S-parameter test set or HP 85044A transmission/reflection test set for measurement of devices with precision 7 mm connectors. The following standards are included:

- Two 7 mm 50 ohm terminations
- One 7 mm combination short/open

HP 85032B 50 Ohm Type-N Calibration Kit. The precision standards in this kit are used to calibrate the HP 8753B with an HP 85046A, 85047A, or 85044A test set for measurement of devices with 50 ohm type-N connectors. The adapters are all of the same electrical length to facilitate calibration of non-insertable devices (see *Operating and Programming Reference*). The kit consists of the following standards:

- (1) type-N (m) 50 ohm termination
- (1) type-N (f) 50 ohm termination
- (1) type-N (m) short circuit
- (1) type-N (f) short circuit
- (1) type-N (m) open circuit with center conductor extender
- (1) type-N (f) open circuit
- (2) 7 mm to type-N (m) adapters
- (2) 7 mm to type-N (f) adapters

HP 85033C 3.5 mm Calibration Kit. This kit contains precision standards used to calibrate the HP 8753B with an HP 85046A, 85047A, or 85044A test set for measurement of devices with precision 3.5 mm connectors. The adapters are all of the same electrical length to facilitate calibration of non-insertable devices. The kit consists of the following standards:

- (1) 3.5 mm (m) 50 ohm termination
- (1) 3.5 mm (f) 50 ohm termination
- (1) 3.5 mm (f) short circuit
- (1) 3.5 mm (m) short circuit
- (1) 3.5 mm (f) open circuit with center conductor extender
- (1) 3.5 mm (m) open circuit with center conductor extender
- (2) 7 mm to 3.5 mm (m) adapters
- (2) 7 mm to 3.5 mm (f) adapters

HP 85036B 75 Ohm Type-N Calibration Kit. This kit contains precision standards used to calibrate the HP 8753B with an HP 85046B or 85044B 75 ohm test set for measurement of devices with 75 ohm type-N connectors. The adapters are all of the same electrical length to facilitate calibration of non-insertable devices. The kit consists of the following standards:

- (1) type-N (m) 75 ohm termination
- (1) type-N (f) 75 ohm termination
- (1) type-N (f) 75 ohm short circuit
- (1) type-N (m) 75 ohm short circuit
- (1) type-N (f) 75 ohm open circuit
- (1) type-N (m) 75 ohm open circuit with center conductor extender
- (1) type-N (m) to type-N (m) 75 ohm adapter
- (1) type-N (f) to type-N (f) 75 ohm adapter
- (1) type-N (f) to type-N (m) 75 ohm adapter

HP 85033A SMA Calibration Kit. The standards in this kit are used to calibrate the HP 8753B with a test set for measurement of devices with SMA connectors. These are not precision devices, and should be used only in applications where some degradation of performance is acceptable. (For maximum accuracy use the HP 85033C precision 3.5 mm calibration kit.) The following devices are included:

- (1) SMA (f) 50 ohm termination
- (1) SMA (m) 50 ohm termination
- (1) SMA (f) short circuit
- (1) SMA (m) short circuit
- (1) SMA (m) open circuit (option 001 only)
- (1) SMA (f) open circuit (option 001 only)
- (2) 7 mm to SMA (m) adapters
- (2) 7 mm to SMA (f) adapters

Verification Kit

Accurate operation of the HP 8753B system can be verified by measuring known devices other than the standards used in calibration, and comparing the results with recorded data.

HP 85029B 7 mm Verification Kit. This kit contains traceable precision 7 mm devices used to confirm the system's error-corrected measurement uncertainty performance. Also included is verification data on a 3.5 inch disc, together with a hard-copy listing. A system verification procedure is provided with this kit and also in the *On-Site System Service Manual*.

Test Port Return Cables

The following RF cables are used to return the transmitted signal to the test set in measurements of two-port devices. These cables provide shielding for high dynamic range measurements.

HP 11857D 7 mm Test Port Return Cable Set. These are a pair of test port return cables for use with the HP 85046A or 85047A S-parameter test sets. The cables can be used in measurements of devices with connectors other than 7 mm by using the appropriate precision adapters.

HP 11857B 75 Ohm Type-N Test Port Return Cable Set. These are a pair of test port return cables for use with the HP 85046B S-parameter test set.

HP 11851B 50 Ohm Type-N RF Cable Set. This kit contains the three phase-matched 50 ohm type-N cables necessary to connect the HP 85044A/B transmission/reflection test set or a power splitter to the HP 8753B, as well as an RF cable to return the transmitted signal of a two-port device to the network analyzer. For use with the HP 85044B test set, the HP 11852B 50 to 75 ohm minimum loss pad supplied with the test set must be used for impedance matching with the RF return cable.

Adapter Kits

HP 11852B 50 to 75 Ohm Minimum Loss Pad. This device converts impedance from 50 ohms to 75 ohms or from 75 ohms to 50 ohms. It is used to provide a low SWR impedance match between a 75 ohm device under test and the HP 8753B network analyzer or a 50 ohm measurement accessory. An HP 11852B pad is included with the HP 85044B 75 ohm transmission/reflection test set. Three HP 11852B pads are included with the HP 11850D 75 ohm power splitter.

HP 11853A 50 Ohm Type-N Adapter Kit. This kit contains the connecting hardware required for making measurements on devices with 50 ohm type-N connectors.

HP 11854A 50 Ohm BNC Adapter Kit. This kit contains the connecting hardware required for making measurements on devices with 50 ohm BNC connectors.

HP 11855A 75 Ohm Type-N Adapter Kit. This kit contains the connecting hardware required for making measurements on devices with 75 ohm type-N connectors.

HP 11856A 75 Ohm BNC Adapter Kit. This kit contains the connecting hardware required for making measurements on devices with 75 ohm BNC connectors.

Transistor Test Fixtures

HP 11600B and 11602B Transistor Fixtures. These fixtures are used to hold devices for S-parameter measurements in a 50 ohm coaxial circuit. They can be used to measure bipolar or field-effect transistors in several configurations, from DC to 2.0 GHz. The HP 11600B accepts transistors with TO-18 to TO-72 package dimensions, and the HP 11602B accepts transistors with TO-5 to TO-12 package dimensions. Both fixtures can also be used to measure other circuit elements such as diodes, resistors, or inductors, which have 0.016 to 0.019 inch diameter leads.

HP 11608A Option 003 Transistor Fixture. This fixture is designed to be user-milled to hold stripline transistors for S-parameter measurements. Option 003 is pre-milled for 0.205 inch diameter disc packages, such as the HP HPAC-200.

HP 11858A Transistor Fixture Adapter. This transistor fixture adapter provides a rigid RF cable interconnection between the HP 85046A or 85047A S-parameter test set and the HP 11600B, 11602B, or 11608A transistor fixture.

SYSTEM ACCESSORIES AVAILABLE

System Rack

The HP 85043B system rack is a 124 cm (49 inch) high metal cabinet designed to rack mount the HP 8753B in a system configuration. The rack is equipped with a large built-in work surface, a drawer for calibration kits and other hardware, a bookshelf for system manuals, and a locking rear door for secured access. Lightweight steel instrument support rails support the instruments along their entire depth. Heavy-duty casters make the cabinet easily movable even with the instruments in place. Screw-down lock feet permit leveling and semi-permanent installation: the cabinet is extremely stable when the lock feet are down. Power is supplied to the cabinet through a heavy-duty grounded primary power cable, and to the individual instruments through special power cables included with the cabinet.

Plotters and Printers

The HP 8753B is capable of plotting or printing displayed measurement results directly to a compatible peripheral without the use of an external computer. The plotters listed below are compatible with the HP 8753B. Note that the HP 8753B has a printer buffer built into its firmware. This buffer allows one hardcopy print or plot to proceed while the instrument makes measurements.

HP 7440A Option 002 ColorPro Eight-Pen Color Graphics Plotter plots on ISO A4 or 8 1/2 x 11 inch charts.

HP 7475A Option 002 Six-Pen Graphics Plotter plots on ISO A4/A3 or 8 1/2 x 11 inch or 11 x 17 inch charts.

HP 7550A High-Speed Eight-Pen Graphics Plotter plots on ISO A4/A3 or 8 1/2 x 11 inch or 11 x 17 inch plots.

HP 7090 Measurement Plotting System is a high-performance six-pen programmable digital plotter. It plots on ISO A4/A3 or 8.5 x 11 inch or 11 x 17 inch paper or overhead transparency film.

Printers. The compatible printers for both printing and plotting are:

- HP 2225A ThinkJet printer
- HP 82906A option 002 graphics printer
- HP 2673A thermal graphics printer
- HP 9876A thermal graphics printer.

Mass Storage

The HP 8753B has the capability of storing instrument states directly to an external mass storage device without the use of a computer. Any disc drive that uses CS80 protocol and HP 200/300 series (LIF) format is compatible. Discs may be formatted directly by the HP 8753B. An HP 9122 Dual 3.5 inch floppy disc drive is supplied when the HP 8753B option 802 is ordered. Another recommended disc drive is the HP 9153C 20 Megabyte Winchester disc drive

HP-IB Cables

An HP-IB cable is required for interfacing the HP 8753B with a plotter, printer, external disc drive, or computer. The cables available are HP 18033A (1 m), HP 10833B (2 m), and HP 10833D (0.5 m).

Computer

An external controller is not required for error correction or time domain capability. However, the system can be automated with the addition of an HP 200/300 series computer. In addition, some performance test procedures are semi-automated and require the use of an external controller. (The system verification procedure does not require an external controller.) For more information about compatible computers, call your Hewlett-Packard customer engineer.

Sample Software

A sample measurement program is provided with the HP 8753B, on a 3.5 inch disc inserted at the back of this manual. The program includes typical measurements to be used as an introductory example for programming the HP 8753B over HP-IB. It is designed to be easily modified for use in developing programs for specific needs. The program is compatible with BASIC versions 2.0 and later and will run on an HP series 200/300 computer, using any HP 8753B compatible printer or plotter.

System Furniture

A table is required for the system controller and the plotter or printer. The recommended work station table is HP 92170G, which is 720 mm (28 in) high by 930 mm (36 in) wide by 712 mm (28 in) deep and mounted on casters.

Discs and Disc Accessories

Hewlett-Packard discs are warranted against defects in material and workmanship for a period of five years from date of delivery. Price information is available from the toll-free number shown below. If you wish, ask for the free *HP Personal Computer User's Catalog*.

To order: CALL TOLL FREE 1-800-538-8787. Orders ship within 24 hours.

HP Part Number	Description
92192A	Box of 10 3.5 inch microfloppy discs
92191R	Rosewood roll-top disc holder. Holds 50 discs.
92191Q	Acrylic lift-top disc holder. Holds 25 discs.
92191E	Set of five modular disc holders. Holds 10 discs per module.
92191T	Bookshelf-style folding plastic disc holder. Holds 10 discs.
92191M	Micro disc carry case. Holds 5 discs.
92191H	Disc library binder. Holds 20 discs initially.
92191L	20 additional pages for binder. Holds 40 additional discs.

RECOMMENDED TEST EQUIPMENT

Equipment required to test, adjust, and service the HP 8753B system is listed in the beginning of the *On-Site System Service Manual*. Other equipment may be substituted if it meets or exceeds the critical specifications listed.

SAFETY CONSIDERATIONS

This manual is intended for use by the operator of the HP 8753B. Operating personnel must not remove the instrument covers. The instrument should be serviced only by qualified personnel who are aware of the hazards involved. Detailed safety precautions are described in the service manual.

Instrument Specifications

Table 1. HP 8753B Instrument Specifications (1 of 10)

The specifications listed in Table 1 range from those guaranteed by Hewlett-Packard to those typical of most HP 8753B instruments but not guaranteed. Codes in the far right column of Table 1 reference a specification definition listed below. These definitions are intended to clarify the extent to which Hewlett-Packard supports the specified performance of the HP 8753B.

S-1: This performance parameter is verifiable using performance tests documented in the service manual.

* Explicitly tested as part of an on-site verification performed by Hewlett-Packard.

S-2: Due to limitations on available industry standards, the guaranteed performance of the instrument cannot be verified outside the factory. Field procedures can verify performance with a confidence prescribed by available standards.

S-3: These specifications are generally digital functions or are mathematically derived from tested specifications, and can therefore be verified by functional pass/fail testing.

T: Typical but non-warranted performance characteristics intended to provide information useful in applying the instrument. Typical characteristics are representative of most instruments, though not necessarily tested in each unit. Not field tested.

SOURCE

FREQUENCY CHARACTERISTICS

		Code
Range	300 kHz to 3 GHz	S-1 *
Accuracy (at 25°C ± 5°C)	± 10 ppm	S-1 *
Stability		
0° to 55°C	± 7.5 ppm	T
per year	± 3 ppm	T
Resolution	1 Hz	S-3

OUTPUT POWER CHARACTERISTICS

Range	-5 to +20 dBm	S-1 *
Resolution	0.1 dB	S-3
Level Accuracy (at +10 dBm output level, 50 MHz)	± 0.5 dB	S-1 *
(at 25°C ± 5°C)		
Flatness (at 25°C ± 5°C)	± 1 dB	S-1 *
Linearity (at 25°C ± 5°C)		
-5 to +15 dBm	± 0.2 dB (relative to +10 dBm output level)	S-1
+15 to +20 dBm	± 0.5 dB (relative to +10 dBm output level)	S-1
Impedance	50 ohms; >16 dB return loss (<1.38 SWR)	T

Table 1. HP 8753B Instrument Specifications (2 of 10)

SOURCE (Cont'd)

SPECTRAL PURITY CHARACTERISTICS

(with 0 to -10 dBm into R input)

		Code
2nd Harmonic		
at +20 dBm output level	< -25 dBc	S-1 *
at +10 dBm	< -40 dBc	T
at 0 dBm	< -50 dBc	T
3rd Harmonic		
at +20 dBm output level	< -25 dBc	S-1 *
at +10 dBm	< -40 dBc	T
at 0 dBm	< -50 dBc	T
Non-Harmonic Spurious Signals		
Mixer Related		
at +20 dBm output level	< -32 dBc	S-1
at 0 dBm output level	< -55 dBc	T
Other Spurious Signals (see graph) (25°C ± 5°C)		
<i>(within 20 kHz)</i>		
f < 135 MHz	-60 dBc	S-1
f ≥ 135 MHz	$[-60 + 20 \log (f/135 \text{ MHz})]$ dBc	S-1

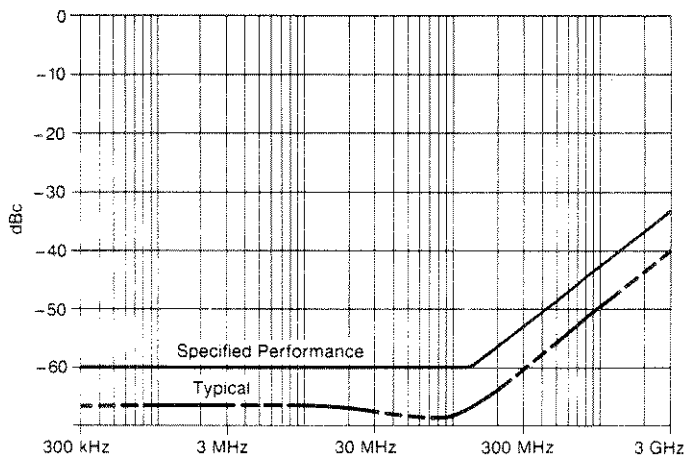

Other Spurious Signals

Phase Noise (10 kHz offset from fundamental in 1 Hz bandwidths)

f < 135 MHz	-90 dBc	S-1
f ≥ 135 MHz	$[-90 + 20 \log (f/135 \text{ MHz})]$ dBc	S-1

Table 1. HP 8753B Instrument Specifications (3 of 10)

RECEIVER

INPUT CHARACTERISTICS

	Code
Frequency Range	
Standard	300 kHz to 3 GHz S-1 *
Option 006 ¹	300 kHz to 6 GHz S-1 *
Impedance	50 ohms nominal
300 kHz to 2 MHz	>20 dB return loss S-1
2 MHz to 2 GHz	>23 dB return loss S-1
2 GHz to 3 GHz	>20 dB return loss S-1
3 GHz to 6 GHz ¹	>8 dB return loss T
Dynamic Range (10 Hz IF bandwidth)	
A, B	
300 kHz to 3 GHz	100 dB S-1
3 GHz to 6 GHz ¹	95 dB S-1
R	
300 kHz to 3 GHz	35 dB S-1
3 GHz to 6 GHz ¹	30 dB S-1
Maximum Input Level	0 dBm S-1
Damage Level	+20 dBm or >25 volts DC T
Noise Level (A, B)	
300 kHz to 3 GHz	
3 kHz IF bandwidth	-90 dBm S-1
10 Hz IF bandwidth	-100 dBm S-1
	-110 dBm T
3 GHz to 6 GHz ¹	
3 kHz IF bandwidth	-85 dBm S-1
10 Hz IF bandwidth	-95 dBm S-1
	-105 T
Minimum R Level	
(required for source operation)	
300 kHz to 3 GHz	-35 dBm S-1
3 GHz to 6 GHz ¹	-30 dBm S-1

1. Operation from 3 GHz to 6 GHz requires option 006. Operation from 3 GHz to 6 GHz in the normal network analyzer mode requires option 006 and an HP 85047A S-parameter test set.

Table 1. HP 8753B Instrument Specifications (4 of 10)

RECEIVER (Cont'd)

INPUT CHARACTERISTICS (Cont'd)

Input Crosstalk (10 Hz IF bandwidth) (see graphs)		Code
300 kHz to 1 GHz	-100 dB	S-1
1 GHz to 3 GHz	-90 dB	S-1
3 GHz to 4.5 GHz ¹	-82 dB	S-1
4.5 GHz to 6 GHz ¹	-75 dB	S-1

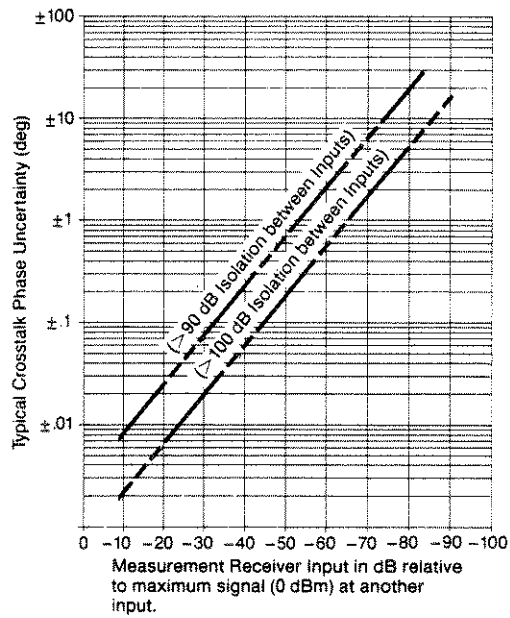
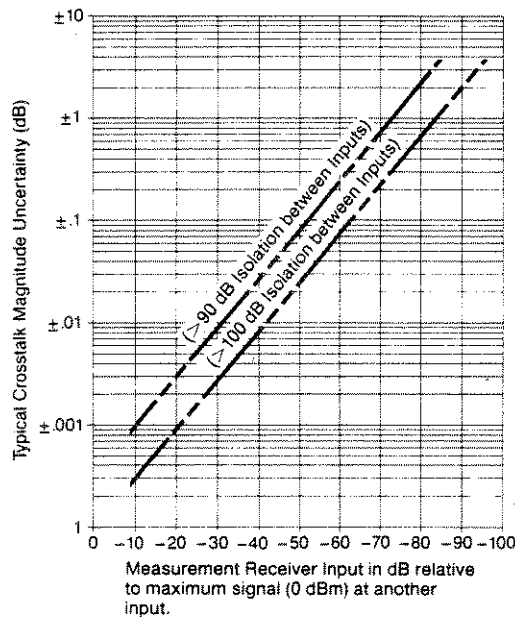

Input Crosstalk

Source Crosstalk (10 Hz IF bandwidth)	< -135 dB	T
---------------------------------------	-----------	---

Receiver Harmonics (option 002)

2nd Harmonic		
at 0 dBm input level	-15 dBc	S-1 *
at -10 dBm	-35 dBc	T
at -30 dBm	-45 dBc	T
3rd Harmonic		
at 0 dBm input level	-30 dBc	S-1 *
at -10 dBm	-50 dBc	T
at -30 dBm	-50 dBc	T
Harmonic Measurement Accuracy		
16 MHz to 3 GHz	±1 dB	S-1
3 GHz to 6 GHz ¹	±3 dB	S-1
Harmonic Measurement Dynamic Range	-40 dBc	T
<i>(with source at 0 dBm and receiver at < -30 dBm)</i>		

1. Operation from 3 GHz to 6 GHz requires option 006. Operation from 3 GHz to 6 GHz in the normal network analyzer mode requires option 006 and an HP 85047A S-parameter test set.

Table 1. HP 8753B Instrument Specifications (5 of 10)

RECEIVER (Cont'd)

INPUT CHARACTERISTICS (Cont'd)

Frequency Offset Operation^{1,2}

	Code
Frequency Range	16 MHz to 3 GHz S-1

R Channel Input Requirements (required for phase-locked operation)

Power Level	0 to -35 dBm S-1
LO Spectral Purity and Accuracy	
Maximum Spurious Input	< -25 dBc T
Residual FM	< 20 kHz T
Frequency Accuracy	-1 to +5 MHz of nominal frequency T

Accuracy (see *Magnitude Characteristics* and *Phase Characteristics*)

External Source Mode^{2,3} (CW Time sweep only)

Frequency Range ⁴	300 kHz to 6 GHz S-1
------------------------------------	----------------------------

R Input Requirements

Power Level	0 to -25 dBm S-1
Spectral Purity	
Maximum Spurious Input	< -30 dBc T
Residual FM	< 20 kHz T

Settling Time

Auto	500 ms T
Manual	50 ms T

Frequency Readout Accuracy (auto)	0.1% T
---	--------------

Input Frequency Margin

Manual	-0.5 to 5 MHz T
Auto	
≤ 50 MHz	± 5 MHz of nominal CW frequency T
> 50 MHz	± 10% of nominal CW frequency T

Accuracy (see *Magnitude Characteristics* and *Phase Characteristics*)³

1. The HP 8753B RF source characteristics in this mode are dependent on the stability of the external LO source. The RF source tracks the LO to maintain a stable IF signal at the R channel receiver input. Degradation in accuracy is negligible with an HP 8642A/B or HP 8656B RF signal generator as the LO source.
2. Refer to Chapter 14 of the *Operating and Programming Reference* for a functional description.
3. Measurement accuracy is dependent on the stability of the input signal.
4. Operation from 3 GHz to 6 GHz requires option 006.

Table 1. HP 8753B Instrument Specifications (6 of 10)

RECEIVER (Cont'd)

MAGNITUDE CHARACTERISTICS

Absolute Amplitude Accuracy (A, B, R) (see graph)
 (with -10 dBm into input, $25^{\circ}\text{C} \pm 5^{\circ}\text{C}$)

		Code
300 kHz to 3 GHz	± 1.0 dB	S-1
3 GHz to 6 GHz ¹	± 3.0 dB	S-1

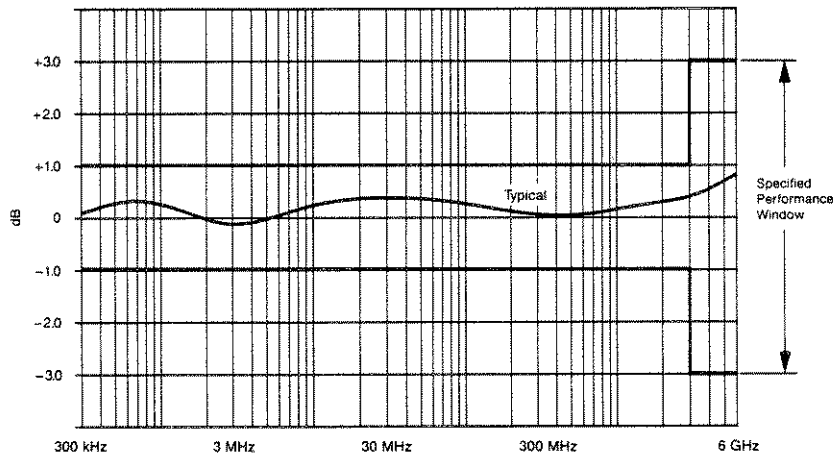

Absolute Amplitude Accuracy

Ratio Accuracy (A/R, B/R, A/B)²
 ($25^{\circ}\text{C} \pm 5^{\circ}\text{C}$, with -10 dBm on all inputs)

300 kHz to 3 GHz	± 0.5 dB	S-1
3 GHz to 6 GHz ¹	± 2.0 dB	S-1

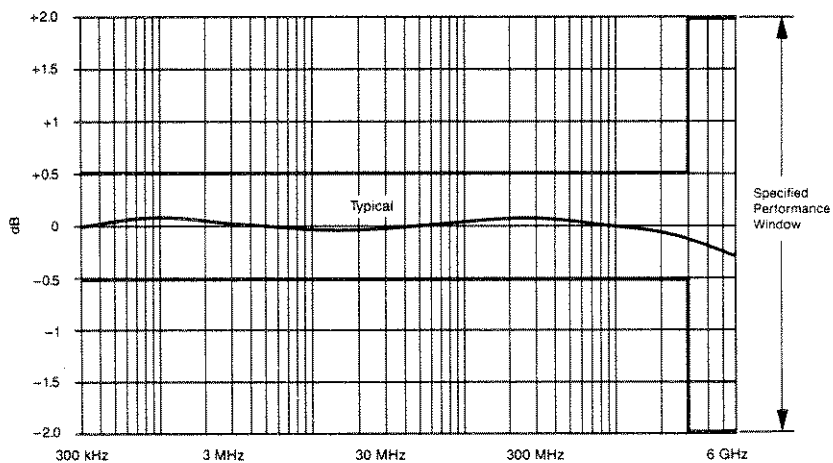

Ratio Accuracy

1. Operation from 3 GHz to 6 GHz requires option 006. Operation from 3 GHz to 6 GHz in the normal network analyzer mode requires option 006 and an HP 85047A S-parameter test set.
2. Unnormalized

Table 1. HP 8753B Instrument Specifications (7 of 10)

RECEIVER (Cont'd)

MAGNITUDE CHARACTERISTICS (Cont'd)

		Code
Display Resolution	0.01 dB/division	S-3
Marker Resolution ¹	0.001 dB	S-3
Dynamic Accuracy (see graph)		S-1
<i>(10 Hz bandwidth, inputs A and B; R to -35 dBm)</i>		

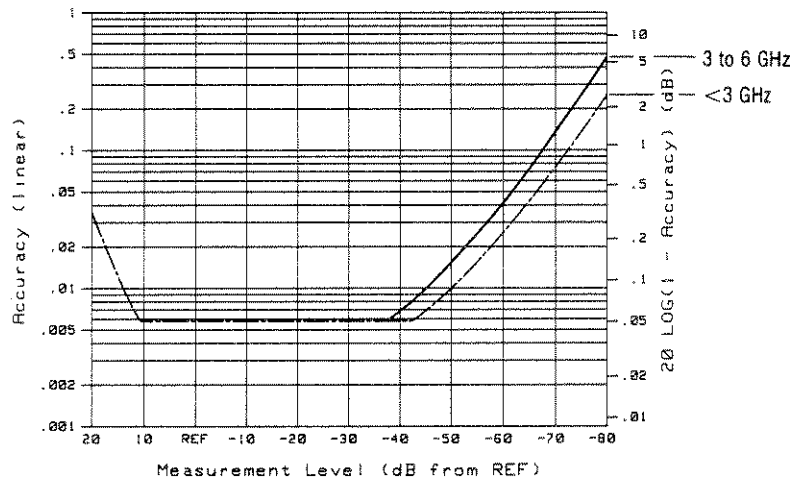

Assumption: Reference Power Level = -20 dBm

Dynamic Accuracy (Magnitude)

Trace Noise (CW sweep)	<0.006 dB rms	S-1
<i>(A/R, B/R, A/B, at -10 dBm, 3 kHz bandwidth)</i>		
Reference Level		
Range	±500 dB	S-3
Resolution	0.001 dB	S-3
Stability (300 kHz to 3 GHz)	0.01 dB/degree C	T
(3 to 6 GHz)	0.02 dB/degree C	T

PHASE CHARACTERISTICS

(A/R, B/R, A/B)

Range	±180°	S-3
Display Resolution	0.01°/division	S-3
Marker Resolution	0.01°	S-3

1. Marker resolution for magnitude, phase, and delay is dependent upon the value measured; resolution is limited to 5 digits.

Table 1. HP 8753B Instrument Specifications (8 of 10)

RECEIVER (Cont'd)

PHASE CHARACTERISTICS (Cont'd)

Frequency Response (deviation from linear) (see graph)
 (with -10 dBm into inputs, $25^{\circ}\text{C} \pm 5^{\circ}\text{C}$)

		Code
300 kHz to 3 GHz	$\pm 3^{\circ}$	S-1
3 GHz to 6 GHz ¹	$\pm 10^{\circ}$	S-1

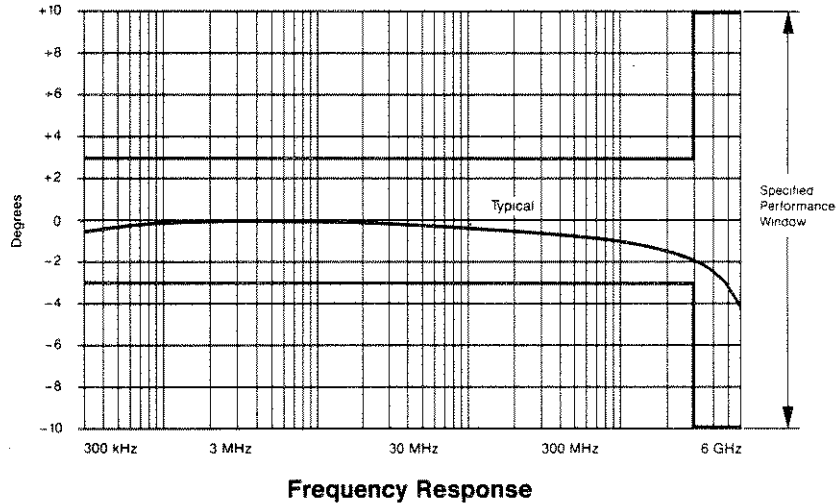

Dynamic Accuracy (see graph) S-1
 (10 Hz bandwidth A/R, B/R, and A/B; R to -35 dBm)

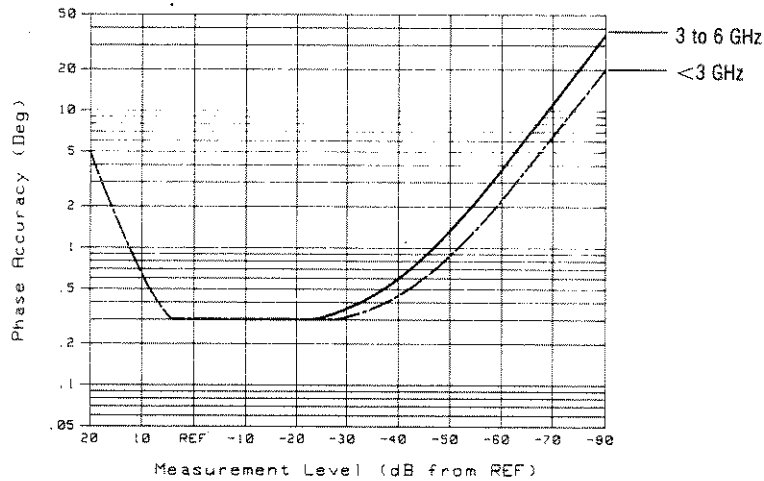

Assumption: Reference Power Level = -20 dBm

Dynamic Accuracy (Phase)

Trace Noise (A/R, B/R, A/B)

300 kHz to 3 GHz	$< 0.035^{\circ}$ rms	S-1
3 GHz to 6 GHz ¹	$< 0.06^{\circ}$ rms	S-1

1. Operation from 3 GHz to 6 GHz requires option 006. Operation from 3 GHz to 6 GHz in the normal network analyzer mode requires option 006 and an HP 85047A S-parameter test set.

Table 1. HP 8753B Instrument Specifications (9 of 10)

RECEIVER (Cont'd)

PHASE CHARACTERISTICS (Cont'd)

		Code
Reference Level		
Range	$\pm 500^\circ$	S-3
Resolution	0.01°	S-3
Stability		
300 kHz to 3 GHz	$0.05^\circ/\text{degree C}$	T
3 GHz to 6 GHz ¹	$0.10^\circ/\text{degree C}$	T

POLAR CHARACTERISTICS

(A/R, B/R, A/B)

Range	10×10^{-12} up to 1000 units full scale	S-3
Reference	range of ± 500 units	S-3

GROUP DELAY CHARACTERISTICS

Group delay is computed by measuring the phase change within a specified frequency step (determined by the frequency span and the number of points per sweep).

Aperture (selectable)	(frequency span)(number of points - 1)	S-3
Maximum aperture	20% of frequency span	S-3
Range	$1/2 \times (1/\text{minimum aperture})$	S-3

(The maximum delay is limited to measuring no more than 180° of phase change within the minimum aperture.)

Accuracy

The following graph shows group delay accuracy at 3 GHz with an HP 85046A S-parameter test set with 7 mm full 2-port calibration and a 10 Hz IF bandwidth. Insertion loss is assumed to be <1 dB and electrical length to be 1 metre.

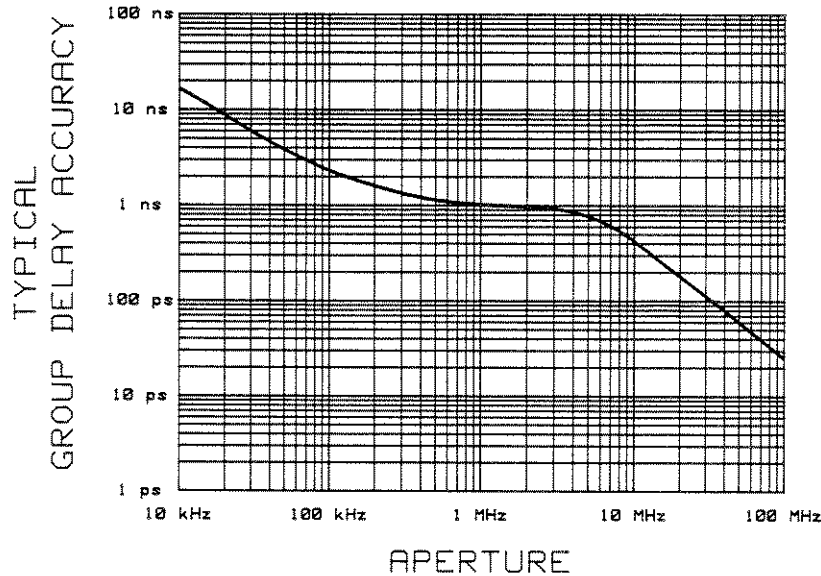

1. Operation from 3 GHz to 6 GHz requires option 006. Operation from 3 GHz to 6 GHz in the normal network analyzer mode requires option 006 and an HP 85047A S-parameter test set.

RECEIVER (Cont'd)

GROUP DELAY CHARACTERISTICS (Cont'd)

In general, the following formula can be used to determine the accuracy, in seconds, of a specific group delay measurement:

$$\pm (0.003 \times \text{Phase Accuracy (deg)}) / \text{Aperture (Hz)}$$

Depending on the aperture and device length, the phase accuracy used is either incremental phase accuracy or worst case phase accuracy. The graph on the previous page shows this transition.

Table 2. HP 8753B General Characteristics (1 of 3)

MEASUREMENT THROUGHPUT SUMMARY

The following table shows typical measurement times for the HP 8753B in milliseconds.

Typical Time for Completion (ms)

	Number of Points			
	51	201	401	1601
Measurement				
Uncorrected	75	150	255	900
1-port cal ¹	75	150	255	900
2-port cal ²	350	980	1640	5500
Time Domain Conversion ³	110	500	1000	2500
HP-IB Data Transfer ⁴				
Internal	20	20	20	20
ASCII	360	1350	2700	10,800
IEEE 754 floating point format				
32 bit	40	100	190	700
64 bit	80	290	560	2200

REMOTE PROGRAMMING

Interface

HP-IB interface operates according to IEEE 488-1978 and IEC 625 standards and IEEE 728-1982 recommended practices.

Transfer Formats

Binary (internal 48-bit floating point complex format)

ASCII

32/64 bit IEEE 754 Floating Point Format

Interface Function Codes

SH1, AH1, T6, TE0, L4, LE0, SR1, RL1, PP0, DC1, DT1, C1, C2, C3, C10, E2

1. S11 1-port calibration, with a 3 kHz IF bandwidth. Includes system retrace time, but does not include bandswitch time. Time domain gating is assumed off.
2. S21 measurement with full 2-port calibration, using a 3 kHz IF bandwidth. Includes system retrace time and RF switching time, but does not include bandswitch time. Time domain gating is assumed off.
3. Option 010 only, gating off.
4. Measured with an HP 9000 series 300 computer.

Table 2. HP 8753B General Characteristics (2 of 3)

FRONT PANEL CONNECTORS

Connector Type type-N (female)
 Impedance 50 ohms (nominal)
 Connector Pin Recession 0.201 to 0.207 in

REAR PANEL CONNECTORS

External Reference Frequency Input (EXT REF INPUT)

Frequency 1, 2, 5, and 10 MHz (± 200 Hz @ 10 MHz)
 Level -10 dBm to +20 dBm, typical
 Impedance 50 ohms

External Auxiliary Input (AUX INPUT)

Input Voltage Limits -10V to +10V

External AM Input (EXT AM)

± 1 volt into a 5k ohm resistor, 1 kHz maximum, resulting in 8 dB/volt amplitude modulation.

External Trigger (EXT TRIGGER)

Triggers on a negative TTL transition or contact closure to ground.

External Trigger Circuit

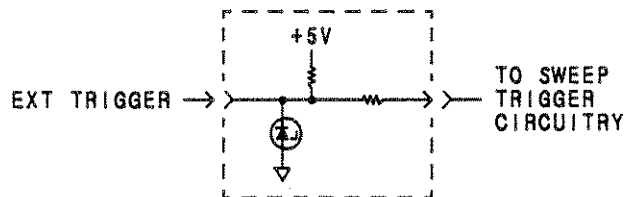

LINE POWER

47 to 63 Hz
 115V nominal (90V to 132V) or 230V nominal (198 to 264V). 280 VA max.

PROBE POWER

+15V $\pm 2\%$ 400 mA (combined load for both probe connections)
 -12.6V $\pm 5.5\%$ 300 mA (combined load for both probe connections)

Table 2. HP 8753B General Characteristics (3 of 3)

ENVIRONMENTAL CHARACTERISTICS

Operating Conditions

Temperature (*unless otherwise noted*) 0° to 55°C
 Humidity 5% to 95% at 40°C (non-condensing)
 Altitude 0 to 4500 meters (15,000 feet)

Non-Operating Storage Conditions

Temperature -40°C to +70°C
 Humidity 0 to 90% relative at +65°C (non-condensing)
 Altitude 0 to 15,240 metres (50,000 feet)

WEIGHT

Net 22 kg (48 lb)
 Shipping 25 kg (55 lb)

CABINET DIMENSIONS

177 mm H x 425 mm W x 497.8 mm D
 (7.0 x 16.75 x 20.0 in)
 (These dimensions exclude front and rear panel protrusions.)

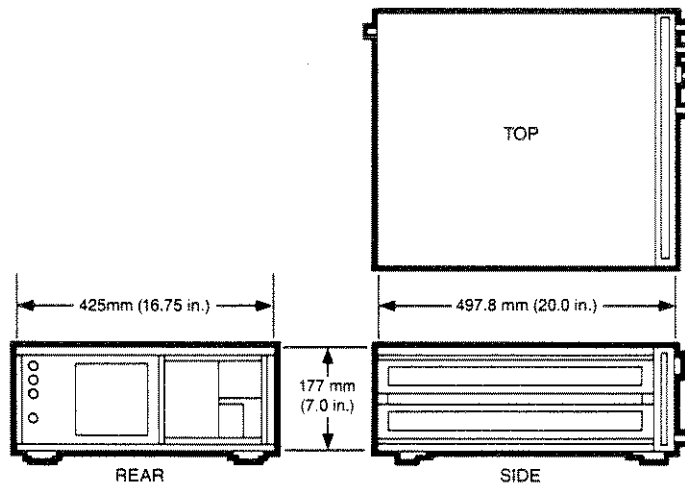

System Performance

INTRODUCTION

The HP 8753B system performance depends not only on the performance of the individual instruments, but also on the system configuration, the user-selected operating conditions, and the measurement calibration.

This section explains the residual errors remaining in a measurement system after accuracy enhancement. It provides information to calculate the total measurement uncertainty of different HP 8753B systems. Graphs at the beginning of the section show examples of the performance that can be calculated using the methods explained in this section.

The sources of measurement errors are explained, with an error model flowgraph and uncertainty equations. Information is provided for conversion of the dynamic accuracy error (in dB) to a linear value for use in the uncertainty equations. The effects of temperature drift on measurement uncertainty are illustrated with graphs.

System specification tables are provided for an HP 8753B 7 mm system using an HP 85046A, 85044A, or 85047A test set. Typical system performance tables are given for 50 ohm type-N and 3.5 mm systems, and for 75 ohm type-N systems using the HP 85046B and 85044B test sets.

Procedures and blank worksheets are supplied to compute the total error-corrected measurement uncertainty of a system. These procedures combine the terms in the tables, the uncertainty equations, and the nominal S-parameter data of the device under test.

COMPARISON OF TYPICAL ERROR-CORRECTED MEASUREMENT UNCERTAINTY

Figures 3 through 10 are examples of the measurement uncertainty data that can be calculated using the information provided in this section. These figures compare the reflection and transmission measurement uncertainty of a 7 mm system using different levels of error correction. Each figure shows uncorrected values and residual uncertainty values after response calibration, response and isolation calibration, and full one or two port calibration. The data applies to a frequency range of 300 kHz to 3 GHz with a stable temperature (no temperature drift), and using compatible 7 mm calibration devices from the HP 85031B calibration kit.

The results graphed in Figures 3 through 10 can be obtained using the HP 85046A, 85044A, or 85047A test sets up to 3 GHz. Different measurement calibration procedures provide comparable measurement improvement for the following compatible connector types and test sets (using the compatible calibration kits):

- 50 ohm type-N connectors
- 3.5 mm connectors
- HP 85047A test set from 3 GHz to 6 GHz (with HP 8753B option 006)
- HP 85046B and 85044B with 75 ohm type-N connectors

Reflection Uncertainty of a One-Port Device

Assumptions: Reference Power Level = -20 dBm
 $S_{21} = S_{12} = 0$ (one-port device only)

Uncorrected - - - - -
 Response
 Response and Isolation - - - - -
 Full one or two port - - - - -

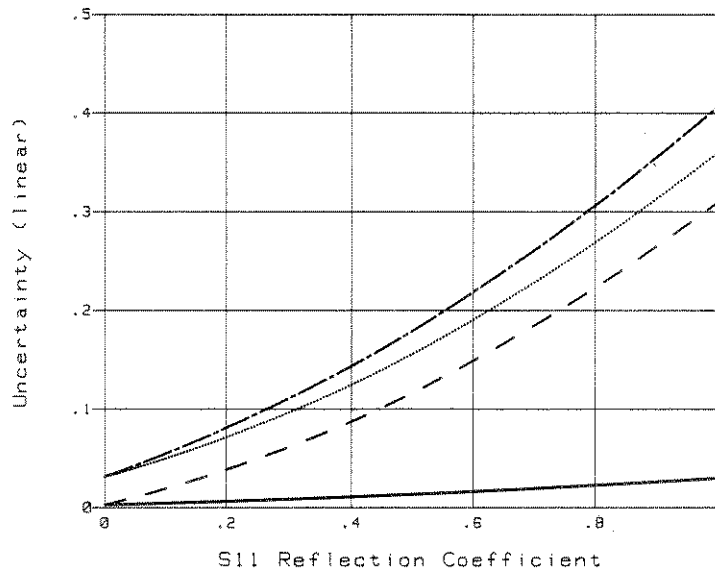

Figure 3. Total Reflection Magnitude Uncertainty

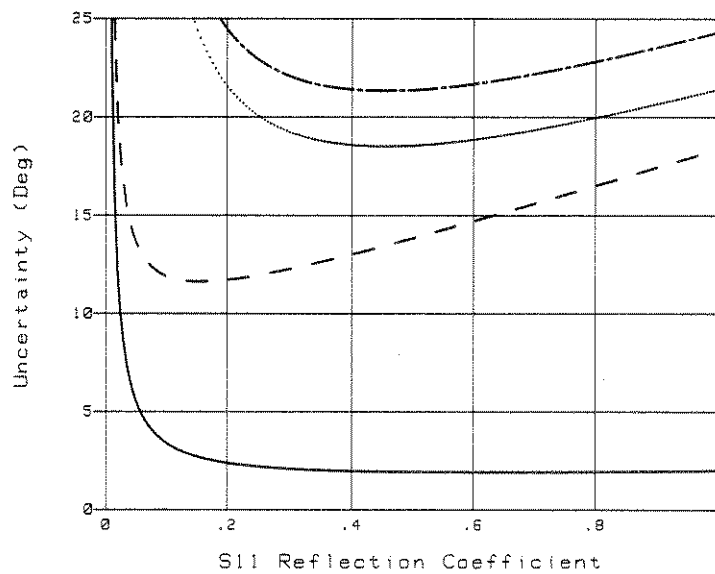

Figure 4. Total Reflection Phase Uncertainty

Reflection Uncertainty of a Two-Port Device

Assumptions: Reference Power Level = -20 dBm
 $S_{21} = S_{12} = 0.5$ (6 dB insertion loss device)

Uncorrected ———
 Response
 Response and Isolation - - - -
 Full one or two port —————

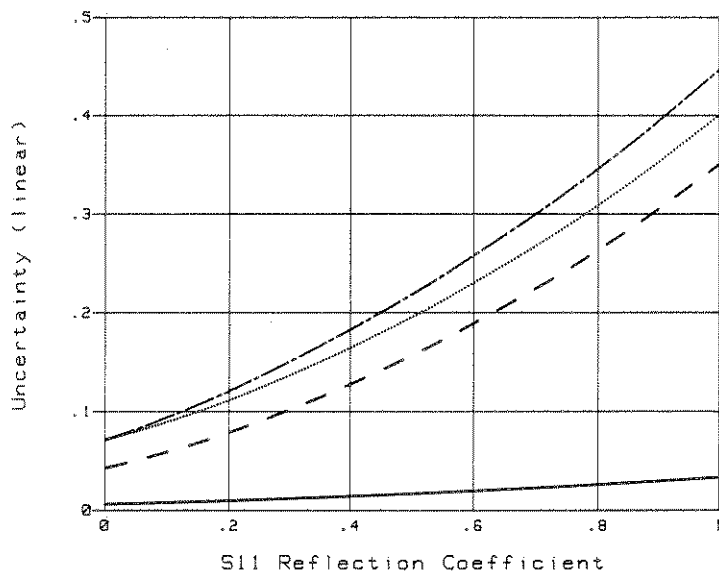

Figure 5. Total Reflection Magnitude Uncertainty

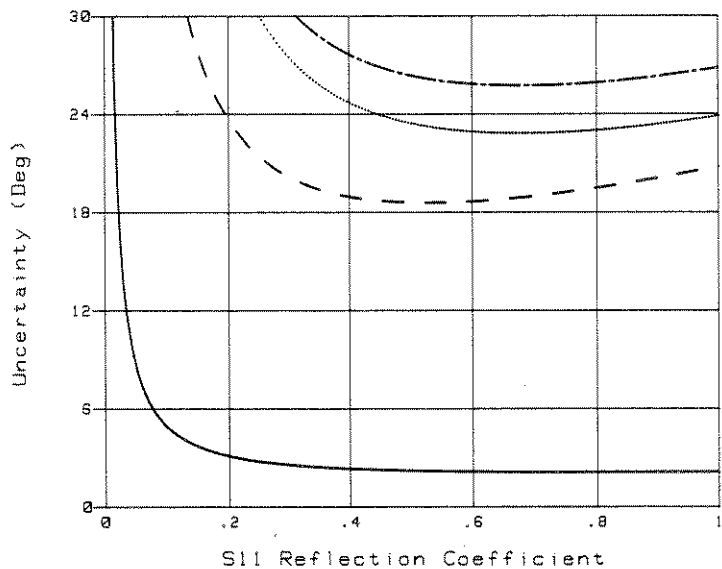

Figure 6. Total Reflection Phase Uncertainty

Transmission Uncertainty of a Low-Loss Device

Assumptions: Reference Power Level = -10 dBm
 $S_{11} = S_{22} = 0.1$

Uncorrected - - - - -
 Response
 Response and Isolation - - - - -
 Full one or two port - - - - -

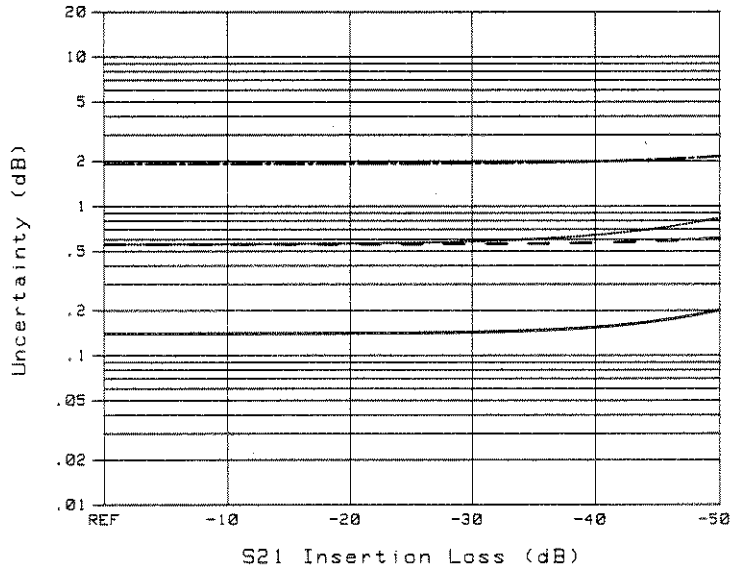

Figure 7. Total Transmission Magnitude Uncertainty

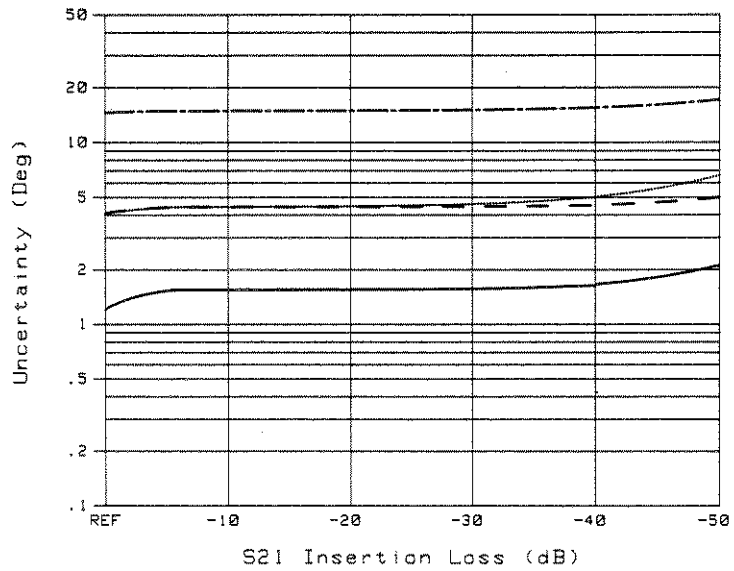

Figure 8. Total Transmission Phase Uncertainty

Transmission Uncertainty of a Wide Dynamic Range Device

Assumptions: Reference Power Level = 0 dBm
 $S_{11} = S_{22} = 0.1$

Uncorrected - - - - -
 Response
 Response and Isolation - - - - -
 Full one or two port - - - - -

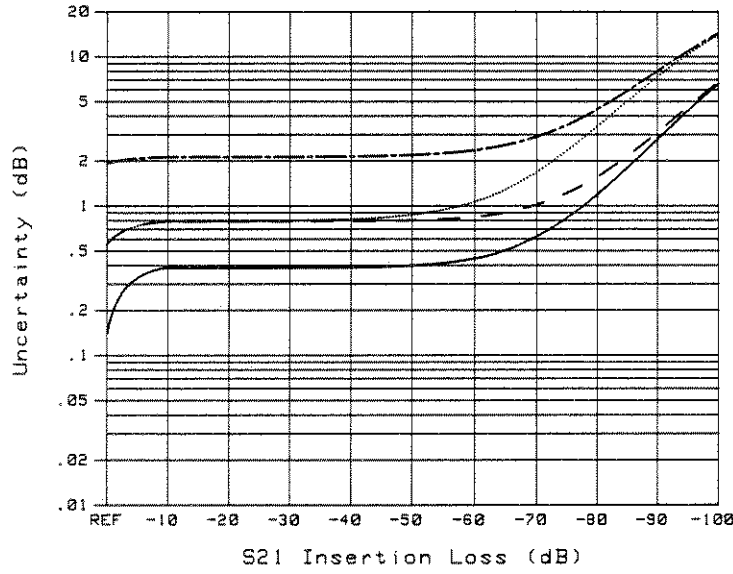

Figure 9. Total Transmission Magnitude Uncertainty

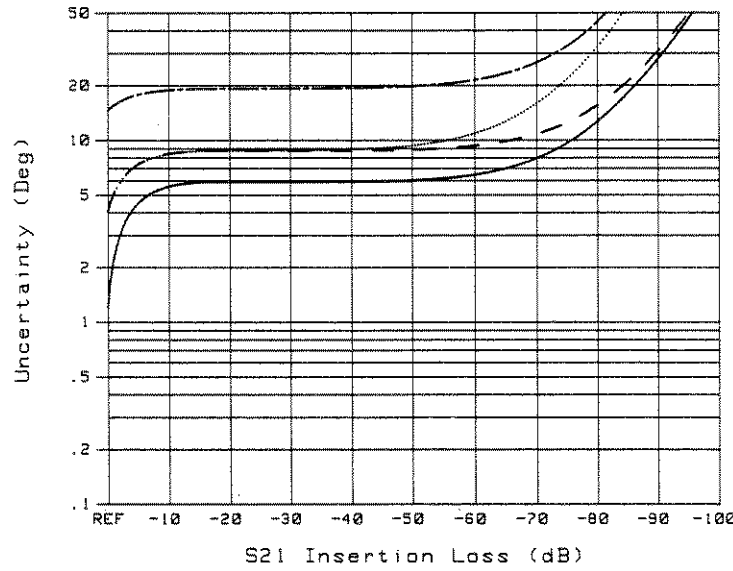

Figure 10. Total Transmission Phase Uncertainty

SOURCES OF MEASUREMENT ERRORS

Network analysis measurement errors can be separated into systematic, random, and drift errors. Refer to chapter 5, *Measurement Calibration*, for a detailed description of the systematic errors corrected by the HP 8753B accuracy enhancement calibration procedures. In addition to the errors removed by accuracy enhancement, other systematic errors exist that, combined with random and drift errors, also contribute to total system measurement uncertainty. Therefore, after accuracy enhancement procedures are performed, residual measurement uncertainties remain.

Systematic Error Sources

Residual (post-calibration) systematic errors result from imperfections in the calibration standards, the connector standards, the connector interface, the interconnecting cables, and the instrumentation. All measurements are affected by dynamic accuracy, effective switch port match, switch tracking, and frequency error effects. For reflection measurements, the associated residual errors are effective directivity, effective source match, and effective reflection tracking. For transmission measurements, the additional residual errors are effective crosstalk, effective load match, effective transmission tracking, and cable stability.

Random Error Sources

Non-repeatable measurement variations occur due to trace noise, noise floor, and connector repeatability. These errors affect both reflection and transmission measurements.

Drift Error Sources

Drift error sources fall into two basic categories: frequency drift and instrumentation drift. Primary causes for instrumentation drift are the thermal expansion characteristics of the interconnecting cables within the test set, and the conversion stability of the frequency converter within the receiver. These errors affect both reflection and transmission measurements.

SYSTEM ERROR MODEL

Any measurement result is the vector sum of the actual test device response plus all error terms. The precise effect of each error term depends upon its magnitude and phase relationship to the actual test device response. When the phase of an error response is not known, phase is assumed to be worst case (0 or 180 degrees). Random errors such as noise and connector repeatability are generally combined in a root-sum-of-the-squares (RSS) manner. The error term related to thermal drift is combined on a worst-case basis as shown in each uncertainty equation given in the following paragraphs.

Figure 11 illustrates the error model for the HP 8753B with the HP 85046A or 85047A S-parameter test set. This error model shows the relationship of the various error sources in the forward direction, and may be used to analyze overall measurement performance. The model for signal flow in the reverse direction is similar. Note the appearance of the dynamic accuracy, noise errors, switch errors, and connector repeatability terms in both the reflection and transmission portions of the model.

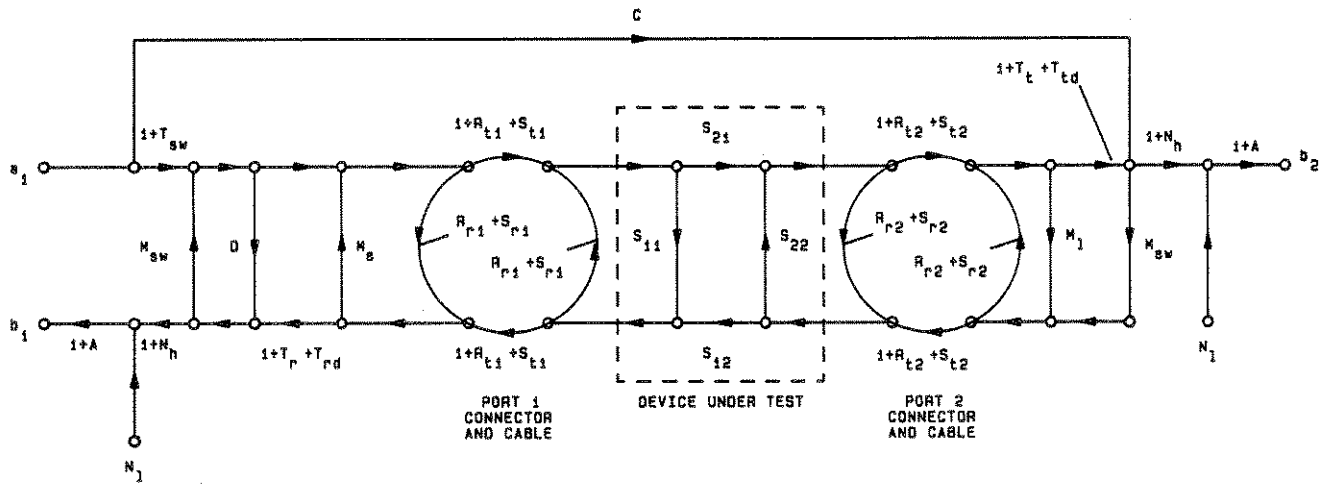

- | | | | |
|------------|--|-------|----------------------------------|
| A | = Dynamic Accuracy
(A_m = Magnitude Dynamic Accuracy)
(A_p = Phase Dynamic Accuracy) | D | = Residual Directivity |
| N_1 | = Noise Floor | M_s | = Residual Source Match |
| N_h | = High Level Noise | M_l | = Residual Load Match |
| T_{sw}^* | = Switch Repeatability (Transmission) | C | = Residual Crosstalk |
| M_{sw}^* | = Switch Repeatability (Reflection) | T_r | = Residual Reflection Tracking |
| R_r | = Reflection Repeatability | T_t | = Residual Transmission Tracking |
| R_t | = Transmission Repeatability | S_r | = Cable Reflection Stability |
| T_{rd} | = Reflection Tracking Drift | S_t | = Cable Transmission Stability |
| T_{td} | = Transmission Tracking Drift | | |

Figure 11. HP 8753B/85046A/85047A System Error Model

For measurement of one-port devices, set the crosstalk (C), load match (M_l), transmission tracking (T_t), port 2 connector repeatability (R_{r2} , R_{t2}), and port 2 cable stability (S_{r2} , S_{t2}) error terms to zero.

* In the tables of specifications and typical system performance, the effects of switch repeatability are included in the terms for source match, load match, reflection tracking, and transmission tracking.

REFLECTION UNCERTAINTY EQUATIONS

Total Reflection Magnitude Uncertainty (E_{rm})

An analysis of the error model yields an equation for the reflection magnitude uncertainty. The equation contains all of the first order terms and the significant second order terms. The error term related to thermal drift is combined on a worst case basis with the total of systematic and random errors. The four terms under the radical are random in character and are combined on an RSS basis. The terms in the systematic error group are combined on a worst case basis. In all cases, the error terms and the S-parameters are treated as linear absolute magnitudes.

$$E_{rm} \text{ (linear)} = V_r + S_{11} \times T_{rd} \text{ (magnitude); and}$$

$$E_{rm} \text{ (log)} = 20 \log (1 \pm E_{rm}/S_{11})$$

where

$$V_r = S_r + \sqrt{W_r^2 + X_r^2 + Y_r^2 + Z_r^2}$$

$$S_r = \text{systematic error} = D + S_{r1} + T_r \times S_{11} + (M_s + S_{r1}) \times S_{11}^2 + M_l \times S_{21} \times S_{12} + A_m \times S_{11}$$

$$W_r = \text{random low-level noise} = 3 \times N_l$$

$$X_r = \text{random high-level noise} = 3 \times N_h \times S_{11}$$

$$Y_r = \text{random port 1 repeatability} = R_{r1} + 2 \times R_{t1} \times S_{11} + R_{r1} \times S_{11}^2$$

$$Z_r = \text{random port 2 repeatability} = R_{r2} \times S_{21} \times S_{12}$$

Total Reflection Phase Uncertainty (E_{rp})

Reflection phase uncertainty is determined from a comparison of the magnitude uncertainty with the test signal magnitude. The worst case phase angle is computed. This result is combined with the error terms related to thermal drift of the total system, port 1 cable stability, and phase dynamic accuracy.

$$E_{rp} = \arcsin ((V_r - A_m \times S_{11}) / S_{11}) + T_{rd} \text{ (phase)} + 2S_{t1} + A_p$$

TRANSMISSION UNCERTAINTY EQUATIONS

Total Transmission Magnitude Uncertainty (E_{tm})

An analysis of the error model in Figure 11 yields an equation for the transmission magnitude uncertainty. The equation contains all of the first order terms and some of the significant second order terms. The error term related to thermal drift is combined on a worst case basis with the total of systematic and random errors. The four terms under the radical are random in character and are combined on an RSS basis. The terms in the systematic error group are combined on a worst case basis. In all cases, the error terms are treated as linear absolute magnitudes.

$$E_{tm} \text{ (linear)} = V_t + S21 \times T_{td} \text{ (magnitude); and}$$

$$E_{tm} \text{ (log)} = 20 \log (1 \pm E_{tm} / S21)$$

where

$$V_t = S_t + \sqrt{W_t^2 + X_t^2 + Y_t^2 + Z_t^2}$$

$$S_t = \text{systematic error} = C + T_t \times S21 + (M_s + S_{r1}) \times S11 \times S21 + (M_l + S_{r2}) \times S21 \times S22 + A_m \times S21$$

$$W_t = \text{random low-level noise} = 3 \times N_l$$

$$X_t = \text{random high-level noise} = 3 \times N_h \times S21$$

$$Y_t = \text{random port 1 repeatability} = R_{t1} \times S21 + R_{r1} \times S11 \times S21$$

$$Z_t = \text{random port 2 repeatability} = R_{t2} \times S21 + R_{r2} \times S22 \times S21$$

Total Transmission Phase Uncertainty (E_{tp})

Transmission phase uncertainty is calculated from a comparison of the magnitude uncertainty with the test signal magnitude. The worst case phase angle is computed. This result is combined with the error terms related to phase dynamic accuracy, cable phase stability, and thermal drift of the total system.

$$E_{tp} = \arcsin ((V_t - A_m \times S21) / S21) + T_{td} \text{ (phase)} + S_{t1} + S_{t2} + A_p$$

DYNAMIC ACCURACY

The dynamic accuracy value used in the system uncertainty equations is obtained from the HP 8753B's dynamic accuracy specifications. The specification for magnitude dynamic accuracy is in dB, and it must be converted to a linear value to be used in the uncertainty equations. In addition, the HP 8753B's dynamic accuracy specifications are given for an absolute input signal in dBm, and must be converted to a relative error (relative to the power at which the accuracy enhancement calibration occurs) to be used in the system uncertainty equations.

$$\text{Dynamic Accuracy (linear)} = \frac{10^{(+\text{DynAcc(dB)}/20)} - 1}{10^{(-\text{DynAcc(dB)}/20)} + 1}$$

$$\text{Dynamic Accuracy (dB)} = 20 \cdot \log(1 \pm \text{Dynamic Accuracy (linear)})$$

Definitions

P_{cal} = the calibration (thus the reference) power level at the instrument input port (A or B) (i.e. when the short is measured in a reflection calibration OR when the thru is measured in a transmission calibration)

P_{meas} = the measured input signal (dBm) when the DUT is measured

Residual dynamic accuracy = the residual error remaining when $P_{meas} = P_{cal}$

Lin_{acc} = relative dynamic accuracy (linear magnitude or phase) for the ratioed measurement used in the linear system performance calculation

Lin_{cal} = dynamic accuracy (linear magnitude or phase) term for single input at P_{cal}

Lin_{meas} = dynamic accuracy (linear magnitude or phase) term for single input at P_{meas}

Determining Relative Dynamic Accuracy Error Contribution

The example given here shows how to determine the relative dynamic accuracy error contribution to a measurement in a ratio mode. Six example graphs are provided: Figures 12 and 13 show the worst-case magnitude and phase dynamic accuracy error with a reference power level of 0 dBm, Figures 14 and 15 with a reference power level of -20 dBm, and Figures 16 and 17 with a reference power level of -60 dBm.

Assume R channel power level to be constant ($P_{cal} = P_{meas}$)

Example: $0 \text{ dBm} \geq P_{cal} \geq -60 \text{ dBm}$ (magnitude)
 $0 \text{ dBm} \geq P_{cal} \geq -50 \text{ dBm}$ (phase)

$0 \text{ dBm} \geq P_{meas} \geq -60 \text{ dBm}$ (magnitude) $-60 \text{ dBm} \geq P_{meas} \geq -100 \text{ dBm}$ (magnitude)
 $0 \text{ dBm} \geq P_{meas} \geq -50 \text{ dBm}$ (phase) $-50 \text{ dBm} \geq P_{meas} \geq -100 \text{ dBm}$ (phase)

$Lin_{acc} = \text{ABS}(Lin_{cal} - Lin_{meas}) + \text{Residual}$ $Lin_{acc} = Lin_{cal} + Lin_{meas} - \text{Residual}$

Residual Magnitude Dynamic Accuracy (linear) = 0.00577
 Residual Phase Dynamic Accuracy = 0.331 degrees

Dynamic Accuracy Error Contribution

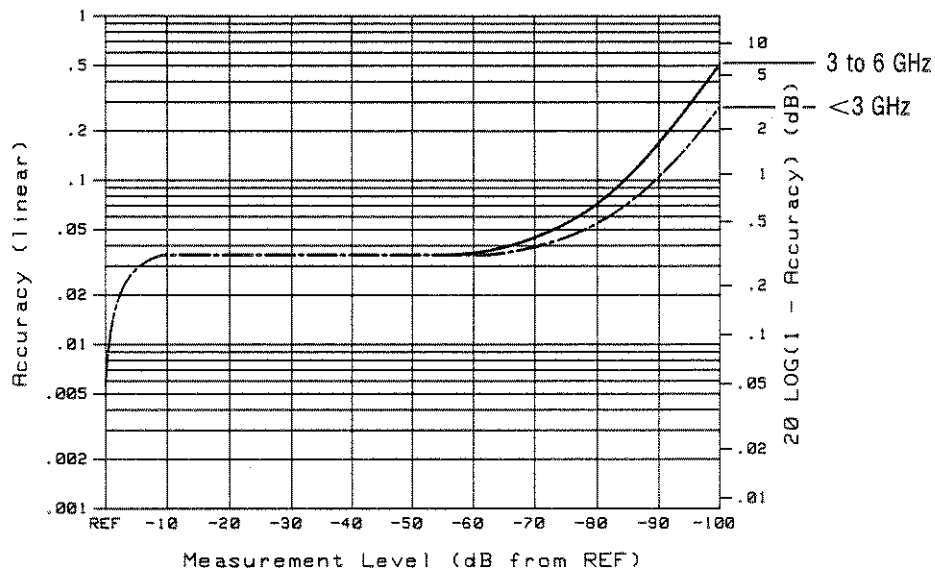

Assumption: Reference Power Level = 0 dBm

Figure 12. Worst-Case Magnitude Dynamic Accuracy Error

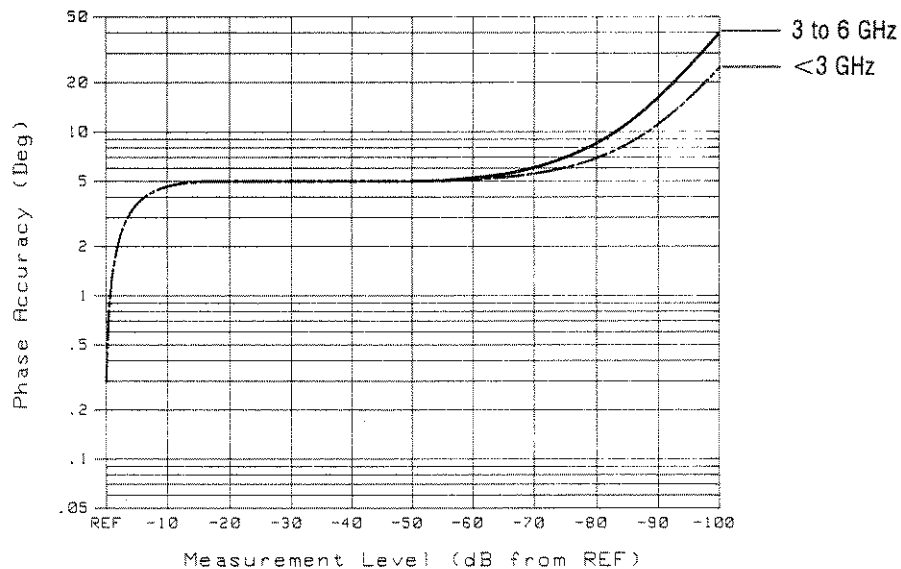

Assumption: Reference Power Level = 0 dBm

Figure 13. Worst-Case Phase Dynamic Accuracy Error

Dynamic Accuracy Error Contribution

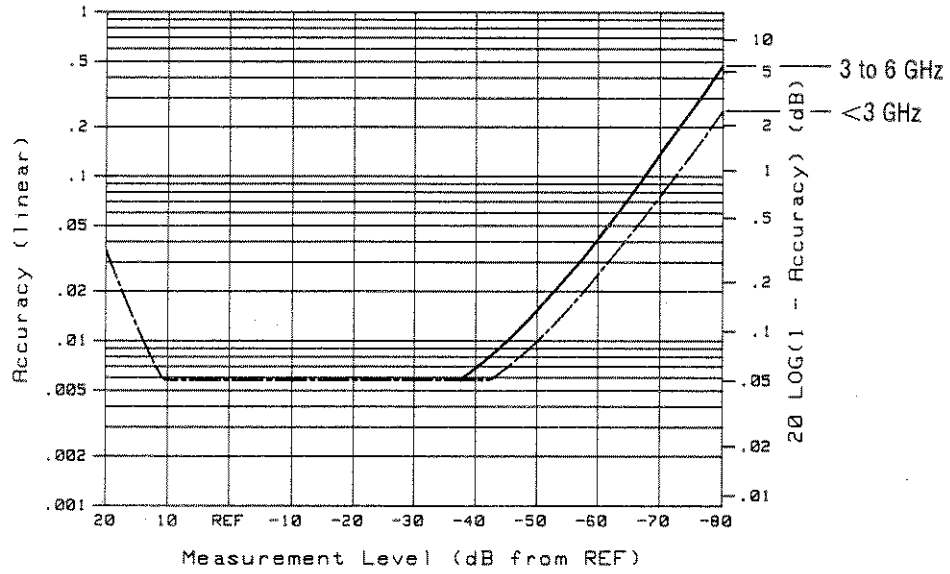

Assumption: Reference Power Level = -20 dBm

Figure 14. Worst-Case Magnitude Dynamic Accuracy Error

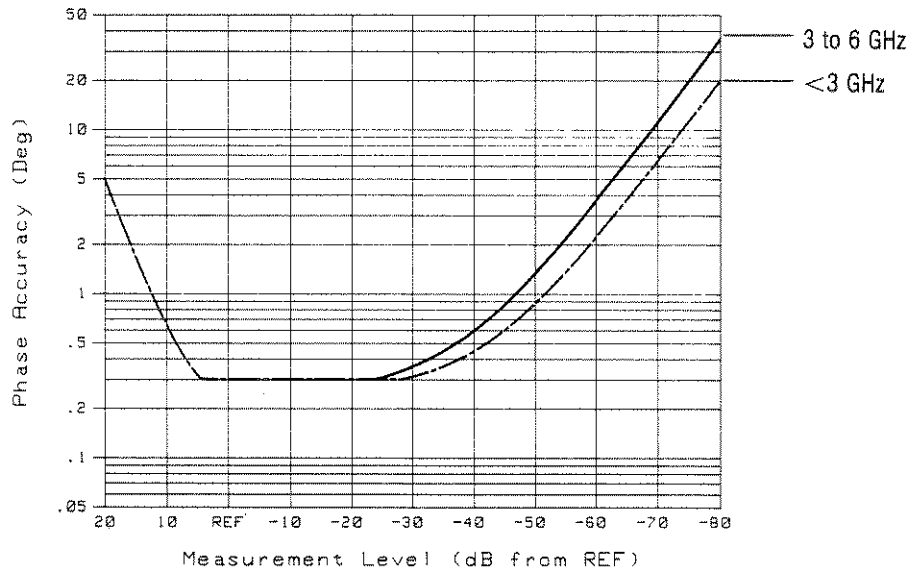

Assumption: Reference Power Level = -20 dBm

Figure 15. Worst-Case Phase Dynamic Accuracy Error

Dynamic Accuracy Error Contribution

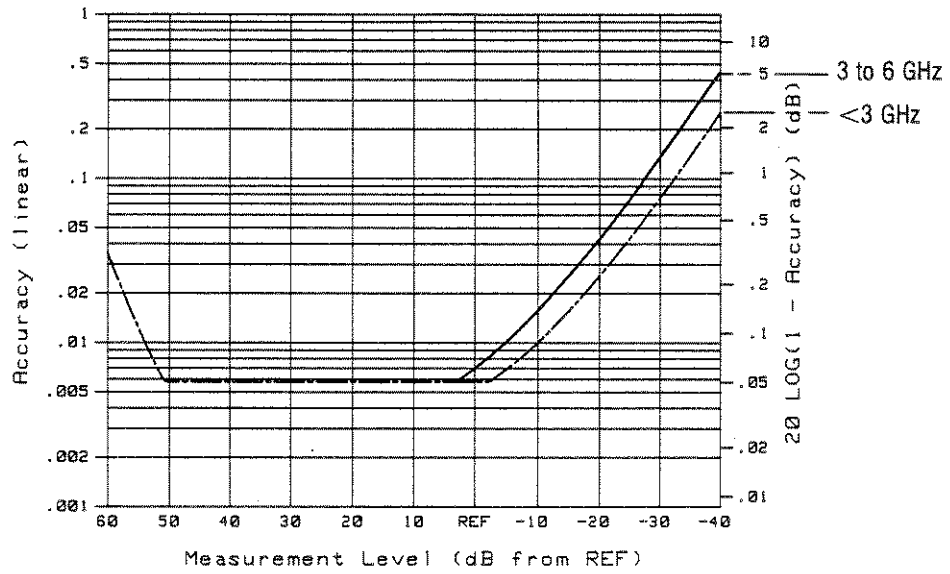

Assumption: Reference Power Level = -60 dBm

Figure 16. Worst-Case Magnitude Dynamic Accuracy Error

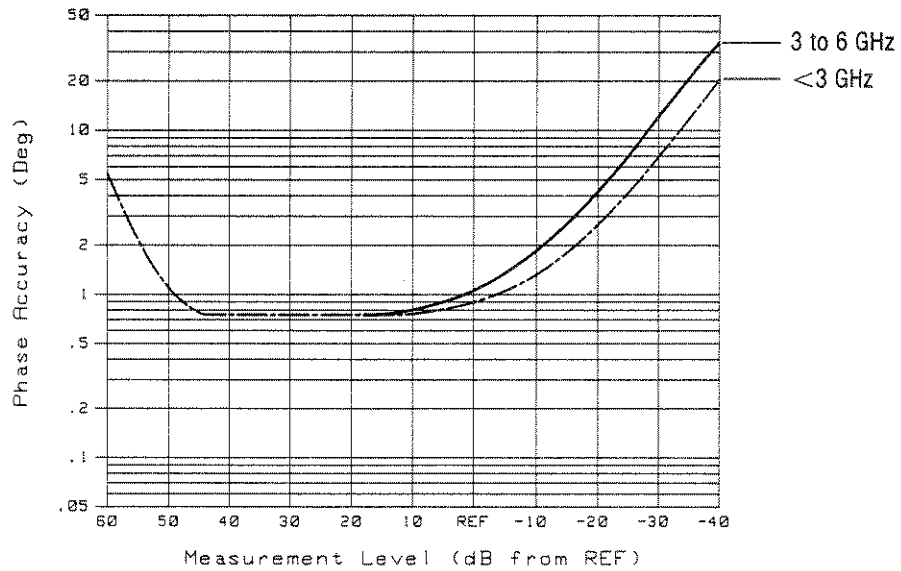

Assumption: Reference Power Level = -60 dBm

Figure 17. Worst-Case Phase Dynamic Accuracy Error

EFFECTS OF TEMPERATURE DRIFT

Figures 18 to 21 are graphs showing the effects of temperature drift on error-corrected measurement uncertainty values. Values are shown for changes of $\pm 3^{\circ}\text{C}$ and $\pm 5^{\circ}\text{C}$ from the ambient temperature. Figures 18 and 19 show total reflection magnitude and phase uncertainty with temperature drift following an S11 one-port calibration. Figures 20 and 21 show total transmission magnitude and phase uncertainty with temperature drift following a full two-port error correction. The graphs apply to measurements up to 3 GHz.

Temperature Drift with S11 One-Port Calibration

Assumptions: Reference Power Level = -20 dBm
 $S_{21} = S_{12} = 0$

$\Delta T = 0^\circ\text{C}$ —————
 $\Delta T = \pm 3^\circ\text{C}$
 $\Delta T = \pm 5^\circ\text{C}$ - - - - -

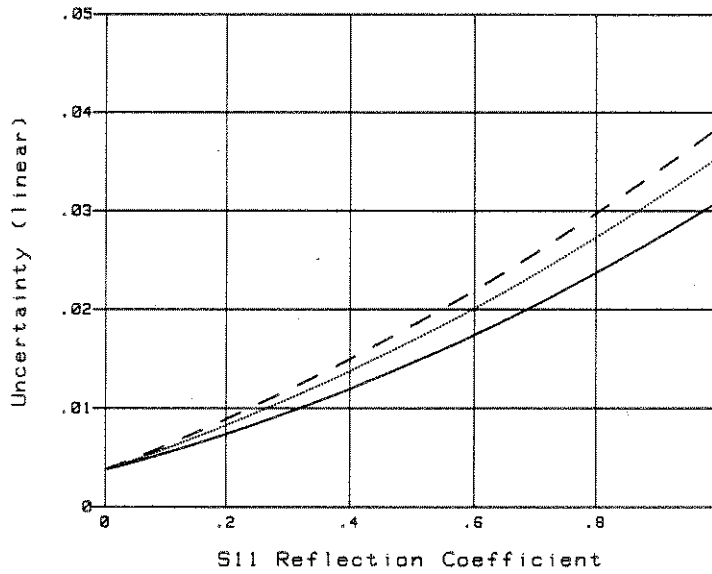

Figure 18. Total Reflection Magnitude Uncertainty

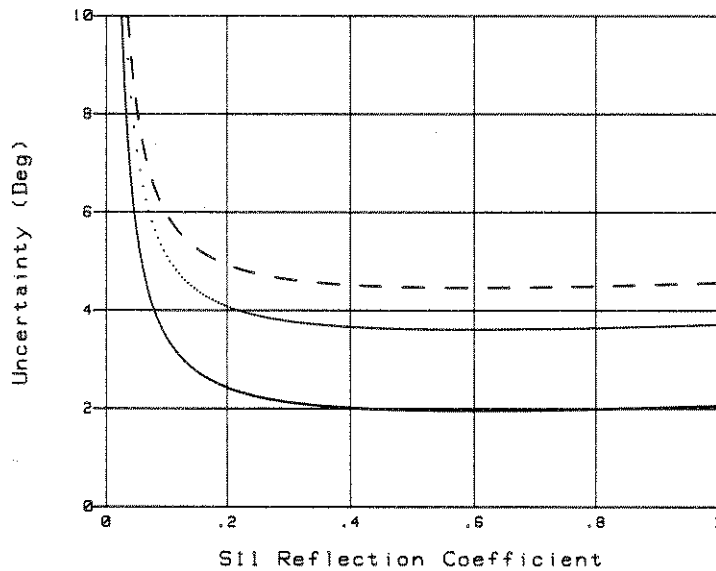

Figure 19. Total Reflection Phase Uncertainty

Temperature Drift with Full Two-Port Calibration

Assumptions: Reference Power Level = -10 dBm
 $S_{11} - S_{22} = 0$

$\Delta T = 0^\circ\text{C}$ —————
 $\Delta T = \pm 3^\circ\text{C}$
 $\Delta T = \pm 5^\circ\text{C}$ - - - - -

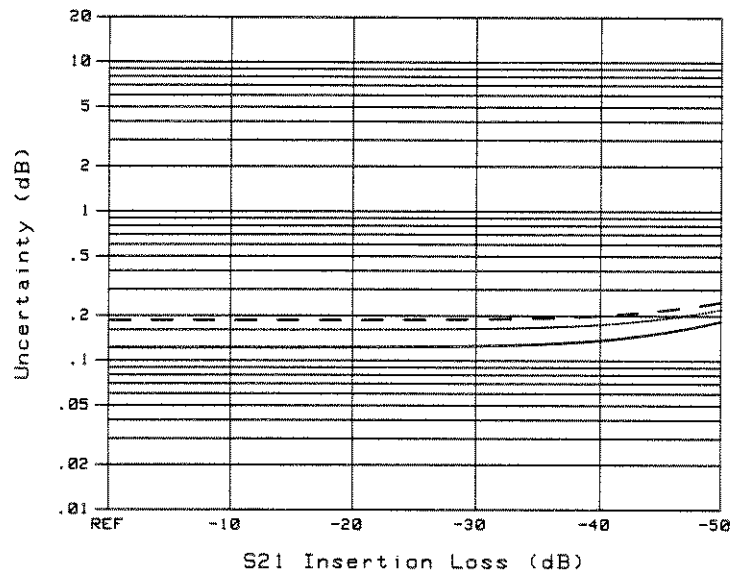

Figure 20. Total Transmission Magnitude Uncertainty

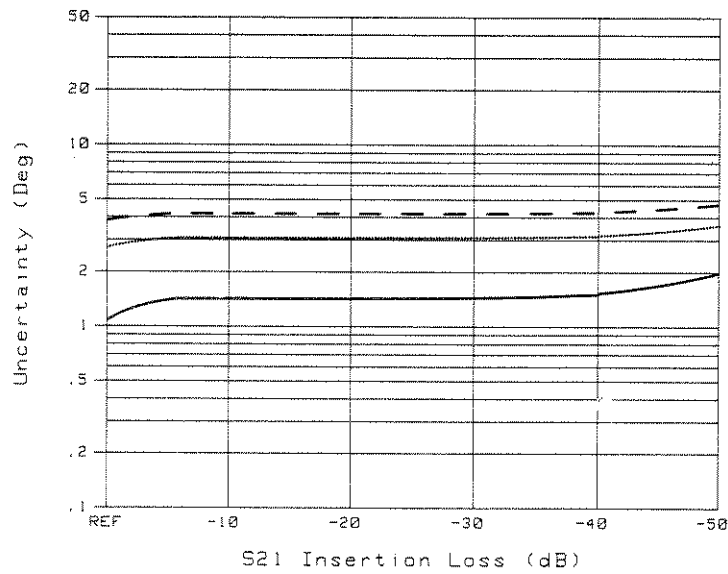

Figure 21. Total Transmission Phase Uncertainty

SYSTEM PERFORMANCE WITH DIFFERENT TEST SETS AND CONNECTOR TYPES

The tables in the following pages provide system specifications or typical system performance for HP 8753B systems using different test sets and different connector types. The values listed are for uncorrected measurements and for corrected measurements after accuracy enhancement.

Table	Connector	Test Set	Frequency Range
3	7 mm	HP 85046A, 85044A, 85047A	300 kHz to 3 GHz
4	7 mm	HP 85047A	3 GHz to 6 GHz
5	50 ohm type-N	HP 85046A, 85044A, 85047A	300 kHz to 3 GHz
6	50 ohm type-N	HP 85047A	3 GHz to 6 GHz
7	3.5 mm	HP 85046A, 85044A, 85047A	300 kHz to 3 GHz
8	3.5 mm	HP 85047A	3 GHz to 6 GHz
9	75 ohm type-N	HP 85046B, 85044B	300 kHz to 2 GHz

Tables 3 and 4 provide specifications for HP 8753B 7 mm systems. Error correction was performed using precision devices from the HP 85031B 7 mm calibration kit. Data listed in the columns headed *Residuals After Accuracy Enhancement* was measured accurately at the factory with standards traceable to the National Bureau of Standards. These residuals can be verified only at the factory (USA). Aggregate system performance after accuracy enhancement can be verified using the HP 85029B 7 mm verification kit and the *System Verification* procedure in the *On-Site System Service Manual*.

Tables 5 through 9 provide typical performance figures for other HP 8753B systems. These are not specifications, but are intended to provide information useful in applying the instrument by giving typical but non-warranted performance parameters. Error correction for these systems is performed using the compatible calibration kits listed in *General Information*.

NOTE: Tables 3 through 9 are generated with the HP 8753B in chop A and B sweep mode. Refer to *Calibrate More Menu* in Chapter 5 for details.

Table 3. System Specifications for Devices with 7mm Connectors
HP 8753B with HP 85046A, 85044A, or 85047A Test Set, up to 3 GHz

Symbol	Error Terms	Uncorrected		Residual after Accuracy Enhancement ^{1, 2}							
				Response Only		Response and Isolation		One-Port		Full Two-Port ³	
		dB	Linear	dB	Linear	dB	Linear	dB	Linear	dB	Linear
D	Directivity	-30	0.032	-30	0.032	-50 ⁴	0.0032	-50	0.0032	-50	0.0032
M _s	Source Match ⁵	-16 ⁶	0.16	-16 ⁶	0.16	-16	0.16	-40	0.01	-40	0.01
M _l	Load Match ⁵	-16 ^{6, 7}	0.16 ⁷	-16 ^{6, 7}	0.16 ⁷	-16 ⁷	0.16 ⁷	—	—	-42	0.005
T _r	Reflection Tracking ⁵	±1.5 ⁷	+0.19 ⁷ -0.16 ⁷	+1.5 ⁷ -1.8 ⁷	0.19 ⁷	+1.3 ⁷ -1.5 ⁷	0.16 ⁷	±0.05	0.006	±0.05	0.006
T _t	Transmission Tracking ⁵	±1.5 ^{7, 8}	+0.19 ⁷ -0.16 ⁷	±0.20 ⁷	0.026 ⁷	±0.20 ⁷	0.026 ⁷	—	—	±0.03	0.0035
C	Crosstalk	-90 ⁷	0.000032 ⁷	-90 ⁷	0.000032	-100 ⁹	0.00001	—	—	-100 ⁹	0.00001
R _{r1}	Port 1 Reflection Connector Repeatability (Typical)	-70 dB or 0.00032 linear									
R _{t1}	Port 1 Transmission Connector Repeatability (Typical)	-70 dB or 0.00032 linear									
R _{r2}	Port 2 Reflection Connector Repeatability (Typical)	-70 dB or 0.00032 linear									
R _{t2}	Port 2 Transmission Connector Repeatability (Typical)	-70 dB or 0.00032 linear									
N _l	Low-Level Noise (Noise Floor)	-100 dBm									
N _h	High-Level Noise ¹⁰	Magnitude: 0.004 dB or 0.00046 linear									
A _m , A _p	HP 8753B Magnitude and Phase Dynamic Accuracy Error	Refer to "Dynamic Accuracy" in this section									
S _{t1}	Port 1 Cable Transmission Phase Stability ¹¹	0.05 x f(GHz), degrees									
S _{r1}	Port 1 Cable Reflection Stability ¹¹	-70 dB or 0.00032 linear									
S _{t2}	Port 2 Cable Transmission Phase Stability ¹¹	0.05 x f(GHz), degrees									
S _{r2}	Port 2 Cable Reflection Stability ¹¹	-70 dB or 0.00032 linear									
T _{td}	Transmission Tracking Drift (Typical)	Magnitude: 0.0015 x Δ°C, linear Phase: [0.1 + 0.15 x f(GHz)] x Δ°C, degrees									
T _{rd}	Reflection Tracking Drift (Typical)	Magnitude: 0.0015 x Δ°C, linear Phase: ¹² [0.1 + 0.15 x f(GHz)] x Δ°C, degrees									

1. Accuracy enhancement procedures are performed using HP 85031B 7 mm calibration kit. Environmental temperature is 25°C ± 5°C at calibration: ± 1°C from calibration temperature must be maintained for valid measurement calibration.

2. With IF bandwidth of 10 Hz.

3. One-path 2-port calibration with HP 85044A.

4. With impedance-matched load.

5. Includes effects of switch repeatability.

6. Applies over most of the frequency range. Refer to test set manual for detailed specifications.

7. Typical.

8. HP 85044A typically has a +6 dB offset.

9. Typically, crosstalk after accuracy enhancement is -110 dB.

10. High-level noise is the RMS of a continuous measurement of a short circuit or thru. Refer to the trace noise performance test.

11. Arrived at by bending HP 11857D cables out perpendicular to front panel and reconnecting. Stability is much better with less flexing.

12. Arrived at using HP 11857D cables and full 2-port calibration. Drift is much better without cables and with 1-port calibration. For this case, drift typically is [0.1 + 0.05 x f(GHz)] x Δ°C, degrees.

Table 4. System Specifications for Devices with 7mm Connectors
HP 8753B with HP 85047A Test Set, 3 GHz to 6 GHz

Symbol	Error Terms	Uncorrected		Residual after Accuracy Enhancement 1, 2							
				Response Only		Response and Isolation		One-Port		Full Two-Port	
		dB	Linear	dB	Linear	dB	Linear	dB	Linear	dB	Linear
D	Directivity	-25	0.06	-25	0.06	-44 ³	0.006	-44	0.0032	-44	0.006
M _s	Source Match ⁴	-14	0.20	-14	0.20	-14	0.20	-36	0.01	-36	0.016
M _l	Load Match ⁴	-14 ⁵	0.20 ⁵	-14 ⁵	0.20 ⁵	-14 ⁵	0.20 ⁵	—	—	-42	0.008
T _r	Reflection Tracking ⁴	+0.5 ⁵ -2.5 ⁵	+0.06 ⁵ -0.25 ⁵	+2.0 -2.6	0.26 ⁵	+1.6 -1.9	0.20 ⁵	±0.06	0.007	±0.06	0.007
T _t	Transmission Tracking ⁴	+0.5 ⁵ -2.5 ⁵	+0.06 ⁵ -0.25 ⁵	±0.35 ⁵	0.04 ⁵	±0.35 ⁵	0.04 ⁵	—	—	±0.05	0.006
C	Crosstalk	-80 ⁵	0.0001 ⁵	-80 ⁵	0.0001	-90 ⁵	0.000032	—	—	-90 ⁶	0.000032
R _{r1}	Port 1 Reflection Connector Repeatability (Typical)	-70 dB or 0.00032 linear									
R _{t1}	Port 1 Transmission Connector Repeatability (Typical)	-70 dB or 0.00032 linear									
R _{r2}	Port 2 Reflection Connector Repeatability (Typical)	-70 dB or 0.00032 linear									
R _{t2}	Port 2 Transmission Connector Repeatability (Typical)	-70 dB or 0.00032 linear									
N _l	Low-Level Noise (Noise Floor)	-95 dBm									
N _h	High-Level Noise ⁷	Magnitude: 0.004 dB or 0.00046 linear									
A _m , A _p	HP 8753B Magnitude and Phase Dynamic Accuracy Error	Refer to "Dynamic Accuracy" in this section									
S _{t1}	Port 1 Cable Transmission Phase Stability ⁸	0.05 x f(GHz), degrees									
S _{r1}	Port 1 Cable Reflection Stability ⁸	-70 dB or 0.00032 linear									
S _{t2}	Port 2 Cable Transmission Phase Stability ⁸	0.05 x f(GHz), degrees									
S _{r2}	Port 2 Cable Reflection Stability ⁸	-70 dB or 0.00032 linear									
T _{td}	Transmission Tracking Drift (Typical)	Magnitude: 0.0015 x Δ°C, linear Phase: [0.1 + 0.15 x f(GHz)] x Δ°C, degrees									
T _{rd}	Reflection Tracking Drift (Typical)	Magnitude: 0.0015 x Δ°C, linear Phase: ⁹ [0.1 + 0.15 x f(GHz)] x Δ°C, degrees									

1. Accuracy enhancement procedures are performed using HP 85031B 7 mm calibration kit. Environmental temperature is 25°C ± 5°C at calibration; ± 1°C from calibration temperature must be maintained for valid measurement calibration.

2. With IF bandwidth of 10 Hz.

3. With impedance-matched load.

4. Includes effects of switch repeatability.

5. Typical.

6. Typically, crosstalk after accuracy enhancement is -100 dB.

7. High-level noise is the RMS of a continuous measurement of a short circuit or thru. Refer to trace noise performance test.

8. Arrived at by bending HP 11857D cables out perpendicular to front panel and reconnecting. Stability is much better with less flexing.

9. Arrived at using HP 11857D cables and full 2-port calibration. Drift is much better without cables and with 1-port calibration. For this case, drift typically is [0.1 + 0.05 x f(GHz)] x Δ°C, degrees.

Table 5. Typical System Performance for Devices with 50 Ohm Type-N Connectors
HP 8753B with HP 85046A, 85044A, or 85047A Test Set up to 3 GHz

Symbol	Error Terms	Uncorrected		Typical Residual after Accuracy Enhancement ^{1, 2}							
				Response Only		Response and Isolation		One-Port		Full Two-Port ³	
		dB	Linear	dB	Linear	dB	Linear	dB	Linear	dB	Linear
D	Directivity	-30	0.032	-30	0.032	-44 ⁴	0.0063	-44	0.0063	-44	0.0063
M _s	Source Match ⁵	-16 ⁶	0.16	-16	0.16	-16	0.16	-35	0.018	-35	0.018
M _l	Load Match ⁵	-16 ⁶	0.16	-16 ⁶	0.16	-16	0.16	—	—	-42	0.008
T _r	Reflection Tracking ⁵	±1.5	+0.19 -0.16	+1.5 -1.8	0.19	+1.4 -1.6	0.17	±0.06	0.007	±0.06	0.007
T _t	Transmission Tracking ⁵	±1.5 ⁷	+0.19 -0.16	±0.20	0.026	±0.20	0.026	—	—	±0.05	0.006
C	Crosstalk	-90	0.000032	-90	0.000032	-100 ⁸	0.00001	—	—	-100 ⁸	0.00001
R _{r1}	Port 1 Reflection Connector Repeatability (Typical)	-65 dB or 0.00056 linear									
R _{t1}	Port 1 Transmission Connector Repeatability (Typical)	-65 dB or 0.00056 linear									
R _{r2}	Port 2 Reflection Connector Repeatability (Typical)	-65 dB or 0.00056 linear									
R _{t2}	Port 2 Transmission Connector Repeatability (Typical)	-65 dB or 0.00056 linear									
N _l	Low-Level Noise (Noise Floor)	-100 dBm									
N _h	High-Level Noise ⁹	Magnitude: 0.004 dB or 0.00046 linear									
A _m , A _p	HP 8753B Magnitude and Phase Dynamic Accuracy Error	Refer to "Dynamic Accuracy" in this section									
S _{t1}	Port 1 Cable Transmission Phase Stability ¹⁰	0.05 x f(GHz), degrees									
S _{r1}	Port 1 Cable Reflection Stability ¹⁰	-70 dB or 0.00032 linear									
S _{t2}	Port 2 Cable Transmission Phase Stability ¹⁰	0.05 x f(GHz), degrees									
S _{r2}	Port 2 Cable Reflection Stability ¹⁰	-70 dB or 0.00032 linear									
T _{td}	Transmission Tracking Drift (Typical)	Magnitude: 0.0015 x Δ°C, linear Phase: [0.1 + 0.15 x f(GHz)] x Δ°C, degrees									
T _{rd}	Reflection Tracking Drift (Typical)	Magnitude: 0.0015 x Δ°C, linear Phase: ¹¹ [0.1 + 0.15 x f(GHz)] x Δ°C, degrees									

1. Accuracy enhancement procedures are performed using HP 85032B 50Ω type-N calibration kit. Environmental temperature is 25°C ±5°C at calibration: ±1°C from calibration temperature must be maintained for valid measurement calibration.
2. With IF bandwidth of 10 Hz.
3. One-path 2-port calibration with HP 85044A.
4. With impedance-matched load.
5. Includes effects of switch repeatability.
6. Applies over most of the frequency range. Refer to test set manual for detailed specifications.

7. HP 85044A typically has a +6 dB offset.
8. Typically, crosstalk after accuracy enhancement is -110 dB.
9. High-level noise is the RMS of a continuous measurement of a short circuit or thru. Refer to the trace noise performance test.
10. Arrived at by bending HP 11857D cables out perpendicular to front panel and reconnecting. Stability is much better with less flexing.
11. Arrived at using HP 11857D cables and full 2-port calibration. Drift is much better without cables and with 1-port calibration. For this case, drift typically is [0.1 + 0.05 x f(GHz)] x Δ°C, degrees.

Table 6. Typical System Performance for Devices with 50 Ohm Type-N Connectors
HP 8753B with HP 85047A Test Set, 3 GHz to 6 GHz

Symbol	Error Terms	Uncorrected		Typical Residual after Accuracy Enhancement ^{1, 2}							
				Response Only		Response and Isolation		One-Port		Full Two-Port	
		dB	Linear	dB	Linear	dB	Linear	dB	Linear	dB	Linear
D	Directivity	-25	0.06	-25	0.06	-40 ³	0.01	-40	0.01	-40	0.01
M _s	Source Match ⁴	-14	0.20	-14	0.20	-14	0.20	-32	0.025	-32	0.025
M _l	Load Match ⁴	-14	0.20	-14	0.20	-14	0.20	—	—	-38	0.013
T _r	Reflection Tracking ⁴	+0.5 -2.5	+0.06 -0.25	+2.0 -2.6	0.26	+1.7 -2.0	0.21	±0.12	0.014	±0.12	0.014
T _t	Transmission Tracking ⁴	+0.5 -2.5	+0.06 -0.25	±0.35	0.04	±0.35	0.04	—	—	±0.06	0.007
C	Crosstalk	-80	0.0001	-80	0.0001	-90 ⁵	0.000032	—	—	-90 ⁵	0.000032
R _{r1}	Port 1 Reflection Connector Repeatability (Typical)	-65 dB or 0.00056 linear									
R _{t1}	Port 1 Transmission Connector Repeatability (Typical)	-65 dB or 0.00056 linear									
R _{r2}	Port 2 Reflection Connector Repeatability (Typical)	-65 dB or 0.00056 linear									
R _{t2}	Port 2 Transmission Connector Repeatability (Typical)	-65 dB or 0.00056 linear									
N _l	Low-Level Noise (Noise Floor)	-95 dBm									
N _h	High-Level Noise ⁶	Magnitude: 0.004 dB or 0.00046 linear									
A _m , A _p	HP 8753B Magnitude and Phase Dynamic Accuracy Error	Refer to "Dynamic Accuracy" in this section									
S _{t1}	Port 1 Cable Transmission Phase Stability ⁷	0.05 x f(GHz), degrees									
S _{r1}	Port 1 Cable Reflection Stability ⁷	-70 dB or 0.00032 linear									
S _{t2}	Port 2 Cable Transmission Phase Stability ⁷	0.05 x f(GHz), degrees									
S _{r2}	Port 2 Cable Reflection Stability ⁷	-70 dB or 0.00032 linear									
T _{td}	Transmission Tracking Drift (Typical)	Magnitude: 0.0015 x Δ°C, linear Phase: [0.1 + 0.15 x f(GHz)] x Δ°C, degrees									
T _{rd}	Reflection Tracking Drift (Typical)	Magnitude: 0.0015 x Δ°C, linear Phase: ⁸ [0.1 + 0.15 x f(GHz)] x Δ°C, degrees									

1. Accuracy enhancement procedures are performed using HP 85032B 50Ω type-N calibration kit. Environmental temperature is 25°C ±5°C at calibration: ±1°C from calibration temperature must be maintained for valid measurement calibration.
2. With IF bandwidth of 10 Hz.
3. With impedance-matched load.
4. Includes effects of switch repeatability.
5. Typically, crosstalk after accuracy enhancement is -100 dB.

6. High-level noise is the RMS of a continuous measurement of a short circuit or thru. Refer to trace noise performance test.
7. Arrived at by bending HP 11857D cables out perpendicular to front panel and reconnecting. Stability is much better with less flexing.
8. Arrived at using HP 11857D cables and full 2-port calibration. Drift is much better without cables and with 1-port calibration. For this case, drift typically is [0.1 + 0.05 x f(GHz)] x Δ°C, degrees.

Table 7. Typical System Performance for Devices with 3.5 mm Connectors

HP 8753B with HP 85046A, 85044A, or 85047A Test Set up to 3 GHz

Symbol	Error Terms	Uncorrected		Typical Residual after Accuracy Enhancement ^{1, 2}							
				Response Only		Response and Isolation		One-Port		Full Two-Port ³	
		dB	Linear	dB	Linear	dB	Linear	dB	Linear	dB	Linear
D	Directivity	-30	0.032	-30	0.032	-40 ⁴	0.01	-40	0.01	-40	0.01
M _s	Source Match ⁵	-16 ⁶	0.16	-16 ⁶	0.16	-16	0.16	-36	0.015	-36	0.015
M _l	Load Match ⁵	-16 ⁶	0.16	-16 ⁶	0.16	-16	0.16	—	—	-38	0.012
T _r	Reflection Tracking ⁵	± 1.5	+0.19 -0.16	+1.51 -1.83	0.19	+1.3 -1.6	0.17	± 0.14	0.016	± 0.14	0.016
T _t	Transmission Tracking ⁵	± 1.5 ⁷	+0.19 -0.16	± 0.2	0.026	± 0.20	0.026	—	—	± 0.05	0.006
C	Crosstalk	-90	0.000032	-90	0.000032	-100 ⁸	0.00001	—	—	-100 ⁸	0.00001
R _{r1}	Port 1 Reflection Connector Repeatability (Typical)	-70 dB or 0.00032 linear									
R _{t1}	Port 1 Transmission Connector Repeatability (Typical)	-70 dB or 0.00032 linear									
R _{r2}	Port 2 Reflection Connector Repeatability (Typical)	-70 dB or 0.00032 linear									
R _{t2}	Port 2 Transmission Connector Repeatability (Typical)	-70 dB or 0.00032 linear									
N _l	Low-Level Noise (Noise Floor)	-100 dBm									
N _h	High-Level Noise ⁹	Magnitude: 0.004 dB or 0.00046 linear									
A _m , A _p	HP 8753B Magnitude and Phase Dynamic Accuracy Error	Refer to "Dynamic Accuracy" in this section									
S _{t1}	Port 1 Cable Transmission Phase Stability ¹⁰	0.05 x f(GHz), degrees									
S _{r1}	Port 1 Cable Reflection Stability ¹⁰	-70 dB or 0.00032 linear									
S _{t2}	Port 2 Cable Transmission Phase Stability ¹⁰	0.05 x f(GHz), degrees									
S _{r2}	Port 2 Cable Reflection Stability ¹⁰	-70 dB or 0.00032 linear									
T _{td}	Transmission Tracking Drift (Typical)	Magnitude: 0.0015 x Δ°C linear Phase: [0.1 + 0.15 x f(GHz)] x Δ°C, degrees									
T _{rd}	Reflection Tracking Drift (Typical)	Magnitude: 0.0015 x Δ°C linear Phase: ¹¹ [0.1 + 0.15 x f(GHz)] x Δ°C, degrees									

1. Accuracy enhancement procedures are performed using HP 85033C 3.5 mm calibration kit. Environmental temperature is 25°C ± 5°C at calibration; ± 1°C from calibration temperature must be maintained for valid measurement calibration.
 2. With IF bandwidth of 10 Hz.
 3. One-path 2-port calibration with HP 85044A.
 4. With impedance-matched load.
 5. Includes effects of switch repeatability.
 6. Applies over most of the frequency range. Refer to test set manual for detailed specifications.

7. HP 85044A typically has a +6 dB offset.
 8. Typically, crosstalk after accuracy enhancement is -110 dB.
 9. High-level noise is the RMS of a continuous measurement of a short circuit or thru. Refer to the trace noise performance test.
 10. Arrived at by bending HP 11857D cables out perpendicular to front panel and reconnecting. Stability is much better with less flexing.
 11. Arrived at using HP 11857D cables and full 2-port calibration. Drift is much better without cables and with 1-port calibration. For this case, drift typically is [0.1 + 0.05 x f(GHz)] x Δ°C, degrees.

Table 8. Typical System Performance for Devices with 3.5 mm Connectors
HP 8753B with HP 85047A Test Set, 3 GHz to 6 GHz

Symbol	Error Terms	Uncorrected		Typical Residual after Accuracy Enhancement ^{1, 2}							
				Response Only		Response and Isolation		One-Port		Full Two-Port	
		dB	Linear	dB	Linear	dB	Linear	dB	Linear	dB	Linear
D	Directivity	-25	0.06	-25	0.06	-35	0.018	-35	0.018	-35	0.018
M _s	Source Match ⁴	-14	0.20	-14	0.20	-14	0.20	-30	0.032	-30	0.032
M _l	Load Match ⁴	-14	0.20	-14	0.20	-14	0.20	—	—	-32	0.025
T _r	Reflection Tracking ⁴	+0.5 -2.5	+0.06 -0.25	+2.0 -2.6	0.26	+1.7 -2.0	0.21	±0.12	0.016	±0.12	0.014
T _t	Transmission Tracking ⁴	+0.5 -2.5	+0.06 -0.25	±0.35	0.04	±0.35	0.04	—	—	±0.1	0.012
C	Crosstalk	-80	0.0001	-80	0.0001	-90 ⁵	0.000032	—	—	-90 ⁵	0.000032
R _{r1}	Port 1 Reflection Connector Repeatability (Typical)	-70 dB or 0.00032 linear									
R _{t1}	Port 1 Transmission Connector Repeatability (Typical)	-70 dB or 0.00032 linear									
R _{r2}	Port 2 Reflection Connector Repeatability (Typical)	-70 dB or 0.00032 linear									
R _{t2}	Port 2 Transmission Connector Repeatability (Typical)	-70 dB or 0.00032 linear									
N _l	Low-Level Noise (Noise Floor)	-95 dBm									
N _h	High-Level Noise ⁶	Magnitude: 0.004 dB or 0.00046 linear									
A _m , A _p	HP 8753B Magnitude and Phase Dynamic Accuracy Error	Refer to "Dynamic Accuracy" in this section									
S _{t1}	Port 1 Cable Transmission Phase Stability ⁷	0.05 x f(GHz), degrees									
S _{r1}	Port 1 Cable Reflection Stability ⁷	-70 dB or 0.00032 linear									
S _{t2}	Port 2 Cable Transmission Phase Stability ⁷	0.05 x f(GHz), degrees									
S _{r2}	Port 2 Cable Reflection Stability ⁷	-70 dB or 0.00032 linear									
T _{td}	Transmission Tracking Drift (Typical)	Magnitude: 0.0015 x Δ°C linear Phase: [0.1 + 0.15 x f(GHz)] x Δ°C, degrees									
T _{rd}	Reflection Tracking Drift (Typical)	Magnitude: 0.0015 x Δ°C linear Phase: ⁸ [0.1 + 0.15 x f(GHz)] x Δ°C, degrees									

1. Accuracy enhancement procedures are performed using HP 85033C 3.5 mm calibration kit. Environmental temperature is 25°C ± 5°C at calibration; ± 1°C from calibration temperature must be maintained for valid measurement calibration.

2. With IF bandwidth of 10 Hz.

3. With impedance-matched load.

4. Includes effects of switch repeatability.

5. Typically, crosstalk after accuracy enhancement is -100 dB.

6. High-level noise is the RMS of a continuous measurement of a short circuit or thru. Refer to trace noise performance test.

7. Arrived at by bending HP 11857D cables out perpendicular to front panel and reconnecting. Stability is much better with less flexing.

8. Arrived at using HP 11857D cables and full 2-port calibration. Drift is much better without cables and with 1-port calibration. For this case, drift typically is [0.1 + 0.05 x f(GHz)] x Δ°C, degrees.

**Table 9. Typical System Performance for Devices with 75 Ohm Type-N Connectors
HP 8753B with HP 85046B or 85044B Test Set**

Symbol	Error Terms	Uncorrected		Typical Residual after Accuracy Enhancement ^{1, 2}							
				Response Only		Response and Isolation		One-Port		Full Two-Port ³	
		dB	Linear	dB	Linear	dB	Linear	dB	Linear	dB	Linear
D	Directivity	-30	0.032	-30	0.032	-44 ⁴	0.0063	-44	0.0063	-44	0.0063
M _s	Source Match ⁵	-16 ⁶	0.16	-16 ⁶	0.16	-16	0.16	-35	0.018	-35	0.018
M _l	Load Match ⁵	-16 ⁶	0.16	-16 ⁶	0.16	-16	0.16	—	—	-42	0.008
T _r	Reflection Tracking ⁵	±1.5	+0.19 -0.16	+1.5 -1.8	0.19	+1.3 -1.6	0.17	±0.06	0.007	±0.06	0.007
T _t	Transmission Tracking ⁵	±1.5 ⁷	+0.019 -0.16	±0.21	0.025	±0.20	0.026	—	—	±0.05	0.006
C	Crosstalk	-85	0.000063	-85	0.000063	-94 ⁸	0.00002	—	—	-94 ⁸	0.00002
R _{r1}	Port 1 Reflection Connector Repeatability (Typical)	-65 dB or 0.00056 linear									
R _{t1}	Port 1 Transmission Connector Repeatability (Typical)	-65 dB or 0.00056 linear									
R _{r2}	Port 2 Reflection Connector Repeatability (Typical)	-65 dB or 0.00056 linear									
R _{t2}	Port 2 Transmission Connector Repeatability (Typical)	-65 dB or 0.00056 linear									
N _l	Low-Level Noise (Noise Floor)	-94 dBm									
N _h	High-Level Noise ⁹	Magnitude: 0.004 dB or 0.00046 linear									
A _m , A _p	HP 8753B Magnitude and Phase Dynamic Accuracy Error	Refer to "Dynamic Accuracy" in this section									
S _{t1}	Port 1 Cable Transmission Phase Stability ¹⁰	0.05 x f(GHz), degrees									
S _{r1}	Port 1 Cable Reflection Stability ¹⁰	-70 dB or 0.00032 linear									
S _{t2}	Port 2 Cable Transmission Phase Stability ¹⁰	0.05 x f(GHz), degrees									
S _{r2}	Port 2 Cable Reflection Stability ¹⁰	-70 dB or 0.00032 linear									
T _{td}	Transmission Tracking Drift (Typical)	Magnitude: 0.0015 x Δ°C linear Phase: [0.1 + 0.15 x f(GHz)] x Δ°C, degrees									
T _{rd}	Reflection Tracking Drift (Typical)	Magnitude: 0.0015 x Δ°C linear Phase: ¹¹ [0.1 + 0.15 x f(GHz)] x Δ°C, degrees									

1. Accuracy enhancement procedures are performed using HP 85036B 75Ω type-N calibration kit. Environmental temperature is 25°C ±5°C at calibration: ±1°C from calibration temperature must be maintained for valid measurement calibration.

2. With IF bandwidth of 10 Hz.

3. One-path 2-port calibration with HP 85044B.

4. With impedance-matched load.

5. Includes effects of switch repeatability.

6. Applies over most of the frequency range. Refer to test set manual for detailed specifications.

7. HP 85044B typically has a +6 dB offset.

8. Typically, crosstalk after accuracy enhancement is -104 dB.

9. High-level noise is the RMS of a continuous measurement of a short circuit or thru. Refer to the trace noise performance test.

10. Arrived at by bending HP 11857B cables out perpendicular to front panel and reconnecting. Stability is much better with less flexing.

11. Arrived at using HP 11857B cables and full 2-port calibration. Drift is much better without cables and with 1-port calibration. For this case, drift typically is [0.1 + 0.05 x f(GHz)] x Δ°C, degrees.

DETERMINING EXPECTED SYSTEM PERFORMANCE

The uncertainty equations, dynamic accuracy calculations, and tables of system performance values provided in the preceding pages can be used to calculate the expected system performance of an HP 8753B system. The following pages explain how to determine the residual errors of a particular system and combine them to obtain total error-corrected residual uncertainty values, using worksheets provided. The uncertainty graphs at the beginning of this *System Performance* section are examples of the results that can be calculated using this information.

Procedures

Table 10 is a worksheet used to calculate the residual uncertainty in reflection measurements. Table 11 is a worksheet for residual uncertainty in transmission measurements. Determine the linear values of the residual error terms and the nominal linear S-parameter data of the device under test as described below and enter these values in the worksheets. Then use the instructions and equations in the worksheets to combine the residual errors for total system uncertainty performance. The resulting total measurement uncertainty values have a confidence factor of 99.9%.

S-Parameter Values. Convert the S-parameters of the test device to their absolute linear terms.

Noise Floor. Refer to the *Receiver Noise Level Performance Test* in the *On-Site System Service Manual* to determine the actual noise floor performance of your measurement setup.

Crosstalk. Refer to the *Input Crosstalk Performance Test*. Connect an impedance-matched load to each of the test ports and measure S₂₁ or S₁₂ after calibration. Turn on the marker statistics function (see Chapter 6, *Using Markers*), and measure the mean value of the trace. Use the mean value plus one standard deviation as the residual crosstalk value of your system.

Dynamic Accuracy. Determine the absolute linear magnitude dynamic accuracy as described under *Dynamic Accuracy* in this chapter.

Other Error Terms. Refer to Tables 3 through 9, depending on the test set and connector type in your system. Find the absolute linear magnitude of the remaining error terms.

Combining Error Terms. Combine the above terms using the reflection or transmission uncertainty equations in the worksheets.

Table 10. Reflection Measurement Uncertainty Worksheet

In the columns below, enter the appropriate values for each term. Frequency: _____			
Error Term	Symbol	dB Value	Linear Value
Directivity	D	_____	_____
Reflection tracking	T_r	_____	_____
Source match	M_s	_____	_____
Load match	M_l	_____	_____
Dynamic accuracy			
Magnitude	A_m	_____	_____
Phase	A_p	_____	_____
S11	S11	_____	_____
S21	S21	_____	_____
S12	S12	_____	_____
Noise floor	N_l	_____	_____
High level noise	N_h	_____	_____
Connector reflection repeatability	R_r	_____	_____
Connector transmission repeatability	R_t	_____	_____
Magnitude drift due to temperature	$T_{rd} \text{ (mag)}$	_____	_____
Phase drift due to temperature	$T_{rd} \text{ (phase)}$	_____	_____
Cable reflection stability	S_r	_____	_____
Cable transmission stability	S_t	_____	_____

Magnitude

Combine Systematic Errors. In the space provided, enter the appropriate linear values from the list of errors. Then combine these errors to obtain the total sum of systematic errors.

$(1 + T_{sw}) \times (D + S_{r1})$	(___ + ___) × (___ + ___) = ___ [k]
$(T_{sw} + T_r) \times (S11)$	(___ + ___) × (___) = ___ [l]
$(S_{r1} + M_{sw} + M_s) \times (S11) \times (S11)$	(___ + ___ + ___) × (___) × (___) = ___ [m]
$M_l \times S21 \times S12$	(___ × ___ × ___) = ___ [n]
$(A_m) \times (S11)$	(___) × (___) = ___ [o]
Total: k + l + m + n + o	___ + ___ + ___ + ___ = ___ [S]

Combine Random Errors. In the space provided, enter the appropriate linear values from the list of errors. Then combine these errors in an RSS fashion to obtain a total sum of the random errors.

$3 \times (N_l)$	$3 \times (\quad) = \quad$ [w]
$3 \times (N_h) \times (S11)$	$3 \times (\quad) \times (\quad) = \quad$ [x]
$R_{r1} + 2 \times (R_{t1}) \times (S11) + (R_{r1}) \times (S11) \times (S11)$	___ + 2 × (___) × (___) + (___) × (___) × (___) = ___ [y]
$(R_{r2}) \times (S21) \times (S12)$	(___) × (___) × (___) = ___ [z]
$\sqrt{w^2 + x^2 + y^2 + z^2}$	$\sqrt{ \quad \times \quad + \quad \times \quad + \quad \times \quad + \quad \times \quad } = \quad$ [R]
$V_r = S + R$	___ + ___ = ___
$E_{rm}(\text{linear}) = V_r + T_{rd}(\text{mag}) \times S11$	___ + (___ × ___) = ___
$E_{rm}(\text{log}) = 20 \text{ Log } (1 \pm E_{rm}/S11)$	$20 \text{ Log } (1 \pm \quad / \quad) = \quad$ dB

Phase

$E_{rp} = \text{Arcsin}[(V_r - A_m \times S11)/S11] + T_{rd}(\text{phase}) + 2 \times S_{t1} + A_p$ $\text{Arcsin}[(\quad - \quad \times \quad) / \quad] + \quad + 2 \times \quad + \quad = \pm \quad$ degrees

Table 11. Transmission Measurement Uncertainty Worksheet

In the columns below, enter the appropriate values for each term. Frequency: _____			
Error Term	Symbol	dB Value	Linear Value
Crosstalk	C	_____	_____
Transmission tracking	T _t	_____	_____
Source match	M _s	_____	_____
Load match	M _l	_____	_____
Dynamic accuracy		_____	_____
Magnitude	A _m	_____	_____
Phase	A _p	_____	_____
S11	S11	_____	_____
S21	S21	_____	_____
S12	S12	_____	_____
S22	S22	_____	_____
Noise floor	N _l	_____	_____
High level noise	N _h	_____	_____
Connector reflection repeatability	R _r	_____	_____
Connector transmission repeatability	R _t	_____	_____
Magnitude drift due to temperature	T _{rd} (mag)	_____	_____
Phase drift due to temperature	T _{rd} (phase)	_____	_____
Cable reflection stability	S _r	_____	_____
Cable transmission stability	S _t	_____	_____

Magnitude

Combine Systematic Errors. In the space provided, enter the appropriate linear values from the list of errors. Then combine these errors to obtain the total sum of systematic errors.

C	= _____ [k]
(T _{sw} + T _t) × (S21)	(_____ + _____) × (_____) = _____ [l]
(S _{r1} + M _{sw} + M _s) × (S11) × (S21)	(_____ + _____ + _____) × (_____) × (_____) = _____ [m]
(S _{r2} + M _{sw} + M _l) × (S21) × (S22)	(_____ + _____ + _____) × (_____) × (_____) = _____ [n]
(A _m) × (S21)	(_____) × (_____) = _____ [o]
k + l + m + n + o	_____ + _____ + _____ + _____ + _____ = _____ [S]

Combine Random Errors. In the space provided, enter the appropriate linear values from the list of errors. Then combine these errors in an RSS fashion to obtain a total sum of the random errors.

3 × (N _l)	3 × (_____) = _____ [w]
3 × (N _h) × (S21)	3 × (_____) × (_____) = _____ [x]
(R _{t1}) × (S21) + (R _{r1}) × (S11) × (S21)	(_____) × (_____) + (_____) × (_____) × (_____) = _____ [y]
(R _{t2}) × (S21) + (R _{r2}) × (S22) × (S21)	(_____) × (_____) + (_____) × (_____) × (_____) = _____ [z]
$\sqrt{w^2 + x^2 + y^2 + z^2}$	$\sqrt{_____^2 + _____^2 + _____^2 + _____^2} = _____ [R]$
V _t = S + R	_____ + _____ = _____
E _{tm} (linear) = V _t + T _{rd} (mag) × S21	_____ + (_____ × _____) = _____
E _{tm} (log) = 20 Log (1 ± E _{tm} /S21)	20 Log (1 ± _____ / _____) = _____ dB

Phase

E_{tp} = Arcsin[(V_t × A_m × S21) / S21] + T_{rd}(phase) + S_{t1} + S_{t2} + A_p Arcsin[(_____ - _____ × _____) / _____] + _____ + _____ + _____ + _____ = ± _____ degrees



HP 8753B NETWORK ANALYZER

System Installation



HEWLETT
PACKARD

CONTENTS

- 1 Introduction
- 1 Site Preparation
- 2 Receiving and Inspection
- 3 Installation
- 5 Setting up the Instruments
- 7,8 Rack Mount Kit Instructions
- 9 Power Considerations
- 12 HP-IB Considerations
- 15 Other System Interconnections
- 17 Storage and Shipment
- 18 System Installation Checklist

INTRODUCTION

This section provides instructions for installing and interconnecting the HP 8753B system in a rack-mounted or bench configuration. Information includes site preparation, receiving shipment, initial inspection, power and grounding requirements, rack mounting, bench installation, system interconnections, and instructions for repacking and shipment.

Checklists are provided following the instructions for site preparation and installation. Complete these checklists to ensure that steps are not overlooked. Table 1 is the site preparation checklist, and Table 4 is the installation checklist.

SITE PREPARATION

A site must be provided that meets the space, power, environmental, and communications requirements of the system ordered, as described below.

Space Requirements

If the system has been ordered with a rack such as the HP 85043B system rack, sufficient space must be provided for the rack plus a minimum clearance of 15 cm (6 in) behind and on both sides of the rack to allow proper ventilation. The HP 85043B system rack measures 124 cm (49 in) high by 60 cm (24 in) wide by 80 cm (32 in) deep. The total depth of the rack with the work surface installed is 115 cm (45 in).

Power Requirements

The voltage and frequency requirements for the power source of the HP 8753B are listed in Table 2 in this section. The test sets obtain power from the HP 8753B and do not require an outside power source.

If the system has been ordered with an HP 85043B rack, power will be supplied to the rack through its heavy-duty grounded primary power cable, and to the individual instruments in the rack through special power cables included with the rack. The rack should be connected to a circuit capable of supplying 2000 VA without interruption, and without interference from other equipment such as air conditioners or large motors. An additional power line outlet should be provided for the controller of an automatic system.



A properly grounded AC outlet is mandatory when operating the HP 8753B. Operating the HP 8753B with an improperly grounded or floating ground prong WILL DAMAGE THE INSTRUMENT!

Environmental Requirements

For best performance, the operating environment for the HP 8753B should meet the following requirements:

- Temperature between 0°C and +55°C
- Relative humidity between 5% and 95% at +40°C (non-condensing)
- Altitude up to 4500 metres (approximately 15,000 feet)
- RFI and EMI susceptibility defined by VDE 0730, CISPR Publication 11, and FCC Class B Standards.

The system can be operated in environments outside this range with a possibility of degradation in performance and a higher risk of failure. For temperature limitations on specified performance, refer to the table of specifications in the *General Information and Specifications* section of this manual.

In addition to the above requirements, the following considerations should be observed:

- The environment should be as dust-free as possible, and the air filters in the instruments and the rack should be cleaned regularly.
- Electrostatic discharge (ESD) should be controlled by use of static-safe work procedures. For bench installation, the HP 92175T antistatic bench mat will decrease the possibility of damage from ESD.

RECEIVING AND INSPECTION

Receiving Shipment

The instruments ordered as components of the HP 8753B system may be shipped separately from different points of origin, and will not arrive together in a single shipment. It is recommended that the shipping containers be kept in one area and not unpacked until all the instruments are delivered. Before unpacking, verify that all system components ordered have arrived by comparing the shipping forms to the original system purchase order.

Initial Inspection

Inspect all shipping containers. If your shipment is damaged or incomplete, save all packing materials and notify both the shipping carrier and the nearest Hewlett-Packard Sales and Service Office. Hewlett-Packard will arrange for repair or replacement of damaged or incomplete shipments without waiting for a settlement from the transportation company. Notify the HP customer engineer of any problems.

As you unpack the system components, verify that the serial numbers listed on the shipping documents are the same as those on the rear panels of the instruments. Keep the packing materials in case they are needed for reuse.

Any instruments or computer equipment already on hand that are intended for use in the system should be verified before being integrated into the system. Collect all components of the system at the installation site.

Complete the site preparation checklist. If you have ordered HP 8753B +23N, On-Site Installation and Verification, contact the Hewlett-Packard customer engineer to perform installation, configuration, and system verification. If you did not order this support product, perform the procedures described under "Installation."

INSTALLATION

If you have ordered HP 8753B +23N, On-Site Installation and Verification, the installation of your system will be performed by a Hewlett-Packard customer engineer. Be sure that all system components have been delivered, unpacked, and collected at the installation site before you contact the customer engineer to schedule the installation.

If you have not ordered HP installation and verification, read the following instructions for:

1. Setting up the instruments in a bench-top or rack-mount configuration. Either of these may be an automatic system: that is, it may include a computer controller.
2. Making correct power connections and checking power-on and self test for each instrument.
3. Making HP-IB connections and checking HP-IB addresses.
4. Completing system interconnections before performing tests of the system functions.

Table 1. HP 8753B System Site Preparation Checklist

(Refer to preceding paragraphs for details.)

Space Requirements

- Rack-Mounted System
 - 90 cm x 130 cm (36 in x 51 in)
(including clearance) []
- Bench-Top System
 - Bench or table to hold instruments []
- Automatic System
 - Controller table 930 mm x 712 mm (36 in x 28 in) []

Power Requirements

- PROPERLY GROUNDED AC POWER OUTLET** []
 - Operating the HP 8753A/B without proper AC ground WILL DAMAGE THE INSTRUMENT!
- Rack-Mounted System
 - 1 multiple-outlet power strip (2000 VA)
(includes outlets for service) []
- Bench-Top System
 - 2 multiple-outlet power strips (2000 VA)
(includes outlets for service) []

Environmental Requirements

- Temperature: +20°C to +30°C (+68°F to +86°F) []
- Humidity: 5% to 80% RH (20-60?? 20-80??) []
- Altitude: 0 to 4500 metres (15,000 feet) []
- RFI and EMI susceptibility defined []
- Antistatic tabletop mat []

Operating Supplies

- Plotter paper, spare pens, etc. on hand []

System Components

- Shipment complete []
- Serial numbers verified []
- Instruments already on hand verified []
- All instruments collected at installation site []

On-Site Installation

- Customer engineer contacted, installation scheduled []

SETTING UP THE INSTRUMENTS

Because there are numerous possible configurations of HP 8753B systems, the instruments can be set up in different ways according to individual situations. The instructions given here are for typical bench-top and rack-mounted system setups. Instructions for connecting the system cables are provided following the power check and HP-IB address check.

Bench-Top Systems

If the system includes an S-parameter test set, place this on the bench at least 15 cm (6 inches) back from the front edge. Put the HP 8753B on top of the S-parameter test set.

If the system will be used with an HP 85044A/B transmission/reflection test set, place the HP 8753B on the bench at least 30 cm (12 inches) back from the front edge. Place the test set in front of the HP 8753B.

Put the plotter (or printer) on top of the HP 8753B. If this is not an automatic (computer-controlled) system and a printer is to be used in addition to the plotter, place the printer on the bench next to the network analyzer/test set combination. A typical system setup is illustrated in Figure 1.

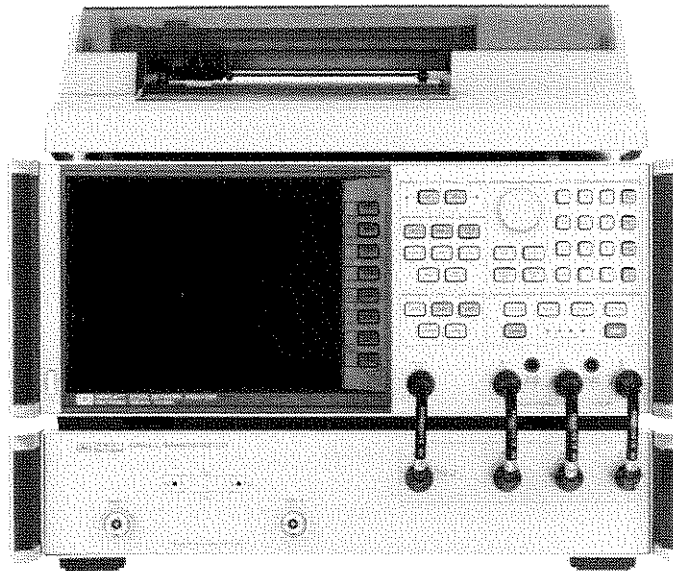

Figure 1. Typical Bench-Top System Setup

Rack-Mounted Systems

The recommended system rack or cabinet for the HP 8753B is HP 85043B, which includes the necessary flange kits for rack mounting. Four short AC power cords are supplied with the rack to connect power from the special cabinet power strip to each instrument in the cabinet. The manual for the HP 85043B rack provides instructions specific to the HP 8753B system. Follow the instructions for correct spacing of the instrument rails for your particular system, and for installation of the work surface. Be sure to install the foam baffling as described in the rack manual: this baffling is necessary for proper cooling, which is accomplished by the individual instrument fans.

The HP 85043B rack has been specifically engineered for the HP 8753B system, and full measurement performance can be expected from systems installed in it. Use of any other rack may adversely affect warranty and support issues. Other racks may promote overheating, dust contamination, and shock hazard, and are not recommended. Electrical and mechanical specifications may be affected by custom-racked system configurations, instrument cooling may be deficient, and electromagnetic interference may be increased. If a user-configured rack system is necessary, the HP customer engineer should be consulted about warranty and support details.

CAUTION

The system rack must be in its normal upright position when the instruments are installed. Do not install instruments with the rack on its side or its back. Major damage to the instruments and the rack can occur if this is done.

IMPORTANT NOTE: If you are using the HP 8753B in a rack mount configuration, make sure cabinet fan airflow and instrument fan airflow are compatible. If not, simply turn the HP 8753B fan around, reversing its airflow direction. To gain access to the fan, remove the rear panel assembly. Instructions are provided in the "Replacement Procedures" section of the *HP 8753B On-Site System Service Manual*.

Stand the rack upright and immobilize it. With the HP 85043B this is done by fully extending the four lock feet at the bottom of the rack.

If your system cabinet does not have a power plug that corresponds to the jack you intend to use, you will need to obtain the correct plug for your needs. Do not plug in the cabinet power cable at this time.

Prepare the instruments for installation into the rack. Remove the feet from all system instruments by lifting the tabs on each foot and sliding it toward the center of the instrument and out of its slot.

Attach flanges to all instruments to be rack-mounted. The HP 85043B rack is shipped with flanges and screws included. In addition, two rack-mount flange kits are available to mount the HP 8753B in any rack with 482.6 mm (19 inches) horizontal spacing. Option 908, illustrated in Figure 2, is a flange kit for rack-mounting the instrument with its handles removed. Option 913, illustrated in Figure 3, is a kit for rack-mounting the instrument with the handles. Follow the illustrated procedures.

Install the instruments by sliding them into place in their designated spaces in the system rack. If an S-parameter test set is part of the system, it must be installed directly below the HP 8753B. Check the distance from the test port connectors to the work surface to be sure it will accommodate different test devices. Secure each instrument in place with four dress screws.

Automatic (Computer-Controlled) Systems

Place the computer in the center of the table provided for it. Refer to the computer manual for detailed instructions on setting up the computer.

Put the plotter on top of the computer and the printer beside it.

RACK MOUNT KIT WITH FRONT HANDLES REMOVED

HP PART NUMBER 5061-9678 (OPTION 908)

CONTENTS

QTY.		PART NO.
2	RACK MOUNT FLANGE	5020-8863
8	M4 × 0.7 × 10 P.H.SCREW (METRIC)	0515-1114

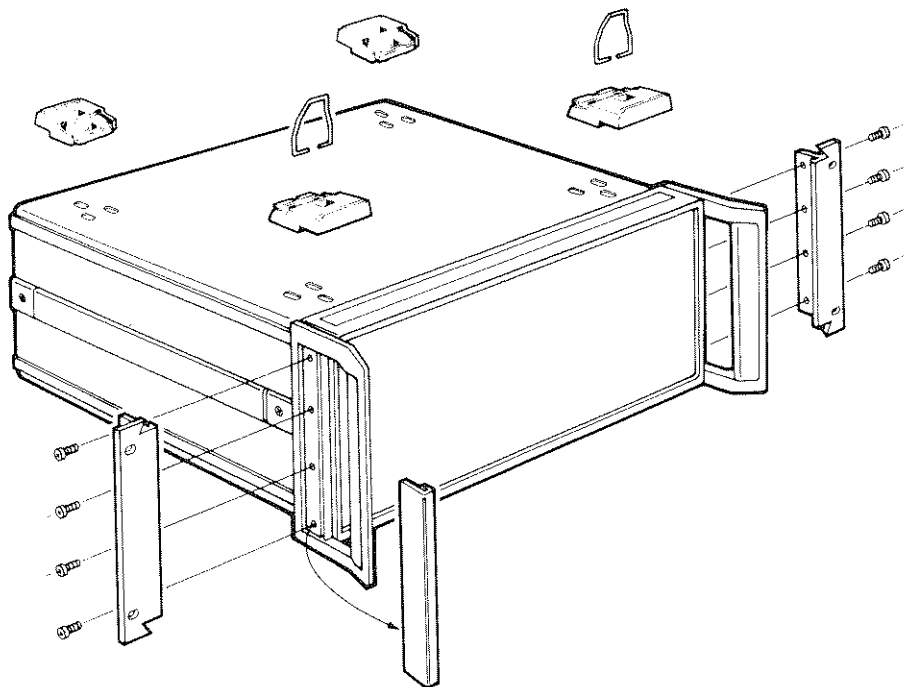

INSTRUCTIONS

1. Remove side trim strips.
2. Remove 4 screws and one front handle assembly from each side.
3. Attach rack mount flange to each side with 4 screws.
4. Remove feet and tilt stands before rack mounting.

Figure 2. Rack Flange Kit Mounting Instructions (Option 908)

RACK MOUNT KIT FOR CABINETS WITH PREVIOUSLY ATTACHED FRONT HANDLES

HP PART NUMBER 5061-9772 (OPTION 913)

CONTENTS

QTY.		PART NO.
2	RACK MOUNT FLANGE	5020-8875
8	M4 × 0.7 × 16 P.H.SCREW (METRIC)	0515-1106

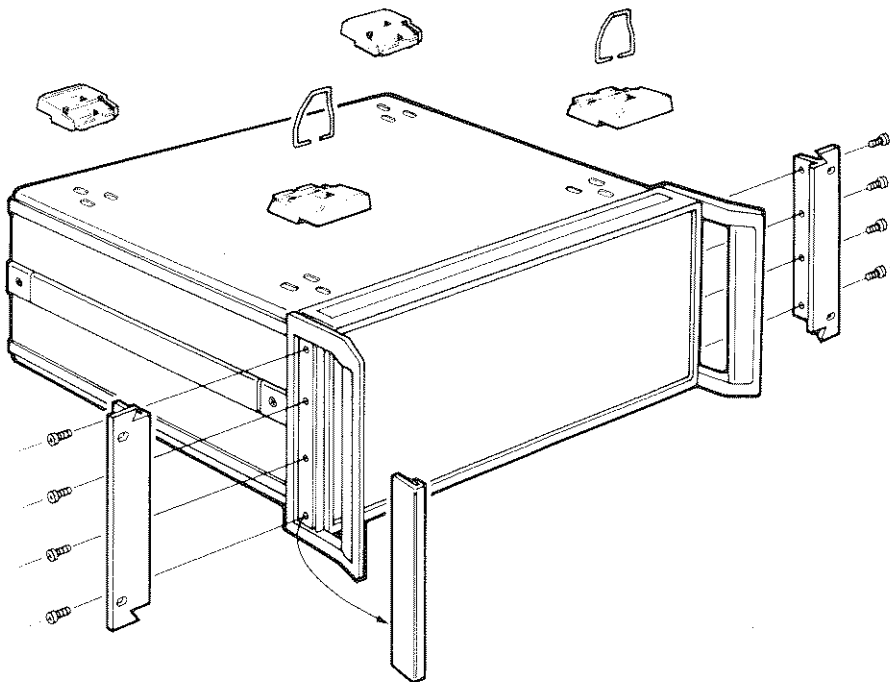

INSTRUCTIONS

1. Remove side trim strips.
2. Remove 4 screws per side.
3. Attach rack mount flange and front handle assembly with 4 new longer screws per side.
4. Remove feet and tilt stands before rack mounting.

Figure 3. Rack Mounting Kit with Handles (Option 913)

POWER CONSIDERATIONS



A properly grounded AC outlet is mandatory when operating the HP 8753B. Operating the HP 8753B with an improperly grounded or floating ground prong WILL DAMAGE THE INSTRUMENT!

Line Voltage and Fuse Selection



To prevent damage to any of the instruments in the system, make the correct line voltage and fuse selection for each instrument before connecting line power to the system.

The HP 8753B is provided with a voltage selector to match the instrument to the AC line voltage available at the site of installation. This voltage selector is a thumbnail switch located directly above the power cord receptacle on the rear panel. Determine the AC line voltage present, and set the switch to the value closest to that voltage, either 115V or 230V. Table 2 lists the possible range of the actual line voltage for each switch setting. If the line voltage is not within one of these ranges, use an autotransformer between the power source and the HP 8753B.



If an autotransformer is required, it must provide continuity to earth ground or the HP 8753B will be damaged.

The required fuse rating for the HP 8753B is listed in Table 2 and is also printed on the rear panel. The fuse is located in a fuse housing immediately above the power receptacle in the AC line module. To remove the fuse housing, insert a small screwdriver into the slot at the base of the housing and pull forward and out. A spare fuse is also supplied in the fuse housing.

Table 2. Line Voltage and Fuse Values

Actual Line Voltage	90 to 127 Vac	195 to 253 Vac
Corresponding Switch Setting	115V	230V
Fuse Value	3.15A	3.15A
(Alternate for Canada)	3.0A	3.0A

Frequency 47.5 to 66.0 Hz, single phase

Each instrument in the system must be set to operate with the available AC line voltage, and the correct line fuse must be installed. Fuse ratings for different line voltage settings vary between different instruments, so follow the instructions provided in the operating manual for each instrument.

Power Cables

In accordance with international safety standards, each instrument in the HP 8753B system is equipped with a three-wire power cable. When connected to an appropriate outlet, this cable grounds the instrument. The offset pin of the three-prong connector is the grounding pin. If the system or any instrument is operated from a two-contact outlet, preserve the protective grounding feature by using a three-prong to two-prong adapter and connecting the ground wire of the adapter to earth ground. The USA adapter is HP part number 1251-0058.



A properly grounded AC outlet is mandatory when operating the HP 8753B. Operating the HP 8753B with an improperly grounded or floating ground prong will damage the instrument! Under no circumstances use a three-prong to two-prong adapter without connecting the ground wire to earth ground. Make sure a three prong outlet is properly grounded. Floating the HP 8753B's ground prong will damage the instrument!

Table 3 lists the part numbers for power cables supplied with HP instruments and illustrates the type of plug on each cable. The type of power cable shipped with the instrument depends on the country of destination. The HP part numbers listed are for complete power cables including the plugs.





Before turning on any instrument in the system, be sure that its three-wire power cord is inserted in a socket outlet provided with a protective earth contact. Do not defeat this protective feature by using an extension cord without a protective ground conductor. Grounding one conductor of a two-conductor outlet is not sufficient protection.

If the system is rack-mounted, connect the short power cables supplied with the rack from the power strip in the rack to the instruments. Connect the rack to line power. Connect bench-top instruments to line power.

Turn on the line switches. Check that each instrument is on and has passed its self test, if any.

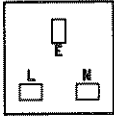
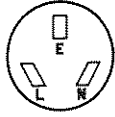
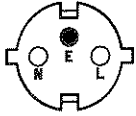
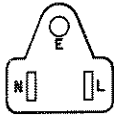
Table 3. AC Power Cables Available

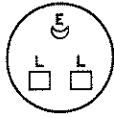
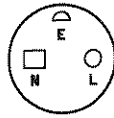
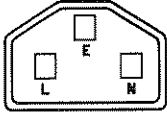
Plug Type ¹	Cable HP Part Number ²	CD ³	Plug Description ²	Cable Length (inches)	Cable Color	For Use in Country
250V 	8120-1351 8120-1703	0 6	Straight BS1363A 90°	90 90	Mint Gray Mint Gray	United Kingdom, Cyprus, Nigeria, Zimbabwe, Singapore
250V 	8120-1369 8120-0696	0 4	Straight ZNSS198/ASC112 90°	79 87	Gray Gray	Australia, New Zealand
250V 	8120-1689 8120-1692	7 2	Straight CEE7-VII 90°	79 79	Mint Gray Mint Gray	East and West Europe, Saudi Arabia, Egypt, Republic of So. Africa, India (unpolarized in many nations)
125V 	8120-1348 8120-1398 8120-1754 8120-1378 8120-1521 8120-1676	5 5 7 1 6 2	Straight NEMA5-15P 90° Straight NEMA5-15P 90° Straight NEMA5-15P 90°	80 80 36 80 80 36	Black Black Black Jade Gray Jade Gray Jade Gray	United States, Canada, Japan (100V or 200V), Mexico, Philippines, Taiwan
250V 	8120-2104	3	Straight SEV1011.1959 24507, Type 12	79	Gray	Switzerland
250V 	8120-0698	6	Straight NEMA6-15P			United States, Canada
220V 	8120-1957 8120-2956	2 3	Straight DHCK 107 90°	79 79	Gray Gray	Denmark
250V 	8120-1860	6	Straight CEE22-VI (System Cabinet Use)			

1. E = Earth Ground; L = Line; N = Neutral
2. Part number shown for plug is industry identifier for plug only. Number shown for cable is HP Part Number for complete cable including plug.
3. The Check Digit (CD) is a coded digit that represents the specific combination of numbers used in the HP Part Number. It should be supplied with the HP Part Number when ordering any of the power assemblies listed above, to expedite speedy delivery.

HP-IB CONSIDERATIONS

In an automated system, the computer controller communicates with the HP 8753B and other compatible peripherals via HP-IB (Hewlett-Packard Interface Bus). HP-IB can also be used by the HP 8753B as controller to output measurement results directly to a compatible plotter or printer. Figure 4 illustrates the HP-IB connections in a typical measurement setup.

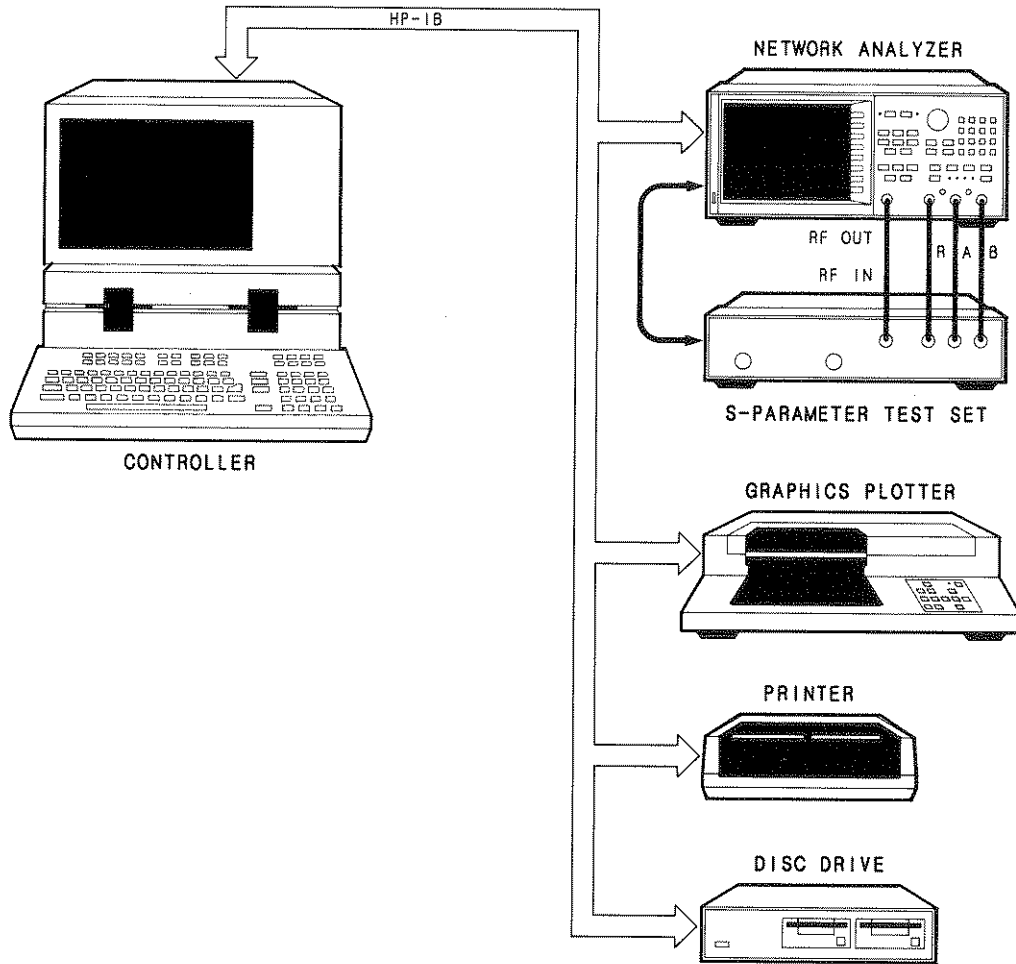

Figure 4. HP-IB Connections in a Typical Setup

HP-IB Connectors and Cables

The HP-IB connector is located on the rear panel of the HP 8753B. This is used to connect the HP 8753B to a controller via HP-IB with or without other instruments connected in parallel. It is also used for HP-IB interface when the HP 8753B itself is the controller of peripheral devices.

All instruments on the interface bus are interconnected by HP-IB cables. Figure 5 illustrates an HP-IB cable and provides a list of available HP-IB cables and their part numbers. As many as fifteen instruments can be connected in parallel on HP-IB, but proper voltage levels and timing relationships must be maintained. If the system cable is too long or if the accumulated cable length between instruments is too long, the data and control lines cannot be driven properly and the system may fail to perform. Therefore, observe the following restrictions:

- 4 metres (12 feet) is the maximum cable length with two instruments in a system.
- 2 metres (6 feet) is the maximum cable length to each instrument when more than two instruments are connected on the bus.
- 20 metres (65 feet) is the maximum total cable length between all units.

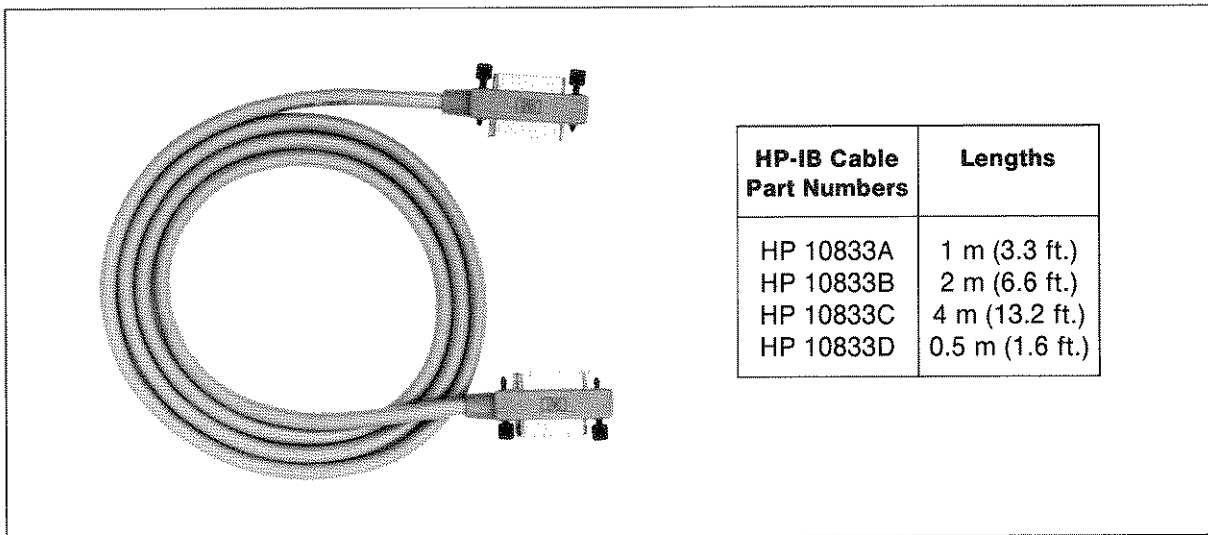

Figure 5. HP-IB Cables Available

Turn off line power to each of the system instruments and connect the HP-IB cables as follows (HP-IB cables can be connected one on top of another). Tighten the screws on each of the HP-IB connectors.

1. Connect an HP-IB cable between the controller and the HP 8753B.
2. Connect an HP-IB cable between the HP 8753B and the plotter, and an HP-IB cable between the HP 8753B and the printer.
3. Connect an HP-IB cable between the HP 8753B and the external disc drive, if used.
4. Note that no HP-IB connection is needed to the test set.
5. Turn on the instruments to check the HP-IB addresses as described below.

HP-IB Addresses

In HP-IB communications, each instrument is identified by an HP-IB address. This decimal-based address code must be different for each instrument on the bus.

Check the HP-IB address of each of the instruments in the system. Most of the HP-IB addresses are factory preset and need not be modified for normal system operation. The standard factory-set addresses for instruments that may be part of the system are as follows:

Instrument	HP-IB Address (decimal)
HP 8753B	16
Plotter	05
Printer	01
External Disc Drive	00
Controller	21
Power Meter	13

To verify that the HP 8753B recognizes the correct addresses, press the **[LOCAL]** key, and the HP-IB softkey menu will be displayed along the right-hand edge of the CRT. Press the key adjacent to the label **[SET ADDRESSES]**. The address menu will be displayed.

Press **[ADDRESS 8753]** and observe the display. The number 16 should be displayed in the active entry area of the CRT. If the number displayed is not 16, press **[1] [6] [x1]**. The display should now show 16. This HP 8753B address is not affected by preset or by turning the line switch off.

Press each of the other **[ADDRESS]** softkeys and verify that the correct address is displayed for each instrument. If any instrument is set to an HP-IB address other than the default, the HP 8753B can be modified to recognize that address. Enter the desired address using the number pad, and terminate with the **[x1]** key. Addresses assigned in this way are retained in memory and automatically recalled whenever the instrument is powered on. Detailed information on HP 8753B front panel and softkey operation is provided in the *Operating and Programming Reference* in this manual.

Addresses can be physically changed on the individual instruments, except for the HP 8753B, by changing the HP-IB switch settings. Instructions are provided in the manual for each instrument. The HP 8753B does not have an HP-IB switch: its address is set only from the front panel, as described above.

Individual HP-IB address labels can be ordered using HP part number 7120-6853 (see Figure 6). These labels can be used on the rear panel of each instrument in the system for quick reference to the HP-IB address.

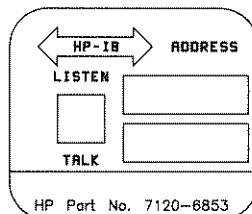

Figure 6. HP-IB Address Label

OTHER SYSTEM INTERCONNECTIONS

Systems Using the HP 85046A/B or 85047A S-Parameter Test Set

The test set interconnect cable is supplied with the S-parameter test set. Connect this cable between the TEST SET INTERCONNECT receptacle on the HP 8753B and the NETWORK ANALYZER INTERCONNECT receptacle on the S-parameter test set.

Four short RF connecting cables are included with each S-parameter test set. Connect these between the front panel connectors on the HP 8753B and the corresponding connectors on the test set.

The HP 11857D 7 mm test port return cable set is required for use with the HP 85046A or 85047A test sets. The HP 11857B 75 ohm type-N test port return cable set is required with the HP 85046B test set. Connect these cables to PORT 1 and PORT 2 of the S-parameter test set. The device under test will be connected to the test port return cables.

Figure 7 illustrates the interconnections in a typical measurement setup using an S-parameter test set. Measurement setups for different applications are illustrated in the *Operating and Programming Reference*.

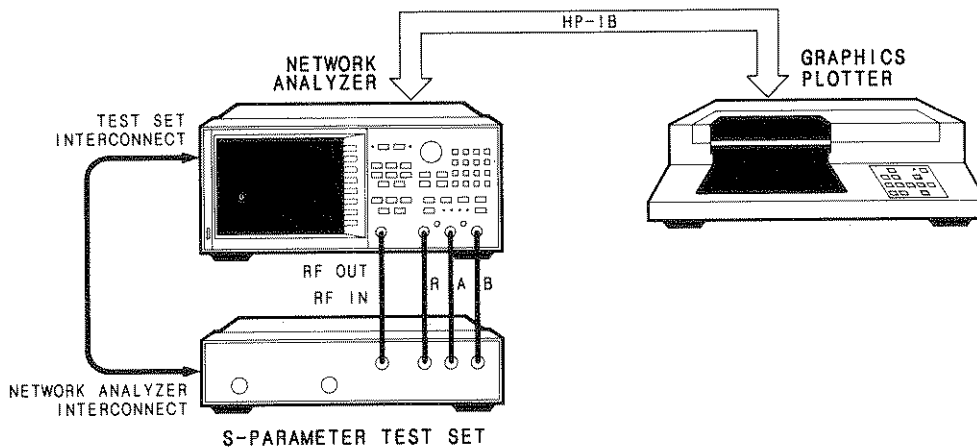

Figure 7. Typical Interconnections with S-Parameter Test Set

Systems Using the HP 85044A/B Transmission/Reflection Test Set

The HP 11851B 50 ohm type-N RF cable set is required to connect the HP 8753B to the HP 85044A/B transmission/reflection test set. Use the three matched cables to connect the front panel connectors of the HP 8753B to the corresponding connectors on the rear panel of the test set. The longer cable is typically used to connect the output of a two-port device under test to the B input of the HP 8753B.

The HP 11852B 50 to 75 ohm minimum loss pad is included with the HP 85044B 75 ohm test set. This pad is required between a 75 ohm device and the RF cable to input B of the HP 8753B, or another 50 ohm measurement accessory.

Figure 8 illustrates the interconnections in a typical measurement setup using an HP 85044A/B transmission/reflection test set.

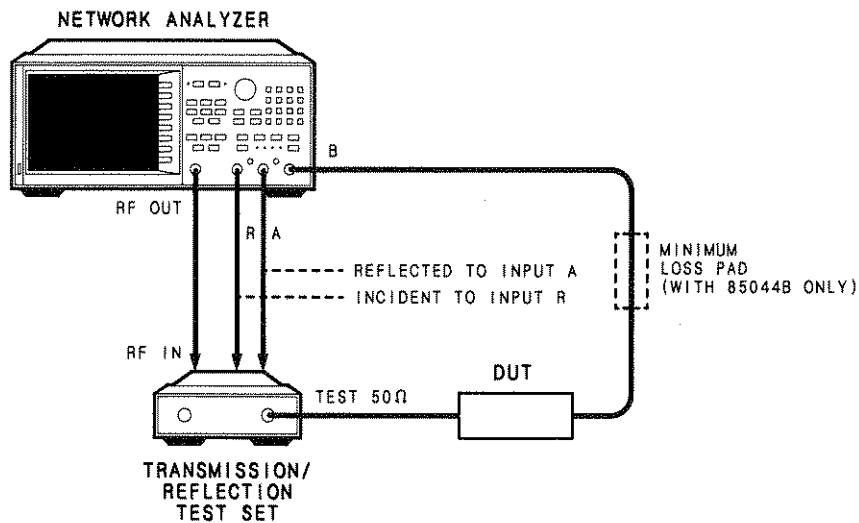

Figure 8. Typical Interconnections with HP 85044A/B Test Set

Rear Panel BNC Connectors

The EXT REF INPUT connector is used for phase locking the HP 8753B to an external frequency standard.

The AUX INPUT connector is used to connect an external DC voltage source for measurement on the CRT.

The EXT AM connector is used to connect an external signal to the HP 8753B to amplitude modulate the source signal.

The EXT TRIGGER connector is used to connect an external signal to trigger the sweep of the HP 8753B.

Additional information about the rear panel connectors is provided in the *Supplemental Characteristics* table in the *General Information and Specifications* section.

STORAGE AND SHIPMENT

Environmental constraints for storage and shipment of the HP 8753B system are not as stringent as for system operation. The following environmental limits are acceptable:

- Temperature between -40°C and $+75^{\circ}\text{C}$.
- Relative humidity up to 90% relative at $+65^{\circ}\text{C}$ (non-condensing)
- Altitude up to 15240 metres (50,000 feet)

The instruments should be protected from temperature and humidity conditions that might cause internal condensation.

If the system is rack-mounted, it must be stored with the rack standing upright. If the cabinet is stored in any other position with the instruments installed, the stress may cause mechanical and electrical damage to the instruments. The cabinet can be wheeled about its immediate installation area with the instruments installed, but care must be used since the instruments are sensitive and heavy. Turn the leveling foot on each bottom corner of the HP 85043B cabinet clockwise, so that the feet do not interfere with movement. For safety's sake, enlist the aid of another person to help guide and steady the cabinet.

INSTALLATION CHECKLIST

Complete the system installation checklist before performing a test of the system functions. Three levels of tests are available: Operator's Check, On-Site Verification, and Performance Tests. These tests are described in the *General Information and Specifications* section of this manual.

Packaging

If the HP 8753B or any of the system components is to be returned to Hewlett-Packard for service, attach a tag indicating the service required, return address, instrument model number, and full serial number, then pack as described below. Use the blue service tags located behind the *System Installation* tab in the *Operating and Programming Manual*. In any correspondence, refer to the instrument(s) by model number and full serial number.

The rack cabinet should never be shipped with the instruments installed. All instruments should be removed and individually packaged before shipment.

If any instrument is to be reshipped, it is best to use the original factory packaging materials. If you have not retained the original packaging, you can order similar containers and materials from the nearest Hewlett-Packard office. Addresses are listed at the back of this manual.

If other packaging materials are used, be sure to wrap the instrument (with service tag) in heavy paper or plastic, and place the wrapped instrument in a strong shipping container such as a double-wall carton made of 350-pound test material. Pack a three to four inch layer of shock absorbing material around the instrument. Seal the carton securely, and mark it FRAGILE.

Table 4. HP 8753B System Installation Checklist (1 of 2)

(Refer to preceding paragraphs for details)

SETTING UP THE INSTRUMENTS

Bench-Top System

Instruments in place []

Rack-Mounted System

Rack configured to hold instruments []

Work surface installed []

Foam baffling installed []

Rack stabilized []

Correct power plug []

Instrument feet removed []

Flanges attached []

Instruments installed in rack []

Secured in place with screws []

Automatic System

Controller in place []

POWER CONSIDERATIONS

PROPERLY GROUNDED AC POWER OUTLET []

Operating the HP 8753A/B without proper
AC ground WILL DAMAGE THE INSTRUMENT!

All instruments set to correct line voltage []

Correct fuse installed in all instruments []

Rack-Mounted System

Short cables connected from rack strip to instruments []

Rack connected to line power []

Bench-Mounted System

Instruments connected to line power []

Line power on. Self test passed.

HP 8753B []

Plotter []

Printer []

Controller []

External disc drive []

Other []

Table 4. HP 8753B System Installation Checklist (2 of 2)

HP-IB CONSIDERATIONS

Power off	[]
Cable length within listed limits	[]
HP-IB cables connected	
Controller → HP 8753B	[]
HP 8753B → plotter	[]
HP 8753B → printer	[]
HP 8753B → external disc drive	[]
Other	[]
Power on	[]
Addresses checked	[]
HP 8753B	[]
Plotter	[]
Printer	[]
Controller	[]
External disc drive	[]

OTHER SYSTEM INTERCONNECTIONS

Systems with S-Parameter Test Set

Test set interconnect cable	[]
Four short RF connecting cables	[]
Test port return cables	[]

Systems with Transmission/Reflection Test Set

Three matched cables and longer cable	[]
Minimum loss pad for 75 ohm system	[]

Rear Panel BNC Connectors if Used

EXT REF INPUT	[]
AUX INPUT	[]
EXT AM	[]
EXT TRIGGER	[]





System Installation

The System Installation Section is initially packaged with the getting started documents shipped with the HP 8753B. After performing System Installation, place the document here.

HP 8753B NETWORK ANALYZER

Operator's Check



HEWLETT
PACKARD

Operator's Check

CONTENTS

1	Introduction
1	Operator's Check
3	In Case of Difficulty
5	Routine Maintenance
5	Cleaning the Fan Filter
5	Cleaning the CRT and Glass Cover
5	Connector Care

INTRODUCTION

The Operator's Check procedure tests all circuits in the HP 8753B. If the tests pass successfully, it verifies (with approximately 80% confidence) that the HP 8753B is functioning properly. This procedure does not verify conformance to the specifications, nor does it verify the test set or other accessories associated with the HP 8753B.

To verify the HP 8753B individual instrument-level specifications or the system-level uncertainty limits, refer to the other verification procedures available:

- On-Site Verification is comprised of two types of tests:

System Verification, which verifies the system-level, accuracy-enhanced uncertainty limits of the HP 8753B with a test set.

On-Site Tests, which verify selected performance parameters of the HP 8753B.

- Performance tests verify the warranted instrument-level specifications of each individual instrument in an HP 8753B system. Refer to the *Performance Tests* section in the *On-site System Service Manual* and in the test set manual.

Refer to the *On-Site Verification* section in the *On-Site System Service Manual*.

OPERATOR'S CHECK

Description

The source output of the HP 8753B is divided by a power splitter, with one output arm driving the R input for phase locking, and the other arm driving either the A or B input (see Figure 1). A fixed coaxial 20 dB attenuator reduces the output power level so that the source may be exercised at high power levels without exceeding the maximum input power level.

These tests exercise the source across its full frequency range at several power levels between -5 dBm and $+20$ dBm. The receiver inputs are tested up to 3 GHz at several power levels between -31 dBm and -11 dBm, in absolute and ratio modes.

The resulting measurement must fall within a limit testing window to pass the test. The window size is based on both source and receiver specifications, plus expected variations due to the external equipment used. The characteristics tested are listed below. (Note that this test does *not* verify the specification limits associated with the following characteristics.)

- source flatness
- source power accuracy
- receiver flatness
- receiver absolute amplitude accuracy
- receiver ratio amplitude accuracy

NOTE: This test does not test option 006 (6 GHz receiver operation) above 3 GHz. However, it does perform an operational check on all related circuits. This test is intended to determine if the instrument is operational. Instrument failures will likely be obvious even with this limitation.

Equipment Required

20 dB attenuator HP 8491A Opt. 020RF cable set, type-N (m) connectors, both ends.
Cables must be identical (phase matched) HP 11851B
Two-way power splitter HP 11667A Opt. 001

Procedure

NOTE: In this procedure, front panel keys are shown in brackets with bold print. Display softkeys are shown in brackets and are in bold italic print.

1. Disconnect any test set from the HP 8753B. Connect the equipment as shown in Figure 1, with one power splitter output connected to input A on the HP 8753B. Make sure all connections are tight.
2. Allow the HP 8753B to warm up for 30 minutes.
3. First, run the test for inputs R and A: press **[PRESET]**, then **[SYSTEM] [SERVICE MENU] [TESTS] [EXTERNAL TESTS]**.
4. The display should show "TEST 21 R&A Op Check" in the active entry area.
5. Press **[EXECUTE TEST]** to begin the test.
6. Press **[CONTINUE]**.
7. The test is a sequence of nine subtests. After each subtest, the routine displays a PASS/FAIL message and pauses to allow you to examine the results of that subtest. At the pause, do one of the following:
 - a. Press **[CONTINUE]** to continue on to the next subtest, or
 - b. Examine the test results by using the **[SCALE/REF]** functions and/or **[MKR]** functions. Then, when you are ready to continue to the next test, press **[SYSTEM] [SERVICE MENU] [TEST OPTIONS] [CONTINUE TEST]**.
 - c. Press **[ABORT]** to exit the sequence of subtests. You may wish to abort if the subtest fails. In this case, go to step 11.

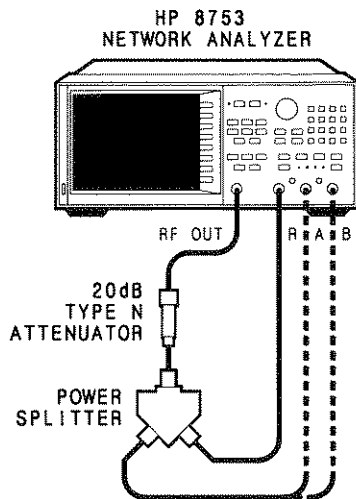

Figure 1. Operator's Check Equipment Setup.

8. At the end of the nine subtests, the test title and result will be displayed. If all subtests pass successfully, the overall test status will be "PASS". If any subtest fails, the overall test status will be "FAIL".
9. Next, run the test for inputs R and B: press **[EXTERNAL TESTS]**, then the step [**▲**] key. The display should show "TEST 22 R&B Op Check" in the active entry area.
10. Repeat steps 5 through 8, with one power splitter output connected to input B on the HP 8753B.
11. If both tests pass, the HP 8753B is about 80% verified. If either test fails:
 - a. Make sure the equipment is connected as shown in Figure 1. Check that all connections are tight. Repeat the test.
 - b. Check the external equipment for damage. Visually inspect the connector interfaces. Verify that the external equipment meets published specifications. Substitute new external equipment, and repeat the test.
 - c. Finally, suspect a problem with the HP 8753B. Refer to the *Performance Tests* section of the *On-Site System Service Manual* for detailed tests, or see the *Troubleshooting* section for fault isolation procedures.

IN CASE OF DIFFICULTY

This section describes common problems or apparent failures, as well as easy solutions that can be performed with the instrument covers on. An operator can solve many problems easily and quickly, with minimum HP 8753B experience and some simple tools.

If the listed solution does not seem to fix the problem, go to the *Troubleshooting* section in the *On-Site System Service Manual*, or contact your local HP service representative.

The problems are listed below by symptom, along with a quick and easy solution.

- Symptom:** Instrument appears dead and the instrument fan is off.
Solution: Check that the main power supply line is providing power. Check the two LEDs on the rear panel: the green LED should be ON and the red LED should be OFF. Check that the line voltage selector switch position matches the line power voltage (120 Vac or 240 Vac). Check the fuse (refer to the *System Installation* section).
- Symptom:** Display screen is blank or out of focus, but CH 1 or CH 2 LED is lit.
Solution: Adjust display intensity or focus with front panel keys. Refer to **[DISPLAY] Key** in Chapter 4 of the *Operating and Programming Reference* section and *CRT Display Adjustments* in the *Adjustments and Correction Constants* section of the *On-Site System Service Manual*.
- Symptom:** Self test fail message is displayed on the CRT immediately after power-on or preset.
Solution: Contact a qualified service technician.
- Symptom:** Phase lock error message is displayed (this includes the “No IF Found. Check R Input Level” message).
Solution: Check that a sample of RF OUT (source output) power is routed to the R input (required for operation); a power splitter or test set can be used. Check that there is not excessive loss in this path; power level into input R must be greater than -35 dBm.
- Symptom:** HP 85046A/B or 85047A test set will not switch and its front panel LEDs are not lit.
Solution: Check the test set interconnect cable and connections between the analyzer and test set.
- Symptom:** Measurements are not repeatable, especially after measurement calibration.
Solution: Check all RF cables and connections. Visually inspect all connectors, and clean if necessary (refer to the *Microwave Connector Care* manual, supplied in the *Test Sets and Accessories* binder). Review proper connection techniques to ensure good, repeatable connections.
- Symptom:** Instrument cannot be programmed via HP-IB.
Solution: Check HP-IB cabling connections. Check that HP-IB addresses match addresses being programmed (refer to Chapter 7 of the *Operating and Programming Reference*). Check that the HP 8753B is set to either **[TALKER/LISTENER]** or **[USE PASS CONTROL]** under the **[LOCAL]** key. Check that the controller can program a known-working instrument.
- Symptom:** Instrument states cannot be saved or recalled from external disc.
Solution: Check HP-IB cabling connections. Check the address of the disc drive. Make sure the HP 8753B is set to **[SYSTEM CONTROLLER]** under the **[LOCAL]** key. Check that disc drive works normally with a controller. Initialize the disc with the HP 8753B and external disc drive. Discs initialized on other instruments will not work. Discs initialized using MS DOS or any other computer operating system will not work.
- Symptom:** Printer/plotter does not respond to HP 8753B front panel commands.
Solution: Check the address of the printer or plotter. Make sure the HP 8753B is set to **[SYSTEM CONTROLLER]** (under the **[LOCAL]** key) and that the pinch wheels of the plotter are down.

ROUTINE MAINTENANCE

Cleaning the Fan Filter

NOTE: If using an HP 8753B with a serial prefix of 2828A and above, ignore manual references to the fan filter.

It is recommended that you clean the fan filter regularly. How regularly depends on the operating environment. It is a good idea to check it weekly and clean it as necessary. If the message, "CAUTION: Air Flow Restricted: Check Fan Filter" is displayed, immediately check for items on the fan that may be impeding the air flow (e.g., a piece of paper). If nothing is on the fan, clean the fan filter as follows:

1. Turn OFF the instrument. Disconnect the HP-IB cables from the HP 8753B rear panel.
2. Remove the plastic fan filter retainer — use either a flat blade screwdriver or your fingers to pry it off; it should pop off easily.
3. Clean the foam filter cover with a vacuum cleaner or shake it out thoroughly to remove the dust and dirt.
4. Replace the foam filter and snap on the plastic filter retainer.

Cleaning the CRT and Glass Cover

1. Remove the softkeys cover (this is the plastic cover through which the front panel softkeys protrude) as follows:
 - a. On the upper or lower left corner of the softkeys cover, *carefully* insert a small, thin, flat screwdriver blade, or a fingernail, between it and the glass cover (see Figure 2 on the next page). If you are using a screwdriver, be extremely careful not to scratch or break the glass.
 - b. Carefully pull the softkey cover forward and off.
2. Remove the two screws that are now uncovered.
3. Remove the display bezel assembly by pulling out the end that is now free and pivoting it around its left edge until it is released.
4. Clean the CRT and the glass cover gently, using a soft cloth. You may need to use cleaning solution. If so, use sparingly and use solutions recommended for optical coated surfaces. HP part number 8500-2163 is one such solution.
5. Allow surfaces to dry before reassembling the bezel and softkeys cover.

Connector Care

For accurate and repeatable measurement results, it is essential that all connectors be cleaned and gaged regularly, handled and stored properly, and regularly inspected for signs of damage. This not only insures the best performance from the connectors, but also extends their life. This is important for connectors on calibration and verification devices, on test ports, cables, and other devices. Refer to the *Microwave Connector Care* manual, contained in the *Test Sets and Accessories* binder, for a detailed description of connector care techniques. The *Microwave Connector Care* manual also describes proper techniques for making connections.

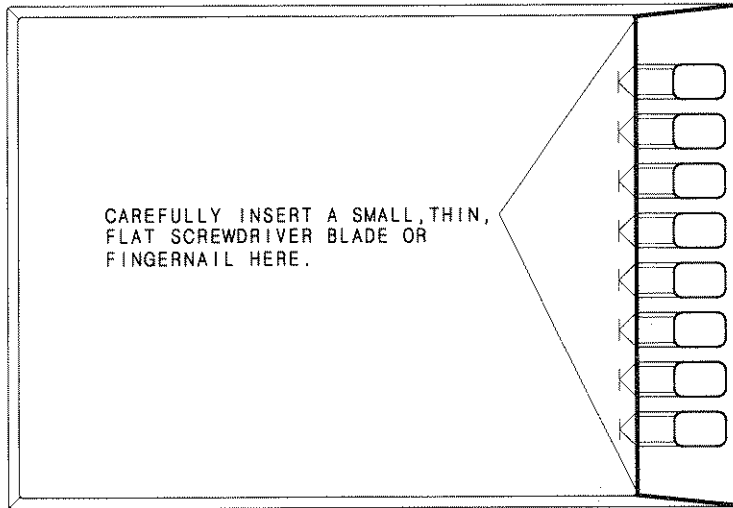

Figure 2. Removing the Softkeys Cover.



Operator's Check

The Operator's Check Section is initially packaged with the getting started documents shipped with the HP 8753B. After performing Operator's Check, place the document here.

User's Guide

 HEWLETT
PACKARD

HP 8753B Network Analyzer

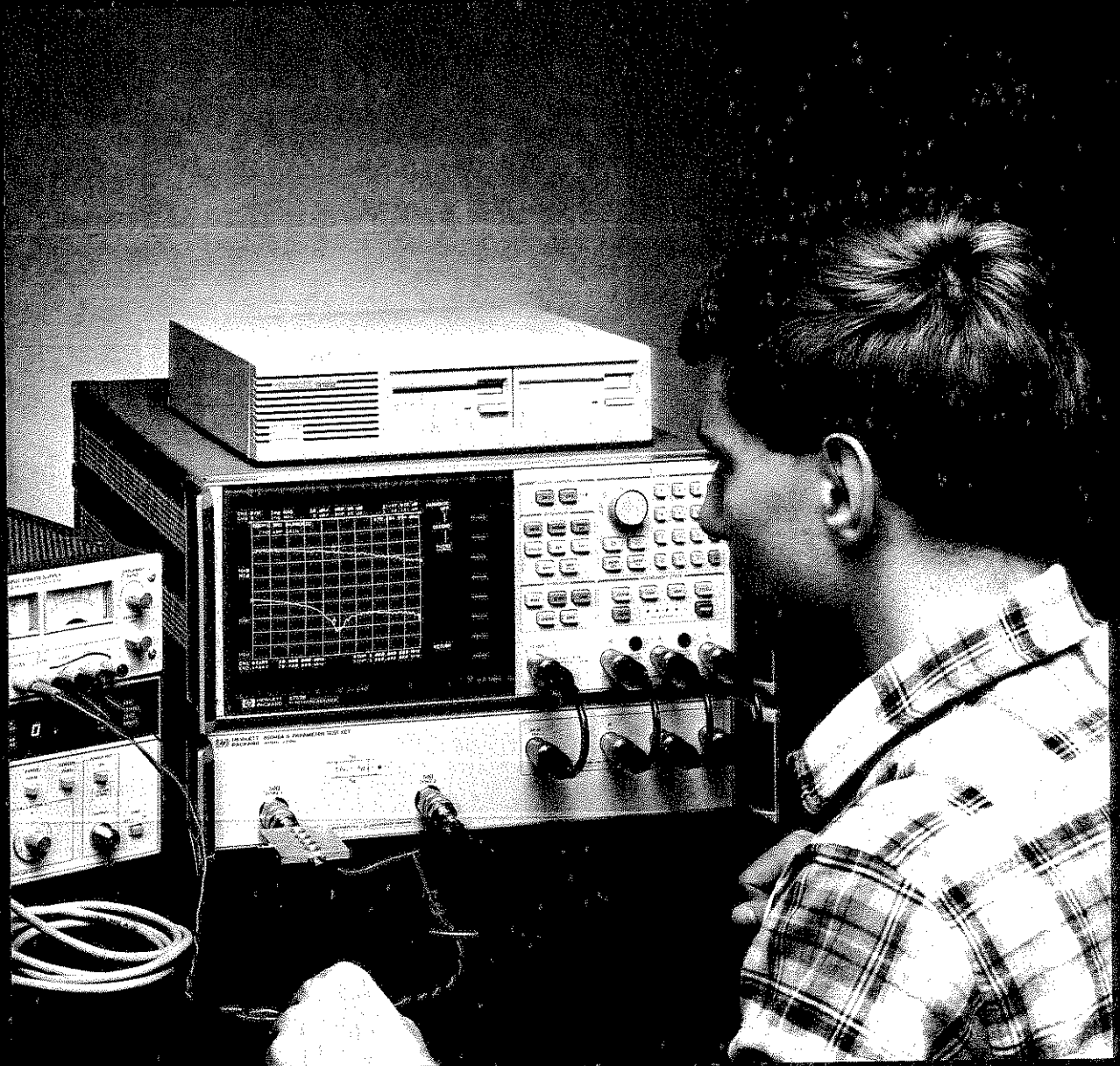

The purpose of this User's Guide is to provide an operator's introduction to the HP 8753B RF network analyzer, showing how the instrument is used for common network measurements. Rather than being a formal text on measurement techniques, it serves to demonstrate many of the features and capabilities of the HP 8753B in actual measurement situations. The example procedures given illustrate the ease with which accurate results can be obtained.

The reader who is fairly new to network analysis will find Chapter 1 helpful. It presents a general procedure for making network measurements, a procedure which is then followed throughout the rest of this User's Guide. Tutorial information on calibration and vector error correction is included to help the user make many of the decisions necessary when setting up a measurement.

Chapters 2 and 3 illustrate the HP 8753B at work making a variety of transmission and reflection measurements. Chapters 4 and 5 discuss the HP 8753B's Time Domain Analysis (Option 010), and Harmonic Measurements (Option 002) features respectively. Chapter 6 will explore the HP 8753B's test sequencing function, while chapter 7 addresses the issue of operation up to 6 GHz.

The examples have been chosen to demonstrate many of the operating modes of the instrument over most of its frequency range. The example device under test is a bandpass filter although the user should be able to adapt the techniques shown to his particular device.

The HP 8753B Operating and Programming Manual (HP Part No. 08753-90119) has more complete operating information for both manual and automatic measurements. Use this reference for further information on any topic covered in this User's Guide. The Quick Operating Guide (HP Part No. 08753-90116) provides a quick review of the softkey menus and manual operation in a handy, ring-bound booklet.

Programming information is provided in the HP-IB chapter of the HP 8753B Operating and Programming Manual, in the Introductory Operating Guide for the HP 8753B Using Series 200 and 300 Computers (HP Part No. 08753-90117) and in the HP 8753B Quick Reference Guide (HP Part No. 08753-90118).

Chapter 1	Operating the HP 8753B.	4
	Getting Acquainted (front panel tour)	
	Preset (starting from a known state)	
	Connections (transmission/reflection and S-parameter setups)	
	Controls (measurement, format, stimulus)	
	Calibration (includes short tutorial on why to calibrate)	
	Measurement Enhancements (IF bandwidth, Averaging, Smoothing, Markers, Copy)	
Chapter 2	Transmission Measurements with the HP 8753B.	18
	Insertion Loss and Gain	
	3 dB Bandwidth	
	Out-of-Band Rejection	
	Passband Ripple	
	Using Limit Lines	
	Phase Response	
	Using the Dual Trace Display	
	Electrical Length	
	Phase Distortion (group delay)	
	Gain Compression	
Chapter 3	Reflection Measurements with the HP 8753B.	27
	Return Loss, Reflection Coefficient, SWR	
	Save/Recall Registers	
	S-Parameters S_{11} and S_{22}	
	Impedance (Smith Charts)	
	Admittance	
Chapter 4	Time Domain Analysis with the HP 8753B	35
	Transmission Response	
	Reflection Response	
Chapter 5	Harmonic Measurements with the HP 8753B	39
	Measuring Swept Harmonics	
Chapter 6	Test Sequencing with the HP 8753B	41
	Creating a Test Sequence	
	Executing a Test Sequence	
	Recalling a Test Sequence	
Chapter 7	Operation up to 6 GHz	44

Operating the HP 8753B

Getting Acquainted

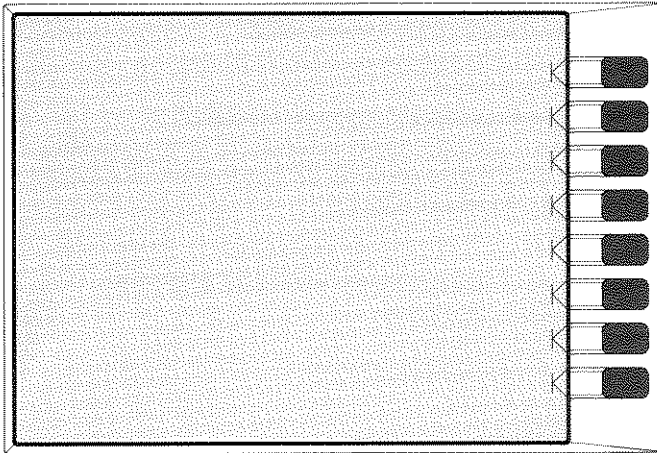

One of the more noticeable characteristics of the HP 8753B is the simplicity of its front panel. Rather than individual keys for each of the many instrument functions, the HP 8753B uses CRT-displayed "menus" for operator input. These menus list the possible choices for a particular function, with each choice corresponding to one of the eight "softkeys" located to the right of the CRT.

The "hardkeys" on the front panel provide access to the various menus, and are grouped by function.

Active Channel

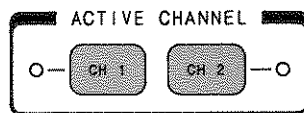

The HP 8753B has dual trace capability with many of the measurement and display functions independently selectable for each trace. To modify the parameters of a particular trace, first select either channel one or two, and then make the desired measurement choices. Note that the LED opposite the channel selection is lit.

Response

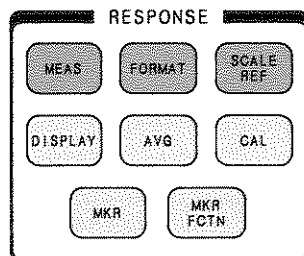

The network analyzer's receiver section is controlled with these keys. The top three keys allow the user to choose a measurement configuration (A, B, B/R, etc), presentation format (amplitude and phase versus frequency, Smith chart, polar coordinates, etc), and scale and reference values for a full screen display.

The lower five keys in this section enhance the usability of the measured data. The displayed traces may be overlaid, manipulated with math function keys, averaged, normalized, or read out at specific points along the trace with up to four independent markers per channel.

Stimulus

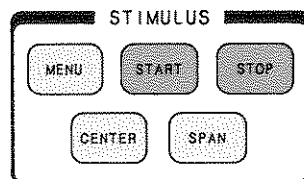

These keys allow the user to define an appropriate source output signal for the device under test. Source frequency may be swept over any portion of the range 300 kHz to 3 GHz, at power levels between +20 and -5 dBm. The stimulus keys can also control the start and stop times in the (optional) time domain mode. The choices for sweep time and resolution, linear versus logarithmic sweep, power sweep, etc. are also selected here.

Data Entry

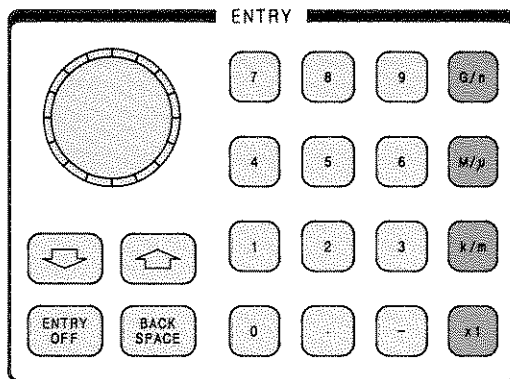

In some cases it is necessary to supply numeric values for a chosen parameter, such as frequency or amplitude. The ten digit keypad is used to supply these values. The keys to the left of the digits terminate the data entry with the appropriate units. Use [G/n] (Giga/nano), [M μ] (Mega/micro), [k/m] (kilo/ milli) and [x1] (basic units: dB, dBm, degree, second, Hz) as applicable. In addition to entering data with the keypad, the knob can be used to make continuous adjustments, while the [↔] and [↔] buttons allow values to be changed in steps.

Instrument State

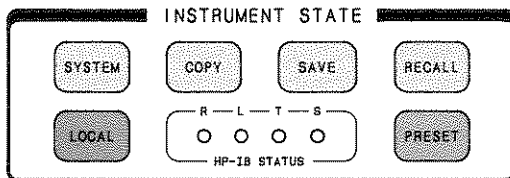

Several utility functions are implemented with these keys, including instrument preset, front panel save/recall memory, HP-GL plotter control, time domain transform (optional) and built-in diagnostic tests.

Example of Softkey Operation

To average a series of twenty consecutive traces to reduce the effects of random noise the following key sequence may be used:

[AVG] 1. Press this hardkey to cause the "Average" menu to be displayed.

[AVERAGING FACTOR] 2. Press this softkey to indicate that a new averaging factor is about to be entered. Note that this causes the current averaging factor to be displayed.

[2] [0] 3. Enter the new averaging factor from the keypad. The digits are shown on the display as they are entered. An arrow appears to the right of the last digit entered. To correct the last digit entered, press [BACK SPACE]. To begin again, press [AVERAGING FACTOR].

[x1] 4. Terminate the entry with the appropriate units. In this case the averaging factor is unitless. The arrow to the right of the digits will disappear and the entry becomes effective after the units terminator is pressed.

[AVERAGING on OFF] 5. Finally, turn the averaging on to see the effect on the displayed trace. Note the change from [AVERAGING on OFF] to [AVERAGING ON off] on the softkey label to indicate the current averaging status. Note also that the "Avg" indicator and the number of averaged traces below that appears to the left of the graticule.

General Measurement Sequence

Even with its wide range of capabilities, the HP 8753B is simple to operate. Common measurements can be set up with only a few front panel selections. This section describes a general approach to performing network analysis measurements with the HP 8753B.

The following sequence is used throughout this User's Guide to illustrate the use of the HP 8753B in its various operating modes. The individual steps are discussed in detail in the sections that follow.

Preset	Return to a known state.
Connections	Set up the measurement.
Controls	Set up the instrument in three steps: 1. Measurement 2. Format 3. Stimulus
Calibrate	Remove measurement errors.
Device Under Test	Connect the device under test (DUT).
Autoscale	Observe correctly scaled data.

Step One: [PRESET] Pressing this key at any time will return the instrument to a well-defined state, the same as if it had just been turned on. When the [PRESET] key is pressed the HP 8753B performs a self test. Following successful completion of the self test, the instrument functions are set to the following preset condition:

MAJOR DEFAULT CONDITIONS AT [PRESET]

Display

Measurement	S ₁₁ on Channel 1 S ₂₁ on Channel 2
Format:	Log Magnitude
Display mode:	Dual Channel Off
Scale:	10 dB/div
Reference:	0 dB, center of CRT

Stimulus

Frequency:	Start 300 kHz Stop 3 GHz
Sweep Type:	Linear Frequency
Number of Points	201
Power:	0 dBm
Sweep Time:	200 msec

Receiver

IF Bandwidth:	3 kHz
Averaging:	Off
Smoothing:	Off
Cal Correction	Off

Step Two: Connections

With one output and three input ports, the HP 8753B can be connected to the DUT in a variety of ways. Simple insertion loss or gain measurements (B/R) can be made with only a power splitter. Reflection measurements require a coupler or a bridge. Most applications will use a transmission/reflection or S-parameter test set for simultaneous measurements of the transmitted and reflected signals.

HP 85044A/B Transmission/Reflection Test Set

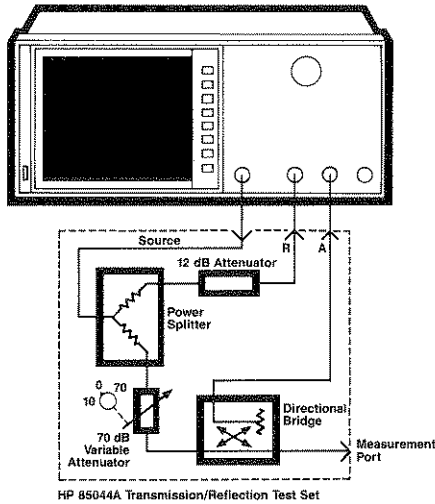

While simple transmission and reflection measurement setups can be constructed from discrete RF components such as power dividers, directional bridges, cables, attenuators, etc., it is easier to use an integrated test set such as the HP 85044A/B transmission/reflection test set.

As shown in the diagram, the HP 85044A/B test set contains the hardware required to make simultaneous transmission and reflection measurements in the forward direction. The only setup required is to connect the DUT input to the test port and the DUT output to the B input of the HP 8753B. The HP 85044A is a 50 ohm test set and the HP 85044B is a 75 ohm test set.

HP 85046A/B S-Parameter Test Set

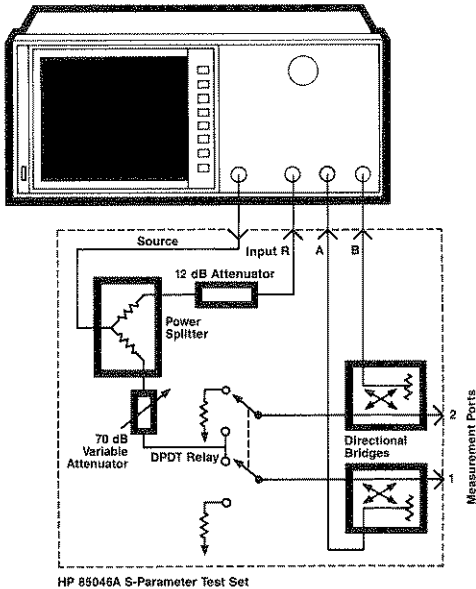

The S-parameter test set contains the hardware required to make simultaneous transmission and reflection measurements in both the forward and reverse directions. The only setup required is to connect the DUT to the two measurement ports. The network analyzer controls the switching functions, so that even reverse measurements can be made without changing device connections. The internal switch simplifies full 2-port measurement calibrations. The HP 85046A is a 50 ohm test set and the HP 85046B is a 75 ohm test set.

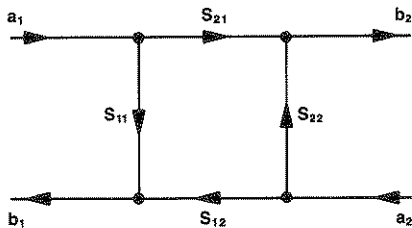

With the S-parameter test set connected the analyzer's [MEAS] menu will read in S-(scattering) parameters. Each choice selects one of the four possible combinations of analyzer input modes (A/R or B/R) and test direction (FWD or REV). For those unfamiliar with S-parameters, they correspond exactly to the more common description terms given in the diagram below, requiring only that the measurements be taken with all DUT ports properly terminated. For more information on S-parameters see HP Application Notes 95-1 and 154.

S-Parameter	Definition	Description	Test Set Direction	Analyzer Input
S_{11}	$\frac{b_1}{a_1} \Big _{a_2=0}$	Input reflection coefficient	FWD	A/R
S_{21}	$\frac{b_2}{a_1} \Big _{a_2=0}$	Forward gain	FWD	B/R
S_{12}	$\frac{b_1}{a_2} \Big _{a_1=0}$	Reverse gain	REV	A/R
S_{22}	$\frac{b_2}{a_2} \Big _{a_1=0}$	Output reflection coefficient	REV	B/R

Step Three: Controls

- 1 MEASUREMENT
- 2 FORMAT
- 3 STIMULUS

■ 1 MEASUREMENT [MEAS]

Based on the DUT connections, select the appropriate inputs. This menu appears for test sets other than the S-parameter test set (e.g. the HP 85044A/B transmission/reflection test set).

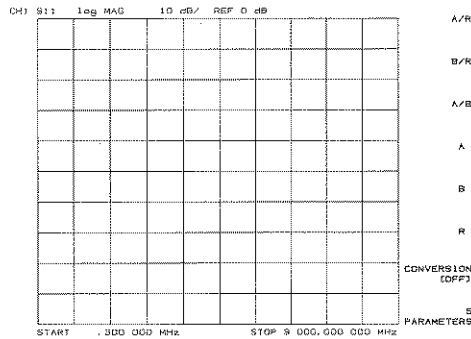

These choices calculate and display ratios of two input signals.

Use these choices for single input measurements.

Use to convert the data to impedance or admittance parameters.

Use to select S-parameters.

This menu appears when an HP 85046A/B S-parameter test set is connected. Note that the current measurement selection is underlined in the softkey label area.

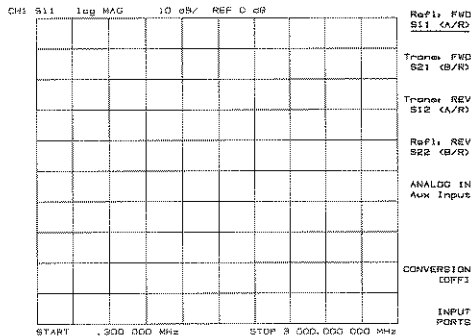

Choose for port 1 reflection measurements

Port 1 transmission measurements

Port 2 transmission measurements

Port 2 reflection measurements

Measures the signal at the AUX INPUT and displays voltage on the vertical axis.

Use to convert the data to impedance or admittance parameters.

Use to select transmission/reflection parameters (A, B, B/R, etc).

2 FORMAT [FORMAT]

Measurements can be displayed in a variety of formats.

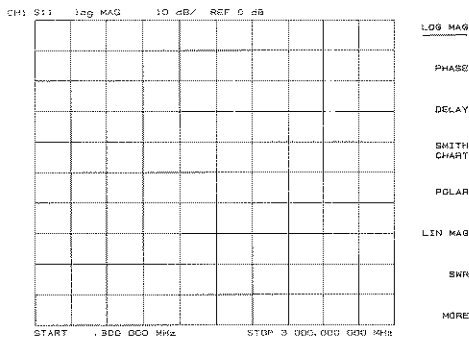

Magnitude in dB or dBm.

Phase angle in degrees.

Swept group delay in seconds.

Magnitude and phase on a Smith chart.

Magnitude and phase on a polar display.

Magnitude in linear ratio units.

Standing Wave Ratio (unitless)

3 STIMULUS

Next, specify the measurement frequency or frequencies. For a narrowband measurement such as a bandpass filter, it is usually easiest to set a center frequency and total span; for measurements over a broader frequency range it may be easier to choose individual start and stop frequencies. The stimulus [MENU] hardkey allows additional stimulus choices.

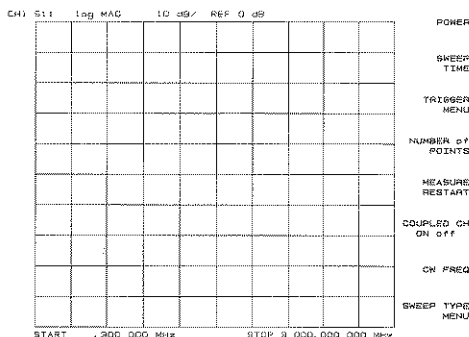

Choose the source output level.

Specify minimum sweep time.

Select the sweep trigger menu.

Specify horizontal resolution between (3 and 1601 points).

Restarts the current measurement.

Uncouples stimulus sweep ranges for channels 1 and 2.

Specify a continuous wave (CW) frequency.

Select sweep type (default is linear frequency).

Step Four: Calibrate

Accuracy in network analysis is greatly influenced by factors external to the network analyzer. Parts of the measurement setup such as interconnecting cables and test sets (as well as the instrument itself) all introduce variations in magnitude and phase that can mask the actual performance of the DUT.

The calibration step seeks to remove repeatable measurement variations in the test setup. There are three types of these "systematic errors:"

- Frequency Response
- Leakages
- Mismatches

The HP 8753B has several methods of measuring and compensating for these test system imperfections. Each method removes one or more of the systematic errors mentioned above using a specific error model (equation). Measurements of standard devices are used to solve for the error terms of the model. The accuracy of the calibrated measurements is dependent on the quality of the standards used for calibrating. Since calibration standards are very precise, great accuracy enhancement is achieved.

Three error models are discussed, starting with the simplest (frequency response) and ending with the most complete (full 2-port).

Frequency Response

- Simple
- Requires only a "thru" for transmission measurements
- Requires only a short or open for reflection measurements

A frequency response calibration removes the frequency response and insertion loss errors of the test setup. This step is also called normalization. For transmission measurements substitute a "thru" connection for the DUT to establish a 0 dB loss (or gain) and a 0° phase reference. For reflection measurements substitute either an open or a short circuit for the DUT to establish a total reflection (0 dB return loss at either 0° or 180° degree phase shift) reference. After the standard is measured, the HP 8753B underlines the appropriate softkey (either short, open or thru). Press *[DONE: RESPONSE]* to continue.

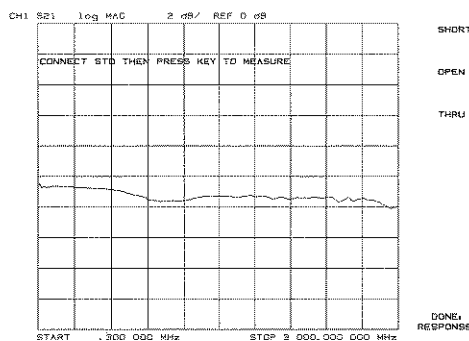
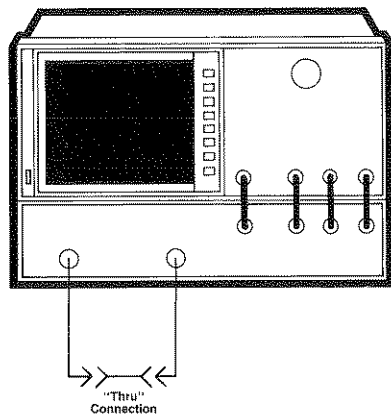

One Port Reflection Calibration

- More accurate than the frequency response calibration
- Requires three precision terminations (short, open, load)
- Good choice for reflection measurements of large reflection or high insertion loss DUTs

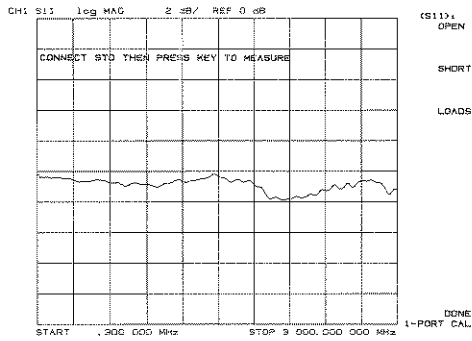

This calibration routine removes all three of the systematic error terms seen from a single input port for a reflection measurement. It does not remove the mismatch effects seen from the DUT output. These output mismatch effects are negligible if either the reflected signal is large or the DUT greatly attenuates the mismatch signals seen from the output port. For example, one port reflection calibration is a good choice when measuring amplifiers or SAW filters because they typically have large reflections or high insertion loss, respectively. *[S11 1-PORT]* and *[S22 1-PORT]* calibrate for reflection measurements in the forward and reverse directions, respectively.

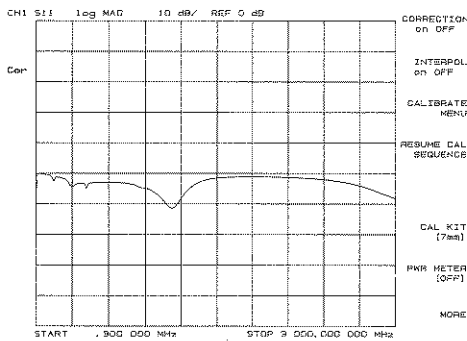

This reflection calibration is simple to perform. Upon pressing either the *[S11 1-PORT]* or *[S22 1-PORT]* softkey, the user is asked to connect a standard open, short and load (50 or 75 ohms). Each is measured in turn, and the results are stored in memory. Upon completion, the HP 8753B determines the contribution of each of the three error terms and removes their effect from the measured data. Note that correction is turned on when the calibration procedure is complete.

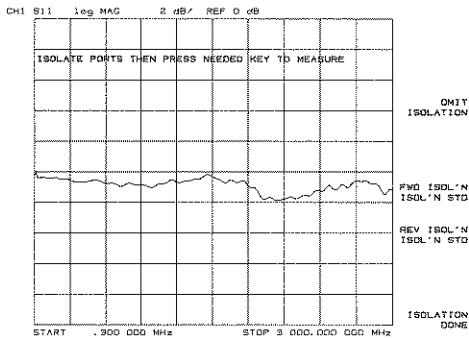
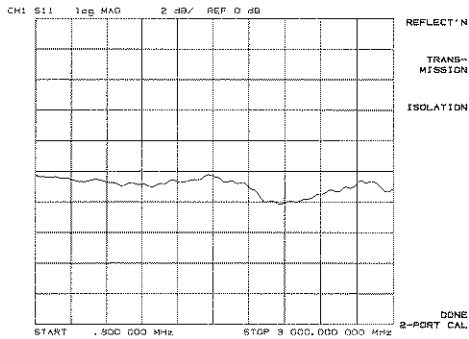
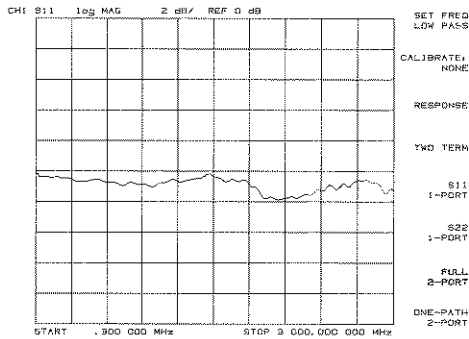

Two Port Calibration

- Most accurate calibration procedure
- Requires 7 connections, 12 measurements for Full 2-Port
- Full 2-Port requires an S-parameter test set

This is the most complete calibration. It measures the three systematic errors (frequency response, leakage and mismatch) in both the forward and reverse directions and removes their effects from the measured data. It is the most accurate calibration for both transmission and reflection measurements.

With an S-parameter test set (HP 85046A/B) the measurement results can be corrected for the systematic errors as seen from both measurement ports. Simply press the **[FULL 2-PORT]** softkey and follow the prompts to correct for transmission, reflection and isolation errors. Choose **[OMIT ISOLATION]** except when measuring devices with high dynamic range (e.g. some filters and switches). The HP 8753B has >90 dB isolation between the measurement ports without accuracy enhancement. For high dynamic range measurements, connect loads to measurement ports 1 and 2, choose an averaging factor of 10 or greater, and select **[FWD ISOL'N]** and **[REV ISOL'N]** for isolation accuracy enhancement of >100 dB.

After calibration, the HP 8753B will turn correction on and switch the source output power between ports 1 and 2 of the S-parameter test set for fully calibrated measurements of all four S-parameters.

2-Port calibrations can be made without an S-parameter test set. For example, to make a full 2-port calibration with the HP 85044A/B transmission/reflection test set, select **[ONE PATH 2-PORT]** and follow the user prompts to measure the reflection, transmission and isolation calibration standards. 2-port calibration requires measuring both the forward and reverse response of the DUT. Since the transmission/reflection test set has only one port (called the test port) the HP 8753B prompts the user to reverse the DUT after each frequency sweep to measure both the input and output response of the DUT.

Step Five: Connect the Device Under Test

After the test setup is calibrated, connect the device under test and make your measurements.

Step Six: Auto Scale

Obtaining a correctly scaled display is simple. From the [SCALE REF] menu, select [AUTOSCALE]. The HP 8753B will automatically choose an appropriate scale factor and reference level for a full screen display of the measurement results. Or use the [SCALE/DIV], [REFERENCE POSITION], and [REFERENCE VALUE] softkeys to manually scale the display.

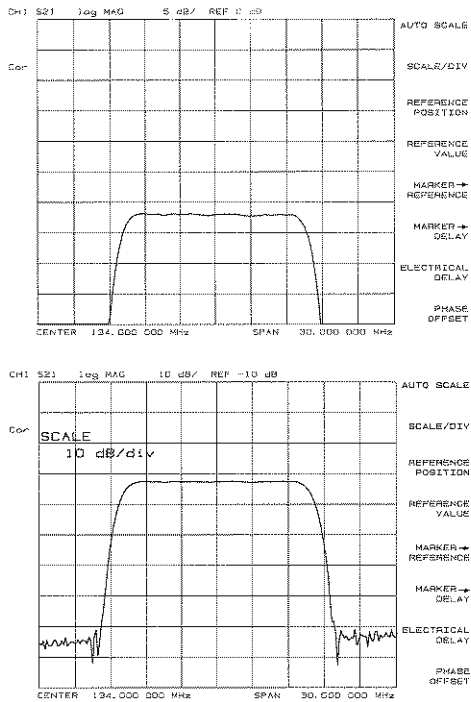

Measurement Enhancements

The HP 8753B RF network analyzer provides many features that make measurements both easier and more accurate. The internal calibration routines already discussed maximize measurement accuracy with a few additional steps per setup. This information will help you optimize the measurement dynamic range and show how to take advantage of the marker functions, hardcopy output choices, and optional time domain capability.

Optimizing Dynamic Range

Network analyzers are often called upon to simultaneously measure two signals that are widely separated in amplitude. Testing the attenuation of a filter, for example, requires measurement of both its input and output signals, which may differ by 80 dB or more. With 100 dB dynamic range, the HP 8753B can make these measurements easily. However it is important to properly select instrument parameters to achieve this measurement range.

Dynamic range is the difference between the analyzer's input overload level and its broadband noise floor. For a measurement to be valid, input signals must be within these boundaries. Optimizing dynamic range, therefore, involves

1. choosing the appropriate source output power, and
2. reducing the analyzer's noise floor.

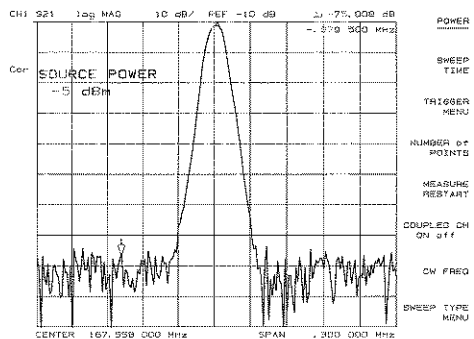

Signal Levels. The accompanying figures show how test levels determine the available measurement range. The DUT is a bandpass filter with 90 dB of rejection. In the first case, the input power to the filter is -25 dBm. The HP 8753B output power is set at -5 dBm and the test set has 20 dB of insertion loss. We cannot measure the filter output in the stop-band region because it is below the analyzer's noise floor. As a result, the device appears to have only about 75 dB of rejection.

In the second case, the input power to the filter is 0 dBm. Now the output of the filter is -90 dBm, more than enough for a satisfactory measurement.

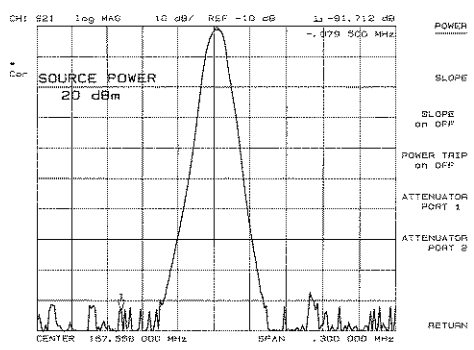

You should ensure that the DUT output power is within the measurement range of the analyzer. The HP 8753B can measure signals in the range of 0 dBm to -100 dBm. Measuring signals below -90 dBm requires consideration of ways to lower the noise floor as described next.

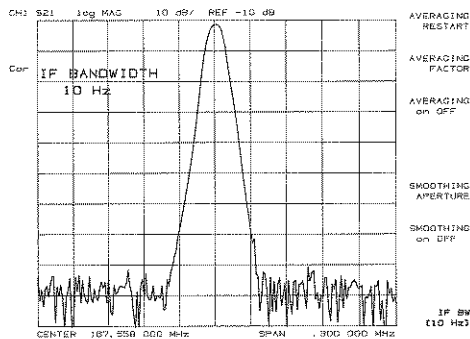
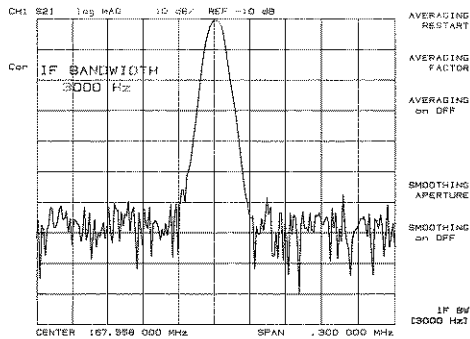

Noise Floor. Several approaches to noise reduction are possible, each with its own tradeoffs.

1. **IF Bandwidth:** as shown in the figure, each tenfold reduction in IF (receiver) bandwidth lowers the noise floor by about 10 dB. IF bandwidth is selectable from 3000 Hz to 10 Hz. With the 10 Hz bandwidth a noise floor of -100 dBm is specified. At the same time, narrower bandwidths also necessitate longer sweep times. Sweep time is automatically increased as the IF bandwidth is narrowed.

2. **Averaging:** the HP 8753B also can apply exponential averaging of successive traces to remove the effects of random noise. "Exponential" means that the trace value at each point is composed of a weighted vector sum of the current trace data and the data from the previous sweep. Current data is weighted at $1/N$, where N is the averaging factor selected from the [AVG] menu. The HP 8753B displays the current averaging factor to the left of the graticule.

3. **Smoothing:** although this function does not lower the noise floor, it can make noisy signals easier to interpret by removing trace ripple. Smoothing is often likened to video filtering, and is different from averaging. Averaging computes each data point based on the average value during several sweeps. Smoothing computes each data point based on one sweep, but on the average of a window of several data points for the current sweep. The window or smoothing aperture is a percent of the span swept, less than or equal to 20%. Use smoothing with caution; too large a smoothing aperture may distort the data.

Markers and Marker Functions

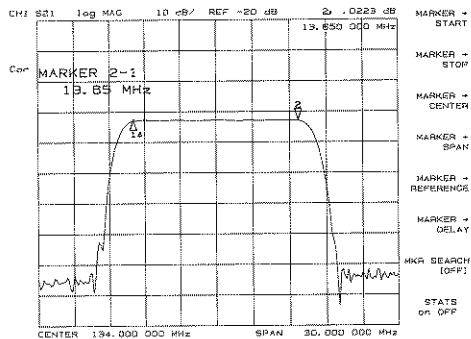
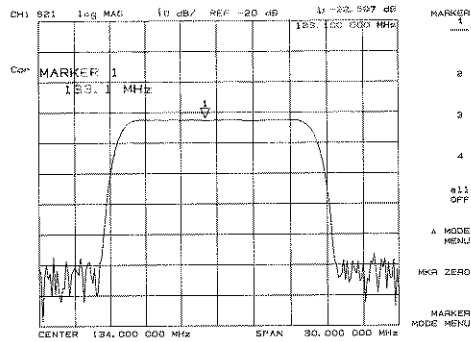

Numerical readout of the displayed data is provided by movable display markers. The marker frequency (or other horizontal axis parameter) is displayed in the active function area in the upper left hand side of the CRT. The power (or other vertical axis parameter) that corresponds to the marker position is displayed in the upper right hand side of the CRT. Many of the HP 8753B's "smart" features involve the marker functions. By using them effectively, measurement times can be reduced, resulting in increased productivity. This section introduces the basic marker capabilities. The full power of the markers is best illustrated in the transmission and reflection measurement sections.

The [MKR] hardkey allows you to select up to four independent markers, and measure absolute values along the trace or delta values relative to another marker or a fixed offset.

The [MKR FCTN] hardkey brings up a menu of marker functions that allow you to change the stimulus parameters, search the trace for specific values, or statistically analyze all or part of the trace.

Hardcopy Output

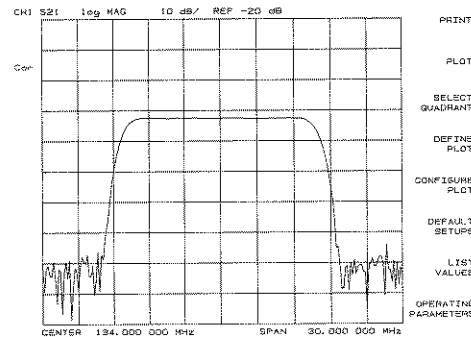

Plot the results of the measurement directly to an HP-GL plotter or printer. Select the [SYSTEM CONTROLLER] softkey from the [LOCAL] hardkey menu if you do not have a computer connected. Then press the [COPY] hardkey and select the [PLOT] or [PRINT ALL] softkey. Or customize the plot with a descriptive title, plotter pen choices, or position up to four plots per page.

Copies the display to a printer

Copies the display to an HP-GL plotter

Select position for a quarter page plot or a full page plot

Choose to plot a subset of the display

Select pen numbers for a multi-colored plot and solid or dashed traces

Resets the plot definition and configuration to the defaults

List the values of the active trace to a printer

List the key operating parameters

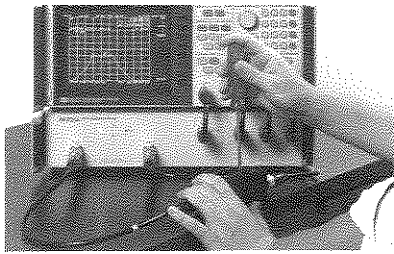

Transmission Measurements with the HP 8753B

The next two chapters of this User's Guide demonstrate the many kinds of network measurements that can be made with the HP 8753B. For each example a complete measurement setup is given, following the same "generalized measurement sequence" described in Chapter 1.

The examples used represent typical network measurements. The DUT used in the examples is a bandpass SAW filter with a 134 MHz center frequency. Modify the instrument setups shown to suit your particular needs. For further information on any of the measurements shown, refer to the HP 8753B Operating and Programming Manual for the most complete description of allowable operating modes, parameters, etc.

Basic Setup

Many of the examples described in this chapter use the HP 85046A/B S-parameter test set to connect to the device under test. This approach simplifies the measurement setup, and provides fully specified results over the HP 8753B's frequency range. Fully specified measurements can also be made using the HP 85044A/B transmission/reflection test set. Or you can create your own test setup with discrete power splitters, couplers, attenuators, etc. If you use your own setup, note that the HP 8753B requires a signal level at the R input in the range of 0 to -35 dBm to phase lock the internal source.

Measuring Insertion Loss and Gain

Insertion loss and gain are ratios of the output to input signals. When set up as shown below, the results can be read directly in decibels.

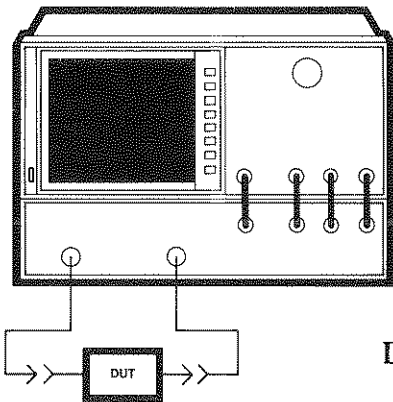

Device Under Test
Autoscale

Preset

Connections

Connect the HP 85046A/B S-parameter test set to the network analyzer as shown in the figure.

Controls

1. Measurement S21 (or B/R) on CH 2
2. Format LOG MAG
3. Stimulus CENTER 134 MHz
SPAN 30 MHz

Calibrate

Do a frequency response calibration. Press the [CAL] hardkey, select [CALIBRATE MENU] then the [RESPONSE] softkey. Connect a "thru" between measurement ports and press [THRU] to measure. Press [DONE: RESPONSE] to complete the calibration.

Remove the "thru" and connect the DUT.

Autoscale

Select [SCALE REF] and press [AUTOSCALE].

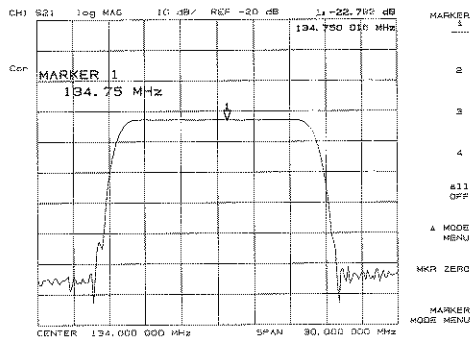

The figure shows the complete response of the bandpass filter under test. From this display you can derive several important filter parameters. The power of the marker functions greatly simplifies this task.

Insertion Loss

Insertion loss can be read to 0.001 dB resolution by moving the marker to any frequency of interest. The marker amplitude and frequency are read in the upper right hand corner of the display.

3 dB Bandwidth

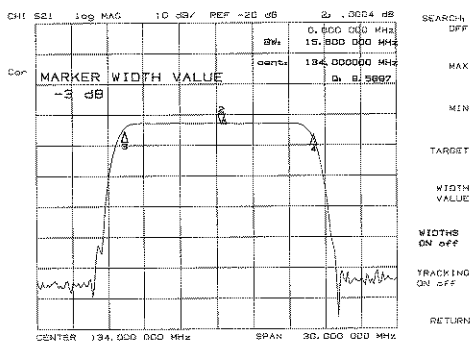

The HP 8753B calculates the bandwidth of the DUT between two equal power levels. In this example, we calculate the -3 dB bandwidth relative to the filter center frequency.

1. Press [MKR] and use the rotary knob to move the marker to the center of the filter passband. Press [MKR ZERO] to zero the delta magnitude and frequency. The softkey label changes to [MKR ZERO Δ REF = Δ] to remind you that the delta reference point is the small Δ symbol.
2. Press [MKR FCTN] and select [MKR SEARCH] to enter the marker search mode. Select [WIDTHS ON off]. The HP 8753B calculates the -3 dB bandwidth, the center frequency and the Q (Quality Factor) of the DUT and lists the results in the upper right hand corner of the display. Markers 3 and 4 on the trace show the location of the -3 dB points. To have the HP 8753B calculate the bandwidth between other power levels, select [WIDTH VALUE] and enter the number (e.g. [-] [6] [x1] for -6 dB). Select [WIDTHS on Off] and [RETURN] when you are finished with this measurement.

Out-of-Band Rejection

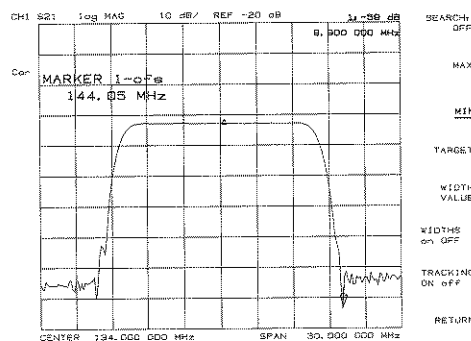

The wide dynamic range of the HP 8753B allows it to measure stopband rejection up to 110 dB below the passband response. As discussed in Chapter 1, maximum dynamic range requires proper selection of input power level, IF bandwidth and averaging.

Select [MKR SEARCH] to enter the marker search mode. Select [SEARCH: MIN]. The marker automatically seeks the minimum point on the trace. The frequency and amplitude of this point, relative to the delta symbol in the center of the filter passband, appear in the upper right hand corner of the display.

Note that the marker search mode can be used to search the trace for the maximum point or for any target value. The target value can be an absolute level (e.g. -3 dBm) or a level relative to the small delta symbol (e.g. -3 dB from the center of the passband).

Select [SEARCH: OFF] and [RETURN] when you are finished with this measurement.

Ripple or Flatness

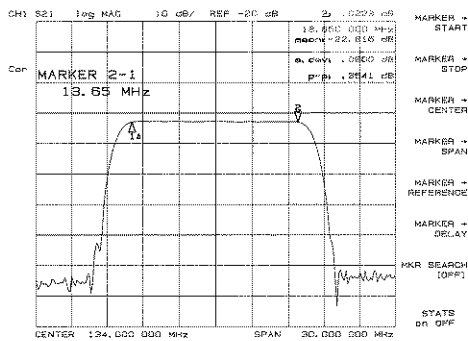

The power of marker statistics is illustrated in this measurement of passband ripple. Passband ripple (or flatness) is the variation in insertion loss over a specified portion of the passband.

1. Press [MKR] and use the rotary knob to move marker 1 to the left edge of the passband. Select [Δ MODE MENU] and [Δ REF = 1] to move the delta reference point to marker 1's position along the trace.

2. Select [MARKER 2] and turn the rotary knob to move marker 2 to the right edge of the passband.

3. Press [MKR FCTN] and select [STATS ON off]. The HP 8753B calculates the mean, standard deviation and peak-to-peak variation between the markers and lists the results in the upper right hand corner of the display. The passband ripple is automatically given as the peak-to-peak variation between the markers.

Select [STATS on OFF] when you are finished with this measurement.

Using Limit Lines

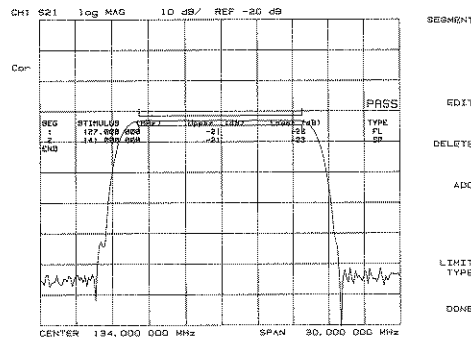
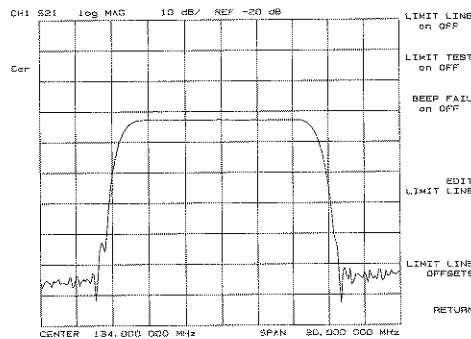
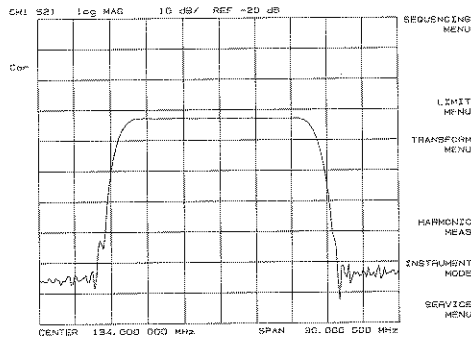

Determine pass or fail status by comparing the device performance to limit lines on the display. In the example to the left a flat limit line lets you quickly make GO/NO GO testing decisions regarding the filter's passband ripple by comparing the measurement trace to the limit lines on the display.

To enter the limit line mode, press [SYSTEM] and select [LIMIT MENU]. To add a new limit segment select [EDIT LIMIT LINE], followed by [ADD].

In this example, we enter a [STIMULUS VALUE] of 127 MHz (at the start of the filter passband), an [UPPER LIMIT] of -21 dB and a [LOWER LIMIT] of -23 dB. The SAW filter under test has about 22 dB insertion loss in the passband. Terminate this segment by selecting [DONE]. Since this is a flat limit segment select [LIMIT TYPE] and [FLAT LINE] (the default type). Select [PRIOR MENU] to return to the limit line edit menu.

Segment 1 specified the start frequency of the flat limit line. Select [ADD] to enter a second limit segment that terminates this flat line. Enter a [STIMULUS VALUE] of 141 MHz (the end of the filter passband). The upper and lower limits are copied from Segment 1. Select [DONE] to terminate this segment. Since this terminates the limit line select [LIMIT TYPE], then [SINGLE POINT], and [PRIOR MENU] to return to the limit line edit menu.

You are now ready to do limit testing. Select [DONE] to return to the limit menu. The HP 8753B draws the limit lines on the display when you select [LIMIT LINE ON]. Select [LIMIT TEST ON] to activate the limit test. The HP 8753B tells you whether the DUT passes or fails the limit test with a message along the right hand edge of the graticule.

Select [LIMIT TEST OFF] and [LIMIT LINE OFF] when you are finished with this measurement.

Measuring Phase Response

A two input ratio measurement can also provide information about the phase shift or insertion phase of a network. The HP 8753B can translate this information into a related parameter, group delay.

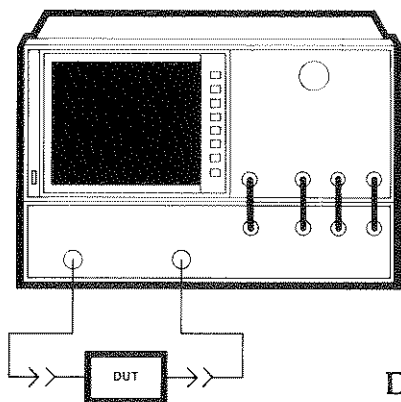

Preset Connections Controls

Use the test setup shown for the previous measurements.

1. Measurement S21 (or B/R) on CH 1
2. Format PHASE
3. Stimulus CENTER 134 MHz
SPAN 30 MHz

Calibrate

Place a "thru" connection between the measurement ports and calibrate as described in the previous setup. Remember that a single normalization is valid for both amplitude and phase measurements, provided that the frequency span is unchanged.

Device Under Test Autoscale

Remove the "thru" and connect the DUT.

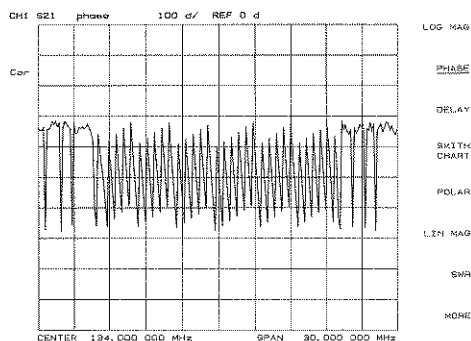

Just as in measuring insertion loss or gain, the various marker functions (marker search, min/max, offset, etc) can be used to examine the details of the phase response.

The figure shows the phase response of the bandpass filter. Notice the linear phase shift through the passband, and the rapid fluctuations outside this region. The random phase of the broadband noise floor causes the spurious out-of-band response.

The HP 8753B measures and displays phase over the range -180 to $+180$ degrees. As phase increases beyond these values, a sharp 360 degree transition occurs in the display as the trace "wraps" between $+180$ and -180 degrees. This causes the characteristic "sawtooth" display usually seen on devices with linearly increasing (or decreasing) phase responses.

Using the Dual Trace Display

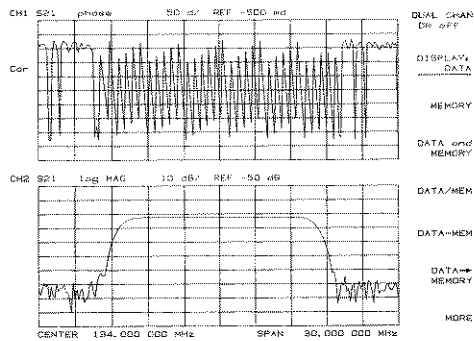

In some cases it is useful to be able to view more than one measured parameter at a time. Simultaneous gain and phase measurements are useful, for example, for evaluating stability in negative feedback amplifiers. Such measurements are easily made using the HP 8753B's dual trace display.

Upon power-on or preset, channel 1 is active and channel 2 is off. To see both channels simultaneously, press [DISPLAY] and select [DUAL CHAN ON]. Two displays appear on the CRT, with channel 1 on the upper and channel 2 on the lower display. The figure left shows a typical dual trace display.

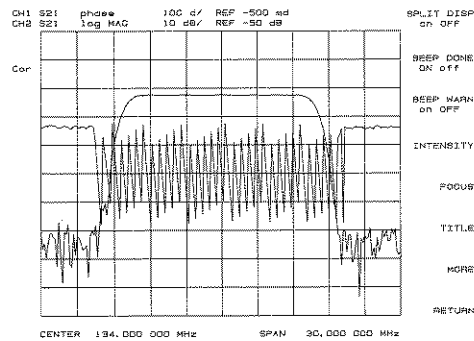

Sometimes it is more convenient to view both channels on a single graticule. From the [DISPLAY] menu, select [MORE] and [SPLIT DISP OFF]. The figure left shows the result.

Select [SPLIT DISP OFF], [RETURN] and [DUAL CHAN OFF] when you are finished with this measurement.

Measuring Electrical Length

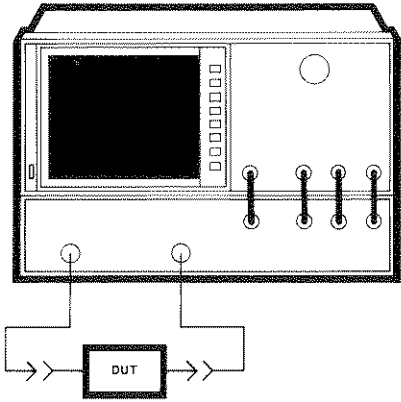

Preset Connections Controls

The HP 8753B electronically implements a function similar to the mechanical "line stretchers" of earlier analyzers. This feature simulates a variable length lossless transmission line, which can be added to or removed from a receiver's input to compensate for interconnecting cables, etc. In this example, the electronic line stretcher is used to measure the electrical length of a test device.

Use the test setup used for the previous measurement.

1. Measurement S21 (or B/R) on CH 2
2. Format PHASE
3. Stimulus CENTER 134 MHz
SPAN 30 MHz

Calibrate

Place a "thru" connection between the measurement ports and calibrate as described in the first setup in this chapter.

Device Under Test Autoscale

Remove the "thru" and connect the DUT.

Electrical Length Adjustment

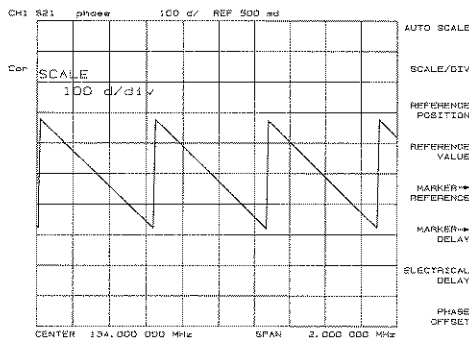

The above setup results in the phase response measurement shown. Note that the SAW filter under test has considerable phase shift within only a 2 MHz span. Other filters may require a larger frequency span to see the effects of phase shift.

The linearly increasing phase is due to the DUT's electrical length, which will be measured by electronically adding length to the R input to compensate for it.

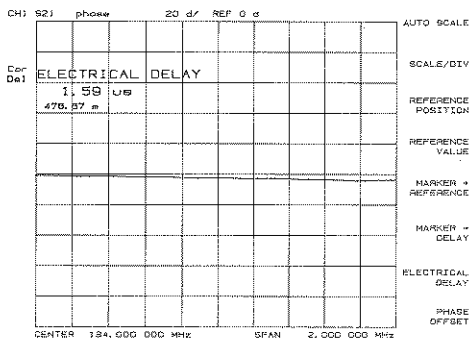

1. Activate the line stretch function by pressing [SCALE REF] and selecting [ELECTRICAL DELAY].

2A. Next, use the rotary knob to adjust the amount of length added to input R until the display is flat as shown.
OR

2B. Press [MKR] and use the rotary knob to position marker 1 near the center of the screen. Press [SCALE REF] and select [MARKER → DELAY]. The HP 8753B adds electrical length equal to the group delay (discussed next) at the marker frequency for a flat phase response just as in 2A above. To display the electrical length select [ELECTRICAL LENGTH].

In this example we must add a large amount of electrical delay due to the long electrical length of the SAW filter under test. Note that the electrical delay is approximately the same as the main path travel time in the time domain example at the end of Chapter 1.

Measuring Phase Distortion

For many networks, the amount of insertion phase is not nearly as important as the linearity of the phase shift over a range of frequencies. The HP 8753B can measure this linearity and express it in two different ways: directly, as deviation from linear phase, or as group delay, a derived value.

Deviation from Linear Phase

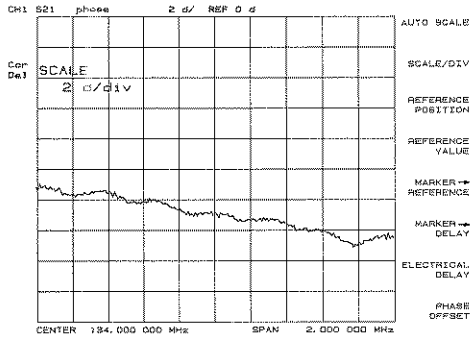

This can be measured using the previous setup for measuring electrical length. By adding electrical length to “flatten out” the phase response we have removed the linear phase shift through the DUT. What remains is the deviation from linear phase shift through the device. Simply increase the scale resolution to directly measure the deviation from linear phase.

Group Delay

The phase linearity of many devices is specified in terms of group or envelope delay. This is especially true of telecommunications components and systems.

Group delay is the transmission time through the DUT as a function of frequency. Mathematically, it is the derivative of the phase response which can be approximated by the ratio $\frac{\Delta\phi}{\Delta F}$

$$\frac{\Delta\phi}{\Delta F}$$

where $\Delta\phi$ is the difference in phase at two frequencies separated by ΔF . The quantity ΔF is commonly called the “aperture” of the measurement. The HP 8753B calculates group delay from its phase response measurements.

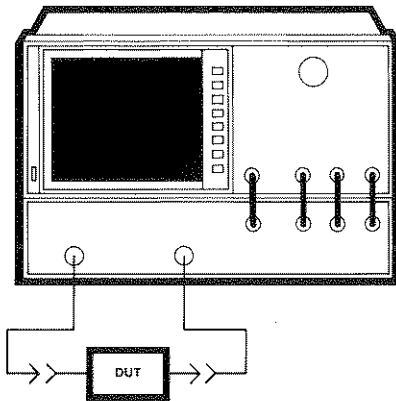

Preset

Connections

Use the setup shown for the previous measurement.

Controls

1. Measurement S21 (or B/R) on CH 2
2. Format DELAY
3. Stimulus CENTER 134 MHz
SPAN 2 MHz

Calibrate

Place a “thru” connection between the measurement ports and calibrate as described in the first setup in this chapter.

Device Under Test

Remove the “thru” and connect the DUT.

Autoscale

The default aperture is the frequency span divided by the number of points across the display (i.e. 201 points or 0.5% of the total span in this example). Other aperture values can be selected by turning on [SMOOTHING] and varying the [SMOOTHING APERTURE] in the [AVG] menu.

Notice the effect of aperture on a group delay measurement. As the aperture is increased from 0.5% to 2% and higher, the "smoothness" of the trace improves markedly, at the expense of measurement detail.

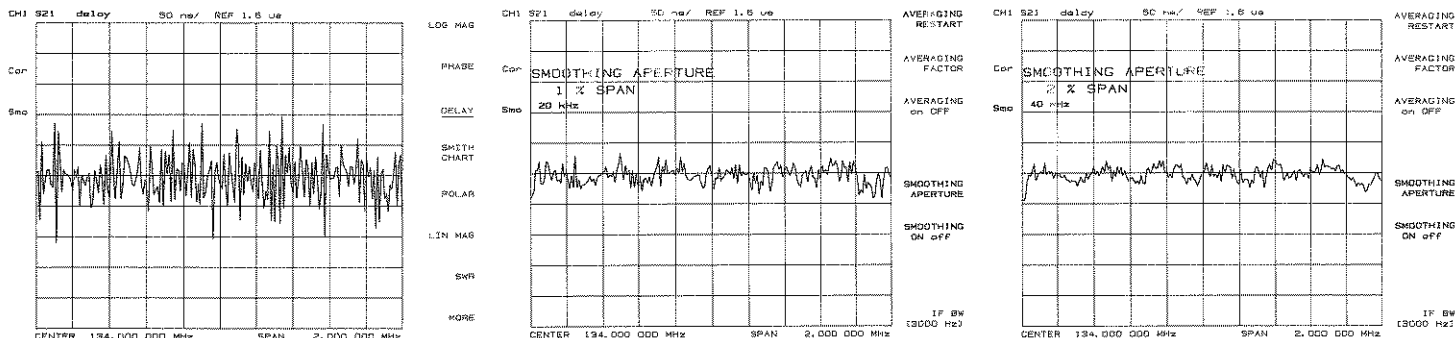

Measuring Gain Compression

Measurements to this point have all been made with a constant input amplitude and swept test frequency. At times, however, it may be desirable to characterize a device at a single frequency as a function of input amplitude. By using the power sweep mode, measurements such as gain compression or AGC (automatic gain control) slope can be made.

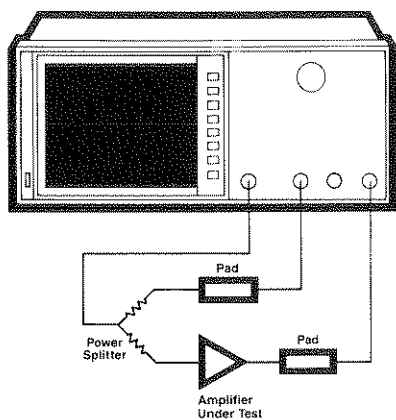

Preset Connections

Controls

Use the setup shown; the HP 85046A test set is not used because its relatively high insertion loss limits the input signal available to drive the test device into compression.

1. Measurement S21 (or B/R) on CH 2
2. Format LOG MAG
3. Stimulus Press MENU
CW FREQ 100 MHz
(select POWER SWEEP)
START POWER -5 dBm
STOP POWER +5 dBm

Calibrate

Substitute a "thru" in place of the amplifier-under-test and calibrate as described in the first setup in this chapter.

Device Under Test Autoscale

Remove the "thru" and connect the DUT.

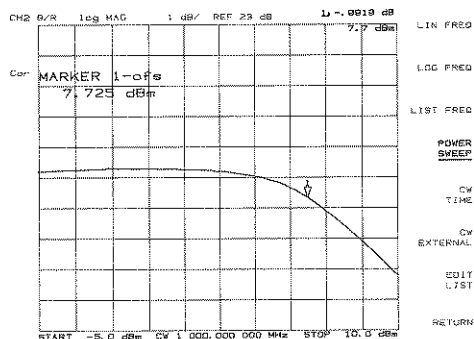

The figure shows the gain rolling off as the input power increases to a level where the amplifier under test exhibits gain compression. While the +20 dBm maximum output from the HP 8753B will be sufficient for many compression tests, it is also possible to add an external amplifier in series with the source to provide additional drive. Remember to limit the input power to the HP 8753B to 0 dBm maximum, adding external attenuators if necessary.

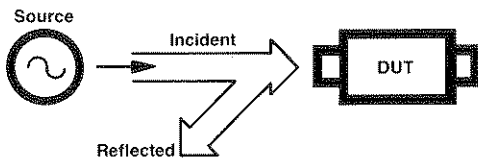

Reflection Measurements with the HP 8753B

The transmission measurements discussed in Chapter 2 are only part of the network measurements picture. Measuring the return loss or reflection coefficient completes the device characterization, and provides the basis for calculating parameters such as impedance and SWR. This chapter demonstrates how to set up, make and interpret reflection measurements with the HP 8753B.

Basic Setup

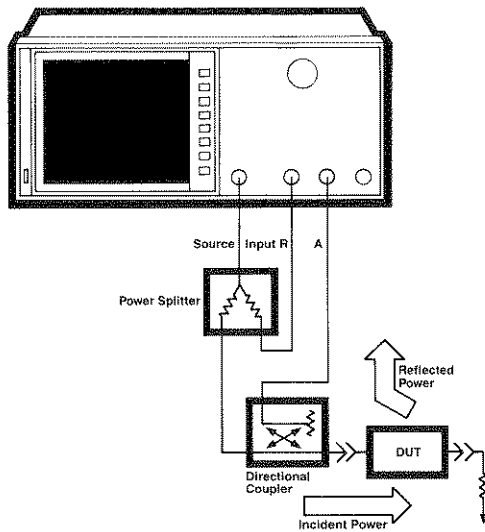

Reflection measurements require a directional device, such as a directional coupler, in the measurement setup. This signal separator provides a sample of the power traveling in one direction only. For reflection measurements it is connected as shown in the figure, allowing the power reflected from the DUT to be separated and measured independently of the incident power. The ratio of these two signals is the reflection coefficient of the DUT or, when expressed in decibels, the return loss.

Many types of directional couplers and bridges are available to perform this function. They are differentiated by frequency range, directivity and connector type. The most convenient approach is to use the HP 85046A/B S-parameter or 85044A/B transmission/reflection test sets as mentioned in Chapter 1. These test sets provide the necessary hardware and interconnect functions for reflection measurements from 300 kHz to 3 GHz. The examples in this chapter use the S-parameter test set.

Multi-Port Test Devices

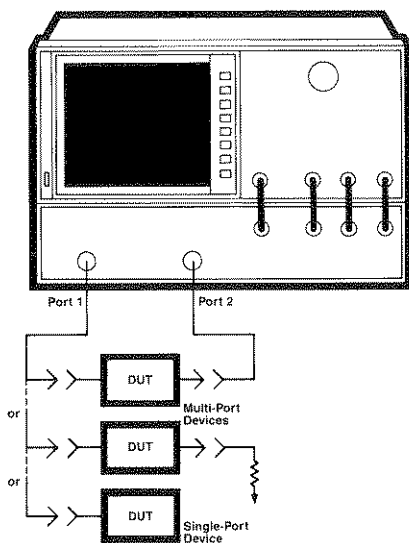

Reflection measurements involve only one port of a test device. When the device has more than one port, care must be taken to insure that the unused port(s) are properly terminated in their characteristic impedance (e.g. 50 or 75 ohms). If this is not done, reflections off the unused ports will cause measurement errors.

Connect high quality terminations (loads) to all unused ports. With the HP 85046A/B S-parameter test set, measurement port 2 supplies this termination during measurements of S_{11} and S_{21} , while port 1 supplies the load for measurements of S_{12} and S_{22} . All switching is automatic, controlled by the HP 8753B. When using the HP 85044A/B transmission/reflection test set, terminate the unused port at the B input of the HP 8753B or with a high quality load.

Measurement Accuracy

In reflection measurements, the accuracy of the final result is highly dependent on the signal separation device, adapters, and the DUT terminations. Systematic errors such as the frequency response of the test setup, leakage signals, and mismatches degrade overall measurement accuracy. The HP 8753B's built-in calibration routines can remove these measurement errors. The most accurate calibration (full 2-port) is used in the first setup in this chapter. Subsequent setups use the simpler 1-port calibration.

Measuring Return Loss, Reflection Reflection Coefficient

The signal reflected from the device under test is most often measured as a ratio with the incident signal and can be expressed as reflection coefficient and/or return loss. These measurements are mathematically defined as:

$$\begin{aligned} \text{reflection coefficient} &= \frac{\text{reflected power}}{\text{incident power}} = \rho \text{ (magnitude only)} \\ &= \Gamma = S_{11} \text{ or } S_{22} \\ &\text{(magnitude and phase)} \end{aligned}$$

$$\text{return loss (dB)} = -20 \log(\rho)$$

$$\text{SWR} = \frac{1 + \rho}{1 - \rho}$$

Preset

Connections Connect the HP 85046A/B S-parameter test set to the network analyzer as shown in the figure.

- Controls**
1. Measurement S11 or A/R on CH 1
 2. Format LOG MAG
 3. Stimulus CENTER 134 MHz
SPAN 30 MHz

Calibrate For maximum accuracy do a full 2-port calibration. Press [CAL], select [CALIBRATE MENU], [FULL 2-PORT], [REFLECT'N] and follow the prompts to connect and measure an open, short and load for port 1 (S_{11}) and port 2 (S_{22}). Connect the standards at ports 1 and 2 using any adapters or cables that will be used in the actual measurement. Select [REFLECT'N DONE] after measuring these six standards. Next select [TRANSMISSION], connect a "thru" and select the four transmission measurements one at a time. Select [TRANS. DONE] when done. Finally, select [ISOLATION], [OMIT ISOLATION] and [ISOLATION DONE]. Isolation accuracy enhancement, as described in Chapter 1, is not required for this measurement.

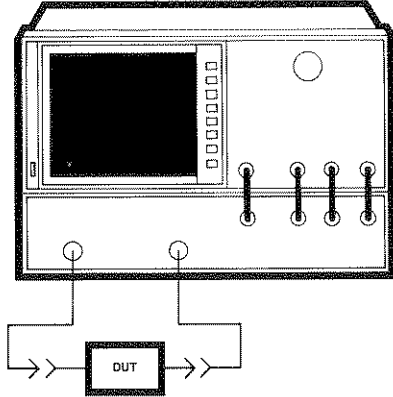

Device Under Test Connect the DUT as shown in the figure.

Autoscale

Return Loss

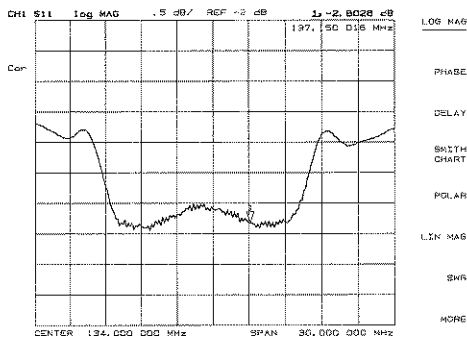

The results of a typical reflection measurement are shown. This device does not have very good match inside the filter passband, although it does illustrate that within the filter passband, the device matches the system impedance more closely than outside the passband. Therefore, the reflected signal in the filter passband is smaller than outside the passband. In terms of return loss, the value inside the passband is larger than outside the passband. A large value for return loss corresponds to a small reflected signal just as a large value for insertion loss corresponds to a small transmitted signal.

Reflection Coefficient

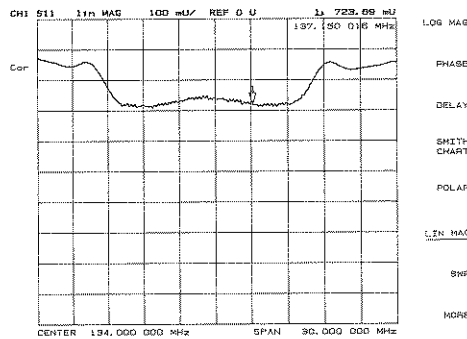

To display the same data in terms of reflection coefficient, press [FORMAT] and select [LIN MAG]. This simply redisplay the existing measurement in a linear magnitude format that varies from $\Gamma = 1.00$ at the top of the display (100% reflection) to 0.00 at the bottom of the display (perfect match).

Standing Wave Ratio

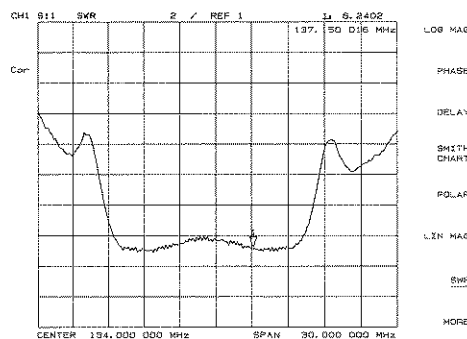

To display the reflection measurement data in terms of standing wave ratio (SWR), press [FORMAT] and select [SWR]. The HP 8753B reformats the display in the unitless measure of SWR with SWR = 1 (perfect match) at the bottom of the display.

Save/Recall Registers

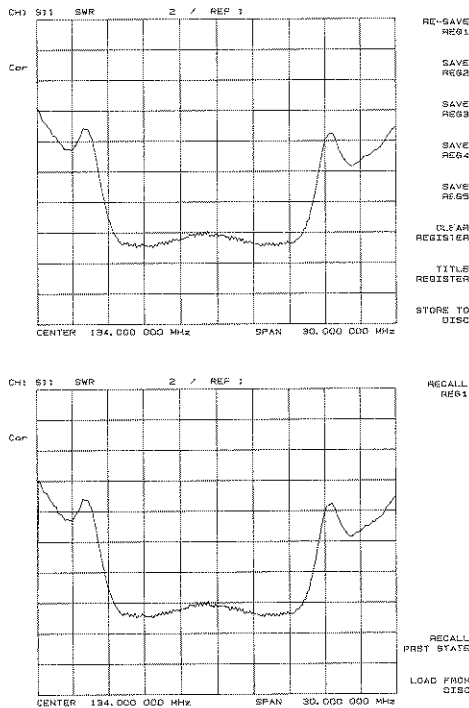

After completing the full 2-port calibration you may want to save the results for future measurements. The HP 8753B has five memory registers that you can use to store up to five instrument states. Because instrument states can be of varying complexities, it is possible to fill the available memory with less than five states. For further save/recall memory, connect a compatible disc drive (e.g. HP 9122D/S), and save the instrument state on disc.

To save the instrument state in the HP 8753B internal memory simply press [SAVE] and select one of the five registers (e.g. select [SAVE REG 1] to save the instrument state in register 1). After you save the instrument state, the soft-key label changes from [SAVE REG *n*] to [RE-SAVE REG *n*]. The HP 8753B saves all the selections you made to set up your desired measurement, such as start and stop frequency, measurement, format, calibration, scaling and limit lines. To recall the instrument state at some later time, press [RECALL] and select the desired register.

The complete instrument state, except calibration data and limit lines, remain saved if power is turned off, for at least three days. The HP 8753B saves the complete instrument state, including the calibration data and limit lines, indefinitely with power on.

Measuring S-Parameters S_{11} and S_{22} in a Polar Format

These parameters are really no different from the measurements made in the previous section. S_{11} is the complex reflection coefficient of the DUT input, while S_{22} is the complex reflection coefficient of the DUT output. In both cases, all unused ports must be properly terminated.

The HP 85046A/B S-parameter test set automatically switches the measurement configuration to agree with the S-parameter selected from the HP 8753B [MEAS] menu. With the HP 85044A/B transmission/reflection test set, or with a test setup constructed from discrete couplers, pads and power splitters, it is necessary to reverse the connections to the DUT between measurements of S_{11} and S_{22} .

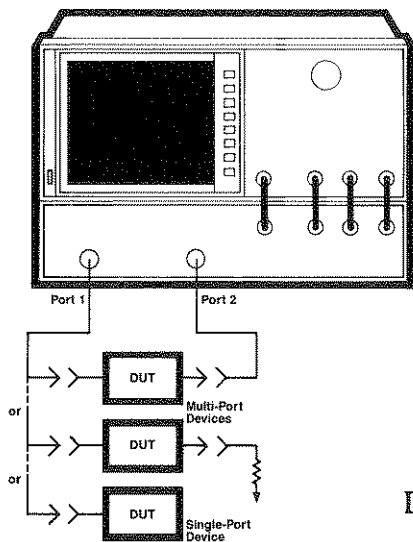

Preset

Connections

Connect the HP 85046A/B S-parameter test set to the network analyzer as shown in the figure.

Controls

1. Measurement S11 or A/R on CH 1
2. Format POLAR
3. Stimulus CENTER 134 MHz
SPAN 30 MHz

Calibrate

A one port calibration is appropriate for this measurement. This cal does not remove mismatch effects from the DUT output, but since this device has more than 20 dB insertion loss, output mismatch is attenuated enough to have very little effect on measurement accuracy. Press [CAL] and select [CALIBRATE MENU] followed by [S11 1-PORT]. Connect and measure an open, a short and a load to port 1 as prompted by the HP 8753B.

Device Under Test Autoscale

Connect the DUT as shown in the figure.

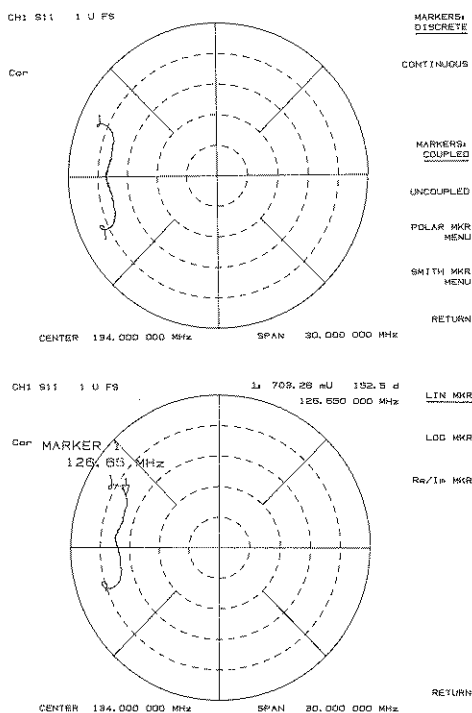

The results of a typical S_{11} measurement are shown, with each point on the polar trace corresponding to a particular value of both magnitude and phase. The center of the circle represents a coefficient Γ of 0, that is, a perfect match or no reflected signal. The outermost circumference of the scale represents $\Gamma = 1.00$, or 100 per cent reflection. The phase angle is read directly from this display. The 3 o'clock position corresponds to zero phase angle, that is, the reflected signal is at the same phase as the incident signal. Phase differences of 90, 180 and 270 degrees correspond to the 12 o'clock, 9 o'clock and 6 o'clock positions on the polar display, respectively.

The magnitude and phase of S_{11} or S_{22} are most easily and accurately read using the markers. Use the knob to position the marker at any desired point on the trace, then read the frequency, magnitude and phase in the upper right hand corner of the display. Or enter the frequency of interest from the data entry keypad to read the magnitude and phase at that point. To read the marker data in either logarithmic or real/imaginary formats, press [MKR] and select [MARKER MODE MENU], [POLAR MKR MENU].

Measuring Impedance

The amount of power reflected from a device is directly related to the impedances of both the device and the measuring system. In fact, each value of the reflection coefficient (Γ) uniquely defines a device impedance; $\Gamma = 0$ only occurs when the device and test set impedance are exactly the same. A short circuit has a reflection coefficient of $\Gamma = 1 \angle 180^\circ$. Every other value for Γ also corresponds uniquely to a complex device impedance, according to the equation

$$Z_n = \frac{1 + \Gamma}{1 - \Gamma}$$

where Z_n is the DUT impedance normalized to (i.e. divided by) the measuring system's characteristic impedance (50 or 75 ohms). The HP 8753B has a default impedance of 50 ohms. To set the impedance to 75 ohms, press [CAL] and select [MORE], [SET Z0]. The HP 8753B uses the formula above to convert the reflection coefficient measurement data to impedance data.

A Smith chart overlay on the polar display axes lets you read the impedance data in the $R \pm jX$ format, where R is the resistive component and X is the reactive component of the complex impedance of the DUT. This overlay is generated electronically within the HP 8753B, and is selected from the [FORMAT] menu.

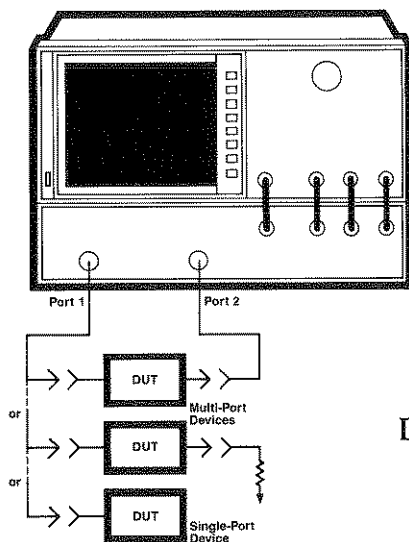

Preset Connections

Connect the HP 85046A/B S-parameter test set to the network analyzer as shown in the figure.

Controls

- | | |
|----------------|-------------------------------|
| 1. Measurement | S11 or A/R on CH 1 |
| 2. Format | SMITH CHART |
| 3. Stimulus | CENTER 134 MHz
SPAN 30 MHz |

Calibrate

Perform an S_{11} 1-port calibration as described in the previous setup.

Device Under Test

Connect the DUT as shown in the figure.

Autoscale

Use of the Smith chart graticule is most easily understood with a full scale value of 1.00. From the [SCALE REF] menu, select [SCALE/DIV], [1], [x1].

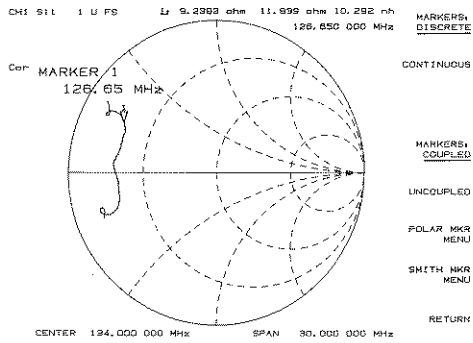

The display shows the complex impedance of the DUT over the frequency range selected. Press [MKR] and use the knob to read the resistive and reactive components of the complex impedance at any point along the trace. Note that the marker annotation tells that the complex impedance is capacitive in the bottom half of the Smith chart display and is inductive in the top half of the display.

Admittance Measurements

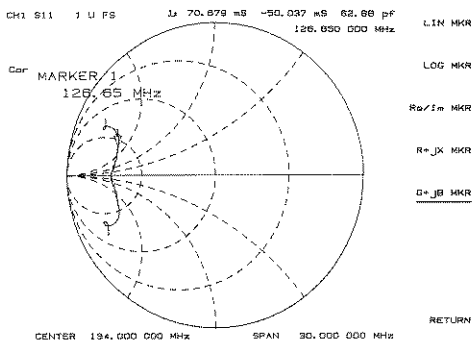

Use the marker to read admittance parameters. From the [MKR] menu, select [MARKER MODE MENU] and [SMITH MKR MENU]. Note that the default selection (currently underlined) is [R+jX MKR] for impedance marker readout. Select [G+jB MKR] for an inverse Smith chart overlay. The marker reads the admittance data in the form $G \pm jB$, where G is conductance and B is susceptance, both measured in units of Siemens (equivalent to mhos).

Time Domain Analysis with the HP 8753B

(Option 010)

Transmission Response

The HP 8753B with optional time domain analysis (Option 010) can display the time domain response of the DUT. Time domain analysis is useful for isolating a problem in the DUT in time or in distance. Time and distance are related by the velocity factor of the DUT. The HP 8753B measures the frequency response of the DUT and uses an inverse Fourier transform to convert the data to the time domain. As examples, use time domain analysis to locate points of reflection (e.g. at connectors and bends) along a transmission line or to separate the individual transmission paths (e.g. main path, leakage and triple travel) through a surface acoustic wave (SAW) filter. This section introduces the time domain concept with a SAW filter example. Chapter 3 (reflection measurements) gives the step-by-step procedure for measuring the time domain response of a cable.

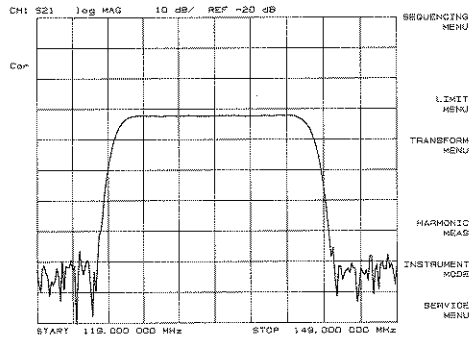

↓ \mathcal{F}^{-1}

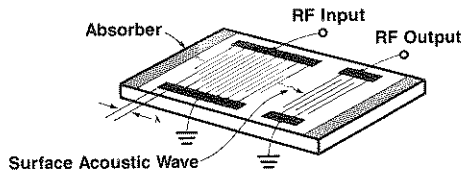
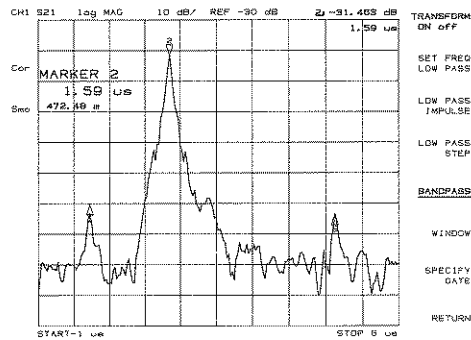

In the example on the previous page, the transmission response of a SAW filter is measured. The inverse Fourier transform of that transmission measurement is also shown. Note the three components of the transmission response: RF leakage at near zero time, the main travel path through the device (1.6 μs travel time) and the "triple travel" path (4.8 μs travel time). Each of these signal paths is illustrated in the diagram to the left.

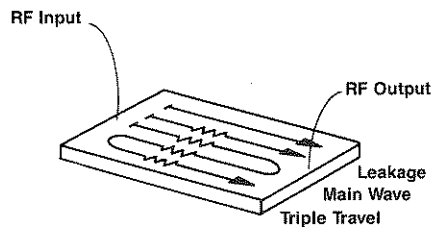

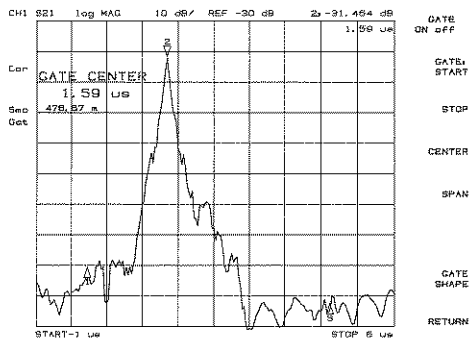

GATE
ON OFF
GATE
START
STOP
CENTER
SPAN
GATE
SHAPE
RETURN

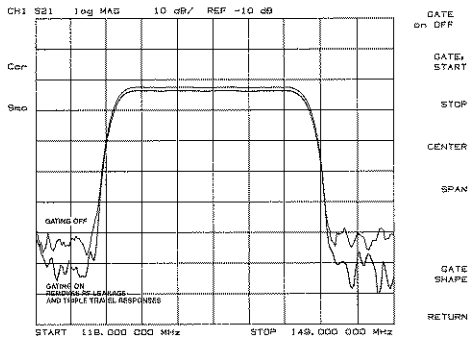

GATE
ON OFF
GATE
START
STOP
CENTER
SPAN
GATE
SHAPE
RETURN

Time domain analysis also lets you mathematically remove individual parts of the time domain response to see the effect of potential design changes. We do this by "gating" out the undesirable responses. In the example shown to the left we see the effect of removing the RF leakage and the triple travel signal path using gating. By transforming back to the frequency domain we see that this design change would yield better out-of-band rejection for the SAW filter under test.

To transform the data from the frequency domain to the time domain, press the [SYSTEM] hardkey and the [TRANSFORM MENU] softkey. Select [BANDPASS] mode to transform the trace on the CRT from the frequency domain to the time domain. The other time domain modes, low pass step and low pass impulse, are described in the HP 8753B Operating and Programming Manual.

Reflection Response

The HP 8753B with optional time domain analysis (option 010) can display the time domain response of the reflection measurement data. The time domain response of a reflection measurement is often compared with the familiar time domain reflectometry (TDR) measurements. Like the TDR measurement, it measures the size of the reflections versus time (or distance). Unlike the TDR, the HP 8753B time domain capability allows you to choose the frequency range over which you would like to make the measurement. With its "gating" capability, the HP 8753B time domain lets you perform "what if" analysis by mathematically removing selected reflections and seeing the effect back in the frequency domain.

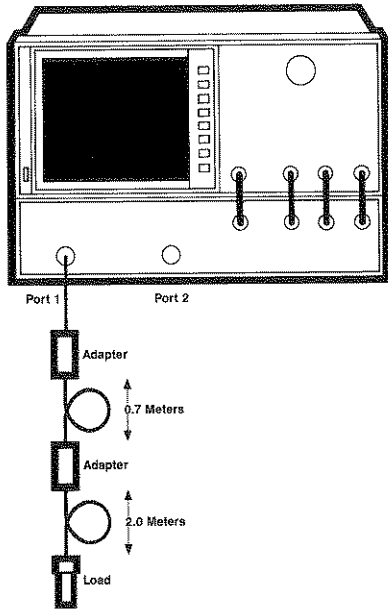

Preset

Connections

Connect the HP 85046A/B to the network analyzer as shown in the figure.

Controls

1. Measurement S11 or A/R on CH 1
2. Format LIN MAG
3. Stimulus START 300 kHz
STOP 3 GHz

Calibrate

Perform an S_{11} 1-port calibration as described in the previous setup.

Device Under Test

Connect a test cable, with one or two adapters to make things interesting, as shown in the figure. Terminate the end of the cable.

Autoscale

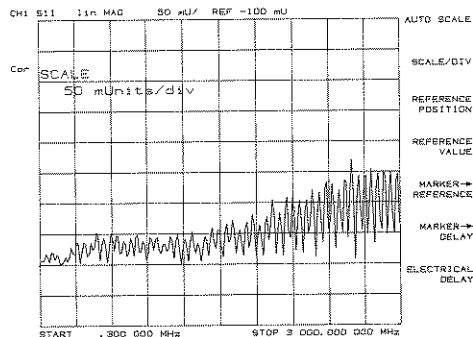

The figure shows the frequency domain reflection response of the cables under test. The complex ripple pattern is caused by reflections from the adapters interacting with each other. By transforming this data to the time domain, you can determine the magnitude of the reflections versus distance along the cable.

To transform to the time domain press [SYSTEM] and [TRANSFORM MENU]. Select [BANDPASS] transform mode. The low pass impulse mode is most similar to the TDR but we use the bandpass mode in this example because it is simpler. Refer to the HP 8753B Operating and Programming Manual for a complete description of all the time domain operating modes.

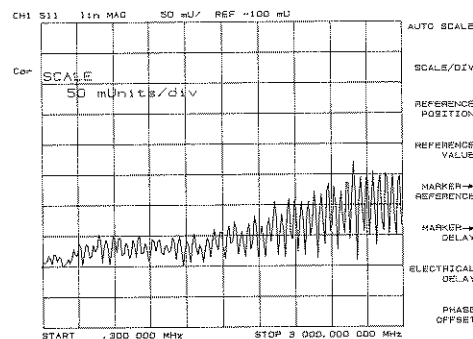

Turn the time domain transform on by selecting [TRANSFORM ON off]. To view the time domain over the length of the cable under test enter a start time of 0 seconds (press [START] [0] [x1]) and a stop time that corresponds to the length of the cable under test. A good rule of thumb is that the energy travels about 1 foot per nanosecond, or 0.3 meter/ns, in free space. Since most cables have a relative velocity about $\frac{2}{3}$ of the speed in free space, and since you measure the roundtrip distance to the end of the cable, figure about 3 ns/foot, or 10 ns/meter, for the stop time. In this example, enter a stop time of 40 ns (press [STOP] [4] [0] [G/n]) for a cable under test that is about four meters long.

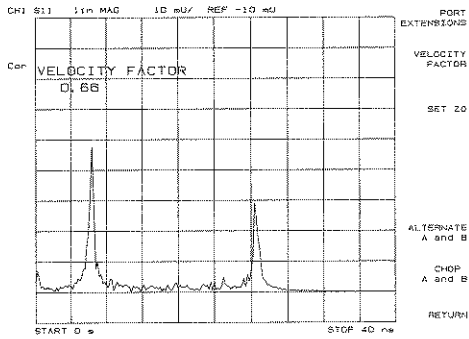

Enter the relative velocity of the cable under test. The HP 8753B markers then read the actual round trip distance to the reflection of interest rather than the "electrical length" that assumes a relative velocity of 1. Press [CAL] and select [MORE] then [VELOCITY FACTOR]. Enter a velocity factor for your cable under test. Most cables have a relative velocity of 0.66 (for polyethylene dielectrics) or 0.7 (for teflon dielectrics). If you would like the markers to read actual one-way distance rather than round trip distance, enter one-half the actual velocity factor.

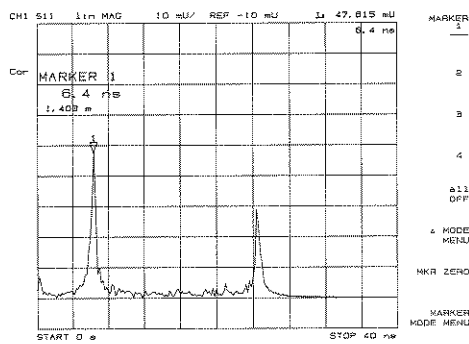

Press [MKR] and use the knob to position the marker on the reflection of interest. Note that the marker reads the time and distance to the reflection in the upper left hand side of the graticule. Loosen one of the connectors to see the corresponding reflection increase.

Harmonic Measurements with the HP 8753B

(Option 002)

In addition to measuring gain, an amplifier's harmonic response is often measured. Traditionally, harmonic measurements have been made with a signal generator, and spectrum analyzer at a number of CW frequencies. The HP 8753B makes it possible to make swept second and third order harmonic measurements directly. This capability can significantly reduce component test times. To demonstrate this a measurement of a preamplifier follows (HP 10855A).

Basic Setup The equipment configuration used is similar to the one used in a transmission measurement, (Chapter 2). This example will step through a typical measurement of amplifier gain and swept second and third order harmonic response.

Measuring Swept Harmonics A harmonic measurement gives the ratio of harmonic signal level to fundamental signal level versus frequency. When set up as shown below, the results can be read directly in decibels, (dBc).

Preset

Connections Connect the HP 85046A/B or HP 85047A S-parameter test set to the network analyzer as shown in the adjacent figure.

Controls

1. Measurement	S21 (or B/R)
2. Format	LOG MAG
3. Stimulus	START 50 MHz STOP 1 GHz POWER 0 dBm ATTENUATOR PORT 1 20dB

Calibrate Substitute a thru for the amplifier under test and do a frequency response calibration. For the gain measurement this procedure will remove the frequency response and insertion loss errors of the test set up. For the swept harmonic measurements there are some residual errors, due to the difference in frequency between the fundamental and the harmonic, that cannot be compensated for.

Device Under Test Connect the DUT.

Note*

When measuring harmonics, it is suggested that you pay close attention to the incident power on your DUT and the HP 8753B's receiver. By correctly choosing input attenuation and fixed output attenuator values the DUT's harmonics will be more easily distinguished from those of the HP 8753B.

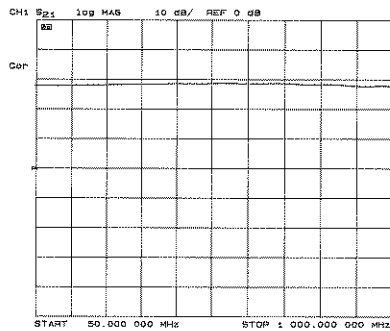

SAVE
REG1
SAVE
REG2
SAVE
REG3
SAVE
REG4
SAVE
MODE
CLEAR
REGISTER
TITLE
REGISTER
STORE TO
DISC

This figure shows gain (S21) of the preamplifier.

In measuring gain we are concerned with the ratio of output power to the input power of the amplifier.

For harmonic measurements we wish to measure the harmonic output of the amplifier with respect to its fundamental output. Therefore we first need to measure the signal at the output of the amplifier alone. To do this press [MEAS], [INPUT PORTS], and [B]. This key sequence will allow you to look at only the fundamental signal at the amplifiers output.

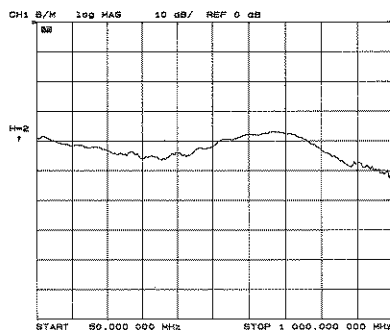

HARMONIC
OFF
SECOND
THIRD
RETURN

Pressing [DISPLAY], [DATA → MEMORY], and [DATA/MEM] stores the fundamental data in memory and lets us look at incoming data relative to it.

In this example, changing the reference position to the top of the screen [SCALE REF], [REFERENCE POSITION] [10] [x1] will let us view the fundamental and harmonic responses on the same display.

Second harmonic mode [SYSTEM], [HARMONIC MEAS], [SECOND] displays the preamplifier's second harmonic response relative to that of the fundamental (dBc).

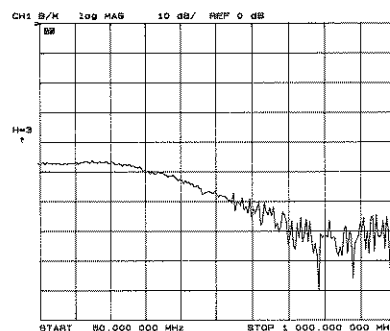

HARMONIC
OFF
SECOND
THIRD
RETURN

Similarly, third harmonic mode [THIRD] displays the preamplifier's third harmonic response relative to that of the fundamental (dBc).

In this chapter we have quickly measured three important amplifier parameters, gain, and second and third order harmonic responses. Other previously discussed measurement techniques such as the use of marker functions (Chapter 1), limit line testing (Chapter 2), and reflection measurements (Chapter 3) can easily be adapted to enhance and expand the amplifier measurements discussed in this chapter.

Test Sequencing with the HP 8753B

In component testing it is usually necessary to repeatedly make measurements requiring a series of keystrokes. The HP 8753B's test sequencing function allows the user to create, title, save, and execute up to 6 independent sequences internally. Test sequencing can dramatically reduce the time required to make a multiple step measurement, and will all but eliminate operator error during testing.

Creating a test sequence is virtually identical to making a manual measurement using the HP 8753B's front panel. Once you have entered the sequencing mode all you need to do is make the desired measurement. The HP 8753B will record the keystrokes it took to do so, storing them internally where they can be called up and repeated with a single keystroke. To demonstrate this capability a test sequencing example follows.

Creating a Test Sequence

The following sequence will perform the transmission measurement previously discussed in Chapter 2, pause for 2 seconds, perform the reflection measurement previously discussed in Chapter 3, again pause for 2 seconds and then simultaneously display both measurements.

This simple example is chosen to illustrate the capability, and ease of use of the HP 8753B's sequencing function. The techniques presented can easily be applied to longer and more complicated test procedures.

[SYSTEM]
[SEQUENCING MENU]
[NEW SEQ/MODIFY SEQ]
[SEQUENCE 1]

Entering test sequencing mode.
Creating a new sequence.
Choosing to store sequence in register 1.

[RECALL]
[RECALL PRST STATE]

Recalling a known instrument state.

[CENTER] [134] [M/u]
[SPAN] [30] [M/u]

[MEAS] <i>[Trans: FWD S21 (B/R)]</i>	Setting measurement controls.
[FORMAT] <i>[LOG MAG]</i>	Displaying log magnitude.
[SCALE REF] <i>[AUTO SCALE]</i>	
[SYSTEM] <i>[SEQUENCING MENU] [SPECIAL FUNCTIONS] [WAIT X] [2] [x1]</i>	Pausing for 2 seconds.
[CH 2]	Displaying channel 2.
[MEAS] <i>[Ref: FWD S11 (A/R)]</i>	Setting measurement controls.
[FORMAT] <i>[SMITH CHART]</i>	Displaying Smith chart.
[SYSTEM] <i>[SEQUENCING MENU] [SPECIAL FUNCTIONS] [WAIT X] [2] [x1]</i>	Pausing for 2 seconds.
[DISPLAY] <i>[DUAL CHAN ON off]</i>	Display both channels simultaneously.
[SYSTEM] <i>[SEQUENCING MENU] [DONE MODIFY]</i>	Completes the creation process.

Executing a Test Sequence

We are now ready to recall and run the test sequence we have written and stored in the 8753B.

Preset	A known state is recalled from inside the sequence.
Connections	Connect the HP 85046A/B or HP 85047A S-parameter test set to the network analyzer as shown in the adjacent figure.
Controls	All measurement controls are automatically recalled from within the sequence.
Calibrate	The HP 8753B allows you the flexibility to perform, or recall (from external disc or internal register), any desired calibration during the execution of a test sequence. To maintain simplicity no measurement calibration is used in this example.
Device Under Test	Connect the DUT.

Recalling a Test Sequence

To recall and execute the sequence we have stored in register 1 press the following keys.

[PRESET]
[SEQUENCE SEQ 1]

When the test sequence has been completed the adjacent configuration will be displayed on the CRT.

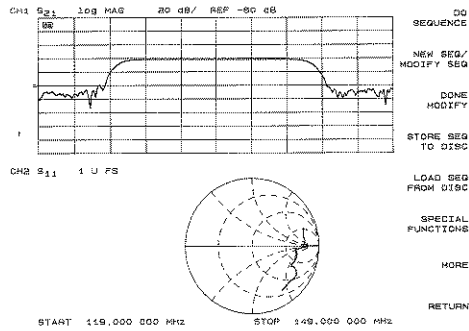

In this very simple example a measurement requiring 30 keystrokes was replaced with just 1. A more complicated measurement would further increase instrument productivity, and reduce possibility for operator error.

In addition the test sequencing function provides if/then decision capability and operator prompts, and can incorporate all of the HP 8753B's standard and optional features (i.e. marker functions, limit testing, harmonic analysis).

In an automated testing environment, where many test sequences may be required, external storage/recall of sequences can be used to further enhance the HP 8753B's productivity in a testing environment.

The HP 8753B allows you to cascade multiple sequences to perform longer or more complicated testing procedures.

This feature also allows you to send HP-IB output strings to control external devices, such as signal generators, power supplies or relay actuators.

Operation up to 6 GHz

Equipment required for 6 GHz operation

- HP 8753B with (Option 006).
- HP 85047A 6 GHz S-parameter test set.

6 GHz Receiver (Option 006)

This option extends the upper frequency limit of the HP 8753B's receiver to 6 GHz. Option (006) also controls the frequency doubler in the HP 85047A S-Parameter test set.

HP 85047A 6 GHz S-Parameter test set

To activate frequency doubler mode press [SYSTEM], [FREQ RANGE 3GHz 6GHz] or [PRESET], [FREQ RANGE 3GHz 6GHz], on the front panel of your option (006) equipped HP 8753B. Once activated, the frequency doubler in the HP 85047A S-parameter test set (shown in the adjacent figure), changes the frequency range of the signal output to the DUT from (300 kHz - 3 GHz) to (3 MHz - 6 GHz).

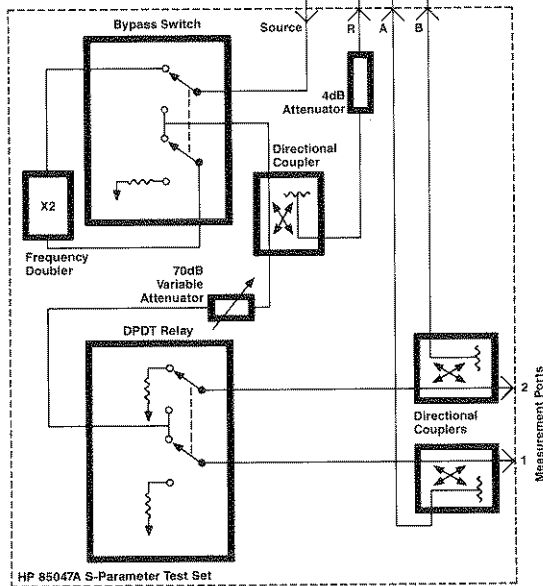
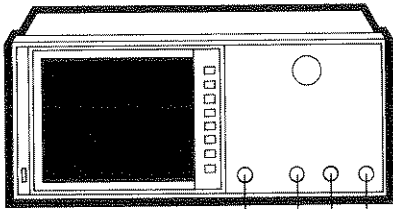

Below 3 GHz the maximum output power at the test ports is nominally 18 dBm. In frequency doubler mode the maximum output power at the test ports is nominally 3 dBm.

The HP 85047A S-parameter test set has less insertion loss and offers greater maximum power to the test ports than both the HP 85046A, or HP 85044A test sets.

User's Guide

The User's Guide is initially packaged with the getting started documents shipped with the HP 8753B. When not using the guide, you may place it here for future reference.

Product Note 8753-1

 HEWLETT
PACKARD

RF Component Measurements
Amplifier measurements using
the HP 8753 network analyzer

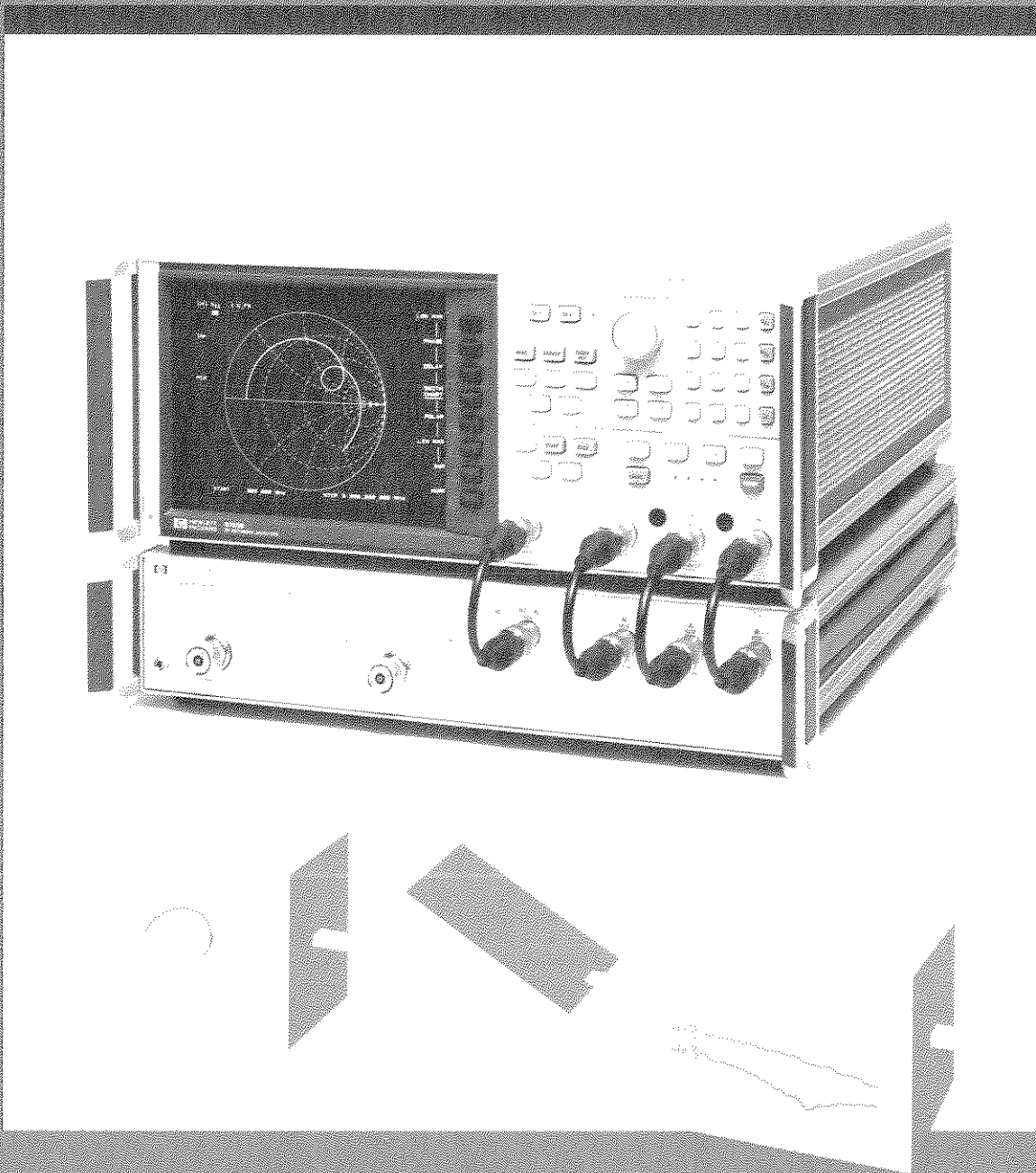

Introduction

Table of contents

Introduction	2
Amplifier Definitions	3
Equipment Required	4
Linear Measurements	
Transmission Measurements	4
Phase Measurements	6
Reflection Measurements	7
Non-Linear Measurements	
Gain Compression	8
Non-Linear Measurements with the HP 8753B	
Swept Harmonic Levels	10
Two-Tone Third Order Intermodulation	11
Enhanced Manufacturing Techniques	
Limit Lines	12
Test Sequence Function (HP 8753B)	13
Accuracy Considerations	14
Appendix	
S-Parameter Test Set Considerations	15

Network analyzers are traditionally used to measure the transmission and reflection characteristics of components, circuits, and devices. This note describes how the HP 8753 vector network analyzer accurately and efficiently characterizes RF amplifiers.

The HP 8753 easily measures commonly specified, amplifier scalar parameters: gain, gain compression, isolation, return loss (SWR), and gain drift versus time. Built-in phase measurement capability allows characterization of an amplifier's deviation from linear phase, group delay, and complex impedance. Knowledge of both magnitude and phase characteristics is needed for successful higher-level component integration.

Besides phase measurement capability, the HP 8753 offers other advantages over a scalar system for amplifier characterization. The HP 8753 employs a tuned receiver which improves dynamic range, sensitivity, and eliminates unwanted spurious responses. The instrument also offers accuracy enhancement which dramatically reduces systematic errors for more precise characterization.

Additional capabilities with the HP 8753B

Harmonic distortion is often specified to describe amplifier non-linear behavior. The HP 8753B Network Analyzer with harmonic measurement capability, option 002, can quickly and easily determine swept amplifier harmonic levels over a broad range.

The HP 8753B offers several other powerful enhancements to increase amplifier measurement productivity and capability. By employing an HP 85047A S-parameter Test Set with 6 GHz receiver, Option 006, complete forward and reverse characteristics of an amplifier can be determined up to 6 GHz. Two-tone third order intermodulation measurements are possible with the instrument by employing two external sources. In fact, the HP 8753B offers several new instrument modes which allow measurements on frequency translation devices such as mixers. Refer to Product Note 8753-2, *Mixer Measurements using the HP 8753B* (HP lit. no. 5956-4362), for a discussion on these measurements. Complex tests can be performed automatically with a single keystroke using the test sequence function. Power meter calibration enables the HP 8753B's source to be leveled at the input or output of an amplifier.

In this product note, measurements are detailed in easy to follow, step-by-step procedures. Accuracy considerations are covered for each measurement. Finally, an appendix discusses S-parameter test set considerations.

Amplifier definitions

This section contains brief descriptions of the amplifier parameters that can be measured using the HP 8753 RF vector network analyzer.

Gain

Amplifier gain is defined as the ratio of the amplifier output power delivered to a Z_o load to the input power delivered from a Z_o source, where Z_o is the characteristic impedance in which the amplifier is used (50 ohms in this note). In logarithmic terms, gain is the difference in dB between the output and input power levels.

Since variations in frequency response represent distortion, "gain flatness" is often specified over the frequency range of the amplifier.

Reverse isolation

Reverse isolation is the measure of transmission from output to input. The measurement of isolation is similar to the measurement of small signal gain, except that the stimulus signal is applied to the amplifier's output.

Gain versus time

Gain versus time is defined as the variation of gain in time, with all other parameters held constant. Stability can be affected by changes in the amplifier's active devices occurring over time. This parameter is typically specified in maximum variation in gain over a given time interval. Often, gain is investigated with respect to other parameter changes, such as temperature or humidity.

Deviation from linear phase

Ideally, the phase shift through an amplifier is a linear function of frequency. The amount of variation from this theoretical phase shift is known as its deviation from linear phase (also called phase linearity).

Group delay

Group delay is a measure of transit time through an amplifier at a particular frequency. It is defined as the derivative of the phase response with respect to frequency. The HP 8753 has the ability to derive the group delay from the measured phase response.

Return loss/SWR

A commonly specified parameter is the quality of the match at the input and output of an amplifier relative to the system characteristic impedance. Impedance parameters are defined by the following equations:

$$\Gamma = V_{\text{reflected}} / V_{\text{incident}} = \rho \angle \theta$$

$$\text{Return Loss} = -20 \log_{10} \rho$$

$$\text{SWR} = \frac{1 + \rho}{1 - \rho}$$

Complex impedance

The complex impedance of an amplifier consists of both a resistive and a reactive component. It is derived from the characteristic impedance of a system and the reflection coefficient by the following equation:

$$Z = \frac{1 + \Gamma * Z_o}{1 - \Gamma}$$

Gain compression

An amplifier has a region of linear gain, where the gain is independent of input power level. This is commonly referred to as "small signal gain." As the input power is increased to a level that causes the amplifier to saturate, gain decreases, resulting in the "large signal" response (see Figure 1-a).

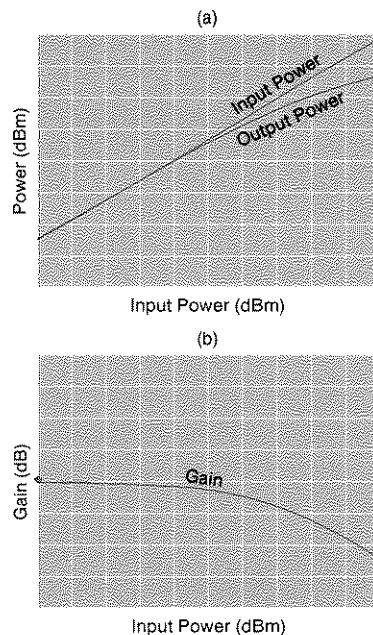

Figure 1. Typical amplifier's characteristics: (a) output power versus input power and (b) gain versus input power.

In this note, gain compression is determined by measuring the amplifier's 1 dB gain compression point (P_{1dB}). This is the point where the output power drops 1 dB relative to the small signal gain (see Figure 1-b). This is a common measure of an amplifier's power output capability.

Harmonic distortion (HP 8753B)

Due to inherent non-linearities, an amplifier generates additional responses at integer multiples of the stimulus frequency. The integer number determines the order of the harmonic. For example, if the harmonic frequency is equal to three times the fundamental frequency, it is known as the third harmonic. Harmonic level is defined as the difference in absolute power between the fundamental and the harmonic, expressed in dBc (dB relative to carrier), for a specified amplifier input or output power.

Two-tone intermodulation distortion (HP 8753B)

When two or more sinusoidal frequencies are applied to an amplifier, the output contains additional frequency components called intermodulation products. For an amplifier with input signals at frequencies f_1 and f_2 , the output will contain signals at the following frequencies: $nf_1 + mf_2$ where $n, m = 0, +1, +2, +3 \dots$. The order of the intermodulation distortion product is defined as $i = |n| + |m|$. Third order products ($i = 3$) are a major concern because of their proximity to the fundamental frequencies (see Figure 2).

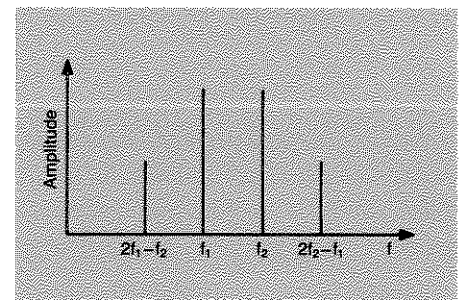

Figure 2. Two-tone third order intermodulation products.

Measurements

Equipment required

The following equipment is typically required for the measurements described in this note. Other configurations can also be used:

- HP 8753B Network Analyzer/
Opt. 002
- Test Set: HP 85044A, 85046A/B,
85047A
- Calibration Kit
- Test Port Cables
- Coaxial Attenuators, as needed
- HP-IB Cables
- Bias Supply
- Power Meter and Sensor
- Test Amplifier such as the HP 10855A
Preamp

The HP 10855A has the following specifications.

- Frequency range: 2 MHz to 1300 MHz
- Gain: 24 dB typical
- Output power for 1 dB compression: 0 dBm

All measurements described in this note, except for two-tone third order intermodulation, use the HP 8753B Network Analyzer configured with the HP 85046A 50 ohm S-parameter test set. Wherever the instrument is referred to as the HP 8753, either the HP 8753A or 8753B can be used to make the measurement equally well. Those unfamiliar with the test configuration are advised to read the appendix before continuing. It contains a description of the HP 85046A and 85047A test sets and shows signal attenuation through each test set and the corresponding power at the ports. Also included are general guidelines for selecting proper attenuation, as well as the HP 8753 parameters needed for proper test setup design.

The reader should be familiar with general network analyzer operation, including the different calibrations available to enhance measurement accuracy. Refer to the *HP 8753B User's Guide* (HP part no. 08753-90007) or the *HP 8753B System Operating and Programming Manual* (HP part no. 08753-90119) for a complete description of instrument operation and the calibration sequences available.

For power meter calibrations, an HP 436A, 437B, or 438A can be used. A power sensor such as the HP 8482A is also required.

In the following measurement procedures, the HP 8753 front panel keys such as [DISPLAY] appear in brackets with bold type. The "softkeys", labeled on the CRT, also appear in brackets but with bold italic type (e.g., [LOG MAG]).

Linear measurements

The following linear measurements can be made with a single connection to the S-parameter test set (see Figure 3). A full two-port calibration yields the most accurate results. Before calibration, set the measurement parameters to their desired values. It may be appropriate to step through some of the measurements before performing the calibration to ensure proper stimulus settings. Power levels at the various ports are of primary concern when measuring the linear transmission and reflection characteristics of amplifiers. If external attenuation is needed, calibrate with the attenuator in the system to remove its effects.

Transmission measurements

Transmission measurements can be made using the basic setup shown in Figure 3. An external attenuator at the amplifier output may be necessary to keep the power level at the B receiver input below the maximum level (0 dBm) for gain measurements. The test set attenuator, accessed through the HP 8753, affects only the source power path.

Both gain and isolation measurements are possible with the same stimulus settings by choosing a source power level for the reverse isolation measurement, then using the test set attenuator to reduce the power at the amplifier input for linear gain measurements.

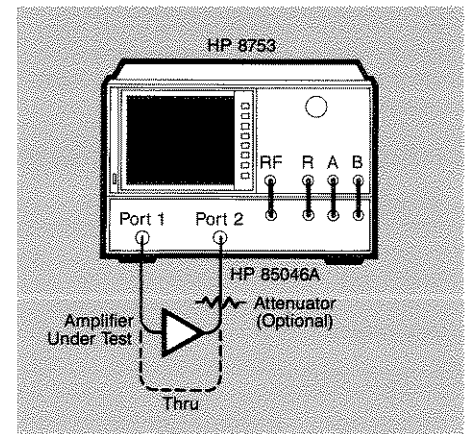

Figure 3. Basic setup for amplifier measurements using the HP 8753 with a S-parameter test set.

Amplifier definitions

This section contains brief descriptions of the amplifier parameters that can be measured using the HP 8753 RF vector network analyzer.

Gain

Amplifier gain is defined as the ratio of the amplifier output power delivered to a Z_o load to the input power delivered from a Z_o source, where Z_o is the characteristic impedance in which the amplifier is used (50 ohms in this note). In logarithmic terms, gain is the difference in dB between the output and input power levels.

Since variations in frequency response represent distortion, "gain flatness" is often specified over the frequency range of the amplifier.

Reverse isolation

Reverse isolation is the measure of transmission from output to input. The measurement of isolation is similar to the measurement of small signal gain, except that the stimulus signal is applied to the amplifier's output.

Gain versus time

Gain versus time is defined as the variation of gain in time, with all other parameters held constant. Stability can be affected by changes in the amplifier's active devices occurring over time. This parameter is typically specified in maximum variation in gain over a given time interval. Often, gain is investigated with respect to other parameter changes, such as temperature or humidity.

Deviation from linear phase

Ideally, the phase shift through an amplifier is a linear function of frequency. The amount of variation from this theoretical phase shift is known as its deviation from linear phase (also called phase linearity).

Group delay

Group delay is a measure of transit time through an amplifier at a particular frequency. It is defined as the derivative of the phase response with respect to frequency. The HP 8753 has the ability to derive the group delay from the measured phase response.

Return loss/SWR

A commonly specified parameter is the quality of the match at the input and output of an amplifier relative to the system characteristic impedance. Impedance parameters are defined by the following equations:

$$\Gamma = V_{\text{reflected}} / V_{\text{incident}} = \rho \angle \theta$$

$$\text{Return Loss} = -20 \log_{10} \rho$$

$$\text{SWR} = \frac{1 + \rho}{1 - \rho}$$

Complex impedance

The complex impedance of an amplifier consists of both a resistive and a reactive component. It is derived from the characteristic impedance of a system and the reflection coefficient by the following equation:

$$Z = \frac{1 + \Gamma * Z_o}{1 - \Gamma}$$

Gain compression

An amplifier has a region of linear gain, where the gain is independent of input power level. This is commonly referred to as "small signal gain." As the input power is increased to a level that causes the amplifier to saturate, gain decreases, resulting in the "large signal" response (see Figure 1-a).

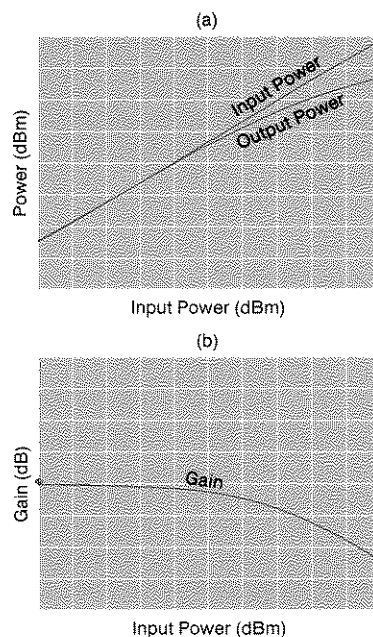

Figure 1. Typical amplifier's characteristics: (a) output power versus input power and (b) gain versus input power.

In this note, gain compression is determined by measuring the amplifier's 1 dB gain compression point (P_{1dB}). This is the point where the output power drops 1 dB relative to the small signal gain (see Figure 1-b). This is a common measure of an amplifier's power output capability.

Harmonic distortion (HP 8753B)

Due to inherent non-linearities, an amplifier generates additional responses at integer multiples of the stimulus frequency. The integer number determines the order of the harmonic. For example, if the harmonic frequency is equal to three times the fundamental frequency, it is known as the third harmonic. Harmonic level is defined as the difference in absolute power between the fundamental and the harmonic, expressed in dBc (dB relative to carrier), for a specified amplifier input or output power.

Two-tone intermodulation distortion (HP 8753B)

When two or more sinusoidal frequencies are applied to an amplifier, the output contains additional frequency components called intermodulation products. For an amplifier with input signals at frequencies f_1 and f_2 , the output will contain signals at the following frequencies: $nf_1 + mf_2$ where $n, m = 0, +1, +2, +3 \dots$. The order of the intermodulation distortion product is defined as $i = |n| + |m|$. Third order products ($i = 3$) are a major concern because of their proximity to the fundamental frequencies (see Figure 2).

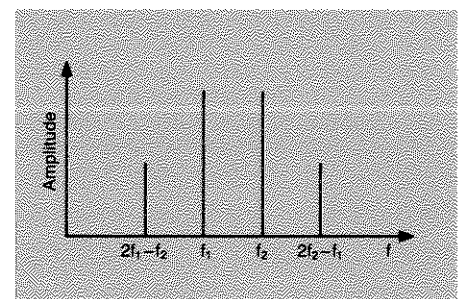

Figure 2. Two-tone third order intermodulation products.

Measurements

Equipment required

The following equipment is typically required for the measurements described in this note. Other configurations can also be used:

- HP 8753B Network Analyzer/ Opt. 002
- Test Set: HP 85044A, 85046A/B, 85047A
- Calibration Kit
- Test Port Cables
- Coaxial Attenuators, as needed
- HP-IB Cables
- Bias Supply
- Power Meter and Sensor
- Test Amplifier such as the HP 10855A Preamp

The HP 10855A has the following specifications.

- Frequency range: 2 MHz to 1300 MHz
- Gain: 24 dB typical
- Output power for 1 dB compression: 0 dBm

All measurements described in this note, except for two-tone third order intermodulation, use the HP 8753B Network Analyzer configured with the HP 85046A 50 ohm S-parameter test set. Wherever the instrument is referred to as the HP 8753, either the HP 8753A or 8753B can be used to make the measurement equally well. Those unfamiliar with the test configuration are advised to read the appendix before continuing. It contains a description of the HP 85046A and 85047A test sets and shows signal attenuation through each test set and the corresponding power at the ports. Also included are general guidelines for selecting proper attenuation, as well as the HP 8753 parameters needed for proper test setup design.

The reader should be familiar with general network analyzer operation, including the different calibrations available to enhance measurement accuracy. Refer to the *HP 8753B User's Guide* (HP part no. 08753-90007) or the *HP 8753B System Operating and Programming Manual* (HP part no. 08753-90119) for a complete description of instrument operation and the calibration sequences available.

For power meter calibrations, an HP 436A, 437B, or 438A can be used. A power sensor such as the HP 8482A is also required.

In the following measurement procedures, the HP 8753 front panel keys such as [DISPLAY] appear in brackets with bold type. The "softkeys", labeled on the CRT, also appear in brackets but with bold italic type (e.g., [LOG MAG]).

Linear measurements

The following linear measurements can be made with a single connection to the S-parameter test set (see Figure 3). A full two-port calibration yields the most accurate results. Before calibration, set the measurement parameters to their desired values. It may be appropriate to step through some of the measurements before performing the calibration to ensure proper stimulus settings. Power levels at the various ports are of primary concern when measuring the linear transmission and reflection characteristics of amplifiers. If external attenuation is needed, calibrate with the attenuator in the system to remove its effects.

Transmission measurements

Transmission measurements can be made using the basic setup shown in Figure 3. An external attenuator at the amplifier output may be necessary to keep the power level at the B receiver input below the maximum level (0 dBm) for gain measurements. The test set attenuator, accessed through the HP 8753, affects only the source power path.

Both gain and isolation measurements are possible with the same stimulus settings by choosing a source power level for the reverse isolation measurement, then using the test set attenuator to reduce the power at the amplifier input for linear gain measurements.

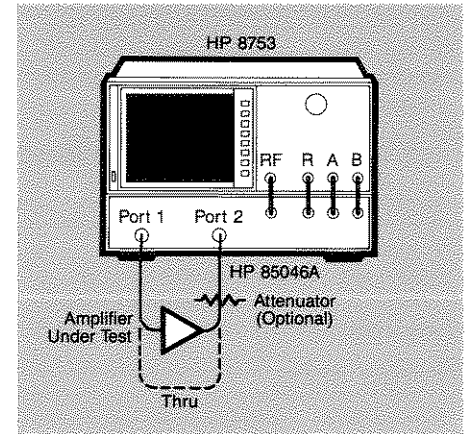

Figure 3. Basic setup for amplifier measurements using the HP 8753 with a S-parameter test set.

NOTE: When measuring high gain amplifiers, it is possible to overload one of the receiver inputs on the HP 8753 (> 0 dBm). When this happens, a *P1* will appear on the left of the screen and a power trip condition will occur. This forces the source power to be reset to its minimum value (-5 dBm) regardless of the user-specified level. You should then either add more attenuation to the output of the amplifier, or reduce the RF power of the source before repeating the measurement. The following keystroke sequence turns power trip off:

```
[MENU]
[POWER]
[POWER TRIP on OFF]
```

Small signal gain

Small signal gain is the gain in the amplifier's linear region of operation. This is typically measured at a constant input power over a swept frequency. Figure 4 shows an example swept frequency gain measurement.

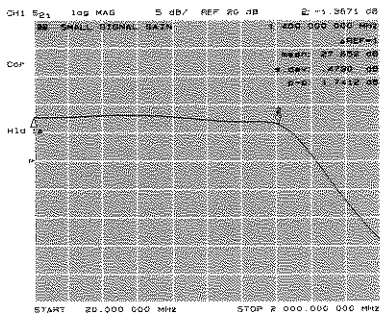

Figure 4. Small signal gain measurement.

Measurement procedure

1. Connect the system as shown in Figure 3. Preset the HP 8753 to return the instrument to a known state of operation.

```
[PRESET]
```

CAUTION: At preset, the source power level is set to its default value of 0 dBm and the internal attenuator for port 1 is set to 0 dB. The preset power level available at port 1 is dependent on the test set used (see *Appendix* for details). If the amplifier under test could be damaged by this power level or will be operating in its non-linear region, it should not be connected until these parameters are set to a desirable level.

2. Choose measurement parameters and perform a calibration. When an attenuator is used on the output of the amplifier, calibrate with it in the system. Remember to consider power levels needed for the reverse isolation measurement when setting the source power and test set attenuation.

```
[START] [20] [M/u]
[STOP] [2] [G/n]
[MENU]
[POWER] [5] [x1]
[ATTENUATOR PORT 1] [30] [x1]
[MEAS]
[S21 [B/R]]
[FORMAT]
[LOG MAG]
```

Perform a measurement calibration.

The instrument state can be saved for later measurements.

```
[SAVE]
[SAVE REG 1]
```

3. Connect the device and apply bias.

4. Scale the display for optimum viewing of the amplifier's gain. Alternatively, the *[AUTOSCALE]* softkey can be used to set the scaling parameters automatically, although it may be preferable to control these manually.

```
[SCALE REF]
[REFERENCE VALUE] [20] [x1]
[SCALE/DIV] [5] [x1]
```

5. Use a marker to measure the small signal gain at a desired frequency.

```
[MKR]
```

Rotate the knob until the marker is set.

6. Measure the gain variation or ripple in the frequency range. Set two markers on the trace to define the start and stop of the frequency range of interest, then use the marker statistics function to view peak-to-peak ripple (see Figure 4).

```
[MKR]
Position marker 1.
[MKR ZERO]
[MARKER 2]
Position marker 2.
[MKR FCTN]
[STATS ON off]
```

Reverse isolation

Reverse isolation can be measured with the small signal gain setup and procedure, with some modifications.

The RF stimulus signal is applied to the output of the amplifier. When the HP 85046/7A test set is connected, this can be done from the front panel of the HP 8753 by simply measuring S12. The external attenuator on the amplifier output is not needed since the signal path now exhibits loss instead of gain.

For amplifiers with very high isolation, measurement sensitivity can be improved by employing averaging or by reducing the IF bandwidth of the HP 8753.

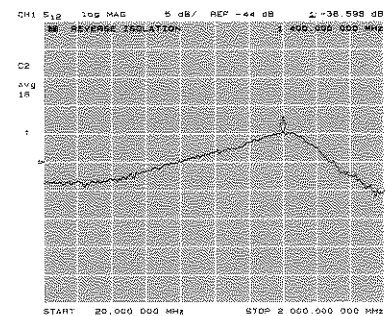

Figure 5. Reverse isolation measurement.

Gain versus time

Gain variation in time, with all other parameters held constant, is sometimes referred to as gain drift. The HP 8753 allows fixed frequency measurements to be made over 100 ms to 24 hour time intervals. This measurement uses the standard setup of Figure 3. An example plot of an amplifier's gain drift over a 10 minute interval is shown in Figure 6.

Often, gain is investigated with respect to other parameter changes, such as temperature or humidity. The procedure described can be modified to be used with an external controller to vary temperature, for example.

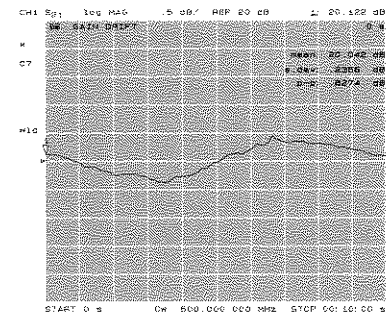

Figure 6. Gain versus time measurement.

Measurement procedure

1. Connect the instrument as shown in Figure 3.
2. Preset the instrument and measure S21 in log format.
[PRESET]
[MEAS]
[S21 [B/R]]
[FORMAT]
[LOG MAG]
3. Enter the desired fixed frequency.
[MENU]
[CW FREQ] [500] [M/u]
4. Modify the parameters such that the amplifier operates in its linear region.
[MENU]
[POWER] [5] [x1]
[ATTENUATOR PORT 1] [30] [x1]
5. When calibrating in the CW time mode, if the desired measurement sweep time is long the user may specify a shorter calibration time, in this case four seconds.
[STOP] [4] [x1]
6. Use a single sweep for the calibration and measurement.

- [MENU]
[TRIGGER MENU]
[SINGLE]
Perform a response calibration.
7. Connect the amplifier under test and apply bias. A 10-minute sweep was used for this measurement. The analyzer will display a C? to indicate that a source parameter has been changed.

[STOP] [10] [: h:m:s] [0] [x1]
[MENU]

- [MEASURE RESTART]
8. Scale the display to see the gain variations with time.

[MKR] [0] [x1]
[SCALE REF]
[MARKER → REFERENCE]
[SCALE/DIV] [.2] [x1]

9. Use marker statistics to measure the maximum peak-to-peak variation in gain over the time interval.

[MKR FCTN]
[STATS ON off]

Phase measurements

Transmission phase measurements are made with the same setup as magnitude transmission measurements (Figure 3). For cases such as complex impedance, both magnitude and phase are displayed simultaneously. Power levels and number of points are both considerations when measuring phase.

Deviation from linear phase

The deviation from linear phase measurement employs the electrical delay capability of the HP 8753 to add electrical delay to the amplifier to remove the linear portion of the phase shift (see Figure 7).

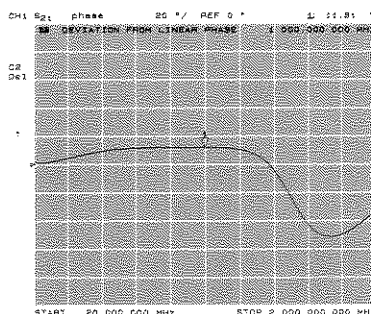

Figure 7. Deviation from linear phase measurement.

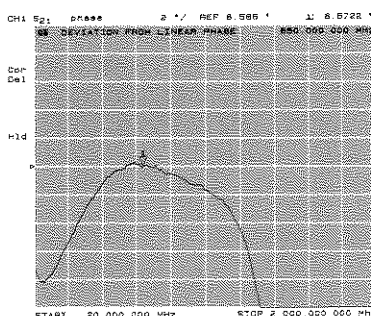

Figure 8. Expanded plot allows fine-tuning of the electrical delay.

Measurement procedure

1. Follow the first two steps in the *Small Signal Gain Measurement Procedure*. Display the phase response of the measurement.
[FORMAT]
[PHASE]
2. Scale the display.
[SCALE REF]
[SCALE/DIV] [20] [x1]
3. Place a marker in the center of the amplifier bandwidth and activate the electrical delay function.
[MKR FCTN]
Position the marker with the knob.
[MARKER → DELAY]
4. Expand the scale and fine-tune the electrical delay to flatten the phase near the center of the passband (see Figure 8).
[MARKER → REFERENCE]
[SCALE REF]
[SCALE/DIV] [2] [x1]
[ELECTRICAL DELAY]

Adjust electrical delay to flatten the response. By flattening the phase response we have effectively removed the linear phase shift through the amplifier under test. The deviation from this linear phase shift remains.

Group delay

Group delay, like deviation from linear phase, is a measure of amplifier distortion. The HP 8753 calculates group delay from the phase and frequency information and displays the results in real time (see Figure 9). It is important to keep the phase difference measured between two adjacent frequency points less than 180°. Otherwise, incorrect group delay information may result. The test setup of Figure 3 is again employed.

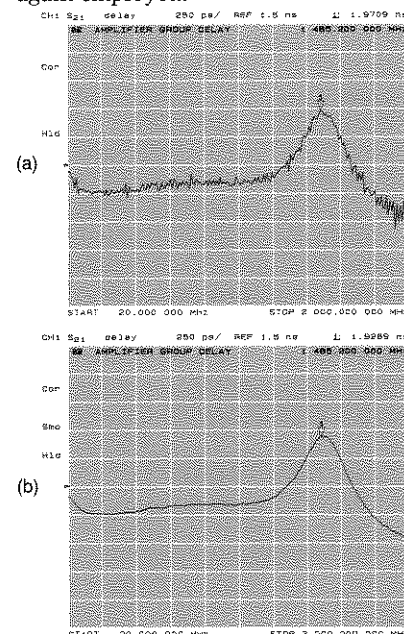

Figure 9. Group delay measurement: (a) with minimum aperture and (b) with increased aperture.

Measurement procedure

1. Follow the first two steps in the *Small Signal Gain Measurement Procedure*. If the instrument state was saved, recall it from memory.
[RECALL]
[RECALL REG 1]
2. Display the group delay response of the amplifier under test.
[FORMAT]
[DELAY]
[SCALE REF]
[AUTOSCALE]
3. This measurement may require a specific group delay aperture. The minimum aperture is equal to the frequency span divided by the number of points minus one (see Figure 9-a). Aperture can be increased from the minimum by varying the smoothing aperture. Increasing the aperture reduces the resolution demands on the phase detector and permits better group delay resolution (see Figure 9-b).
[AVG]
[SMOOTHING ON off]
[SMOOTHING APERTURE]
Adjust aperture as needed.

Reflection measurements

Reflection measurements can be made with the same setup as transmission measurements (Figure 3). If external attenuation is needed for gain measurements, calibrate with the attenuator in the system to remove its effects. Since reflection measurements involve loss instead of gain, power levels are lower at the receiver inputs. Therefore, it may be necessary to increase power levels for reflection measurements.

Alternatively, reduce the noise level by decreasing the IF bandwidth or by employing averaging.

Return loss, SWR, and reflection coefficient

Return loss, standing wave ratio (SWR), and reflection coefficient (ρ) are commonly specified for the amplifier's input and output ports. With the HP 8753, scalar reflection measurements can be displayed as return loss in dB, SWR, or ρ .

With the internal switching capabilities of the HP 85046/7A test set, you can switch between displaying the input reflection and output reflection with the touch of a key; no rearrangement of the test setup is required. Figure 10 shows an example amplifier input return loss measurement.

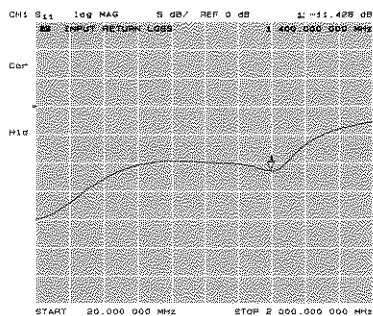

Figure 10. Input return loss measurement.

Measurement procedure

1. Connect the instruments as shown in Figure 3 and preset the network analyzer.

[PRESET]

2. Set source power and attenuation such that the amplifier operates in its linear region and power levels incident to the receiver inputs are below the maximum level. Also set all other stimulus parameters.

[MENU]

[POWER] [5] [x1]

[PORT 1 ATTENUATOR] [30] [x1]

[START] [20] [M/u]

[STOP] [2] [G/n]

3. Since reflection measurements are very sensitive to mismatches, a full 2-port calibration is recommended. A full 2-port calibration removes the effects of source and load match, directivity, and frequency response. Perform the calibration.

Alternatively, if a 2-port calibration was performed with suitable stimulus parameters for the small signal measurement, recall that instrument state.

[RECALL]

[RECALL REG 1]

4. If low level signals are being measured, reduce the IF bandwidth.

[AVG]

[IF BW]

[300] [x1]

5. Connect the amplifier under test and apply bias.

6. Display S11 on channel 1.

[MEAS]

[S11 [A/R]]

7. View the different reflection formats and scale as necessary. View return loss.

[FORMAT]

[LOG MAG]

View standing wave ratio.

[SWR]

View reflection coefficient, ρ .

[LIN MAG]

8. Now view return loss, SWR, or ρ at the amplifier's output port.

[MEAS]

[S22 [B/R]]

Repeat step 7.

Complex impedance

Because the HP 8753 measures phase as well as magnitude, complex impedance is easily determined once the instrument is configured to make reflection measurements.

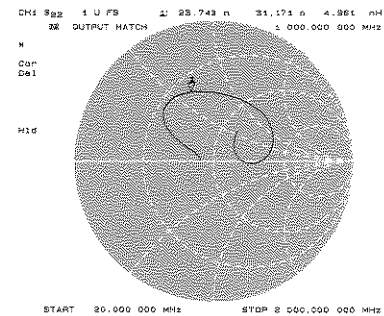

Figure 11. Complex impedance measurement.

Measurement procedure

1. Perform the Return Loss Procedure.

2. Display the output impedance by measuring S22 in Smith chart format. Figure 11 shows amplifier output impedance.

Markers used with this format display $R + jX$. In fact, the reactance is displayed as equivalent capacitance or inductance at the marker frequency.

[MEAS]

[S11 [A/R]]

[FORMAT]

[SMITH CHART]

3. View the complex reflection coefficient, Γ . Polar format markers display linear magnitude and phase.

[FORMAT]

[POLAR]

Non-linear measurements

These measurements, with the exception of gain compression, are not usually associated with network analyzers. However, the HP 8753 offers some added capabilities which allow some non-linear measurements to be made. Due to the nature of non-linear measurements, measurement calibrations are not applicable. The exception is gain compression measurements where frequency response errors can be removed from the system.

Gain compression

There are two ways to measure amplifier gain compression using the HP 8753. The first method, swept frequency gain compression, shows how to find the frequency at which 1 dB gain compression first occurs. The second method, swept power gain compression, shows the reduction in gain as a power ramp is applied to the amplifier under test.

Swept frequency gain compression

This measurement allows the user to easily determine the frequency at which 1 dB gain compression first occurs (Figure 12). This is accomplished through normalization to the small signal gain and by observing compression as the drop from the reference line as input power is increased. This frequency can in turn be used as the fixed frequency for a swept power compression measurement, discussed in the next section.

The output power of the amplifier can be displayed on channel 2 to easily determine P_{1dB} . Also, a power meter calibration, available with the HP 8753B, improves the accuracy of this measurement by setting input power precisely. For a discussion of power meter calibration, see the *HP 8753B System Operating and Programming Manual*.

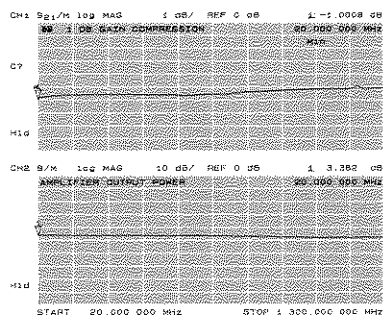

Figure 12. Swept frequency gain compression measurement.

Measurement procedure

1. Connect the instrument as shown in Figure 13. Preset the instrument. Channel 1 will display the frequency for which 1 dB gain compression first occurs. Channel 2 will display amplifier output power to allow easy determination of the 1 dB gain compression output power.
2. Set measurement stimulus parameters.
3. Since the output power of an amplifier is important, the loss through the test set between the amplifier output and the receiver input needs to be characterized. To do this, first perform a response calibration on channel 2 as shown in Figure 13.

NOTE: When using the HP 85044 test set, steps 3 and 4 can be omitted since the amplifier's output is connected directly to the HP 8753 receiver input.

```
[CH 2]
[MEAS]
[S21 [B/R]]
[CAL]
[CALIBRATE MENU]
[RESPONSE]
[THRU]
[DONE]
```

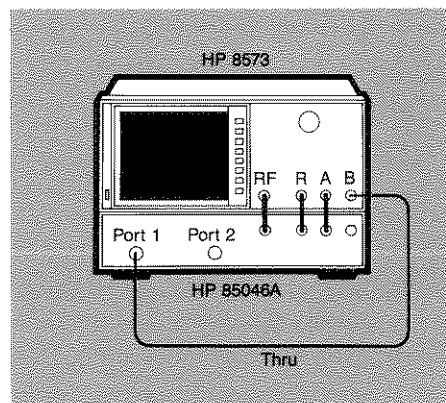

Figure 13. Setup for calibration to input B.

4. Connect the standard configuration without the amplifier (see Figure 3) and measure the signal path between port 2 to input B. Use this data to normalize the display to the actual output power of the amplifier, which is the power incident at port 2 of the test set.

```
[DISPLAY]
[DATA → MEM]
[MEAS]
[INPUT PORTS]
[B]
[DISPLAY]
[DATA/MEM]
5. Calibrate channel 1 for gain measurements.
[CH 1]
[CAL]
[CALIBRATE MENU]
[RESPONSE]
[THRU]
[DONE]
```

5B. (Optional for the HP 8753B only) For increased accuracy, also perform a power meter calibration at port 1 to remove source and test set non-linearities with frequency. Attach the HP 438A power meter to port 1 of the test set. Also, connect HP-IB as shown in Figure 14. Make sure the power meter model and address is known by the HP 8753. Before proceeding, zero the power meter.

```
[LOCAL]
[SYSTEM CONTROLLER]
[SET ADDRESSES]
[ADDRESS: P MTR/HPIB] [15] [x1]
[PWR MTR: [438A/437/436A]]
Toggle to select desired power meter.
[CAL]
[PWR METER]
[NUMBER OF READINGS] [1] [x1]
[PWRMTR CAL: ONE SWEEP]
Set the desired power at port 1 of the HP 8753B and take the cal sweep.
(Cal power) [-20] [x1]
[TAKE CAL SWEEP]
```

A "Power Meter Calibration Sweep Done" prompt will appear when the calibration sweep is completed. Reconnect Figure 3.

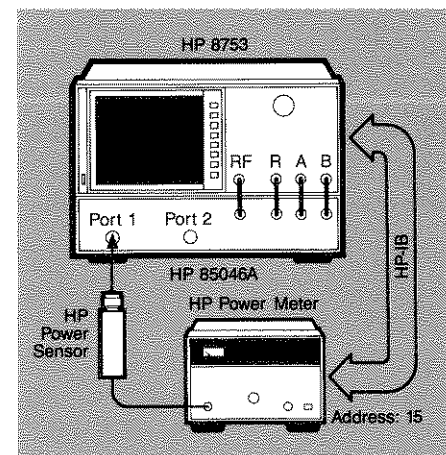

Figure 14. Setup for power meter calibration at amplifier input.

6. Connect the amplifier, apply bias, and turn on dual channel split display.

[DISPLAY]
[DUAL CHAN ON off]

7. Normalize the trace to the small signal gain. The new trace should be a flat line at 0 dB.

[DISPLAY]
[DATA → MEMORY]
[DATA/MEMORY]

8. Scale the display to allow easy observation of a 1 dB drop from the small signal gain.

[SCALE REF]
[SCALE/DIV] [1] [x1]
[REFERENCE VALUE] [0] [x1]

9. Use the rotary knob to increase the source power level until the trace drops by 1 dB at some point. A marker can then be used to track the exact frequency where 1 dB compression first occurs. Care should be taken when increasing the source power so that the input power limitation of the amplifier under test is not exceeded. Channel 2 displays the actual output power of the amplifier since the test set loss has been removed.

[MKR FCTN]
[MARKER SEARCH]
[TRACKING ON off]
[SEARCH: MIN]
[MENU]
[POWER]

Adjust power for 1 dB compression.

Swept power gain compression

By applying a fixed frequency power ramp to the input of an amplifier and investigating gain, gain compression is observed as a 1 dB drop from small signal gain. The fixed frequency chosen could be, for example, the frequency for which 1 dB compression first occurs in a swept frequency gain compression measurement. As with the swept gain compression measurement of the previous section, channel 2 displays the output power of the amplifier in order to easily determine P_{1dB} .

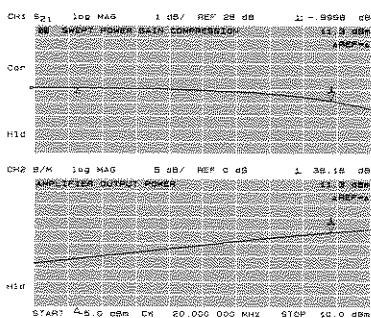

Figure 15. Swept power gain compression measurement.

Measurement procedure

1. Connect the instrument as shown in Figure 14 and preset the instrument. Channel 1 will display the amplifier's response to a power ramp. Channel 2 will display amplifier output power to allow easy determination of the 1 dB gain compression output power.

[PRESET]

2. Select a power sweep at the fixed frequency of interest. This could be the frequency at which 1 dB gain compression first occurs for a swept frequency gain compression measurement.

[MENU]
[SWEEP TYPE MENU]
[POWER SWEEP]
[RETURN]
[CW FREQ] [20] [M/u]

3. Set the stimulus parameters. Power levels must be set so that the amplifier is forced into compression. The range of the HP 8753's source is from -5 to +20 dBm. An external output attenuator may be required to prevent overdriving input B.

[MEAS]
[S21 [B/R]]
[START] [-5] [x1]
[STOP] [10] [x1]
[MENU]
[POWER]
[ATTENUATOR PORT 1] [20] [x1]

4. Since the output power of the amplifier is important, the loss through the test set between the amplifier output and the receiver input needs to be characterized.

To do this, first perform a response calibration on channel 2 as shown in Figure 13.

NOTE: When using the HP 85044 test set, steps 4 and 5 can be omitted since the amplifier's output is connected directly to the HP 8753 receiver input.

[CH 2]
[MEAS]
[S21 [B/R]]
[CAL]
[CALIBRATE MENU]
[RESPONSE]
[THRU]
[DONE]

5. Connect the standard configuration without the amplifier (see Figure 3) and measure the port 2 to input B path. Use this data to normalize the display to the actual output power of the amplifier, which is the power incident at port 2 of the test set.

[DISPLAY]
[DATA → MEM]
[MEAS]
[INPUT PORTS]
[B]
[DISPLAY]
[DATA/MEM]

6. Calibrate channel 1 for gain measurements.

[CH 1]
[CAL]
[CALIBRATE MENU]
[RESPONSE]
[THRU]
[DONE]

7. Reconnect the amplifier, apply bias, and turn on dual channel split display. Gain versus input power will be displayed on channel 1 and absolute output power will be displayed on channel 2.

[DISPLAY]
[DUAL CHAN ON off]

8. Move a marker to the flat portion of the trace (if there is no flat portion, the amplifier is in compression throughout the sweep, and power levels must be decreased). Use the marker search to find the power for which a 1 dB drop in gain occurs.

[MKR]

Position the marker in the flat gain portion of the trace.

[SCALE REF]
[MARKER → REFERENCE]
[SCALE/DIV] [1] [x1]
[MKR]
[MKR ZERO]
[MKR FCTN]
[MKR SEARCH]
[TARGET] [-1] [x1]
[MKR]
[Δ MODE MENU]
[Δ MODE OFF]

The 1 dB gain compression output power should be displayed on channel 2.

Non-linear measurements with the HP 8753B

Swept harmonic levels (Option 002)

Traditionally, harmonic measurements are made with a spectrum analyzer at several CW frequencies. Many frequencies must be tested for complete characterization, which can dramatically increase test time. With the HP 8753B, however, you can make swept frequency (and power) second and third harmonic response measurements. This capability provides "real-time" update of the measured harmonic response versus frequency.

Harmonic response measurements on the HP 8753B are made using the channel trace math functions to normalize the harmonic response to the fundamental response. In this manner, the harmonic response of the device under test can be displayed directly in dBc (see Figure 16).

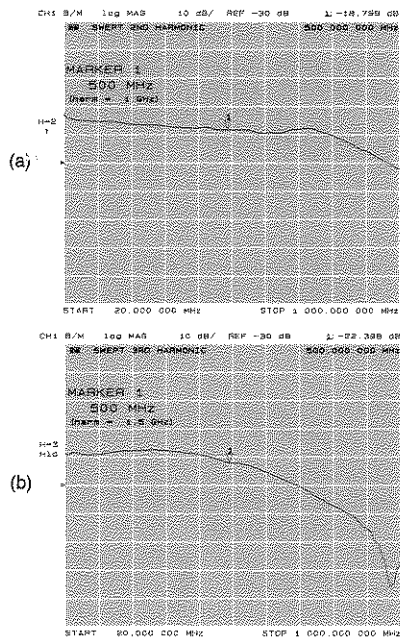

Figure 16. Swept harmonic response measurement: (a) 2nd harmonic dBc and (b) 3rd harmonic dBc.

The HP 8753B can measure the second harmonic response of a fundamental signal up to 1.5 GHz, and third harmonic response of a 1 GHz fundamental. The HP 8753B with 6 GHz capability, option 006, allows measurements of frequencies up to 6 GHz. So for second harmonic measurements, the fundamental frequency can be up to 3 GHz, while for third harmonic measurements, the fundamental frequency can be up to 2 GHz.

The test setup for measuring the harmonic response of an amplifier can be made with the same connections that were employed for all the linear measurements (see Figure 3).

Measurement procedure

1. Set up the instrument as shown in Figure 3. Notice that a 20 dB external attenuator at the amplifier's output serves to reduce the power level incident on the receiver. This protects against overloading and reduces the harmonics generated by the receiver.
2. Preset the instrument.
 - [PRESET]
3. Measure input port B.
 - [MEAS]
 - [INPUT PORTS]
 - [B]
 - [FORMAT]
 - [LOG MAG]
4. Set the source power level and port 1 attenuation such that the amplifier operates in its linear region. Remember that the source output power level affects the uncertainty of harmonic measurements.
 - [MENU]
 - [POWER] [-5] [x1]
 - [ATTENUATOR PORT 1] [10] [x1]
5. Set the desired start and stop fundamental frequencies. Frequencies greater than 16 MHz must be used.
 - [START] [20] [M/u]
 - [STOP] [1] [G/n]
6. Apply bias to the amplifier.
7. Configure channel 2 like channel 1.
 - [CH 2]
 Repeat step 3.

8. Display the fundamental response of the amplifier for optimum viewing.
 - [SCALE REF]
 - [REFERENCE POSITION] [10] [x1]
 9. Uncouple the channels to allow second or third harmonic responses in dBc.
 - [MENU]
 - [COUPLED CH on OFF]
 10. Normalize the trace to the fundamental response.
 - [DISPLAY]
 - [DUAL CHAN ON off]
 - [MORE]
 - [SPLIT DISP on OFF]
 - [MORE]
 - [D2/D1 to D2 ON off]
 A flat line should now be displayed at 0 dB.
 11. Use the harmonic mode menu to view the second and third harmonic responses in dBc.
 - [SYSTEM]
 - [HARMONIC MEAS]
 View the second harmonic response (see Figure 16-a).
 - [SECOND]
 Now view the third harmonic response (see Figure 16-b).
 - [THIRD]
 An "H=2" or "H=3", respectively, will appear to the left of the display. Markers display both the fundamental and corresponding harmonic frequencies. Return to the fundamental response.
 - [HARMONIC OFF]
 If the trace appears noisy, you are near the noise floor of the HP 8753B. This noise floor can be lowered by narrowing the IF bandwidth.
 - [AVG]
 - [IF BW]
 Enter a lower value for the IF bandwidth.
- Often, when making harmonic response measurements, it is important to accurately know the power level entering the device under test. The HP 8753B power meter calibration procedure can be used to level the source power at the amplifier input.

Two-tone third order intermodulation

Intermodulation distortion (IMD), like harmonic distortion, describes nonlinearities of an amplifier. Two-tone intermodulation products are generated when two incoming signals enter the amplifier and interact to produce IMD products.

Corresponding to each IMD product is a theoretical *Intercept Point* of order i . This term is often used to specify the IMD performance of an amplifier. Because of the proximity of the third order ($i = 3$) products to the fundamental frequencies, these are of greatest concern. Assuming the two input signals are of equal magnitude, the third order intercept point, TOI, is then calculated from:

$$TOI = P_0 + (P_0 - P_3)/2$$

(all quantities in dBm) where:

P_0 = output power of the individual test frequencies

P_3 = output power of the third order IMD product

This measurement must be performed in the linear operating region of the amplifier to ensure a correct intercept point calculation (see Figure 17).

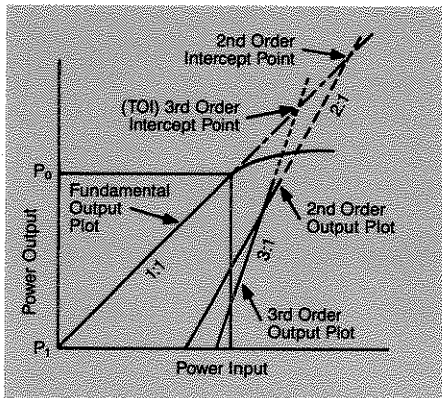

Figure 17. Plot for intercept point calculation.

In the tuned receiver instrument mode, the HP 8753B displays IMD in a similar fashion to a spectrum analyzer (see Figure 18). Because the HP 8753B's receiver tunes to a frequency without phaselocking, it is necessary to use synthesizers to ensure precisely known CW input signals.

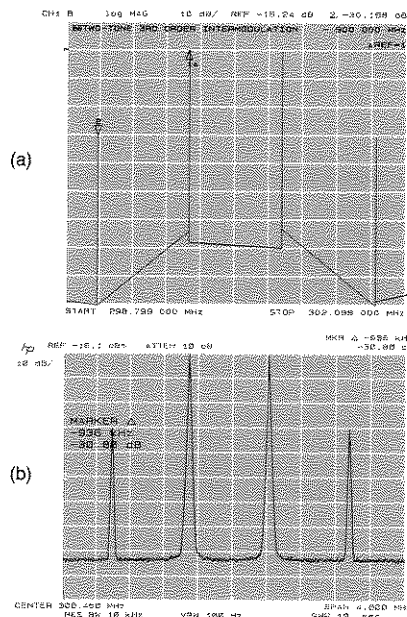

Figure 18. Two-tone IMD measurement (a) using the HP 8753B and (b) using a Spectrum Analyzer.

The measurement setup is shown in Figure 19. The two synthesizers used were HP 8656Bs. Attenuators are used to ensure the individual fundamental power levels at the receiver input are below -20 dBm.

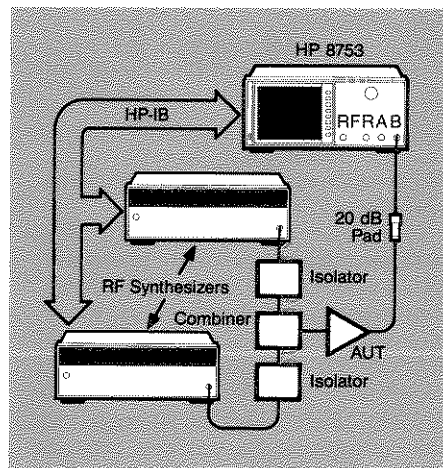

Figure 19. Two-tone third order intermodulation measurement setup.

Measurement procedure

1. Connect the instruments as shown in Figure 19. Connect the external frequency references together to synchronize the measurement frequencies. Preset the HP 8753B.

[PRESET]

2. Preset the synthesizers and then select CW frequencies, f_1 and f_2 . In the example, $f_1 = 300$ MHz and $f_2 = 300.9$ MHz. Also, set the power on both instruments to the same level.

3. Reduce the IF bandwidth of the HP 8753B receiver to lower the noise floor of the trace.

[AVG]
[IF BW]
[100] [x1]

4. Set up a frequency list for the four frequencies of interest: f_1 , f_2 , $2f_1 - f_2$, and $2f_2 - f_1$. Five points are chosen to ensure detection of the desired signals at the four frequencies.

[MENU]
[SWEEP TYPE MENU]
[EDIT LIST]
[ADD]
[CENTER] [#] [M/u]
[SPAN] [2] [k/m]
[NUMBER OF POINTS] [5] [x1]
[DONE]

where # refers to the four frequencies of interest. The example frequencies are 299.1 MHz, 300 MHz, 300.9 MHz, and 301.8 MHz. Step 4 must be repeated for each frequency.

NOTE: If the third order products are unequal in magnitude or any of the signals appear unstable, vary the frequencies used slightly. The HP 8753B Operating and Programming Manual gives a listing of frequencies that should be avoided.

5. Enter two other frequency segments to allow better viewing of the frequencies of interest on the display.

[ADD]
[CENTER] [#] [M/u]
[SPAN] [2] [k/m]
[NUMBER OF POINTS] [1] [x1]
[DONE]
[DONE]
[LIST FREQ]

where # refers to 298.9 and 302 MHz.

6. Place the instrument in tuned receiver mode.

[SYSTEM]
[INSTRUMENT MODE]
[TUNED RECEIVER]

7. Third order IMD should now be displayed on the HP 8753B's display. To calculate the third order intercept point, TOI, use the equation:

$$TOI = P_0 + (P_0 - P_3)/2$$

Remember to account for any padding between the amplifier's output and the HP 8753B. For the example measurement shown in Figure 18, since P_0 is about +4.8 dBm and $(P_0 - P_3)$ is 30.2 dB, TOI is calculated as 19.9 dBm.

Enhanced manufacturing techniques

Limit lines

The limit line feature of the HP 8753 network analyzer allows arbitrary limit values to be entered on the screen for direct comparison with the measured data (see Figure 20). Up to 15 limit segments can be added per channel as single points, flat lines, or sloped lines. Each segment contains an upper and lower limit and a starting stimulus value. Results are displayed with a *PASS/FAIL* message, and an optional beep upon failure. For example, gain over a certain frequency range can be tested by using a flat limit line with a lower limit set to the minimum gain allowable and an upper limit set to the upper gain value. This allows testing of both minimum gain and gain ripple simultaneously. The following procedure describes how to use limit lines to perform this test.

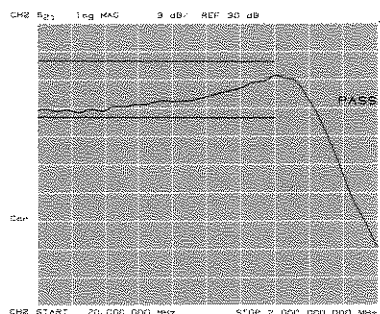

Figure 20. Limit lines example.

Measurement procedure

1. Perform the small signal gain measurement.
2. Enter the limit line menu.
[SYSTEM]
[LIMIT MENU]
[EDIT LIMIT LINE]
3. Enter the stimulus value as well as the upper and lower amplitude limits for your limit line.
[ADD]
[STIMULUS VALUE]
[20][M/u]
[LOWER LIMIT]
[20][x1]
[UPPER LIMIT]
[26][x1]
[DONE]
4. Define the type of limit line to be used.
[LIMIT TYPE]
[FLAT LINE]
[RETURN]

5. The flat line segment is valid from its stimulus value to the end of the frequency sweep range. To shorten its range, terminate the segment with a corresponding single point.

- ```
[ADD]
[STIMULUS VALUE]
[1.4][G/n]
[DONE]
[LIMIT TYPE]
[SINGLE POINT]
[RETURN]
[DONE]
```
6. Repeat steps 3 to 5 until all desired limit lines are entered.
  7. Turn on limit lines.  
[LIMIT LINES ON off]
  8. Activate PASS/FAIL limit testing.  
[LIMIT TEST ON off]

## Test sequence function (HP 8753B)

The amplifier measurements covered in this note are typical of those made in manufacturing environments. The HP 8753B test sequence function increases throughput by automating the test procedure. This is accomplished by simply performing the measurement manually from the front panel while in the test sequence mode. Figure 21 shows a sample sequence for the swept harmonic levels measurement.

In addition to throughput, the chances of operator error are reduced when using sequencing. Also, since no external controllers are required, no time is wasted learning instrument control commands, and in some cases, a new programming language.

Each sequence can be up to 2000 bytes, or about 200 lines in length. With the ability to call other sequences, complex tasks can be easily handled. Limited decision making is possible, such as *IF LIMIT TEST PASS THEN DO SEQUENCE*. The test sequence function can also control other HP-IB programmable instruments. For example, optimize harmonic levels with respect to bias by using a sequence to automatically control a power supply. Refer to the *HP 8753B System Operating and Programming Manual* for a complete discussion of the test sequence function.

```
SEQUENCE HARMONIC
Start of Sequence
RECALL PRST STATE
B
LOG MAG
POWER
-5 x1
ATTENUATOR PORT 1
10x1
START
20M/u
STOP
1 G/n
SCALE/DIV
REFERENCE VALUE
-100 x1
CH 2
B
SCALE/DIV
REFERENCE POSITION
10x1
COUPLED CH
OFF
DUAL CHAN
ON
SPLIT DISP
OFF
D2/D1 t0D2
ON
HARMONIC SECOND
```

Figure 21. Swept harmonic levels sequence.

# Accuracy considerations

## Linear measurements

This section summarizes key accuracy considerations for the measurements described in this note. Vector accuracy enhancement can be applied to the linear measurements discussed to greatly reduce measurement uncertainty. This is accomplished by removing systematic errors through measurement calibration with standards such as a short, an open, and a thru.

To illustrate the differences between the various accuracy enhancement techniques, the following amplifier characteristics were assumed.

- Gain: 22 dB
- Reverse isolation: 45 dB
- Input SWR: 3.0
- Output SWR: 2.2

An HP 85046A test set and 3.5 mm calibration accessories are used in these examples. For a complete table of uncertainty improvements resulting from various calibration procedures, see the *HP 8753 System Operating and Programming Manual*.

## Gain

The major sources of error in a gain measurement with the HP 8753 network analyzer are the frequency response of the test setup, the source and load mismatch during measurement, and the system dynamic accuracy. The frequency response of the test setup is the dominant error in a transmission measurement. A simple response calibration significantly reduces this error. For greater accuracy, a full 2-port calibration can be used.

Mismatch uncertainties are a function of effective source and load mismatches. A full 2-port calibration not only reduces the effects of frequency response, it also improves the effective source and load match. An example illustrates the accuracy improvements of a full 2-port calibration over a response calibration.

Total measurement uncertainty of gain (worst case)<sup>1</sup>:

Response calibration:  $\pm 1.4$  dB

Full 2-port calibration:  $\pm 0.3$  dB

Dynamic accuracy, a measure of the tuned receiver's performance as a function of incident power level, also influences the uncertainty of gain measurements. This is due to the fact that a receiver usually sees a different power level between calibration and measurement. The dynamic accuracy of the HP 8753 is typically  $\pm 0.02$  dB over a 50 dB range ( $-10$  dBm to  $-60$  dBm).

## Reverse isolation

Isolation is subject to the same error considerations as gain. In addition, if the isolation of the amplifier under test is very large, the transmitted signal level may be near the noise floor and/or crosstalk level. To lower the noise floor, employ averaging or reduce the IF bandwidth of the HP 8753. When crosstalk levels affect the measurement accuracy, a response and isolation calibration or a full 2-port calibration removes the crosstalk error term.

## Gain versus time

Since the gain drift measurement described in this note is a fixed frequency gain measurement over time, it is subject to the error considerations discussed for gain. Another factor that could be significant in this type of measurement is the transmission tracking drift of the test setup. This is primarily caused by a change in the test setup temperature between calibration and measurement. If the instrument is allowed to stabilize to the ambient temperature before calibration and measurement, this error term should be small.

## Deviation from linear phase

Transmission phase uncertainty is calculated from a comparison of the magnitude uncertainty, previously discussed for gain measurements, with the test signal magnitude. The typical size of this uncertainty is best illustrated with an example.

Total measurement uncertainty of phase (worst case)<sup>1</sup>:

Response only calibration:  $\pm 9.4^\circ$

Full 2-port calibration:  $\pm 2.2^\circ$

## Reflection measurements

The uncertainty of reflection measurements is affected by directivity, source match, load match, and the reflection tracking of the test system. With a full 2-port calibration, the effects of these factors are minimized. A 1-port calibration provides the same accuracy if the output of the amplifier is well terminated. An example using the amplifier described earlier best illustrates this improvement. Total measurement uncertainty of input return loss (worst case)<sup>1</sup>:

Response only calibration:  $\pm 3.0$  dB

Full 2-port calibration:  $\pm 0.6$  dB

Since the magnitude of the mismatch uncertainty depends on the input and output match of an amplifier, a measurement of a better matched amplifier will contain less uncertainty.

<sup>1</sup>NOTE: For the complete uncertainty equations, see the *General Information and Specifications* section of the *HP 8753B System Operating and Programming Manual*.

## Non-linear measurements

The non-linear measurements discussed in this note make use of the HP 8753's receiver to measure absolute power. Vector accuracy enhancement is not applicable to power measurements. Uncertainties for these measurements are affected by the previously mentioned sources of error. Thus, care should be taken to reduce mismatch effects since mismatch errors contribute to total measurement uncertainty. For absolute power measurements, additional uncertainty is introduced by the receiver power accuracy. The tuned receiver of the HP 8753 is accurate to  $\pm 1$  dB in absolute amplitude measurements over the 300 kHz to 3 GHz frequency range (typically  $< \pm 0.5$  dB). From 3 to 6 GHz with the HP 8753B, the receiver is accurate to  $\pm 3$  dB (typically  $\pm 1$  dB). One method of increasing the accuracy of absolute power measurements is to reference the receiver inputs with a power meter. In this manner, the receiver can be characterized and the measured data improved.

Remember that when using the HP 85046/7A test sets, there is uncertainty in the amount of insertion loss from the output of the amplifier under test to the receiver input on the HP 8753. For maximum accuracy in absolute power level measurements, this loss must also be characterized and removed from the measurement. See the *Swept Frequency Gain Compression Measurement Procedure* for a discussion on how to remove this loss from the system.

### Gain compression

Gain compression measurements employ response calibrations to reduce uncertainties. Be aware, however, that to determine swept frequency gain compression, the source power level must be changed. The HP 8753's source linearity is  $\pm .2$  dB from  $-5$  to  $+15$  dBm. Therefore, the validity of the response calibration is reduced when varying source power for swept frequency measurements. Source linearity uncertainty can be reduced for swept power gain compression measurements by performing a power meter calibration at the input of the amplifier. This precisely sets the power level incident to the amplifier under test by compensating the source power for any nonlinearities in the source or test setup.

### Swept harmonic levels (HP 8753B)

For harmonic distortion measurements, it is important to note that the source and the receiver of the HP 8753B generate their own harmonics. The level of these additional harmonics affects the range and uncertainty of harmonic measurements. The HP 8753B is capable of making up to 40 dBc harmonic measurements with a source power level of 0 dBm, and a power level of  $-20$  dBm or lower, incident on the receiver. Increasing the source power level and/or the power level incident on the receiver reduces the range of harmonic levels that can be measured. Performance for different source and receiver levels is specified in the *HP 8753B Data Sheet* (HP lit no. 5956-4335) and in the *HP 8753B System Operating and Programming Manual*.

With harmonic measurements, measurement calibration is not used, since the harmonic and fundamental frequencies are different. Instead, the absolute values of the amplifier's fundamental and harmonic levels are compared using the  $D2/D1$  to  $D2$  trace math function.

### Two-tone third order intermodulation (HP 8753B)

A power combiner should be used for two-tone IMD measurements to sufficiently isolate the sources. In some situations, it may be necessary to further isolate the sources with amplifiers. Attenuators can be used to reduce mismatch errors. In cases where source harmonics affect the intermodulation response, low pass filtering can be inserted between the amplifier and the signal sources to reduce their harmonics.

# Appendix : S-parameter test set considerations

When configuring a test setup for amplifier measurements, knowledge of power levels through the various signal paths is vital. This appendix describes the HP 85046A (300 kHz to 3 GHz) and 85047A (300 kHz to 6 GHz) 50 ohm S-parameter test set, and explicitly shows the signal paths and power levels through them. The actual power levels available at the test ports of the HP 8753/S-parameter test set system are listed in Table 1. Finally, an example is presented to clarify attenuator and power level requirements for a particular amplifier.

Figure 22 shows a schematic representation of the HP 85046A S-parameter test set and lists the attenuation from the RF input (0 dB reference point) to the other ports. The same is done in Figure 23 for the HP 85047A.

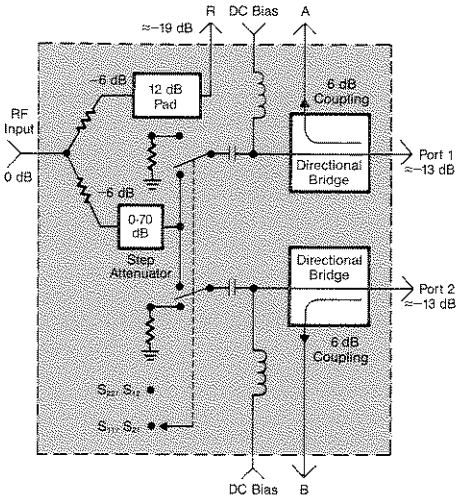

Figure 22. Schematic of the HP 85046A S-Parameter Test Set.

**NOTE:** This appendix describes the HP 85046A and the HP 85047A only. The HP 85046B 75 ohm S-parameter test set and other signal separation device, such as the HP 85044A/B transmission/reflection test set, have different insertion losses and should be considered separately. Some important parameters of the HP 8753 test system:

- Source power range = +20 dBm to -5 dBm
- Receiver input ranges: (best accuracy when signal levels are kept below -10 dBm)  
R channel = 0 dBm to -35 dBm  
A, B channel = 0 dBm to -100 dBm

The following example illustrates the general procedure for choosing attenuator levels and source power.

**Example:** Measuring the small signal gain of an amplifier, using the HP 8753/HP 85046A test system.

**Given:** The general test setup of Figure 3. Amplifier under test has the following parameters:

- gain of approx. 40 dB
- desired input power of -30 dBm

**Required:** To design a test setup and set operating parameters such that the amplifier operates in its linear region (i.e., input power < -30 dBm).

**Procedure:** Start with the amplifier's maximum input, -30 dBm. The input power must be less than this so that the amplifier is operating in its linear region. With the source power at its default value of 0 dBm, and a nominal loss through the test set to port 1 of 13 dB, the default power at port 1 is about -13 dBm. The step attenuator must therefore be used to decrease this power below -30 dBm. The step attenuator can be set in increments of 10 dB up to 70 dB, by setting [ATTENUATOR PORT 1] or [ATTENUATOR PORT 2] (depending on the direction of the measurement) in the HP 8753 power menu. Increasing the port 1 attenuation to 20 dB, changes the power level at port 1 (the amplifier input) to -33 dBm, which is about the required power limit.

Now consider the amplifier output. Since the output power is approximately 7 dBm (-33 dBm + 40 dB of gain) and the loss in the test set from port 2 to channel B is only about 6 dB, an external attenuator must be inserted before port 2 in order to keep input B below its maximum power level (0 dBm). A 20 dB pad at the amplifier output will keep the maximum power at B ≤ 19 dBm, which allows the receiver to operate in its most accurate range.

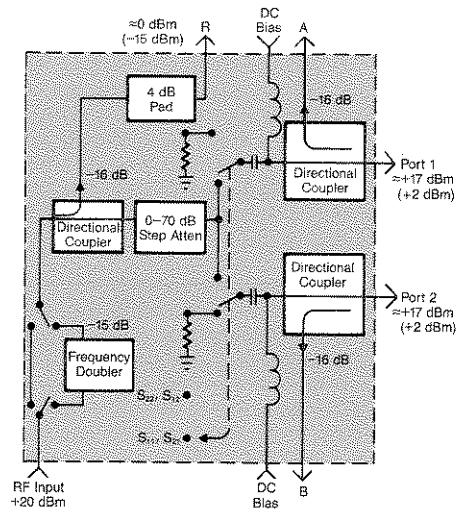

Figure 23. Schematic of the HP 85047A S-Parameter Test Set.

Table 1. Power available at the test ports with the HP 85046/7A S-Parameter Test Sets.

|                                                | HP 85046A Test Set | HP 85047A Test Set |         |
|------------------------------------------------|--------------------|--------------------|---------|
|                                                |                    | 3 GHz              | 6 GHz   |
| Maximum attenuation from RF input to port 1, 2 | 83 dB              | 73 dB              | 88 dB   |
| Minimum attenuation from RF input to port 1, 2 | 13 dB              | 3 dB               | 18 dB   |
| Maximum power level at port 1, 2               | +7 dBm             | +17 dBm            | +2 dBm  |
| Minimum power level at port 1, 2               | -88 dBm            | -78 dBm            | -93 dBm |
| Nominal attenuation from port 2 to channel B   | 6 dB               | 16 dB              | 16 dB   |

For more information, call your local HP sales office listed in your telephone directory or an HP regional office listed below for the location of your nearest sales office.

**United States:**

Hewlett-Packard Company  
4 Choke Cherry Road  
Rockville, MD 20850  
(301) 670-4300

Hewlett-Packard Company  
5201 Tollview Dr.  
Rolling Meadows, IL 60008  
(312) 255-9800

Hewlett-Packard Company  
5161 Lankershim Blvd.  
No. Hollywood, CA 91601  
(818) 505-5600

Hewlett-Packard Company  
2015 South Park Place  
Atlanta, GA 30339  
(404) 955-1500

**Canada:**

Hewlett-Packard Ltd.  
6877 Goreway Drive  
Mississauga, Ontario L4V1M8  
(416) 678-9430

**Japan:**

Yokogawa-Hewlett-Packard Ltd.  
29-21, Takaido-Higashi 3-chome  
Suginami-ku, Tokyo 168  
(03) 391-6111

**Latin America:**

Hewlett-Packard de Mexico  
S.p.A. de C.V.  
Monte Palvux No. 111  
Lomas de Chapultepec  
11000 Mexico D.F., Mexico  
(905) 596-7933

**Australia/New Zealand:**

Hewlett-Packard Australia Ltd.  
31-41 Joseph Street,  
Blackburn, Victoria 3130  
Melbourne, Australia  
(03) 895-2895

**Far East:**

Hewlett-Packard Asia Ltd.  
47/F China Resources Building  
26 Harbour Road, Hong Kong  
(5) 833-0833

**Germany:**

Hewlett-Packard GmbH  
Vertriebzentrale Deutschland  
Hewlett-Packard-Strasse  
Postfach 1641  
6380 Bad Homburg v.d.H.  
Federal Republic of Germany  
06172/400-0

**France:**

Hewlett-Packard France  
Parc d'activite du Bois Briard  
2, avenue du Lac  
91040 Evry Cedex  
01/60 77 83 83

**United Kingdom:**

Hewlett-Packard Ltd.  
Enquiry Group  
Customer Support Centre  
Eskdale Road  
Winnersh Triangle  
Wokingham  
Berkshire RG11 5DZ  
0734/69 66 22

**Italy:**

Hewlett-Packard Italiana S.p.A.  
Via G. di Vittorio, 9  
20063 Cernusco Sul Naviglio (MI)  
Milano  
02/923691

**Northern Europe:**

Hewlett-Packard S.A.  
Van der Hooplaan 241  
1185 LN Amstelveen  
P.O. Box 999  
1180 AZ Amstelveen,  
The Netherlands  
(31) 20/547 9999

**South East Europe:**

Hewlett-Packard S.A.  
World Trade Center  
110, Avenue Louis-Casar  
1215 Aeroport-Geneve  
Switzerland  
(41) 22/98 96 51

**Or write to:**

**United States:**

Hewlett-Packard Company  
P.O. Box 10301  
Palo Alto, CA 94303-0890

**Europe/Middle East/Africa:**

Hewlett-Packard Company  
Central Mailing Department  
P.O. Box 529  
1180 AM Amstelveen,  
The Netherlands

**For all other areas:**

Hewlett-Packard Company  
Intercontinental Headquarters  
3495 Deer Creek Rd.  
Palo Alto, CA 94304  
U.S.A.

# Product Note 8753-2



RF Component Measurements  
Mixer measurements using the  
HP 8753B Network Analyzer

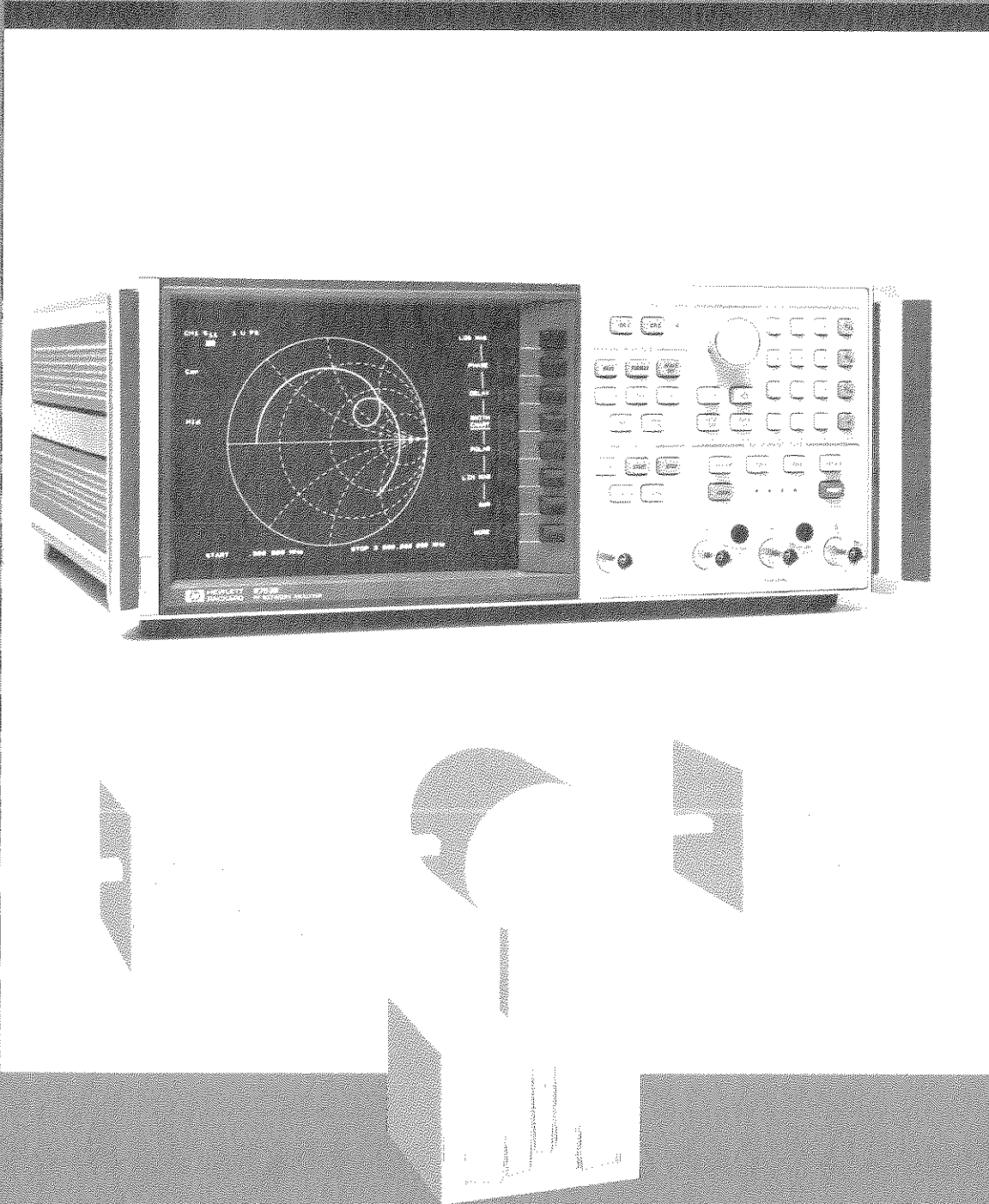

# Introduction

## Table of contents

|                                                       |    |
|-------------------------------------------------------|----|
| Introduction .....                                    | 2  |
| Mixer Term Definitions .....                          | 3  |
| Measurement Considerations .....                      | 4  |
| Mixer Measurements                                    |    |
| Conversion Loss .....                                 | 5  |
| Conversion Compression .....                          | 8  |
| Amplitude & Phase Tracking .....                      | 9  |
| Two-Tone Third Order Intermodulation Distortion ..... | 10 |
| Isolation .....                                       | 12 |
| SWR / Return Loss .....                               | 13 |
| Appendix                                              |    |
| Spur Analysis and Prediction .....                    | 14 |

This note describes several procedures and hardware setups for measuring the performance of a mixer or frequency translator using the HP 8753B vector network analyzer.

The measurements described in this note are conversion loss, conversion compression, amplitude and phase tracking, two-tone third order intermodulation distortion, isolation (feedthrough), and SWR.

Vector network analyzers have typically been used for measuring the transmission and reflection characteristics of linear components and networks. The HP 8753B simplifies and speeds the testing of non-linear devices such as mixers (the focus of this note) and amplifiers (see HP Product Note 8753-1, *Amplifier measurements using the HP 8753, Lit. No. 5956-4361*).

Traditionally, vector network analyzers working at a single stimulus and response frequency were unable to test the transmission characteristics of a mixer. The HP 8753B has the ability to offset or decouple its receiver from its own internal synthesized source. This enables you to stimulate a device over one frequency range and view its response over another. This, along with its vector network analyzer capabilities, makes the HP 8753B a significant enhancement to any environment where comprehensive mixer testing is required.

Because a mixer is a 3-port non-linear device it is impossible to take advantage of traditional 2-port vector accuracy enhancement. However, there are necessary considerations when making any mixer measurement: IF port filtering, to reduce the number of unwanted signals that enter the receiver, attenuation at all mixer ports, to reduce reflections, and frequency selection (frequency list mode). These techniques will be discussed in greater detail in the Measurement Considerations section of this note.

Throughout the procedures described in this note, front panel keys appear in bold type, e.g. [MENU]. Softkeys such as POWER appear in bold italics, e.g. [POWER].

### Typical equipment list used to make the measurements in this note

|                                                                  |                                                       |
|------------------------------------------------------------------|-------------------------------------------------------|
| Network analyzer                                                 | HP 8753B                                              |
| Transmission/Reflection test set                                 | HP 85044A                                             |
| External synthesized signal generator                            | HP 8656A/B<br>HP 8657A/8642A/B<br>could also be used. |
| Power meter HP-IB                                                | HP 436A/7B/8A                                         |
| Mixer Under Test                                                 | Mini-Circuits ZFM-15<br>or equivalent                 |
| Various cables, filters, amplifiers, connectors and attenuators. |                                                       |



# Mixer term definitions

## Conversion loss

Conversion loss is the measure of efficiency of a mixer. It is the ratio of sideband IF power to RF signal power, and is usually expressed in dB. The mixer translates the incoming signal, RF, to a replica, IF, displaced in frequency by the local oscillator, LO. This frequency translation exacts a penalty that is characterized by a loss in signal amplitude and the generation of additional sidebands. For a given translation, two equal output signals are expected, a lower sideband and an upper sideband (figure 1a).

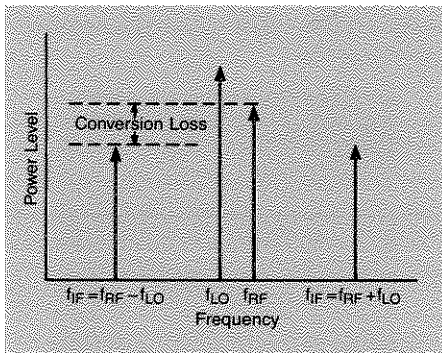

Figure 1a. Spectrum of RF, LO and IF signals present in mixer measurements.

## Conversion compression

Conversion compression is a measure of the maximum RF input signal level for which the mixer will provide linear operation. The conversion loss is the ratio of the IF output level to the RF input level, and this value remains constant over a specified input power range. When the input power level exceeds a certain maximum, the constant ratio between IF and RF power levels will begin to change. The point at which the ratio has decreased 1 dB is called the 1 dB compression point. See figure 1b.

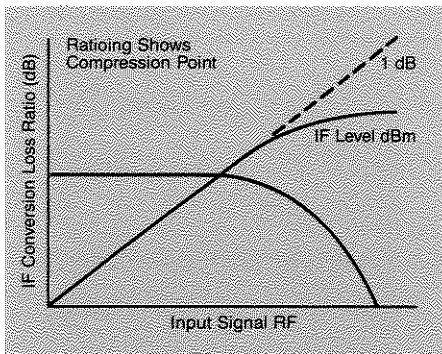

Figure 1b. Plot of conversion loss and IF output power as a function of RF input power level. Note that the IF output power increases linearly with the increasing RF signal, until mixer compression begins and the mixer saturates.

## Amplitude and phase tracking

The match between mixers is defined as the absolute difference in amplitude and/or phase response over a specified frequency range. The tracking between mixers is essentially how well the devices are matched over a specified interval. This interval may be a frequency interval or a temperature interval, or a combination of both.

## Third order intermodulation distortion

This term describes the distortion of the mixer's conversion loss, caused by two or more sinusoidal signals interacting at the mixer's RF port. The two-tone third order distortion term is the amount of the signal at the IF port of the mixer due to third order frequency terms. This is usually expressed relative to the desired IF mixing product, (dBc). These third order terms are given by  $(2RF1 - RF2) \pm LO$ , and  $(2RF2 - RF1) \pm LO$ .

- RF1 = Fixed RF frequency # 1.
- RF2 = Fixed RF frequency # 2.
- LO = Local oscillator frequency.

## Isolation

Isolation is the measure of signal leakage in a mixer. Feedthrough is specifically the forward signal leakage to the IF port. High isolation means that the amount of leakage or feedthrough between the mixer's ports is very small. Figure 1c diagrams the signal flow in a mixer.

The LO to RF isolation and the LO feedthrough are typically measured with the third port terminated in 50 ohms. Measurement of the RF feedthrough is made as the LO signal is being applied to the mixer.

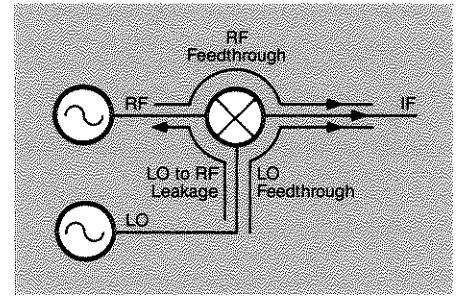

Figure 1c. Diagram showing the signal flow in a mixer. Note that RF and LO feedthrough signals may appear at the mixer IF output, together with the desired IF signal.

## SWR/Return loss

Reflection coefficient ( $\Gamma$ ) is defined as the ratio between the reflected voltage ( $V_r$ ) and incident voltage ( $V_i$ ). Standing wave ratio (SWR) is defined as the ratio of maximum standing wave voltage to the minimum standing wave voltage, and can be derived from the reflection coefficient ( $\Gamma$ ) using the equation shown below.

$$\Gamma = V_r / V_i$$

$$SWR = \frac{1 + |\Gamma|}{1 - |\Gamma|}$$

Return loss is equal to  $-20 \log |\Gamma|$ .

Because mixers are three-port devices, making a SWR measurement on one is more complicated than making a SWR measurement on a two-port device. The operating conditions the mixer will encounter during use should be the test levels at which the SWR measurements are made. For example, to make RF port SWR measurements, the LO must be connected and set at the desired frequency and power level, and the IF port must be terminated in 50 ohms.

# Measurement considerations

In mixer transmission measurements, you have RF and LO inputs and an IF output. Also emanating from the IF port are several other mixing products of the RF and LO signals. In mixer reflection measurements, leakage signals from one mixer port propagate and appear at the other two mixer ports. These unwanted mixing products or leakage signals can cause distortion by mixing with a harmonic of the HP 8753B's first down conversion stage. To ensure that measurement accuracy is not degraded, certain frequencies must be filtered or avoided by frequency selection. Attenuators placed at all mixer ports can be used to reduce mismatch uncertainties.

For frequency offset measurements made on the HP 8753B, it is necessary to choose the HP 8753B's source to supply the highest frequency in the measurement, whether it is being used to drive the RF or LO of the mixer. It is also necessary to configure the measurement so that the lowest frequency is incident upon the HP 8753B's receiver; this simply means measuring the lower of the two IF mixing products.

## Filtering

Proper filtering between the mixer's IF port and the receiver's input port can eliminate unwanted mixing and leakage signals from entering the analyzer's receiver. Figure 2a shows a plot of mixer conversion loss when proper IF filtering was neglected. Figure 2b shows the same mixer's conversion loss with the addition of a low pass filter at the mixer's IF port. Filtering is required in both fixed and broadband measurements, but will be more easily implemented in the fixed situation. Therefore, when configuring broadband (swept) measurements you may need to trade some measurement bandwidth for the ability to more selectively filter signals entering the HP 8753B's receiver.

## Attenuation at mixer ports

When characterizing linear devices, (single test frequency) vector accuracy enhancement can be used to mathematically remove all systematic errors, including source and load mismatches, from the measurement. This is not possible when the device you are characterizing is a mixer operating over multiple frequency ranges. Therefore, source and load mismatches are not corrected for and will add to overall measurement uncertainty.

As in a scalar measurement system, to reduce the measurement errors associated with the interaction between mixer port matches and system port matches, it is advisable to place attenuators at all of the mixer's ports. Figure 2c shows a plot of swept conversion loss where no attenuation at mixer ports was used. The ripple versus frequency is due to source and load mismatches. In contrast, figure 2b made use of appropriate attenuation at all mixer ports. Extra care should be given to the selection of the attenuator located at the mixer's IF port to avoid overdriving the receiver. For best results, the value of this attenuator should be chosen so that the power incident on the HP 8753B's receiver ports is less than  $-10$  dBm.

## Frequency selection

Choosing test frequencies (frequency list mode) can reduce the effect of spurious responses on measurements by avoiding frequencies that produce IF signal path distortion.

The first step in avoiding or eliminating spurs is determining at what frequencies they will occur. To aid you in predicting where these frequencies will occur, a spur prediction program is included in Appendix 1 of this note. Although this spur prediction program is specialized for the measurement of the swept IF/ fixed LO response of a mixer, it can easily be modified to accommodate other measurement configurations.

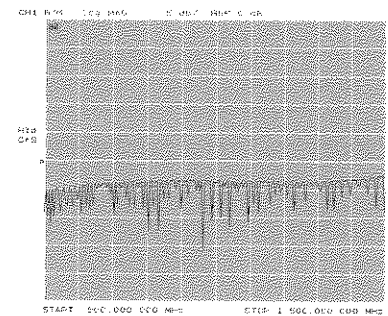

Figure 2a. Plot of a mixer's conversion loss vs. IF frequency without the use of appropriate IF signal path filtering, resulting in unusable data.

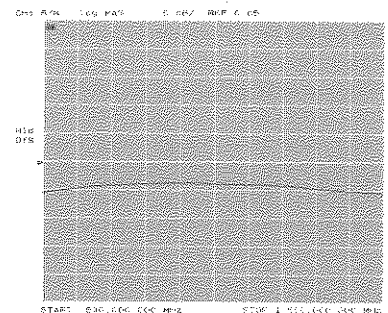

Figure 2b. Plot of a mixer's conversion loss vs. IF frequency with proper IF signal path filtering, and attenuation at all mixer ports.

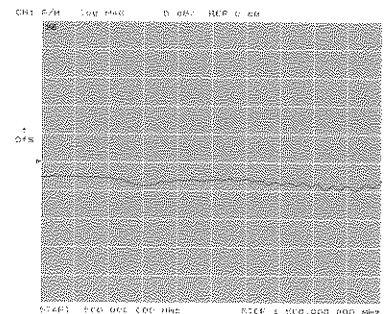

Figure 2c. Plot of a mixer's conversion loss vs. IF frequency neglecting attenuation at mixer ports. The frequency ripple seen is due to mixer and system port mismatches.

# Conversion loss

## Fixed IF conversion loss

The simplest of all conversion loss measurements is the fixed IF/fixed LO measurement where all three frequencies are held constant. Figure 3 shows the block diagram for a fixed IF/fixed LO conversion loss measurement.

The frequencies to be used in this measurement are:

- RF = 1400 MHz
- LO = 800 MHz
- IF = 600 MHz

In all conversion loss measurements, the IF and LO frequencies are entered directly as parameters, while the RF frequency is entered by adding the IF and LO frequencies using frequency offset mode.

### Frequency offset mode

This mode of operation allows you to offset the HP 8753B's source, by a fixed value, above the HP 8753B's receiver. This allows you to stimulate a device under test at one frequency and view its response at another frequency. This mode of operation has a RF source frequency limit of 3 GHz.

## Measurement procedure

1. Connect the instruments as shown in figure 3.

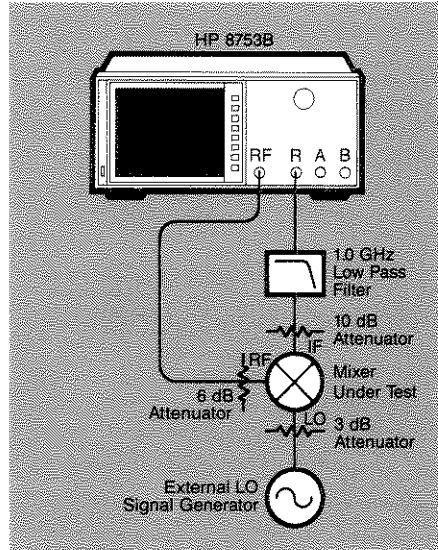

Figure 3. Block diagram for a fixed IF/fixed LO/fixed RF conversion loss measurement.

2. Press [PRESET] on the front panels of the HP 8753B and the local oscillator (LO) source.  
 3. From the front panel of the HP 8753B, set the desired IF frequency and RF source output power to be used.

```
[MENU]
[CW FREQ] [600] [M/μ]
[POWER] [6] [x1]
[MEAS]
[R]
```

4. On the external signal generator, select the desired LO frequency and power level to be used in this measurement.

```
[CW] [800] [MHz]
[POWER] [13] [dBm]
```

5. Turn frequency offset on to set up a constant offset between the IF and RF signals. This sets the RF source frequency.

```
[SYSTEM]
[INSTRUMENT MODE]
[OFFSET VALUE]
[800] [M/μ]
[FREQ OFFSET ON]
```

6. Figure 4 shows the attenuated output power of the mixer's IF at the receiver. The conversion loss of the mixer is found by subtracting the attenuation from the total loss between the RF source and IF receiver.

```
Source power = 6 dBm
Output power = -17.5 dB
Total loss = 23.5 dB
Total attenuation = 16 dB
Conversion loss = 7.5 dB
```

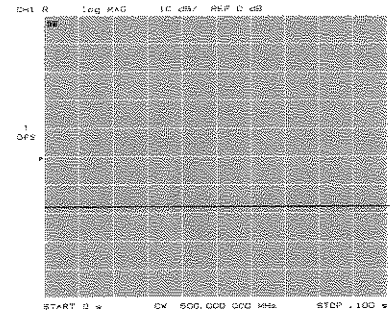

Figure 4. Plot of a mixer's fixed IF/fixed LO/fixed RF output power.

## Swept IF measurements

One of the primary contributions of the HP 8753B to mixer testing is its ability to make a swept IF conversion loss measurement. Frequency translators can also be measured using the techniques described in this note, for example the down converter module in figure 5.

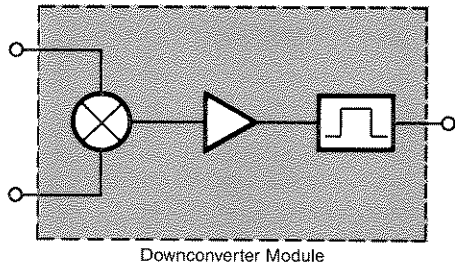

Figure 5. Block diagram of a typical downconverter module which can be characterized using the techniques described in this note.

## Measurement procedure

The following procedure describes the steps necessary to perform a swept IF conversion loss measurement, using the setups in figures 6 and 7. The first five steps in this procedure are used to measure the response of the IF signal path, so that its response can be mathematically removed from the conversion loss measurement that follows.

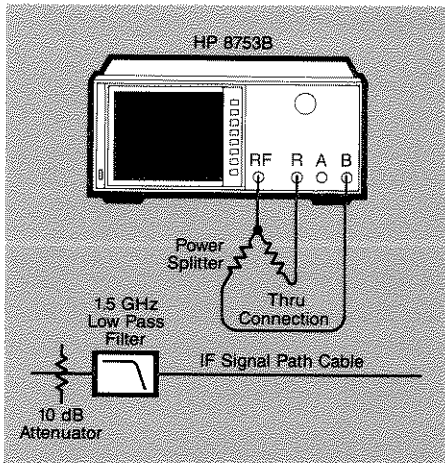

Figure 6. Block diagram for a B/R response calibration and device normalization.

1. Connect the hardware in figure 6 with a thru connection between the power splitter and the receiver's B port.

2. Press [PRESET] on the front panels of the HP 8753B and the local oscillator (LO) source.

3. From the front panel of the HP 8753B, set the desired IF frequency range and RF output power to be used in this measurement.

[START] [100] [M/μ]  
[STOP] [1.0] [G/n]  
[MENU]  
[POWER] [6] [x1]

4. Using the keystrokes shown below perform a frequency response calibration.

[MEAS]  
[B/R]  
[CAL]  
[CALIBRATE MENU]  
[RESPONSE]  
[THRU]  
[DONE: RESPONSE]

5. Leaving the thru cable in place connect the IF attenuator, filter, and cable between the power splitter and the receiver's B port. The IF low pass filter was chosen not only to eliminate unwanted mixing products from entering the analyzer's receiver, but also to pass the largest of the IF frequencies. Store the response into memory.

[DISPLAY]  
[DATA → MEMORY]

This step measures the frequency response of the components in the IF signal path, (attenuator, filter, and cable), and stores it into memory. This memory trace will be used to remove the frequency response of these components from the conversion loss measurement to be made with the setup in figure 7.

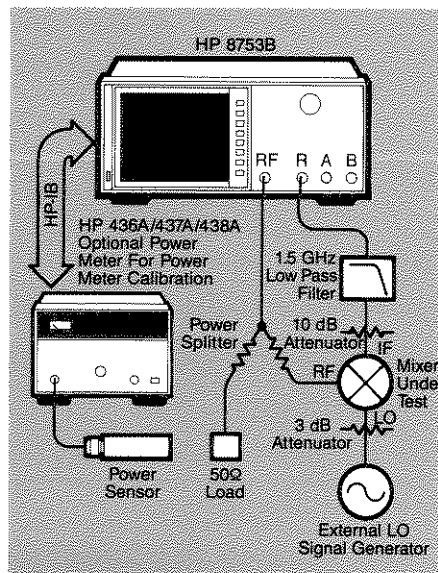

Figure 7. Block diagram for a swept IF/ fixed LO conversion loss measurement.

6. View the absolute input power to the R channel.

[MEAS]  
[R]

7. Connect the hardware as shown in figure 7, terminating the open port of the power splitter with a 50 ohm load.

8. Set the external local oscillator (LO) source to the desired fixed frequency and power level.

[CW] [1.5] [GHz]  
[POWER] [13] [dBm]

9. Remove the frequency response of the IF attenuator, filter, and cable from the measurement by viewing [DATA/MEM].

[DISPLAY]  
[DATA/MEM]

10. Turn frequency offset on to set a constant offset between the IF and RF signals. This sets the RF source's frequency range.

In this example, the RF frequency range is 1.6 GHz to 2.5 GHz.

[SYSTEM]  
[INSTRUMENT MODE]  
[OFFSET VALUE]  
[1500] [M/μ]  
[FREQ OFFSET ON]

11. Since the mixer's RF input power was chosen to be 0 dBm and the loss due to the IF components was removed, the resulting display shows the swept IF conversion loss of the mixer versus IF frequency. A plot of this is shown in figure 8.

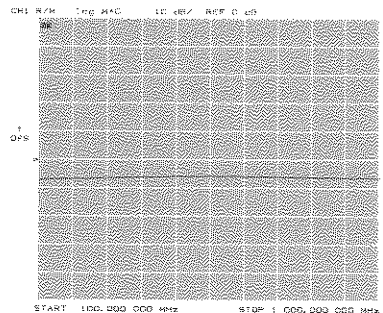

Figure 8. Plot of swept IF/ fixed LO conversion loss of a mixer.

## Optional procedure

To enhance measurement accuracy, replace the 50 ohm load at the power splitter with the power meter and power meter sensor, as shown in figure 7. Perform a one sweep power meter calibration. This will level the power splitter's output power to a user specified value over the frequency range of the measurement.

Zero the power meter. Prepare the HP 8753B to interface with the power meter.

```
[LOCAL]
[SYSTEM CONTROLLER]
[SET ADDRESSES]
[ADDRESS: P MTR/HP1B]
[#] [x1]
```

Press the power meter softkey (shown below) until the desired power meter has been chosen.

```
[POWER MTR: [438/437]]
Perform the power meter calibration.
[CAL]
[PWR METER]
[ONE SWEEP]
[CAL POWER] [0] [x1]
[TAKE CAL SWEEP]
```

Once this power calibration is complete the power at the mixer's RF port is leveled to 0 dBm.

Disconnect the power meter and terminate this open port with the 50 ohm load.

NOTE: For more information on power meter calibration see the HP 8753B System Operating and Programming Manual (08753-90119). For more information on power meter measurements and accuracy see the appropriate power meter manual.

## Conversion loss greater than 35 dB

Since the dynamic range of the receiver's R channel is limited, a modification of this procedure is required for conversion loss measurements where the R channel input is less than  $-35$  dBm. The measurement procedure is the same as for the conversion loss measurements previously discussed. Figure 9 shows the hardware configuration for this measurement. Note that the mixer under test is being measured on the B channel which has greater than 35 dB dynamic range, while the reference signal on channel R (used for phase lock) has been increased by an external amplifier.

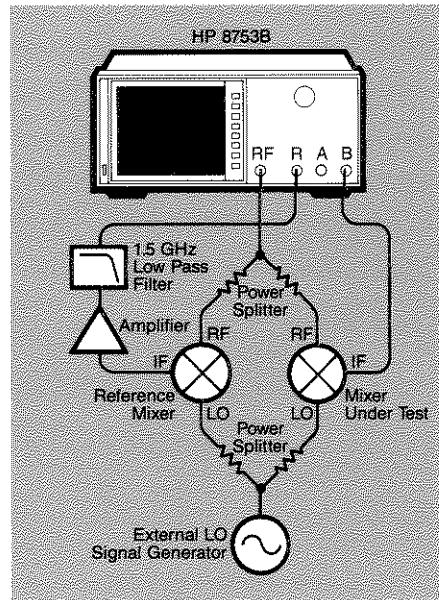

Figure 9. Block diagram for a conversion loss measurement greater than 35 dB.

## Fixed IF stepped LO & RF

An extension of the previous measurements is the case of fixed IF/stepped LO and RF frequencies. Figure 10 shows the hardware configuration for this fixed IF measurement. The simplest way to make this type of measurement without the use of an external controller is through the use of the HP 8753B's test sequence function. An excerpt from a sequence written to control two external synthesizers in tuned receiver mode appears below.

```
ADDRESS: PRINTER
19x1
ADDRESS: P MTR/HP1B
27x1
MANUAL TRG ON POINT
HOLD
CONTINUOUS
TITLE
AP130M;FA50MZ;FB1050MZ;ST2.85C;9M1
TITLE TO PRINTER
TITLE
AP100M;IW1;FA60MZ;FB106QZ;IN35QZ;Y1;CTY3;
TITLE TO P MTR/HP1B
LOOP COUNTER
21x1
DO SEQUENCE
SEQUENCE 2
```

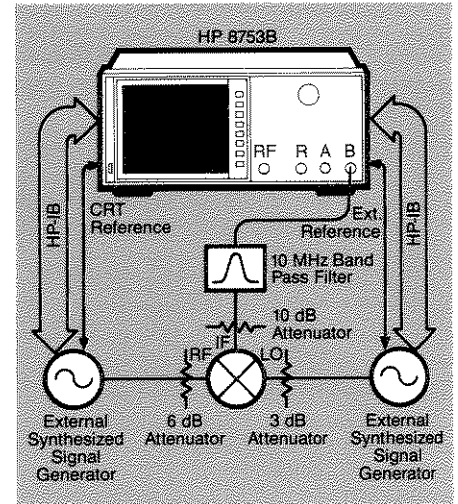

Figure 10. Block diagram for a Fixed IF stepped RF and LO measurement.

## Tuned receiver mode

In situations when the analysis of a specific signal or mixing product is necessary, the HP 8753B's tuned receiver mode allows you to tune the HP 8753B's receiver to an arbitrary frequency and analyze a signal without phase locking to it. This is only possible if the signal we wish to analyze is at an exact known frequency. Therefore, the RF and LO must be synthesized and synchronized with the HP 8753B's time base.

Figure 11 shows a plot of the stepped LO and RF fixed IF conversion loss of a mixer.

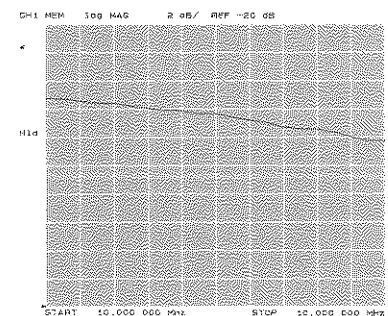

Figure 11. Plot of fixed IF/stepped LO and RF conversion loss of a mixer.

# Conversion compression

The following example uses a ratio of mixer output to input power to locate the mixer's 1 dB compression point. Included is an optional accuracy enhancement step using power meter calibration.

## Measurement procedure

1. Connect the HP 8753B's source through the 20 dB IF attenuator and low pass filter to the receiver's R port.
2. Press [PRESET] on the front panels of the HP 8753B and the LO source.
3. From the front panel of the HP 8753B set the desired fixed frequency, power range, and measurement specifications.

```
[MENU]
[SWEEP TYPE MENU]
[POWER SWEEP]
[RETURN]
[CW FREQ]
[700] [M/μ]
[START] [0] [x1]
[STOP] [15] [x1]
[MEAS]
[R]
```

4. Store a trace of receiver power vs. source power into memory and view [DATA/MEM]. This removes the loss between the IF port of a mixer and the receiver, and will provide a linear power sweep for use in subsequent measurements.

```
[DISPLAY]
[DATA → MEMORY]
[DATA/MEM]
```

5. Connect the instruments as shown in figure 12.

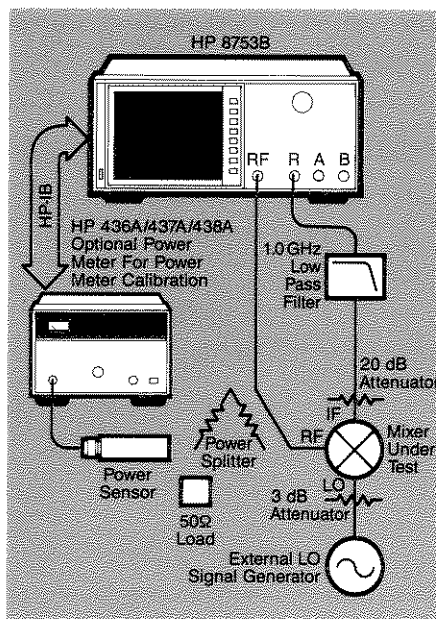

Figure 12. Block diagram for a conversion compression measurement.

6. Set the LO source to the desired fixed frequency and power level.
7. Turn on a frequency offset equal to the LO's fixed frequency. This specifies the RF source frequency.

```
[SYSTEM]
[INSTRUMENT MODE]
[OFFSET VALUE]
[800] [M/μ]
[FREQ OFFS ON]
```

8. The resulting display shows the mixer's output power as a function of its input power.

9. Set up an active marker to search for the 1 dB compression point of the mixer.

```
[SCALE REF]
[AUTO SCALE]
[MKR]
```

Move the marker to a point of zero slope on the trace (zero slope indicates the mixer's linear region of operation).

```
[MKR ZERO]
[MKR FCTN]
[MKR SEARCH ON]
[TARGET]
[-1] [x1]
[MKR]
[Δ MODE MENU]
[Δ MODE OFF]
```

The following display (figure 13) shows the mixer's 1 dB compression point. By changing the target value, you can easily locate other compression points (e.g., 0.5 dB, 3 dB).

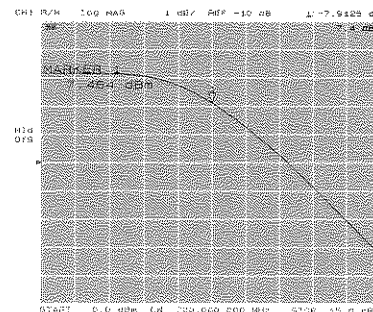

Figure 13. Plot of a mixer's conversion compression, including a marker locating the 1 dB compression point.

## Optional procedure

To enhance measurement accuracy, insert a power splitter between the RF source and the mixer's RF port. Connect the power meter (shown in figure 12), to the power splitter's open port. Perform a one sweep power meter calibration.

For the necessary procedure, see the swept IF conversion loss measurement on page 6.

Once this procedure is complete, the mixer's RF input power is referenced to a power meter standard.

# Amplitude and phase tracking

The HP 8753B can be used to measure swept IF amplitude and phase tracking between mixers over a specified frequency interval. A block diagram of the hardware configuration necessary for this measurement is shown in figure 14.

In this measurement, we compare mixers having the same stimulus and response signal paths, so that any difference seen in response is due to the mixers and not the measurement system. Mixer B is replaced with the mixer that you wish to compare to it, while mixer A remains in place, used by all mixers as a reference.

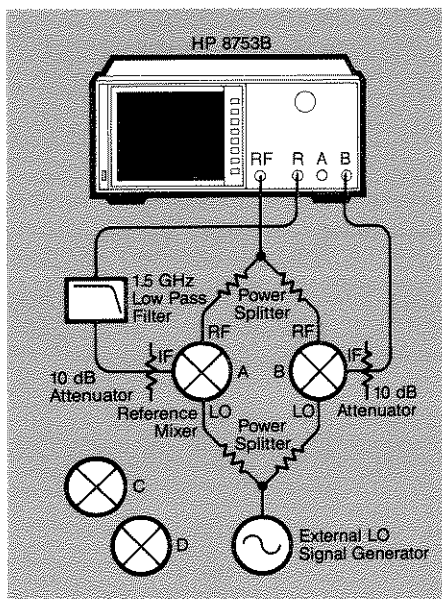

Figure 14. Block diagram for an amplitude and phase tracking measurement.

## Measurement procedure

1. Connect the hardware, including mixers A and B, as shown in figure 14.
2. Press [PRESET] on all instruments.
3. Set the RF source output power and frequency range of the IF receiver.

```
[MENU]
[POWER] [6] [x1]
[START] [100] [M/μ]
[STOP] [1.0] [G/n]
```

4. Set the fixed frequency and output power of your LO source.

```
[CW] [1.5] [GHz]
[POWER] [16] [dBm]
```

5. Set the RF source frequency range using frequency offset mode. In this measurement the RF range covers 1.6 GHz to 2.5 GHz.

```
[SYSTEM]
[INSTRUMENT MODE]
[OFFSET VALUE]
[1.5] [G/n]
[FREQ OFFS ON]
```

6. Display the magnitude and phase of the IF output of mixer B divided by that of mixer A. Store this data into memory and display future data relative to it. This display shows two flat lines.

```
[CH 1]
[MEAS]
[B/R]
[FORMAT]
[LOG MAG]
[DISPLAY]
[DUAL CHAN ON]
[DATA → MEMORY]
[DATA/MEM]
[CH 2]
[MEAS]
[B/R]
[FORMAT]
[PHASE]
[DISPLAY]
[DATA → MEMORY]
[DATA/MEM]
```

7. Remove mixer B from the test setup and replace it with the mixer you wish to compare it to (in this case mixer C). The resulting display is the amplitude and phase match between the third mixer and the original mixer that it replaced (mixer C / mixer B), see figure 15.

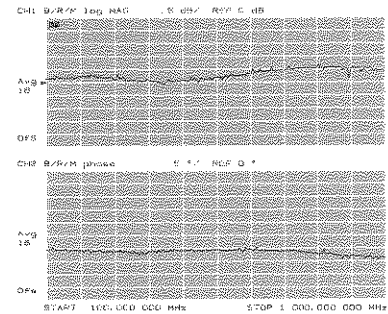

Figure 15. Plot of amplitude and phase tracking between two mixers.

When comparing several mixers, it is good measurement procedure to periodically reinsert the original mixer, (mixer B) and observe the display. This display should look as it did in step 6 of the above procedure. This procedure will verify that your measurement system is time invariant.

# Two-tone third order intermodulation distortion

When two signals are applied to the input of a device, they interact to produce third order intermodulation distortion. In this measurement procedure, two closely spaced fixed frequencies of equal amplitude are input at the mixer's RF port, while a single frequency is used to drive the mixer's LO port. The size of the third order intermodulation distortion products relative to the desired IF frequencies will be measured (dBc). The HP 8753B is used to perform this measurement typically made with a spectrum analyzer. This measurement makes use of the HP 8753B's tuned receiver mode, previously discussed in the fixed IF/ stepped RF and LO measurement, (page 7).

RF1 = Fixed RF frequency #1

RF2 = Fixed RF frequency #2

LO = Local oscillator frequency

IF1 = RF1 - LO

IF2 = RF2 - LO

3rd order intermodulation products

3rd1 = 2RF1 - RF2 - LO

3rd2 = 2RF2 - RF1 - LO

Figure 16 shows a block diagram for a third order IMD measurement made with the HP 8753B. The filters, attenuators and amplifiers provide isolation and remove unwanted signals from the system. These are essential to accurate measurements, because signal levels as low as 60 dBc can degrade third order IMD measurements.

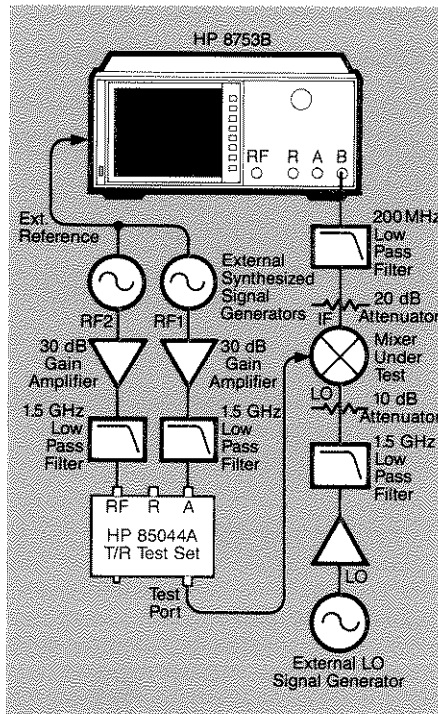

Figure 16. Block diagram for a two-tone third order intermodulation distortion (IMD) measurement.

## Measurement procedure

1. Connect the hardware in figure 6 (page 6) with a thru connection between the power splitter and the receiver's B port.
2. Press [PRESET] on all instruments.
3. Select the fixed frequencies and output power levels for all three external signal sources. To ensure accurate measurement, independent of source distinction, power levels should be chosen give third order IMD sidebands between -40 and -50 dBc. The power levels below were chosen for a +30 dB amplifier gain.

RF1: [CW FREQ] [1] [GHz]

[POWER] [-24] [dBm]

RF2: [CW FREQ] [1.00003] [GHz]

[POWER] [-17] [dBm]

LO: [CW FREQ] [.9] [GHz]

[POWER] [-10] [dBm]



4. Set up a frequency list (frequency list mode) of points where the HP 8753B's receiver is to take data. This includes the four points of interest IF1, IF2, 3rd1, and 3rd2, and the two endpoints that are used to center the plot. In this example RF1 is 1 GHz, RF2 is 1.00003 GHz, the LO is 0.9 GHz, and the two third order products are .09997, and .10006 GHz.

Frequency list data points:

.09992 GHz  
 .09997 GHz  
 .10000 GHz  
 .10003 GHz  
 .10006 GHz  
 .10011 GHz

[MENU]

[SWEEP TYPE MENU]

[EDIT LIST]

Enter frequency points. The keystrokes found directly below will be repeated for each point in the list.

[ADD]

[CENTER] [#] [G/n]

[SPAN] [2] [k/m]

[NUMBER of POINTS]

[5] [x1]

[DONE]

Next point:

[DONE]

[LIST FREQ]

5. Reduce the IF bandwidth to lower the noise floor of the trace, and resolve the measurement data.

[AVG]

[IF BW [3000 Hz]]

[100] [x1]

6. With the configuration in figure 6 still connected, repeat steps 4 and 5 of the swept IF conversion loss measurement (page 6).

7. Connect the instruments as shown in figure 16, tying all time bases together (EXT REF). To minimize the effect of system distortion, it is suggested that attenuation at the mixer's IF port be chosen to give receiver input levels of  $-10$  dBm or less.

8. View the absolute power present at port B relative to the trace of the IF attenuator, filter, and cable stored in memory.

[MEAS]

[B]

[DATA/MEM]

9. Select tuned receiver mode. This mode of operation allows the HP 8753B to receive external signals without the need to phase lock.

[SYSTEM]

[INSTRUMENT MODE]

[TUNED RECEIVER]

10. Figure 17 shows a comparison of two-tone third order IMD measured on a spectrum analyzer and on the HP 8753B.

If the displayed third order IMD products are of unequal magnitude, or appear to be unstable, change the frequency spacing between the RF input signals until the display stabilizes.

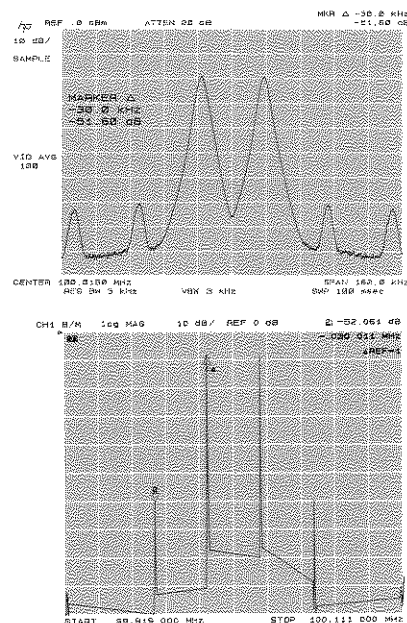

Figure 17. Comparison of third order IMD measurements made on a spectrum analyzer and the HP 8753B.

### Third order intercept point (TOI)

Third order intercept point can be calculated, using the equation below.

$$TOI = DR/2 + (P_{in})$$

Where (P<sub>in</sub>) is the RF input signal level and DR is the difference between mixer IF output power and third order product mixer output power (dBc).

# Isolation

The equipment configuration necessary to measure isolation (feedthrough) between mixer ports is identical to that used in a transmission (B/R) measurement, shown in figure 18.

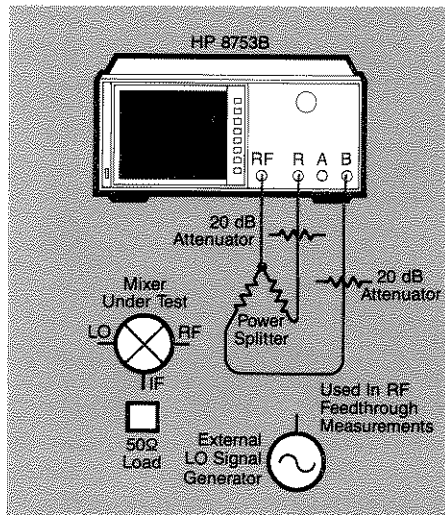

Figure 18. Block diagram for an isolation measurement.

## Measurement procedure

### LO to RF isolation

1. Connect the hardware as shown in figure 18.
2. Preset the HP 8753B by pressing [PRESET].
3. Using the HP 8753B's source as your local oscillator, select the LO frequency range and source output power.  
[START] [10] [M/μ]  
[STOP] [3] [G/n]  
[MENU]  
[POWER] [16] [x1]
4. Perform a frequency response calibration.  
[MEAS]  
[B/R]  
[CAL]  
[CALIBRATE MENU]  
[RESPONSE]  
[THRU]  
[DONE: RESPONSE]
5. Terminate the mixer's IF port with a 50 ohm load.
6. Insert the mixer to be tested between the power splitter and attenuator leading to the receiver's B port. The incident signal should be entering the mixer's LO port and exiting the mixer's RF port.
7. Adjust scale.  
[SCALE REF]  
[AUTO SCALE]
8. The resulting display shows the mixer's LO to RF isolation (figure 19)

Measuring the IF to LO or LO feedthrough would follow a similar procedure.

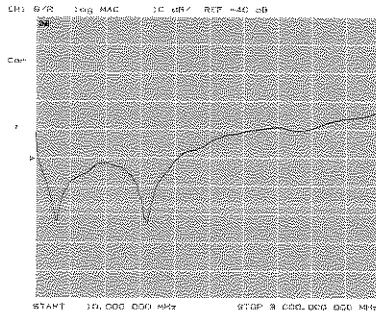

Figure 19. Plot of LO to RF isolation of a mixer.

### RF feedthrough

The procedure and equipment configuration necessary for this measurement are very similar to those above, with the addition of an external source to drive the mixer's LO port as we measure the mixer's RF feedthrough.

1. Connect the hardware as shown in figure 18.
2. Preset the instruments by pressing [PRESET] on the instrument front panels.
3. Using the HP 8753B as the RF source, select the frequency range and source power.  
[START] [10] [M/μ]  
[STOP] [3] [G/n]  
[MENU]  
[POWER] [0] [x1]
4. Perform a frequency response calibration.  
[MEAS]  
[B/R]  
[CAL]  
[CALIBRATE MENU]  
[RESPONSE]  
[THRU]  
[DONE: RESPONSE]
5. Insert the mixer to be tested between the power splitter and attenuator leading to the receiver's B port. The incident signal should be entering the mixer's RF port and exiting the mixer's IF port, with the external source connected to the mixer's LO port.
6. Select a fixed LO frequency and source power from the front panel of the external source. Isolation is dependent on LO power level and frequency. To ensure good test results, these parameters should be chosen as close to actual operating conditions as possible.  
[CW] [300] [MHz]  
[POWER] [10] [dBm]
7. The resulting display shows the mixer's RF feedthrough.

Measuring IF to RF isolation is done in a similar manner using the HP 8753B's source as the IF signal, driving the LO port with an external source, and viewing the leakage signal at the RF port.

# SWR/ Return loss

## RF Port SWR

Mixer reflection measurements can be made simply and quickly using the setup shown in Figure 20.

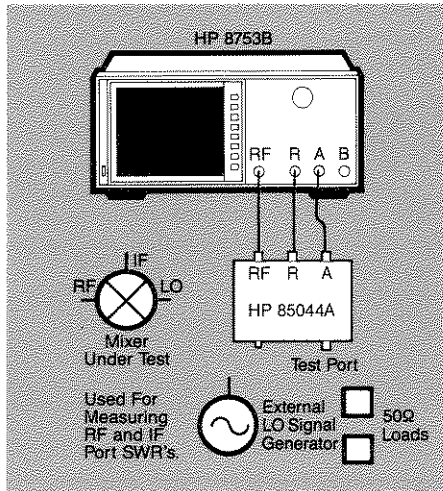

Figure 20. Block diagram for a SWR/return loss measurement.

## Measurement procedure

1. Connect the HP 85044A Transmission/Reflection test set to the HP 8753B.
2. Preset the HP 8753B by pressing [PRESET].
3. Select the frequency and source output power for the HP 8753B.  
[START] [10] [M/ $\mu$ ]  
[STOP] [3] [G/n]  
[MENU]  
[POWER] [13] [ $\times$ 1]  
[FORMAT]  
[SWR]

4. Perform an S11 1-port calibration at the point to be connected to the RF port of the mixer. This removes systematic errors from the reflection measurement.

[CAL]  
[CALIBRATE MENU]  
[S11 1-PORT]

5. Select a fixed LO frequency and output power level. SWR is dependent on both LO power level and frequency. To ensure accurate test results select these parameters to simulate the conditions that the mixer will encounter during normal operation.

[CW] [300] [MHz]  
[POWER] [13] [dBm]

6. Connect the mixer's RF port to the HP 85044A test set.
7. Connect the mixer's LO port to the output of the local oscillator.
8. Terminate the mixer's IF port with a 50 ohm load.
9. Adjust scale.

[SCALE REF]  
[AUTO SCALE]

10. The resulting display (figure 21) is the SWR of the mixer's RF port between 10 MHz and 3 GHz.

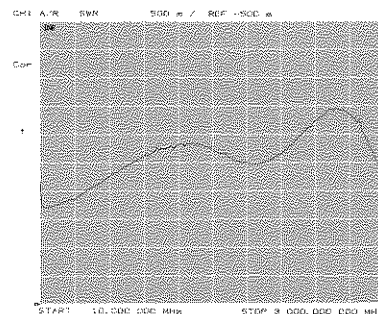

Figure 21. Plot of a mixer's RF port SWR.

## IF Port SWR

By connecting the IF port of the mixer to the front of the HP 85044A, and terminating the mixer's RF port with a 50 ohm load, you can measure the IF port SWR by using the procedure above.

## LO Port SWR

By adding 10 dB attenuators between the test set and the receiver's R and A ports, LO port SWR can be measured using a procedure similar to the one listed above, using the HP 8753B as the local oscillator.

## Measurement procedure

1. Connect the HP 85044A Transmission/Reflection test set to the HP 8753B.
  2. [PRESET] the HP 8753B.
  3. Select the frequency and output power the local oscillator will be set at under the mixer's normal operating conditions. If more power is needed than is available at the test port, you may insert an amplifier (<1 Watt) between source and test set, or replace the test set with a dual directional coupler.
  4. Perform an S11 1-port calibration at the point to be connected to the mixer's LO port.
  5. Terminate the mixer's RF and IF ports with 50 ohm loads.
  6. Connect the mixer's LO port to the LO signal generator.
- The resulting display of LO SWR shows signal reflection under typical operating conditions, and therefore more accurately predicts the reflections that will be present during actual operation.

# Appendix

## Spur analysis and prediction

As described in the measurement considerations section of this note, the HP 8753B is susceptible to spurious responses caused by unwanted mixing products of the device entering and mixing with the analyzer's sampler-based receiver. The easiest way to eliminate these spurs is to stop the unwanted signals from entering the HP 8753B. For fixed IF mixer measurements, this is easily accomplished by the use of a bandpass filter (BPF) centered around the mixer's IF signal. For swept measurements filtering alone may not remove all unwanted signals. If this is the case, both filtering and frequency selection (frequency list mode) will be necessary. The spur prediction program found at the end of this appendix will help you select the frequencies to avoid when measuring the mixer's response.

### Spur analysis

Shown in figure A1 is a mixer under test having RF and LO inputs and an IF output. Also emanating from the mixer's IF port are several other mixing products of the RF and LO signals. These unwanted mixing products can cause spurious responses in the HP 8753B's IF signal path that will degrade measurement accuracy. For this reason, spurious responses must be avoided or reduced.

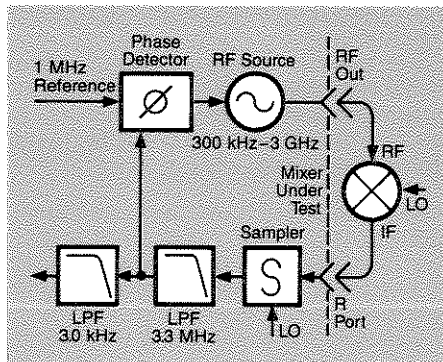

Figure A1. Block diagram of the HP 8753B receiver and a mixer under test.

The method used in the HP 8753B to downconvert incoming IF signals to 1 MHz for internal processing is called sampling. The sampling method presents all of the frequency harmonics of the receiver's voltage-tuned oscillator (VTO) to the incoming IF signal. The VTO is retuned and phase locked so that one of its harmonics mixes with the incoming IF signal to give exactly 1 MHz. An internal 1 MHz BPF stops all other mixing products of the RF, LO and VTO which are not at 1 MHz from continuing on inside the HP 8753B. However, if the incoming IF signal is composed of many different frequency components, it is possible that some other component of the IF signal will combine with a different harmonic of the VTO and also produce a signal at 1 MHz (see figure A2). This unwanted signal will then proceed through the internal 1 MHz BPF, along with the desired signal, and cause a spurious measurement response.

If you are concerned about spurious measurement responses it is suggested that you reduce the instrument's IF bandwidth, and avoid frequencies, and frequency

spacings of 1 MHz. Reducing the IF bandwidth will more selectively filter signals in the instrument's IF signal path. 1 MHz is the HP 8753B's first internal IF frequency, therefore 1 MHz and multiples thereof should be avoided when choosing frequencies and frequency spacings for mixer measurements made with the HP 8753B.

### The spur prediction program

The first step in avoiding or eliminating spurs is to determine at what frequencies they may occur. This program predicts the frequencies that may cause spurious responses when they enter the HP 8753B's receiver, so that you may avoid them using frequency list mode. This spur prediction program is written in HP BASIC 5.0, and although it is specialized for fixed LO/swept IF mixer measurements, it can easily be modified for other measurement configurations. This program only predicts the possible occurrence of a spur; it does not predict its power level. Also, this program does not consider RF and LO subharmonics.

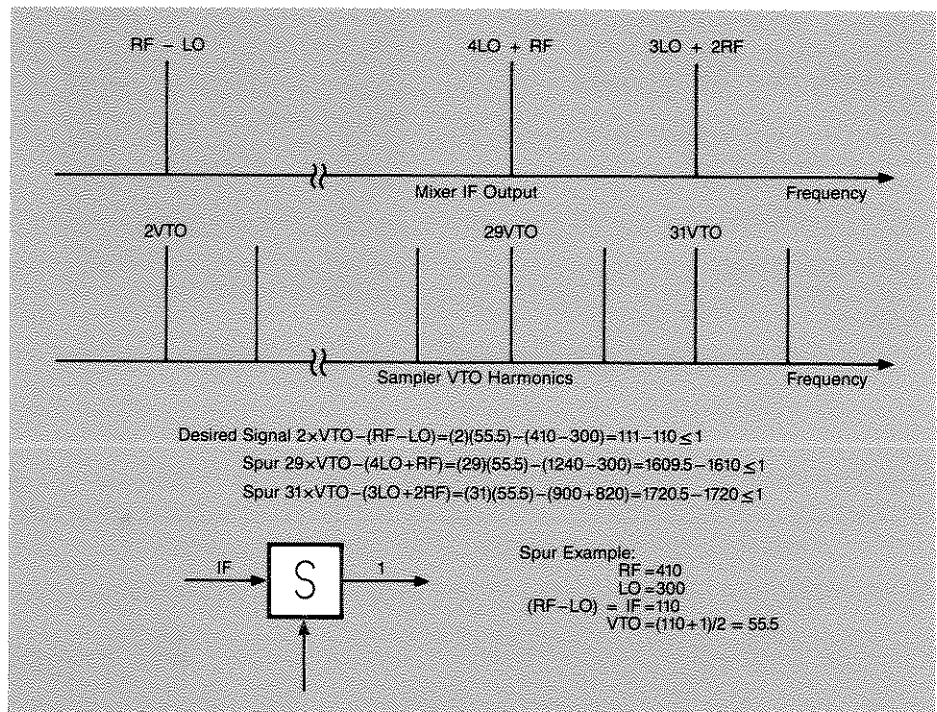

Figure A2. Diagram of mixer IF output and sampler VTO harmonics vs. frequency.

```

10 !TEST SPUR
20 !8753 MIXER SPUR PROGRAM
30 OUTPUT KBD;CHR$(255)&CHR$(75);
40 INPUT "ENTER RF START FREQ (MHz)".R start
50 INPUT "ENTER RF STOP FREQ (MHz)".R stop
60 PRINT USING "2(3A.5D.3D)";"R=".R start." - ".R stop
70 INPUT "ENTER LO FREQ (MHz)".L freq
80 PRINT USING "3A.5D.3D";"L=".L freq
90 INPUT "ENTER THE NUMBER OF 8753 TRACE POINTS".N pnts
100 PRINT USING "14A.4D";"NO. OF POINTS=".N pnts
110 INPUT "ENTER IF FILTER LOWER FREQ EDGE (MHz)".B start
120 INPUT "ENTER IF FILTER UPPER FREQ EDGE (MHz)".B stop
130 PRINT USING "13A.6D.3D.1X.3A.4X";"Filter start=".B start."MHz". "Filter sto
p=" .B stop "MHz"
140 PRINT " "
150 PRINT " R L I F vto* X= Y mL
- nR= Spur"
160 !
170 Mm=1
180 Nn=-1
190 R step=(R stop-R start)/(N pnts-1)
200 FOR Pnt=0 TO N pnts-1
210 R=R start+Pnt*R step
220 L=L freq
230 I=ABS(Mm*L+Nn*R)
240 CALL Vto(I,V)
250 !
260 FOR M=0 TO 10
270 FOR N=-10 TO 10
280 IF M=Mm AND N=Nn THEN Necst
290 CALL Spur(M,L,N,R,V,B start,B stop)
300 Necst:NEXT N
310 NEXT M
320 NEXT Pnt
330 END
340 !
350 SUB Vto(I,V)
360 V=(I+1)/101
370 IF I<3060 THEN V=(I+1)/51
380 IF I<1607 THEN V=(I+1)/27
390 IF I<893 THEN V=(I+1)/15
400 IF I<535 THEN V=(I+1)/9
410 IF I<296 THEN V=(I+1)/5
420 IF I<178 THEN V=(I+1)/3
430 IF I<121 THEN V=(I+1)/2
440 IF I<61 THEN V=(I+1)/1
450 SUBEND
460 SUB Spur(M,L,N,R,V,B start,B stop)
470 X=ABS(M*L+N*R)
480 IF X<B start OR X>B stop THEN Here
481 P=X DIV V
490 IF P>(6000/V) THEN Here
500 FOR H=0 TO 1
510 Y=ABS(X-(P+H)*V)
520 IF Y<2.000 THEN
530 PRINT USING "3(5D.3D.4X).3D.3D.1A.3D.1A.5D.3D.3X.2D.1A.3D.2A.5D.3D."
;R.L.ABS(L-R).V."*".P+H."=" .V*(P+H).M."L" .N."R=" .X
540 END IF
550 NEXT H
560 Here:SUBEND

```

HEWLETT-PACKARD CO. NMD  
REV. 1.0 1/8/80 TR  
!CLEAR SCREEN

For more information, call your local HP sales office listed in your telephone directory or an HP regional office listed below for the location of your nearest sales office.

**United States:**

Hewlett-Packard Company  
4 Choke Cherry Road  
Rockville, MD 20850  
(301) 670-4300

Hewlett-Packard Company  
5201 Tollview Dr.  
Rolling Meadows, IL 60008  
(312) 255-9800

Hewlett-Packard Company  
5161 Lankershim Blvd.  
No. Hollywood, CA 91601  
(818) 505-5600

Hewlett-Packard Company  
2015 South Park Place  
Atlanta, GA 30339  
(404) 955-1500

**Canada:**

Hewlett-Packard Ltd.  
6677 Goreway Drive  
Mississauga, Ontario L4V1M8  
(416) 678-9430

**Japan:**

Yokogawa-Hewlett-Packard Ltd.  
19-21, Takaido, Higashi 3-chome  
Suginami-ku, Tokyo 168  
(03) 331-6111

**Latin America:**

Hewlett-Packard de Mexico,  
Sp. A. de C.V.  
Monte Pelvux No. 111  
Lomas de Chapultepec  
11000 Mexico D.F., Mexico  
(905) 596-7933

**Australia/New Zealand:**

Hewlett-Packard Australia Ltd.  
31-41 Joseph Street  
Blackburn, Victoria 3130  
Melbourne, Australia  
(03) 895-2895

**Far East:**

Hewlett-Packard Asia Ltd.  
47/F China Resources Building  
26 Harbour Road, Hong Kong  
(5) 833-0833

**Germany:**

Hewlett-Packard GmbH  
Vertriebszentrale Deutschland  
Hewlett-Packard-Strasse  
Postfach 1641  
6380 Bad Homburg v.d.H.  
Federal Republic of Germany  
06172/400-0

**France:**

Hewlett-Packard France  
Parc d'activite du Bois Briard  
2, avenue du Lac  
91040 Evry Cedex  
01/60 77 83 83

**United Kingdom:**

Hewlett-Packard Ltd.  
Enquiry Group  
Customer Support Centre  
Eskdale Road  
Winnersh Triangle  
Wokingham  
Berkshire RG11 5DZ  
0734/69 66 22

**Italy:**

Hewlett-Packard Italiana S.p.A.  
Via G. di Vittorio, 9  
20063 Cernusco Sul Naviglio (MI)  
Milano  
02/923691

**Northern Europe:**

Hewlett-Packard S.A.  
Van der Hooplaan 241  
1185 LN Amstelveen  
P.O. Box 999,  
1180 AZ Amstelveen,  
The Netherlands  
(31) 20/547 9999

**South East Europe:**

Hewlett-Packard S.A.  
World Trade Center  
110, Avenue Louis-Casari  
1215 Aeroport-Geneve  
Switzerland  
(41) 22/98 96 51

**Or write to:**

**United States:**

Hewlett-Packard Company  
P.O. Box 10301  
Palo Alto, CA 94303-0890

**Europe/Middle East/Africa:**

Hewlett-Packard Company  
Central Mailing Department  
P.O. Box 529  
1180 AM Amstelveen,  
The Netherlands

**For all other areas:**

Hewlett-Packard Company  
Intercontinental Headquarters  
3495 Deer Creek Rd.  
Palo Alto, CA 94304  
U.S.A.

## RF Component Measurements

### Applications of the Test Sequence Function

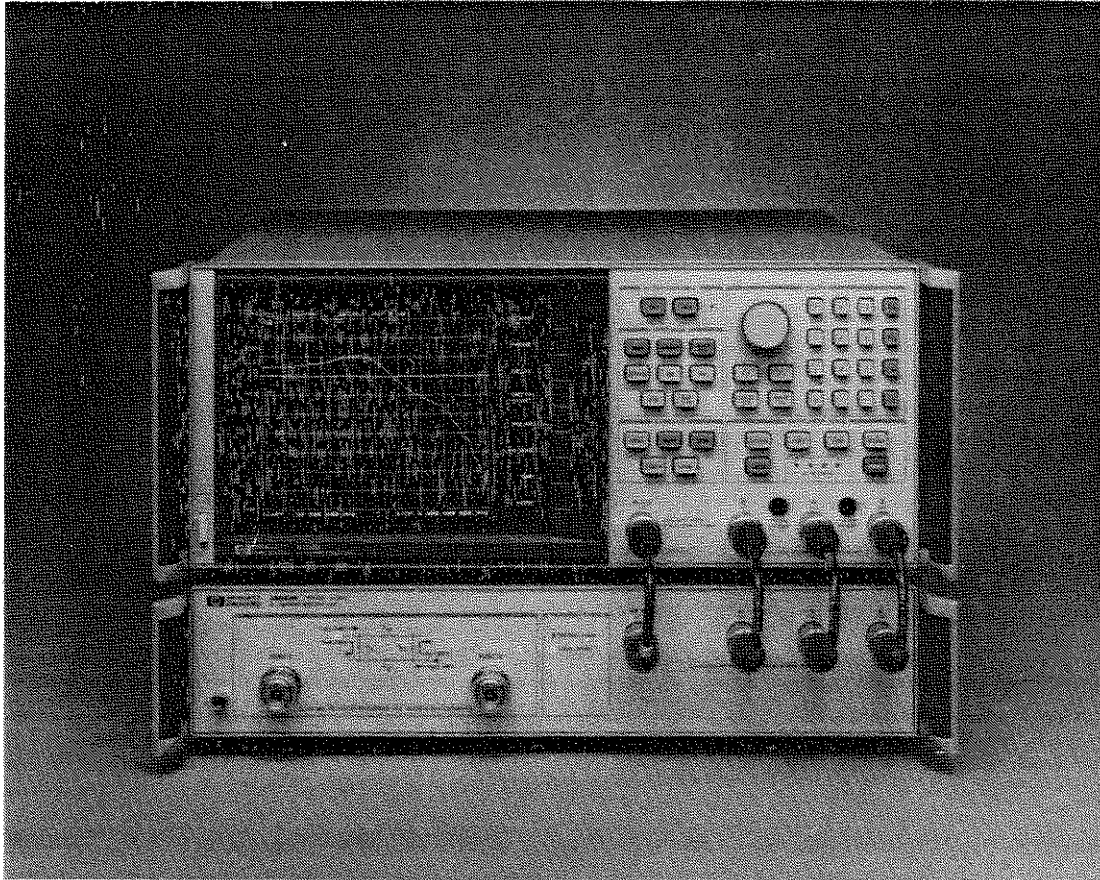

# Introduction

## Table of contents

|                                                                                                   |    |
|---------------------------------------------------------------------------------------------------|----|
| Introduction .....                                                                                | 2  |
| Getting Started .....                                                                             | 3  |
| Creating a Test Sequence .....                                                                    | 3  |
| Running a Test Sequence .....                                                                     | 3  |
| Aborting a Test Sequence .....                                                                    | 3  |
| Editing a Test Sequence .....                                                                     | 4  |
| Storing and Recalling a Test Sequence .....                                                       | 4  |
| Test Sequencing Examples .....                                                                    |    |
| Cascading Multiple Sequences .....                                                                | 6  |
| Using a Loop Counter .....                                                                        | 6  |
| Branching on the Outcome of a Limit Test .....                                                    | 6  |
| Sending Out Control Commands over HP-IB .....                                                     | 7  |
| Reading and Displaying Information acquired over HP-IB .....                                      | 7  |
| Creating a User Interactive Test .....                                                            | 8  |
| Using SEQ 6 as an autostart routine .....                                                         | 8  |
| Application Examples .....                                                                        |    |
| 1. Comprehensive component test example .....                                                     | 9  |
| 2. Swept gain compression example .....                                                           | 14 |
| 3. Test automation through external device control .....                                          | 17 |
| 4. Annotating the HP 8753B's CRT with multiple markers<br>for quick device characterization ..... | 18 |
| 5. Guided measurements using HP-GL user graphics .....                                            | 21 |
| Menu Map .....                                                                                    | 27 |
| Advanced Softkey Descriptions .....                                                               | 28 |

This note illustrates capabilities, and practical application examples of the test sequence function, the HP 8753B's new instrument automation feature.

Component measurements made with a network analyzer are generally simple but repetitive in nature. The HP 8753B's test sequence function offers simple automation without the need for an external computer. The test sequence function enables the user to manually make a measurement from the instrument's front panel, and later repeat that measurement automatically with a single keystroke. The analyzer does this by sequentially recording the keystrokes used during the measurement and storing them in an internal memory register.

The test sequence function can dramatically reduce component test times and greatly reduce the possibility of user error. Because the test sequence function is simply a superset of all standard front panel measurement capabilities no programming expertise is required to use it.

The test sequence function allows the user to create, title, execute and save up to six independent sequences internally. Sequences may also be saved to external disc and can be transferred between the HP 8753B and an external computer for multi-system management applications. For more complete information about the test sequence function see the HP 8753B *System Operating and Programming Manual* (HP part number 08753-90122).

Throughout the descriptions in this note, front panel keys appear in bold type, e.g. **[MENU]**. Softkeys appear in bold italics, e.g. ***[POWER]***.

This note is for an HP 8753B, although an HP 8753A can be retrofitted with the 11882A upgrade kit to provide identical capability. Some examples require the presence of the following installed options (harmonics 002, 6 GHz receiver 006, and time domain 010).



# Getting started

This section contains brief descriptions of creating, running, editing and storing/recalling test sequences on the HP 8753B.

## Creating a test sequence

Listed below are the steps necessary when creating a sequence.

1. Enter the sequence creation/editing mode by pressing

```
[SYSTEM]
[SEQUENCING MENU]
[NEW SEQ/MODIFY SEQ].
```

At this time a list of instructions will appear on the CRT to aid you in creating or editing a sequence (see below).

### TEST SEQUENCING

#### MODIFY

- INSERT - Any function is inserted after cursor.
- DELETE - BACK SP deletes line at cursor.
- STEP - Use ARROW keys or RPG. ARROW up does the function at the cursor and moves list up. ARROW down only moves list down.
- END - Press DONE MODIFY in SEQUENCE MENU.

#### RUN

- START - Press DO SEQUENCE in SEQUENCE MENU.
- KEYS - All front panel keys except LOCAL are locked out until sequence stops.
- STOP - Press LOCAL to stop a running sequence.
- PAUSE - Press CONTINUE SEQUENCE in SYSTEM MENU to restart a paused sequence.

Only sequence 6 is saved when instrument is turned off.

For more information, see Test Sequencing chapter in System Operating and Programming Manual.

Select a softkey to start modifying a sequence --

2. Select a sequence position in which to store your sequence.

For example, pressing

```
[SEQUENCE 1 SEQ1]
```

selects sequence position #1. SEQ1 is the default title of this sequence. For information on how to modify a sequence title refer to *Storing and recalling a test sequence*.

3. When the following display appears on the CRT, you can begin pressing keys for the desired measurement.

```
→Start of Sequence
1996 empty bytes available
```

Your keystrokes will be inserted on the line below the cursor arrow. 1996 bytes correspond to approximately 200 command lines.

**NOTE:** Only those keystrokes performing a specific function will appear in the test sequence. Intermediate keystrokes leading to more menu choices will generally be left out of the test sequence command list.

**Example:** This sequence sets up and displays an S21 measurement of a 134 MHz bandpass filter.

### Keystrokes

### Test Sequence

|                        |                      |
|------------------------|----------------------|
| [RECALL]               | SEQUENCE SEQ1        |
| [RECALL PRST STATE]    | Start of Sequence    |
| [CENTER]               | RECALL PRST STATE    |
| [134][M/u]             | CENTER               |
| [SPAN]                 | 134 M/u              |
| [30][M/u]              | SPAN                 |
| [MEAS]                 | 30M/u                |
| [Trans: FWD S21 (B/R)] | Trans: FWD S21 (B/R) |
| [FORMAT]               | LOG MAG              |
| [LOG MAG]              | SCALE/DIV            |
| [SCALE REF]            | AUTO SCALE           |
| [AUTOSCALE]            |                      |

4. When you have completed entering the keystrokes necessary to make a measurement, exit the creation/editing mode by pressing

```
[SYSTEM]
[SEQUENCING MENU]
[DONE MODIFY]
```

**NOTE:** Only a sequence created in sequence position #6 is stored in non-volatile memory. Sequences stored in other positions are stored in volatile memory and will be lost if the instrument is turned off.

## Running a test sequence

To run a test sequence press

```
[SYSTEM]
[SEQUENCING MENU]
[DO SEQUENCE]
```

followed by the appropriate test sequence number. It is also possible to run a sequence by pressing [PRESET] and the appropriate test sequence number.

**NOTE:** The test sequence function has been designed to maximize test execution speed. Therefore, command order may be slightly modified during the execution of a sequence. In situations where sequential execution of command steps is critical, placing [WAIT X] [0][x1] in a sequence will force the sequence to complete any prior commands before continuing down the command list.

## Aborting a test sequence

To stop a test sequence while it is running, press [LOCAL].

**NOTE:** It is not possible to continue a test sequence once it has been stopped in this manner.

## Editing a test sequence

1. The first step in editing a test sequence is to enter the creation/editing mode.

```
[SYSTEM]
[SEQUENCING MENU]
[NEW SEQ/MODIFY SEQ].
```

2. The next step is to select the particular test sequence you wish to modify, in this example sequence 1.

```
[SEQUENCE 1 SEQ1]
```

Once you have chosen which sequence to edit, it will be active until you exit the creation/editing mode by pressing **[DONE MODIFY]**. Shown below is the active sequence, SEQ 1. Note that for longer sequences only a portion of the sequence will actually appear on the CRT at any point in time.

```
SEQUENCE SEQ1
Start of Sequence
RECALL PRST STATE
CENTER
 134 M/u
SPAN
 30M/u
Trans: FWD S21 (B/R)
LOG MAG
SCALE/DIV
AUTO SCALE
```

### The active line

The active line is always the line next to the → cursor.

### Scrolling through the sequence command list

The position of the → cursor is fixed on the CRT, the command list moves up or down when the operator uses the rotary knob or the [▼] and [▲] keys.

Pressing the key causes the list to scroll down, and the cursor to point to the next command line. Pressing the [▲] key also allows you to execute each line individually as you scroll through the sequence. If you wish to scroll through the sequence without executing each line as you do so, you can press the [▼] key and scroll through the command list backwards.

### Inserting commands

Inserting commands into a sequence requires no special keystrokes. Move the → cursor to the line immediately above the line to be inserted, then press the desired keystroke command to be inserted, and it will appear below the active entry line.

### Deleting commands

Pressing the **[BACK SP]** (backspace) key deletes the active entry next to the → cursor.

## Storing and recalling a test sequence

### Modifying a test sequence's title

Before storing test sequences it is often necessary to rename them. To modify a test sequence title press

```
[SYSTEM]
[SEQUENCING MENU]
[MORE]
[TITLE SEQUENCE].
```

Select the appropriate sequence and modify its title by following the steps listed below.

```
[ERASE TITLE]
```

Move the RPG knob to place the cursor under the letter of choice. Press

```
[SELECT LETTER]
```

Repeat this letter selection process until the new title is complete. Once the title is complete press

```
[DONE].
```

### Internal storage of a test sequence

The HP 8753B automatically stores test sequences as they are created or modified, into an internal memory register initially chosen by the user. Remember, only sequence 6 is stored in non-volatile memory.

### Internal recall of a test sequences

To recall and run or modify a test sequence press

```
[SYSTEM]
[SEQUENCING MENU]
[DO SEQUENCE] or [NEW SEQ/MODIFY SEQ]
```

followed by the appropriate sequence number, for example

```
[SEQUENCE 1 SEQ1].
```

### Storing a test sequence to an external disc

Connect the disc drive and set the HP 8753B to system controller mode

1. Connect an HP 9122 (or other CS-80/HP-IB compatible disc drive) to the HP 8753B. Program the HP 8753B with the disc drive's HP-IB address by pressing

```
[LOCAL]
[SET ADDRESSES]
[ADDRESS: DISC]
```

followed by the disc drive's HP-IB address.

2. Disconnect the HP 8753B from any external computer/controller. Set the HP 8753B to system controller mode by pressing

```
[LOCAL]
[SYSTEM CONTROLLER].
```

### Formatting a blank disc (Optional)

3. If necessary, format a blank disc by inserting it into default disc drive 0 and pressing

[SAVE]  
[STORE TO DISC]  
[DEFINE STORE]  
[MORE]  
[INITIALIZE DISC]  
[INIT DISC? YES].

4. Press [SYSTEM]  
[SEQUENCING MENU]  
[STORE SEQ TO DISC].

The titles of the sequences presently stored in internal memory will be displayed in the softkey menu area.

5. Select the desired sequence to store from those listed in the softkey menu area, for example

[SEQUENCE 1 SEQ1].

#### CAUTION

**The save sequence to disc function will overwrite any file on the disc with the same title. There is no warning to the user when a file is to be overwritten.**

6. The disc drive access light will briefly turn on. When it goes out, the sequence has been saved.

### Recalling a test sequence from an external disc

The first part of this section deals with locating a sequence title on an external disc. This is useful if you are not sure about the exact sequence title and wish to read the sequence titles stored on the disc. If you know the title of the sequence that you wish to recall skip down to the part of this section that deals with loading a sequence.

#### Locating a sequence title on an external disc

Press [SYSTEM]  
[SEQUENCING MENU]  
[LOAD SEQ FROM DISC]  
[READ SEQ FILE TTLS]

If the desired sequence title is not among the first six titles, keep pressing

[READ SEQ FILE TTLS]

until the desired sequence title appears. Sequences are stored in chronological order.

### Loading a sequence

1. If you know the title of the sequence you are trying to load, press

[SYSTEM]  
[SEQUENCING MENU]  
[LOAD SEQUENCE FROM DISC].

If the desired sequence title is not on the load sequence from disc menu, change one of the six sequence titles to match that of the desired sequence by pressing

[SYSTEM]  
[SEQUENCING MENU]  
[MORE]  
[TITLE SEQUENCE]

Select the appropriate sequence position and modify its title as follows. Press

[ERASE TITLE]

Then move the RPG knob to place the cursor under the letter of choice. Press

[SELECT LETTER]

Repeat this letter selection process until the new title is complete. Once the title is complete press

[DONE]  
[RETURN]  
[LOAD SEQ FROM DISC].

2. Press the softkey next to the title of the desired sequence. The disc access light should turn on briefly. When it goes out, the sequence has been loaded.

**NOTE:** When loading interactive sequences from disc, care should be taken to load them into the expected sequence positions. Sequences are called by location in the sequencing menu (sequences 1-6), not by sequence title.

# Test Sequencing Examples

## Cascading multiple sequences

Cascading test sequences can be used to modularize test sequences just as subroutines are used to modularize computer programs. Cascading sequences can also be used to extend the length of test sequences to greater than 200 lines. Shown below are two sequences that have been cascaded. This has been done by having the last command in sequence 1 call sequence position 2. Once called, the sequence residing in sequence position 2 will be executed regardless of sequence title.

```
SEQUENCE SEQ1
Start of Sequence
RECALL PRST STATE
CENTER
 134 M/u
SPAN
 30M/u
DO SEQUENCE
 SEQUENCE 2
```

```
SEQUENCE SEQ2
Start of Sequence
Trans: FWD S21 (B/R)
LOG MAG
SCALE/DIV
AUTO SCALE
```

This process of calling the next sequence from the last line of the present sequence can be extended to 6 internal sequences, or an unlimited number of externally stored sequences. Note, it is not possible to nest sequences, because no pointer information exists between sequences.

## Using a loop counter

Listed below are the basic steps necessary for constructing a looping structure within a test sequence. A typical application of this loop counter structure is repeating a specific measurement as you step through a number of CW frequencies or DC bias levels.

1. Create a sequence that will set the initial value of the loop counter, and call the sequence position containing the sequence that you wish to repeat. An example of this sequence is shown below.

```
SEQUENCE LOOP1
Start of Sequence
RECALL PRST STATE
LOOP COUNTER
 10x1
DO SEQUENCE
 SEQUENCE 2
```

2. Create a second sequence that will perform the desired function, decrement the loop counter, and call itself until the loop counter value is equal to zero. An example of this sequence is shown below.

```
SEQUENCE LOOP2
Start of Sequence

(MAKE MEASUREMENT)

DECR LOOP COUNTER
IF LOOP COUNTER <> 0 THEN DO
 SEQUENCE 2
```

## Branching on the outcome of a limit test

Listed below are the basic steps necessary for constructing a sequence that is to branch on the outcome of a limit test. By configuring sequences similarly to the ones below, the test sequence function can automatically make a decision based on the outcome of a limit test or series of limit tests.

1. Create an instrument state including limit lines that will be used to test your device.
2. Create a sequence that will recall the desired instrument state, perform a limit test, and branch to another sequence position based on the outcome of that limit test. An example sequence (BRANCH1) is shown below.

```
SEQUENCE BRANCH1
Start of Sequence
RECALL 1
LIMIT LINE
ON
LIMIT TEST
ON
IF LIMIT TEST PASS THEN DO
 SEQUENCE 2
IF LIMIT TEST FAIL THEN DO
 SEQUENCE 3
```

3. The sequence position called by the branching statement contains a sequence that performs a specific function such as tuning and retesting a device that has failed, or storing data for a device that has passed. Two example sequences are shown below.

The sequence BRANCH2 stores data for a device that has passed the limit test in sequence BRANCH1.

```
SEQUENCE BRANCH2
Start of Sequence
STORE 1
```

The sequence BRANCH3 prompts the user to tune a device that has failed the limit test in sequence BRANCH1, and calls sequence position 1 to retest the device once it has been tuned.

```
SEQUENCE BRANCH3
Start of Sequence
TITLE
 TUNE DEVICE; PRESS CONTINUE TO RETEST
SYSTEM
PAUSE
DO SEQUENCE
 SEQUENCE 1
```

## Sending out control commands over HP-IB

While the test sequencing function is not intended to have all the flexibility of programming over HP-IB with a computer, it does have some limited HP-IB control capability.

Sending out control commands over HP-IB is accomplished by writing HP-IB mnemonics with the [TITLE] softkey, and sending out those mnemonics via the [TITLE TO PRINTER], and [TITLE TO P MTR/HPIB] softkeys.

This feature simply allows the HP 8753B to set parameters on other HP-IB instruments: it does not enable complete talker/listener capabilities. As a typical example, it could be used to automatically set the frequency on an external RF source or set a DC bias level on an external bias source. The steps necessary to send out control commands are outlined below.

1. Connect the HP-IB device or devices that you wish to control using the HP 8753B.
2. Create a sequence that will recall a known instrument state, set the correct addresses for the HP-IB equipment connected to the HP 8753B, and put the HP 8753B into system controller mode. This sequence will also produce display titles containing HP-IB mnemonics, and send these titles out to the appropriate instruments on the bus. An example sequence is shown below.

```
SEQUENCE SEND1
Start of Sequence
RECALL PRST STATE
ADDRESS: P MTR/HPIB
 14x1
SYSTEM CONTROLLER
TITLE
PL10DB;SF50MZ;CW1.5GZ;
TITLE TO P MTR/HPIB
```

## Reading and displaying information acquired over HP-IB

The first step in reading and displaying information acquired over HP-IB is to initialize external instruments by creating and sending HP-IB mnemonics with the [TITLE], and [TITLE TO P MTR/HPIB] softkeys. Once the external instruments have been initialized the [P MTR/HPIB TO TITLE], and [TITLE TO MEMORY] commands can be used to read in and store data. By displaying the memory trace this data can be displayed. The steps necessary to read and display information read in over HP-IB are outlined below.

1. Connect the HP-IB device or devices that you wish to control to the HP 8753B.

2. Create a sequence that will recall a known instrument state, set a loop counter value equal to the desired number of points in the measurement, set the correct addresses for the HP-IB equipment connected to the HP 8753B, and put the HP 8753B into system controller mode. This sequence will also produce and send out display titles to initialize the HP-IB instruments to be used. An example sequence is shown below.

```
SEQUENCE READ1
Start of Sequence
RECALL PRST STATE
REAL
NUMBER of POINTS
 51x1
LOOP COUNTER
 51x1
DATA -> MEMORY
DISPLAY: MEMORY
ADDRESS: P MTR/HPIB
 13x1
SYSTEM CONTROLLER
TITLE
PR;BP;LN;
TITLE TO P MTR/HPIB
MEASURE RESTART
DO SEQUENCE
SEQUENCE 2
```

3. Create a second sequence that will decrement the loop counter value, trigger the instruments, and read and display the data read in over HP-IB. This sequence will repeat itself until the loop counter value is equal to zero. An example sequence is shown below.

```
SEQUENCE READ2
Start of Sequence
MANUAL TRG ON POINT
TITLE
TR2;
TITLE TO P MTR/HPIB
P MTR/HPIB TO TITLE
TITLE TO MEMORY
DECR LOOP COUNTER
IF LOOP COUNTER <> 0 THEN DO
SEQUENCE 2
```

## Creating a user interactive test

Automatic test procedures often require an operator to connect/disconnect devices during the course of a measurement. The test sequence function can be used to execute user prompts during the execution of an automated measurement.

This example shows how to utilize user prompts in an automated test situation.

1. Store measurement parameters and limit lines in an instrument state.
2. Create a test sequence that recalls an instrument state and performs a limit test. If the limit test fails, this sequence will send a message to the CRT instructing the user to tune the DUT. If the limit test passes, the sequence will branch to another sequence that will prompt the user to prepare the next device for testing, or exit from the test. An example is shown below.

```
SEQUENCE TEST1
Start of Sequence
RECALL 1
LIMIT LINE
ON
LIMIT TEST
ON
IF LIMIT TEST PASS THEN DO
SEQUENCE 2
TITLE
TUNE DEVICE AS NEEDED
SYSTEM
PAUSE
DO SEQUENCE
SEQUENCE 1
```

```
SEQUENCE TEST2
Start of Sequence
TITLE
PRESS LOCAL TO EXIT TEST
SYSTEM
PAUSE
TITLE
CONNECT THE NEXT DEVICE TO BE TESTED
SYSTEM
PAUSE
DO SEQUENCE
SEQUENCE 1
```

## Using SEQ 6 as an autostart routine

By labeling sequence position 6 [AUTO], it will automatically execute every time the line power is cycled. The sequence below shows a typical autostart routine that initializes the analyzer, recalls instrument states, and loads and executes test sequences stored on an external disc drive. Note that sequence 6 must be used, because it is the only sequence stored in non-volatile memory.

```
SEQUENCE AUTO
Start of Sequence
RECALL PRST STATE
ADDRESS: DISC
1 x1
TITLE REGISTER 1
FILE1
LOAD 1
SAVE 1
TITLE REGISTER 2
FILE2
LOAD 2
SAVE 2
TITLE SEQUENCE
SEQUENCE 1
ONE
LOAD SEQUENCE 1
LOAD SEQUENCE 1
TITLE SEQUENCE
SEQUENCE 2
TWO
LOAD SEQUENCE 2
LOAD SEQUENCE 2
DO SEQUENCE
SEQUENCE 1
```

# Applications Examples

The following section illustrates a number of measurement examples using the test sequence function.

## 1. Comprehensive component test example.

This test uses pre-stored limit lines and test sequencing's built-in logic functions to automatically measure amplifier gain, reverse isolation, input and output match, gain compression, and second and third order harmonic output levels.

**AMP1.** This sequence recalls measurement parameters from instrument state reg 1 and performs a limit test of amplifier small signal gain, while simultaneously displaying amplifier input match in a Smith chart format. If the limit test passes, this sequence will call sequence position 2 (AMP2). If the limit test fails, it will branch to a tuning sequence that will allow device tuning and an opportunity for retest. The resulting display is shown in figure 1.

**AMP2.** This sequence recalls measurement parameters from instrument state reg 2 and performs a limit test of amplifier reverse isolation, while simultaneously displaying amplifier output match in a Smith chart format. If the limit test passes, this sequence will call sequence position 3 (AMP3). If the limit test fails, it will branch to a tuning sequence that will allow device tuning and an opportunity for retest.

**AMP3.** This sequence recalls measurement parameters from instrument state reg 3 and performs a CW frequency, swept power, gain compression measurement of an amplifier. The 1 dB gain compression point is displayed using a marker search function. The resulting display is shown in figure 2. Once completed, this sequence calls sequence position 4 (AMP4).

**AMP4.** This sequence recalls measurement parameters from instrument state reg 4 to test second and third order harmonic levels in dBc. If the limit test fails, this test will branch to a tuning sequence that will allow device tuning and an opportunity for retest. This sequence requires use of an instrument equipped with option 002.

Two displays showing the results of the harmonic tests are shown in figure 3.

**AMP5.** This sequence pauses testing to allow tuning, then calls sequence position 1 (AMP1) to retest device.

**REG1.** This register contains measurement parameters (start frequency, stop frequency, power level, number of points ...); display format (log mag, Smith chart ...); calibration data (full two-port calibration); and limit lines to be used in the amplifier gain, and input match measurements contained in sequence AMP1. The information contained in this register is device-specific and will depend on the amplifier under test but the sequences utilizing it are designed to be independent of the device under test.

**REG2.** This register contains measurement parameters (start frequency, stop frequency, power level, number of points ...); display format (log mag, Smith chart ...); calibration data (full two-port calibration); and limit lines to be used in the reverse isolation, and output match measurements contained in sequence AMP2. The information contained in this register is device-specific and will depend on the amplifier under test but the sequences utilizing it are designed to be independent of the device under test.

**REG3.** This register contains measurement parameters (start power level, stop power level, CW frequency, number of points ...); display format (log mag, Smith chart ...); to be used in the amplifier gain compression measurement of sequence AMP3. The information contained in this register is device-specific and will depend on the amplifier under test.

**REG4.** This register contains measurement parameters (start frequency, stop frequency, power level, number of points ...); display format (log mag, Smith chart ...); and limit lines to be used in the amplifier harmonic level test contained in AMP4. The information contained in this register is device-specific and will depend on the amplifier under test.

```

SEQUENCE AMP1
Start of Sequence
RECALL 1
LIMIT LINE
 ON
LIMIT TEST
 ON
BEEP FAIL
 ON
IF LIMIT TEST FAIL THEN DO
 SEQUENCE 5
MKR FCTN
SEARCH MAX
TITLE
 SMALL SIGNAL GAIN
CH 2
Ref1: FWD S11 (A/R)
DUAL CHAN
 ON
SMITH CHART
TITLE
 INPUT MATCH
SYSTEM
PAUSE
DO SEQUENCE
 SEQUENCE 2

```

Performing a limit test of amplifier gain.

Displaying input match on a Smith chart format, and pausing execution of the sequence.

Branching to sequence position 2.

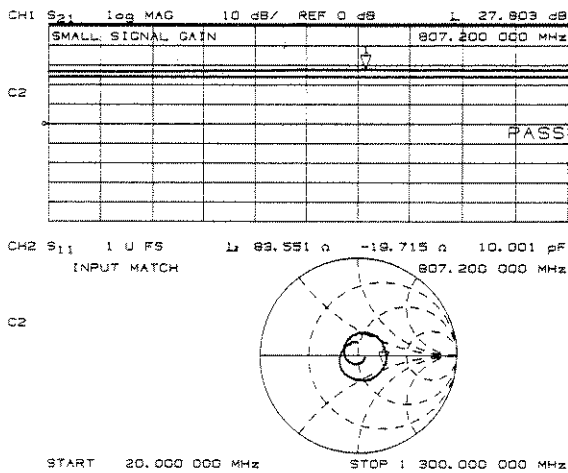

Figure 1. Display of amplifier gain and input match



SEQUENCE AMP2  
Start of Sequence

RECALL 2  
LIMIT LINE  
ON

LIMIT TEST  
ON

Performing a limit test of amplifier reverse isolation.

BEEP FAIL  
ON

IF LIMIT TEST FAIL THEN DO  
SEQUENCE 5

MKR FCTN  
SEARCH MIN  
TITLE  
REVERSE ISOLATION

CH 2  
Ref1: REV S22

DUAL CHAN  
ON

SMITH CHART  
TITLE

Displaying output match on a Smith chart format, and pausing execution of the sequence.

OUTPUT MATCH

SYSTEM

PAUSE

DO SEQUENCE  
SEQUENCE 3

Branching to sequence position 3.

```

SEQUENCE AMP3
Start of Sequence
RECALL 3
MKR FCTN
SEARCH MAX
MKR
DELTA REF MKR = 1
MARKER 2
MKR FCTN
SEARCH TARGET
-1 x1
MKR
DELTA MKR MODE OFF
TITLE
 1 DB GAIN COMPRESSION
MKR
SYSTEM
PAUSE
DO SEQUENCE
 SEQUENCE 4

```

Performing a CW frequency gain compression measurement of an amplifier.

Branching to sequence position 4.

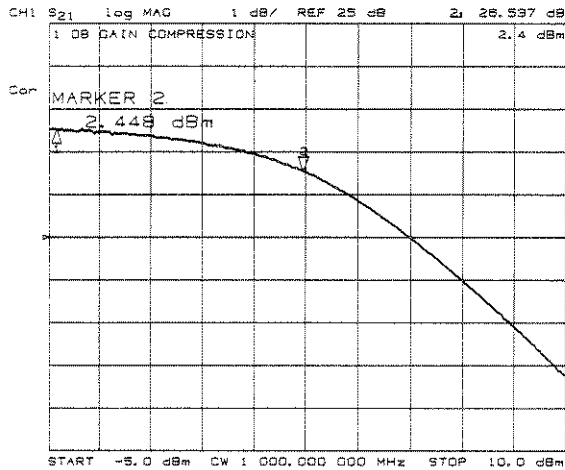

Figure 2. Display of the amplifier's CW frequency gain compression

```

SEQUENCE AMP4
Start of Sequence
RECALL 4
DUAL CHAN
 ON
SPLIT DISP
 OFF
COUPLED CH
 OFF
POWER
COUPLE PWR
 ON
D2/D1 toD2
 ON
HARMONIC SECOND
SINGLE

```

Configuring dBc harmonic measurement.

Performing second order harmonic output level limit test.

```

TITLE
 2ND HARMONIC(DBC)
LIMIT LINE
 ON
LIMIT TEST
 ON
BEEP FAIL
 ON
IF LIMIT TEST FAIL THEN DO
 SEQUENCE 5
SYSTEM
PAUSE
HARMONIC THIRD
SINGLE
TITLE
 3RD HARMONIC (DBC)
IF LIMIT TEST FAIL THEN DO
 SEQUENCE 5

```

Pausing between measurements of second and third order harmonic levels.

Performing third order harmonic output level limit test.

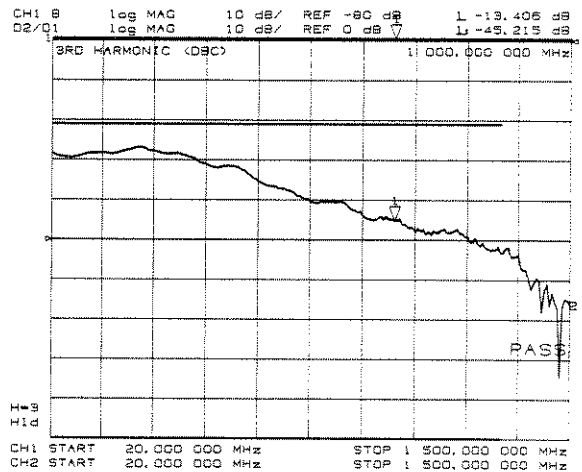
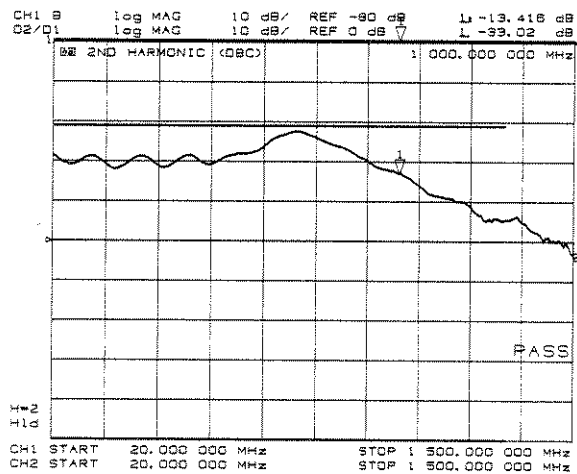

Figure 3. The results of the amplifier's second and third order harmonic level test

```

SEQUENCE AMPS
Start of Sequence
CONTINUOUS
TITLE
 LIMIT TEST FAILED. TUNE AS NECESSARY
SYSTEM
PAUSE
DO SEQUENCE
 SEQUENCE 1

```

Allowing the operator to tune and retest device as necessary.

## 2. Swept gain compression example.

The amplifier's swept gain compression is found by sweeping input power and finding 1 dB gain compression points at a list of CW frequencies. This example utilizes many of the analyzer's new features including loop counters, power meter calibration, and reading data over HP-IB. This measurement illustrates how sequences can be used instead of HP-IB programs for simple device testing. A display of the results is shown in figure 4.

**COMP1.** Sets necessary measurement parameters, acquires calibration data, and initializes marker and loop counter values. Once completed, this sequence calls sequence position 2 (COMP2).

**COMP2.** This sequence performs a CW frequency, swept power, gain compression measurement, and stores the amplifier's output power at 1 dB gain compression into the memory data array. Once completed, this sequence calls sequence position 3 (COMP3).

**COMP3.** This sequence increments the CW measurement frequency, and decrements the loop counter. If the loop counter value is equal to zero (all data points measured), this sequence will scale and display the 1 dB gain compression data of the amplifier. If it is not equal to zero the sequence will call sequence position 2 (COMP2), where another piece of data will be taken.

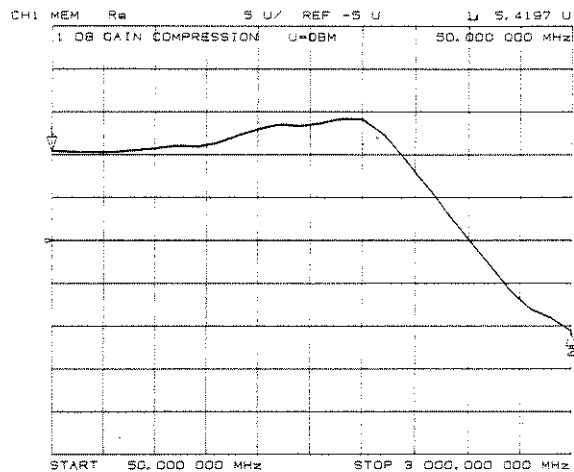

Figure 4. Display of amplifier 1 dB gain compression points versus frequency.

```

SEQUENCE COMP1
Start of Sequence
RECALL PRST STATE
POWER MTR:
 438A/437
ADDRESS: P MTR/HPIB
 13x1
START
 50M/u
STOP
 3 G/n
NUMBER of POINTS
 26x1
LOOP COUNTER
 26x1
IF BW
 300 x1
MKR
MARKER 2
 50M/u
R
TITLE
CONNECT PWR METER TO PORT 1
SYSTEM
PAUSE
TITLE

HOLD
PWRMTR CAL
NUMBER of READINGS
 2 x1
ONE SWEEP
TAKE CAL SWEEP

```

Measurement parameters are chosen here in the first section of COMP1.

The number of measurement points, and loop counter value are both set to 26.

Marker 2 holds CW frequency information: note that its initial value is the measurement start frequency.

A power meter calibration is done to level the test port 1 output power to 0 dBm. For more information on power meter calibration see the HP 8753B System Operating and Programming Manual (08753-90122).

SINGLE  
CONTINUOUS  
TITLE  
CONNECT THRU  
SYSTEM  
PAUSE  
TITLE

A thru response calibration, using the power calibrated test port 1 as a source, calibrates the receiver to measure power at input port B. Input port B is now calibrated to measure power within the dynamic accuracy specification of the analyzer, providing that the receiver's maximum input power is not exceeded.

B  
CALIBRATE: RESPONSE  
CAL STANDARD  
DONE: CAL CLASS  
INTERPOL  
ON  
PWRMTR CAL  
PWRMTR CAL OFF  
POWER  
ATTENUATOR PORT 1  
10x1  
MARKER -> CW  
MKR  
MARKER 1  
CW FREQ  
Trans: FWD S21 (B/R)  
POWER SWEEP  
DATA -> MEMORY  
SWEEP TIME  
0 x1  
TITLE  
CONNECT AMPLIFIER UNDER TEST  
SYSTEM  
PAUSE  
DO SEQUENCE  
SEQUENCE 2

An input attenuator value is chosen to prevent overdriving the amplifier under test.

NOTE: From this point forward the only measurement calibration used is the receiver power calibration. Therefore, adding an input attenuator (lowering source power), does not affect the calibration data or the accuracy of the measurement.

Initializing the memory array, and setting the analyzer for the minimum possible sweep time.

```

SEQUENCE COMP2
Start of Sequence
STOP
 20x1
SINGLE
SCALE/DIV
AUTO SCALE
MKR FCTN
SEARCH MAX
MKR
MKR ZERO
MKR FCTN
SEARCH TARGET
-1 x1
SEARCH MIN
SEARCH TARGET
 B
SINGLE
SCALE/DIV
AUTO SCALE
MKR
DELTA MKR MODE OFF
MARKER 1
TITLE
 [MKR]
TITLE TO MEMORY
Trans: FWD S21 (B/R)
DO SEQUENCE
 SEQUENCE 3

```

This sequence measures the amplifier's gain compression versus swept power at a CW frequency. A similar measurement of gain compression is shown in Figure 2.

The amplifier's maximum small signal gain is found and established as a reference by using the marker search maximum, and marker zero functions.

Searching for the amplifier's 1 dB compression point is done by setting the target value to -1 dB and using the search target function.

The search minimum function is used to insure that if the amplifier does not compress by at least 1 dB at maximum source output power (+ 20dBm), it will return a maximum amplifier output power.

By turning delta marker mode off the amplifier's output power at 1 dB gain compression is stored in the active marker (marker 1).

The 1 dB gain compression point contained in marker 1 is put into the title string and stored in a position in the memory array. Once all data has been taken the memory trace will be displayed versus frequency.

```

SEQUENCE COMP3
Start of Sequence
LIN FREQ
MKR
MARKER 2
MKR ZERO
 118 M/u
DELTA MKR MODE OFF
MARKER -> CW
MKR
MARKER 1
POWER SWEEP
SINGLE
DECR LOOP COUNTER
IF LOOP COUNTER <> 0 THEN DO
 SEQUENCE 2
DISPLAY: MEMORY
REAL
SCALE/DIV
AUTO SCALE
LIN FREQ
CONTINUOUS
SCALE/DIV
AUTO SCALE
MKR
MARKERS: DISCRETE
TITLE
 1 DB GAIN COMPRESSION U=DBM

```

Marker frequency values cannot be changed in power sweep mode. Therefore, the sweep type is changed to linear frequency.

Marker 2 holds the CW measurement information. Its value is incremented by adding the marker zero value to the previous measurement frequency. The marker zero value, is given by the equation below.

$$\text{Marker zero value} = \frac{\text{Stop Freq.} - \text{Start Freq.}}{(\# \text{ of Points}) - 1}$$

Marker 1 is made active, the analyzer is put back into power sweep and the loop counter is decremented. Until the loop counter value is equal to zero (all data points measured), this sequence will branch back to sequence position 2 (COMP2) to take another data point.

Once the loop counter is equal to zero the data stored in the memory trace is scaled and displayed.

### 3. Test automation through external device control.

This example demonstrates how the HP 8753B can control external devices over HP-IB, and use a loop counter to make a stepped measurement. A block diagram for this measurement is shown in figure 5.

**CONLOSS1.** This sequence initializes the analyzer and external sources prior to the measurement. This preparation includes addressing and initializing the two sources, putting the analyzer into tuned receiver mode, setting up a frequency list of 26 points, and setting the loop counter value to 26.

**CONLOSS2.** This sequence takes data, increments source frequencies and decrements the loop counter until all 26 measurements are made, and the loop counter value is equal to zero. Once the data has been taken, the conversion loss data is displayed, and the addresses used for the sources are returned to default values.

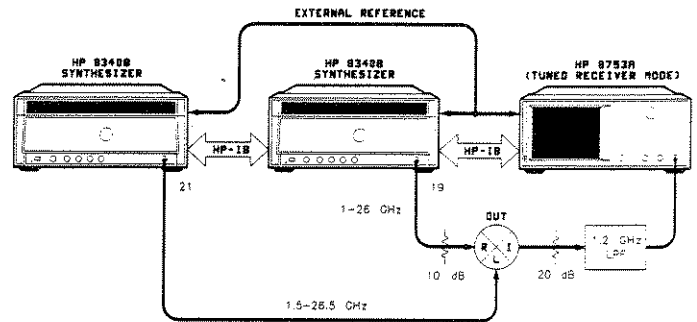

Figure 5. Block diagram for a fixed IF mixer conversions loss measurement.

```

SEQUENCE CONLOSS1
Start of Sequence
RECALL PRST STATE
SYSTEM CONTROLLER
ADDRESS: PRINTER
 19x1
ADDRESS: P MTR/HPIB
 21x1
TUNED RECEIVER
EDIT LIST
ADD
CW FREQ
 500 M/u
NUMBER of POINTS
 26x1
DONE
DONE
LIST FREQ
LOOP COUNTER
 26x1
 B
SCALE/DIV
 2 x1
REFERENCE POSITION
 0 x1
REFERENCE VALUE
 -20x1
MANUAL TRG ON POINT
TITLE
 PL0.2DB;SF16Z;CW16Z;
TITLE TO PRINTER
TITLE
 PL8DB;SF16Z;CW16Z;
TITLE TO P MTR/HPIB
DO SEQUENCE
SEQUENCE 2

```

HP-IB addresses are assigned to the two external sources to be used. One source will reside at HP-IB address 19, presently the system printer address, while the other will be at HP-IB address 21, presently the system power meter address.

This measurement is made in tuned receiver mode, with a 26 point, CW list frequency sweep.

The loop counter value is set to the number of measurement points to be used, in this case 26.

The two sources are initialized to the necessary power levels, step frequencies, and start frequencies.

```

SEQUENCE CONLOSS2
Start of Sequence
MANUAL TRG ON POINT
TITLE
UP;
TITLE TO PRINTER
TITLE TO P MTR/HP1B
DECR LOOP COUNTER
IF LOOP COUNTER <> 0 THEN DO
 SEQUENCE 2
TITLE
 DMS1-26 CONVERSION LOSS RF=1-266HZ
ADDRESS: PRINTER
 1 x1
ADDRESS: P MTR/HP1B
 13x1

```

CONLOSS2 triggers the analyzer to take a data point, instructs the sources to step up in frequency, and decrements the loop counter. This is repeated until the loop counter value is equal to zero. Conversion loss data is then displayed, and HP-IB printer and power meter addresses are returned to 1 and 13 respectively.

#### 4. Annotating the HP 8753B's CRT with multiple markers for quick device characterization.

This example simultaneously displays eight markers and their values on a single trace, through the use of Hewlett-Packard Graphics Language (HP-GL) commands. The resulting display is shown in figure 6. For more information on HP 8753B display graphics and HP-GL commands, refer to Appendix D of the *HP 8753B Quick Reference Guide*.

**MKR1.** This sequence sets up measurement parameters and channel 1 markers for a SAW filter insertion loss measurement. Once completed, this sequence calls sequence position 2 (MKR2).

**MKR2.** This sequence sets up measurement parameters and channel 2 markers for a SAW filter insertion loss measurement. Once completed, this sequence prints the measurement results and returns the analyzer to continuous sweep mode.

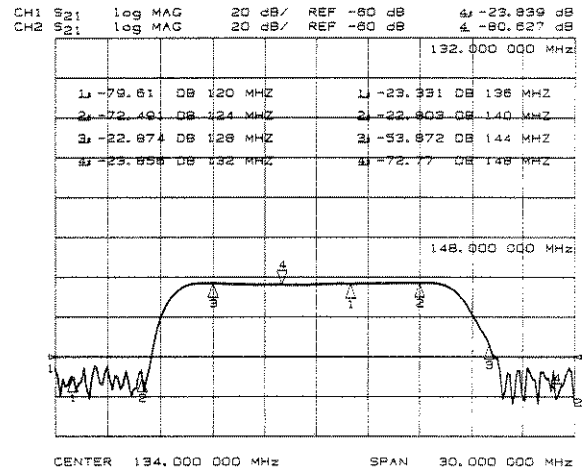

Figure 6. Display of a filter's transmission response including 8 markers and their values.



SEQUENCE MKR1  
Start of Sequence  
RECALL PRST STATE  
Trans: FWD S21 (B/R)

Choosing channel 1 measurement parameters.

POWER  
0 x1  
CENTER  
134 M/u  
SPAN  
30M/u  
LOG MAG  
SCALE/DIV  
20x1  
REFERENCE POSITION  
2 x1  
REFERENCE VALUE  
-60x1  
ADDRESS: PRINTER  
1 x1

Setting the system power meter address to 17, the HP 8753B's display graphics address.

ADDRESS: P MTR/HPIB  
17x1

SYSTEM CONTROLLER

SINGLE

MKR

MARKER 1

120 M/u

TITLE

PU;PA550/3300;LB[MKR][ACT][EOL]

TITLE TO P MTR/HPIB

MKR

MARKER 2

124 M/u

TITLE

PU;PA550/3100;LB[MKR][ACT][EOL]

TITLE TO P MTR/HPIB

MKR

MARKER 3

128 M/u

TITLE

PU;PA550/2900;LB[MKR][ACT][EOL]

TITLE TO P MTR/HPIB

MKR

MARKER 4

132 M/u

TITLE

PU;PA550/2700;LB[MKR][ACT][EOL]

TITLE TO P MTR/HPIB

TITLE

Activating marker 1 on channel 1, moving it to 120 MHz, and positioning frequency and magnitude display information on the CRT.

Activating marker 2 on channel 1, moving it to 124 MHz, and positioning frequency and magnitude display information on the CRT.

Activating marker 3 on channel 1, moving it to 128 MHz, and positioning frequency and magnitude display information on the CRT.

Activating marker 4 on channel 1, moving it to 132 MHz, and positioning frequency and magnitude display information on the CRT.

DO SEQUENCE  
SEQUENCE 2

SEQUENCE MKR2

Start of Sequence

CH 2

Trans: FWD S21 (B/R)

POWER

0 x1

LOG MAG

CENTER

134 M/u

SPAN

30M/u

SCALE/DIV

20x1

REFERENCE POSITION

2 x1

REFERENCE VALUE

-60x1

MKR

MARKERS: UNCOUPLED

SPLIT DISP

OFF

DUAL CHAN

ON

ADDRESS: PRINTER

1 x1

ADDRESS: P MTR/HPIB

17x1

SYSTEM CONTROLLER

SINGLE

MARKER 1

136 M/u

TITLE

PU;PA3000/3300;LB[MKR][ACT][EOL]

TITLE TO P MTR/HPIB

MKR

MARKER 2

140 M/u

TITLE

PU;PA3000/3100;LB[MKR][ACT][EOL]

TITLE TO P MTR/HPIB

MKR

MARKER 3

144 M/u

TITLE

PU;PA3000/2900;LB[MKR][ACT][EOL]

TITLE TO P MTR/HPIB

MKR

MARKER 4

148 M/u

TITLE

PU;PA3000/2700;LB[MKR][ACT][EOL]

TITLE TO P MTR/HPIB

TITLE

PRINT

CONTINUOUS

Choosing channel 2 measurement parameters.

Activating marker 1 on channel 2, moving it to 136 MHz, and positioning frequency and magnitude display information on the CRT.

Activating marker 2 on channel 2, moving it to 140 MHz, and positioning frequency and magnitude display information on the CRT.

Activating marker 3 on channel 2, moving it to 144 MHz, and positioning frequency and magnitude display information on the CRT.

Activating marker 4 on channel 2, moving it to 148 MHz, and positioning frequency and magnitude display information on the CRT.

## 5. Guided measurements using HP-GL user graphics.

This example uses HP-GL commands to create two connection diagrams, and displays them on the analyzer's CRT. The purpose of these diagrams is to lead a user through an interactive measurement, including a power meter calibration of the HP 8753B's test port power. For more information on HP 8753B display graphics and HP-GL commands, refer to Appendix D of the *HP 8753B Quick Reference Guide*.

**UG1.** This sequence uses HP-GL commands to draw and display the connection diagram for a power meter calibration. The resulting CRT display is shown in figure 7. Once this sequence has been completed, sequence position 2 (UG2) is called.

**UG2.** This procedure sets measurement parameters, performs a one sweep power meter calibration, stores the chosen instrument state to disc, and calls sequence position 3 (UG3).

**UG3.** This sequence uses HP-GL commands to draw and display the connection diagram for device characterization. The resulting CRT display is shown in figure 8. Once this sequence has been completed, sequence position 4 (UG4) is called.

**UG4.** This procedure recalls the instrument state stored in UG2, and performs the measurement of the device under test.

```

SEQUENCE UG1
Start of Sequence
SYSTEM CONTROLLER
ADDRESS: PRINTER
 17x1
TITLE
 AF;CS;
TITLE TO PRINTER
TITLE
 PU;PA500/2200;PD;
TITLE TO PRINTER
TITLE
 PR2700/0/0/1000/-2700/0/0/-1000;PU;
TITLE TO PRINTER
TITLE
 PU;PA600/2300;PD;
TITLE TO PRINTER
TITLE
 PR1200/0/0/800/-1200/0/0/-800;PU;
TITLE TO PRINTER
TITLE
 PU;PA500/3200;PD;PA800/3400;
TITLE TO PRINTER
TITLE
 PA2900/3400;PA3200/3200;
TITLE TO PRINTER

```

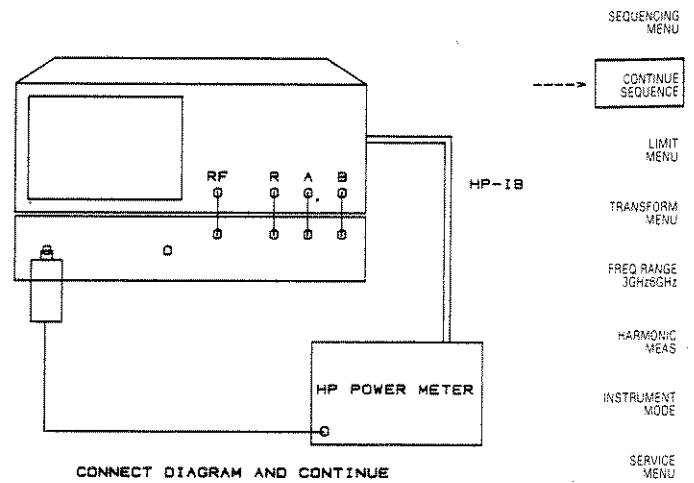

Figure 7. HP-GL diagram for a power meter calibration connection.

Putting the analyzer into system controller mode. Setting the CRT's HP-IB address (17) to the system printer's address, and clearing the graphics and measurement display.

Drawing the outside box of the HP 8753B.

Drawing the display of the HP 8753B.

Drawing the perspective lines for the outside box of the HP 8753B.

TITLE  
 PU;PA2800/400;PD;  
 TITLE TO PRINTER  
 TITLE  
 PR1300/0/0/800/-1300/0/0/-800;PU;  
 TITLE TO PRINTER  
 TITLE  
 PA2875/475;LB0[EOL]  
 TITLE TO PRINTER  
 TITLE  
 PU;PA2895/500;PD;PA735/500;PU;  
 TITLE TO PRINTER  
 TITLE  
 PU;PA735/500;PD;PA735/1350;PU;  
 TITLE TO PRINTER  
 TITLE  
 PA2850/800;LBHP POWER METER[EOL]  
 TITLE TO PRINTER  
 TITLE  
 PU;PA700/1830;PD;  
 TITLE TO PRINTER  
 TITLE  
 PR90/0/0/70/-90/0/0/-70;PU;  
 TITLE TO PRINTER  
 TITLE  
 PU;PA625/1350;PD;  
 TITLE TO PRINTER  
 TITLE  
 PR240/0/0/480/-240/0/0/-480;PU;  
 TITLE TO PRINTER  
 TITLE  
 PU;PA3800/1200;PD;PA3800/2750;PU;  
 TITLE TO PRINTER  
 TITLE  
 PU;PA3800/2750;PD;PA3200/2750;PU;  
 TITLE TO PRINTER  
 TITLE  
 PU;PA3850/1200;PD;PA3850/2800;PU;  
 TITLE TO PRINTER  
 TITLE  
 PU;PA3850/2800;PD;PA3200/2800;PU;  
 TITLE TO PRINTER  
 TITLE  
 PA4000/2400;LBHP-IB[EOL]  
 TITLE TO PRINTER  
 TITLE  
 PU;PA500/1670;PD;  
 TITLE TO PRINTER  
 TITLE  
 PR2700/0/0/500/-2700/0/0/-500;PU;  
 TITLE TO PRINTER  
 TITLE  
 PA1875/2325;LB o o o o[EOL]  
 TITLE TO PRINTER  
 TITLE  
 PA1875/2000;LB o o o o[EOL]

Drawing the power meter box.

Drawing the power meter sensor port.

Drawing lines for the power meter sensor connection.

Drawing the power meter sensor.

Drawing the HP-IB connection between the HP 8753B and the power meter.

Labeling the HP-IB connection.

Drawing the test set box.

Labeling the analyzer ports.

Positioning the test set ports using a label statement.

TITLE TO PRINTER

TITLE

PAS45/1875;LB o o[EOL]

TITLE TO PRINTER

TITLE

PA1875/2450;LB R A B[EOL]

TITLE TO PRINTER

TITLE

PA2000/2450;LBRF[EOL]

TITLE TO PRINTER

TITLE

PU;PA2075/2025;PD;PA2075/2360;PU;

Drawing test set interconnect cables.

TITLE TO PRINTER

TITLE

PU;PA2503/2025;PD;PA2503/2360;PU;

TITLE TO PRINTER

TITLE

PU;PA2762/2025;PD;PA2762/2360;PU;

TITLE TO PRINTER

TITLE

PU;PA3020/2025;PD;PA3020/2360;PU;

TITLE TO PRINTER

TITLE

PA1000/150;LBCONNECT DIAGRAM AND CONTINUE[EOL]

TITLE TO PRINTER

Writing instructions to CRT. Written twice for double intensity.

TITLE

PA1000/150;LBCONNECT DIAGRAM AND CONTINUE[EOL]

TITLE TO PRINTER

TITLE

PA4725/3375;LB---->[EOL]

Drawing the softkey arrow and box.

TITLE TO PRINTER

TITLE

PU;PA5150/3250;PD;

TITLE TO PRINTER

TITLE

PR700/0/0/300/-700/0/0/-300;

TITLE TO PRINTER

TITLE

PU;

TITLE TO PRINTER

SYSTEM

PAUSE

DO SEQUENCE

SEQUENCE 2

SEQUENCE UG2  
Start of Sequence  
RECALL PRST STATE  
POWER MTR:  
438A/437  
ADDRESS: P MTR/HPIB  
13x1  
Trans: FWD S21 (B/R)  
START  
20M/u  
STOP  
1 G/n  
NUMBER of POINTS  
25x1  
PWRMTR CAL  
NUMBER of READINGS  
2 x1  
ONE SWEEP  
0 x1  
TAKE CAL SWEEP  
WAIT x  
0 x1  
SAVE 1  
TITLE  
POWER METER CAL COMPLETED  
SYSTEM  
PAUSE  
DO SEQUENCE  
SEQUENCE 3

Setting measurement parameters.

Performing a one sweep power meter calibration.

Storing the chosen instrument state, and calling sequence position 3 (UG3).

SEQUENCE UG3  
Start of Sequence  
TITLE  
AF;CS;  
TITLE TO PRINTER  
TITLE  
PU;PA500/2200;PD;  
TITLE TO PRINTER  
TITLE  
PR2700/0/0/1000/-2700/0/0/-1000;PU;  
TITLE TO PRINTER  
TITLE  
PU;PA600/2300;PD;  
TITLE TO PRINTER  
TITLE  
PR1200/0/0/800/-1200/0/0/-800;PU;  
TITLE TO PRINTER  
TITLE  
PU;PA500/3200;PD;PA800/3400;  
TITLE TO PRINTER  
TITLE  
PA2900/3400;PA3200/3200;

Drawing the outside box of the HP 8753B.

Drawing the display of the HP 8753B.

Drawing the perspective lines for the outside box of the HP 8753B.

```

TITLE TO PRINTER
TITLE
 PU;PA500/1670;PD;
TITLE TO PRINTER
TITLE
 PR2700/0/0/500/-2700/0/0/-500;PU;
TITLE TO PRINTER
TITLE
 PU;PA900/950;PD;
TITLE TO PRINTER
TITLE
 PR640/0/0/300/-640/0/0/-300;PU;
TITLE TO PRINTER
TITLE
 PA950/1050;LB DUT[EOL]
TITLE TO PRINTER
TITLE
 PU;PA750/1900;PD;PA750/1100;PU;
TITLE TO PRINTER
TITLE
 PU;PA750/1100;PD;PA900/1100;PU;
TITLE TO PRINTER
TITLE
 PU;PA1690/1900;PD;PA1690/1100;PU;
TITLE TO PRINTER
TITLE
 PU;PA1690/1100;PD;PA1540/1100;PU;
TITLE TO PRINTER
TITLE
 PA1875/2325;LB o o o o[EOL]
TITLE TO PRINTER
TITLE
 PA1875/2000;LB o o o o[EOL]
TITLE TO PRINTER
TITLE
 PA545/1875;LB o o[EOL]
TITLE TO PRINTER
TITLE
 PA1875/2450;LB R A B[EOL]
TITLE TO PRINTER
TITLE
 PA2000/2450;LBRF[EOL]
TITLE TO PRINTER
TITLE
 PU;PA2075/2025;PD;PA2075/2360;PU;
TITLE TO PRINTER
TITLE
 PU;PA2503/2025;PD;PA2503/2360;PU;
TITLE TO PRINTER
TITLE
 PU;PA2762/2025;PD;PA2762/2360;PU;
TITLE TO PRINTER
TITLE
 PU;PA3020/2025;PD;PA3020/2360;PU;
TITLE TO PRINTER
TITLE
 PA1700/400;LBCONNECT DUT AND CONTINUE[EOL]

```

Drawing the test set box.

Drawing the device under test (DUT).

Labeling the DUT.

Drawing the DUT connections.

Positioning the test set ports using a label statement.

Labeling the analyzer ports.

Drawing the test set interconnect cables.

Writing instructions to the CRT. Written twice for double intensity.

```

TITLE TO PRINTER
TITLE
PA1700/400;LBCONNECT DUT AND CONTINUE[EOL]
TITLE TO PRINTER
TITLE
PA4725/3375;LB---->[EOL]
TITLE TO PRINTER
TITLE
PU;PA5150/3250;PD;
TITLE TO PRINTER
TITLE
PR700/0/0/300/-700/0/0/-300;
TITLE TO PRINTER
TITLE
PU;
TITLE TO PRINTER
SYSTEM
PAUSE
DO SEQUENCE
SEQUENCE 4

```

Drawing the softkey arrow and box.

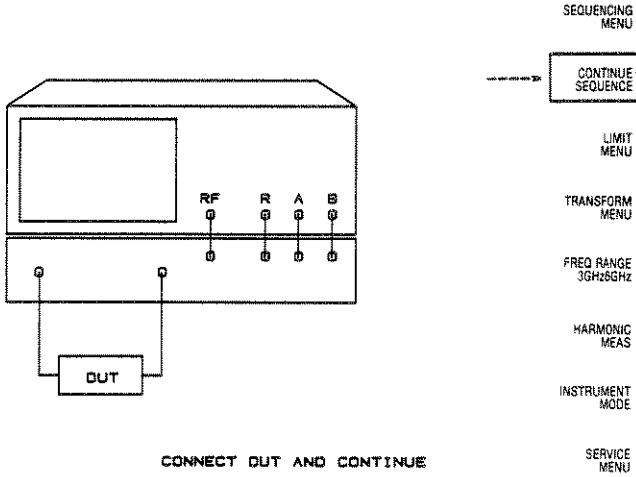

Figure 8. HP-SL diagram for a 2-port measurement.

```

SEQUENCE UG4
Start of Sequence
RECALL 1

```

Recalling register 1 with the DUT connected, and making the measurement.



# Test Sequence Function Menu Map

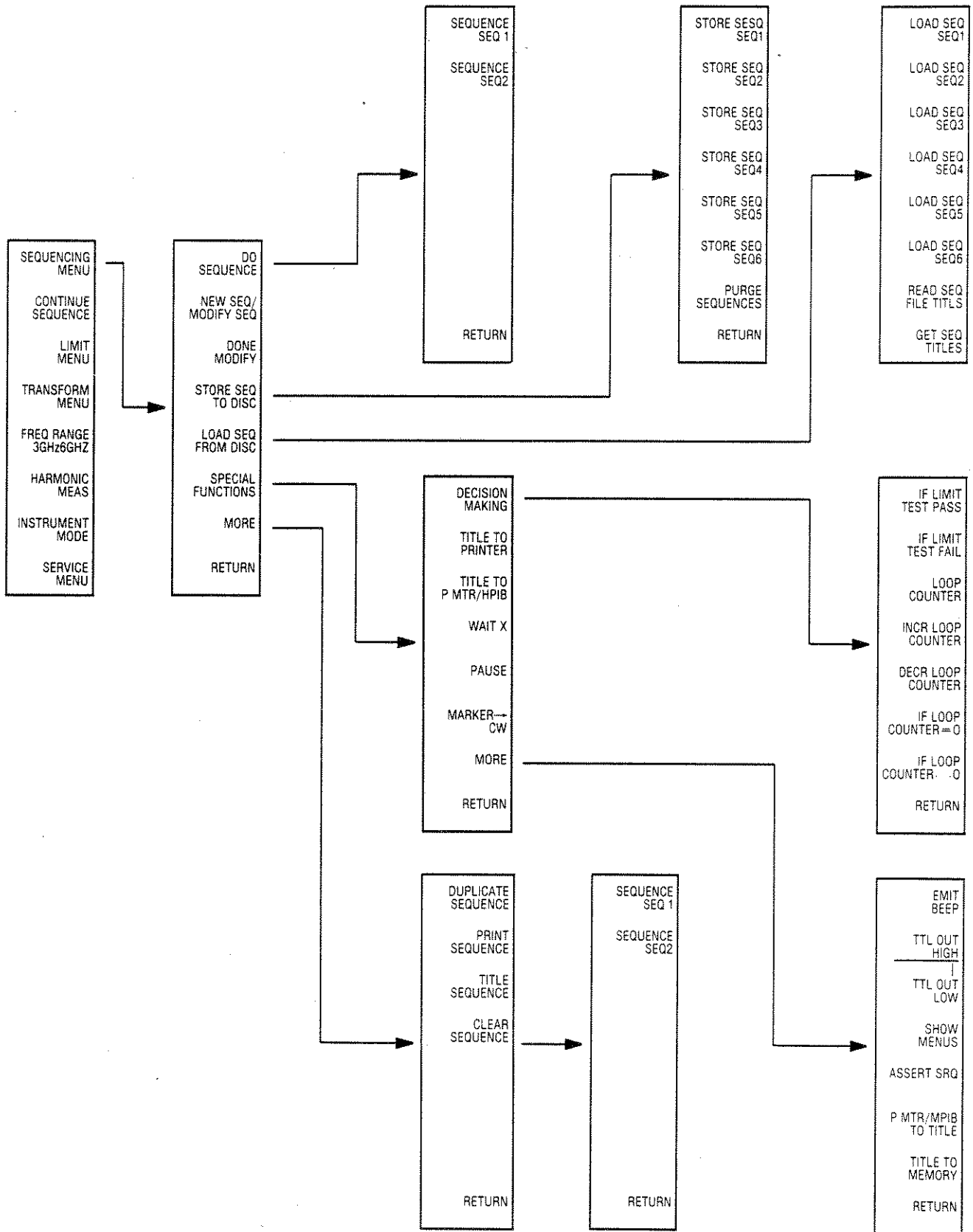

# Advanced softkey descriptions

[*TITLE TO PRINTER*] outputs a title string including letters, numbers, punctuation, and several control characters, to any device residing at the system printer's address. This function automatically appends a carriage return/line feed to the desired string. This command requires that the HP 8753B is in system controller or pass control mode and the system bus is clear of all other devices residing at the system printer's address. The system printer's address is set with the HP 8753B [*LOCAL*][*SET ADDRESSES*][*ADDRESS:PRINTER*] commands.

[*TITLE TO PMTR/HPIB*] outputs a title string including letters, numbers, punctuation, and several control characters to any device residing at the system power meter's address. This command requires that the HP 8753B is in system controller or pass control mode and the system bus is clear of all other devices residing at the system power meter's address. The system power meter's address is set with the HP 8753B [*LOCAL*][*SET ADDRESSES*][*ADDRESS:PMTR/HPIB*] commands.

[*WAIT X*] pauses the execution of a sequence for X seconds. [*WAIT*][*0*][*x1*] is a special case of the wait function, it causes the sequence to wait for previous statements to execute before proceeding.

[*PAUSE*] temporarily stops the execution of a sequence. The keyboard is freed up allowing the user to change an instrument parameter or modify an equipment configuration. The sequence can be restarted by pressing the [*CONTINUE SEQUENCE*] softkey.

[*MARKER ->CW*] moves the CW frequency of the HP 8753B to the marker stimulus value. An application of this function is locating a specific frequency on a swept trace (e.g. occurrence of a maximum, or minimum), and then viewing the response of the device at that specific frequency vs. power.

[*IF LIMIT TEST PASS*] causes the sequence under execution to branch to a pre-chosen sequence position if the limit test just completed was passed. If the limit test was failed, the sequence under execution will not branch, and instead will continue down the present command list.

[*IF LIMIT TEST FAIL*] causes the sequence under execution to branch to a pre-chosen sequence position if the limit test just completed was failed. If the limit test was passed the sequence under execution will not branch, and instead will continue down the present command list.

[*LOOP COUNTER*] allows the user to set the initial value of a loop counter.

[*INCR LOOP COUNTER*] increments the value of the loop counter by 1.

[*DECR LOOP COUNTER*] decrements the value of the loop counter by 1.

[*IF LOOP COUNTER = 0*] causes the sequence under execution to branch to a pre-chosen sequence position if the loop counter value is equal to zero. If the loop counter value is not equal to zero, the sequence under execution will not branch, and instead will continue down the present command list.

[*IF LOOP COUNTER <> 0*] causes the sequence under execution to branch to a pre-chosen sequence position if the loop counter value is not equal to zero. If the loop counter value is equal to zero, the sequence under execution will not branch, and instead will continue down the present command list.

[*EMIT BEEP*] emits a beep of fixed tone and duration during the execution of a sequence.

[*TTL OUT HIGH*] sets the TTL line at the back of the HP 85047A test set high.

[*TTL OUT LOW*] sets the TTL line at the back of the HP 85047A test set low.

[*SHOW MENUS*] this command enables the recall of menus from within a sequence. This is especially useful for prompting someone for a softkey response in an interactive test situation.

[*ASSERT SRQ*] enables the HP 8753B to request service from an external controller, when a sequence has been completed or paused. For more information on status reporting structure, refer to the *HP 8753B Quick Reference Guide*.

*[PMTR/HPIB TO TITLE]* reads a single scalar value from any device residing at the system power meter's address. This command requires that the HP 8753B is in system controller or pass control mode and the system bus is clear of all other devices residing at the system power meter's address (e.g. a power meter). The system power meter's address is set with the HP 8753B *[LOCAL][SET ADDRESSES]* *[ADDRESS:PMTR/HPIB]* commands. The acquired data is stored in a title string.

*[TITLE TO MEMORY]* strips the numeric (i.e. scalar) information from the string read in by the *[PMTR/HPIB TO TITLE]* function, and stores in into a location in the memory data array. The location of the data in the memory array is calculated using the equation:

Memory Display Point = Total Points – Loop Counter + 1.

*[ACTIVE ENTRY]* puts the active entry value into the title string. Once in the string, this value can be printed, stored, or used by other test sequence function commands, such as *[TITLE TO MEMORY]*, *[TITLE TO PRINTER]*, and *[TITLE TO PMTR/HPIB]*.

*[ACTIVE MKR MAGNITUDE]* puts the active marker magnitude into the title string. Once in the string, this value can be printed, stored, or used by other test sequence function commands, such as *[TITLE TO MEMORY]*, *[TITLE TO PRINTER]*, and *[TITLE TO PMTR/HPIB]*.

*[LIMIT TEST RESULT]* puts the present limit test result into the title string. Using this function the limit test results of a specific device can be recorded with a plot or print of the device data.

*[LOOP COUNTER]* puts the present loop counter value into the title string. Using this function device data can be numbered and cataloged.

*[END OF LABEL]* terminates the HP-GL label command (LB).





**For more information, call your local HP sales office listed in your telephone directory or an HP regional office listed below for the location of your nearest sales office.**

**United States:**

Hewlett-Packard Company  
4 Choke Cherry Road  
Rockville, MD 20850  
(301) 670-4300

Hewlett-Packard Company  
5201 Tollview Drive  
Rolling Meadows, IL 60008  
(312) 255-9800

Hewlett-Packard Company  
5161 Lankershim Blvd.  
No. Hollywood, CA 91601  
(818) 505-5600

Hewlett-Packard Company  
2015 South Park Place  
Atlanta, GA 30339  
(404) 955-1500

**Canada:**

Hewlett-Packard Ltd.  
6877 Goreway Drive  
Mississauga, Ontario L4V1M8  
(416) 678-9430

**Japan:**

Yokogawa-Hewlett-Packard Ltd.  
29-21, Takaido-Higashi 3-chome  
Suginami-ku, Tokyo 168  
(03) 331-6111

**Latin America:**

Latin American Region Headquarters  
Monte Pelvoux Nbr. 111  
Lomas de Chapultepec  
11000 Mexico, D.F. Mexico  
(905) 596-79-33

**Australia/New Zealand:**

Hewlett-Packard Australia Ltd.  
31-41 Joseph Street,  
Blackburn, Victoria 3130  
Melbourne, Australia  
(03) 895-2895

**Far East:**

Hewlett-Packard Asia Ltd.  
22/F Bond Centre  
West Tower  
89 Queensway  
Central, Hong Kong  
(5) 8487777

**Germany:**

Hewlett-Packard GmbH  
Vertriebzentrale Deutschland  
Hewlett-Packard-Strasse  
Postfach 1641  
6380 Bad Homburg v.d.H.  
Federal Republic of Germany  
06172/400-0

**France:**

Hewlett-Packard France  
Parc d'activité du Bois Briard  
2, avenue du Lac  
91040 Evry Cedex  
01/60 77 83 83

**United Kingdom:**

Hewlett-Packard Limited  
Enquiry Group  
Customer Support Centre  
Eskdale Road  
Winnersh Triangle  
Wokingham  
Berkshire RG11 5DZ  
0734/69 66 22

**Italy:**

Hewlett-Packard Italiana S.p.A.  
Via G. di Vittorio, 9  
20063 Cernusco Sul Naviglio (MI)  
Milano  
02/923691

**European Multi Country Region:**

Hewlett-Packard S.A.  
Route du Nant d'Avril 150  
1217 Meyrin 2 - Geneva  
Switzerland  
(41) 22/83 81 11

**Or write to:**

**United States:**

Hewlett-Packard S.A.  
P.O. Box 10301,  
Palo Alto, CA 94303-0890

**Europe/Middle East/Africa:**

Hewlett-Packard S.A.  
Central Mailing Department,  
P.O. Box 529  
1180 AM Amstelveen,  
The Netherlands

**For all other areas:**

Hewlett-Packard Company  
Intercontinental Headquarters  
3495 Deer Creek Rd.  
Palo Alto, CA 94304  
U.S.A.

## Introductory Programming Guide

For the HP 8753B network analyzer

with the HP 9000 series 200/300 desktop computer (BASIC)

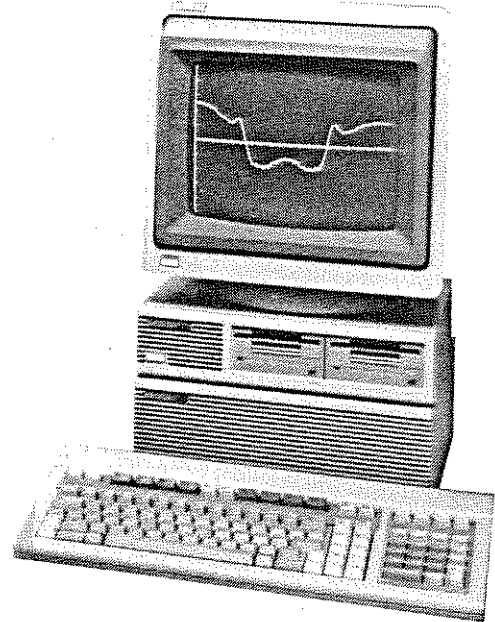
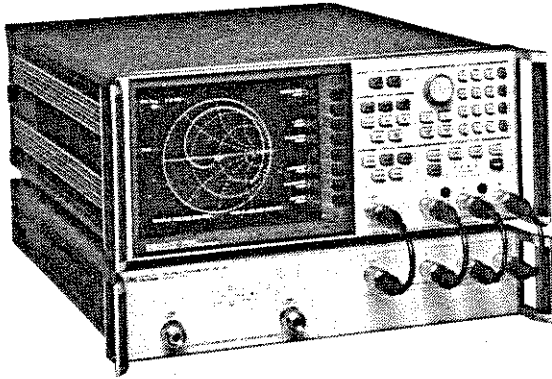

## Introduction

This programming note is an introduction to remote operation of the HP 8753B network analyzer using an HP 9000 series 200 or 300 computer. It is a tutorial introduction, using BASIC programming examples to demonstrate the remote operation of the HP 8753B. The examples are on the Example Programs disc (part number 08753-10010), included with the HP 8753B operating manual. This document is closely associ-

ated with the HP 8753B HP-IB *Quick Reference Guide* (part number 08753-90118.) The *Quick Reference Guide* provides complete programming information in a very concise format. Included in the *Quick Reference Guide* are both functional and alphabetical lists of HP-IB commands. The HP 8753B *Quick Operating Guide* also lists HP-IB commands, along with its softkey menu explanations.

## Table of Contents

|                                                                 |    |                                                   |    |
|-----------------------------------------------------------------|----|---------------------------------------------------|----|
| Basic Instrument Control .....                                  | 3  | Using limit lines to perform limit testing:       |    |
| Measurement Programming .....                                   | 6  | 5A. Setting up limit lines .....                  | 22 |
| Basic Programming Examples:                                     |    | 5B. Performing PASS/FAIL tests while tuning ..... | 24 |
| 1. Setting up a basic measurement .....                         | 7  | Storing and recalling instrument states:          |    |
| Performing a measurement calibration:                           |    | 6A. Using the learn string .....                  | 25 |
| 2A. S11 1-port calibration .....                                | 8  | 6B. Coordinating disc storage .....               | 26 |
| 2B. Full 2-port calibration .....                               | 10 | 6C. Reading calibration data .....                | 26 |
| Data transfer from analyzer to computer:                        |    | Miscellaneous Programming Examples:               |    |
| 3A. Data transfer using ASCII transfer format .....             | 14 | Controlling peripherals:                          |    |
| 3B. Data transfer using IEEE 64 bit floating point format ..... | 16 | 7A. Operation using Talker/Listener mode .....    | 28 |
| 3C. Data transfer using HP 8753B internal binary format .....   | 17 | 7B. Operation using pass control mode .....       | 29 |
| Advanced Programming Examples:                                  |    | 8. Creating a user interface .....                | 30 |
| Using list frequency mode:                                      |    | Transferring disc data files:                     |    |
| 4A. Setting up a list frequency sweep .....                     | 19 | 9. Reading data files into a computer .....       | 32 |
| 4B. Selecting a single segment from a table of segments .....   | 21 | Appendix A: Status Reporting .....                | 33 |
|                                                                 |    | A1. Using the error queue .....                   | 33 |
|                                                                 |    | A2. Using the status registers .....              | 35 |
|                                                                 |    | A3. Generating interrupts .....                   | 35 |

The Hewlett-Packard computers specifically addressed are the HP 9000 series 200 and 300 computers, operating with BASIC 2.0 with AP2—1, or BASIC 3.0 or higher. This includes the 216 (9816), 217 (9817), 220 (9920), 226 (9826), 236 (9836), 310 and 320 computers.

The reader should become familiar with the operation of the HP 8753B before controlling it over HP-IB. Also, this document is not intended to teach BASIC programming or to discuss HP-IB theory except at an introductory level: see below for documents better suited to these tasks.

### For more information

For more information concerning the operation of the HP 8753B, refer to the following:

|                                            |             |
|--------------------------------------------|-------------|
| <i>User's Guide</i>                        | 08753-90007 |
| <i>Quick Operating Guide</i>               | 08753-90116 |
| <i>Operating and Programming Reference</i> | 08753-90119 |

For more information concerning BASIC, see the manual set for the BASIC revision being used. For example:

|                                         |             |
|-----------------------------------------|-------------|
| <i>BASIC 5.0 Programming Techniques</i> | 98613-90012 |
| <i>BASIC 5.0 Language Reference</i>     | 98613-90052 |

For more information concerning HP-IB, see:

|                                                                   |             |
|-------------------------------------------------------------------|-------------|
| <i>BASIC 5.0 Interfacing Techniques</i>                           | 98613-90022 |
| <i>Tutorial Description of the Hewlett-Packard Interface Bus</i>  | 5952-0156   |
| <i>Condensed Description of the Hewlett-Packard Interface Bus</i> | 59401-90030 |

### Required equipment

To run the examples of this *Introductory Programming Guide*, the following equipment is required:

1. HP 8753B network analyzer.
2. HP 9000 series 200 or 300 computer with enough memory to hold BASIC, needed binaries, and at least 64 kBytes of program space. In addition, 512 kBytes are needed for BASIC 3.0 or higher operating systems, with the binaries suggested in step 2 in the section *Powering up the system*. A disc drive (e.g. HP 9122) is required to load BASIC if no internal disc drive is available.
3. HP BASIC 2.0 with AP2—1, or BASIC 3.0 or higher operating system.
4. HP 10833A/B/C/D HP-IB cables to interconnect the computer, the HP 8753B, and any peripherals.

### Optional equipment

1. HP 85032B 50 ohm type-N calibration kit.
2. HP 11852D test port return cables.
3. A test device such as a filter to use in the example measurement programs.
4. HP 7440A ColorPro plotter, an HP 2225A Thinkjet printer, or an HP 9122 or HP 9153 CS80 disc drive. See the General Information section of the manual for a more complete list of compatible peripherals.

### Powering up the system

1. **Set up the HP 8753B as shown in Figure 1.**  
Connect the HP 8753B to the computer with an HP-IB cable. The HP 8753B has only one HP-IB interface, but it occupies two addresses: one for the instrument, one for the display. The display address is the instrument address with the least significant bit complemented. The default addresses are 16 for the instrument, 17 for the display. Devices on the HP-IB cannot occupy the same address as the HP 8753B.
2. **Turn on the computer and load the BASIC operating system.**  
For BASIC 2.0, load AP2—1 if available. If BASIC 3.0 or higher is used, load the following BASIC binary extensions: HPIB, GRAPH, IO, KBD, and ERR. Depending on the disc drive, a binary such as CS80 may be also be required.
3. **Turn the HP 8753B on.**  
To verify the HP 8753B's address, press [LOCAL] [SET ADDRESSES] and [ADDRESS: 8753]. If the address has been changed from 16, the default value, return it to 16 while performing the examples in this document by pressing [1] [6] [x1] and then presetting the instrument. Make sure the instrument is in either [USE PASS CONTROL] or [TALKER/LISTENER] mode, as indicated under the [LOCAL] key. These are the only modes in which the HP 8753B will accept commands over HP-IB.
4. **On the computer type the following:**  
OUTPUT 716; "PRES; " [EXECUTE] (or [RETURN])  
This will preset the HP 8753B. If Preset does not occur, there is a problem. First check all HP-IB addresses and connections: most HP-IB problems are caused by an incorrect address and bad or loose HP-IB cables.

**NOTE:** Only the 9826 and 9836 computers have an actual [EXECUTE] key. An HP 216 has an [EXEC] key with the same function. All the other computers use the [RETURN] key as both execute and enter. Throughout this document, the notation [EXECUTE] is used.

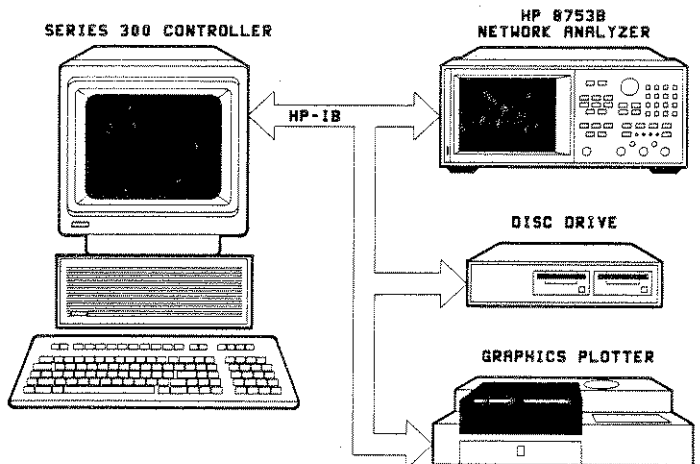

Figure 1. HP-IB connections in a typical setup.



## Basic Instrument Control

A computer controls the HP 8753B by sending it commands over HP-IB. The commands sent are specific to the HP 8753B. Each command is executed automatically upon receipt, taking precedence over manual control of the HP 8753B. A command applies only to the active channel except where functions are coupled between channels, just as with front panel operation. Most commands are equivalent to front panel functions. For example, type:

```
OUTPUT 716 ; "STAR 10 MHZ ; "
```

and press [EXECUTE].

The HP 8753B now has a start frequency of 10 MHz. The construction of the command is:

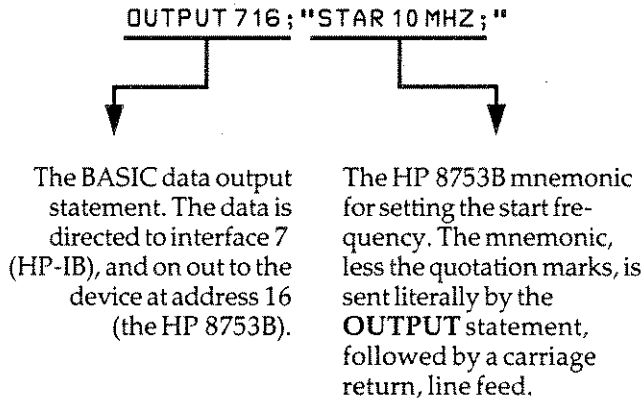

The BASIC data output statement. The data is directed to interface 7 (HP-IB), and on out to the device at address 16 (the HP 8753B).

The HP 8753B mnemonic for setting the start frequency. The mnemonic, less the quotation marks, is sent literally by the **OUTPUT** statement, followed by a carriage return, line feed.

The **STAR 10 MHZ ;** command performs the same function as pressing [START] and keying in 10 [M/u]. **STAR** is the root mnemonic for the start key, 10 is the data, and **MHZ** are the units. The HP 8753B's root mnemonics are derived from the equivalent key label where possible, otherwise from the common name for the function. The *Quick Reference Guide* lists all the root mnemonics, and all the different units accepted.

The semicolon following **MHZ** terminates the command inside the HP 8753B. It removes start frequency from the active entry area, and prepares the HP 8753B for the next command. If there is a syntax error in a command, the HP 8753B will ignore the command and look for the next terminator. When it finds the next terminator, it starts processing incoming commands normally. Characters between the syntax error and the next terminator are lost. A line feed also acts as terminator. The BASIC **OUTPUT** statement transmits a carriage return, line feed following the data. This can be suppressed by putting a semicolon at the end of the statement.

The **OUTPUT 716 ;** statement will transmit all items listed, as long as they are separated by commas or semicolons. It will transmit literal information enclosed in quotes, numeric variables, string variables, and arrays. A carriage return, line feed is transmitted after each item. This can be suppressed by separating items with semicolons rather than commas.

Note that the front panel remote (R) and listen (L) HP-IB status indicators are on: the HP 8753B automatically goes into remote mode when sent a command with the **OUTPUT**

statement. In remote mode, the HP 8753B ignores all front panel keys except the local key. Pressing the [LOCAL] key returns the HP 8753B to manual operation, unless the universal HP-IB command **LOCAL LOCKOUT 7** has been issued. The only way to get out of local lockout is to either issue the **LOCAL 7** command, or to cycle power on the HP 8753B.

Setting a parameter is just one form of command the HP 8753B will accept. It will also accept simple commands that require no operand at all. For example, execute:

```
OUTPUT 716 ; "AUTO ; "
```

In response, the HP 8753B autoscales the active channel. Autoscale only applies to the active channel, unlike start frequency, which applies to both channels as long as the channels are stimulus coupled.

The HP 8753B will also accept commands that turn various functions on and off. Execute:

```
OUTPUT 716 ; "DUACON ; "
```

This causes the HP 8753B to display both channels. To go back to single channel display mode, execute:

```
OUTPUT 716 ; "DUACOFF ; "
```

The construction of the command starts with the root mnemonic **DUAC** (dual channel display,) and **ON** or **OFF** is appended to the root to form the entire command.

The HP 8753B does not distinguish between upper and lower case letters. For example, execute:

```
OUTPUT 716 ; "auto ; "
```

The HP 8753B also has a debug mode to aid in troubleshooting systems. When debug mode is on, the HP 8753B scrolls incoming HP-IB commands across the display. To turn the mode on manually, press [LOCAL] [HP-IB DIAGON]. To turn it on over HP-IB, execute:

```
OUTPUT 716 ; "DEBUON ; "
```

### Command interrogate

Suppose the operator has changed the power level from the front panel. The computer can find out the new power level using the HP 8753B's command interrogate function. If a question mark is appended to the root of a command, the HP 8753B will output the value of that function. For instance, **POWE 7 DB ;** sets the output power to 7 dB, and **POWE ? ;** outputs the current RF output power at the test port. For example, type **SCRATCH** and press [EXECUTE] to clear old programs. Type **EDIT** and press [EXECUTE] to get into the edit mode. Then type in:

```
10 OUTPUT 716 ; "POWE ? ; "
20 ENTER 716 ; Reply
30 DISP Reply
40 END
```

Run the program. The computer will display the source power level in dBm. The preset source power level is 0 dBm. Change the power level by pressing [LOCAL][MENU][POWER] and then entering [1][5][x1]. Now run the program again.

When the HP 8753B receives `POWE?`, it prepares to transmit the current RF source power level. The BASIC statement `ENTER 716` allows the HP 8753B to transmit information to the computer by addressing it to talk. This turns the HP 8753B front panel talk light (T) on. The computer places the data transmitted by the HP 8753B into the variables listed in the enter statement. In this case, the HP 8753B transmits the output power, which gets placed in the variable `Reply`.

The `ENTER` statement takes the stream of binary data output by the HP 8753B and reformats it back into numbers and ASCII strings. With the formatting in its default state, the enter statement will format the data into real variables, integers, or ASCII strings, depending on the variable being filled. The variable list must match the data the HP 8753B has to transmit: if there are too few variables, data is lost, and if there are too many variables for the data available, a BASIC error is generated.

The formatting done by the enter statement can be changed. As discussed in *Data transfer from analyzer to computer*, the formatting can be turned off to allow binary transfers of data. Also, the `ENTER USING` statement can be used to selectively control the formatting.

On/off commands can also be interrogated. The reply is a one if the function is on, a zero if it is off. Similarly, if a command controls a function that is underlined on the HP 8753B display when active, interrogating that command yields a one if the command is underlined, a zero if it is not. For example, there are nine options on the format menu: only one is underlined at a time. The underlined option will return a one when interrogated.

For instance, rewrite line 10 as:

```
10 OUTPUT 716;"DUAC?;"
```

Run the program once, note the result, the press [LOCAL][DISPLAY][DUAL CHAN] to toggle the display mode, and run the program again.

Another example is to rewrite line 10 as:

```
10 OUTPUT 716;"PHAS?;"
```

In this case, the program will display a one if phase is currently being displayed. Since the command only applies to the active channel, the response to the `PHAS?` inquiry depends on which channel is active.

### Held commands

When the HP 8753B is executing a command that cannot be interrupted, it will hold off processing new HP-IB commands. It will fill the 16 character input buffer, and then halt HP-IB until the held command has completed execution. This action will be transparent to a program unless HP-IB timeouts have been set with the `ONTIMEOUT` statement.

While a held command is executing, the HP 8753B will still service the HP-IB interface commands, such as `SPOLL(716)`, `CLEAR 716`, and `ABORT 7`. Executing `CLEAR 716` or `CLEAR 7` will abort a command hold off, leaving the held command to complete execution as if it had been begun from the front panel. These commands also clear the input buffer, destroying any commands received after the held command. If the HP 8753B has halted the bus because its input buffer was full, `ABORT 7` will release the bus.

### Operation complete

Occasionally, there is a need to find out when certain operations have completed inside the HP 8753B. For instance, a program should not have the operator connect the next calibration standard while the HP 8753B is still measuring the current one.

To provide such information, the HP 8753B has an Operation Complete reporting mechanism that will indicate when certain key commands have completed operation. The mechanism is activated by sending either `OPC` or `OPC?` immediately before an OPC'able command. When the command completes execution, bit 0 of the event status register will be set. If `OPC` was interrogated with `OPC?`, the HP 8753B will also output a 1 when the command completes execution.

As an example, type **SCRATCH** and press **[EXECUTE]**. Type **EDIT** and press **[EXECUTE]**, and type in the following program:

```
10 OUTPUT 716;"SWET 3 S;OPC?;SING;" Set the sweep time to 3 seconds, and OPC a
 single sweep.
20 DISP "SWEEPING"
30 ENTER 716;Reply The program will halt at this point until the
 HP 8753B completes the sweep and issues a
 one.

40 DISP "DONE"
50 END
```

Running this program causes the computer to display the sweeping message for about 3 seconds, as the instrument executes the sweep. The computer will display **DONE** just as the instrument goes into hold. When the **DONE** message

appears, the program could then continue on, being assured that there is a valid data trace in the instrument. Without single sweep, we would have had to wait at least two sweep times to ensure good data.

### Preparing for HP-IB control

At the beginning of a program, the HP 8753B has to be taken from an unknown state and brought under computer control. One way to do this is with an abort/clear sequence. **ABORT 7** is used to halt bus activity and return control to the computer. **CLEAR 716** will then prepare the HP 8753B to receive commands by clearing syntax errors, the input command buffer, and any messages waiting to be output.

The abort/clear sequence makes the HP 8753B ready to receive HP-IB commands. The next step is to put the HP 8753B into a known state. The most convenient way to do this is to send **PRES**, which returns the instrument to the preset state. If preset cannot be used and the status reporting mechanism is going to be used, **CLES** can be sent to clear all of the status reporting registers and their enables.

Type **SCRATCH** and press **[EXECUTE]**. Type **EDIT** and press **[EXECUTE]**, and type in the following program:

```
10 ABORT 7 This halts all bus action and gives active control
 to the computer.
20 CLEAR 716 This clears all HP-IB errors, resets the HP-IB
 interface, clears syntax errors. It does not
 affect the status reporting system.
30 OUTPUT 716;"PRES;" Preset the instrument. This clears the status
 reporting system, as well as resetting all of
 the front panel settings, except the HP-IB
 mode and the HP-IB addresses.

40 END
```

Running this program brings the HP 8753B to a known state, ready to respond to HP-IB control.

The local key can also be disabled with the sequence:

The HP 8753B will not respond to HP-IB commands unless the remote line is asserted. When the remote line is asserted and the HP 8753B is addressed to listen, it automatically goes into remote mode. Remote mode means that all the front panel keys are disabled except **[LOCAL]** and the line power switch. **ABORT 7** asserts the remote line, which remains asserted until a **LOCAL 7** statement is executed. Another way to assert the remote line is to execute:

```
REMOTE 716
LOCAL LOCKOUT 7
```

Now no front panel keys will respond at all. The HP 8753B can be returned to local mode temporarily with:

```
REMOTE 716
```

```
LOCAL 716
```

But as soon as the HP 8753B is next addressed to listen, it goes back into local lockout. The only way to clear local lockout, aside from cycling power, is to execute:

This statement asserts remote and addresses the HP 8753B to listen so that it goes into remote mode. Press any front panel key except local. None will respond until after you press **[LOCAL]**.

```
LOCAL 7
```

Which un-asserts the remote line on the interface. This puts the instrument into local mode and clears local lockout. Be sure to put the instrument back into remote mode.

## Measurement Programming

The previous section of this document outlined how to get commands into the HP 8753B. The next step is to organize the commands into a measurement sequence. A typical measurement sequence consists of the following steps:

1. Set up the instrument.
2. Calibrate.
3. Connect the device.
4. Take data.
5. Post process data.
6. Transfer data.

### Set up the instrument:

Define the measurement by setting all of the basic measurement parameters. These include all the stimulus parameters: sweep type, span, sweep time, number of points, and RF power level. They also include the parameter to be measured, and both IF averaging and IF bandwidth. These parameters define the way data is gathered and processed within the instrument, and to change one requires that a new sweep be taken.

There are other parameters that can be set within the instrument that do not affect data gathering directly, such as smoothing, trace scaling or trace math. These functions are classed as post processing functions: they can be changed with the instrument in hold mode, and the data will correctly reflect the current state.

The save/recall registers and the learn string are two rapid ways of setting up an entire instrument state. The learn string is a summary of the instrument state compacted into a string that can be read into the computer and retransmitted to the HP 8753B. See Example 6A, *Using the learn string*, for a discussion of how to do this.

### Calibrate:

Measurement calibration is normally performed once the instrument state has been defined. Measurement calibration is not required to make a measurement, but it does improve the accuracy of the data.

There are several ways to calibrate the instrument. The simplest is to stop the program and have the operator perform the calibration from the front panel. Alternatively, the computer can be used to guide the operator through the calibration, as discussed in Example 2A and 2B, *S<sub>11</sub> 1-port calibration* and *Full 2-port calibration*. The last option is to transfer calibration data from a previous calibration back into the instrument, as discussed in Example 6C, *Reading calibration data*.

### Connect device:

Have the operator connect and adjust the device. The computer can be used to speed the adjustment process by setting up such functions as limit testing, bandwidth searches, and trace statistics. All adjustments take place at this stage so that there is no danger of taking data from the device while it is being adjusted.

### Take data:

With the device connected and adjusted, measure its frequency response, and hold the data within the instrument so that there is a valid trace to analyze.

The single sweep command `SING` is designed to ensure a valid sweep. All stimulus changes are completed before the sweep is started, and the HP-IB hold state is not released until the formatted trace is displayed. When the sweep is complete, the instrument is put into hold, freezing the data inside the instrument. Because single sweep is OPC'able, it is easy to determine when the sweep has been completed.

The number of groups command `NUMG n` is designed to work the same as single sweep, except that it triggers *n* sweeps. This is useful, for example, in making a measurement with an averaging factor *n*. (*n* can be 1 to 999). Both single sweep and number of groups restart averaging.

### Post process:

With valid data to operate on, the post-processing functions can be used. Referring ahead to Figure 2, any function that affects the data after the error correction stage can be used. The most useful functions are trace statistics, marker searches, electrical delay offset, time domain, and gating. If a 2-port calibration is active, then any of the four S-parameters can be viewed without taking a new sweep.

### Transfer data:

Lastly, read the results out of the instrument. All the data output commands are designed to ensure that the data transmitted reflects the current state of the instrument:

- `OUTPDATA`, `OUTPRAWn`, and `OUTPFORM` will not transmit data until all formatting functions have completed.
- `OUTPLIML`, `OUTPLIMM`, and `OUTPLIMF` will not transmit data until limit test has occurred, if on.
- `OUTPMARK` will activate a marker if one is not already selected, and it will make sure that any current marker searches have completed before transmitting data.
- `OUTPMSTA` makes sure that statistics have been calculated for the current trace before transmitting data. If statistics is not on, it will turn statistics on to update the current values, and then turn it off.
- `OUTPMWID` makes sure that a bandwidth search has been executed for the current trace before transmitting data. If bandwidth search is not on, it will turn the search on to update the current values, and then turn it off.

Data transfer is discussed further in Examples 3A through 3C, *Data transfer using ASCII transfer format*, etc.

## Example 1: Setting up a basic measurement

In general, the procedure for setting up measurements on the HP 8753B via HP-IB follows the same sequence as if the setup was performed manually. There is no required order, as long as the desired frequency range, number of points and power level is set prior to performing the calibration.

This example illustrates how a basic measurement can be set up on the HP 8753B. The sequence will be to first select the desired S-parameter, the measurement format, and

```
10 ABORT 7
20 CLEAR 716
30 OUTPUT 716;"PRES;"
40 OUTPUT 716;"CHAN1; S11; LOGM;"

50 OUTPUT 716;"CHAN2; S11; PHAS;"

60 OUTPUT 716;"DUACON;"

70 INPUT "ENTER START FREQUENCY (MHz):",F_start
80 INPUT "ENTER STOP FREQUENCY (MHz):",F_stop
90 OUTPUT 716;"STAR";F_start;"MHZ;"
100 OUTPUT 716;"STOP";F_stop;"MHZ;"
110 DISP F_start, F_Stop
120 END
```

then the frequency range. Performing calibrations is described later.

By interrogating the analyzer to determine the actual values of the start and stop frequencies, the computer can keep track of the actual frequencies.

This example program is stored on the Example Programs disc as **IPG1**.

Prepare for HP-IB control.  
Preset the HP 8753B.  
Make channel 1 the active channel, and measure  $S_{11}$ , displaying its magnitude in dB.  
Make channel 2 the active channel, and measure the phase of  $S_{11}$  on it.  
Tell the analyzer to display both channels simultaneously.  
Input a start frequency.  
Input a stop frequency.  
Set the start frequency to  $F_{start}$ .  
Set the stop frequency to  $F_{stop}$ .  
Show the current start and stop frequencies.

## Running the program

The program will set up a measurement of  $S_{11}$ , log magnitude on channel 1, and  $S_{11}$ , phase on channel 2, and turn on the dual channel display mode. When prompted for

start and stop frequencies, enter any value in MHz from 0.3 (300 kHz) to 3 GHz. These will be entered into the HP 8753B, and the frequencies are then displayed.

---

## Performing a measurement calibration

This section will demonstrate how to coordinate a measurement calibration over HP-IB. The HP-IB command sequence follows the key sequence required to calibrate from the front panel: there is a command for every step.

The general key sequence is to select the calibration, measure the calibration standards, and then declare the calibration done. The actual sequence depends on the calibration kit and changes slightly for 2-port calibrations, which are divided into three calibration sub-sequences.

### Calibration kits

The calibration kit tells the HP 8753B what standards to expect at each step of the calibration. The set of standards associated with a given calibration is termed a class. For example, measuring the short during an  $S_{11}$  1-port calibration is one calibration step. All of the shorts that can be used for this calibration step make up the class, which is called class  $S_{11}B$ . For the 7 mm and the 3.5 mm cal kits, class  $S_{11}B$  has only one standard in it. For type-N cal kits, class  $S_{11}B$  has two standards in it: male and female shorts.

When doing an  $S_{11}$  1-port calibration in 7 or 3.5 mm, selecting [SHORT] automatically measures the short because there is only one standard in the class. When doing the same calibration in type-N, selecting [SHORTS] brings up a second menu, allowing the user to select which standard in the class is to be measured. The sex listed refers to the test port: if the test port is female, then the user selects the female short option.

Doing an  $S_{11}$  1-port calibration over HP-IB is very similar. In 7 or 3.5 mm, sending CLASS11B will automatically measure the short. In type-N, sending CLASS11B brings up the menu with the male and female short options. To select a standard, use STANA or STANB. The STAN command is appended with the letters A through G, corresponding to the standards listed under softkeys 1 through 7, softkey 1 being the topmost softkey.

The STAN command is OPC'able. A command that calls a class is only OPC'able if that class has only one standard in it.

If there is more than one standard in a class, the command that calls the class only brings up another menu, and there is no need to OPC it.

Hence, both the manual and HP-IB calibration sequences depend heavily on which calibration kit is active.

### Full 2-port calibrations

Each full 2-port measurement calibration is divided into three sub-sequences: transmission, reflection, and isolation. Each subsequence is treated like a calibration in its own right: each must be opened, have all the standards measured, and then be declared done.

The opening and closing statements for the transmission sub-sequence are TRAN and TRAD. The opening and closing statements for the reflection sub-sequence are REFL and REFD. The opening and closing statements for isolation are ISQL and ISOD.

## Example 2A: $S_{11}$ 1-port calibration

To demonstrate coordinating a calibration over HP-IB, the following program does an  $S_{11}$  1-port calibration, using the HP 85032B 50 ohm type-N calibration kit. This program simplifies the calibration for the operator by giving explicit

directions on the HP 8753B display, and allowing the user to continue the program from the HP 8753B front panel.

This example program is stored on the Example Programs disc as IPG2A.

```

10 ABORT 7
20 CLEAR 716
30 OUTPUT 716;"CALKNS0;MENUOFF;CLES;ESE 64;"

40 OUTPUT 716;"CALIS111;"
50 CALL Waitforkey("CONNECT LOAD AT PORT 1")
60 OUTPUT 716;"OPC?;CLASS11C;"

70 ENTER 716;Reply
80 CALL Waitforkey("CONNECT OPEN AT PORT 1")
90 OUTPUT 716;"CLASS11AOPC?;STAN;"

100 ENTER 716;Reply
110 CALL Waitforkey("CONNECT SHORT LOAD AT PORT 1")
```

Prepare for HP-IB control.

This is the minimum instrument set up: the 50 ohm type-N cal kit is selected, the softkey menu is turned off, and the status reporting system is set up so that bit 6, User Request, of the event status register, is summarized by bit 5 of the status byte. This allows us to detect a key press with a serial poll. Refer to Appendix A.

Open the calibration by calling the  $S_{11}$  1-port calibration.

Now ask for the load, and wait for the operator. The Waitforkey subroutine will not return until the operator presses a key on the front panel of the HP 8753B.

There is only one choice in this class, so the CLASS command is OPC'able. Using the OPC? command causes the program to wait until the standard has been measured before continuing. This is very important, because the prompt to connect the next standard should only appear after the first standard is measured.

Wait until the HP 8753B is done with the standard.

Ask for an open, and wait for the operator to connect it.

Measure the open. There is more than one standard in this loads class, so we must identify the specific standard within that class. The female open is the second softkey selection from the top in the menu, so select a lowband load as the standard using the command STANB.

Wait for the standard to be measured.

Have the operator connect the short and wait for his reply.

|                                                                                                                                                                                                                                                                                                                                                                                                                                                                                                                                                                                                                               |                                                                                                                                                                                                                                                                                                                                                                                                                                                                                                                                                                                                                                                                                                                                                                                                                                                                                                                                                                                                                                                                                                                                                                                                                                                                                                                                                                                                                                                          |
|-------------------------------------------------------------------------------------------------------------------------------------------------------------------------------------------------------------------------------------------------------------------------------------------------------------------------------------------------------------------------------------------------------------------------------------------------------------------------------------------------------------------------------------------------------------------------------------------------------------------------------|----------------------------------------------------------------------------------------------------------------------------------------------------------------------------------------------------------------------------------------------------------------------------------------------------------------------------------------------------------------------------------------------------------------------------------------------------------------------------------------------------------------------------------------------------------------------------------------------------------------------------------------------------------------------------------------------------------------------------------------------------------------------------------------------------------------------------------------------------------------------------------------------------------------------------------------------------------------------------------------------------------------------------------------------------------------------------------------------------------------------------------------------------------------------------------------------------------------------------------------------------------------------------------------------------------------------------------------------------------------------------------------------------------------------------------------------------------|
| <pre> 120 OUTPUT 716;"CLASS11B:OPC?;STANB;" ..... 130 ENTER 716;Reply ..... 140 OUTPUT 717;"PG;" ..... 150 DISP "COMPUTING CALIBRATION COEFFICIENTS" 160 OUTPUT 716;"DONE;OPC?;SAV1;" ..... 170 ENTER 716;Reply .....  180 DISP "S11 1-     PORT CAL COMPLETED. CONNECT TEST DEVICE." 190 OUTPUT 716;"MENUON;" .....  200 END 210 SUB Waitforkey(Lab\$) .....  220 DISP Lab\$ .....  230 OUTPUT 717;"PG;PU;PA390,3600;PD;LB";Lab\$;" , PRESS     ANY KEY WHEN READY;"  240 CLEAR 716 ..... 250 OUTPUT 716;"ESR?;" .....  260 ENTER 716;Estat 270 Stat=SPOLL(716) ..... 280 IF NOT BIT(Stat,5) THEN GOTO 340 290 SUBEND </pre> | <p>There is more than one standard in the short class, too. The specific standard is the female short, or STAN B. Measure the short. Wait for the standard to be measured. The PG command sent to the display clears the user graphics, removing the last prompt.</p> <p>Affirm the completion of the calibration, and save the calibration. Wait until the HP 8753B is done calculating the calibration coefficients before allowing the program to go on.</p> <p>The calibration is completed, so turn the soft key menu back on.</p> <p>This subroutine displays the passed message on the HP 8753B, and waits for the operator to press a key. It assumes that bit 6, User Request, of the event status register has been enabled. First, display a message on the computer in case the operator has returned to the computer keyboard. This statement writes on the HP 8753B's display. PG (page) clears old user graphics. PU (pen up) prevents anything from being drawn. PA390, 3600; moves the logical pen to just above the message area on the display. PD (pen down) enables drawing. LB (label) writes the message on the display. The label command is terminated with an ETX symbol, which is [CTRL] [C] (pressed simultaneously) on the keyboard. Clear the message line on the HP 8753B. Clear the latched User Request bit so that old key presses will not trigger a measurement.</p> <p>Now wait for a key press to be reported.</p> |
|-------------------------------------------------------------------------------------------------------------------------------------------------------------------------------------------------------------------------------------------------------------------------------------------------------------------------------------------------------------------------------------------------------------------------------------------------------------------------------------------------------------------------------------------------------------------------------------------------------------------------------|----------------------------------------------------------------------------------------------------------------------------------------------------------------------------------------------------------------------------------------------------------------------------------------------------------------------------------------------------------------------------------------------------------------------------------------------------------------------------------------------------------------------------------------------------------------------------------------------------------------------------------------------------------------------------------------------------------------------------------------------------------------------------------------------------------------------------------------------------------------------------------------------------------------------------------------------------------------------------------------------------------------------------------------------------------------------------------------------------------------------------------------------------------------------------------------------------------------------------------------------------------------------------------------------------------------------------------------------------------------------------------------------------------------------------------------------------------|

## Running the program

The program assumes that the port being calibrated is a 50 ohm, type-N female test port. The prompts appear just above the message line on the HP 8753B display. Pressing any key on the front panel of the HP 8753B continues the program and measures the standard. The program will display a message when the measurement calibration is complete.

Before running the program, set up the desired instrument state. This program does not modify the instrument state in any way. Run the program, and connect the standards as prompted. When the standard is connected, press any key on the HP 8753B's front panel to measure it.

## Example 2B: Full 2-port measurement calibration

The following example shows how to perform a full 2-port measurement calibration using the HP 85032B calibration kit. The main difference between this example and Example 2A is that in this case, the calibration process allows removal of both the forward and reverse error terms, so that all four

S-parameters of the device under test can be measured. Port 1 is a female test port and Port 2 is a male test port.

This example program is stored on the Example Programs disc as **IPG2B**.

|     |                                                     |                                                                                                                                                                                                                                                                                                                                         |
|-----|-----------------------------------------------------|-----------------------------------------------------------------------------------------------------------------------------------------------------------------------------------------------------------------------------------------------------------------------------------------------------------------------------------------|
| 10  | ABORT 7                                             |                                                                                                                                                                                                                                                                                                                                         |
| 20  | CLEAR 716                                           | Prepare for HP-IB control.                                                                                                                                                                                                                                                                                                              |
| 30  | OUTPUT 716;"CALKN50;MENUOFF;CLES;ESE 64;"           | This is the minimum instrument set up: the 50 ohm type-N kit is selected, the softkey menu is turned off, and the status reporting system is set up so that bit 6, User Request, of the event status register, is summarized by bit 5 of the status byte. This allows us to detect a key press with a serial poll. Refer to Appendix A. |
| 40  | OUTPUT 716;"CALIFUL2;"                              | Open the calibration by calling for a full 2-port calibration.                                                                                                                                                                                                                                                                          |
| 50  | OUTPUT 716;"REFL;"                                  | Open the reflection calibration subsequence.                                                                                                                                                                                                                                                                                            |
| 60  | CALL Waitforkey("CONNECT OPEN AT PORT 1")           | Now ask for the open, and wait for the operator. The Waitforkey subroutine will not return until the operator presses a key on the front panel of the HP 8753B.                                                                                                                                                                         |
| 70  | OUTPUT 716;"CLASS11A;OPC?;STANB;"                   | There is more than one standard in the open class, so we must identify the specific standard within that class. The female open selection is the second softkey from the top in the menu, so we select a broadband load as the standard using the command STANB.                                                                        |
| 80  | ENTER 716;Reply                                     | Wait until the HP 8753B is done with the standard.                                                                                                                                                                                                                                                                                      |
| 90  | CALL Waitforkey("CONNECT SHORT AT PORT 1")          | Ask for a short, and wait for the operator to connect it.                                                                                                                                                                                                                                                                               |
| 100 | OUTPUT 716;"CLASS11B;OPC?;STANB;"                   | Measure the short.                                                                                                                                                                                                                                                                                                                      |
| 110 | ENTER 716;Reply                                     | Wait for the standard to be measured.                                                                                                                                                                                                                                                                                                   |
| 120 | CALL Waitforkey("CONNECT BROADBAND LOAD AT PORT 1") | Have the operator connect the broadband load, and wait for his reply.                                                                                                                                                                                                                                                                   |
| 130 | OUTPUT 716;"OPC?;CLASS11C;"                         | There is only one choice in this class, so the CLASS command is OPC'able. Using the OPC? command causes the program to wait until the standard has been measured before continuing. This is very important, because the prompt to connect the next standard should only appear after the first standard is measured.                    |
| 140 | ENTER 716;Reply                                     | Wait for the standard to be measured.                                                                                                                                                                                                                                                                                                   |
| 150 | CALL Waitforkey("CONNECT OPEN AT PORT 2")           | Ask for the male open for port 2, and wait for the operator.                                                                                                                                                                                                                                                                            |
| 160 | OUTPUT 716;"CLASS22A;OPC?;STANA;"                   | Measure the open.                                                                                                                                                                                                                                                                                                                       |
| 170 | ENTER 716;Reply                                     | Wait until the HP 8753B is done with the standard.                                                                                                                                                                                                                                                                                      |
| 180 | CALL Waitforkey("CONNECT SHORT AT PORT 2")          | Ask for a male short, and wait for the operator to connect it.                                                                                                                                                                                                                                                                          |
| 190 | OUTPUT 716;"CLASS22B;OPC?;STANA;"                   | Measure the short.                                                                                                                                                                                                                                                                                                                      |
| 200 | ENTER 716;Reply                                     | Wait for the standard to be measured.                                                                                                                                                                                                                                                                                                   |
| 210 | CALL Waitforkey("CONNECT LOAD AT PORT 2")           | Have the operator connect the load, and wait for his reply.                                                                                                                                                                                                                                                                             |



|     |                                                      |                                                                                                                                                                                             |
|-----|------------------------------------------------------|---------------------------------------------------------------------------------------------------------------------------------------------------------------------------------------------|
| 220 | OUTPUT 716;"OPC?;CLASS22C;"                          | Measure the load.                                                                                                                                                                           |
| 230 | ENTER 716;Reply                                      | Wait for the standard to be measured.                                                                                                                                                       |
| 240 | OUTPUT 716;"REFD;"                                   | Close the reflection calibration subsequence.                                                                                                                                               |
| 250 | DISP "COMPUTING REFLECTION CALIBRATION COEFFICIENTS" |                                                                                                                                                                                             |
| 260 | OUTPUT 716;"TRAN;"                                   | Open the transmission calibration subsequence.                                                                                                                                              |
| 270 | CALL Waitforkey("CONNECT THRU [PORT 1 TO PORT 2]")   |                                                                                                                                                                                             |
| 280 | DISP "MEASURING FORWARD TRANSMISSION"                |                                                                                                                                                                                             |
| 290 | OUTPUT 716;"OPC?;FWDI;"                              | Measure forward transmission.                                                                                                                                                               |
| 300 | ENTER 716;Reply                                      |                                                                                                                                                                                             |
| 310 | OUTPUT 716;"OPC?;FWDI;"                              | Measure forward load match.                                                                                                                                                                 |
| 320 | ENTER 716;Reply                                      |                                                                                                                                                                                             |
| 330 | DISP "MEASURING REVERSE TRANSMISSION"                |                                                                                                                                                                                             |
| 340 | OUTPUT 716;"OPC?;REVT;"                              | Measure reverse transmission.                                                                                                                                                               |
| 350 | ENTER 716;Reply                                      |                                                                                                                                                                                             |
| 360 | OUTPUT 716;"OPC?;REVM;"                              | Measure reverse load match.                                                                                                                                                                 |
| 370 | ENTER 716;Reply                                      |                                                                                                                                                                                             |
| 380 | OUTPUT 716;"TRAD;"                                   | Close the transmission calibration subsequence.                                                                                                                                             |
| 390 | INPUT "SKIP ISOLATION CAL? Y OR N.", An\$            | Ask operator if the isolation cal should be skipped.                                                                                                                                        |
| 400 | "IF An\$="Y" THEN                                    | If the answer is yes, skip the isolation cal and branch to the computation of the calibration coefficients.                                                                                 |
| 410 | OUTPUT 716;"OMII;"                                   |                                                                                                                                                                                             |
| 420 | GOTO 520                                             |                                                                                                                                                                                             |
| 430 | END IF                                               |                                                                                                                                                                                             |
| 440 | CALL Waitforkey("ISOLATE TEST PORTS")                | Ask operator to isolate the test ports.                                                                                                                                                     |
| 450 | OUTPUT 716;"ISOL;AVERFACT10;AVEROON;"                | Open the isolation calibration subsequence. Turn on averaging with an averaging factor of 10 for the isolation cal.                                                                         |
| 460 | DISP "MEASURING REVERSE ISOLATION"                   |                                                                                                                                                                                             |
| 470 | OUTPUT 716;"OPC?;REVI;"                              | Measure reverse isolation.                                                                                                                                                                  |
| 480 | ENTER 716;Reply                                      |                                                                                                                                                                                             |
| 490 | DISP "MEASURING FORWARD ISOLATION"                   |                                                                                                                                                                                             |
| 500 | OUTPUT 716;"OPC?;FWDI;"                              | Measure forward isolation.                                                                                                                                                                  |
| 510 | ENTER 716;Reply                                      |                                                                                                                                                                                             |
| 520 | OUTPUT 716;"ISOD;AVEROOFF;"                          | Close the isolation calibration subsequence and turn off averaging.                                                                                                                         |
| 530 | OUTPUT 717;"PG;"                                     | The PG command sent to the display clears the user graphics, removing the last prompt.                                                                                                      |
| 540 | DISP "COMPUTING CALIBRATION COEFFICIENTS"            |                                                                                                                                                                                             |
| 550 | OUTPUT 716;"OPC?;SAV2;"                              |                                                                                                                                                                                             |
| 560 | ENTER 716;Reply                                      | Wait until the HP 8753B is done calculating the calibration coefficients before allowing the program to go on.                                                                              |
| 570 | DISP "DONE FULL 2-PORT CAL. CONNECT TEST DEVICE."    |                                                                                                                                                                                             |
| 580 | OUTPUT 716;"MENUON;"                                 | The calibration is completed, so turn the soft key menu back on.                                                                                                                            |
| 590 | END                                                  |                                                                                                                                                                                             |
| 600 | SUB Waitforkey(Lab\$)                                | This subroutine displays the passed message on the HP 8753B, and waits for the operator to press a key. It assumes that bit 6, User Request, of the event status register has been enabled. |
| 610 | DISP Lab\$                                           | First, display a message on the computer in case the operator has returned to the computer keyboard.                                                                                        |

```

620 OUTPUT 717;"PG;PU;PA390,3600;PD;LB";Lab$;" , PRESS . . . This statement writes on the HP 8753B's display. PG (page) clears old user graphics. PU (pen up) prevents anything from being drawn. PA390,3600; moves the logical pen to just above the message area on the display. PD (pen down) enables drawing. LB (label) writes the message on the display. The label command is terminated with an ETX symbol, which is [CTRL][C] (pressed simultaneously) on the keyboard.
 ANY KEY*;"
630 CLEAR 716 Clear the message line on the HP 8753B.
640 OUTPUT 716;"ESR?;" Clear the latched User Request bit so that old key presses will not trigger a measurement. Now wait for a key press to be reported.
650 ENTER 716;Estat
660 Stat=SPOLL(716)
670 IF NOT BIT(Stat,5) THEN GOTO 660
680 OUTPUT 717;"PG;" Clear the prompt from the display.
690 SUBEND

```

## Running the program

The program assumes that the test ports being calibrated are type-N, port 1 being a female test port and port 2 being a male test port. The HP 85032B 50 ohm type-N calibration kit is to be used. The prompts appear just above the message line on the HP 8753B display. Pressing any key on the front panel of the HP 8753B continues the program and measures the standard. The operator has the option of omitting the isolation cal. If the isolation cal is performed, averaging is

automatically employed to ensure a good calibration. The program will display a message when the measurement calibration is complete.

Before running the program, set up the desired instrument state. This program does not modify the instrument state in any way. Run the program, and connect the standards as prompted. When the standard is connected, press any key on the HP 8753B's front panel to measure it.

## Data transfer from analyzer to computer

### Using markers to obtain trace data at specific points

Trace information can be read out of the HP 8753B in several ways. Data can be read off the trace selectively using the markers, or the entire trace can be read out. If only specific information such as a single point off the trace or the result of a marker search is needed, the marker output command can be used to read the information. If all the trace data is needed, see Examples 3A thru 3C.

To get data off the trace using the marker, the marker first has to be put at the frequency desired. This is done with the marker commands. For example, execute:

```
OUTPUT 716;"MARK1 1.56 GHZ;"
```

This places marker one at 1.56 GHz. If the markers are in continuous mode, the marker value will be linearly interpolated from the two nearest points if 1.5600 GHz was not sampled. This interpolation can be prevented by putting the markers into discrete mode. The key sequence for this is [LOCAL][MKR][MARKER MODE MENU][MARKERS:DISCRETE]. To do it over HP-IB, execute:

```
OUTPUT 716;"MARKDISC;"
```

After executing this, note that the marker is may no longer be precisely on 1.56 GHz. (This depends on the start and stop frequencies).

Another way of using the markers is to let the HP 8753B pick the stimulus value on the basis of one of the marker searches: max, min, target value, or bandwidths search. For example, execute:

```
OUTPUT 716;"SEAMAX;"
```

This executes a one-time trace search for the trace maximum, and puts the marker at that maximum. In order to continually update the search, turn tracking on. The key sequence is [MKR FCTN][MKR SEARCH][TRACKING][SEARCH:MAX]. To do it over HP-IB, execute:

```
OUTPUT 716;"TRACKON;SEAMAX;"
```

The trace maximum search will stay on this time, until search is turned off, tracking is turned off, or all markers are turned off. For example, execute:

```
OUTPUT 716;"MARKOFF;"
```

Marker data is read out with the command OUTPMARK. This command causes the HP 8753B to transmit three numbers: marker value 1, marker value 2, and marker stimulus value. In this case we get the log magnitude at marker 1, zero, and the marker frequency. See Table 1 for all the different possibilities for values one and two. The third value is frequency in this case, but it could have been time as in time domain (option 010 only) or CW time.

Table 1. Units as a Function of Display Format.

| DISPLAY FORMAT | MARKER MODE | OUTPMARK<br>value 1, value 2 | OUTPFORM<br>value 1, value 2 | MARKET READOUT**<br>value, aux value |
|----------------|-------------|------------------------------|------------------------------|--------------------------------------|
| LOG MAG        | LIN MKR     | dB,*                         | dB,*                         | dB,*                                 |
| PHASE          |             | degrees,*                    | degrees,                     | degrees,*                            |
| DELAY          |             | seconds,*                    | seconds,*                    | seconds,*                            |
| SMITH          |             | lin mag, degrees             | real, imag                   | lin mag, degrees                     |
| CHART          |             |                              |                              |                                      |
|                | LOG MKR     | dB, degrees                  | "                            | dB, degrees                          |
|                | Re/Im       | real, imag                   | "                            | real, imag                           |
|                | R + jX      | real, imag ohms              | "                            | real, imag ohms                      |
|                | G + jB      | real, imag Siemens           | "                            | real, imag Siemens                   |
| POLAR          | LIN MKR     | lin mag, degrees             | real, imag                   | lin mag, degrees                     |
|                | LOG MKR     | dB, degrees                  | "                            | dB, degrees                          |
|                | Re/Im       | real, imag                   | "                            | real, imag                           |
| LIN MAG        |             | lin mag,*                    | lin mag,*                    | lin mag,*                            |
| REAL           |             | real,*                       | real,*                       | real,*                               |
| SWR            |             | SWR,*                        | SWR,*                        | SWR,*                                |

\* Value not significant in this format, but is included in data transfers.

\*\* The marker readout values are the marker values displayed in the upper left hand corner of the display. They also correspond to the value and aux value associated with the fixed marker.

Type **SCRATCH** and press [EXECUTE]. Type **EDIT** and press [EXECUTE], and then type in the following program:

```

10 OUTPUT 716;"SEAMIN;OUTPMARK;" Have the HP 8753B search out the trace mini-
 mum, and then output the marker values at that
 point.
20 ENTER 716;Val1,Val2,Stim Read marker value 1, marker value 2, and the
 stimulus value.
30 DISP Val1,Val2,Stim Display the values.
40 END

```

Run the program. The values displayed by the computer should agree with the marker values displayed on the HP 8753B, except that the second value displayed by the computer will be meaningless in phase and log mag formats. To see the possibilities for different values, run the program three times: once in log magnitude format, once in phase format, and once in Smith chart format. To change display format, press [LOCAL] [FORMAT] and then select the desired format.

**Trace transfer**

Getting trace data out of the HP 8753B with a 200/300 series computer can be broken down into three steps:

1. Setting up the receive array.
2. Telling the HP 8753B to transmit the data.
3. Accepting the transferred data.

Data inside the HP 8753B is always stored in pairs, to accommodate real/imaginary pairs, for each data point. Hence, the receiving array has to be two elements wide, and as deep as the number of points. This memory space for this array must be declared before any data is to be transferred from the HP 8753B to the computer.

The HP 8753B can transmit data over HP-IB in four different formats. The type of format affects what kind of data array is declared (real or integer), since the format determines what type of data is transferred. Examples for data transfers using different formats are given below. The first, Example 3A, illustrates the basic transfer using form 4, an ASCII transfer. For more information on the various data formats, see the section entitled *Data Formats*. For information on the various types of data that can be obtained (raw data, corrected data and so on), see the section entitled *Data Levels*.

Note that Example 9, *Reading disc files into a computer*, allows the operator to access disc files from a computer.

### Example 3A: Data transfer using form 4 (ASCII transfer)

As detailed in the *Quick Reference Guide*, when form 4 is used, each number is sent as a 24 character string, each character being a digit, sign, or decimal point. Since there are two numbers per point, a 201 point transfer in form 4 takes

9,648 bytes. An example simple data transfer using form 4, an ASCII data transfer is shown in this program.

This example program is stored on the Example Programs disc as IPG3A.

|    |                                              |                                                                                                                                                                                                                                                                                                                                                                                              |
|----|----------------------------------------------|----------------------------------------------------------------------------------------------------------------------------------------------------------------------------------------------------------------------------------------------------------------------------------------------------------------------------------------------------------------------------------------------|
| 10 | ABORT 7                                      |                                                                                                                                                                                                                                                                                                                                                                                              |
| 20 | CLEAR 716                                    | Prepare for HP-IB control.                                                                                                                                                                                                                                                                                                                                                                   |
| 30 | OUTPUT 716;"PRES;"                           | Preset the analyzer.                                                                                                                                                                                                                                                                                                                                                                         |
| 40 | DIM Dat(1:11,1:2)                            | This line sets up an array to receive the data. The ENTER 716; Dat(*) statement in line 60 fills the array Dat automatically, changing the second subscript fastest. Since the HP 8753B transmits the data as ordered pairs, we make the second dimension two so that the pairs will be properly grouped. The number of points will be set to 11, so we know to make the first dimension 11. |
| 50 | OUTPUT 716;"POIN 11; SING; FORM4; OUTPFORM;" | Set the number of points, tell the HP 8753B to use ASCII transfer format, and request the formatted trace data. Frequency information is not included in the transfer.                                                                                                                                                                                                                       |
| 60 | ENTER 716; Dat(*)                            | The computer takes the data from the instrument and puts it in the receiving array. By specifying Dat(*), we have told the enter statement to fill every location in the array.                                                                                                                                                                                                              |
| 70 | DISP DAT(1,1),DAT(1,2)                       | This line checks the first data point received. The data is in the current HP 8753B display format: see Table 1 for the contents of the array as a function of display format.                                                                                                                                                                                                               |
| 80 | END                                          |                                                                                                                                                                                                                                                                                                                                                                                              |

### Running the program

The first number of the result is a trace value in dB, and the second is zero. Put a marker at 300 kHz, which was the first point transmitted, to see that the values displayed by the computer agree with the HP 8753B. Keep in mind that no matter how many digits are displayed, the HP 8753B is specified to measure magnitude to a resolution of .001 dB, phase to a resolution of .01 degrees, and group delay to a resolution of .01 psec.

Changing the display format will change the data sent with the OUTPFORM transfer. See Table 1 for a list of what data is provided with what formats. The data from OUTPFORM reflects all the post processing such as time domain, gating, electrical delay, trace math, and smoothing. Note that if time domain (option 010 only) is on, operation is limited to 201 points in the lowpass mode.

Relating the data from a linear frequency sweep to frequency can be done by interrogating the start frequency, the frequency span, and the number of points. Given that information, the frequency of point N in a linear frequency sweep is just:

$$F = \text{Start\_frequency} + (N-1) \times \text{Span} / (\text{Points}-1)$$

Alternatively, it is possible to read the frequencies directly out of the instrument with the OUTPLIML command. OUTPLIML reports the limit test results by transmitting the stimulus point tested, a number indicating the limit test results, and then the upper and lower limits at that stimulus point, if available. The number indicating the limit results is a -1 for no test, 0 for fail, and 1 for pass. If there are no limits available, the HP 8753B transmits zeros.

For this example, we throw away the limit test information and keep the stimulus information. Edit line 40 to read:

```
40 DIMDat(1:11,1:2),Stim(1:11)
```

And type in:

```
70 OUTPUT 716;"OUTPLIML;" Request the limit test results.
80 FOR I=1 TO 11 Loop 11 times to read in all 11 data points.
90 ENTER 716;Stim(I),Reslt,Upr,Lwr Read the stimulus values in, throw the rest away.
Because we are not loading the data into a single
array, it is necessary to loop and read every point.
100 PRINTStim(I),Dat(I,1),Dat(I,2) Print the data value and stimulus value.
110 NEXT I
120 DISPReslt,Upr,Lwr Show what the last limit test result was, just to
see what came out.
130 END
```

Running this program will print out all the trace data and the stimulus values. Put the instrument into a log frequency sweep by pressing [LOCAL][MENU][SWEEP TYPE MENU][LOG FREQ], and run the program again. If you define a list frequency table with 11 points, this program will still show the sampled frequencies. If you define a limit test table, **Reslt** will hold the limit test results.

### Data levels

Different levels of data can be read out of the instrument. Referring to the data processing chain in Figure 2, there is available:

- Raw data. The basic measurement data, reflecting the stimulus parameters, IF averaging, and IF bandwidth. If a full 2-port measurement calibration is on, there are actually four raw arrays kept: one for each raw S-parameter. The data is read out with the commands **OUTPRAW1**, **OUTPRAW2**, **OUTPRAW3**, **OUTPRAW4**. Normally, only raw 1 is available, and it holds the current parameter. If a 2-port calibration is on, the four arrays refer to  $S_{11}$ ,  $S_{21}$ ,  $S_{12}$ , and  $S_{22}$  respectively. This data is in real/imaginary pairs.
- Error Corrected data. This is the raw data with error correction applied. The array is for the currently measured parameter, and is in real/imaginary pairs. The error corrected data is read out with **OUTPDATA**. **OUTPMEMO** reads the trace memory if available, which is also error corrected data. Note that neither raw nor error corrected data reflect such post-processing functions as electrical delay offset, trace math, or time domain gating.
- Formatted data. This is the array of data actually being displayed. It reflects all post-processing functions such as electrical delay or time domain, and the units of the array read out depends on the current display format. See Table 1 for the various units as a function of display format.

- Calibration coefficients. The results of a calibration are arrays of calibration coefficients which are used in the error correction routines. Each array corresponds to a specific error term in the error model. The *Quick Reference Guide* details which error coefficients are used for specific calibration types, and which arrays those coefficients are to be found in. Not all calibration types use all 12 arrays. The data is stored as real/imaginary pairs.

Formatted data is the most generally useful data, being the same information an operator sees on the display. However if the post processing is unneeded or unwanted, as may be the case with smoothing, error corrected data is more desirable. Error corrected data also gives you the opportunity to put the data into the instrument and apply post-processing at a later time.

As an example of error corrected data, change line 50 to:

```
50 OUTPUT 716;"POIN 11;SING;FORM4;
OUTPDATA;"
```

Running the program now displays real and imaginary trace data, regardless of what display format is currently being used. Select the real display format to verify that the data is indeed the real portion.

### Data formats

As stated earlier, the HP 8753B can transmit data over HP-IB in four different formats. Until now, we have been using form 4, an ASCII data transfer. Another option is to use form 3, which is the IEEE 64 bit floating point format. In this mode, each number takes only 8 bytes instead of 24. This means that a 201 point transfer takes only 3,216 bytes. This mode is particularly attractive since data is stored internally in the 200/300 series computer with the IEEE 64 bit floating point format, removing the need for any reformatting by the computer.

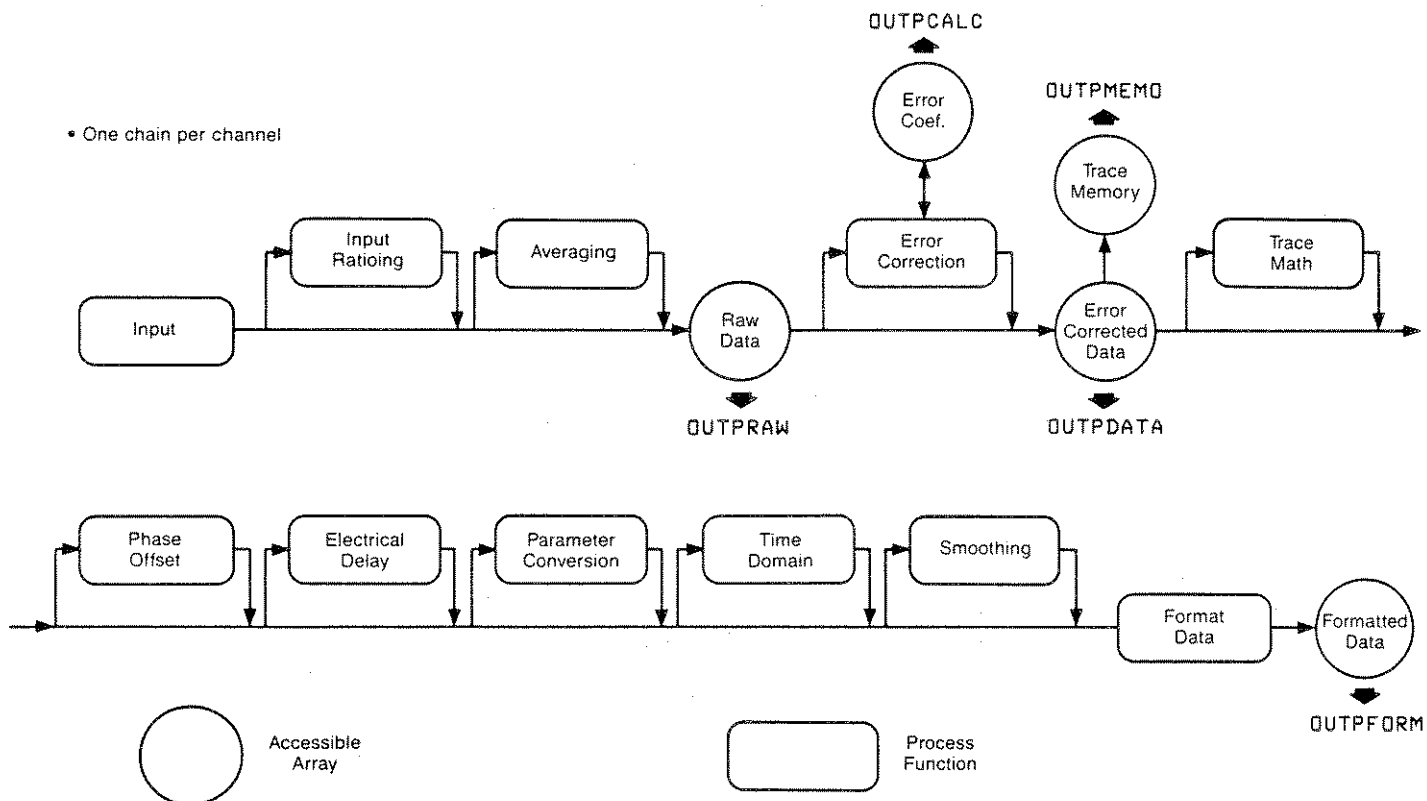

Figure 2. Data processing chain.

### Example 3B: Data transfer using form 3 (IEEE 64 bit floating point format)

Example program 3B illustrates data transfer using form 3, in which data is transmitted in the IEEE 64 bit floating point format.

To use form 3, the computer is told to stop formatting the incoming data with the ENTER statement. This is done by defining an I/O path with formatting off. Form 3 also has a

four byte header to deal with. The first two bytes are the ASCII characters "#A" that indicate that a fixed length block transfer follows, and the next two bytes form an integer containing number of bytes in the block to follow. The header must read in so that data order is maintained.

This example program is stored on the Example Programs disc as **IPG3B**.

```

10 ABORT 7
20 CLEAR 716
30 DIM Dat(1:201, 1:2)
40 INTEGER Hdr, Lgth

50 ASSIGN @Dt TO 716; FORMAT OFF

60 OUTPUT 716; "SING; FORM3; OUTPFORM;"

70 ENTER @Dt; Hdr, Lgth, Dat(*)

80 DISPLgth, Dat(1, 1), Dat(1, 2)
90 END

```

Prepare for HP-IB control. As before, prepare the receiving array. Since an integer takes two bytes, **Hdr** and **Lgth** will take care of the four byte header. **Lgth** will hold the number of bytes in the data block.

This statement defines a data I/O path with ASCII formatting off. The I/O path points to the HP 8753B, and can be used to read or write data to the instrument, as long as that data is in binary rather than ASCII format.

The analyzer is told to output formatted data using form 3.

The data is read in much as before, but the I/O path has format off to accept the binary data from form 3. The HP 8753B and the computer must be in agreement as to the format of the data being transmitted.

## Running the program

Preset the instrument and run the program. The computer displays 3,216 and the trace values at 300 kHz. The number 3,216 comes from 201 points, 2 values per point, 8 bytes per value. Note that this transfer is much faster than a form 4 transfer: more than twice as fast.

To illustrate a point, go to the instrument and press [LOCAL] [MENU] [NUMBER of POINTS], and key in 101 [x1]. Now run the program again: a BASIC error will be generated because the HP 8753B ran out of data to transmit before the variable list was full.

Go to the instrument again, and this time change the number of points to 401. Running the program again does not generate an error, but not all of the data was read in. The HP 8753B is still waiting to transmit data, but the program has not been designed to detect the situation.

As illustrated above, it is imperative that the receiving array be correctly dimensioned. There are two things that assure correct dimensions. First, the number of points is readily

```
70 ENTER@Dt;Hdr,Lgth
80 ALLOCATEDat(1:Lgth/16,1:2)
```

This guarantees that the receiving array is the correct size. In form 3, each number is 8 bytes, and there are two numbers per point, so we divide *Lgth* by 16 to get number of points.

```
90 ENTER@Dt;Dat(*)
100 DISPDat(Lgth/16,1)
110 END
```

Display the last number read in.

Set the number of points to 51 and run the program: this time no errors are generated. Set the number of points to 401, and run the program again. Move a marker to the last point on the trace, and check to see that the last point read in was the last point on the trace, as expected.

There are two other formats available. Form 2 is not used with 200/300 computers, and form 1 is a special high speed transfer. Form 1 is a condensed transfer format that is useful if data is being transferred out of the HP 8753B for direct storage and later re-transmission to the HP 8753B. Example 3C gives an example of a data transfer using form 1.

## Example 3C: Data transfer using form 1 (HP 8753B internal format)

In form 1, each data point is sent out as it is stored inside the HP 8753B, in a six byte binary string. Hence, it is a very fast transfer, using only 1206 bytes to transfer 201 points, but it is difficult to decode. (Real/imaginary data uses the first two bytes for the imaginary fraction mantissa, the middle two bytes for the real fraction mantissa, the fifth byte is used for additional resolution when transferring raw data, and the last byte as the common power of two). The data could be recombined and displayed in the computer, but this requires significant reformatting time.

In this example, we use form 1 to get data to store on disc. Before running this program, be sure that the mass storage device is a disc drive with a formatted disc in it. We also introduce a method of loading data back into the HP 8753B. For most `OUTPUTxxx` commands, there is a corresponding `INPUTxxx` command, and here we take advantage of that to load error corrected data back into the instrument.

This example program is stored on the Example Programs disc as `IPG3C`.

```
10 ABORT 7
20 CLEAR 716
30 INTEGER Hdr,Lgth
40 ASSIGN@Dt TO 716;FORMAT OFF
50 OUTPUT 716;"SING;FORM1;OUTPUTDATA;"
```

Prepare for HP-IB control. Set up to integers to take the header, the same as with form 3.

Now we have the HP 8753B take a sweep, and prepare to transmit the trace data to the computer.

```

60 ENTER @Dt;Hdr,Lgth
70 CREATE BDAT "TESTDATA",1,Lgth+4

80 ASSIGN @Disc TO "TESTDATA"

90 ALLOCATE INTEGER Dat(1:Lgth/6,1:3)

100 ENTER @Dt;Dat(*)
110 OUTPUT @Disc;Hdr,Lgth,Dat(*)
120 INPUT "CHANGE TRACE AND HIT RETURN",Dum$

130 OUTPUT 716;"SING;"
140 ASSIGN @Disc TO "TESTDATA"

150 ENTER @Disc;Hdr,Lgth,Dat(*)
160 OUTPUT 716;"INPUDATA"
170 OUTPUT @Dt;Hdr,Lgth,Dat(*)
180 ASSIGN @Disc TO *
190 DEALLOCATE Dat(*)
200 PURGE "TESTDATA"
210 END

```

This statement creates a disc file to store the form 1 data in. It creates a binary data file name TESTDATA. The file is 1 record long, using a record length of Lgth+4 bytes. The extra 4 bytes are for the header. This example will not run unless MASS STORAGE IS points to a disc drive with a formatted disc it, and that disc cannot have a file named TESTDATA on it.

This statement creates a data I/O path pointing to the file TESTDATA.

We create an integer receiving array. There are six bytes per point in form 1, so allocating 3 integers per point will hold the data correctly, since an integer is two bytes.

The data is received much as before.

Write the data to the disc drive.

At this point, disconnect the test device, and take a sweep. We will then go on to read the data off the disc, and put it back in the instrument.

Take one sweep and hold.

Re-establish the data path. This is necessary in order to begin reading data from the start of the file, rather than the end of the file where the file pointer was left by line 110.

Get the information.

And copy it out to the HP 8753B.

Close the file.

Release the memory for the data array.

And purge the data file.

## Running the program

Preset the HP 8753B, and run the program. When the program pauses press [LOCAL], change the trace, and press [RETURN]. When the data is reloaded into the HP 8753B, it will be formatted and displayed as the current trace. Note that this form of data transfer is even faster than the transfer using form 3.



# Advanced Programming Examples

## Using list frequency mode

The HP 8753B normally takes data points spaced at regular intervals across the overall frequency range of the measurement. For example, for a 2 GHz frequency span, using 201 points, data will be taken at intervals of 10 MHz. The list frequency mode allows the operator to select the specific points or frequency spacing between points at which measurements are to be made. This mode of operation allows flexibility in setting up tests to ensure device performance in an efficient manner. By only sampling specific points, measurement time is reduced, since additional time is not spent measuring device performance at frequencies which are of no concern.

The following two examples illustrate the use of the HP 8753B's list frequency mode to perform arbitrary fre-

quency testing. Example 4A lets the operator construct a table of list frequency segments which is then loaded into the HP 8753B's list frequency table. Each segment stipulates a start and stop frequency, and the number of data points to be taken over that frequency range. Example 4B lets the operator select a specific segment to "zoom-in" on. A single instrument can thus be ready to measure several different devices, each with its own frequency range, using a single calibration performed with all of the segments active. When a specific device is connected, the operator selects the appropriate segment for that device. Note that list frequency segments can be overlapped, but the total number of points in all the segments must not exceed 1632 points.

### Example 4A: Setting up a list frequency sweep

The purpose of this example is to show how to create a list frequency table and transmit it to the HP 8753B.

The command sequence for entering a list frequency table imitates the key sequence followed when entering a table from the front panel: there is a command for every key press. Editing a segment is also the same as the key sequence, but remember the HP 8753B automatically reorders each edited segment in order of increasing start frequency.

The list frequency table is also carried as part of the learn string. While it cannot be modified as part of the learn string, it can be stored and recalled with very little effort.

This example takes advantage of the computer's capabilities to simplify creating, adding to, and editing the table. The table is entered and completely edited before being transmitted to the HP 8753B. To simplify the programming task, options such as entering center/span or step size are not included. For information on reading list frequency data out of the HP 8753B, see the section *Data transfer from analyzer to computer*.

This program is stored on the Example Programs disc as **IPG4A**.

```
10 ABORT 7
20 CLEAR 716
30 OUTPUT 716;"EDITLIST;"
40 FOR I=1 to 30
50 OUTPUT 716;"SDEL;"
60 NEXT I
70 INPUT "Number of segments?", Numb
80 ALLOCATE Table(1:Numb, 1:3)

90 PRINTER IS 1
100 OUTPUT 2;CHR$(255)&"K";
110 PRINT USING
 "10A,10A,10A,20A";"SEGMENT","START(MHZ)",
 "STOP(MHZ)","NUMBER OF POINTS"
120 FOR I=1 TO Numb
130 GOSUB Loadpoin

140 NEXT I
150 LOOP
```

Prepare the HP 8753B for HP-IB control  
Activate the frequency list edit mode.  
Setup a FOR NEXT loop.  
Delete any existing segments.

Find out how many segments to expect  
Create a table to hold the segments. We only  
keep start frequency, stop frequency, and  
number of points.  
Make sure we print on the screen.  
Clear the screen.

Print the table header.

Read in each segment.  
Loadpoin (line 300) reads in the start fre-  
quency, stop frequency, and number of points  
for segment I. Since Loadpoin is a sub-  
routine, I is used as a global variable.

Use the LOOP, EXIT IF, END LOOP  
structure to loop and edit the table until the  
operator indicates that editing is no longer  
desired. This structure sets up a loop with the  
exit point in the middle of the loop rather than  
at the beginning (as with WHILE, END  
WHILE), or at the end (as with REPEAT,  
UNTIL).

|                                                                                                                                                                                                                                                                                                                                                                                                                                                                                                                                                                                                                                                                                                                |                                                                                                                                                                                                                                                                                                                                                                                                                                                                                                                                                                                                                                                                                                                                                                                                                                                                                                                                                                                           |
|----------------------------------------------------------------------------------------------------------------------------------------------------------------------------------------------------------------------------------------------------------------------------------------------------------------------------------------------------------------------------------------------------------------------------------------------------------------------------------------------------------------------------------------------------------------------------------------------------------------------------------------------------------------------------------------------------------------|-------------------------------------------------------------------------------------------------------------------------------------------------------------------------------------------------------------------------------------------------------------------------------------------------------------------------------------------------------------------------------------------------------------------------------------------------------------------------------------------------------------------------------------------------------------------------------------------------------------------------------------------------------------------------------------------------------------------------------------------------------------------------------------------------------------------------------------------------------------------------------------------------------------------------------------------------------------------------------------------|
| <pre> 160 INPUT "DO YOU WANT TO EDIT? Y OR N",An\$ 170 EXIT IF An\$="N" 180 INPUT "ENTRY NUMBER?",I 190 GOSUB Loadpoin 200 END LOOP 210 OUTPUT 716;"EDITLIST"  220 FOR I=1 TO Numb 230 OUTPUT 716;"SADD;STAR";Table(I,1);"MHZ;" 240 OUTPUT 716;"STOP";Table(I,2);"MHZ;" 250 OUTPUT 716;"POIN",Table(I,3),";" 260 OUTPUT 716;"SDON;" 270 NEXT I 280 OUTPUT 716;"EDITDONE;LISFREQ;"  290 STOP 300 Loadpoin: ! 310 INPUT "START FREQUENCY? (MHZ)",Table(I,1) 320 INPUT "STOP FREQUENCY? (MHZ)",Table(I,2) 330 INPUT "NUMBER OF POINTS?",Table(I,3) 340 IF Table(I,3)=1 THEN Table(I,2)=Table(I,1)  350 PRINT TABXY(0,I+1);I;TAB(10);Table(I,1);TAB(20);       Table(I,2);TAB(30),Table  360 RETURN 370 END </pre> | <p>Let the operator edit the table. Editing is actually re-entering the entire segment. The old segment values are left in place if the operator presses return without typing anything. Exit the edit loop if editing is finished. Execution is continued at line 210.</p> <p>For editing, get the entry number. And have Loadpoin re-enter the values.</p> <p>Begin the table entry by opening the list frequency table for editing. The list frequency table must be empty, or these segments will just be added on top of the old ones. Loop for each segment.</p> <p>Enter the segment values. Declare the segment done.</p> <p>Close the table, and turn on the list frequency mode.</p> <p>Enter in a segment.</p> <p>Enter the segment values. If only one point in the segment, make the stop frequency equal to the start frequency to avoid ambiguity.</p> <p>Print the segment out. Because of the TABXY, this will print over old segments if a segment is being edited.</p> |
|----------------------------------------------------------------------------------------------------------------------------------------------------------------------------------------------------------------------------------------------------------------------------------------------------------------------------------------------------------------------------------------------------------------------------------------------------------------------------------------------------------------------------------------------------------------------------------------------------------------------------------------------------------------------------------------------------------------|-------------------------------------------------------------------------------------------------------------------------------------------------------------------------------------------------------------------------------------------------------------------------------------------------------------------------------------------------------------------------------------------------------------------------------------------------------------------------------------------------------------------------------------------------------------------------------------------------------------------------------------------------------------------------------------------------------------------------------------------------------------------------------------------------------------------------------------------------------------------------------------------------------------------------------------------------------------------------------------------|

### Running the program

The program displays the frequency list table as it is entered. During editing, the displayed table is updated as each line is edited. The table is not re-ordered. At the completion of editing, the table is entered into the HP 8753B, and list frequency mode turned on. During editing, simply pressing [RETURN] leaves an entry at the old value.

Any segments already in the list frequency table in the HP 8753B will be deleted by the program. If this is not desired, delete lines 40 thru 60. New segments will then simply be entered on top of the old list frequency segments.

## Example 4B: Selecting a single segment from a table of segments

This example program shows how a single segment can be chosen to be the operating frequency range of the HP 8753B, out of a table of segments. The program assumes that a list frequency table has already been entered into the HP 8753B, either manually, or using the program in Example 4A, *Setting up a list frequency sweep*.

The program first loads the list frequency table into the computer by reading the start and stop frequencies of each

segment, and the number of points for each segment. The segments' parameters are then displayed on the computer screen, and the user can choose which segment is to be used by the analyzer. Note that only one segment can be chosen at a time.

This program is stored on the Example Programs disc as **IPG4B**.

```

10 ABORT 7
20 CLEAR 716
30 PRINTER IS 1
40 OUTPUT 2;CHR(255)"K";
50 PRINT USING "10A, 15A, 15A, 20A";"SEGMENT",
 "START(MHZ)", "STOP(MHZ)", "NUMBER OF POINTS"
60 OUTPUT 716;"EDITLIST;SEDI30;OUTPACTI;"

70 ENTER 716;Numsegs

80 ALLOCATE Table(1:Numsegs, 1:3)

90 FOR I=1 to Numsegs

100 GOSUB Readlist
110 NEXT I
120 LOOP

130 INPUT "SELECT SEGMENT NUMBER: (0 TO EXIT)", Segment
140 EXIT IF Segment=0

150 OUTPUT 716;"SSEG"; Segment;"; EDITDONE;"

160 END LOOP
170 OUTPUT 716;"ASEG;"

180 DISP "PROGRAM ENDED"
190 STOP
200 Readlist: !

210 OUTPUT 716;"EDITLIST;SEDI;" , I, ";"
220 OUTPUT 716;"STAR;OUTPACTI;"

230 ENTER 716;Table(I, 1)
240 OUTPUT 716;"STOP;OUTPACTI;"

250 ENTER 716;Table(I, 2)
260 OUTPUT 716;"POIN;OUTPACTI;"

270 ENTER 716;Table(I, 3)
```

Prepare for HP-IB control  
Make sure we print on the screen.  
Clear the screen.  
Print out the table header.

Interrogate the number of the highest segment. This allows the program to determine the number of list frequency segments.  
Read the active parameter (segment number) into the variable `Numsegs`.  
Create an array large enough to hold all the segment parameters.  
This `FOR NEXT` loop calls the subroutine `Readlist` which reads in the segment parameters.

Use the `LOOP` structure to allow continuous selection of the desired segment to be measured.

Allow the operator to exit the loop by entering 0 as the segment number.  
The `SSEG` command causes the specific segment to become the new operating frequency range of the measurement.

When the loop is exited, resume operation using all list frequency segments. The `ASEG` command turns on all the segments.

This subroutine reads out all the segment parameters.  
Activate the `I`th segment.  
Make the start frequency active, and output its value using the `OUTPACTI` command.  
Read the start frequency into the list table.  
Make the stop frequency active, and output its value.  
Read the stop frequency value.  
Make the number of points active, and output its value.  
Read the number of points.

|                                                                                                                                                                                                                   |                                                                                                                                                                                                                                                                                                                                                                                         |
|-------------------------------------------------------------------------------------------------------------------------------------------------------------------------------------------------------------------|-----------------------------------------------------------------------------------------------------------------------------------------------------------------------------------------------------------------------------------------------------------------------------------------------------------------------------------------------------------------------------------------|
| <pre> 280 IF I=18 THEN INPUT "HIT RETURN FOR MORE",A\$ ..... 290 IMAGE 4D,6X,4D.6D,3X,4D.6D,3X,4D ..... 300 PRINT USING 290;I;Table(I,1)/1.E+9;Table(I,2)/ .....       1.E+9;Table(I,3) 310 RETURN 320 END </pre> | <p>Stop printing when 17 segments have been listed on the display, this allows the operator to examine the first 17 segments before they are scrolled off the computer display by addition segments (remember, there are up to 30 segments).</p> <p>Specify the print format and margins for the list frequency table.</p> <p>Print out the segment parameters for the Ith segment.</p> |
|-------------------------------------------------------------------------------------------------------------------------------------------------------------------------------------------------------------------|-----------------------------------------------------------------------------------------------------------------------------------------------------------------------------------------------------------------------------------------------------------------------------------------------------------------------------------------------------------------------------------------|

### Running the program

The program will read the parameters for each list frequency segment from the HP 8753B, and build a table containing all the segments. The parameters of each segment will be printed on the computer screen. If there are more than 17 segments, the program will pause. Press [RETURN] to see more segments. The maximum number of segments that can be read is 30 (which is the maximum number of segments that the HP 8753B can hold). Use the computer's [Prev] and [Next] keys to scroll the list of segments back and forth if there are more than 17 segments.

After all the segments are displayed, the program will prompt for a specific segment to be used. Type in the number of the segment, and the HP 8753B will then "zoom-in" on that segment. The program will continue looping, allowing continuous selection of different segments. To exit the loop, type 0. This will restore all the segments (with the command ASEG), allowing the HP 8753B to sweep all of the segments, and the program will terminate.

### Using limit lines to perform PASS/FAIL tests

There are two steps to performing limit testing on the HP 8753B under HP-IB control. First, limit specifications must be specified and loaded into the analyzer. Second, the limits are activated, the device is measured, and its

performance to the specified limits is signaled by a pass or fail message on the HP 8753B's display.

Example 5A illustrates the first step, setting up limits, and Example 5B performs the actual limit testing.

### Example 5A: Setting up limit lines

The purpose of this example is to show how to create a limit table and transmit it to the HP 8753B.

The command sequence for entering a limit table imitates the key sequence followed when entering a table from the front panel: there is a command for every key press. Editing a limit is also the same as the key sequence, but remember that the HP 8753B automatically re-orders the table in order of increasing start frequency.

The limit table is also carried as part of the learn string. While it cannot be modified as part of the learn string, it can be stored and recalled with very little effort.

This example takes advantage of the computer's capabilities to simplify creating and editing the table. The table is entered and completely edited before being transmitted to the HP 8753B. To simplify the programming task, options such as entering offsets are not included.

This program is stored as **IPG5A** on the Example Programs disc.

|                                                                                                                                                                                                  |                                                                                                                                                                                                                                                                                                                            |
|--------------------------------------------------------------------------------------------------------------------------------------------------------------------------------------------------|----------------------------------------------------------------------------------------------------------------------------------------------------------------------------------------------------------------------------------------------------------------------------------------------------------------------------|
| <pre> 10 ABORT 7 20 CLEAR 716 ..... 30 OUTPUT 716;"EDITLIML;CDEL;" ..... 40 INPUT "Number of limits?",Numb ..... 50 ALLOCATE Table(1:Numb,1:3) ..... 60 ALLOCATE Limtype\$(Numb)[2] ..... </pre> | <p>Prepare the HP 8753B for HP-IB control.</p> <p>Delete any existing limits.</p> <p>Find out how many limits to expect.</p> <p>Create a table to hold the limits. It will contain stimulus value (frequency), upper limit value, and the lower limit value.</p> <p>Create a string array to indicate the limit types.</p> |
|--------------------------------------------------------------------------------------------------------------------------------------------------------------------------------------------------|----------------------------------------------------------------------------------------------------------------------------------------------------------------------------------------------------------------------------------------------------------------------------------------------------------------------------|

```

70 PRINTER IS 1
80 OUTPUT 2;CHR$(255)&"K";
90 PRINT USING
 "10A,20A,15A,20A";"SEG","STIMULUS(MHZ)",
 "UPPER (dB)","LOWER (dB)","TYPE"
100 FOR I=1 TO Numb
110 GOSUB Loadlimit

120 NEXT I
130 LOOP

140 INPUT "DO YOU WANT TO EDIT? Y OR N",An$

150 EXIT IF An$="N"

160 INPUT "ENTRY NUMBER?",I
170 GOSUB Loadlimit
180 END LOOP
190 OUTPUT 716;"EDITLIML;".

200 FOR I=1 TO Numb
210 OUTPUT 716;"SADD;LIMS";Table(I,1);"MHZ;"
220 OUTPUT 716;"LIMU";Table(I,2);"DB;"
230 OUTPUT 716;"LIML",Table(I,3),"DB;"
240 IF Limtype$(I)="FL" THEN OUTPUT 716;"LIMTFL;"
250 IF Limtype$(I)="SL" THEN OUTPUT 716;"LIMTSL;"
260 IF Limtype$(I)="SP" THEN OUTPUT 716;"LIMTSP;"
270 OUTPUT 716;"SDON;"
280 NEXT I
290 OUTPUT 716;"EDITDONE;LIMILINEON; LIMITESTON;"

300 STOP
310 Loadlimit: !
320 INPUT "STIMULUS VALUE? (MHZ)",Table(I,1)
330 INPUT "UPPER LIMIT VALUE (DB)?",Table(I,2)
340 INPUT "LOWER LIMIT VALUE (DB)?",Table(I,3)
350 INPUT "LIMIT TYPE" (FL=FLAT, SL=SLOPED, SP=SINGLE
 POINT)",Limtype$(I)

360 PRINT TABXY(0,I+1);I;TAB(10);Table(I,1);TAB(30);
 Table(I,2);TAB(45);Table(I,3);TAB(67);Limtype$(I)

370 RETURN
380 END

```

Make sure we print on the screen.  
Clear the screen.

Print the table header.

Read in each segment.  
**Loadlimit** (line 310) reads in the stimulus value (frequency), upper value, lower value, and the limit type for limit **I**. Since **Loadlimit** is a subroutine, **I** is used as a global variable.

Use the **LOOP**, **EXIT IF**, **END LOOP** structure to loop and edit the table until the operator indicates that editing is no longer desired. This structure sets up a loop with the exit point in the middle of the loop rather than at the beginning (as with **WHILE**, **END WHILE**), or at the end (as with **REPEAT**, **UNTIL**).

Let the operator edit the table. Editing is actually re-entering the entire limit. The old limit values are left in place if the operator presses return without typing anything.

Exit the edit loop if editing is finished. Execution is continued at line 190.

For editing, get the entry number.  
And have **Loadlimit** re-enter the values.

Begin the table entry by opening the limit table for editing. The limit table must be empty, or these limits will just be added on top of the old ones.

Loop for each limit.  
Enter the stimulus value.  
Enter the upper limit value.  
Enter the lower limit value.  
Set flat limit type.  
Set sloped limit type.  
Set point limit type.  
Declare the limit done.

Close the table, display the limits, and activate limit testing.

Enter in a segment.

Enter the limit values.  
Enter the limit type.

Print the limit values out. Because of the **TABXY**, this will print over old limits if a limit is being edited.

## Running the program

The program displays the limit table as it is entered. During editing, the displayed table is updated as each line is edited. The table is not reordered. At the completion of editing, the table is entered into the HP 8753B, and limit testing mode turned on. During editing, simply pressing **[RETURN]** leaves an entry at the old value.

This example program will delete any existing limit lines before entering the new limits. If this is not desired, omit lines 30 through 50.

## Example 5B: Performing PASS/FAIL tests while tuning

The purpose of this example is to demonstrate the use of the limit/search fail bits in event status register B, to determine whether a device passes the specified limits. Limits can be entered manually, or using the Example 5A.

The limit/search fail bits are set and latched when limit testing or a marker search fails. There are four bits, one for each channel for both limit testing and marker search. Their purpose is to allow the computer to determine whether the test/search just executed was successful. The sequence of their use is to clear event status register B, trigger the limit test or marker search, and then check the appropriate fail bit.

In the case of limit testing, the best way to trigger the limit test is to trigger a single sweep. By the time the SING command finishes, limit testing will have occurred. A second consideration when dealing with limit testing is that if the device is tuned during the sweep, it may be tuned into and then out of limit, causing a limit test pass when the device is not in fact within limits.

In the case of the marker searches (max, min, target, and widths), outputting marker or bandwidth values automati-

cally triggers any related searches. Hence, all that is needed is to check the fail bit after reading the data.

In this example, the requirement that several sweeps in a row must pass is used in order to give confidence that the limit test pass was not extraneous due to the device settling or the operator tuning during the sweep. Upon running the program, the number of passed sweeps for qualification is entered. For very slow sweeps, a small number of sweeps such as two is appropriate. For very fast sweeps, where the device needs time to settle after tuning and the operator needs time to get away from the device, as many sweeps as six or more sweeps might be appropriate.

A limit test table can be entered over HP-IB: the sequence is very similar to that used in entering a list frequency table and is shown in Example 5A. The manual sequence is closely followed.

This program is stored under **IPG5B** on the Example Programs disc.

|     |                                                                      |                                                                                                   |
|-----|----------------------------------------------------------------------|---------------------------------------------------------------------------------------------------|
| 10  | ABORT 7                                                              |                                                                                                   |
| 20  | CLEAR 716                                                            | Prepare the HP 8753B for remote control.                                                          |
| 30  | INPUT "Number of consecutive passed sweeps for qualification?", Qual | Find out how many sweeps must pass before the device is considered to have passed the limit test. |
| 40  | DISP "TUNE DEVICE"                                                   | Tell operator to begin tuning.                                                                    |
| 50  | Reap=0                                                               | Reap is a counter holding how many sweeps have passed the limit test.                             |
| 60  | OUTPUT 716;"OPC?;SING;"                                              | Take a sweep. When it is done, limit test will have occurred.                                     |
| 70  | ENTER 716;Reply                                                      | Wait for the end of the sweep.                                                                    |
| 80  | OUTPUT 716;"ESB?;"                                                   | Check to see if the fail bit is set.                                                              |
| 90  | ENTER 716;Estat                                                      |                                                                                                   |
| 100 | IF BIT(Estat,4) THEN                                                 | If the fail bit for channel one is set, reset the number of sweeps passed counter.                |
| 110 | IF Reap<>0 THEN BEEP 1200,.05                                        | If sweeps had been passing, warn the operator that the device is now failing.                     |
| 120 | Reap=0                                                               |                                                                                                   |
| 130 | GOTO 40                                                              |                                                                                                   |
| 140 | END IF                                                               | If the fail bit was not set, tell the operator.                                                   |
| 150 | BEEP 2500,.01                                                        |                                                                                                   |
| 160 | Reap=Reap+1                                                          | Increment the sweeps passed counter.                                                              |
| 170 | DISP "STOP TUNING"                                                   | Encourage the operator to stop tuning the device.                                                 |
| 180 | IF Reap<Qual THEN GOTO 60                                            | If not enough sweeps have passed, loop.                                                           |
| 190 | DISP "DEVICE PASSED!"                                                | The device has passed.                                                                            |
| 200 | FOR I=1 TO 10                                                        | Warble, telling the operator the device has passed, using an audible signal.                      |
| 210 | BEEP 1000,.05                                                        |                                                                                                   |
| 220 | BEEP 2000,.01                                                        |                                                                                                   |
| 230 | NEXT I                                                               |                                                                                                   |
| 240 | INPUT "HIT RETURN FOR NEXT DEVICE", Dum\$                            | Wait for the next device.                                                                         |
| 250 | GOTO 40                                                              |                                                                                                   |
| 260 | END                                                                  |                                                                                                   |

## Running the program

Set up a limit table on channel 1 for a specific device either manually, or using the program in Example 5A. Run the program, and enter the number of passed sweeps desired for qualification. After entering the qualification number, connect the filter. When a sweep passes, the computer beeps. When enough sweeps in a row pass to qualify the device, the computer warbles at the operator, and then asks for a new device.

The program assumes a response calibration (thru calibration) or full 2-port calibration has been performed prior to running the program. Try causing the DUT to fail by loosening the cables connecting the DUT to the HP 8753B, and then retightening them.

## Storing and recalling instrument states

The purpose of this example is to demonstrate ways of storing and recalling entire instrument states over HP-IB. The two methods discussed are to use the learn string, and to use the computer to coordinate direct store/load of instrument states to disc.

Using the learn string is a very rapid way of saving the instrument state, but using direct disc access has the advantage of automatically storing calibrations, cal kits, and data along with the instrument state.

## Example 6A: Using the learn string

The learn string is a very fast and easy way to read an instrument state. The learn string includes all front panel settings, the limit table for each channel, and the list frequency table. The learn string is read out with OUTPLEAS, and put back

into the instrument with INPULEAS. The string itself is in form 1, and is no longer than 3000 bytes long.

This example program is stored on the Example Programs disc as **IPG6A**.

```
10 DIM State$(3000)
20 OUTPUT 716;"OUTPLEAS;"
30 ENTER 716 USING "-K";State$

40 LOCAL 716
50 INPUT "CHANGE STATE AND HIT RETURN",Dum$

60 OUTPUT 716;"INPULEAS";STATE$
70 DISP "INITIAL INSTRUMENT STATE RESTORED"
80 END
```

Set up the receive string.  
Request the learn string.  
Read in the learn string. Normally, the enter state-ment will terminate if a line feed is received, so USING "-K" is used, which allows termination only on End Or Identify.  
Put the analyzer in LOCAL mode.  
Give the operator a chance to modify the state.  
Transmit the state back to the HP 8753B.

## Running the program

Run the program. When the program stops, change the instrument state and press [RETURN]. The HP 8753B will return its original state.

## Example 6B: Coordinating disc storage

To have the HP 8753B store an instrument state on disc, specify the state name by titling a file using `TITF n`, then specify a `STOR n` of that file, where `n` is the file number, 1 to 5. On receipt of the store command, the HP 8753B will request active control. When control is received, the HP 8753B will store the instrument state on disc as defined under the `[DEFINE STORE]` menu.

```
10 ABORT 7
20 CLEAR 716
30 INPUT "STATE TITLE? PRESS RETURN", Nam$
40 OUTPUT 716; "USEPASC; "
50 OUTPUT 716; "TITF1"""; Nam$; """"; STOR1; "

60 DISP "SAVING ON DISC"
70 SEND 7; TALK 16 CMD9

80 STATUS 7,6; Stat
90 IF NOT BIT(Stat,6) THEN GOTO 80
100 INPUT "STATE STORED. HIT RETURN TO RECALL", Dum$
110 INPUT "STATE TITLE?", Nam$
120 OUTPUT 716; "TITF1"""; Nam$; """"; LOAD1; "
130 DISP "READING DISC"
140 SEND 7; TALK 16 CMD9
150 STATUS 7,6; Stat
160 IF NOT BIT(Stat,6) THEN GOTO 150
170 DISP "DONE"

180 END
```

### Running the program

Put a formatted disc in the disc drive, and point the HP 8753B's disc address, unit number, and volume number towards that drive. Run the example, and when the program

Similarly, to have the HP 8753B load a file from disc, specify the state name as before, and then request a `LOAD n` of that file. The best way of learning what the register titles on the disc are is to use the `[READ FILE TITLES]` under the `[RECALL]` key.

This example program is stored on the Example Programs disc as `IPG6B`.

Prepare the HP 8753B for remote control.  
Get the name of the file to create.  
Tell the HP 8753B to use pass control mode.  
Title register 1, and store it. The title must be preceded and followed by double quotation marks, and the only way to do that with an output statement is to use two sets of quotation marks: """.  
Pass control to the HP 8753B, assuming it has interpreted the `STOR 1` command and set the request control bit.  
Wait for active control to return.  
Get the name of the file to read.  
Title register one, and request a load.  
Pass control.  
Wait for control to return.  
The program is done, and the state has been loaded back into the instrument.

pauses, change the instrument state so that a change will be noticeable. Pressing return will recall the state just stored, or a completely different state can be recalled.

## Example 6C: Reading calibration data

This example demonstrates how to read measurement calibration data out of the HP 8753B, how to put it back into the instrument, and how to determine which calibration is active.

The data used to perform measurement error correction is stored inside the HP 8753B in up to twelve calibration coefficient arrays. Each array is a specific error coefficient, and is stored and transmitted as an error corrected data array: each point is a real/imaginary pair, and the number of points in the array is the same as the number of points in the sweep. The four data formats also apply to the transfer of calibration coefficient arrays. Appendix C, *Calibration*, of the *Quick Reference Guide* specifies where the calibration coefficients are stored for different calibration types.

A computer can read out the error coefficients using the commands `OUTPCALC01`, `OUTPCALC02`, . . . `OUTPCALC12`. Each calibration type uses only as many arrays as needed, starting with array 1. Hence, it is necessary to know the type of calibration about to be read out: attempting to read an array not being used in the current calibration

causes the "REQUESTED DATA NOT CURRENTLY AVAILABLE" warning.

A computer can also store calibration coefficients in the HP 8753B. To do this, declare the type of calibration data about to be stored in the HP 8753B just as if you were about to perform that calibration. Then, instead of calling up different classes, transfer the calibration coefficients using the `INPUALC n n` commands. When all the coefficients are in the HP 8753B, activate the calibration by issuing the mnemonic `SAVC`, and have the HP 8753B take a sweep.

This example reads the calibration coefficients into a very large array, from which they can be examined, modified, stored, or put back into the instrument. If the data is to be directly stored onto disc, it is usually more efficient to use form 1 (HP 8753B internal binary format), and to store each coefficient array as it is read in.

This program is stored on the Example Programs disc as `IPG6C`.



|     |                                                      |                                                                                                                                            |
|-----|------------------------------------------------------|--------------------------------------------------------------------------------------------------------------------------------------------|
| 10  | ABORT 7                                              |                                                                                                                                            |
| 20  | CLEAR 716                                            | Prepare the HP 8753B for HP-IB control.                                                                                                    |
| 30  | DATA "CALIRESP", 1, "CALIRAI", 2, "CALIS111", 3      |                                                                                                                                            |
| 40  | DATA "CALIS221", 3, "CALIFUL2", 12                   |                                                                                                                                            |
| 50  | DATA "NOOP", 0                                       | Set up the data base of possible calibrations, and the number of arrays associated with each calibration.                                  |
| 60  | INTEGER Hdr, Lgth, I, J                              | Define integers to hold the header, and to act as counters.                                                                                |
| 70  | ASSIGN @Dt TO 716; FORMAT OFF                        |                                                                                                                                            |
| 80  | READ Calt\$, Numb                                    | Get a calibration type and the number of associated arrays.                                                                                |
| 90  | IF Numb=0 THEN GOTO 360                              | If correction was not on, stop the program.                                                                                                |
| 100 | OUTPUT 716; Calt\$; "?:"                             | Interrogate the HP 8753B to see if this calibration is active.                                                                             |
| 110 | ENTER 716; Active                                    |                                                                                                                                            |
| 120 | IF NOT Active THEN GOTO 80                           | If the calibration was not active, loop.                                                                                                   |
| 130 | DISP Calt\$, Numb                                    | Show the operator that we have found the calibration and number of arrays.                                                                 |
| 140 | OUTPUT 716; "FORM3; POIN?;"                          | Find out how many points to expect.                                                                                                        |
| 150 | ENTER 716; Poin                                      |                                                                                                                                            |
| 160 | ALLOCATE Cal(1:Numb, 1:Poin, 1:2)                    | Create a very large array to hold all the coefficients.                                                                                    |
| 170 | FOR I=1 TO Numb                                      | Loop once for each calibration coefficient.                                                                                                |
| 180 | OUTPUT 716 USING "K, ZZ"; "OUTPCALC", I              | Request the calibration coefficient. The K transmits OUTPCALC literally, and ZZ transmits I as two digits, using a leading zero if needed. |
| 190 | ENTER @Dt; Hdr, Lgth                                 | Read the header.                                                                                                                           |
| 200 | FOR J=1 TO Poin                                      |                                                                                                                                            |
| 210 | ENTER @Dt; Cal(I, J, 1), Cal(I, J, 2)                | Since we are not filling the entire array, we have to read each point individually.                                                        |
| 220 | NEXT J                                               |                                                                                                                                            |
| 230 | NEXT I                                               |                                                                                                                                            |
| 240 | INPUT "HIT RETURN TO RE-TRANSMIT CALIBRATION", Dum\$ | The calibration data is now all in the computer.                                                                                           |
| 250 | OUTPUT 716; Calt\$, "?:"                             | Begin the calibration retransmission by declaring what calibration type is about to be loaded.                                             |
| 260 | FOR I=1 TO Numb                                      | Now load each calibration coefficient.                                                                                                     |
| 270 | DISP "TRANSMITTING ARRAY: ", I                       |                                                                                                                                            |
| 280 | OUTPUT 716 USING "K, ZZ"; "FORM3; INPUCALC", I       |                                                                                                                                            |
| 290 | OUTPUT @Dt; Hdr, Lgth                                |                                                                                                                                            |
| 300 | FOR J=1 TO Poin                                      |                                                                                                                                            |
| 310 | OUTPUT @Dt; Cal(I, J, 1), Cal(I, J, 2)               |                                                                                                                                            |
| 320 | NEXT J                                               |                                                                                                                                            |
| 330 | NEXT I                                               | All of the calibration data has been loaded.                                                                                               |
| 340 | OUTPUT 716; "SAVC; "                                 | End the sequence by activating the calibration.                                                                                            |
| 350 | OUTPUT 716; "CONT; "                                 | Trigger a sweep so the calibration becomes active.                                                                                         |
| 360 | DISP "DONE"                                          |                                                                                                                                            |
| 370 | END                                                  |                                                                                                                                            |

## Running the program

Before executing the program, perform a calibration.

The program is able to detect what calibration is active, and with that information it predicts how many arrays to read out. When all the arrays are inside the computer, the program prompts the user. At this point, turn calibration off, or perform a completely different calibration on the HP 8753B. Then press continue on the computer, and the computer will reload the old calibration.

Note that the retransmitted calibration is associated with the current instrument state: the instrument has no way of knowing the original state associated with the calibration data. For this reason, it is recommended that the learn string be used to store the instrument state whenever calibration data is stored. See Example 6A, *Using the learn string*.

# Miscellaneous Programming Examples

## Controlling peripherals

The purpose of this section is to demonstrate how to coordinate printers, plotters, power meters, and disc drives with the HP 8753B.

The HP 8753B has three operating modes with respect to HP-IB, as set under the [LOCAL] menu. System controller mode is used when no computer is present. The other two modes allow the computer to coordinate certain actions: in talker/listener mode the computer can control the HP 8753B, as well as coordinate plotting and printing, and in pass control

mode the computer can pass active control to the HP 8753B so that the HP 8753B can plot, print, control a power meter, or load/store to disc. Peripheral control is the major difference between the two modes.

Note that the HP 8753B assumes that the address of the computer is correctly stored in its HP-IB addresses menu under the [ADDRESS: CONTROLLER] entry. If this address is incorrect, control will not return to the computer. Similarly, if control is passed to the HP 8753B while it is in talker/listener mode, control will not return to the computer.

### Example 7A: Operation using Talker/Listener mode

The commands OUTPPLOT and OUTPPRIN allow talker/listener mode plotting and printing via a one way data path from the HP 8753B to the plotter or printer. The computer sets up the path by addressing the HP 8753B to talk and the plotter to listen and then placing the bus into data mode. The HP 8753B will then make the plot or print. When it is

finished, it asserts the End or Identify (EOI) control line on HP-IB.

This program makes a plot using the talker/listener mode. It is stored on the Example Programs disc as **IPG7A**.

```
10 OUTPUT 716;"OUTPPLOT;"
20 SEND 7;UNL LISTEN 5 TALK 16 DATA
30 DISP "PLOTTING"
40 STATUS 7,7;Stat
50 IF NOT BIT(Stat,11) THEN GOTO 40
60 DISP "DONE"
70 END
```

Command the HP 8753B to plot using the talker/listener mode plot command. For a printer, use OUTPPRIN;.

Use the HP-IB control commands to establish a data path from the HP 8753B to the plotter. SEND 7 sends bus control commands. UNL clears out the last data path. LISTEN 5 tells the device at address 5, the default address for a plotter, to accept the data. For printing, substitute the address 1, the default for a printer, and change "OUTPPLOT;" in line 10 to "OUTPPRIN;". TALK 16 tells the HP 8753B to talk; that is, transmit the contents of its output queue. When DATA is executed, the bus changes from command to data mode, and the HP 8753B makes the plot.

This statement serves the dual purpose of informing the user of the state of the program and preventing interrogation of status register 7 immediately after the SEND statement, when the register state is unstable.

Now wait for the HP 8753B to assert the EOI line, indicating the end of transmission. The STATUS command accesses the status registers for the interfaces installed on the computer. In this case, we access interface 7 (HP-IB), register 7, HP-IB status. The value of the register is placed in the variable Stat. We are specifically interested in bit 11, which is assigned to the EOI line.

If bit 11 is not set, then the EOI line is not being asserted by the HP 8753B, so loop and check again.

The HP 8753B has asserted EOI to indicate that it has finished with the plot.

## Running the program

The HP 8753B will go into remote, and make the plot. During the plot, the computer will display the message `PLOTTING`. One of the attributes of the `OUTPLOT` command is that the plot can include the current softkey menu. The plotting of the softkeys is enabled with the command `PSOFTON` and disabled with `PSOFTOFF`.

When the plot is completed, the HP 8753B asserts the EOI line on HP-IB. The computer detects this and displays the `DONE` message. The HP 8753B will go on asserting EOI until some other activity on the bus causes it to clear the line.

If a problem arises with the plotter, such as no pen or paper, the HP 8753B cannot detect the situation because it only has a one-way path of communication. Hence, the HP 8753B will attempt to continue plotting until the operator intervenes and aborts the plot by pressing the `[LOCAL]` key. This key aborts the plot, causes the warning message "CAUTION: PLOT ABORTED," asserts EOI, and hence frees the computer. Because of possible malfunctions, it is generally advisable to use pass control mode, which allows two way communication between the plotter and the HP 8753B.

## Example 7B: Operation using pass control mode

If the HP 8753B is in pass control mode and it receives a command telling it to plot, print, control a power meter, or store/load to disc, it sets bit 1 in the event status register to indicate that it needs control of the bus. If the computer then uses the HP-IB control command to pass control to the HP 8753B, the HP 8753B will take control of the bus, and access the peripheral. When the HP 8753B no longer requires control, it will pass control back to the computer. When performing a power meter cal over HP-IB, the HP 8753B requests control at each measurement point in a sweep which is typically  $\cong 3 \times$  the number of readings.

Control should not be passed to the HP 8753B before it has set event status register bit 1, Request Active Control. If the

HP 8753B receives control before the bit is set, control is passed immediately back.

While the HP 8753B has control, it is free to address devices to talk and listen as needed. The only functions denied it are the ability to assert the interface clear line (IFC), and the remote line (REN). These are reserved for the system controller. As active controller, the HP 8753B can send messages to and read replies back from printers, plotters, and disc drives.

This example prints the display. It is stored on the Example Programs disc as `IPG7B`. The program could request a plot with `PLOT`, or a disc access with a command such as `REFT` (read file titles.)

|     |                                              |                                                                                                                                                                                                                                                                                                                                                   |
|-----|----------------------------------------------|---------------------------------------------------------------------------------------------------------------------------------------------------------------------------------------------------------------------------------------------------------------------------------------------------------------------------------------------------|
| 10  | <code>OUTPUT 716;"CLES;ESE2;"</code>         | Clear the status reporting system, and enable the Request Active Control bit in the event status register.                                                                                                                                                                                                                                        |
| 20  | <code>OUTPUT 716;"USEPASC;PRINALL;"</code>   | Put the HP 8753B in pass control mode, and request a print.                                                                                                                                                                                                                                                                                       |
| 30  | <code>Stat=SPOLL(716)</code>                 | Get the status byte of the HP 8753B.                                                                                                                                                                                                                                                                                                              |
| 40  | <code>IF NOT BIT(Stat,5) THEN GOTO 30</code> | If the HP 8753B is not requesting control, loop and wait.                                                                                                                                                                                                                                                                                         |
| 50  | <code>SEND 7;TALK 16 CMD 9</code>            | This is the bus command to pass active control to device 16. With BASIC 3.0 or higher, or 2.0 with extensions 2.1, the command <code>PASS CONTROL 716</code> can be used instead.                                                                                                                                                                 |
| 60  | <code>DISP "PRINTING"</code>                 |                                                                                                                                                                                                                                                                                                                                                   |
| 70  | <code>STATUS 7,6;Hp1b</code>                 | To determine when the print is finished, watch for return of active control. The <code>STATUS</code> command loads the interface 7 (HP-IB) register 6, the computer's status with respect to HP-IB, into the variable <code>Hp1b</code> . Bit 6 tells if the computer is the active controller: it will be set when the HP 8753B returns control. |
| 80  | <code>IF NOT BIT(Hp1b,6) THEN GOTO 70</code> | If control has not returned, loop and wait.                                                                                                                                                                                                                                                                                                       |
| 90  | <code>DISP "DONE"</code>                     | Control has returned.                                                                                                                                                                                                                                                                                                                             |
| 100 | <code>END</code>                             |                                                                                                                                                                                                                                                                                                                                                   |

## Running the program

The HP 8753B will very briefly flash the message `WAITING FOR CONTROL`, before actually receiving control and making the print. The computer will display the `PRINTING` message.

When the print is complete, the HP 8753B passes control back to the address stored as the controller address under the `[LOCAL][SET ADDRESSES]` menu. The computer will detect the return of active control and exit the wait loop.

Because the program waits for the HP 8753B's request for control, it can be used to respond to front panel requests as well. Delete `PRINALL;` from line 20, and run the program. Nothing will happen until you go to the front panel of the HP 8753B and request a print, plot, or disc access. For example, press `[LOCAL][COPY]` and `[PRINT]`.

## Example 8: Creating a user interface

This example shows how to create a custom user interface involving only the front panel keys and display of the HP 8753B.

### User graphics

The HP 8753B's display can be treated as an HP-GL plotter. The BASIC graphics commands can be used to create a custom display. Some of the more useful commands are as follows. `VIEWPORT` defines what area of the display is to be plotted on. `WINDOW` allows you to specify the plotting units (i.e. how many units per axis) in the `VIEWPORT` defined area. `DRAW` draws lines from point to point. `MOVE` moves the logical pen without drawing anything. `GCLEAR` clears the graphics display area. `PEN` selects the line intensity, and `LINE TYPE` selects various line types.

All of the BASIC graphics statements are accepted. The `LABEL` statement is not recommended because it fills the display memory up very rapidly as opposed to when the HP-GL `LB` command is used. See the `Waitforkey` subroutine of Example 2A for an example of the `LB` command.

HP-GL (Hewlett-Packard Graphics Language) commands, such as the `LB` command mentioned above, can be directly sent to the HP 8753B display with the `OUTPUT` statement. See Appendix D, *Display Graphics*, of the *Quick Reference Guide* for a list of the HP-GL commands accepted, and their functions.

```
10 INTEGERHdr,Lgth,Keyc
20 ASSIGN@Dt TO 716;FORMAT OFF
30 OUTPUT 716;"HOLD;AUTO;CLES;ESE 64;POIN?;"

40 ENTER 716;Poin
50 GINIT

60 PLOTTER IS 717,"HPGL"
70 OUTPUT 717;"CS;"
80 Cx=55

90 Cy=60

100 S=20
110 REPEAT

120 LINE TYPE 4
130 GCLEAR
140 IF Cx>160 THEN Cx=160
150 IF Cx<-17 THEN Cx=-17
```

### Front panel control

It is possible to take over the front panel keys. The user request bit in the event status register is set whenever a front panel key is pressed or the knob is turned, whether the instrument is in remote or local mode. Each key has a number associated with it, as shown in Figure E.4, *Front Panel Keycodes* of the *Quick Reference Guide*. The number of the key last pressed can be read with the `KOR?` and the `OUTPKEY?` commands. With `KOR?`, a knob turn is reported as a negative number encoded with the number of counts turned. With `OUTPKEY?`, a knob turn is always reported as a negative one.

The keycode encoding with `KOR?` is as follows. Clockwise rotations are reported as numbers from  $-1$  to  $-64$ ,  $-1$  being a very small rotation. Counter-clockwise rotations are reported as the numbers  $-32,767$  to  $-32,703$ ,  $-32,767$  being a very small rotation. Hence, clockwise rotations don't need any decoding at all, and counter-clockwise rotations can be decoded by adding 32,768.

There are approximately 120 counts per knob rotation, and sign of the count depends on the direction the knob was turned.

This example uses the knob and the up and down keys on the HP 8753B to position a grid on the display. Pressing **[ENTRY OFF]** on the HP 8753B causes the computer to put a trace on the grid.

This example program is stored on the Example Programs disc as `IPG8`.

Declare variables to hold the header and the key code.

Define an IO path with formatting off, to receive the form 3 trace data for plotting.

Prepare the instrument. `HOLD;AUTO;` freezes and scales the trace for plotting. `CLES;ESE 64;` clears the status reporting system and enables the User Request bit in the event status register. Lastly, `POIN?;` requests the number of points.

Read in the number of points. Initialize the graphics functions in the computer.

Specify the HP 8753B display as the plotting device.

Turn off the measurement display.

Initialize the x position of the center of the rectangle.

Initialize the y position of the center of the rectangle.

Set the size of the rectangle.

The `REPEAT, UNTIL` structure sets up a loop that keeps repeating until the condition specified in the `UNTIL` statement is found to be true. The condition is checked at the end of the loop. In this case, loop and redraw the rectangle until **[ENTRY OFF]** has been pressed.

Select a dashed line for the rectangle.

Clear the graphics area on the HP 8753B.

Prevent box from going off the screen.

Note that these values are linked to the increments set in lines 270/310 and 320!

|                                      |                                                                                                                                                                       |
|--------------------------------------|-----------------------------------------------------------------------------------------------------------------------------------------------------------------------|
| 160 IF Cy>115 THEN Cy=115            | Define the area of the rectangle, which will become the plotting area for the grid and trace.                                                                         |
| 170 IF Cy<-15 THEN Cy=-15            |                                                                                                                                                                       |
| 180 VIEWPORT Cx-S, Cx+S, Cy-S, Cy+S  | Define the units along the edges of the rectangle. In this case, the horizontal edge has as many units as points in the sweep, and the vertical edge is simply unity. |
| 190 WINDOW 0, Poin-1, 0, 1           | Draw the rectangle around the plotting area.                                                                                                                          |
| 200 FRAME                            | Read the status byte.                                                                                                                                                 |
| 210 Stat=SPOLL(716)                  | If bit 5 is not set, a key has not been pressed, so loop and wait.                                                                                                    |
| 220 IF NOT BIT(Stat,5) THEN GOTO 170 | A key press has occurred, so read the event status register in order to clear the latched bit.                                                                        |
| 230 OUTPUT 716;"ESR?;"               | Read in the register value, but do nothing with it.                                                                                                                   |
| 240 ENTER 716;Estat                  | Now read in the key or knob count.                                                                                                                                    |
| 250 OUTPUT 716;"KOR?;"               |                                                                                                                                                                       |
| 260 ENTER 716;Keyc                   | Key 26 is the up key, so shift the rectangle up.                                                                                                                      |
| 270 IF Keyc=26 THEN Cy=Cy+5          |                                                                                                                                                                       |
| 280 IF Keyc=18 THEN Cy=Cy-5          | Key 18 is the down key, so shift the rectangle down.                                                                                                                  |
| 290 IF Keyc<0 THEN                   | If the keycode was negative, then it is a knob count.                                                                                                                 |
| 300 Knb=Keyc                         | Decode the knob count into the variable Knb.                                                                                                                          |
| 310 IF Knb<-64 THEN Knb=Knb+32768    | If the count is less than -64, add 32768 (2 <sup>15</sup> ) to recover the knob count. If the count is more than -64, then no decoding is needed.                     |
| 320 Cx=Cx-Knb*3                      | Shift the rectangle according the knob count, multiplying the knob count to make the rectangle move farther.                                                          |
| 330 END IF                           |                                                                                                                                                                       |
| 340 UNTIL Keyc=34                    | This is the end of the REPEAT, UNTIL structure. Leave the loop only when key 34, [ENTRY OFF] has been pressed.                                                        |
| 350 GRID(Poin-1)/10,.1               | [ENTRY OFF] has been pressed, so draw the grid and the trace. This statement draws a grid with 10 divisions on each axis.                                             |
| 360 LINE TYPE 1                      | Use a solid line for the trace.                                                                                                                                       |
| 370 OUTPUT 716;"FORM3;OUTPFORM;"     | Now get the trace data.                                                                                                                                               |
| 380 ENTER@Dt;Hdr,Lgth                | Get the header information.                                                                                                                                           |
| 390 ALLOCATE Dat(1:Poin,1:2)         | Define the receiving array.                                                                                                                                           |
| 400 ENTER@Dt;Dat(*)                  | And read in the data.                                                                                                                                                 |
| 410 OUTPUT 716;"SCAL?;"              | Instead of scaling the data in this program, interrogate the scale factor the HP 8753B was using.                                                                     |
| 420 ENTER 716;Scal                   |                                                                                                                                                                       |
| 430 OUTPUT 716;"REFV?;"              | Similarly, use the value at the reference position to decide where to draw the trace.                                                                                 |
| 440 ENTER 716;Ref                    |                                                                                                                                                                       |
| 450 OUTPUT 716;"REFP?;"              | Interrogate the current reference position being used.                                                                                                                |
| 460 ENTER 716;Refp                   |                                                                                                                                                                       |
| 470 Bot=Ref-Refp*Scal                | Calculate the value of the bottom grid line.                                                                                                                          |
| 480 Full=10*Scal                     | And define the full scale span across the grid.                                                                                                                       |
| 490 MOVE 0,(Dat(1,1)-Bot)/Full       | Go to the first point on the trace without drawing anything.                                                                                                          |
| 500 FOR I=1 TO Poin-1                | And draw all the rest of the points in the trace.                                                                                                                     |
| 510 DRAW I,(Dat(I,1)-Bot)/Full       |                                                                                                                                                                       |
| 520 NEXT I                           | The trace is drawn, so end the program.                                                                                                                               |
| 530 END                              |                                                                                                                                                                       |

### Running the program

Before running the program, set the instrument up to make a measurement. The HP 8753B will not accept a graphics dump of a trace of greater than 1601 points.

Run the program, and go to the front panel of the HP 8753B.

The measurement display has been turned off, and there is a box on the screen. The knob moves the box left and right, and the up/down keys move the box up and down. When you are satisfied with the position of the box, press [ENTRY OFF]. The computer will fill the box with a grid, and plot the current measurement data on the grid.

## Transferring disc data files

An external disc drive is often used to store data files in addition to instrument states (see Example 6B). Instrument states, graphics files, data trace files, calibration data files, and memory trace files can be stored on disc. The file name is then appended with up to two characters to indicate what is in the file. For example, if channel 2 error-corrected data is saved to

disc as DEVICE, the actual error-corrected data would be stored in DEVICED2. As with all data files stored on disc, they are stored in form 3. See Appendix E.3: *Disc file names* in the *Quick Reference Guide* for a complete list of the types of files saved to disc as well as the corresponding appendages to file names.

### Example 9: Reading data files into a computer

This example demonstrates how to recall a specific disc file into a computer. First, EXTMADTAON defines the storage of the current trace as error-corrected data. After the file is stored

to disc, the computer reads the error-corrected data into an array. The program can easily be modified to read and transfer raw data, memory traces, and formatted data.

```
10 ABORT 7
20 CLEAR 716
30 INPUT "STATE TITLE?" , Nam$
40 OUTPUT 716 ; "USEPASC ; "
50 OUTPUT 716 ; "TITF1"""" ; Nam$; """" ; EXTMDATAON ; STOR1 ; "

60 DISP "SAVING ON DISC"
70 SEND 7 ; TALK 16 CMD 9

80 STATUS 7 , 6 ; Stat
90 IF NOT BIT (Stat , 6) THEN GOTO 80
100 DISP "READING DATA INTO Disc_dat ARRAY"
110 ASSIGN @Dt TO Nam$ & "D1" ; FORMAT OFF

120 ALLOCATE Disc=dat (1 : 201 , 1 : 2)

130 ENTER @Dt ; Disc_dat (*)

140 ASSIGN @Dt TO *
150 DISP Disc_dat (1 , 1) , Disc_dat (1 , 2)
160 END
```

Prepare the HP 8753B for remote control. Get the name of the file to create. Tell the HP 8753B to use pass control mode. Title register 1, and store the instrument state and error-corrected data. The title must be preceded and followed by double quotation marks. The only way to do this within an output statement is to use two sets of quotation marks: " " .

Pass control to the HP 8753B, assuming it has interpreted the STOR 1 command and set the request control bit.

Wait for active control to return.

This statement defines an I/O path with ASCII formatting off. The I/O path points to the chosen error-corrected data file, and can be used to read or write data from the file, since it is in binary rather than ASCII format.

Allocate an array for a 201 point data trace. Real and imaginary pairs will be transferred for each data point.

The computer takes the data from disc and transfers it into the receiving array. By specifying `Disc_dat ( * )`, the ENTER statement will fill every location in the array.

Close the I/O path.

Show the first real imaginary pair.

### Running the program

Perform a measurement calibration with 201 points. Connect a test device and run the program. The first/real imaginary pair will be displayed. Place a marker at the beginning of the trace and look at both real and imaginary formats to verify this point.

## Appendix A: Status Reporting

The HP 8753B has a status reporting mechanism that gives information about specific functions and events inside the HP 8753B. The status byte is an 8 bit register with each bit summarizing the state of one aspect of the instrument. For example, the error queue summary bit will always be set if there are any errors in the queue. The value of the status byte can be read with the `SPOLL(716)` statement. This command does not automatically put the instrument in remote mode, thus giving the operator access to the HP 8753B front panel functions. The status byte can also be read by sending the

command `OUTPSTAT`. Reading the status byte does not affect its value. The sequencing bit can be set by the operator during execution of a test sequence.

The status byte summarizes the error queue, as mentioned before. It also summarizes two event status registers that monitor specific conditions inside the instrument. The status byte also has a bit that is set when the instrument is issuing a service request over HP-IB, and a bit that is set when the HP 8753B has data to send out over HP-IB. See Figure A.1 for a definition of the status registers.

### Example A1: Using the error queue

The error queue holds up to 20 instrument errors and warnings in the order that they occurred. Each time the HP 8753B detects an error condition and displays a message on the CRT, it also puts the error in the error queue. If there are any errors in the queue, bit 3 of the status byte will be set. The errors can

be read from the queue with the `OUTPERRO` command, which causes the HP 8753B to transmit the error number and the error message of the oldest error in the queue.

This example program is stored on the Example Programs disc as `IPGAI`.

```
10 DIM Err$(50)
20 Stat=SPOLL(716)

30 IF NOT BIT(Stat,3) THEN GOTO 20
40 OUTPUT 716;"OUTPERRO;"

50 ENTER 716;Err,Err$
60 PRINT Err,Err$
70 LOCAL 716

80 BEEP 600,.01
90 GOTO 20
100 END
```

Prepare a string to hold the error message.

Use the serial poll statement to read the status byte into the variable `Stat`. Serial poll is an HP-IB function dedicated specifically to getting the status byte of an instrument quickly, and does not cause the HP 8753B to go into remote.

If the error queue summary bit is not set, we loop until it gets set.

If the error queue has something in it, we instruct the HP 8753B to output the error number and the error message. This communication with the HP 8753B will put it in remote mode.

`Err` holds the error number, `Err$` the error message.

Return the HP 8753B to local mode so that the front panel is available to the operator.

Give an audible signal that there is a problem.

## Running the program

Preset the HP 8753B and run the program. Nothing should happen at first. To get something to happen, press a blank softkey. The message "CAUTION: INVALID KEY" will appear on the HP 8753B, the computer will beep and print two lines. The first line will be the invalid key error, and the second message will be the "NO ERRORS" message. Hence, to clean the error queue, you can either loop until the no errors message is received, or until the bit in the status register is cleared. In this case, we wait until the status bit is clear. Note that all through this, the front panel of the HP 8753B is in local mode.

Because the error queue will keep up to 20 errors until either all the errors are read out or the instrument is preset, it is important to clear out the error queue whenever errors are detected so that old errors are not associated with the current instrument state.

Not all messages displayed by the HP 8753B are put in the error queue: operator prompts and cautions are not included.

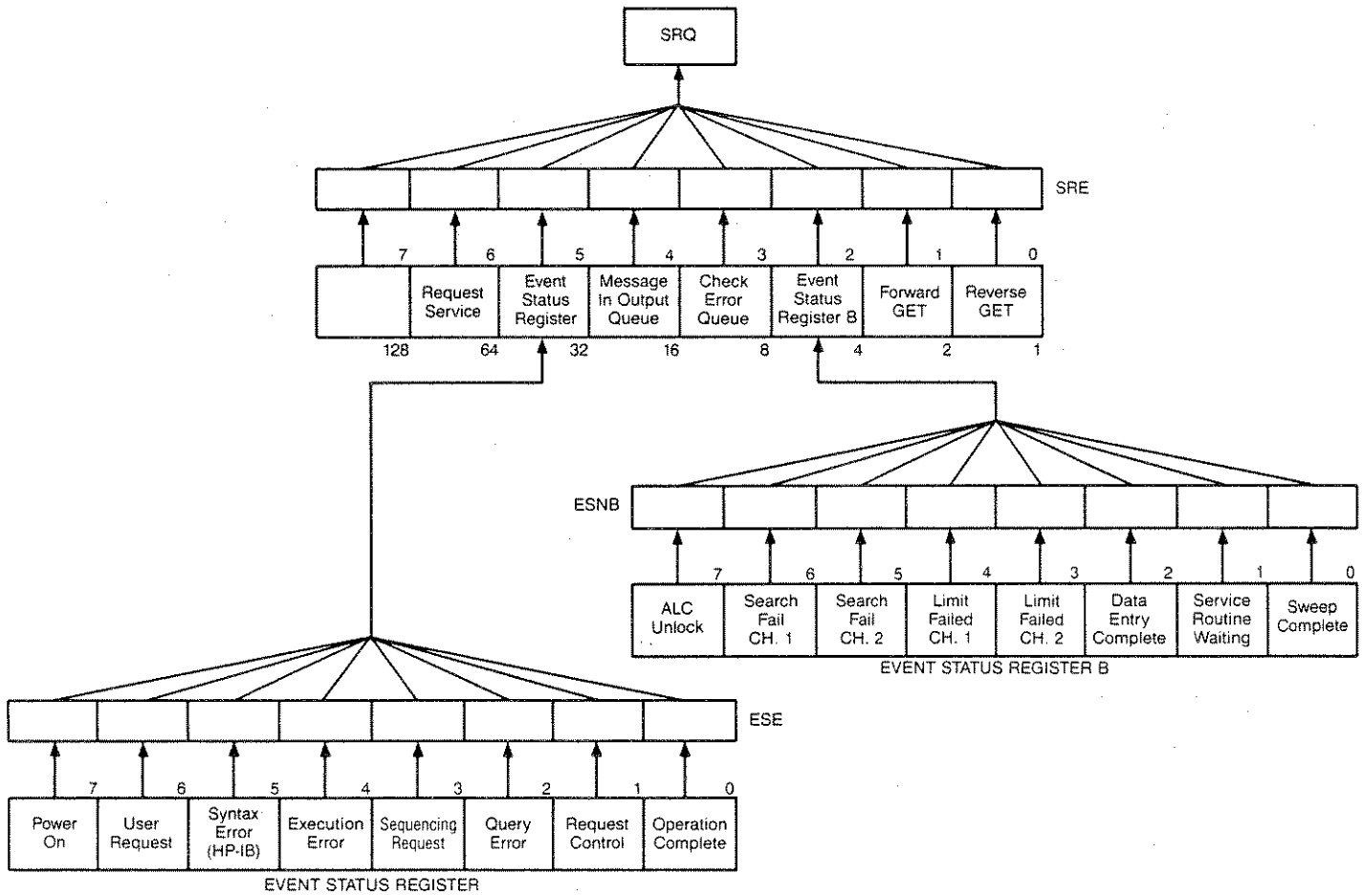

Figure A.1. Status reporting system.



## Example A2: Using the status registers

The other two key components of the status reporting system are the event status register, and event status register B. These 8 bit registers consist of latched event bits. A latched bit is set at the onset of the monitored condition, and is cleared only by a

read of the register or by clearing the status registers with CLES.

This example program is stored on the Example Programs disc as **IPGA2**.

|     |                                               |                                                                                                                                                                                                                                                                             |
|-----|-----------------------------------------------|-----------------------------------------------------------------------------------------------------------------------------------------------------------------------------------------------------------------------------------------------------------------------------|
| 10  | CLEAR 716 .....                               | Clear out any old conditions.                                                                                                                                                                                                                                               |
| 20  | OUTPUT 716;"ESR?;" .....                      | Read out the event status register.                                                                                                                                                                                                                                         |
| 30  | ENTER 716;Estat .....                         |                                                                                                                                                                                                                                                                             |
| 40  | IF NOT BIT(Estat,6) THEN GOTO 20 .....        | If the user request bit of the event status register is not set, loop back.                                                                                                                                                                                                 |
| 50  | OUTPUT 716;"KOR?;" .....                      | If the user request bit has been set, there has been some front panel activity, and we read out the key code. The HP 8753B's reply to KOR?; includes the knob count if the knob was turned. The information comes as a negative number, and has to be decoded.              |
| 60  | ENTER 716;Keyc .....                          |                                                                                                                                                                                                                                                                             |
| 70  | IF Keyc ≥ 0 then PRINT "KEY"; .....           | If the code was positive, we know it was a key press rather than a knob turn, and print the leader KEY. By placing a semicolon after the statement, we suppress the carriage return, line feed, allowing the code to be printed on the same line.                           |
| 80  | IF Keyc < -400 THEN Keyc = Keyc + 32768 ..... | If the keycode is negative, it represents a knob count. If it isn't less than -400, then the count is a clockwise rotation and needs no modification. However, if the count is less than -400, we have to add 32,768 (2 <sup>15</sup> ) to get the counter-clockwise count. |
| 90  | PRINT "CODE =",Keyc .....                     | Print the decoded key code.                                                                                                                                                                                                                                                 |
| 100 | GOTO 20 .....                                 | Wait for the next key press.                                                                                                                                                                                                                                                |
| 110 | END .....                                     |                                                                                                                                                                                                                                                                             |

### Running the program

Run the program. Pressing a key on the HP 8753B causes the computer to display the keycode associated with that key. Note that since the HP 8753B is in remote mode, the normal

function of the key is not executed. In effect, we have taken over the front panel and can now redefine the keys.

## Example A3: Generating interrupts

It is also possible to generate interrupts using the status reporting mechanism. The status byte bits can be enabled to generate a service request (SRQ) when set. The 200/300 series computers can in turn be set up to generate an interrupt on the SRQ.

To be able to generate an SRQ, a bit in the status byte has to be enabled using SRE n. A one in a bit position enables that bit in the status byte. Hence, SRE 8 enables an SRQ on bit 3, check error queue, since 8 equals 00001000 in binary representation. That means that whenever an error is put into the error queue and bit 3 gets set, the SRQ line is asserted, and the (S) indicator on the front panel of the HP 8753B comes on. The only way to clear the SRQ is to disable bit 3, re-enable bit 3, or read out all the errors from the queue.

A bit in the event status register can be enabled so that it is summarized by bit 5 of the status byte. If any enabled bit in the event status register is set, bit 5 of the status byte will also be

set. For example ESE 66 enables bits 1 and 6 of the event status register, since in binary, 66 equals 01000010. Hence, whenever active control is requested or a front panel key is pressed, bit five of the status byte will be set. Similarly, ESNBn enables bits in event status register B so that they will be summarized by bit 2 in the status byte.

To generate an SRQ from an event status register, enable the desired event status register bit. Then enable the status byte to generate an SRQ. For instance, ESE 32 ; SRE 32 ; enables the syntax error bit, so that when the syntax error bit is set, the summary bit in the status byte will be set, and it enables an SRQ on bit 5 of the status byte, the summary bit for the event status register.

The following example program is stored on the Example Programs disc as **IPGA3**.

|                                                                                                                                                                                                                                                                              |                                                                                                                                                                                                                                                                                                                                                                                                                                                                                                                                                                                                                                                                                                                                                                                                                         |
|------------------------------------------------------------------------------------------------------------------------------------------------------------------------------------------------------------------------------------------------------------------------------|-------------------------------------------------------------------------------------------------------------------------------------------------------------------------------------------------------------------------------------------------------------------------------------------------------------------------------------------------------------------------------------------------------------------------------------------------------------------------------------------------------------------------------------------------------------------------------------------------------------------------------------------------------------------------------------------------------------------------------------------------------------------------------------------------------------------------|
| <pre> 10  OUTPUT 716;"CLES;ESE 32;SRE 32;" ..... 20  ON INTR 7 GOTO Err ..... 30  ENABLE INTR 7;2 .....  40  GOTO 40 ..... 50  Err: ! .....  70  OUTPUT 716;"ESR?" .....  80  ENTER 716;Estat 90  PRINT "SYNTAX ERROR DETECTED" 100 ENABLE INTR 7 110 GOTO 30 120 END </pre> | <p>Clear the status reporting system, and then enable bit 5 of the event status register, and bit 5 of the status byte so that an SRQ will be generated on a syntax error.</p> <p>Tell the computer where to branch it gets the interrupt.</p> <p>Tell the 200/300 series to enable an interrupt from interface 7 (HP-IB) when bit 1 (value 2, the SRQ bit) of the interrupt register is set. If there is more than one instrument on the bus capable of generating an SRQ, it is necessary to use serial poll to determine which device has issued the SRQ. In this case, we assume the HP 8753B did it. A branch to <code>Err</code> will disable the interrupt, so the return from <code>Err</code> re-enables it.</p> <p>Do nothing loop.</p> <p>The interrupt has come in! Read the register to clear the bit.</p> |
|------------------------------------------------------------------------------------------------------------------------------------------------------------------------------------------------------------------------------------------------------------------------------|-------------------------------------------------------------------------------------------------------------------------------------------------------------------------------------------------------------------------------------------------------------------------------------------------------------------------------------------------------------------------------------------------------------------------------------------------------------------------------------------------------------------------------------------------------------------------------------------------------------------------------------------------------------------------------------------------------------------------------------------------------------------------------------------------------------------------|

### Running the program

Preset the instrument, and run the program. The computer will do nothing. With the program still running, execute:

```
OUTPUT 716;"STIP 2 GHZ;"
```

The computer will display SYNTAX ERROR DETECTED, and the HP 8753B will display CAUTION: SYNTAX ERROR, and display the incorrect command, pointing at the first character it did not understand.

The SRQ can be cleared by reading the event status register and hence clearing the latched bit, or by clearing the enable registers with `CLES`. The syntax error message on the

HP 8753B display can only be cleared by `CLEAR 7` or `CLEAR 716`. `CLEAR 7` is not commonly used because it clears every device on the bus.

Note that an impossible data condition does not generate a syntax error. For example, execute:

```
CLEAR 716
OUTPUT 716;"STAR 10 HZ;"
```

The HP 8753B simply sets the start frequency to 300 kHz, without generating a syntax error.



For more information  
call your local HP sales office listed  
in the telephone directory white pages.  
Or write to Hewlett-Packard:

**United States:**

Hewlett-Packard  
P.O. Box 10301  
Palo Alto, CA 94303-0890

**Europe:**

Hewlett-Packard  
P.O. Box 999  
1180 AZ Amstelveen, the Netherlands

**Canada:**

Hewlett-Packard Ltd.  
6877 Goreway Drive  
Mississauga, Ontario L4V 1M8

**Japan:**

Yokogawa-Hewlett-Packard Ltd.  
3-29-21, Takaido-Higashi  
Suginami-ku, Tokyo 168

**Elsewhere in the World:**

Hewlett-Packard Intercontinental  
3495 Deer Creek Road  
Palo Alto, Ca 94304



May 1, 1988  
Printed in U.S.A.  
08753-90117

# HP-IB Programming Note

## Quick Reference Guide

### For the HP 8753B Network Analyzer



## Introduction

This document is a guide to HP-IB control of the HP 8753B Network Analyzer. Its purpose is to provide concise information about the operation of the instrument under HP-IB control: the reader should already be familiar with making measurements with the HP 8753B and with the general operation of HP-IB. For more complete

information on the HP 8753B, see the Introductory Operating Guide and the Operating and Programming Reference section in the HP 8753B operating manual. For more information on using HP-IB, see the Tutorial Description of the Hewlett-Packard Interface Bus (HP literature number 5952-0156.)

## Table of contents:

|                                                                                                               |   |
|---------------------------------------------------------------------------------------------------------------|---|
| HP-IB Capabilities .....                                                                                      | 2 |
| General Information .....                                                                                     | 2 |
| HP-IB addresses, Held commands, Operation complete, Identification, Command interrogate, Output queue, Units. |   |
| Input Data .....                                                                                              | 3 |
| Input syntax, Valid characters, Programming data, Array transfer, CRT graphics, Instrument preset.            |   |
| Output .....                                                                                                  | 5 |
| Output syntax, Data formats, Data arrays, Learn string and cal kit string.                                    |   |
| Error Reporting .....                                                                                         | 6 |
| Status reporting, Error output.                                                                               |   |
| HP-IB Information .....                                                                                       | 6 |
| Modes, Response to HP-IB commands.                                                                            |   |

## Appendices:

|                                   |    |
|-----------------------------------|----|
| A Key Select Codes .....          | 8  |
| B HP-IB Only Codes .....          | 17 |
| C Calibration .....               | 20 |
| D Display Graphics .....          | 22 |
| E Useful Tables and Figures ..... | 24 |
| F Status Reporting .....          | 27 |
| G Alphabetical Code Listing ..... | 29 |

---

## HP-IB Capabilities

The HP-IB capabilities of the HP 8753B are as follows:

|     |                                                                        |
|-----|------------------------------------------------------------------------|
| SH1 | Full source handshake capability.                                      |
| AH1 | Full acceptor handshake capability.                                    |
| T6  | Can be a basic talker, answers serial poll, unaddresses if MLA issued. |
| TE0 | No extended talker capabilities.                                       |
| L4  | Acts as a basic listener and unaddresses if MTA issued.                |
| LE0 | No extended listener capabilities.                                     |
| SR1 | Can issue service requests.                                            |
| RL1 | Will do remote, local, and local lockout.                              |
| PP0 | No parallel poll capability.                                           |
| DC1 | Device clear capability.                                               |
| DT1 | Will respond to device trigger in hold mode.                           |
| CO  | No controller capabilities in talker/listener mode.                    |
| C1  | System controller mode.                                                |
| C10 | Pass control capability in pass control mode.                          |
| E2  | Tri-state drivers.                                                     |

These codes are completely explained in the IEEE Std 488-1978 document, published by the Institute of Electrical and Electronic Engineers, Inc., 345 East 47th Street, New York, New York 11017.

## General Information

The HP 8753B interprets and executes commands as they are received. If a command is received without a needed operand, the HP 8753B will put the function in the active entry area and wait for the operand. An operand is entered as the value when the units or a terminator is received. The active entry area is turned off when a terminator is received. In the event of a syntax error, the HP 8753B displays the error, then recovers at the next terminator and continues command execution. Characters and commands between the syntax error and the next terminator are lost. The error can only be reset with a device clear (DCL or SDC) or by presetting the instrument.

## HP-IB Addresses

*The HP 8753B occupies two HP-IB addresses: the instrument itself and the display. The display address is derived from the instrument address by complementing the least significant bit. Hence, if the instrument is at an even address, the display occupies the next higher address. If the instrument is at an odd address, the display occupies the next lower address. Changes of the HP 8753B's address do not become effective until after the next preset following the address change.*

## Held Commands

The HP 8753B cannot process HP-IB commands while executing certain key commands, called held commands. Once a held command is received, the HP 8753B will read new commands into the input buffer, but it will not begin the execution of any commands until the completion of the held command. When the 15 character input buffer is full, the HP 8753B will hold off the bus until it is able to process the commands in the buffer.

## Operation Complete

There is an operation complete function that allows synchronization of programs with the execution of certain held commands. The function is enabled by issuing **OPC;** or **OPC?;** prior to an OPC'able command. The operation complete bit will then be set at the completion of the OPC'able command's execution. For example, issuing **OPC;SING;** causes the OPC bit to be set when the single sweep is finished. Issuing **OPC?;** causes the HP 8753B to output a one when the command execution is complete. Addressing the HP 8753B to talk after issuing **OPC?;** will not cause an "addressed to talk without selecting output" error, but the HP 8753B will halt the computer by not transmitting the one until the command has completed. For example, issuing **OPC?;PRES;**, and then immediately interrogating the HP 8753B causes the bus to halt until the instrument preset is complete and the HP 8753B outputs a one.

Table 1: OPC'able Commands

|                  |              |
|------------------|--------------|
| CHAN1            | MANTRIG      |
| CHAN2            | NOOP         |
| CLEARALL         | NUMG         |
| DATI             | PRES         |
| DONE             | RAID         |
| EDITDONE         | RECA<1 to 5> |
| EXTTOFF          | REFD         |
| EXTTON           | RESPDONE     |
| EXTTPOIN         | RST          |
| FREQOFFS<ON OFF> | SAV1         |
| HARMOFF          | SAV2         |
| HARMSEC          | SAVC         |
| HARMTHIR         | SAVE<1 to 5> |
| INSMEXSA         | SING         |
| INSMEXSM         | STAN<A to G> |
| INSMNETA         | TRAD         |
| INSMTUNR         | WAIT         |
| ISOD             |              |

NOTE: Commands that call a calibration class are held if there is just one standard in the class, since such commands trigger a measurement.

## Command Interrogate

To interrogate one of the front panel equivalent commands listed in Appendix A, Key Select Codes, append a question mark to the command root. This causes the HP 8753B to output the state of that function as a single number in ASCII format. If the function is a settable function, such as power or sweep time, the HP 8753B will output the current value of that function. If the function is either on/off (e.g. averaging) or one selection of several (e.g. log mag display format), the HP 8753B outputs a one for on or selected, and a zero for off. If a command that does not have a defined response is interrogated, the HP 8753B

outputs a zero. Interrogating a function does not put it in the active entry area.

## Identification

The HP 8753B's response to **IDN?;** is "HEWLETT PACKARD,8753B,0,X.XX" where X.XX is the firmware revision of the instrument.

## Output Queue

Whenever a command to output data is received, the HP 8753B puts the data into the output queue to be copied out by the next read operation. The queue, however, is only one event long; the next command to output data will overwrite the data already in the queue. Hence, it is important to read the output queue immediately after every interrogation or request to output data.

## Units

The HP 8753B outputs data in basic units such as Hz, dB, seconds, ohms, etc.

Input data is assumed to be in basic units unless one of the following units expressions qualifies the data input (upper and lower case are equivalent):

|           |              |            |           |           |           |
|-----------|--------------|------------|-----------|-----------|-----------|
| <b>S</b>  | Seconds      | <b>HZ</b>  | Hertz     | <b>DB</b> | dB or DBm |
| <b>MS</b> | Milliseconds | <b>KHZ</b> | Kilohertz |           |           |
| <b>US</b> | Microseconds | <b>MHZ</b> | Megahertz | <b>V</b>  | Volts     |
| <b>NS</b> | Nanoseconds  | <b>GHZ</b> | Gigahertz |           |           |
| <b>PS</b> | Picoseconds  |            |           |           |           |
| <b>FS</b> | Femtoseconds |            |           |           |           |

## Input Data

### Input Syntax

The HP-IB commands accepted by the HP 8753B can be grouped into four input syntax types. The HP 8753B does not distinguish between upper and lower case letters.

### General Structure:

[code][appendage][data][unit][terminator]

[code]

The root mnemonic, as found in the appendices.

[appendage]

A qualifier attached to the root mnemonic. Possible appendages are **ON** or **OFF**, which toggle a function on or off, or integers, which specify one option out of several. There can be no spaces or symbols between the code and the appendage.

[data]

A single operand used by the root mnemonic, usually to set the value of a function. The data can be a number or a character string. Numbers are accepted as integers or decimals, with power of ten specified by **E**, as in **STAR 0.2E+10**, which sets the start frequency to 2 GHz. Character strings must be preceded and followed by double quotation marks (e.g. "**DEVICE LABEL**") must be sent to the HP 8753B, not **DEVICE LABEL.**)

[unit]

The units of the operand, if applicable. If no units are specified, the HP 8753B assumes the basic units as

described under General Information. The data is entered into the function when either units or a terminator is received.

[terminator]

Indicates the end of the command, enters the data, and turns off the active entry area. The terminator should be a semicolon. Terminators are not necessary for the HP 8753B to interpret commands correctly, but in the case of a syntax error, the HP 8753B will attempt to recover at the next terminator. The HP 8753B also interprets line feeds and HP-IB END OR IDENTIFY (EOI) messages as terminators.

The specific syntaxes are as follows:

SYNTAX TYPE 1: [code][terminator]

These are simple action commands that require no complementary information, such as **AUTO** (autoscales the active channel.)

SYNTAX TYPE 2: [code][appendage][terminator]

These are simple action commands requiring limited customization, such as **CORRON**, **CORROFF** (turn error correction on or off,) or **RECA1**, **RECA2**, **RECA3** . . . (recall register 1,2,3 . . .) There can be no characters or symbols between the code and the appendage.

SYNTAX TYPE 3: [code][data][unit][terminator]

These are data input commands such as **STAR 1.0 GHZ**; (set the start frequency to 1 GHz).

SYNTAX TYPE 4: [code][appendage][data][terminator]

These are titling and marker commands that have an appendage, such as **TITL "FILTER"** (enter **FILTER** as the CRT title), **TITR1 "STATE1"**, **TITR2 "EMPTY"** (title register 1 **STATE1**, title register 2 **EMPTY**.)

INTERROGATE SYNTAX: [code][?]

To interrogate a front panel equivalent function, simply append a question mark to the root mnemonic. For example **POWE?**, **AVERO?**, or **REAL?** will return, respectively, the power level in dB, a one if averaging is on, and a one if the current display format is real. Interrogating a function does not put it in the active entry area. To interrogate commands with integer appendages, place the question mark after the appendage.

### Valid Characters

The HP 8753B will accept letters, changing lower case to upper case, numbers, decimal points,  $\pm$ , semicolons, carriage returns and linefeeds. Leading zeros, spaces, carriage returns, and unnecessary terminators are ignored, except when inserted into or between a mnemonic and/or an appendage. If the HP 8753B does not recognize a character as appropriate, it generates a syntax error message and recovers at the next terminator (see General Information.)

## Programming Data

The command mnemonics are presented in the appendices. Appendix A, Key Select Codes, represents front panel equivalent commands. These commands perform the same function as a front panel key, and are arranged functionally by front panel key. Appendix B, HP-IB Only Codes, represents functions that have no logical equivalent in manual operation. They concern data transmission, status reporting, and special HP-IB functions. Appendix G, Alphabetical Command List, contains all the mnemonics from the Appendices A and B, plus some redundant mnemonics included for compatibility with standards and other instruments.

In general, the commands were named following these rules:

1. Simple commands are the first four letters of the function they control, as in **POWE**. If the function label is two words, the first three mnemonic letters are the first three letters of the first word, and the fourth mnemonic letter is the first letter of the second word. For example, **ELED** is derived from electrical delay.

2. If there are many commands grouped together in a class, as in markers or plotting pen numbers, the command is increased to 8 letters. The first 4 letters are the class label derived using rule 1. The last 4 letters are the function specifier, again derived using rule 1. An example of this is the class pen numbers **PENN**, which is used with several functions such as **PENNDATA**, **PENNMEMO**.

These rules were not always followed, in order to maintain compatibility with other products, to make commands more meaningful and easier to remember, and when technical considerations prevented their use.

### Array Transfer

There are several arrays of information that can be read out of the HP 8753B, such as trace data, calibration data, and learn string. These arrays can be transmitted back to the HP 8753B, where the incoming data becomes the array for the current instrument state. The instrument must be properly configured to receive the array. For instance, the instrument will not accept a 401 point data array if the current instrument state is 201 points.

Arrays need not be transmitted back to the instrument in the same format in which they were read out: the only requirement is that the HP 8753B be set to receive the format the computer is transmitting. Refer to Data Formats.

Note: the correct header must precede forms 1, 2, and 3. The header is described in Data Formats.

### CRT Graphics

The CRT is accessed as if it were a graphics plotter, responding to a limited set of HP-GL commands outlined



in Appendix D, Display Graphics. The CRT has its own HP-IB address, and is independent of the rest of the HP 8753B. To calculate the CRT address, take the HP 8753B's address, and complement the least significant bit. If the HP 8753B has an odd address, the CRT is the next lower address. If the HP 8753B has an even address, the CRT is the next higher address. For example, with an HP 8753B address of 16, the CRT is 17. With an address of 15, the CRT is 14.

### Instrument Preset

The **PRES** command causes the HP 8753B to execute an instrument preset, which returns the HP 8753B to instrument preset state. During an instrument preset, a device clear is executed, the status registers are cleared, the error queue is cleared, and the HP-IB hardware is reset.

## Output

### Output Syntax

Data transmitted by the HP 8753B in response to an interrogation, certain output commands, and form 4 array transfers is in ASCII format. This means that each character and each digit is transmitted as a separate byte, leaving the receiving computer to reconstruct the numbers and strings. Numbers are transmitted as 24 character strings, consisting of:

-DDD.DDDDDDDDDDDDDDDDE-DD

| CONTENTS      | MEANING                                   |
|---------------|-------------------------------------------|
| Sign          | '-' for negative, blank for positive.     |
| 3 digits      | Digits to the left of the decimal point.  |
| Decimal point |                                           |
| 15 digits     | Digits to the right of the decimal point. |
| E             | Exponent notation.                        |
| Sign          | '-' for negative, '+' for positive.       |
| Exponent      | Two digits for the exponent.              |

### Data Formats

The HP 8753B transmits and receives arrays in any of four different numeric formats. The current format is set with the **FORM1**, **FORM2**, **FORM3**, and **FORM4** commands. These commands do not affect learn string, cal kit string, or non-array transfers such as command interrogate or output marker values. A transmitted array will go out in the current format, and the HP 8753B will attempt to read incoming arrays according to the current format. Each data point in an array is a pair of numbers, normally a real/imaginary pair. The number of data points in each array is the same as the number of points in the current sweep. The formats are as follows:

**FORM 1** HP 8753B internal binary format, 6 bytes per data point. The array is preceded by a four byte header. The first two bytes represent the string

"#A", the standard block header. The second two bytes are an integer holding the number of bytes in the block to follow. Form 1 is meant for rapid data transfers, not to be modified by the computer.

**FORM 2** IEEE 32 bit floating point format, 8 bytes per data point. The data is preceded by the same header as in form 1. Each number consists of a 1 bit sign, an 8 bit biased exponent, and a 23 bit mantissa.

**FORM 3** IEEE 64 bit floating point format, 16 bytes per data point. The data is preceded by the same header as in form 1. Each number consists of a 1 bit sign, an 11 bit biased exponent, and a 52 bit mantissa.

**FORM 4** ASCII floating point format. The data is transmitted as ASCII numbers, as described in Output Syntax. There is no header.

The HP 8753B terminates each transmission by asserting the EOI interface line with the last byte transmitted.

### Data Arrays

Figure E.1, Data Processing Chain, shows the different kinds of data available within the instrument: raw measured data, error corrected data, formatted data, trace memory, and calibration coefficients. Trace memory can be directly read out with **OUTPMEMO**, but it cannot be directly transmitted back. If time domain (option 10) is on with 1601 points, the formatted data array will only have 401 points.

### Learn String and Cal Kit String

The learn string is summary of the instrument state. It includes all the front panel settings, the limit test tables, and the list frequency table for the current instrument state. It does not include calibration data, nor does it include the information stored in the save/recall registers.

The learn string is read out with **OUTPLEAS**, which causes the HP 8753B to start transmitting the binary string. The string has a fixed length for a given firmware revision, and is no more than 3000 bytes long. The array has the same header as in form 1.

The calibration kit is a set of key characteristics of the calibration standards used to increase the accuracy improvement associated with calibration. There are default kits for several different connector types, and there is space for a user-defined cal kit. The command **OUTPCALK** outputs the currently active cal kit as a binary string in form 1. As with the learn string, the cal kit string has a fixed length for a given firmware revision, and is no more than 1000 bytes long.

## Error Reporting

### Status Reporting

The HP 8753B status reporting structure depicted in Appendix F consists of three registers:

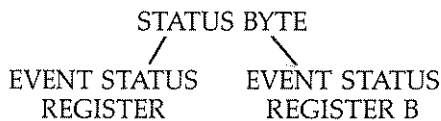

The top level register is the status byte, which consists of summary bits. Each bit reflects the condition of another register or a queue. If a summary bit is set (equals 1), the corresponding register or queue should be read to obtain the status information and to clear the condition. Reading the status byte, which can be done with a serial poll or by issuing **OUTPSTAT**, does not affect the state of the summary bits: they always reflect the condition of the summarized queue or register.

Any bit in the status byte can be selectively enabled to generate a service request (SRQ) when set. Setting a bit in the service request enable register with **SREnn** enables the corresponding bit in the status byte. For example, **SRE24** enables status byte bits 3 and 4 (since  $2^3 + 2^4 = 24$ ) and disables all the other bits. **SRE** will not affect the state of the status register bits.

The event status register and event status register B are the other two registers in the status reporting structure. They are selectively summarized by bits in the status byte via enable registers. The event status registers consist of latched bits. A latched bit is set at the onset of a specific trigger condition in the instrument, and is cleared only by a read of the register. The bit will not be set again until the condition occurs again. If a bit in one of these two registers is enabled, it is summarized by the summary bit in the status byte. The registers are enabled by **ESEnn** and **ESNBnn**, which work the same as **SREnn**.

If a bit in one of the event status registers is enabled and the summary bit in the status byte is enabled, an SRQ will be generated when the event status register bit is set. The SRQ will not be cleared until one of four things happens:

1. The event status register is read, clearing the latched bit.
2. The summary bit in the status byte is disabled.
3. The event status register bit is disabled.

or

4. The status registers are cleared with **CLES** or a preset.

SRQ's generated when there are error messages or when the instrument is waiting for Group Execute Trigger (GET) are cleared by reading the errors or issuing GET, disabling the bits, or by clearing the status registers.

The status byte also summarizes two queues, the output queue and the error queue. When the HP 8753B outputs information, it puts it in the output queue, where it resides until the controller reads it. The output queue is only one event long, so that the next output request will clear the current data. The summary bit is set whenever there is something in the output queue. The error queue is described in the next section.

See Appendix F for the definition of each of the registers.

### Error Output

When an error condition is detected in the HP 8753B, a message is displayed on the screen, and that message is placed in the error queue. The error queue holds up to 20 errors in the order they occur until the errors are read out using the **OUTPERRO** command. The **OUTPERRO** command outputs one error message, which consists of an error number followed by an ASCII string which is no more than 50 characters long. The string is the same message that appears on the display.

The error queue is not cleared by any event except a preset or cycling the line switch. In order to keep the queue up-to-date, it is important to read all of the messages out of the queue each time errors are detected.

## HP-IB Information

### Modes

Under HP-IB control, the HP 8753B can operate in one of two modes: talker/ listener and pass control.

In talker/listener mode, the HP 8753B behaves as a simple element on the bus. It is possible to have the HP 8753B make a plot or print in talker/listener mode, using the **OUTPLOT** or **OUTPPRIN** commands. Unlike **PLOT** and **PRINALL**, which require that control be passed, the HP 8753B will wait to be addressed to talk, assume the plotter or printer has been addressed to listen, and dump the display. It is not possible to have the HP 8753B access a disc drive when it is in talker/listener mode.

In pass control mode, the HP 8753B will take control of the bus if control is passed to it. This allows the HP 8753B to take control of printers, plotters, and disc drives on an as-needed basis. The HP 8753B sets event status register bit 1 when it needs control, and the HP 8753B will transfer control back at the completion of the operation. It passes control back to its controller address, specified by **ADDRCONT**.

The HP 8753B can also operate in the system controller mode. This mode is meant for use only when there is no computer on the bus. In this mode, the HP 8753B simply takes control of the bus, and uses it whenever it needs to access a peripheral. While the HP 8753B is in this mode, no other devices on the bus can attempt to take control. Specifically, the REN, ATN, and IFC lines must remain unasserted, and the data lines must be freed by all but the addressed talker.

## Response to HP-IB Commands

### Abort

The HP 8753B responds to the abort message (IFC) by halting all listener, talker, and controller functions.

### Device Clear

The HP 8753B responds to the device clear commands (DCL, SDC) by clearing the input and output queues and clearing any HP-IB errors. The status registers and the error queue are unaffected.

### Local

The HP 8753B will go into local mode if the local command (GTL) is received, the remote line is unasserted, or the front panel local key is pressed. Only unasserting the remote line will clear a local lockout condition, although GTL will place the instrument temporarily in local mode. Changes from remote to local do not affect any of the front panel functions or values.

### Local Lockout

If the HP 8753B is in remote mode, and it receives the local lockout command (LLO), it will disable the entire front panel except the line power switch.

### Parallel Poll

The HP 8753B does not respond to parallel poll configure (PPC) or parallel poll unconfigure (PPU) messages.

### Pass Control

If the HP 8753B is in pass control mode, is addressed to talk, and receives the take control command (TCT), it will take active control of the bus. If the HP 8753B was not requesting control, it immediately passes control to its

controller address. Otherwise, the HP 8753B will execute the function it needed control of the bus for, and then pass control back.

### Remote

The HP 8753B will go into remote mode, disabling all keys but **[LOCAL]**, when the remote line is asserted and it is addressed to listen. Changes from remote to local do not affect any front panel settings or functions.

### Serial Poll

The HP 8753B will respond to a serial poll with its status byte, as defined in Appendix F, Status Reporting. To initiate the serial poll sequence, address the HP 8753B to talk and issue a serial poll enable (SPE), at which time the HP 8753B puts out its status byte. End the sequence by issuing a serial poll disable (SPD.) A serial poll does not affect the value of the status byte, and it does not put the instrument into remote.

### Trigger

If in hold mode, the HP 8753B responds to device trigger by taking a single sweep. If a one path, 2-port calibration is active, the HP 8753B will set the waiting for GET bits in the status byte. If waiting for forward GET is set, the HP 8753B will assume the device is connected for forward measurement and take a sweep when GET is received. Similarly, if waiting for reverse GET is set, the HP 8753B will assume the device is connected for reverse measurement. The HP 8753B responds only to selected device trigger (SDT,) which means that it will not respond to group execute trigger (GET) unless it is addressed to listen. The HP 8753B will not respond to GET if it is not in hold mode.

## Appendix A: Key Select Codes for the HP 8753B

This appendix is a functionally arranged table of HP-IB mnemonics that have a direct front panel key equivalent. The functions are arranged alphabetically by front panel hard key.

|                                   |    |
|-----------------------------------|----|
| <b>Keys:</b>                      |    |
| AVG .....                         | 8  |
| CAL-Error correction .....        | 8  |
| CAL-Calibration kits .....        | 9  |
| CAL-Power meter calibration ..... | 11 |
| CHANNEL .....                     | 11 |
| COPY .....                        | 11 |
| DISPLAY .....                     | 12 |
| ENTRY .....                       | 12 |
| FORMAT .....                      | 13 |
| LOCAL .....                       | 13 |
| MEAS .....                        | 13 |
| MENU .....                        | 14 |
| MKR .....                         | 15 |
| MKR FCTN .....                    | 15 |
| SAVE/RECALL .....                 | 15 |
| SCALE REF .....                   | 16 |
| STIMULUS .....                    | 16 |
| SYSTEM .....                      | 16 |
| SYSTEM-Sequencing .....           | 17 |
| SYSTEM-Limit testing .....        | 18 |
| SYSTEM-Transform .....            | 18 |

|                         |                                                               |
|-------------------------|---------------------------------------------------------------|
| <b>Column headings:</b> |                                                               |
| FUNCTION                | The front panel function affected by the mnemonic.            |
| ACTION                  | The effects of the mnemonic on that function.                 |
| MNEMONIC                | The mnemonic.                                                 |
| S                       | Syntax type. See Input Syntax.                                |
| ?                       | Interrogate response. If a response is defined, it is listed. |
| O                       | OPC'able command.                                             |
| RANGE                   | The range of acceptable inputs and corresponding units.       |

|                                |                                                               |
|--------------------------------|---------------------------------------------------------------|
| <b>Symbol conventions are:</b> |                                                               |
| []                             | An optional operand.                                          |
| D                              | A numerical operand.                                          |
| \$                             | A character string operand, which must be enclosed by quotes. |
| <>                             | A necessary appendage.                                        |
|                                | An either/or choice in appendages.                            |

| Function                                 | Action        | Mnemonic                   | S | ?   | O | Range                             |
|------------------------------------------|---------------|----------------------------|---|-----|---|-----------------------------------|
| <b>AVG</b>                               |               |                            |   |     |   |                                   |
| Averaging                                | Restart       | <b>AVERREST</b>            | 1 |     |   |                                   |
|                                          | Factor        | <b>AVERFACT[D]</b>         | 3 | D   |   | 0 to 999                          |
|                                          | On/off        | <b>AVERO&lt;ON OFF&gt;</b> | 2 | 1,0 |   |                                   |
| Smoothing                                | Set aperture  | <b>SMOOAPER[D]</b>         | 3 | D   |   | 0.05 to 20 percent                |
|                                          | Activate      | <b>SMOOO&lt;ON OFF&gt;</b> | 2 | 1,0 |   |                                   |
| IF bandwidth                             | Set bandwidth | <b>IFBW[D]</b>             | 3 | D   |   | D=10, 30, 100, 300, 1000, 3000 Hz |
| <b>CAL-error correction, calibration</b> |               |                            |   |     |   |                                   |
| Correction                               | On/off        | <b>CORR&lt;ON OFF&gt;</b>  | 2 | 1,0 |   |                                   |
| Interpolative correction                 | On/off        | <b>CORI&lt;ON OFF&gt;</b>  | 2 | 1,0 |   |                                   |
| Cal sequence                             | Resume        | <b>RESC</b>                | 1 |     |   |                                   |
| Port extensions                          | Port 1        | <b>PORT1[D]</b>            | 3 | D   |   | ± 10 s                            |
|                                          | Port 2        | <b>PORT2[D]</b>            | 3 | D   |   | ± 10 s                            |
|                                          | Input A       | <b>PORTA[D]</b>            | 3 | D   |   | ± 10 s                            |
|                                          | Input B       | <b>PORTB[D]</b>            | 3 | D   |   | ± 10 s                            |
|                                          | Off           | <b>PORE&lt;ON OFF&gt;</b>  | 2 | 1,0 |   |                                   |
| Velocity factor                          | Set value     | <b>VELOFACT[D]</b>         | 3 | D   |   | 0 to 10                           |

| Function                                 | Action            | Mnemonic        | S | ?   | O          | Range         |
|------------------------------------------|-------------------|-----------------|---|-----|------------|---------------|
| Z0                                       | Set Value         | <b>SETZ[D]</b>  | 3 | D   |            | .1 to 500 ohm |
| Begin cal<br>sequence                    | Response          | <b>CALIRESP</b> | 1 | 0,1 |            |               |
|                                          | Response and Isol | <b>CALIRAI</b>  | 1 | 0,1 |            |               |
|                                          | S11 1-port        | <b>CALIS111</b> | 1 | 0,1 |            |               |
|                                          | S22 1-port        | <b>CALIS221</b> | 1 | 0,1 |            |               |
|                                          | Full 2-port       | <b>CALIFUL2</b> | 1 | 0,1 |            |               |
|                                          | One path 2-port   | <b>CALIONE2</b> | 1 | 0,1 |            |               |
| Intermediate<br>cal steps,<br>2-port cal | Transmission      | <b>TRAN</b>     | 1 |     |            |               |
|                                          | Reflection        | <b>REFL</b>     | 1 |     |            |               |
|                                          | Isolation         | <b>ISOL</b>     | 1 |     |            |               |
| Select<br>response &<br>isol class       | Response          | <b>RAIRESP</b>  | 1 |     |            |               |
|                                          | Isolation         | <b>RAISOL</b>   | 1 |     |            |               |
| Select<br>reflection<br>class            | S11A (open)       | <b>CLASS11A</b> | 1 |     | See Note 1 |               |
|                                          | S11B (short)      | <b>CLASS11B</b> | 1 |     | "          |               |
|                                          | S11C (load)       | <b>CLASS11C</b> | 1 |     | "          |               |
|                                          | S22A (open)       | <b>CLASS22A</b> | 1 |     | "          |               |
|                                          | S22B (short)      | <b>CLASS22B</b> | 1 |     | "          |               |
|                                          | S22C (load)       | <b>CLASS22C</b> | 1 |     | "          |               |
| Select<br>transmission<br>class          | Fwd transmission  | <b>FWDT</b>     | 1 |     | "          |               |
|                                          | Rev transmission  | <b>REVT</b>     | 1 |     | "          |               |
|                                          | Fwd match         | <b>FWDM</b>     | 1 |     | "          |               |
|                                          | Rev match         | <b>REVM</b>     | 1 |     | "          |               |
| Select<br>isolation<br>class             | Forward isol.     | <b>FWDI</b>     | 1 |     | "          |               |
|                                          | Reverse isolation | <b>REVI</b>     | 1 |     | "          |               |
|                                          | Omit isolation    | <b>OMII</b>     | 1 |     | "          |               |
| Select<br>standard in<br>class           | Standard A        | <b>STANA</b>    | 1 |     | OPC        |               |
|                                          | B                 | <b>STANB</b>    | 1 |     | OPC        |               |
|                                          | C                 | <b>STANC</b>    | 1 |     | OPC        |               |
|                                          | D                 | <b>STAND</b>    | 1 |     | OPC        |               |
|                                          | E                 | <b>STANE</b>    | 1 |     | OPC        |               |
|                                          | F                 | <b>STANF</b>    | 1 |     | OPC        |               |
|                                          | G                 | <b>STANG</b>    | 1 |     | OPC        |               |
| Sliding<br>load                          | Set               | <b>SLIS</b>     | 1 |     |            |               |
|                                          | Done              | <b>SLID</b>     | 1 |     |            |               |
| Done with:                               | Class             | <b>DONE</b>     | 1 |     | OPC        |               |
|                                          | Isolation         | <b>ISOD</b>     | 1 |     | OPC        |               |
|                                          | Reflection        | <b>REFD</b>     | 1 |     | OPC        |               |
|                                          | Transmission      | <b>TRAD</b>     | 1 |     | OPC        |               |
| Save<br>cal                              | Response          | <b>RESPDONE</b> | 1 |     | OPC        |               |
|                                          | Resp and isol     | <b>RAID</b>     | 1 |     | OPC        |               |
|                                          | 1-port cal        | <b>SAV1</b>     | 1 |     | OPC        |               |
|                                          | 2-port cal        | <b>SAV2</b>     | 1 |     | OPC        |               |
| <b>CAL-calibration kits</b>              |                   |                 |   |     |            |               |
| Select<br>default<br>kits                | 7 mm              | <b>CALK7MM</b>  | 1 | 1,0 |            |               |
|                                          | 3.5 mm            | <b>CALK35MM</b> | 1 | 1,0 |            |               |
|                                          | Type N, 50 ohm    | <b>CALKN50</b>  | 1 | 1,0 |            |               |
|                                          | Type N, 75 ohm    | <b>CALKN75</b>  | 1 | 1,0 |            |               |
|                                          | User defined      | <b>CALKUSED</b> | 1 | 1,0 |            |               |
| Modify kit                               | Modify current    | <b>MODI1</b>    | 1 |     |            |               |

| Function                                          | Action             | Mnemonic                 | S               | ?   | O | Range                            |
|---------------------------------------------------|--------------------|--------------------------|-----------------|-----|---|----------------------------------|
| Define std.<br>number (begin standard definition) |                    | <b>DEFS[D]</b>           | 3               |     |   |                                  |
| Define<br>standard<br>type                        | Open               | <b>STDTOPEN</b>          | 1               | 1,0 |   |                                  |
|                                                   | Short              | <b>STDTSHOR</b>          | 1               | 1,0 |   |                                  |
|                                                   | Load               | <b>STDTLOAD</b>          | 1               | 1,0 |   |                                  |
|                                                   | Delay/thru         | <b>STDTDELA</b>          | 1               | 1,0 |   |                                  |
|                                                   | Arbitrary impeded. | <b>STDTARBI</b>          | 1               | 1,0 |   |                                  |
| Define<br>standard<br>parameters                  | Open cap. C0       | <b>C0[D]</b>             | 3               |     |   | $\pm 10e-12$ F                   |
|                                                   | Open cap. C1       | <b>C1[D]</b>             | 3               |     |   | $\pm 10e-12$ F/Hz                |
|                                                   | Open cap. C2       | <b>C2[D]</b>             | 3               |     |   | $\pm 10e-12$ F/Hz <sup>2</sup>   |
|                                                   | Open cap. C3       | <b>C3[D]</b>             | 3               |     |   | $\pm 10e-12$ F/Hz <sup>3</sup>   |
|                                                   | Fixed load         | <b>FIXE</b>              | 1               |     |   |                                  |
|                                                   | Sliding load       | <b>SLIL</b>              | 1               |     |   |                                  |
|                                                   | Terminal impeded.  | <b>TERI[D]</b>           | 3               |     |   | 0 to 1 kohm                      |
| Define<br>standard<br>offsets                     | Delay              | <b>OFS[D]</b>            | 3               |     |   | $\pm 1$ s                        |
|                                                   | Loss               | <b>OFSL[D]</b>           | 3               |     |   | 0 to 1000 Tohm/s                 |
|                                                   | Z0                 | <b>OFSZ[D]</b>           | 3               |     |   | .1 to 500 ohm                    |
|                                                   | Min. frequency     | <b>MINF[D]</b>           | 3               |     |   | 0 to 1000 GHz                    |
|                                                   | Max frequency      | <b>MAXF[D]</b>           | 3               |     |   | 0 to 1000 GHz                    |
|                                                   | Coaxial            | <b>COAX</b>              | 1               | 0,1 |   |                                  |
|                                                   | Waveguide          | <b>WAVE</b>              | 1               | 0,1 |   |                                  |
|                                                   | Std done           | standard defined         | <b>STDD</b>     | 1   |   |                                  |
| Label std                                         |                    | <b>LABS[\$]</b>          | 3               |     |   | 10 char.                         |
| Specify<br>class                                  | Response           | <b>SPECRESP[I,I,...]</b> | 3               |     |   | I=std numbers<br>(all same form) |
|                                                   | Resp & Isol        | <b>SPECRESI</b>          |                 |     |   |                                  |
|                                                   | S11A (open)        | <b>SPECS11A</b>          |                 |     |   |                                  |
|                                                   | S11B (short)       | <b>SPECS11B</b>          |                 |     |   |                                  |
|                                                   | S11C (load)        | <b>SPECS11C</b>          |                 |     |   |                                  |
|                                                   | S22A (open)        | <b>SPECS22A</b>          |                 |     |   |                                  |
|                                                   | S22B (short)       | <b>SPECS22B</b>          |                 |     |   |                                  |
|                                                   | S22C (load)        | <b>SPECS22C</b>          |                 |     |   |                                  |
|                                                   | Forward tran.      | <b>SPECFWDT</b>          |                 |     |   |                                  |
|                                                   | Forward match      | <b>SPECFWDM</b>          |                 |     |   |                                  |
|                                                   | Reverse tran.      | <b>SPECREVT</b>          |                 |     |   |                                  |
|                                                   | Reverse match      | <b>SPECREVM</b>          |                 |     |   |                                  |
| Class done                                        |                    | <b>CLAD</b>              | 1               |     |   |                                  |
| Label<br>class                                    | Response           | <b>LABERESP[\$]</b>      | 3               |     |   | 10 char.                         |
|                                                   | Resp. & isolation  | <b>LABERESI[\$]</b>      | 3               |     |   | "                                |
|                                                   | S11A               | <b>LABES11A[\$]</b>      | 3               |     |   | "                                |
|                                                   | S11B               | <b>LABES11B[\$]</b>      | 3               |     |   | "                                |
|                                                   | S11C               | <b>LABES11C[\$]</b>      | 3               |     |   | "                                |
|                                                   | S22A               | <b>LABES22A[\$]</b>      | 3               |     |   | "                                |
|                                                   | S22B               | <b>LABES22B[\$]</b>      | 3               |     |   | "                                |
|                                                   | S22C               | <b>LABES22C[\$]</b>      | 3               |     |   | "                                |
|                                                   | Forward tran.      | <b>LABEFWDT[\$]</b>      | 3               |     |   | "                                |
|                                                   | Forward match      | <b>LABEFWDM[\$]</b>      | 3               |     |   | "                                |
|                                                   | Reverse tran.      | <b>LABEREVT[\$]</b>      | 3               |     |   | "                                |
|                                                   | Reverse match      | <b>LABEREVM[\$]</b>      | 3               |     |   | "                                |
|                                                   | Label kit          |                          | <b>LABK[\$]</b> | 3   |   |                                  |
| Kit done                                          |                    | <b>KITD</b>              | 1               |     |   |                                  |
| Save kit                                          | Into user kit      | <b>SAVEUSEK</b>          | 1               |     |   |                                  |

| Function                           | Action             | Mnemonic                     | S | ?   | O   | Range                     |
|------------------------------------|--------------------|------------------------------|---|-----|-----|---------------------------|
| <b>CAL-power meter calibration</b> |                    |                              |   |     |     |                           |
| Power meter cal                    | Off                | <b>PWMCOFF[D]</b>            | 1 | D   |     | Cal power: -100 to 100 dB |
|                                    | Each sweep         | <b>PWMCEACS[D]</b>           | 1 | D   |     | "                         |
|                                    | One sweep          | <b>PWMCONES[D]</b>           | 1 | D   |     | "                         |
|                                    | Take cal sweep     | <b>TAKCS</b>                 | 1 |     |     | "                         |
|                                    | Number of readings | <b>NUMR[D]</b>               | 3 | D   |     | 1 to 100                  |
| Edit power loss table              | On/off             | <b>PWRLOSS&lt;ON OFF&gt;</b> | 2 | 1,0 |     |                           |
|                                    | Edit list          | <b>POWLLIST</b>              | 1 |     |     |                           |
|                                    | Add segment        | <b>SADD</b>                  | 1 |     |     |                           |
|                                    | Edit segment N     | <b>SEDI[D]</b>               | 3 | D   |     | 1 to 12                   |
|                                    | Done with segment  | <b>SDON</b>                  | 1 |     |     |                           |
|                                    | Delete segment     | <b>SDEL</b>                  | 1 |     |     |                           |
|                                    | Done               | <b>EDITDONE</b>              | 1 |     | OPC |                           |
| Clear list                         | <b>CLEL</b>        | 1                            |   |     |     |                           |
| Edit power loss segment            | Frequency          | <b>POWLFREQ[D]</b>           | 3 | D   |     | See Note 2                |
|                                    | Value              | <b>POWLLOSS[D]</b>           | 3 | D   |     | -9900 to 9900 dB          |
| Edit cal sensor table              | Sensor A           | <b>USESENSA</b>              | 1 |     |     |                           |
|                                    | Sensor B           | <b>USESENSB</b>              | 1 |     |     | HP 438A only              |
|                                    | Edit sensor menu A | <b>CALFSENA</b>              | 1 |     |     |                           |
|                                    | Edit sensor menu B | <b>CALFSENB</b>              | 1 |     |     | HP 438A only              |
|                                    | Add segment        | <b>SADD</b>                  | 1 |     |     |                           |
|                                    | Edit segment N     | <b>SEDI[D]</b>               | 3 | D   |     | 1 to 12                   |
|                                    | Done with segment  | <b>SDON</b>                  | 1 |     |     |                           |
|                                    | Delete segment     | <b>SDEL</b>                  | 1 |     |     |                           |
|                                    | Done               | <b>EDITDONE</b>              | 1 |     | OPC |                           |
| Clear list                         | <b>CLEL</b>        | 1                            |   |     |     |                           |
| Edit cal sensor segment            | Frequency          | <b>CALFFREQ[D]</b>           | 3 | D   |     | See Note 2.               |
|                                    | Cal factor         | <b>CALFCALF[D]</b>           | 3 | D   |     | 0 to 200 percent          |
| <b>CHANNEL</b>                     |                    |                              |   |     |     |                           |
| Channel                            | CH 1 active        | <b>CHAN1</b>                 | 1 |     | OPC |                           |
|                                    | CH 2 active        | <b>CHAN2</b>                 | 1 |     | OPC |                           |
| <b>COPY</b>                        |                    |                              |   |     |     |                           |
| Copy display                       | To printer         | <b>PRINALL</b>               | 1 |     |     |                           |
|                                    | To plotter         | <b>PLOT</b>                  | 1 |     |     |                           |
| Copy display talker/<br>listener   | To plotter         | <b>OUTPPLOT</b>              | 1 |     |     |                           |
|                                    | To printer         | <b>OUTPPRIN</b>              | 1 |     |     |                           |
| List values                        |                    | <b>LISV</b>                  | 1 |     |     |                           |
| Operating parameters               |                    | <b>OPEP</b>                  | 1 |     |     |                           |
| Next page                          |                    | <b>NEXP</b>                  | 1 |     |     |                           |

| Function               | Action             | Mnemonic                      | S | ?   | O   | Range            |
|------------------------|--------------------|-------------------------------|---|-----|-----|------------------|
| Restore display        |                    | <b>RESD</b>                   | 1 |     |     |                  |
| Quadrant               | Left lower         | <b>LEFL</b>                   | 1 | 0,1 |     |                  |
|                        | Left upper         | <b>LEFU</b>                   | 1 | 0,1 |     |                  |
|                        | Right lower        | <b>RIGL</b>                   | 1 | 0,1 |     |                  |
|                        | Right upper        | <b>RIGU</b>                   | 1 | 0,1 |     |                  |
|                        | Full page          | <b>FULP</b>                   | 1 | 0,1 |     |                  |
| Pen number             | Data               | <b>PENNDATA[D]</b>            | 3 |     |     | 0,1,2...10       |
|                        | Memory             | <b>PENNMEMO[D]</b>            | 3 |     |     | 0,1,2...10       |
|                        | Graticule          | <b>PENNGRAT[D]</b>            | 3 |     |     | 0,1,2...10       |
|                        | Text               | <b>PENNTXT[D]</b>             | 3 |     |     | 0,1,2...10       |
|                        | Marker             | <b>PENNMARK[D]</b>            | 3 |     |     | 0,1,2...10       |
| Line type              | Data               | <b>LINTDATA[D]</b>            | 3 |     |     | 0,1,2...10       |
|                        | Memory             | <b>LINTMEMO[D]</b>            | 3 |     |     | 0,1,2...10       |
| Features to be plotted | Data               | <b>PDATA&lt;ON OFF&gt;</b>    | 2 | 1,0 |     |                  |
|                        | Memory             | <b>PMEM&lt;ON OFF&gt;</b>     | 2 | 1,0 |     |                  |
|                        | Graticule          | <b>PGRAT&lt;ON OFF&gt;</b>    | 2 | 1,0 |     |                  |
|                        | Text               | <b>PTEXT&lt;ON OFF&gt;</b>    | 2 | 1,0 |     |                  |
|                        | Marker             | <b>PMKR&lt;ON OFF&gt;</b>     | 2 | 1,0 |     |                  |
| Plot scale             | Full page          | <b>SCAPFULL</b>               | 1 |     |     |                  |
|                        | Graticule to p1,p2 | <b>SCAPGRAT</b>               | 1 |     |     |                  |
| Plot speed             | Slow               | <b>PLOSSLOW</b>               | 1 |     |     |                  |
|                        | Fast               | <b>PLOFAST</b>                | 1 |     |     |                  |
| <b>DISPLAY</b>         |                    |                               |   |     |     |                  |
| Channels               | Dual on/off        | <b>DUAC&lt;ON OFF&gt;</b>     | 2 | 1,0 |     |                  |
|                        | Split on/off       | <b>SPLD&lt;ON OFF&gt;</b>     | 2 | 1,0 |     |                  |
|                        | D2/D1 to D2        | <b>D1DIVD2&lt;ON OFF&gt;</b>  | 2 | 1,0 |     |                  |
| Display                | Data               | <b>DISPDATA</b>               | 1 | 0,1 |     |                  |
|                        | Memory only        | <b>DISPMEMO</b>               | 1 | 0,1 |     |                  |
|                        | Data and mem       | <b>DISPDATM</b>               | 1 | 0,1 |     |                  |
|                        | Data/mem           | <b>DISPDDM</b>                | 1 | 0,1 |     |                  |
|                        | Data — mem         | <b>DISPDMM</b>                | 1 | 0,1 |     |                  |
|                        | Data to mem        | <b>DATI</b>                   | 1 | 0,1 | OPC |                  |
| Beeper                 | On done            | <b>BEEPDONE&lt;ON OFF&gt;</b> | 2 | 1,0 |     |                  |
|                        | On warning message | <b>BEEPWARN&lt;ON OFF&gt;</b> | 2 | 1,0 |     |                  |
| CRT                    | Intensity          | <b>INTE[D]</b>                | 3 | D   |     | 0 to 100 percent |
|                        | Focus              | <b>FOCU[D]</b>                | 3 | D   |     | 0 to 100 percent |
|                        | Title              | <b>TITL[\$]</b>               | 4 | \$  |     | 48 char.         |
| Frequency notation     | blank              | <b>FREQ</b>                   | 1 |     |     |                  |
| <b>ENTRY</b>           |                    |                               |   |     |     |                  |
| Step keys              | Up                 | <b>UP</b>                     | 1 |     |     |                  |
|                        | Down               | <b>DOWN</b>                   | 1 |     |     |                  |
| Entry off              |                    | <b>ENTO</b>                   | 1 |     |     |                  |



| Function                           | Action           | Mnemonic                  | S | ?   | O | Range                     |
|------------------------------------|------------------|---------------------------|---|-----|---|---------------------------|
| <b>FORMAT</b>                      |                  |                           |   |     |   |                           |
| Format                             | Log mag          | <b>LOGM</b>               | 1 | 0,1 |   |                           |
|                                    | Phase            | <b>PHAS</b>               | 1 | 0,1 |   |                           |
|                                    | Delay            | <b>DELA</b>               | 1 | 0,1 |   |                           |
|                                    | Smith chart      | <b>SMIC</b>               | 1 | 0,1 |   |                           |
|                                    | Polar            | <b>POLA</b>               | 1 | 0,1 |   |                           |
|                                    | Lin mag          | <b>LINM</b>               | 1 | 0,1 |   |                           |
|                                    | Real             | <b>REAL</b>               | 1 | 0,1 |   |                           |
|                                    | Imaginary        | <b>IMAG</b>               | 1 | 0,1 |   |                           |
|                                    | SWR              | <b>SWR</b>                | 1 | 0,1 |   |                           |
| <b>LOCAL</b>                       |                  |                           |   |     |   |                           |
| HP-IB modes                        | Talker/listener  | <b>TALKLIST</b>           | 1 | 0,1 |   |                           |
|                                    | Use pass control | <b>USEPASC</b>            | 1 | 0,1 |   |                           |
| Debug                              | Display commands | <b>DEBU&lt;ON OFF&gt;</b> | 2 | 1,0 |   |                           |
| Disc drive                         | Unit             | <b>DISCUNIT[D]</b>        | 3 | D   |   | 0 to 30                   |
|                                    | Volume           | <b>DISCVOL[D]</b>         | 3 | D   |   | 0 to 30                   |
| HP-IB addresses                    | Plotter          | <b>ADDRPLOT[D]</b>        | 1 | D   |   | 0 to 30                   |
|                                    | Printer          | <b>ADDRPRIN[D]</b>        | 1 | D   |   | 0 to 30                   |
|                                    | Disc drive       | <b>ADDRDISC[D]</b>        | 1 | D   |   | 0 to 30                   |
|                                    | Controller       | <b>ADDRCONT[D]</b>        | 1 | D   |   | 0 to 30                   |
| Power meter                        | Address          | <b>ADDRPOWM[D]</b>        | 1 | D   |   | 0 to 30                   |
|                                    | Type             | <b>POWM&lt;ON OFF&gt;</b> | 2 | 0,1 |   | On=436A,<br>off=438A/437B |
| <b>MEAS</b>                        |                  |                           |   |     |   |                           |
| Input ports                        | A/R              | <b>AR</b>                 | 1 | 0,1 |   |                           |
|                                    | B/R              | <b>BR</b>                 | 1 | 0,1 |   |                           |
|                                    | A/B              | <b>AB</b>                 | 1 | 0,1 |   |                           |
|                                    | A                | <b>MEASA</b>              | 1 | 0,1 |   |                           |
|                                    | B                | <b>MEASB</b>              | 1 | 0,1 |   |                           |
|                                    | R                | <b>MEASR</b>              | 1 | 0,1 |   |                           |
|                                    |                  |                           |   |     |   |                           |
| S-parameters                       | S11              | <b>S11</b>                | 1 | 0,1 |   |                           |
|                                    | S12              | <b>S12</b>                | 1 | 0,1 |   |                           |
|                                    | S21              | <b>S21</b>                | 1 | 0,1 |   |                           |
|                                    | S22              | <b>S22</b>                | 1 | 0,1 |   |                           |
| Conversion to alternate parameters | Off              | <b>CONVOFF</b>            | 1 | 0,1 |   |                           |
|                                    | Z:reflection     | <b>CONVZREF</b>           | 1 | 0,1 |   |                           |
|                                    | Z:transmission   | <b>CONVZTRA</b>           | 1 | 0,1 |   |                           |
|                                    | Y:reflection     | <b>CONVYREF</b>           | 1 | 0,1 |   |                           |
|                                    | Y:transmission   | <b>CONVYTRA</b>           | 1 | 0,1 |   |                           |
|                                    | 1/S              | <b>CONV1DS</b>            | 1 | 0,1 |   |                           |
| Analog input                       |                  | <b>ANAI</b>               | 1 | 0,1 |   |                           |

| Function               | Action                    | Mnemonic                   | S | ?   | O   | Range                                   |
|------------------------|---------------------------|----------------------------|---|-----|-----|-----------------------------------------|
| <b>MENU (stimulus)</b> |                           |                            |   |     |     |                                         |
| Power                  | Level                     | <b>POWE[D]</b>             | 3 | D   |     | -10 to +25 dBm                          |
|                        | Trip                      | <b>POWT&lt;ON OFF&gt;</b>  | 2 | 1,0 |     |                                         |
|                        | Always couple power       | <b>COUP&lt;ON OFF&gt;</b>  | 2 | 1,0 |     |                                         |
| Time                   | Specify                   | <b>SWET[D]</b>             | 3 | D   |     | .01 to 86,400 s                         |
| Measurement            | Restart                   | <b>REST</b>                | 1 |     |     |                                         |
| Trigger                | Hold                      | <b>HOLD</b>                | 1 | 0,1 |     |                                         |
|                        | Single                    | <b>SING</b>                | 1 |     | OPC |                                         |
|                        | Number of groups          | <b>NUMG[D]</b>             | 3 |     | OPC | 1 to 999                                |
|                        | Continuous                | <b>CONT</b>                | 1 | 0,1 |     |                                         |
|                        | External trigger off      | <b>EXTTOFF</b>             | 2 | 0,1 | OPC |                                         |
|                        | External trigger on       | <b>EXTTON</b>              | 2 | 0,1 | OPC |                                         |
|                        | External trigger on point | <b>EXTTPOIN</b>            | 1 | 0,1 | OPC |                                         |
|                        | Manual trigger on point   | <b>MANTRIG</b>             | 1 | 0,1 | OPC |                                         |
| Points                 | Specify                   | <b>POIN[D]</b>             | 3 | D   |     | 3, 11, 26, 51, 101, 201, 401, 801, 1601 |
| Coupled channels       | On/off                    | <b>COUC&lt;ON OFF&gt;</b>  | 2 | 1,0 |     |                                         |
| CW freq                | Set value                 | <b>CWFREQ[D]</b>           | 3 | D   |     | See Note 2.                             |
| Power slope            | Value                     | <b>SLOPE[D]</b>            | 3 | D   |     | 0 to 2 dB/GHz                           |
|                        | On/off                    | <b>SLOPO&lt;ON OFF&gt;</b> | 2 | 1,0 |     |                                         |
| Test set attenuation   | Port 1                    | <b>ATTP1[D]</b>            | 3 | D   |     | 0,10,20...70 dB                         |
|                        | Port 2                    | <b>ATTP2[D]</b>            | 3 | D   |     | 0,10,20...70 dB                         |
| Sweep type             | Linear                    | <b>LINFREQ</b>             | 1 | 0,1 |     |                                         |
|                        | Log                       | <b>LOGFREQ</b>             | 1 | 0,1 |     |                                         |
|                        | List                      | <b>LISFREQ</b>             | 1 | 0,1 |     |                                         |
|                        | Select a segment          | <b>SSEG[D]</b>             | 3 | 0,1 |     | 1 to 30                                 |
|                        | Select all segments       | <b>ASEG</b>                | 1 | 0,1 |     |                                         |
|                        | Power                     | <b>POWS</b>                | 1 | 0,1 |     |                                         |
|                        | CW time                   | <b>CWTIME</b>              | 1 | 0,1 |     |                                         |
| Edit list              | Begin                     | <b>EDITLIST</b>            | 1 |     |     |                                         |
|                        | Add segment               | <b>SADD</b>                | 1 |     |     |                                         |
|                        | Edit segment N            | <b>SEDI[D]</b>             | 3 | D   |     | 1 to 30                                 |
|                        | Done with segment         | <b>SDON</b>                | 1 |     |     |                                         |
|                        | Delete segment            | <b>SDEL</b>                | 1 |     |     |                                         |
|                        | Done                      | <b>EDITDONE</b>            | 1 |     | OPC |                                         |
|                        | Clear list                | <b>CLEL</b>                | 1 |     |     |                                         |
| Edit segment           | Start                     | <b>STAR[D]</b>             | 3 | D   |     | See Note 2.                             |
|                        | Stop                      | <b>STOP[D]</b>             | 3 | D   |     | "                                       |
|                        | Center                    | <b>CENT[D]</b>             | 3 | D   |     | "                                       |
|                        | Span                      | <b>SPAN[D]</b>             | 3 | D   |     | "                                       |
|                        | Points                    | <b>POIN[D]</b>             | 3 | D   |     | 1 to 1632                               |
|                        | Stepsize                  | <b>STPSIZE[D]</b>          | 3 | D   |     | See Note 2.                             |
|                        | CW                        | <b>CWFREQ[D]</b>           | 3 | D   |     | "                                       |

| Function                     | Action          | Mnemonic                     | S | ?   | O | Range       |
|------------------------------|-----------------|------------------------------|---|-----|---|-------------|
| <b>MKR</b>                   |                 |                              |   |     |   |             |
| Select active                | 1 to 4          | <b>MARK&lt;I&gt;[D]</b>      | 4 | D   |   | See Note 2. |
|                              | All off         | <b>MARKOFF</b>               | 1 | 0,1 |   |             |
| Marker zero                  | Zero offsets    | <b>MARKZERO</b>              | 1 |     |   |             |
| Delta reference              | 1 to 4          | <b>DEL&lt;I&gt;</b>          | 2 | 0,1 |   | I=1 to 4    |
|                              | Fixed marker    | <b>DELRFIXM</b>              | 1 | 0,1 |   |             |
|                              | Mode off        | <b>DELO</b>                  | 1 | 0,1 |   |             |
| Fixed mkr position           | Stimulus        | <b>MARKFSTI[D]</b>           | 3 | D   |   | See Note 2. |
|                              | Value           | <b>MARKFVAL[D]</b>           | 3 | D   |   | See Note 3. |
|                              | Aux value       | <b>MARKFAUV[D]</b>           | 3 | D   |   | "           |
| Marker placement             | Continuous      | <b>MARKCONT</b>              | 1 | 0,1 |   |             |
|                              | Discrete        | <b>MARKDISC</b>              | 1 | 0,1 |   |             |
| Coupled                      | Couple channels | <b>MARKCOUP</b>              | 1 | 0,1 |   |             |
|                              | Uncouple        | <b>MARKUNCO</b>              | 1 | 0,1 |   |             |
| Polar markers                | Log             | <b>POLMLOG</b>               | 1 | 0,1 |   |             |
|                              | Linear          | <b>POLMLIN</b>               | 1 | 0,1 |   |             |
|                              | Re/Im           | <b>POLMRI</b>                | 1 | 0,1 |   |             |
| Smith markers                | Linear          | <b>SMIMLIN</b>               | 1 | 0,1 |   |             |
|                              | Log             | <b>SMIMLOG</b>               | 1 | 0,1 |   |             |
|                              | Re/Im           | <b>SMIMRI</b>                | 1 | 0,1 |   |             |
|                              | R+jX            | <b>SMIMRX</b>                | 1 | 0,1 |   |             |
|                              | G+jB            | <b>SMIMGB</b>                | 1 | 0,1 |   |             |
| <b>MKR FCTN</b>              |                 |                              |   |     |   |             |
| Set function to marker value | Start           | <b>MARKSTAR</b>              | 1 |     |   |             |
|                              | Stop            | <b>MARKSTOP</b>              | 1 |     |   |             |
|                              | Center          | <b>MARKCENT</b>              | 1 |     |   |             |
|                              | Span            | <b>MARKSPAN</b>              | 1 |     |   |             |
|                              | Reference       | <b>MARKREF</b>               | 1 |     |   |             |
|                              | Delay           | <b>MARKDELA</b>              | 1 |     |   |             |
| Search                       | Off             | <b>SEAOFF</b>                | 1 | 0,1 |   |             |
|                              | Maximum         | <b>SEAMAX</b>                | 1 | 0,1 |   |             |
|                              | Minimum         | <b>SEAMIN</b>                | 1 | 0,1 |   |             |
|                              | Target          | <b>SEATARG[D]</b>            | 3 | D   |   | See Note 3. |
|                              | Search left     | <b>SEAL</b>                  | 1 |     |   |             |
| Search right                 | <b>SEAR</b>     | 1                            |   |     |   |             |
| Width search                 | Value           | <b>WIDV[D]</b>               | 3 | D   |   | See Note 3. |
|                              | Search on/off   | <b>WIDT&lt;ON OFF&gt;</b>    | 2 | 1,0 |   |             |
| Tracking search              | On/off          | <b>TRACK&lt;ON OFF&gt;</b>   | 2 | 1,0 |   |             |
| Statistics                   | On/off          | <b>MEASTAT&lt;ON OFF&gt;</b> | 2 | 1,0 |   |             |

| Function                          | Action          | Mnemonic                              | S | ?   | O   | Range               |
|-----------------------------------|-----------------|---------------------------------------|---|-----|-----|---------------------|
| <b>SAVE/RECALL</b>                |                 |                                       |   |     |     |                     |
| Save                              | Selected reg    | <b>SAVE&lt;I&gt;</b>                  | 2 |     | OPC | I=1 to 5            |
| Clear                             | Selected reg    | <b>CLEA&lt;I&gt;</b>                  | 2 |     |     | I=1 to 5            |
|                                   | All regs        | <b>CLEARALL</b>                       | 1 |     | OPC |                     |
| Purge                             | Selected file   | <b>PURG&lt;I&gt;</b>                  | 2 |     |     | I=1 to 5            |
| Store                             | To disc         | <b>STOR&lt;I&gt;</b>                  | 2 |     |     | I=1 to 5            |
| Title                             | Internal reg    | <b>TITR&lt;I&gt;[\$]</b>              | 2 |     |     | I=1 to 5, 10 char.  |
|                                   | Disc reg        | <b>TITF&lt;I&gt;[\$]</b>              | 2 |     |     | "                   |
| Include with<br>disc<br>registers | Data            | <b>EXTMDATA&lt;ON OFF&gt;</b>         | 2 | 1,0 |     |                     |
|                                   | Raw data        | <b>EXTMRAW&lt;ON OFF&gt;</b>          | 2 | 1,0 |     |                     |
|                                   | Formatted data  | <b>EXTMFORM&lt;ON OFF&gt;</b>         | 2 | 1,0 |     |                     |
|                                   | User graphics   | <b>EXTMGRAP&lt;ON OFF&gt;</b>         | 2 | 1,0 |     |                     |
|                                   | Data only       | <b>EXTMDATO&lt;ON OFF&gt;</b>         | 2 | 1,0 |     |                     |
| Recall                            | Selected reg    | <b>RECA&lt;I&gt;</b>                  | 2 |     | OPC | I=1 to 5            |
| Load                              | From disc       | <b>LOAD&lt;I&gt;</b>                  | 2 |     |     | I=1 to 5            |
|                                   | Register titles | <b>REFT</b>                           | 2 |     |     |                     |
| Initialize                        | Disc            | <b>INID</b>                           | 1 |     |     |                     |
|                                   | Directory size  | <b>DIRS[D]</b>                        |   |     |     | 8 to 32,760         |
| <b>SCALE REF</b>                  |                 |                                       |   |     |     |                     |
| Scale                             | Auto            | <b>AUTO</b>                           | 1 |     |     |                     |
|                                   | Value           | <b>SCAL[D]</b>                        | 3 | D   |     | See Note 3.         |
| Reference                         | Position        | <b>REFP[D]</b>                        | 3 | D   |     | 0<D<10              |
|                                   | Value           | <b>REFV[D]</b>                        | 3 | D   |     | See Note 3.         |
|                                   | Set to mkr      | <b>MARKREF</b>                        | 1 |     |     |                     |
| Delay                             | Set delay       | <b>ELED[D]</b>                        | 3 | D   |     | ±1.0 s              |
|                                   | Set to mkr      | <b>MARKDELA</b>                       | 1 |     |     |                     |
| Phase                             | Offset          | <b>PHAO[D]</b>                        | 3 | D   |     | ± 360 deg           |
| <b>STIMULUS</b>                   |                 |                                       |   |     |     |                     |
| Stimulus                          | Center          | <b>CENT[D]</b>                        | 3 | D   |     | Stim range, Note 2. |
|                                   | Span            | <b>SPAN[D]</b>                        | 3 | D   |     | "                   |
|                                   | Start           | <b>STAR[D]</b>                        | 3 | D   |     | "                   |
|                                   | Stop            | <b>STOP[D]</b>                        | 3 | D   |     | "                   |
| <b>SYSTEM</b>                     |                 |                                       |   |     |     |                     |
| Frequency<br>range                | Doubler on/off  | <b>FREQRANG&lt;3GHZ <br/>6GHZ&gt;</b> | 2 | 1,0 | OPC | See Note 4.         |
| Harmonic<br>mode                  | Off             | <b>HARMOFF</b>                        | 1 | 0,1 | OPC |                     |
|                                   | Second          | <b>HARMSEC</b>                        | 1 | 0,1 | OPC |                     |
|                                   | Third           | <b>HARMTHIR</b>                       | 1 | 0,1 | OPC |                     |

| Function                 | Action                                | Mnemonic                            | S | ?   | O        | Range            |
|--------------------------|---------------------------------------|-------------------------------------|---|-----|----------|------------------|
| Instrument Mode          | Network analyzer                      | <b>INSMNETA</b>                     | 1 | 0,1 | OPC      |                  |
|                          | Ext. source auto                      | <b>INSMEXSA</b>                     | 1 | 0,1 | OPC      |                  |
|                          | Ext. source manual                    | <b>INSMEXSM</b>                     | 1 | 0,1 | OPC      |                  |
|                          | Tuned receiver                        | <b>INSMTUNR</b>                     | 1 | 0,1 | OPC      |                  |
| Frequency offset         | On/off                                | <b>FREQOFFS&lt;ON OFF&gt;</b>       | 2 | 1,0 | OPC      |                  |
|                          | Value                                 | <b>VOFF[D]</b>                      | 3 |     |          | See note 2.      |
| <b>SYSTEM-sequencing</b> |                                       |                                     |   |     |          |                  |
| Sequencing Menu          | Do sequence                           | <b>DOSEQ&lt;I&gt;</b>               | 3 |     |          | I=1 to 6         |
|                          | New/modify sequence                   | <b>NEWSEQ&lt;I&gt;</b>              | 3 |     |          | I=1 to 6         |
|                          | Done modify                           | <b>DONM</b>                         | 1 |     |          |                  |
| Save/recall sequences    | Store to disc                         | <b>STORSEQ&lt;I&gt;</b>             | 3 |     |          | I=1 to 6         |
|                          | Recall from disc                      | <b>LOADSEQ&lt;I&gt;</b>             | 3 |     |          | I=1 to 6         |
| Special functions        | Title to printer                      | <b>TITTPRIN</b>                     | 1 |     |          |                  |
|                          | Title to power meter/HP-IB            | <b>TITTPMTR</b>                     | 1 |     |          |                  |
|                          | Wait D seconds                        | <b>SEQWAIT[D]</b>                   | 3 |     |          | 0.1 to 3000 sec. |
|                          | Pause                                 | <b>PAUS</b>                         | 1 |     |          |                  |
|                          | Marker to CW freq.                    | <b>MARKCW</b>                       | 1 |     |          |                  |
|                          | Emit beep                             | <b>EMIB</b>                         | 1 |     |          |                  |
|                          | TTL out high                          | <b>TTLOH</b>                        | 1 |     |          | See Note 4.      |
|                          | TTL out low                           | <b>TTLOL</b>                        | 1 |     |          | See Note 4.      |
|                          | Show menus                            | <b>SHOM</b>                         | 1 |     |          |                  |
|                          | Assert seq. status bit                | <b>ASSS</b>                         | 1 |     |          |                  |
|                          | Read pwr mtr/HP-IB into title string  | <b>PMTRTTIT</b>                     | 1 |     |          |                  |
|                          | Send number into trace memory         | <b>TITTMEM</b>                      | 1 |     |          |                  |
|                          | Duplicate seq. X to seq. Y            | <b>DUPLSEQ&lt;X&gt;SEQ&lt;Y&gt;</b> | 3 |     |          | X, Y=1 to 6      |
|                          | Print sequence I                      | <b>PRINSEQ&lt;I&gt;</b>             | 3 |     |          | I=1 to 6         |
|                          | Title sequence I                      | <b>TITSEQ&lt;I&gt;</b>              | 3 |     |          | I=1 to 6         |
| Clear sequence I         | <b>CLEASEQ&lt;I&gt;</b>               | 3                                   |   |     | I=1 to 6 |                  |
| Decision making          | If limit test pass then do sequence   | <b>IFLTPASSEQ&lt;I&gt;</b>          | 3 |     |          | I=1 to 6         |
|                          | If limit test fail then do sequence   | <b>IFLTFALSEQ&lt;I&gt;</b>          | 3 |     |          | I=1 to 6         |
| Loop counter             | Set value                             | <b>LOOC[D]</b>                      | 3 |     |          | 0 to 32,760      |
|                          | Increment by 1                        | <b>INCRLOOC</b>                     | 1 |     |          |                  |
|                          | Decrement by 1                        | <b>DECRLOOC</b>                     | 1 |     |          |                  |
|                          | If counter equals 0 then do sequence  | <b>IFLCEQZESEQ&lt;I&gt;</b>         | 3 |     |          | I=1 to 6         |
|                          | If counter not eq. 0 then do sequence | <b>IFLCNEZESEQ&lt;I&gt;</b>         | 3 |     |          | I=1 to 6         |

| Function                    | Action             | Mnemonic         | S        | ?   | O   | Range           |
|-----------------------------|--------------------|------------------|----------|-----|-----|-----------------|
| <b>SYSTEM-limit testing</b> |                    |                  |          |     |     |                 |
| Limit line                  | On/off             | LIMILINE<ON OFF> | 2        | 1,0 |     |                 |
| Limit test                  | On/off             | LIMITEST<ON OFF> | 2        | 1,0 |     |                 |
|                             | Beeper             | BEEPFAIL<ON OFF> | 2        | 1,0 |     |                 |
| Limit offset                | Stimulus           | LIMISTIO[D]      | 3        | D   |     | See Note 2.     |
|                             | Amplitude          | LIMIAMP[D]       | 3        | D   |     | See Note 3.     |
|                             | Marker to offset   | LIMIMAOF         | 1        |     |     |                 |
| Edit table                  | Begin edit         | EDITLIML         | 1        |     |     |                 |
|                             | Add segment        | SADD             | 1        |     |     |                 |
|                             | Edit segment D     | SEDI[D]          | 3        | D   |     | 1 to 18         |
|                             | Segment done       | SDON             | 1        |     |     |                 |
|                             | Delete segment     | SDEL             | 1        |     |     |                 |
|                             | Done with edit     | EDITDONE         | 1        |     |     |                 |
|                             | Clear list         | CLEL             | 1        |     |     |                 |
| Edit segment                | Stimulus value     | LIMS[D]          | 3        | D   |     | See Note 2.     |
|                             | Marker to stimulus | MARKSTIM         | 1        |     |     |                 |
|                             | Upper limit        | LIMU[D]          | 3        | D   |     | See Note 3.     |
|                             | Lower limit        | LIML[D]          | 3        | D   |     | "               |
|                             | Delta limits       | LIMD[D]          | 3        | D   |     | "               |
|                             | Middle value       | LIMM[D]          | 3        | D   |     | "               |
|                             | Marker to middle   | MARKMIDD         | 1        |     |     |                 |
|                             | Flat line type     | LIMITFL          | 1        | 0,1 |     |                 |
|                             | Sloping line type  | LIMITSL          | 1        | 0,1 |     |                 |
|                             | Single point type  | LIMITSP          | 1        | 0,1 |     |                 |
| <b>SYSTEM-transform</b>     |                    |                  |          |     |     |                 |
| Transform                   | On/off             | TIMDTRAN<ON OFF> | 2        |     |     |                 |
| Set freq                    | Low pass           | SETF             | 1        |     |     |                 |
| Mode                        | Low pass impulse   | LOWPIMPU         | 1        | 0,1 |     |                 |
|                             | Low pass step      | LOWPSTEP         | 1        | 0,1 |     |                 |
|                             | Bandpass           | BANDPASS         | 1        | 0,1 |     |                 |
| Window                      | Maximum            | WINDMAXI         | 1        |     |     |                 |
|                             | Normal             | WINDNORM         | 1        |     |     |                 |
|                             | Minimum            | WINDMINI         | 1        |     |     |                 |
|                             | Any value          | WINDOW[D]        | 3        | D   |     | State dependent |
| Window shape Demodulation   | Use trace memory   | WINDUSEM<ON OFF> | 2        | 1,0 |     |                 |
|                             | Off                | DEMOFF           | 1        | 0,1 |     |                 |
|                             | Amplitude          | DEMOAMPL         | 1        | 0,1 |     |                 |
|                             | Phase              | DEMOPHAS         | 1        | 0,1 |     |                 |
| Gate                        | On/off             | GATEO<ON OFF>    | 2        | 1,0 |     |                 |
|                             | Start              | GATESTAR[D]      | 3        | D   |     | See Note 2.     |
|                             | Stop               | GATESTOP[D]      | 3        | D   |     | "               |
|                             | Center             | GATECENT[D]      | 3        | D   |     | "               |
|                             | Span               | GATESPAN[D]      | 3        | D   |     | "               |
|                             | Gate shape         | Maximum          | GATSMAXI | 1   | 0,1 |                 |
| Wide                        |                    | GATSWIDE         | 1        | 0,1 |     |                 |
| Normal                      |                    | GATSNORM         | 1        | 0,1 |     |                 |
| Minimum                     |                    | GATSMINI         | 1        | 0,1 |     |                 |

NOTE 1:

The class commands are OPCable if there is only one standard in the class. If there is just one standard, that standard is measured automatically. If there is more than one standard in the class, the class command only calls another menu.

NOTE 2, Stimulus range:

For frequency sweeps: 300 kHz to 3 GHz. (3 MHz to 6 GHz for Option 006 and an HP 85047A Test Set with the doubler turned on).

For power sweeps: -10 to 25 dBm (-100 to +100 with power meter cal on).

For CW time: 0 to 24 hours.

For frequency sweep, transform on:  $\pm 1/\text{frequency step}$ .

For CW time sweep, transform on:  $\pm 1/\text{time step}$ .

NOTE 3, Amplitude range:

For log mag:  $\pm 500$  dB.

For phase:  $\pm 500$  degrees.

For Smith chart and Polar:  $\pm 500$  units.

For linear magnitude:  $\pm 500$  units.

For SWR:  $\pm 500$  units.

The scale is always positive, and has minimum values of .001 dB,  $10e-12$  degrees,  $10e-15$  seconds, and 10 picounits.

NOTE 4:

These commands are applicable when the HP 8753B is configured with an HP 85047A Test Set.

## Appendix B: HP-IB Only Commands

| Action               | Mnemonic                                 | Syntax | Description                                                                                                                                                                                                                                                                |
|----------------------|------------------------------------------|--------|----------------------------------------------------------------------------------------------------------------------------------------------------------------------------------------------------------------------------------------------------------------------------|
| <b>MISCELLANEOUS</b> |                                          |        |                                                                                                                                                                                                                                                                            |
| Identity             | <b>IDN?</b>                              | 1      | Outputs the identification string: "HEWLETT PACKARD, 8753B,0,X.XX", where X.XX is the firmware revision of the instrument.                                                                                                                                                 |
| Key                  | <b>KEY[D]</b>                            | 1      | Imitates pressing a key. The data transmitted is the key code, as defined in Figure E.4.                                                                                                                                                                                   |
| Key code             | <b>KOR?</b>                              | 1      | Outputs last key code or knob count. If the reply is positive, it is a key code. If it is negative, then set bit 15 equal to bit 14, and the resulting two byte integer is the RPG knob count. It can be either positive or negative. There are about 120 counts per turn. |
| Move marker          | <b>MARKBUCK[D]</b>                       | 2      | Moves the marker to the selected point on the trace. On a 201 point sweep, D can range from 0 to 200.                                                                                                                                                                      |
| On completion        | <b>OPC</b>                               | 1      | Reports completion of the last OPCable command received since <b>OPC</b> ; or <b>OPC?</b> ; was received.                                                                                                                                                                  |
| Plot keys            | <b>PSOFT&lt;ON OFF&gt;</b>               | 2      | Includes the menu keys in <b>OUTPPLOT</b> ; and <b>OUTPPRIN</b> ; strings.                                                                                                                                                                                                 |
| Revision             | <b>SOFR</b>                              | 1      | Displays the software revision on the HP 8753B.                                                                                                                                                                                                                            |
| Sampler              | <b>SAMC&lt;ON OFF&gt;</b>                | 2      | Turns sampler correction off. To be used only when data is being taken to create custom calibration coefficients.                                                                                                                                                          |
| Test Set             | <b>TESS?</b>                             | 1      | Returns a one if an HP 85046A/B S-parameter test set is present. Returns a two if an HP 85047A S-parameter test set is present.                                                                                                                                            |
| <b>INPUT</b>         |                                          |        |                                                                                                                                                                                                                                                                            |
| Data                 | <b>INPU DATA[D]</b>                      | 3      | Accepts error corrected data.                                                                                                                                                                                                                                              |
| Formatted            | <b>INPU FORM[D]</b>                      | 3      | Accepts formatted data.                                                                                                                                                                                                                                                    |
| Uncorrected          | <b>INPU RAW1[D]</b>                      | 3      | Accepts raw data.                                                                                                                                                                                                                                                          |
|                      | <b>INPU RAW2[D]</b>                      | 3      |                                                                                                                                                                                                                                                                            |
|                      | <b>INPU RAW3[D]</b>                      | 3      |                                                                                                                                                                                                                                                                            |
|                      | <b>INPU RAW4[D]</b>                      | 3      |                                                                                                                                                                                                                                                                            |
| Error coef.          | <b>INPU CALC&lt;01, 02, . . . 12&gt;</b> |        | Accepts the individual error coefficient arrays. Issue the command that begins the calibration the coefficients are from (e.g. <b>CALIS11</b> );, then input the data. Lastly, issue <b>SAVC</b> ; and trigger a sweep.                                                    |
| Pwr meter cal        | <b>INPU PRCAL&lt;1,2&gt;</b>             | 3      | Accepts power meter cal array. Values should be entered as 100*desired source power.                                                                                                                                                                                       |
| Cal kit              | <b>INPU CALK[D]</b>                      | 3      | Accepts a cal kit.                                                                                                                                                                                                                                                         |
| Learn string         | <b>INPU LEAS[D]</b>                      | 3      | Accepts the learn string.                                                                                                                                                                                                                                                  |
| <b>MENUS</b>         |                                          |        |                                                                                                                                                                                                                                                                            |
| Averaging            | <b>MENUAVG</b>                           | 1      |                                                                                                                                                                                                                                                                            |
| Calibration          | <b>MENUCAL</b>                           | 1      |                                                                                                                                                                                                                                                                            |
| Copy                 | <b>MENUCOPY</b>                          | 1      |                                                                                                                                                                                                                                                                            |
| Display              | <b>MENUDISP</b>                          | 1      |                                                                                                                                                                                                                                                                            |
| Format               | <b>MENUFORM</b>                          | 1      |                                                                                                                                                                                                                                                                            |



| Action      | Mnemonic                   | Syntax | Description |
|-------------|----------------------------|--------|-------------|
| Marker      | <b>MENUMARK</b>            | 1      |             |
| Meas        | <b>MENUMEAS</b>            | 1      |             |
| Marker fctn | <b>MENUMRKF</b>            | 1      |             |
| Off         | <b>MENUO&lt;ON OFF&gt;</b> | 2      |             |
| Recall      | <b>MENURECA</b>            | 1      |             |
| Save        | <b>MENUSAVE</b>            | 1      |             |
| Scale       | <b>MENUSCAL</b>            | 1      |             |
| Stimulus    | <b>MENUSTIM</b>            | 1      |             |
| System      | <b>MENUSYST</b>            | 1      |             |

## OUTPUT

NOTE: Except as noted, these commands output data according to the current output format. The data is transmitted in pairs of numbers, the number of pairs being the same as the number of points in the sweep.

|                |                                       |   |                                                                                                                                                                                                                                                                                                                            |
|----------------|---------------------------------------|---|----------------------------------------------------------------------------------------------------------------------------------------------------------------------------------------------------------------------------------------------------------------------------------------------------------------------------|
| Active funct.  | <b>OUTPACTI</b>                       | 1 | Outputs value of function in active entry area in ASCII format.                                                                                                                                                                                                                                                            |
| Error coef.    | <b>OUTPCALC&lt;01,02 . . . 12&gt;</b> |   | Outputs the selected error coefficient array from the active channel. Each array is the same as a data array. See Appendix C, Calibration, for the contents of the arrays.                                                                                                                                                 |
| Cal kit        | <b>OUTPCALK</b>                       | 1 | Outputs the active cal kit, a less than 1000 byte string in form 1.                                                                                                                                                                                                                                                        |
| Data           | <b>OUTPDATA</b>                       | 1 | Outputs the error corrected data from the active channel in real/imaginary pairs. See Figure E.1, Processing Chain.                                                                                                                                                                                                        |
| Error          | <b>OUTPERRO</b>                       | 1 | Outputs the oldest error in the error queue. The error number is transmitted, then the error message, in ASCII format.                                                                                                                                                                                                     |
| Formatted      | <b>OUTPFORM</b>                       | 1 | Outputs the formatted trace data from the active channel in current display units. See Figure E.2 for data transmitted.                                                                                                                                                                                                    |
| Pwr mtr cal    | <b>OUTPMCAL&lt;1,2&gt;</b>            | 1 | Outputs power meter cal array for channel 1 or channel 2. Values are sent as 100*power.                                                                                                                                                                                                                                    |
| Identity       | <b>OUTPIDEN</b>                       | 1 | Outputs identification string, same as <b>IDN?</b> .                                                                                                                                                                                                                                                                       |
| Keycode        | <b>OUTPKEY</b>                        | 1 | Outputs the code of the last key pressed, in ASCII format. See Figure E.4 for key codes. A -1 is transmitted for a knob turn.                                                                                                                                                                                              |
| Learn strng    | <b>OUTPLEAS</b>                       | 1 | Outputs the learn string, a less than 3,000 byte string in form 1.                                                                                                                                                                                                                                                         |
| Ext. source    | <b>OUTPRFFR</b>                       | 1 | Outputs external source RF frequency when in external source instrument mode.                                                                                                                                                                                                                                              |
| Sequencing     | <b>OUTPSEQ&lt;I&gt;</b>               | 1 | Outputs sequence I (I=1 to 6) listing over HP-IB.                                                                                                                                                                                                                                                                          |
| Limit failures | <b>OUTPLIMF</b>                       | 1 | Outputs the limit results as described under <b>OUTPLIML</b> for only those stimulus points that failed.                                                                                                                                                                                                                   |
| Limit list     | <b>OUTPLIML</b>                       | 1 | Outputs the limit test results for each stimulus point. The results consist of four numbers. The first is the stimulus value tested, the second is the test result: -1 for no test, 0 for fail, 1 for pass. The third number is the upper limit value, and the fourth is the lower limit value. This is a form 4 transfer. |
| Limit marker   | <b>OUTPLIMM</b>                       | 1 | Outputs the limit test results as described for <b>OUTPLIML</b> at the marker.                                                                                                                                                                                                                                             |

| Action                  | Mnemonic                      | Syntax | Description                                                                                                                                                                                                              |
|-------------------------|-------------------------------|--------|--------------------------------------------------------------------------------------------------------------------------------------------------------------------------------------------------------------------------|
| Marker                  | <b>OUTPMARK</b>               | 1      | Outputs the active marker values in 3 numbers. The first two numbers are the marker values, and the last is the stimulus value. See Figure E.2 for the marker values.                                                    |
| Memory                  | <b>OUTPMEMO</b>               | 1      | Outputs the memory trace from the active channel. It is error corrected data in real/imaginary pairs, and can be treated the same as data from <b>OUTPDATA</b> .                                                         |
| Marker stats.           | <b>OUTPMSTA</b>               | 1      | Outputs marker statistics: mean, standard deviation, and peak to peak deviation. ASCII format.                                                                                                                           |
| Bandwidth               | <b>OUTPMWID</b>               | 1      | Outputs results of bandwidth search: bandwidth, center, and Q. ASCII format.                                                                                                                                             |
| Plot                    | <b>OUTPPLOT</b>               | 1      | Outputs the plot string in ASCII format. Can be directed to an HP-GL plotter.                                                                                                                                            |
| Print                   | <b>OUTPPRIN</b>               | 1      | Outputs a raster display dump in ASCII format. Can be directed to a graphics printer.                                                                                                                                    |
| Raw data                | <b>OUTPRAW1</b>               | 1      | Outputs uncorrected data arrays for the active channel. Raw 1 holds the data unless a 2-port calibration is on, in which case the arrays hold S11, S21, S12, and S22, respectively. The data is in real/imaginary pairs. |
|                         | <b>OUTPRAW2</b>               | 1      |                                                                                                                                                                                                                          |
|                         | <b>OUTPRAW3</b>               | 1      |                                                                                                                                                                                                                          |
|                         | <b>OUTPRAW4</b>               | 1      |                                                                                                                                                                                                                          |
| Status byte             | <b>OUTPSTAT</b>               | 1      | Outputs the status byte. ASCII format.                                                                                                                                                                                   |
| Display title           | <b>OUTPTITL</b>               | 1      | Outputs the display title. ASCII format.                                                                                                                                                                                 |
| <b>OUTPUT FORMATS</b>   |                               |        |                                                                                                                                                                                                                          |
|                         | <b>FORM1</b>                  | 1      | HP 8753A internal format, with header.                                                                                                                                                                                   |
|                         | <b>FORM2</b>                  | 1      | 32 bit floating point, with header.                                                                                                                                                                                      |
|                         | <b>FORM3</b>                  | 1      | 64 bit floating point, with header.                                                                                                                                                                                      |
|                         | <b>FORM4</b>                  | 1      | ASCII format. No header.                                                                                                                                                                                                 |
| <b>SOFTKEYS</b>         |                               |        |                                                                                                                                                                                                                          |
| Press                   | <b>SOFT[I]</b>                | 2      | Activates softkey I, I=1 to 8.                                                                                                                                                                                           |
| label                   | <b>WRSK&lt;1 TO 8&gt;[\$]</b> | 3      | Writes label (10 char) to indicated softkey.                                                                                                                                                                             |
| <b>STATUS REPORTING</b> |                               |        |                                                                                                                                                                                                                          |
| Clear                   | <b>CLES</b>                   | 1      | Clears the status byte.                                                                                                                                                                                                  |
| Interrogate             | <b>ESB?</b>                   | 1      | Returns event status register B.                                                                                                                                                                                         |
|                         | <b>ESR?</b>                   | 1      | Returns the event status register.                                                                                                                                                                                       |
| Enable                  | <b>OUTPSTAT</b>               | 1      | Returns the status byte.                                                                                                                                                                                                 |
|                         | <b>ESE[D]</b>                 | 3      | Enables event status register. (0<D<255)                                                                                                                                                                                 |
|                         | <b>ESNB[D]</b>                | 3      | Enables event status register B. (0<D<255)                                                                                                                                                                               |
|                         | <b>SRE[D]</b>                 | 3      | Enables SRQ. (0<D<255)                                                                                                                                                                                                   |

## Appendix C: Calibration

Measurement calibration over HP-IB follows the same command sequence as a calibration from the front panel:

1. Start by selecting a cal kit, such as 50 ohm type N (**CALKN50**; over HP-IB.)
2. Select a calibration type, such as S11 1-port (**CALIS111**; over HP-IB.)
3. Call each class used by the calibration type, such as [**OPENS**] (**CLASS11A**; over HP-IB.) During a 2-port calibration, the reflection, transmission, and isolation subsequences must be opened before the classes in the subsequence are called, and then closed at the end of each subsequence.
4. If a class has more than one standard in it, select a standard from the menu presented (**STANA** to **STANG** over HP-IB.)

5. If, during a calibration, two standards are measured to satisfy one class, the class must be closed with **DONE**;
6. Declare the calibration done, such as with [**DONE 1-PORT**] (**SAV1**; over HP-IB.)

The **STANA** to **STANG** commands are all held commands because they trigger a sweep. If a class has only one standard in it, which means that it will trigger a sweep when called, the class command will be held also.

Note that since different cal kits can have a different number of standards in a given class, any automated calibration sequence is valid only for a specific cal kit.

Table C.1 Relationship between calibrations and classes

| Class                      | Response | Response and Isolation | S11 1-port | S22 1-port | One path 2-port | Full 2-port |
|----------------------------|----------|------------------------|------------|------------|-----------------|-------------|
| Reflection: <sup>1</sup>   |          |                        |            |            | •               | •           |
| S11A, opens                |          |                        | •          |            | •               | •           |
| S11B, shorts               |          |                        | •          |            | •               | •           |
| S11C, loads                |          |                        | •          |            | •               | •           |
| S22A, opens                |          |                        |            | •          |                 | •           |
| S22B, shorts               |          |                        |            | •          |                 | •           |
| S22C, loads                |          |                        |            | •          |                 | •           |
| Transmission: <sup>1</sup> |          |                        |            |            | •               | •           |
| Forward match              |          |                        |            |            | •               | •           |
| Forward thru               |          |                        |            |            | •               | •           |
| Reverse match              |          |                        |            |            |                 | •           |
| Reverse thru               |          |                        |            |            |                 | •           |
| Isolation: <sup>1</sup>    |          |                        |            |            | •               | •           |
| Forward                    |          |                        |            |            | •               | •           |
| Reverse                    |          |                        |            |            |                 | •           |
| Response                   | •        |                        |            |            |                 |             |
| Response and isolation:    |          |                        |            |            |                 |             |
| Response                   |          | •                      |            |            |                 |             |
| Isolation                  |          | •                      |            |            |                 |             |

<sup>1</sup> These subheadings must be called when doing 2-port calibrations.

Table C.2 Calibration arrays

| Array | Response | Response and Isolation          | 1-port         | 2-port <sup>1</sup> |
|-------|----------|---------------------------------|----------------|---------------------|
| 1     | ER or ET | EX (ED) <sup>2</sup><br>ET (ER) | ED<br>ES<br>ER | EDF                 |
| 2     |          |                                 |                | ESF                 |
| 3     |          |                                 |                | ERF                 |
| 4     |          |                                 |                | EXF                 |
| 5     |          |                                 |                | ELF                 |
| 6     |          |                                 |                | ETF                 |
| 7     |          |                                 |                | EDR                 |
| 8     |          |                                 |                | ESR                 |
| 9     |          |                                 |                | ERR                 |
| 10    |          |                                 |                | EXR                 |
| 11    |          |                                 |                | ELR                 |
| 12    |          |                                 |                | ETR                 |

<sup>1</sup> One path, 2-port cal duplicates arrays 1 to 6 in arrays 7 to 12.

<sup>2</sup> Response and isolation corrects for crosstalk and transmission tracking in transmission measurements, and for directivity and reflection tracking in reflection measurements.

Meaning of first subscript: D=directivity, S=source match, R=reflection tracking, X=crosstalk, L=load match, T=transmission tracking.

Meaning of second subscript: F=forward, R=reverse.

## Appendix D: Display Graphics

### HP-GL subset:

| Command                             | Description                                                                                                                                                                                                                                                                                                                                                                                                                    |             |                   |             |       |     |           |     |              |   |             |     |  |     |     |         |
|-------------------------------------|--------------------------------------------------------------------------------------------------------------------------------------------------------------------------------------------------------------------------------------------------------------------------------------------------------------------------------------------------------------------------------------------------------------------------------|-------------|-------------------|-------------|-------|-----|-----------|-----|--------------|---|-------------|-----|--|-----|-----|---------|
| <b>AF;</b>                          | Erases the user graphics display.                                                                                                                                                                                                                                                                                                                                                                                              |             |                   |             |       |     |           |     |              |   |             |     |  |     |     |         |
| <b>CS;</b>                          | Turns off the measurement display.                                                                                                                                                                                                                                                                                                                                                                                             |             |                   |             |       |     |           |     |              |   |             |     |  |     |     |         |
| <b>DF;</b>                          | Sets the default values.                                                                                                                                                                                                                                                                                                                                                                                                       |             |                   |             |       |     |           |     |              |   |             |     |  |     |     |         |
| <b>LB[<u>text</u>][<u>etx</u>];</b> | Labels the display, placing the symbols starting at the current pen position. All incoming characters are printed until the etx symbol is received. The default etx symbol is the ASCII value 3 (not the character 3).                                                                                                                                                                                                         |             |                   |             |       |     |           |     |              |   |             |     |  |     |     |         |
| <b>LTa;</b>                         | Specifies line type: <table style="margin-left: 40px;"> <tr> <td>a</td> <td>line</td> </tr> <tr> <td>0</td> <td>solid</td> </tr> <tr> <td>1</td> <td>solid</td> </tr> <tr> <td>2</td> <td>short dashes</td> </tr> <tr> <td>3</td> <td>long dashes</td> </tr> </table>                                                                                                                                                          | a           | line              | 0           | solid | 1   | solid     | 2   | short dashes | 3 | long dashes |     |  |     |     |         |
| a                                   | line                                                                                                                                                                                                                                                                                                                                                                                                                           |             |                   |             |       |     |           |     |              |   |             |     |  |     |     |         |
| 0                                   | solid                                                                                                                                                                                                                                                                                                                                                                                                                          |             |                   |             |       |     |           |     |              |   |             |     |  |     |     |         |
| 1                                   | solid                                                                                                                                                                                                                                                                                                                                                                                                                          |             |                   |             |       |     |           |     |              |   |             |     |  |     |     |         |
| 2                                   | short dashes                                                                                                                                                                                                                                                                                                                                                                                                                   |             |                   |             |       |     |           |     |              |   |             |     |  |     |     |         |
| 3                                   | long dashes                                                                                                                                                                                                                                                                                                                                                                                                                    |             |                   |             |       |     |           |     |              |   |             |     |  |     |     |         |
| <b>OP;</b>                          | Outputs P1 and P2, the scaling limits: 0,0,5850,4095.                                                                                                                                                                                                                                                                                                                                                                          |             |                   |             |       |     |           |     |              |   |             |     |  |     |     |         |
| <b>PAX,y;</b>                       | Draws from the current pen position to x,y. There can be many pairs of x,y coordinates within one command. They are separated by commas, and the entire sequence is terminated with a semicolon.                                                                                                                                                                                                                               |             |                   |             |       |     |           |     |              |   |             |     |  |     |     |         |
| <b>PD;</b>                          | Pen down. A line is drawn only if the pen is down.                                                                                                                                                                                                                                                                                                                                                                             |             |                   |             |       |     |           |     |              |   |             |     |  |     |     |         |
| <b>PG;</b>                          | Erases the user graphics display.                                                                                                                                                                                                                                                                                                                                                                                              |             |                   |             |       |     |           |     |              |   |             |     |  |     |     |         |
| <b>PRx,y;</b>                       | Plot relative: draws a line from the current pen position to a position y up and x over.                                                                                                                                                                                                                                                                                                                                       |             |                   |             |       |     |           |     |              |   |             |     |  |     |     |         |
| <b>PU;</b>                          | Pen up. Stops anything from being drawn.                                                                                                                                                                                                                                                                                                                                                                                       |             |                   |             |       |     |           |     |              |   |             |     |  |     |     |         |
| <b>RS;</b>                          | Turns on the measurement display.                                                                                                                                                                                                                                                                                                                                                                                              |             |                   |             |       |     |           |     |              |   |             |     |  |     |     |         |
| <b>SIh,w;</b>                       | Sets the character size, for height h and width w in centimeters: <table style="margin-left: 40px;"> <thead> <tr> <th><u>h</u></th> <th><u>w</u></th> <th><u>size</u></th> </tr> </thead> <tbody> <tr> <td>.16</td> <td>.20</td> <td>smallest</td> </tr> <tr> <td>.25</td> <td>.30</td> <td></td> </tr> <tr> <td>.33</td> <td>.39</td> <td></td> </tr> <tr> <td>.41</td> <td>.49</td> <td>largest</td> </tr> </tbody> </table> | <u>h</u>    | <u>w</u>          | <u>size</u> | .16   | .20 | smallest  | .25 | .30          |   | .33         | .39 |  | .41 | .49 | largest |
| <u>h</u>                            | <u>w</u>                                                                                                                                                                                                                                                                                                                                                                                                                       | <u>size</u> |                   |             |       |     |           |     |              |   |             |     |  |     |     |         |
| .16                                 | .20                                                                                                                                                                                                                                                                                                                                                                                                                            | smallest    |                   |             |       |     |           |     |              |   |             |     |  |     |     |         |
| .25                                 | .30                                                                                                                                                                                                                                                                                                                                                                                                                            |             |                   |             |       |     |           |     |              |   |             |     |  |     |     |         |
| .33                                 | .39                                                                                                                                                                                                                                                                                                                                                                                                                            |             |                   |             |       |     |           |     |              |   |             |     |  |     |     |         |
| .41                                 | .49                                                                                                                                                                                                                                                                                                                                                                                                                            | largest     |                   |             |       |     |           |     |              |   |             |     |  |     |     |         |
| <b>SPn;</b>                         | Selects pen n: <table style="margin-left: 40px;"> <tr> <td>n</td> <td><u>brightness</u></td> </tr> <tr> <td>0</td> <td>blank</td> </tr> <tr> <td>1</td> <td>brightest</td> </tr> <tr> <td>2</td> <td></td> </tr> <tr> <td>3</td> <td>dimmost</td> </tr> </table>                                                                                                                                                               | n           | <u>brightness</u> | 0           | blank | 1   | brightest | 2   |              | 3 | dimmost     |     |  |     |     |         |
| n                                   | <u>brightness</u>                                                                                                                                                                                                                                                                                                                                                                                                              |             |                   |             |       |     |           |     |              |   |             |     |  |     |     |         |
| 0                                   | blank                                                                                                                                                                                                                                                                                                                                                                                                                          |             |                   |             |       |     |           |     |              |   |             |     |  |     |     |         |
| 1                                   | brightest                                                                                                                                                                                                                                                                                                                                                                                                                      |             |                   |             |       |     |           |     |              |   |             |     |  |     |     |         |
| 2                                   |                                                                                                                                                                                                                                                                                                                                                                                                                                |             |                   |             |       |     |           |     |              |   |             |     |  |     |     |         |
| 3                                   | dimmost                                                                                                                                                                                                                                                                                                                                                                                                                        |             |                   |             |       |     |           |     |              |   |             |     |  |     |     |         |

### Accepted but ignored HP-GL commands:

|    |                             |
|----|-----------------------------|
| IM | Input service request mask  |
| IP | Input P1,P2 scaling points  |
| IW | Input window                |
| OC | Output current pen position |
| OE | Output error                |
| OI | Output identity             |
| OS | Output status               |
| SL | Character slant             |
| SR | Relative character size     |

Figure D.1: Location of graticule in user graphics units

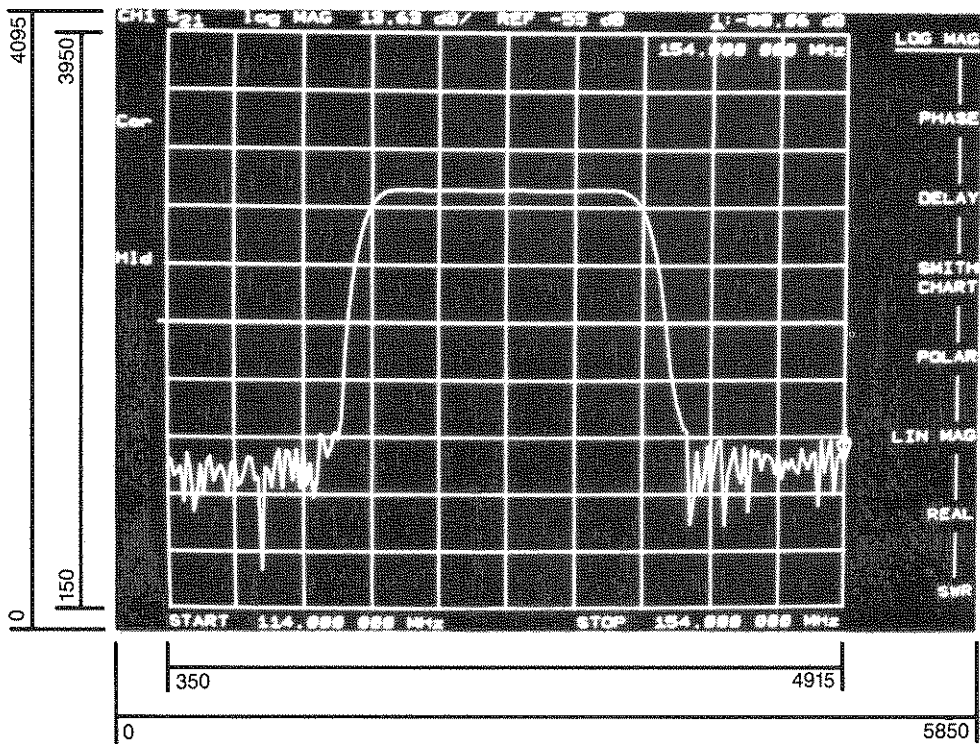

# Appendix E: Useful Tables and Figures

Figure E.1: Processing Chain

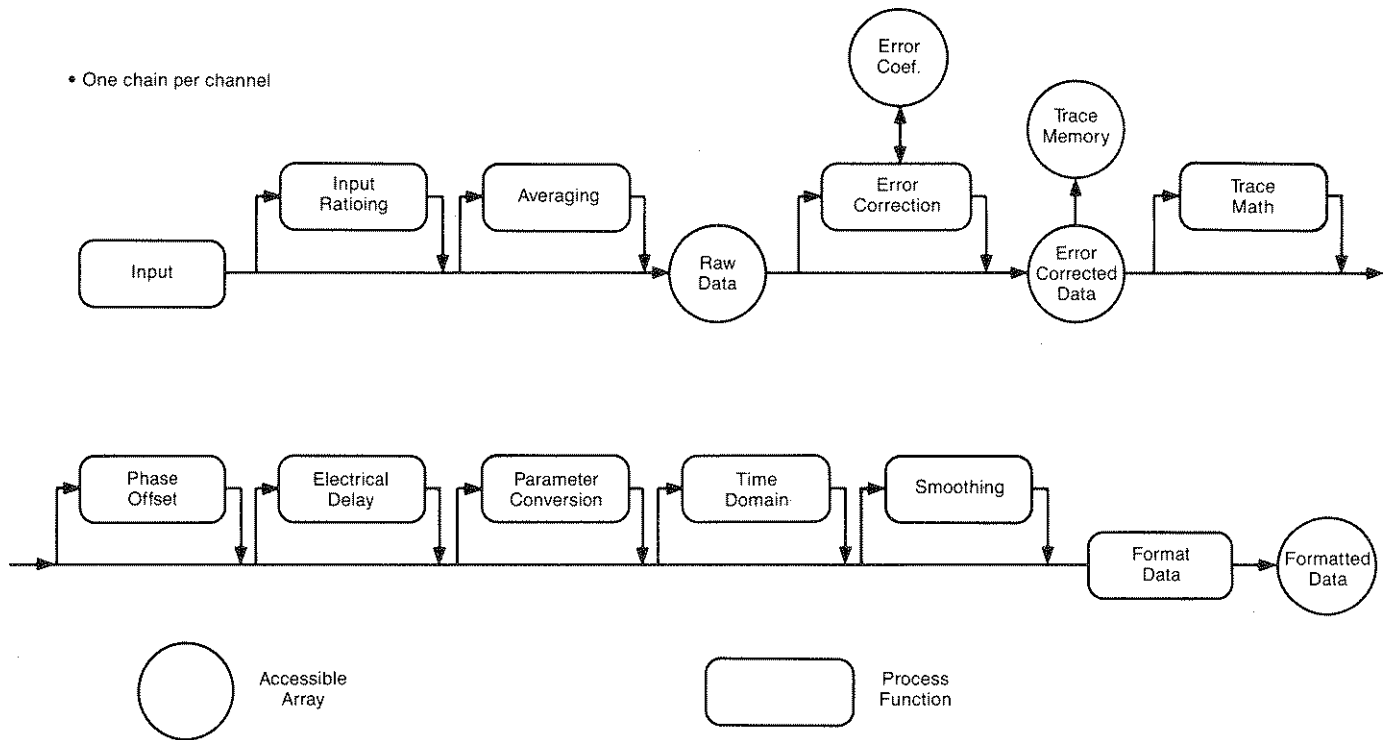

Figure E.2: Marker and data array units as a function of display format

| Display Format | Marker Mode | OUTPMARK<br>value 1, value 2 | OUTFORM<br>value 1, value 2 | Marker Readout**<br>value, aux value |
|----------------|-------------|------------------------------|-----------------------------|--------------------------------------|
| LOG MAG        |             | dB, *                        | dB, *                       | dB, *                                |
| PHASE          |             | degrees, *                   | degrees, *                  | degrees, *                           |
| DELAY          |             | seconds, *                   | seconds, *                  | seconds, *                           |
| SMITH CHART    | LIN MKR     | lin mag, degrees             | real, imag                  | lin mag, degrees                     |
|                | LOG MKR     | dB, degrees                  | "                           | dB, degrees                          |
|                | Re/Im       | real, imag                   | "                           | real, imag                           |
|                | R + jX      | real, imag ohms              | "                           | real, imag ohms                      |
|                | G + jB      | real, imag Siemens           | "                           | real, imag Siemens                   |
| POLAR          | LIN MKR     | lin mag, degrees             | real, imag                  | lin mag, degrees                     |
|                | LOG MKR     | dB, degrees                  | "                           | dB, degrees                          |
|                | Re/Im       | real, imag                   | "                           | real, imag                           |
| LIN MAG        |             | lin mag, *                   | lin mag, *                  | lin mag, *                           |
| REAL           |             | real, *                      | real, *                     | real, *                              |
| SWR            |             | SWR, *                       | SWR, *                      | SWR, *                               |

\* = Value not significant in this format, but is included in data transfers.

\*\* = The marker readout values are the marker values displayed in the upper left hand corner of the display. They also correspond to the value and aux value associated with the fixed marker.

Figure E.3: Disc file names

Disc files created by the HP 8753B consist of a state name of up to 8 characters, such as FILTER, appended with up to two characters, which indicate what is in the file. Data and calibration files are form 3 data (without a header) which can be read off the disc. The other files are not meant to be decoded, and it is recommended that disc registers not be created or modified with a computer.

**FILTERXX**

The first character is the file type, telling the kind of information in the file.

The second character is a data index, used to distinguish files of the same type.

| Char 1 | Meaning              | Char 2                          | Meaning                                                                                                |
|--------|----------------------|---------------------------------|--------------------------------------------------------------------------------------------------------|
| I      | Instrument state     |                                 |                                                                                                        |
| G      | Graphics             | 1<br>0                          | Display graphics<br>Graphics index                                                                     |
| D      | Error corrected data | 1<br>2                          | Channel 1<br>Channel 2                                                                                 |
| R      | Raw data             | 1 to 4<br>5 to 8                | Channel 1, raw arrays 1 to 4<br>Channel 2, raw arrays 1 to 4                                           |
| F      | Formatted data       | 1<br>2                          | Channel 1<br>Channel 2                                                                                 |
| M      | Memory trace         | 1<br>2                          | Channel 1<br>Channel 2                                                                                 |
| 1      | Cal data, channel 1  | K<br>0<br>1 to 9<br>A<br>B<br>C | Cal kit<br>Stimulus state<br>Coefficients 1 to 9<br>Coefficient 10<br>Coefficient 11<br>Coefficient 12 |
| 2      | Cal data, channel 2  | 0 to C,K                        | Same as channel 1                                                                                      |



Figure E.4: Key codes

Note 1: Key code 63 is invalid key.

Note 2: **OUTPKEY**; reports a knob turn as a -1.

Note 3: If the two byte integer sent back from **KOR?** is negative, it is a knob count. If the knob count was negative, no modification is needed. If the knob count was positive, however, bit 14 will not be set. In this case, the number must be decoded by clearing the most significant byte, as by AND'ing the integer with 255.



# Appendix F: Status Reporting

Figure F.1: Status Reporting Structure

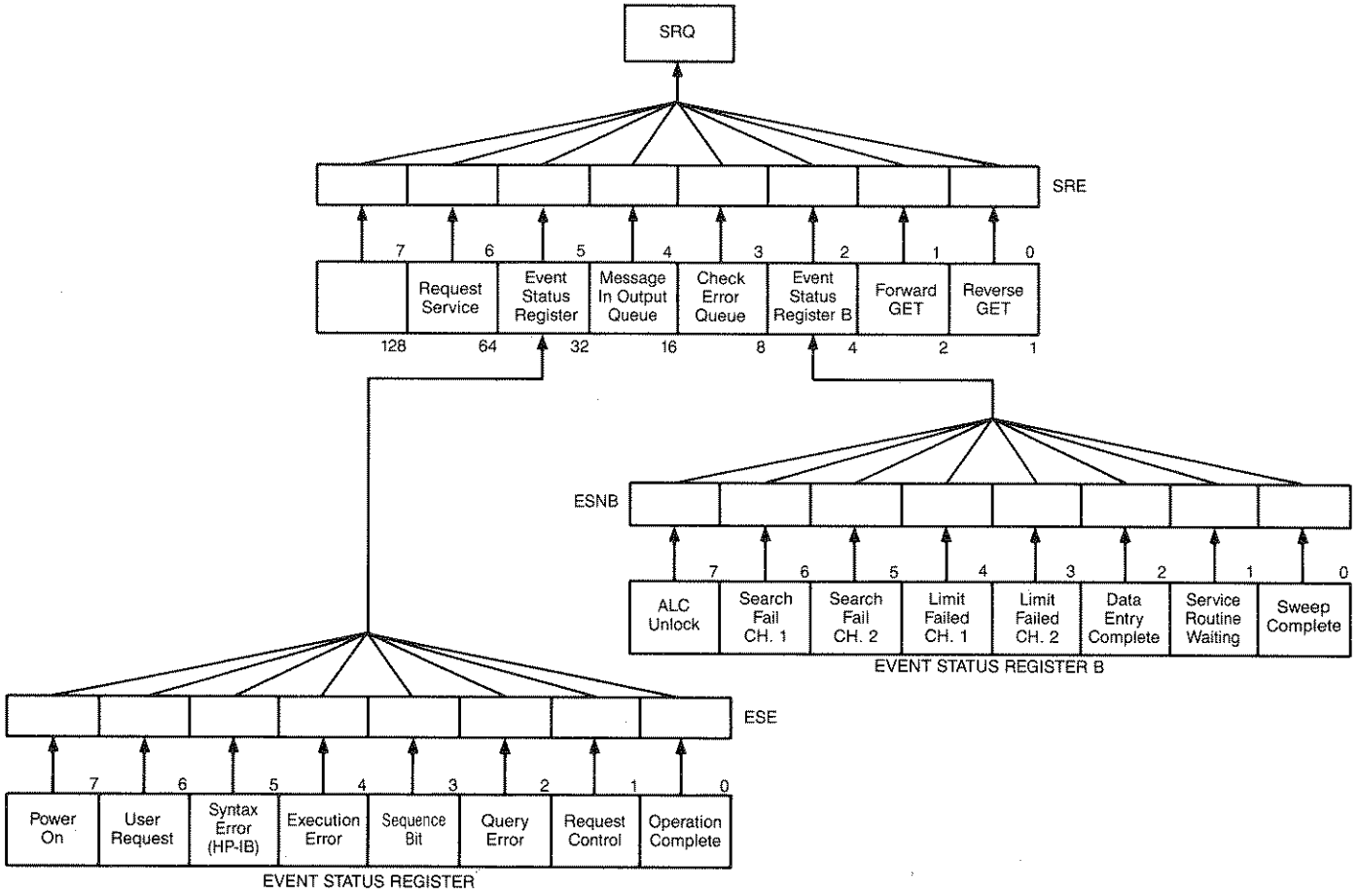

## Status Byte

| Bit | Name                          | Description                                                                                                                                       |
|-----|-------------------------------|---------------------------------------------------------------------------------------------------------------------------------------------------|
| 0   | Waiting for reverse GET       | A one path, 2-port calibration is active, and the instrument has stopped, waiting for the operator to connect the device for reverse measurement. |
| 1   | Waiting for forward GET       | A one path, 2-port calibration is active, and the instrument has stopped, waiting for the operator to connect the device for forward measurement. |
| 2   | Check event status register B | One of the enabled bits in event status register B has been set.                                                                                  |
| 3   | Check error queue             | An error has occurred and the message has been placed in the error queue, but has not been read yet.                                              |
| 4   | Message in output queue       | A command has prepared information to be output, but it has not been read yet.                                                                    |
| 5   | Check event status register   | One of the enabled bits in the event status register has been set.                                                                                |
| 6   | Request service               | One of the enabled status byte bits is causing an SRQ.                                                                                            |

## Event Status Register

| Bit | Name               | Description                                                                                                                                            |
|-----|--------------------|--------------------------------------------------------------------------------------------------------------------------------------------------------|
| 0   | Operation complete | A command for which OPC has been enabled completed operation.                                                                                          |
| 1   | Request control    | The HP 8753B has been commanded to perform an operation that requires control of a peripheral, and needs control of HP-IB. Requires pass control mode. |
| 2   | Query error        | The HP 8753B has been addressed to talk, but there is nothing in the output queue to transmit.                                                         |
| 4   | Execution error    | A command was received that could not be executed. Commonly due to invalid operands.                                                                   |
| 5   | Syntax error       | The incoming HP-IB commands contained a syntax error. The syntax error is cleared only by a device clear or an instrument preset.                      |
| 6   | User request       | The operator has pressed a front panel key or turned the knob. Works if front panel in local or remote mode.                                           |
| 7   | Power on           | A power on sequence has occurred since the last read of the register.                                                                                  |

## Event Status Register B

| Bit | Name                            | Description                                                                                                                |
|-----|---------------------------------|----------------------------------------------------------------------------------------------------------------------------|
| 0   | Sweep or group complete         | A single sweep or group has been completed since the last read of the register. Operates in conjunction with SING or NUMG. |
| 1   | Service routine waiting or done | An internal service routine has completed operation, or is waiting for an operator response.                               |
| 2   | Data entry complete             | A terminator key has been pressed, or a value entered over HP-IB since last read of the register.                          |
| 3   | Limit failed, Ch 2              | Limit test failed on channel 2.                                                                                            |
| 4   | Limit failed, Ch 1              | Limit test failed on channel 1.                                                                                            |
| 5   | Search failed, Ch 2             | A marker target search or bandwidth search was executed, but the desired value was not found.                              |
| 6   | Search failed, Ch 1             | Same as on channel 2.                                                                                                      |
| 7   | ALC unlock                      | The output power went unlevelled at the beginning or end of a sweep. Data may be invalid.                                  |

## Appendix G: Alphabetical Code Listing

Mnemonic

Description

- A -

|                            |                                                                                                                                                    |
|----------------------------|----------------------------------------------------------------------------------------------------------------------------------------------------|
| <b>AB</b>                  | Measure and display A/B on the active channel.                                                                                                     |
| <b>AR</b>                  | Measure and display A/R on the active channel.                                                                                                     |
| <b>ADDRCONT[D]</b>         | Controller HP-IB address: the address where control is returned after a pass control.                                                              |
| <b>ADDRDISC[D]</b>         | Disc HP-IB address.                                                                                                                                |
| <b>ADDRPLOT[D]</b>         | Plotter HP-IB address.                                                                                                                             |
| <b>ADDRPOWM[D]</b>         | Power meter HP-IB address.                                                                                                                         |
| <b>ADDRPRIN[D]</b>         | Printer HP-IB address.                                                                                                                             |
| <b>ALTAB</b>               | Places the HP 8753B in the alternate inputs measurement mode, where inputs A and B are measured on alternate sweeps. As opposed to <b>CHOPAB</b> . |
| <b>ANAI</b>                | Measure and display the data at the auxiliary input (ANALOG IN).                                                                                   |
| <b>ASEG</b>                | Use all segments for list frequency sweep.                                                                                                         |
| <b>ASSS</b>                | Assert the sequence status bit.                                                                                                                    |
| <b>ATTP1[D]</b>            | Set the S-parameter test set port 1 attenuator.                                                                                                    |
| <b>ATTP2[D]</b>            | Set the S-parameter test set port 2 attenuator.                                                                                                    |
| <b>AUTO</b>                | Autoscale the active channel.                                                                                                                      |
| <b>AVERFACT[D]</b>         | Set the averaging factor on the active channel.                                                                                                    |
| <b>AVERO&lt;ON OFF&gt;</b> | Turn averaging on and off on the active channel.                                                                                                   |
| <b>AVERREST</b>            | Restart the averaging on the active channel.                                                                                                       |

- B -

**BANDPASS** ..... Select the time domain bandpass mode.

These commands control the warning beeper, causing it to sound if the indicated condition occurs:

|                               |                                                                                                       |
|-------------------------------|-------------------------------------------------------------------------------------------------------|
| <b>BEEPDONE&lt;ON OFF&gt;</b> | ..... The completion of functions such as save, done with calibration standard, and data trace saved. |
| <b>BEEPFAIL&lt;ON OFF&gt;</b> | ..... A limit test failure.                                                                           |
| <b>BEEPWARN&lt;ON OFF&gt;</b> | ..... The generation of a warning message.                                                            |
| <b>BR</b>                     | ..... Measure and display B/R on the active channel.                                                  |

- C -

These commands set the open capacitance values of an open circuit while it is being defined as a calibration standard.

**C0[D]**  
**C1[D]**  
**C2[D]**  
**C3[D]**

**CAL1** ..... Accepted for compatibility with the HP 8510A, where its function is to begin a calibration sequence.

These commands set the power meter calibration factor corrections for the particular sensor used. Sensor B is only valid for the HP 438A which has two input channels:

|                    |                                                                   |
|--------------------|-------------------------------------------------------------------|
| <b>CALFCALC[D]</b> | ..... Set the calibration factor.                                 |
| <b>CALFFREQ[D]</b> | ..... Select the frequency for the calibration factor correction. |
| <b>CALFSENA</b>    | ..... Edit the sensor A calibration factor table.                 |
| <b>CALFSENB</b>    | ..... Edit the sensor B calibration factor table.                 |

These commands begin a calibration sequence:

|                 |                               |
|-----------------|-------------------------------|
| <b>CALIFUL2</b> | ..... Full 2-port.            |
| <b>CALIONE2</b> | ..... One-path 2-port.        |
| <b>CALIRAI</b>  | ..... Response and isolation. |
| <b>CALIRESP</b> | ..... Response.               |
| <b>CALIS111</b> | ..... S11 1-port.             |
| <b>CALIS221</b> | ..... S22 1-port.             |

**CALK35MM to COUC<ON|OFF>**

Mnemonic Description

These commands select a default calibration kit:

**CALK35MM** ..... 3.5 mm.  
**CALK7MM** ..... 7 mm.  
**CALKN50** ..... Type-N 50 ohm.  
**CALKN75** ..... Type-N 75 ohm.  
**CALKUSED** ..... The user defined calibration kit.

**CENT[D]** ..... Sets the center stimulus value. If a list frequency segment is being edited, sets the center of the list segment.

**CHAN1** ..... Make channel 1 the active channel. OPC'able.  
**CHAN2** ..... Make channel 2 the active channel. OPC'able.  
**CHOPAB** ..... Places the HP 8753B in the chop measurement mode. As opposed to **ALTAB**;  
**CLAD** ..... Class done, modify cal kit, specify class.

These commands call reflection standard classes during a calibration sequence. If only one standard is in the class, it is measured. If there is more than one, the standard being used must be selected with **STAN<A|B|C|D|E|F|G>**. If there is only one standard in the class, these commands are OPC'able.

**CLASS11A** ..... S11A: S11 1-port, opens.  
**CLASS11B** ..... S11B: S11 1-port, shorts.  
**CLASS11C** ..... S11C: S11 1-port, loads.  
**CLASS22A** ..... S22A: S22 1-port, opens.  
**CLASS22B** ..... S22B: S22 1-port, shorts.  
**CLASS22C** ..... S22C: S22 1-port, loads.

These commands clear the indicated save/recall registers:

**CLEA1** ..... 1.  
**CLEA2** ..... 2.  
**CLEA3** ..... 3.  
**CLEA4** ..... 4.  
**CLEA5** ..... 5.  
**CLEARALL** ..... All the registers. OPC'able.

These commands clear the sequence from the internal registers:

**CLEASEQ1** ..... Sequence 1.  
**CLEASEQ2** ..... Sequence 2.  
**CLEASEQ3** ..... Sequence 3.  
**CLEASEQ4** ..... Sequence 4.  
**CLEASEQ5** ..... Sequence 5.  
**CLEASEQ6** ..... Sequence 6.

**CLEL** ..... Clear the desired list. This could be a frequency list, power loss list, or limit test list.

**CLES** ..... Clears the status register, the event status registers, and the enable registers.

**CLS** ..... Same as CLES.

**COAX** ..... Selects coaxial offsets instead of waveguide while defining a standard during a cal kit modification.

**CONT** ..... Continuous sweep trigger mode.

These commands convert the S-parameter data to:

**CONV1DS** ..... Inverted S-parameters.  
**CONVOFF** ..... Conversion off.  
**CONVYREF** ..... Y:reflection.  
**CONVYTRA** ..... Y:transmission.  
**CONVZREF** ..... Z:reflection.  
**CONVZTRA** ..... Z:transmission.

**COPYFRFT** ..... Copies the file titles into the register titles.

**COPYFRRT** ..... Copy save/recall register titles to the disc register titles.

**CORI<ON|OFF>** ..... Turns interpolative error correction on and off.

**CORR<ON|OFF>** ..... Turns error correction on and off.

**COUC<ON|OFF>** ..... Couples and uncouples the stimulus between the channels.

| Mnemonic                        | Description                                                                                                                                                                |
|---------------------------------|----------------------------------------------------------------------------------------------------------------------------------------------------------------------------|
| <b>COUP&lt;ON OFF&gt;</b> ..... | Couple the power when coupled channels is turned off, <b>COUCOFF</b> .                                                                                                     |
| <b>CWFREQ[D]</b> .....          | Sets the CW frequency for power sweep and CW frequency modes. While the list frequency table segment is being edited, it sets the center frequency of the current segment. |
| <b>CWTIME</b> .....             | Selects the CW time sweep type.                                                                                                                                            |

- D -

|                                     |                                                                                                                                                    |
|-------------------------------------|----------------------------------------------------------------------------------------------------------------------------------------------------|
| <b>D1DIVID2&lt;ON OFF&gt;</b> ..... | This command divides the data in channel 1 by the data in channel 2 and displays the result on channel 2.                                          |
| <b>DATI</b> .....                   | Stores trace in channel memory. OPC'able.                                                                                                          |
| <b>DEBU&lt;ON OFF&gt;</b> .....     | Turns the HP-IB debug mode on and off. When on, the HP 8753B scrolls incoming HP-IB commands across the display.                                   |
| <b>DECRLOOC</b> .....               | Decrements the sequencing loop counter by 1. <b>NEWSEQ&lt;I&gt;</b> must precede to ensure that a sequence is currently being created or modified. |
| <b>DEFS[D]</b> .....                | Begins standard definition during cal kit modification. D is the standard number.                                                                  |
| <b>DELA</b> .....                   | Displays the data formatted as group delay.                                                                                                        |
| <b>DELO</b> .....                   | Turns the delta marker mode off.                                                                                                                   |

These commands make the indicated marker the delta reference:

|                       |               |
|-----------------------|---------------|
| <b>DELR1</b> .....    | Marker 1.     |
| <b>DELR2</b> .....    | Marker 2.     |
| <b>DELR3</b> .....    | Marker 3.     |
| <b>DELR4</b> .....    | Marker 4.     |
| <b>DELRFIXM</b> ..... | Fixed marker. |

|                          |                                                                                                              |
|--------------------------|--------------------------------------------------------------------------------------------------------------|
| <b>DEMOAMPL</b> .....    | Sets the transform demodulation to amplitude demodulation. Only has an effect with a CW time transform.      |
| <b>DEMOOFF</b> .....     | Turns the transform demodulation function off.                                                               |
| <b>DEMOPHAS</b> .....    | Sets the transform demodulation to phase demodulation.                                                       |
| <b>DIRS[D]</b> .....     | Sets the number of files in the directory at disc initialization.                                            |
| <b>DISCUNIT[D]</b> ..... | Specifies which disc in a multiple-disc disc drive is to be used for disc registers.                         |
| <b>DISCVOLU[D]</b> ..... | Specifies which volume of a multiple-volume disc drive (e.g. a Winchester) is to be used for disc registers. |

These commands display the indicated combinations of data and trace memory on the active channel:

|                                 |                                                                                                                                         |
|---------------------------------|-----------------------------------------------------------------------------------------------------------------------------------------|
| <b>DISPDATA</b> .....           | Data only.                                                                                                                              |
| <b>DISPDATM</b> .....           | Data and memory.                                                                                                                        |
| <b>DISPMEMO</b> .....           | Memory only.                                                                                                                            |
| <b>DISPDDM</b> .....            | Data divided by memory (linear division, log subtraction).                                                                              |
| <b>DISPDMM</b> .....            | Data minus memory (linear subtraction).                                                                                                 |
| <b>DIVI</b> .....               | Same as <b>DISPDDM</b> .                                                                                                                |
| <b>DONE</b> .....               | Done with a class of standards, during a calibration. Only needed when multiple standards are measured to complete the class. OPC'able. |
| <b>DONM</b> .....               | Done modifying a test sequence.                                                                                                         |
| <b>DOSEQ&lt;I&gt;</b> .....     | Begin execution of the selected sequence.                                                                                               |
| <b>DOWN</b> .....               | Decrements the value in the active entry area (down key).                                                                               |
| <b>DUAC&lt;ON OFF&gt;</b> ..... | Dual channel display on or off.                                                                                                         |
| <b>DUPLSEQ[X]SEQ[Y]</b> .....   | Duplicates sequence X to sequence Y.                                                                                                    |

- E -

|                       |                                                                                                                                          |
|-----------------------|------------------------------------------------------------------------------------------------------------------------------------------|
| <b>EDITDONE</b> ..... | Done editing list frequency or limit table. OPC'able.                                                                                    |
| <b>EDITLIML</b> ..... | Begin editing limit table.                                                                                                               |
| <b>EDITLIST</b> ..... | Begin editing list frequency table.                                                                                                      |
| <b>ELED[D]</b> .....  | Sets the electrical delay offset.                                                                                                        |
| <b>EMIB</b> .....     | Send out a beep during a sequence. <b>NEWSEQ&lt;I&gt;</b> must precede to ensure that a sequence is currently being created or modified. |
| <b>ENTO</b> .....     | Turns the active entry area off.                                                                                                         |
| <b>ESB?</b> .....     | Outputs event status register B.                                                                                                         |

## ESE[D] to GATSWIDE

| Mnemonic | Description                                                                                                                                                                               |
|----------|-------------------------------------------------------------------------------------------------------------------------------------------------------------------------------------------|
| ESE[D]   | Enables the selected event status register bits to be summarized by bit 5 in the status byte. An event status register bit is enabled when the corresponding bit in the operand D is set. |
| ESNB[D]  | Enables the selected event status register B bits to be summarized by bit 2 of the status byte. Much like <b>ESE</b> ;                                                                    |
| ESR?     | Outputs the value of the event status register.                                                                                                                                           |

These commands include the indicated information when a register is stored on disc. See Figure E.1 for data types:

|                  |                             |
|------------------|-----------------------------|
| EXTMDATA<ON OFF> | ..... Error corrected data. |
| EXTMDATO<ON OFF> | ..... Data array only.      |
| EXTMFORM<ON OFF> | ..... Formatted trace data. |
| EXTMGRAP<ON OFF> | ..... User graphics.        |
| EXTMRAW<ON OFF>  | ..... Raw data arrays.      |

|          |                                                                     |
|----------|---------------------------------------------------------------------|
| EXTTOFF  | ..... Deactivates the external trigger mode. OPC'able.              |
| EXTTON   | ..... Activates the external trigger mode. OPC'able.                |
| EXTTPOIN | ..... Sets the external trigger to auto trigger on point. OPC'able. |

- F -

|         |                                                                                                                     |
|---------|---------------------------------------------------------------------------------------------------------------------|
| FIXE    | ..... Specifies a fixed load, as opposed to a sliding load, when defining a standard during a cal kit modification. |
| FOCU[D] | ..... CRT focus, 0 to 100 percent.                                                                                  |

These commands set the data format for array transfers in and out of the instrument:

|       |                                                                |
|-------|----------------------------------------------------------------|
| FORM1 | ..... HP 8753B internal format. Preceded by 4 byte header.     |
| FORM2 | ..... 32 bit floating point format. Preceded by 4 byte header. |
| FORM3 | ..... 64 bit floating point format. Preceded by 4 byte header. |
| FORM4 | ..... ASCII format. No header.                                 |

|                     |                                                                                        |
|---------------------|----------------------------------------------------------------------------------------|
| FREQOFFS<ON OFF>    | ..... Activates the frequency offset instrument mode. OPC'able.                        |
| FREQRANG<3GHZ 6GHZ> | ..... Turns on and off the frequency doubler in the HP 85047A Test Set. OPC'able.      |
| FREER               | ..... HP-IB free run. Acts the same as <b>CONT</b> ;                                   |
| FREO                | ..... Frequency blank. Turns off frequency notation.                                   |
| FULP                | ..... Selects full page plotting, as opposed to plotting in one of the four quadrants. |

These commands select a forward calibration class, during a 2-port calibration sequence. They are OPC'able if there is only one standard in the class:

|      |                     |
|------|---------------------|
| FWDI | ..... Isolation.    |
| FWDM | ..... Match.        |
| FWDT | ..... Transmission. |

- G -

These commands control the time domain gate (available only with option 010, time domain):

|               |                    |
|---------------|--------------------|
| GATECENT[D]   | ..... Center time. |
| GATEO<ON OFF> | ..... Gate on/off. |
| GATESPAN[D]   | ..... Span time.   |
| GATESTAR[D]   | ..... Start time.  |
| GATESTOP[D]   | ..... Stop time.   |

These commands set the gate shape:

|          |                |
|----------|----------------|
| GATSMAXI | ..... Maximum. |
| GATSMINI | ..... Minimum. |
| GATSNORM | ..... Normal.  |
| GATSWIDE | ..... Wide.    |

| Mnemonic | Description |
|----------|-------------|
|----------|-------------|

- H -

These commands activate the harmonic measurement mode, Option 002. They are all OPCable:

|                       |                               |
|-----------------------|-------------------------------|
| <b>HARMOFF</b> .....  | Turns off harmonic mode.      |
| <b>HARMSEC</b> .....  | Measures the second harmonic. |
| <b>HARMTHIR</b> ..... | Measures the third harmonic.  |

|                   |                                   |
|-------------------|-----------------------------------|
| <b>HOLD</b> ..... | Puts the sweep trigger into hold. |
|-------------------|-----------------------------------|

- I -

|                      |                                                                                                                           |
|----------------------|---------------------------------------------------------------------------------------------------------------------------|
| <b>IDN?</b> .....    | Outputs the identification string: "HEWLETT PACKARD,8753B,0,X.XX", where X.XX is the firmware revision of the instrument. |
| <b>IFBW[D]</b> ..... | Sets the IF bandwidth.                                                                                                    |

These commands branch an executing sequence to a new sequence if the following condition is satisfied. **NEWSEQ<I>** must precede to ensure that a sequence is currently being created or modified:

|                                    |                                   |
|------------------------------------|-----------------------------------|
| <b>IFLCEQZESEQ&lt;I&gt;</b> .....  | Loop counter equals zero.         |
| <b>INFLCNEZESEQ&lt;I&gt;</b> ..... | Loop counter does not equal zero. |
| <b>IFLTFALSESEQ&lt;I&gt;</b> ..... | Limit test fails.                 |
| <b>IFLTPASSESEQ&lt;I&gt;</b> ..... | Limit test passes.                |

|                       |                                                                                                                                                    |
|-----------------------|----------------------------------------------------------------------------------------------------------------------------------------------------|
| <b>IMAG</b> .....     | Selects the imaginary display format.                                                                                                              |
| <b>INCRLOOC</b> ..... | Increments the sequencing loop counter by 1. <b>NEWSEQ&lt;I&gt;</b> must precede to ensure that a sequence is currently being created or modified. |
| <b>INID</b> .....     | Initialize disc. All information on disc will be destroyed. Requires pass control mode.                                                            |

These commands input individual calibration coefficient arrays. Before sending the array, issue a **CALIXXXX;** command, where XXX specifies the calibration type of the data. Then input the cal arrays. Lastly store the data with **SAVC;**. The instrument goes into hold, displaying uncorrected data: **SING;** completes the process by displaying error corrected data. See Appendix C, Calibration, for the contents of the different arrays.

|                            |          |
|----------------------------|----------|
| <b>INPUCALC01[D]</b> ..... | Array 1. |
| <b>INPUCALC02[D]</b> ..... | 2.       |
| <b>INPUCALC03[D]</b> ..... | 3.       |
| <b>INPUCALC04[D]</b> ..... | 4.       |
| <b>INPUCALC05[D]</b> ..... | 5.       |
| <b>INPUCALC06[D]</b> ..... | 6.       |
| <b>INPUCALC07[D]</b> ..... | 7.       |
| <b>INPUCALC08[D]</b> ..... | 8.       |
| <b>INPUCALC09[D]</b> ..... | 9.       |
| <b>INPUCALC10[D]</b> ..... | 10.      |
| <b>INPUCALC11[D]</b> ..... | 11.      |
| <b>INPUCALC12[D]</b> ..... | 12.      |

|                          |                                                                                                                                                  |
|--------------------------|--------------------------------------------------------------------------------------------------------------------------------------------------|
| <b>INPUCALK[D]</b> ..... | Inputs a cal kit read out with <b>OUTCALK;</b> . After the transfer, the data should be saved into the user cal kit area with <b>SAVEUSEK;</b> . |
| <b>INPUDATA[D]</b> ..... | Inputs an error corrected data array, using current format. The instrument stops sweeping, and then formats and displays the data.               |
| <b>INPUFORM[D]</b> ..... | Inputs a formatted data array, using current format. The instrument stops sweeping and displays the data.                                        |
| <b>INPULEAS[D]</b> ..... | Inputs a learn string read out by <b>OUTPLEAS;</b> .                                                                                             |

These commands input power meter calibration arrays into the instrument. Values should be entered as 100\*desired source power.

|                         |            |
|-------------------------|------------|
| <b>INPUPMCAL1</b> ..... | Channel 1. |
| <b>INPUPMCAL2</b> ..... | Channel 2. |

These commands input a raw data array using the current format. See **OUTPRAW** for the meaning of the arrays. The instrument stops sweeping, error corrects the data, then formats and displays the data.

|                          |    |
|--------------------------|----|
| <b>INPURAW1[D]</b> ..... | 1. |
| <b>INPURAW2[D]</b> ..... | 2. |
| <b>INPURAW3[D]</b> ..... | 3. |
| <b>INPURAW4[D]</b> ..... | 4. |



| Mnemonic | Description |
|----------|-------------|
|----------|-------------|

These commands select the instrument mode. They are all OPC'able.:

|                       |                            |
|-----------------------|----------------------------|
| <b>INSMEXSA</b> ..... | External source, auto.     |
| <b>INSMEXSM</b> ..... | External source, manual.   |
| <b>INSMNETA</b> ..... | Standard network analyzer. |
| <b>INSMTUNR</b> ..... | Tuned receiver.            |

|                      |                                                                    |
|----------------------|--------------------------------------------------------------------|
| <b>INTE[D]</b> ..... | Sets the display intensity, 0 to 100 percent.                      |
| <b>ISOD</b> .....    | Done with isolation subsequence in a 2-port calibration. OPC'able. |
| <b>ISOL</b> .....    | Begins the isolation subsequence step in a 2-port calibration.     |

- K -

|                     |                                                                                                                                                                                                                                                                                                                                                       |
|---------------------|-------------------------------------------------------------------------------------------------------------------------------------------------------------------------------------------------------------------------------------------------------------------------------------------------------------------------------------------------------|
| <b>KEY[D]</b> ..... | Sends a keycode, equivalent to actually pressing the key. It does not matter if the front panel is in remote mode. See Figure E.4 for the key codes.                                                                                                                                                                                                  |
| <b>KITD</b> .....   | Calibration kit done: the last step in modifying a cal kit.                                                                                                                                                                                                                                                                                           |
| <b>KOR?</b> .....   | Outputs a two byte key code/knob count. If the number is positive, it is a key code. Otherwise, it has to be converted to a knob count by clearing the upper 8 bits if bit 14 is not set. The resulting integer is the knob count, either positive or negative, depending on the direction of turn. There are approximately 120 counts per knob turn. |

- L -

These commands enter labels for the standard classes during a cal kit modification:

|                           |                                   |
|---------------------------|-----------------------------------|
| <b>LABEFWDM[\$]</b> ..... | Forward match.                    |
| <b>LABEFWDT[\$]</b> ..... | Forward transmission.             |
| <b>LABERESP[\$]</b> ..... | Response.                         |
| <b>LABERESI[\$]</b> ..... | Response, response and isolation. |
| <b>LABEREVM[\$]</b> ..... | Reverse match.                    |
| <b>LABEREVT[\$]</b> ..... | Reverse transmission.             |
| <b>LABES11A[\$]</b> ..... | S11A (opens).                     |
| <b>LABES11B[\$]</b> ..... | S11B (shorts).                    |
| <b>LABES11C[\$]</b> ..... | S11C (loads).                     |
| <b>LABES22A[\$]</b> ..... | S22A (opens).                     |
| <b>LABES22B[\$]</b> ..... | S22B (shorts).                    |
| <b>LABES22C[\$]</b> ..... | S22C (loads).                     |

|                                     |                                                                                                                              |
|-------------------------------------|------------------------------------------------------------------------------------------------------------------------------|
| <b>LABK[\$]</b> .....               | Enters a cal kit label during a cal kit modification.                                                                        |
| <b>LABS[\$]</b> .....               | Enters a standard's label during standard definition.                                                                        |
| <b>LEFL</b> .....                   | Selects a plot in the left lower quadrant.                                                                                   |
| <b>LEFU</b> .....                   | Selects a plot in the left upper quadrant.                                                                                   |
| <b>LIMD[D]</b> .....                | Sets the limit delta value while editing a limit line segment.                                                               |
| <b>LIMIAMPO[D]</b> .....            | Enters the limit line amplitude offset.                                                                                      |
| <b>LIMILINE&lt;ON OFF&gt;</b> ..... | Turns the display of the limit lines on and off.                                                                             |
| <b>LIMIMAOF[D]</b> .....            | Marker to limit offset. Centers the limit lines about the current marker position using the limit amplitude offset function. |
| <b>LIMISTIO[D]</b> .....            | Enters the stimulus offset of the limit lines.                                                                               |
| <b>LIMITEST&lt;ON OFF&gt;</b> ..... | Turns limit testing on and off.                                                                                              |

These commands edit a limit test segment. The limit table editing is begun with **EDITLIML;**, and a segment is brought up for editing with either **SADD;** or **SEDI N;**. The segment is closed with **SDON;**, the table is closed with **EDITDONE;**.

|                          |                                              |
|--------------------------|----------------------------------------------|
| <b>LIMM[D]</b> .....     | Set the middle limit value.                  |
| <b>LIML[D]</b> .....     | Set the lower limit value.                   |
| <b>LIMS[D]</b> .....     | Set the limit stimulus break point.          |
| <b>LIMTFL</b> .....      | Make the segment a flat line.                |
| <b>LIMTSL</b> .....      | Make the segment a sloping line.             |
| <b>LIMTSP</b> .....      | Make the segment a single point.             |
| <b>LIMU[D]</b> .....     | Set the upper limit value.                   |
| <b>LINM</b> .....        | Selects the linear magnitude display format. |
| <b>LINFREQ</b> .....     | Selects a linear frequency sweep.            |
| <b>LINTDATA[D]</b> ..... | Enters the line type for plotting data.      |

**LINTMEMO[D] to MAXF[D]**

Mnemonic

Description

**LINTMEMO[D]** ..... Enters the line type for plotting memory.  
**LISFREQ** ..... Selects the list frequency sweep mode.  
**LISV** ..... Activates the list values function. The next page of values can be called with **NEXP**;  
 The current page can be plotted or printed with **PLOT**;, or **PRINTALL**;

These commands load the indicated file from disc. Requires pass control. The actual file recalled depends on the file title in the file position specified:

**LOAD1** ..... 1.  
**LOAD2** ..... 2.  
**LOAD3** ..... 3.  
**LOAD4** ..... 4.  
**LOAD5** ..... 5.

**LOGFREQ** ..... Selects a log frequency sweep.  
**LOGM** ..... Selects the log magnitude display format.  
**LOOC[D]** ..... Sets the value of the sequencing loop counter. **NEWSEQ<I>** must precede to ensure that a sequence is currently being created or modified.  
**LOWPIMPU** ..... Turns on the low pass impulse transform (option 010).  
**LOWPSTEP** ..... Turns on the low pass step transform (option 010).  
**LRN?** ..... Same as **OUTPLEAS**.  
**LRN[D]** ..... Same as **INPULEAS**.

- M -

**MANTRIG** ..... Sets the external trigger to manual trigger on point. OPC'able.

These commands make the indicated marker active and sets its stimulus:

**MARK1[D]** ..... Marker 1.  
**MARK2[D]** ..... Marker 2.  
**MARK3[D]** ..... Marker 3.  
**MARK4[D]** ..... Marker 4.

**MARKBUCK[D]** ..... Places the marker on a specific sweep point (bucket). D is the bucket number, ranging from 0 to number of points less 1.

**MARKCENT** ..... Enters the marker stimulus as the center stimulus.  
**MARKCONT** ..... Places the markers continuously on the trace, not on discrete sample points.  
**MARKCOUP** ..... Couples the markers between the channels, as opposed to **MARKUNCO**.  
**MARKCW** ..... Sets the CW frequency to the marker frequency.  
**MARKDELA** ..... Sets electrical length so group delay is zero at the marker stimulus.  
**MARKDISC** ..... Places the markers in discrete placement mode.  
**MARKFAUV[D]** ..... Sets the auxiliary value of the fixed marker position. Works in coordination with **MARKFVAL** and **MARKFSTI**.  
**MARKFSTI[D]** ..... Sets the stimulus position of the fixed marker.  
**MARKFVAL[D]** ..... Sets the value of the fixed marker position. See Figure E.2 for the meaning of value and auxiliary value as a function of display format.  
**MARKMAXI** ..... Same as **SEAMAX**.  
**MARKMIDD** ..... During a limit segment edit, makes the marker amplitude the limit segment middle value.  
**MARKMINI** ..... Same as **SEAMIN**.  
**MARKOFF** ..... Turns all markers and marker functions off.  
**MARKREF** ..... Enters the marker amplitude as the reference value.  
**MARKSPAN** ..... Enters the span between the active marker and the delta reference as the sweep span.  
**MARKSTIM** ..... During a limit segment edit, enters the marker stimulus as the limit stimulus break point.  
**MARKSTAR** ..... Enters the marker stimulus as the start stimulus.  
**MARKSTOP** ..... Enters the marker stimulus as the stop stimulus.  
**MARKUNCO** ..... Uncouples the markers between channels, as opposed to **MARKCOUP**.  
**MARKZERO** ..... Places the fixed marker at the active marker position and makes it the delta reference.  
**MAXF[D]** ..... Sets the maximum valid frequency of a standard being defined during a cal kit modification.

| Mnemonic                           | Description                                          |
|------------------------------------|------------------------------------------------------|
| <b>MEASA</b> .....                 | Measures and displays input A on the active channel. |
| <b>MEASB</b> .....                 | Measures and displays input B on the active channel. |
| <b>MEASR</b> .....                 | Measures and displays input R on the active channel. |
| <b>MEASTAT&lt;ON OFF&gt;</b> ..... | Turns trace statistics on and off.                   |

These commands bring up the menu associated with the indicated front panel key:

|                                 |                          |
|---------------------------------|--------------------------|
| <b>MENUAVG</b> .....            | AVG                      |
| <b>MENUCAL</b> .....            | CAL                      |
| <b>MENUCOPY</b> .....           | COPY                     |
| <b>MENUDISP</b> .....           | DISPLAY                  |
| <b>MENUFORM</b> .....           | FORMAT                   |
| <b>MENUMARK</b> .....           | MKR                      |
| <b>MENUMEAS</b> .....           | MEAS                     |
| <b>MENUMRKF</b> .....           | MKR FCTN                 |
| <b>MENU&lt;ON OFF&gt;</b> ..... | Blanks the softkey menu. |
| <b>MENURECA</b> .....           | RECALL                   |
| <b>MENUSAVE</b> .....           | SAVE                     |
| <b>MENUSCAL</b> .....           | SCALE                    |
| <b>MENUSTIM</b> .....           | STIMULUS MENU            |
| <b>MENUSYST</b> .....           | SYSTEM                   |

|                      |                                                                                             |
|----------------------|---------------------------------------------------------------------------------------------|
| <b>MINF[D]</b> ..... | Sets the minimum valid frequency of a standard being defined during a cal kit modification. |
| <b>MINU</b> .....    | Displays data minus memory, the same as <b>DISPDMM</b> .                                    |
| <b>MODH</b> .....    | Begins the modify cal kit sequence.                                                         |

- N -

|                              |                                                                                                                                                               |
|------------------------------|---------------------------------------------------------------------------------------------------------------------------------------------------------------|
| <b>NEWSEQ&lt;I&gt;</b> ..... | Begin modifying a sequence.                                                                                                                                   |
| <b>NEXP</b> .....            | Displays the next page of the operating parameters list.                                                                                                      |
| <b>NOOP</b> .....            | No operation. OPC'able.                                                                                                                                       |
| <b>NUMG[D]</b> .....         | Activates D number of groups of sweeps. A group is whatever is needed to update the current parameter once. This function restarts averaging if on. OPC'able. |
| <b>NUMR[D]</b> .....         | Sets the number of power meter readings per point used during a power meter calibration.                                                                      |

- O -

These commands specify the offset value for the indicated parameter for a standard being defined during a cal kit modification:

|                       |                                                                                                                                                                                                                |
|-----------------------|----------------------------------------------------------------------------------------------------------------------------------------------------------------------------------------------------------------|
| <b>OFSD[D]</b> .....  | Delay offset.                                                                                                                                                                                                  |
| <b>OFSL[D]</b> .....  | Loss offset.                                                                                                                                                                                                   |
| <b>OFSZ[D]</b> .....  | Impedance offset.                                                                                                                                                                                              |
| <b>OMII</b> .....     | Omits the isolation step of a calibration sequence.                                                                                                                                                            |
| <b>OPC</b> .....      | Operation complete. Reports the completion of the next command received by setting bit 0 in the event status register, or by replying to an interrogation if <b>OPC?</b> ; is issued. See General Information. |
| <b>OPEP</b> .....     | Presents a list of key operating parameters. <b>NEXP</b> ; scrolls to the next page of parameters. Requesting a plot or print copies the current page.                                                         |
| <b>OUTPACTI</b> ..... | Outputs the value of the active function, or the last active function if the active entry area is off.                                                                                                         |
| <b>OUTPAPER</b> ..... | Outputs the smoothing aperture in stimulus units, rather than as a percentage.                                                                                                                                 |

These commands output the error correction arrays for the active calibration on the active channel. See Appendix C, Calibration, for the contents of the arrays. Each array comes out in the current output format. They contain real/imaginary pairs, the same number of pairs as points in the sweep.

|                         |    |
|-------------------------|----|
| <b>OUTPCALC01</b> ..... | 1. |
| <b>OUTPCALC02</b> ..... | 2. |
| <b>OUTPCALC03</b> ..... | 3. |
| <b>OUTPCALC04</b> ..... | 4. |
| <b>OUTPCALC05</b> ..... | 5. |

## OUTPCALC06 to OUTPRAW4

Mnemonic Description

OUTPCALC06 .....6.  
OUTPCALC07 .....7.  
OUTPCALC08 .....8.  
OUTPCALC09 .....9.  
OUTPCALC10 .....10.  
OUTPCALC11 .....11.  
OUTPCALC12 .....12.

**OUTPCALK** ..... Outputs the currently active calibration kit, as a less than 1000 byte string. The data is in form 1.

**OUTPDATA** ..... Outputs the error corrected data from the active channel in the current format. See Figure E.1, Processing Chain.

**OUTPERRO** ..... Outputs the oldest error message in the error queue. Sends first the error number, and then the error message itself as a string no longer than 50 characters.

**OUTPFORM** ..... Outputs the formatted display data array from the active channel in the current format. See Figure E.2 for the contents of the array positions as a function of display format.

**OUTPIDEN** ..... Outputs the identification string for the HP 8753B: "HEWLETT  
PACKARD,8753B,0,X.XX" where X.XX is the firmware revision.

**OUTPKEY** ..... Outputs the key code of the last key pressed. An invalid key is reported with a 63, a knob turn with a -1. See Figure E.4 for the front panel key codes.

**OUTPLEAS** ..... Outputs the learn string, which contains the entire front panel state, the limit table, and the list frequency table. It is always in form 1.

These commands output the limit test results. The results consist of four fields. First is the stimulus value for the point. Second is an integer indicating test status. Third is the upper limit at that point. Fourth is the lower limit at that point. If there are no limits at that point, the third and fourth fields are zero. The test status is -1 for no test, 0 for fail, and 1 for pass.

**OUTPLIMF** ..... Outputs the limit test results for each failed point.

**OUTPLIML** ..... Outputs the limit test results for each point in the sweep. This is a form 4 transfer.

**OUTPLIMM** ..... Outputs the limit test results at the marker.

**OUTPMARK** ..... Outputs the marker values. The first two numbers are the marker response values, and the last is the stimulus value. See Figure E.2 for the meaning of the response values as a function of display format.

**OUTPMEMO** ..... Outputs the memory trace from the active channel. The data is in real/imaginary pairs, and can be treated the same as data read with the **OUTPDATA** command.

**OUTPMSTA** ..... Outputs the marker statistics: mean, standard deviation, and peak-to-peak variation in that order. If statistics is not on, it is turned on to generate current values and turned off again.

**OUTPMWID** ..... Outputs the marker bandwidths search results: bandwidth, center, and Q in that order. If widths is not on, it is turned on to generate current values and turned off again.

**OUTPLOT** ..... Outputs the plot string. Can be directed to a plotter, or read into the computer.  
**PSOFT<ON|OFF>** controls whether the soft keys are included in the plot.

These commands output the power meter calibration array. Note the numbers are actually 100\* the source power. A default array is used if a power meter calibration sweep, **TAKCS**, has not been taken:

**OUTPPMCAL1** ..... Channel 1.  
**OUTPPMCAL2** ..... Channel 2.

**OUTPPRIN** ..... Outputs a raster dump of the display, intended for a graphics printer.  
**PSOFT<ON|OFF>** controls whether the soft keys are included in the plot.

These commands output the raw measurement data. See Figure E.1, Processing Chain, for the meaning of the data. Normally, array 1 holds the current parameter. If a 2-port calibration is active, the arrays hold S11, S21, S12, and S22, respectively:

**OUTPRAW1** .....1.  
**OUTPRAW2** .....2.  
**OUTPRAW3** .....3.  
**OUTPRAW4** .....4.

| Mnemonic                      | Description                                                                                                                          |
|-------------------------------|--------------------------------------------------------------------------------------------------------------------------------------|
| <b>OUTPRFFR</b> .....         | Outputs the external source RF frequency. The instrument must be in external source mode, either <b>INSMECSA</b> or <b>INSEXSM</b> . |
| <b>OUTPSEQ&lt;I&gt;</b> ..... | Outputs a sequence listing over HP-IB.                                                                                               |
| <b>OUTPSTAT</b> .....         | Outputs the status byte.                                                                                                             |
| <b>OUTPTITL</b> .....         | Outputs the display title.                                                                                                           |

- P -

|                                  |                                                                                                                                        |
|----------------------------------|----------------------------------------------------------------------------------------------------------------------------------------|
| <b>PAUS</b> .....                | Inserts a pause into a sequence. <b>NEWSEQ&lt;I&gt;</b> must precede to ensure that a sequence is currently being created or modified. |
| <b>PCB</b> .....                 | Same as <b>ADDRCONT</b> . Indicates where control will be passed in pass control mode.                                                 |
| <b>PDATA&lt;ON OFF&gt;</b> ..... | Selects whether trace data is plotted.                                                                                                 |

These commands select the pen for plotting the indicated display feature:

|                                    |                                                                                                                                                        |
|------------------------------------|--------------------------------------------------------------------------------------------------------------------------------------------------------|
| <b>PENNDATA[D]</b> .....           | Data trace.                                                                                                                                            |
| <b>PENNGRAT[D]</b> .....           | Graticule.                                                                                                                                             |
| <b>PENMARK[D]</b> .....            | Markers and marker text.                                                                                                                               |
| <b>PENMEMO[D]</b> .....            | Memory trace.                                                                                                                                          |
| <b>PENNTXT[D]</b> .....            | Text and user graphics.                                                                                                                                |
| <b>PGRAT&lt;ON OFF&gt;</b> .....   | Selects whether the graticule is plotted.                                                                                                              |
| <b>PHAS</b> .....                  | Selects the phase display format.                                                                                                                      |
| <b>PHAO[D]</b> .....               | Sets the phase offset.                                                                                                                                 |
| <b>PLOS&lt;SLOW FAST&gt;</b> ..... | Selects the pen speed for plotting.                                                                                                                    |
| <b>PLOT</b> .....                  | Requests a plot. Requires pass control mode.                                                                                                           |
| <b>PMEM&lt;ON OFF&gt;</b> .....    | Selects whether memory is plotted.                                                                                                                     |
| <b>PMKR&lt;ON OFF&gt;</b> .....    | Selects whether markers are plotted.                                                                                                                   |
| <b>PMTRTTIT</b> .....              | Reads power meter/HP-IB value into title string. <b>NEWSEQ&lt;I&gt;</b> must precede to ensure that a sequence is currently being created or modified. |
| <b>POIN[D]</b> .....               | Sets the number of points in the sweep.                                                                                                                |
| <b>POLA</b> .....                  | Selects the polar display format.                                                                                                                      |

These commands select the marker readout format for polar display:

|                      |                         |
|----------------------|-------------------------|
| <b>POLMLIN</b> ..... | Linear markers.         |
| <b>POLMLOG</b> ..... | Log markers.            |
| <b>POLMRI</b> .....  | Real/imaginary markers. |

**PORE<ON|OFF>** .....

These commands set the port extension length for the indicated port or input. Ports 1 and 2 refer to the test set port(s):

|                                 |                                                                                                                                          |
|---------------------------------|------------------------------------------------------------------------------------------------------------------------------------------|
| <b>PORT1[D]</b> .....           | Port 1.                                                                                                                                  |
| <b>PORT2[D]</b> .....           | Port 2.                                                                                                                                  |
| <b>PORTA[D]</b> .....           | Input A.                                                                                                                                 |
| <b>PORTB[D]</b> .....           | Input B.                                                                                                                                 |
| <b>POWE[D]</b> .....            | Sets the output power level.                                                                                                             |
| <b>POWLFREQ[D]</b> .....        | Selects the frequency for which a power loss correction is entered. This must be followed by a <b>POWLOSS[D]</b> , which sets the value. |
| <b>POWLLIST</b> .....           | Begins editing a power loss list for a power meter calibration.                                                                          |
| <b>POWLOSS[D]</b> .....         | Sets the loss value for a particular frequency, <b>POWLFREQ[D]</b> , in the power loss list.                                             |
| <b>POWM&lt;ON OFF&gt;</b> ..... | Selects whether the HP 436A (on) or the HP 438A (off) is to be used as the power meter in service procedures.                            |
| <b>POWS</b> .....               | Selects power sweep, from the sweep type menu.                                                                                           |
| <b>POWT&lt;ON OFF&gt;</b> ..... | Turning power trip off clears a power trip after an overload condition is detected at one of the input ports.                            |
| <b>PRES</b> .....               | Presets the instrument. OPC'able.                                                                                                        |
| <b>PRINALL</b> .....            | Copies the display on a printer. Requires pass control mode.                                                                             |
| <b>PRINSEQ&lt;I&gt;</b> .....   | Begins printing the sequence selected.                                                                                                   |

**PSOFT<ON|OFF> to RST**

| Mnemonic | Description |
|----------|-------------|
|----------|-------------|

|                                  |                                                                                               |
|----------------------------------|-----------------------------------------------------------------------------------------------|
| <b>PSOFT&lt;ON OFF&gt;</b> ..... | Controls whether softkeys are included in the <b>OUTPLOT</b> ; and <b>OUTPPRIN</b> ; strings. |
| <b>PTEXT&lt;ON OFF&gt;</b> ..... | Selects whether text is plotted.                                                              |

These commands purge the indicated file from disk. Requires pass control.

|                    |    |
|--------------------|----|
| <b>PURG1</b> ..... | 1. |
| <b>PURG2</b> ..... | 2. |
| <b>PURG3</b> ..... | 3. |
| <b>PURG4</b> ..... | 4. |
| <b>PURG5</b> ..... | 5. |

These commands select the type of power meter calibration desired. A calibration sweep should be taken, **TAKCS**, after selecting a "one sweep" power meter calibration, to ensure a valid calibration. No calibration sweep is needed for "each sweep" power meter calibrations. They are all OPC'able:

|                       |             |
|-----------------------|-------------|
| <b>PWMCEACS</b> ..... | Each sweep. |
| <b>PWMCOFF</b> .....  | Off.        |
| <b>PWMCONES</b> ..... | One sweep.  |

|                                    |                                                                                   |
|------------------------------------|-----------------------------------------------------------------------------------|
| <b>PWRLOSS&lt;ON OFF&gt;</b> ..... | Selects whether or not to use the power loss table for a power meter calibration. |
|------------------------------------|-----------------------------------------------------------------------------------|

- R -

|                      |                                                                                                               |
|----------------------|---------------------------------------------------------------------------------------------------------------|
| <b>RAID</b> .....    | Completes the response and isolation cal sequence. OPC'able.                                                  |
| <b>RAISOL</b> .....  | Calls the isolation class for the response and isolation calibration. OPC'able if only one standard in class. |
| <b>RAIRESP</b> ..... | Calls the response class for the response and isolation calibration. OPC'able if only one standard in class.  |
| <b>REAL</b> .....    | Selects the real display format.                                                                              |

These commands recall the indicated internal register. They are all OPC'able:

|                    |    |
|--------------------|----|
| <b>RECA1</b> ..... | 1. |
| <b>RECA2</b> ..... | 2. |
| <b>RECA3</b> ..... | 3. |
| <b>RECA4</b> ..... | 4. |
| <b>RECA5</b> ..... | 5. |

|                       |                                                                                         |
|-----------------------|-----------------------------------------------------------------------------------------|
| <b>REFD</b> .....     | Completes the reflection calibration subsequence of a 2-port calibration. OPC'able.     |
| <b>REFL</b> .....     | Begins the reflection calibration subsequence of a 2-port calibration.                  |
| <b>REFP[D]</b> .....  | Enters the reference position. 0 is the bottom, 10 is the top of the graticule.         |
| <b>REFT</b> .....     | Recall file titles from disc. Requires pass control mode.                               |
| <b>REFV[D]</b> .....  | Enters the reference line value.                                                        |
| <b>RESC</b> .....     | Resume cal sequence.                                                                    |
| <b>RESD</b> .....     | Restores the measurement display after viewing the operating parameters or list values. |
| <b>RESPDONE</b> ..... | Completes the response calibration sequence. OPC'able.                                  |
| <b>REST</b> .....     | Measurement restart.                                                                    |

These commands call the reverse calibration classes, during a full 2-port calibration. They are OPC'able if there is only one standard in the class:

|                   |               |
|-------------------|---------------|
| <b>REVI</b> ..... | Isolation.    |
| <b>REVM</b> ..... | Match.        |
| <b>REVT</b> ..... | Transmission. |

|                   |                                             |
|-------------------|---------------------------------------------|
| <b>RIGL</b> ..... | Selects a plot in the lower right quadrant. |
| <b>RIGU</b> ..... | Selects a plot in the upper right quadrant. |
| <b>RST</b> .....  | Presets the instrument. OPC'able.           |

| Mnemonic | Description |
|----------|-------------|
|----------|-------------|

- S -

These commands select the parameter displayed on the active channel:

S11  
S12  
S21  
S22

**SADD** ..... During either a list frequency or limit table edit, adds a new segment to the table.  
**SAMC<ON|OFF>** ..... Turns sampler correction on and off. Sampler correction is only turned off to take data for custom calibration coefficients.  
**SAV1** ..... Completes the 1-port calibration sequence. OPC'able.  
**SAV2** ..... Completes the 2-port calibration sequence. OPC'able.  
**SAVC** ..... Completes the transfer of error correction coefficients back into the instrument. OPC'able.

These commands store the current instrument state in the indicated internal register. These commands are all OPC'able:

**SAVE1** ..... 1.  
**SAVE2** ..... 2.  
**SAVE3** ..... 3.  
**SAVE4** ..... 4.  
**SAVE5** ..... 5.

**SAVEUSEK** ..... Stores the active calibration kit as the user kit.  
**SCAL[D]** ..... Sets the trace scale factor.  
**SCAP<FULL|GRAT>** ..... Selects a full plot, or a plot where the graticule is expanded to P1 and P2.  
**SDEL** ..... During either a list frequency or a limit table edit, deletes the current segment.  
**SDON** ..... During either a list frequency or a limit table edit, closes a segment after editing.

These commands control the marker searches. The marker searches place the active marker according to the indicated search criteria. The search is continuously updated if tracking is on:

**SEAL** ..... Search left for next occurrence of the target value.  
**SEAMAX** ..... Trace maximum.  
**SEAMIN** ..... Trace minimum.  
**SEAOFF** ..... Turns the marker search off.  
**SEAR** ..... Search right for next occurrence of the target value.  
**SEATARG[D]** ..... Arbitrary target amplitude.  
**SEDI[N]** ..... During either a frequency or a limit table edit, selects segment N for editing.  
**SEQWAIT[D]** ..... Tells the instrument to wait D seconds during a sequence. **NEWSEQ<I>** must precede to ensure that a sequence is currently being created or modified.  
**SETF** ..... Set frequency for low pass transform, option 010.  
**SETZ** ..... Set the characteristic impedance of the measurement system.  
**SHOM** ..... Displays the desired softkey menu during a sequence. **NEWSEQ<I>** must precede to ensure that a sequence is currently being created or modified.  
**SING** ..... Single sweep. OPC'able.  
**SLID** ..... Sliding load done.  
**SLIL** ..... Specifies the standard as a sliding load during a standard definition as part of a cal kit modification.  
**SLIS** ..... Sliding load set.  
**SLOPE[D]** ..... Enters the power slope value.  
**SLOPO<ON|OFF>** ..... Turns the power slope on and off.  
**SMIC** ..... Select Smith chart display format.

The following select the marker readout format on a Smith chart:

**SMIMGB** ..... G+jB.  
**SMIMLIN** ..... Linear.  
**SMIMLOG** ..... Log.  
**SMIMRI** ..... Real/imaginary pairs.  
**SMIMRX** ..... R+jX.

**SMOOAPER[D] to STDD**

|          |             |
|----------|-------------|
| Mnemonic | Description |
|----------|-------------|

**SMOOAPER[D]** ..... Sets the smoothing aperture as a percent of the trace.  
**SMOOO<ON|OFF>** ..... Turns smoothing on and off.

The following commands press the indicated soft key:

**SOFT1** ..... 1.  
**SOFT2** ..... 2.  
**SOFT3** ..... 3.  
**SOFT4** ..... 4.  
**SOFT5** ..... 5.  
**SOFT6** ..... 6.  
**SOFT7** ..... 7.  
**SOFT8** ..... 8.

**SOFR** ..... Displays the firmware revision on the screen.  
**SPAN[D]** ..... Sets the stimulus span. If a list frequency segment is being edited, sets the span of the segment.

The following commands initiate the [**SPECIFY CLASS**] part of modifying a cal kit. After issuing each command, send the HP 8753B a series of standard numbers to be included in the class. When the class is full, send **CLAD;** to terminate the sequence.

**SPECFWDM** ..... Forward match.  
**SPECFWDT** ..... Forward transmission.  
**SPECRESP** ..... Response.  
**SPECRESI** ..... Resp & Isol, response.  
**SPECREVM** ..... Reverse match.  
**SPECREVT** ..... Reverse transmission.  
**SPECS11A** ..... S11A (opens).  
**SPECS11B** ..... S11B (shorts).  
**SPECS11C** ..... S11C (loads).  
**SPECS22A** ..... S22A (opens).  
**SPECS22B** ..... S22B (shorts).  
**SPECS22C** ..... S22C (loads).

**SPLD<ON|OFF>** ..... Turns the split display mode on and off.  
**SRE[D]** ..... Service request enable. A bit set in D enables the corresponding bit in the status byte to generate an SRQ.  
**SSEG[D]** ..... Selects the desired segment of the frequency list for a list frequency sweep.  
**STB?** ..... Outputs the status byte.

The following commands select a standard from a class during a calibration sequence. If a class is requested, as in **CLASS11A** (open, S11 1-port cal,) the HP 8753B will do one of two things. If there is only one standard in the class, it will measure that standard automatically. If there are several standards in the class, then one of the following commands must be used to select one, causing it to be measured. All of these commands are OPCable:

**STANA** ..... Standard listed under softkey 1.  
**STANB** ..... Softkey 2.  
**STANC** ..... Softkey 3.  
**STAND** ..... Softkey 4.  
**STANE** ..... Softkey 5.  
**STANF** ..... Softkey 6.  
**STANG** ..... Softkey 7.

**STAR[D]** ..... Enters the start stimulus value. If a list frequency segment is being edited, sets the start of the segment.  
**STDD** ..... Standard done, define standard sequence, while modifying a cal kit.



Mnemonic Description

The following commands select the standard type after the standard number has been entered during a modify cal kit sequence:

- STDTARBI ..... Arbitrary impedance.
- STDTDELA ..... Delay/thru.
- STDTLOAD ..... Load.
- STDTOPEN ..... Open.
- STDTSHOR ..... Short.

- STPSIZE ..... While editing a list frequency segment, sets step size.
- STOP[D] ..... Sets the stimulus stop value. If a list frequency segment is being edited, sets the stop of the segment.

These commands store the indicated file on disc:

- STOR1 ..... 1.
- STOR2 ..... 2.
- STOR3 ..... 3.
- STOR4 ..... 4.
- STOR5 ..... 5.

- SWET[D] ..... Sets the sweep time.
- SWR ..... Selects the SWR display format.

- T -

- TAKCS ..... Begins a power meter calibration sweep. OPC'able.
- TALKLIST ..... Puts the HP 8753B in talker listener mode.
- TERI[D] ..... Specifies the terminal impedance of an arbitrary impedance standard during a cal kit modification.
- TESS? ..... Returns a one if an HP 85046A/B S-parameter test set is present.
- TIMDTRAN<ON|OFF> ..... Turns the option 010 (time domain) transform on and off.

These commands title the indicated file positions:

- TITF1[\$] ..... 1.
- TITF2[\$] ..... 2.
- TITF3[\$] ..... 3.
- TITF4[\$] ..... 4.
- TITF5[\$] ..... 5.

- TITL[\$] ..... Enters a new CRT title.

These commands title the indicated internal register:

- TITR1[\$] ..... 1.
- TITR2[\$] ..... 2.
- TITR3[\$] ..... 3.
- TITR4[\$] ..... 4.
- TITR5[\$] ..... 5.

- TITSEQ<I> ..... Selects the sequence to be titled.
- TITTMEM ..... Sends the title string to trace memory. **NEWSEQ<I>** must precede to ensure that a sequence is currently being created or modified.
- TITTPMTR ..... Sends the title string to the power meter address. **NEWSEQ<I>** must precede to ensure that a sequence is currently being created or modified.
- TITTPRIN ..... Sends the title string to the printer address. **NEWSEQ<I>** must precede to ensure that a sequence is currently being created or modified.
- TRACK<ON|OFF> ..... Turns marker search tracking on and off.
- TRAD ..... Completes the transmission calibration subsequence of a 2-port calibration. OPC'able.
- TRAN ..... Begins the transmission calibration subsequence of a 2-port calibration.
- TRIG ..... HP-IB trigger. Puts instrument into hold mode.
- TST? ..... Causes a self test and returns a zero if the test is passed.

**TTLOH to WRSK8[\$]**

|          |             |
|----------|-------------|
| Mnemonic | Description |
|----------|-------------|

These commands set the TTL output on the HP 85047A Test Set:

**TTLOH** ..... High.

**TTLOL** ..... Low.

- U -

**UP** ..... Increments the value in the active entry area (up key).

**USEPASC** ..... Puts the HP 8753B in pass control mode.

These commands select the sensor input being used with the HP 438A Power Meter. For the HP 436A or 437B, the A sensor is always used:

**USESENSA** ..... Sensor A.

**USESENSB** ..... Sensor B.

- V -

**VELOFACT[D]** ..... Enters the velocity factor of the transmission medium.

**VOFF[D]** ..... Sets the frequency offset value.

- W -

**WAIT** ..... Waits for a clean sweep. OPCable.

**WAVE** ..... Specifies a waveguide standard while defining a standard as part of a cal kit modification.

**WIDT<ON|OFF>** ..... Turns the bandwidths search on and off.

**WIDV[D]** ..... Enters the widths search parameter.

These commands set the window for the transform (option 010, time domain):

**WINDMAXI** ..... Maximum.

**WINDMINI** ..... Minimum.

**WINDNORM** ..... Normal.

**WINDOW[D]** ..... Enters arbitrary window.

**WINDUSEM<ON|OFF>** ..... Turns the trace memory on as the window shape.

These commands enter new softkey labels into the indicated softkey positions.

**WRSK1[\$]** ..... 1.

**WRSK2[\$]** ..... 2.

**WRSK3[\$]** ..... 3.

**WRSK4[\$]** ..... 4.

**WRSK5[\$]** ..... 5.

**WRSK6[\$]** ..... 6.

**WRSK7[\$]** ..... 7.

**WRSK8[\$]** ..... 8.



For more information  
call your local HP sales office listed  
in the telephone directory white pages.  
Or write to Hewlett-Packard:

**United States:**

Hewlett-Packard  
P.O. Box 10301  
Palo Alto, CA 94303-0890

**Europe:**

Hewlett-Packard  
P.O. Box 999  
1180 AZ Amstelveen, the Netherlands

**Canada:**

Hewlett-Packard Ltd.  
6877 Goreway Drive  
Mississauga, Ontario L4V 1M8

**Japan:**

Yokogawa-Hewlett-Packard Ltd.  
3-29-21, Takaido-Higashi  
Suginami-ku, Tokyo 168

**Elsewhere in the World:**

Hewlett-Packard Intercontinental  
3495 Deer Creek Road  
Palo Alto, Ca 94304



May 1, 1988  
Printed in U.S.A.  
08753-90118

## Network Analyzer Compatibility Guide

For the HP 8510 and 8700 series network analyzers

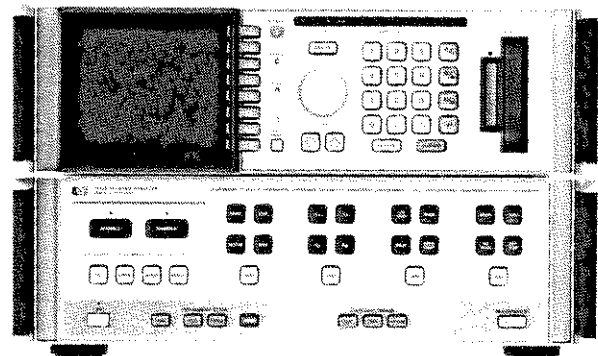
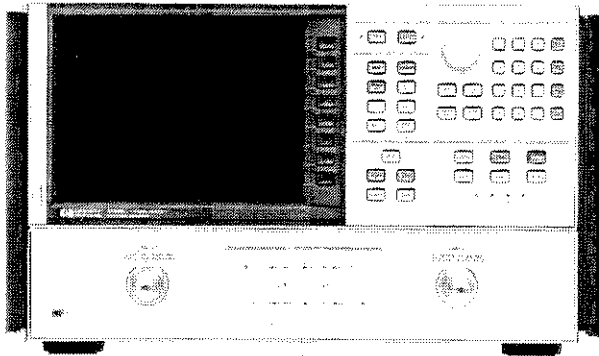

## Introduction

This document is designed for use as a reference when information regarding HP-IB command compatibility between network analyzers in the HP 8510 and HP 8700 series is required. The HP 8700 series network analyzer family consists of the HP 8702A Lightwave Component Analyzer, the HP 8720A Microwave Network Analyzer, and the HP 8753A RF Network Analyzer. *Section 1* gives a brief overview on the similarities and differences in programming the HP 8510 and the HP 8700 series network analyzers. *Section 2* lists alphabetically those commands which are shared by the HP 8510B and the HP 8720A network analyzers and perform the same function. *Section 3* lists alphabetically the HP-IB commands for the HP 8510B, HP 8720A, HP 8753A and HP 8702A, and indicates which commands are valid on each analyzer.

For more complete information HP-IB programming of the respective instruments, consult the following documents:

### HP 8510B:

*Introductory Programming Guide*  
*Operating and Programming Reference*  
*Keyword Dictionary*

HP Lit. No. 5954-1549  
HP Part No. 08510-90070  
HP Part No. 08510-90072

### HP 8720A:

*Introductory Programming Guide*  
*Quick Reference Guide*

HP Part No. 08720-90013  
HP Part No. 08720-90014

### HP 8753A:

*Introductory Operating Guide*  
*Quick Reference Guide*

HP Part No. 08753-90009  
HP Part No. 08753-90011

### HP 8702A:

*Introductory Programming Guide*  
*Quick Reference Guide*

HP Part No. 08702-90012  
HP Part No. 08702-90014

For more information on using HP-IB, the *Tutorial Description of the Hewlett-Packard Interface Bus*

HP Lit. No. 5952-0156

# Section 1:

## Programming the HP 8510 and the HP 8700 series

### Basic instrument control

HP-IB programming of the HP 8510 and HP 8700 series network analyzers is similar in many respects. All of these instruments are programmed using four to eight character HP-IB mnemonics (also known as commands or key-words). About 290 commands are shared by the HP 8510 and HP 8700 series network analyzers, about 295 are valid only on the HP 8510, and 175 are valid only on the HP 8700 series. The HP 8702A Lightwave Component

- 10 ABORT 7 ..... Abort any HP-IB bus activity
- 20 CLEAR 7 16 ..... Clear the analyzer's HP-IB interface.
- 30 OUTPUT 7 16 ; "PRES ; " ..... Preset the analyzer (return to a known state).

Note that the remote (R) and listen (L) HP-IB status indicators should now be lit.

Once the remote status indicator is on, the front panel of the analyzers is disabled. If front panel control is desired, press the [LOCAL] key, and then press the desired front panel key(s). The [LOCAL] key on the HP 8510 and the HP 8700 series analyzers can be locked out using LOCAL LOCKOUT 7. This will completely disable the analyzer's front panel keys. The only way to re-enable the front panel is to issue LOCAL 7, or cycle power.

The basic structure of a typical command is as follows:

```
OUTPUT 7 16 ; "STAR 2 GHZ ; "
```

This command tells the instrument to start the frequency sweep at 2 GHz. The number 716 is the HP-IB address of the HP 8510 or HP 8700 series network analyzer, STAR indicates start frequency, 2 indicates the numeric value of the start frequency, and GHZ gives the units in which the start frequency is specified. The semicolon following GHZ terminates the command.

When operated under computer control, the sequence of events that occur is similar to that which happens when the instruments are operated manually. A typical measurement sequence consists of the following steps:

- 1. Set up the instrument
- 2. Calibrate
- 3. Connect the device
- 4. Take data
- 5. Post process data
- 6. Transfer data

This first chapter will outline the similarities and differences between the HP 8510 and the HP 8700 series in terms of this sequence. Use of plotters, printers, and disc drives, user graphics, and status bytes will also be discussed.

Analyzer uses all of the HP 8753A HP-IB commands, and has approximately 70 additional commands related to the optical measurements that only it can perform. Programming the three instruments of the HP 8700 series is virtually the same in all respects, since all three have the same basic HP-IB hardware and firmware.

The sequence of commands recommended to prepare the HP 8510 and HP 8700 series network analyzer for HP-IB control is as follows:

### Set up the instrument

The HP 8510 and HP 8700 series share most of the basic setup commands (STAR, STOP, POINT, PHAS, S21, and so on). However, instrument states and calibration sets created on one type of instrument cannot be transferred to another. For example, HP 8510 instrument states and calibration data cannot be used on an HP 8720A. The same applies to transfer of instrument states and calibration sets from one HP 8700 series network analyzer to another. Learn strings are also not compatible between the different network analyzers.

Note that the HP 8700 series network analyzers do not have a system bus like the HP 8510 has. In the case of the HP 8753A and 8702A, communication between the receiver/display and test set is handled over the test set interconnect cable, independent of HP-IB operation.

| Default Address | HP 8510 | HP 8700 series |
|-----------------|---------|----------------|
| Analyzer        | 16      | 16             |
| Plotter         | 05      | 05             |
| Printer         | 01      | 01             |
| Disc drive      | 00      | 00             |
| System bus      | 17      | —              |
| Display         | 31      | 17             |

These are the default, factory set HP-IB addresses. To check the address of the HP 8510, press [LOCAL] [ADDRESS of HP 8510] on the instrument's keyboard. To check the address of the HP 8700 series network analyzers, press [LOCAL] [SET ADDRESSES] [ADDRESS:87nn]. If the address has changed, it can be reset to 16 by entering [1][6][x1] on the instrument's keyboard.

## Sweep modes

In terms of measurement method, the HP 8510 can be operated in either ramp sweep, step sweep, single point, or frequency list mode. In ramp sweep mode, the HP 8510 source (HP 8350/835XX or HP 8340/41) performs an analog sweep over the frequency range of interest. In the step sweep mode (HP 8340/41 only), the source is phase-locked at each frequency, and is rapidly stepped from one frequency to the next. The HP 8700 series instruments operate only in the stepped sweep, single point, or list frequency modes. They do not have a ramp sweep mode. The HP 8510 ramp sweep mode is turned on with the command **RAMP**, and stepped sweep mode is activated with **STEP**. The default sweep mode (after instrument preset) is ramp sweep with the HP 8510, and stepped sweep with the HP 8700 series.

The HP 8510 and HP 8700 series both can operate in the frequency list mode, and this mode is activated with **L I SFREQ**, assuming a list frequency table has already been created. The HP 8720A has the ability to sweep specific, single segments from a frequency list. The HP 8510B with Revision 4.0 firmware also has this capability. To sweep a single segment, use **SSEGn** where **n** is the segment number. To return to normal list frequency operation (sweep all list frequency segments), issue **ASEG**.

On the HP 8510, single frequency (CW) operation is accessed with **SINP**, followed by **CENT xx GHZ**; where **xx** is the desired CW frequency. With the HP 8700 series, use **CWFREQ xx GHZ**;

## Averaging

When averaging is desired, it can be turned on with **AVERON**, with the HP 8510 and the HP8700 series analyzers. To specify an averaging factor, use **AVERON xx** for the HP 8510, where **xx** is the averaging factor (1 to 4096). With the HP 8700 series analyzers, an averaging factor can be specified using **AVERFACT xx**, where **xx** is the averaging factor (1 to 999). The universal command **AVEROFF** is used to turn off averaging.

When averaging is used with the HP 8700 series, as many groups of sweeps are executed as the value of the averaging factor plus 1 during calibration and measurement before a valid data trace is ready. The same applies to the HP 8510 when it is operating in ramp sweep mode. In the step sweep mode, the HP 8510 takes multiple readings (number of samples equals the averaging factor) at each frequency step before moving on to the next frequency. Averaging can be restarted with **REST** on the HP 8510 and the HP 8700 series analyzers.

## Calibration

The HP 8510 and HP 8700 series network analyzers share many of the calibration commands. However, some of the calibration types that are possible on the HP 8510 are not available with the HP 8700 series. The following table shows the cal types available with the different analyzers:

| Calibration Type     | HP<br>8510B | HP<br>8720A | HP<br>8753A | HP<br>8702A |
|----------------------|-------------|-------------|-------------|-------------|
| Response             | X           | X           | X           | X           |
| Response & isolation | X           | X           | X           | X           |
| S11 1-port           | X           | X           | X           | X           |
| S22 1-port           | X           | X           | X           | X           |
| One-path 2-port      | X           |             | X           |             |
| Full 2-port          | X           | X           | X           | X           |
| TRL 2-port           | X           |             |             |             |
| Non-insertable       | X           |             |             |             |
| Optical calibrations |             |             |             | X           |

## Calibration sets

The HP 8510 can store two calibration kits internally (these are usually loaded from tape). These cal kits are activated with the commands **CAL 1** and **CAL 2**. The **CAL 1** command specifies cal kit 1 with the HP 8510; it performs no function with the HP 8700 series but is accepted for compatibility with the HP 8510. **CAL 2** is not accepted by the HP 8700 series. The HP 8700 series contain three or more internal kits: 3.5 mm, 7 mm, and type-N 50 ohm in the case of the HP 8720A. When using the HP 8700 series analyzers, a specific cal kit is chosen by issuing a command such as **CALK35MM** (3.5 mm calibration kit). This is the main difference between the HP 8510 and the HP 8700 series analyzers in terms of initiating a calibration.

Once the calibration kit to be used has been identified, the calibration sequences are generally the same for all of the analyzers. The sequence is started with a command such as **CAL IRESP**, **CAL IS111**, **CAL IFUL2**, etc. to specify the calibration type. The next step is to open a class with a command such as **CLASS 11A**. This will measure the open connected at port 1 if there is only one open in the class. If there is more than one standard in the class (for example, there are two standards in the type-N 50 ohm class of opens), the specific standard is chosen with the command **STANx**, where **x** can be A thru G. For example, **STANA** causes the standard selected with the top softkey (softkey 1) during manual operation to be measured.

It is necessary to ensure that the measurement of the standard is completed before the program prompts for connection of the next standard, and there are different techniques that must be used with the HP 8510 and the HP 8700 series. With the HP 8510, use a subroutine which serial polls bit 4 of the status byte to determine when the sweep(s) are completed. (Refer to Example 7, *Calibrating over the HP-IB*, in the HP 8510 *Introductory Programming Guide*). With the HP 8700 series, the `DPC?` command is used prior to issuing the class command. For more information on calibrating the HP 8700 series analyzers over HP-IB, refer to the appropriate examples on calibration in their programming guides.

To conclude the calibration sequence on the HP 8510 and the HP 8700 series analyzers, issue `SAV1` or `SAV2` in the case of 1-port or 2-port calibrations respectively. With the HP 8510, follow with `CALS $n$` , which stores the calibration and the stimulus settings into Cal Set  $n$  ( $n$  can be from 1 to 8). With the HP 8700 series, error-correction is automatically activated when the calibration is completed. To save a calibration with the HP 8700 series analyzers, issue `SAVE $n$`  which will store the calibration coefficients, along with the current instrument state into register  $n$  ( $n$  can be from 1 to 5). It is important to note that in the HP 8510, calibration sets are not recalled when the instrument states are recalled. They are stored separately and must be activated after the desired instrument state has been recalled. With the HP 8700 series, calibrations are a part of the instrument state, and are recalled automatically when the instrument state is recalled.

### Calibration error coefficients

The actual calibration error coefficients can be read from the HP 8510 and HP 8700 series analyzers with the `OUTPCALC $nn$`  command, where  $nn$  is the coefficient number (1 to 12). Use `INPUCALC $nn$`  to input calibration coefficients. These coefficients are arrayed identically in the HP 8510 and HP 8700 series analyzers.

### Taking Data

Once the device under test is connected to the analyzer, a completely fresh sweep must be triggered to ensure valid data is taken. This is accomplished with all four instruments using the command `SING`. This command activates a single group of sweeps. If a full 2-port calibration is active, a group is four sweeps, so that all four S-parameters can be measured. `SING` automatically forces four sweeps if a full two-port calibration is active. In the HP 8510 step sweep mode, all four S-parameters are measured at each frequency step, so only one sweep is performed. After this command, the analyzer goes into hold mode (sweeping is stopped).

If more groups of sweeps are desired, issue the command `NUMG $n$` , where  $n$  is the desired number of groups. A case where `NUMG $n$`  might be used is when averaging is turned on, in which case  $n$  would be 1 plus the averaging factor. `NUMG $n$`  is valid on both the HP 8510 and the HP 8700 series analyzers. Note that `NUMG1` is equivalent to `SING`. With the HP 8700 series, the `SING` and `NUMG $n$`  commands can be prefaced with `DPC?`, and followed by `ENTER 716; Reply`. This will ensure that the program waits for the sweeps to complete before continuing. Refer to the HP 8700 series analyzers's programming guides for more information about `DPC`. When used with the HP 8510, `SING` and `NUMG $n$`  force a hold off of all further HP 8510 HP-IB command processing, but to prevent the program from executing other commands (such as those for generating prompts), a subroutine is required which polls bit 4 of the status byte when the sweep is finished. Refer to Example 7 in the HP 8510 *Introductory Programming Guide* for more information.

### Post processing data

After the device has been measured, the data can be processed. Post-processing is performed within the analyzers and includes such operations as the application of smoothing, time domain gating, etc. The commands to perform these operation are shared by the HP 8510 and the HP 8700 series network analyzers. For example, smoothing is turned on with `SMOON`, and is turned off with `SMOOF`. To set the smoothing aperture on the HP 8510, use `SMOON XX`, where  $XX$  is the desired smoothing aperture in percent. With the HP 8700 series, use `SMOAPER XX` to set the smoothing aperture  $XX$  in percent. To activate a time domain gate, use `GATEON`. Gating can be turned off with `GATEOFF`.

### Transferring Data

After the device has been measured, and any desired post-processing applied, the data can be transferred to the computer for further analysis and storage. Data transfer is initiated with commands such as `OUTPRAW $n$` , `OUTPDATA`, `OUTPFORM`, `OUTPMARK`. To transfer data without post-processing applied, use `OUTPDATA`. To include post-processing, use `OUTPFORM`. Most of the data output commands are shared by the HP 8510 and the HP 8700 series network analyzers.



## Data levels

Formatted measurement data can be read out in log or linear magnitude, phase, real/imaginary pair formats with `OUTPFORM`. The format is a function of the format in which data is currently being presented on the analyzer's display. The formats are identical between the HP 8510 and HP 8700 series. Data which is read by the computer using `OUTPFORM` will reflect all post processing such as time domain gating, electrical delay, trace math and smoothing.

Raw data is accessible with `OUTPRAW1`, `OUTPRAW2`, `OUTPRAW3`, `OUTPRAW4`. Normally, only raw 1 is available, and it holds the current parameter. If a full 2-port calibration is in effect, the four arrays refer to `S11`, `S21`, `S12`, and `S22` respectively. The data will be in real/imaginary pairs.

Error corrected data is the raw data with error correction applied. It can be read with `OUTPDATA`. The array is for the currently measured parameter, and is in real/imaginary pairs. `OUTPMEM0` reads the trace memory if available. Note that this data does not reflect any post processing such as electrical delay offset, trace math, or time domain gating.

## Data transfer formats

The HP 8510 and HP 8700 series network analyzers share the same four data transfer formats. These formats are chosen with the commands `FORM1`, `FORM2`, `FORM3`, and `FORM4`. Prior to transfer of data, it is imperative that the receiving arrays be dimensioned to the right number of data points. Refer to the appropriate examples in the instrument's *Introductory Programming Guides* for examples on data transfers using the various formats.

## Other data types

Limit test data and trace statistics can be obtained only from the HP 8700 series network analyzers with commands such as `OUTPLIML`, `OUTPLIMM`, `OUTPLIMF`, for limit data, and `OUTPMSTA` for trace statistics.

Learn strings can be obtained from the HP 8510 and HP 8700 series analyzers with `OUTPLEAS`, and can be read into the analyzers from the computer with `INPULEAS`. For the HP 8510 learn string, the receive array for the learn string should be declared as an integer array of 2195 elements with

```
10 INTEGER P, B, Learn_string(1:2195)
20 OUTPUT 716; ' 'OUTPLEAS;
30 ENTER 716 USING "W"; P; B; Learn_string(*)
```

`Learn_string` is the variable which will contain the learn string. `P` and `B` are integer variables which contain the learn string preamble and the number of bytes respectively. To read the learn string back into the HP 8510, use

```
40 OUTPUT 716; "INPULEAS; "
50 OUTPUT 716 USING
"W"; 9025; 3400; Learn_string(*)
```

To read the learn string from an HP 8700 series network analyzer, use

```
10 DIM Learn_string$[3000]
20 OUTPUT 716; "OUTPLEAS; "
30 ENTER 716 USING "-K"; Learn_string$
```

To input a learn string into an HP 8700 series network analyzer, use

```
40 OUTPUT 716; "INPULEAS"; Learn_string$
```

## Using plotters, printers, and disc drives

Access to peripherals from the computer when using the HP 8510 is different than the HP 8700 series analyzers are used. The following section discusses the differences in peripheral control between the HP 8510 and the HP 8700 series.

Plotters, printers and disc drives used with the HP 8510 are connected to the system bus, which is separate from the HP 8510 HP-IB. This way, the HP 8510 has direct control over the peripherals. This allows plots to be made from the HP 8510 relatively easily, since the computer is on a different bus. To tell the HP 8510 to make a plot on a plotter on the system bus, issue `PLOTALL`. To make a plot on a plotter connected to the HP-IB, issue `OUTPLOT`. To obtain a tabular listing of the trace data values and frequencies of the active channel on a printer connected to the system bus, use `LIST`. To have computer access to these peripherals on the HP 8510 system bus, the pass-thru mode is used to transfer the computer's commands over from the HP-IB.

## Pass-thru on the HP 8510

With the peripherals on the system bus, the only way the computer (controller) can obtain direct access to them is by using the pass-thru mode. In pass-thru mode, commands are routed through the HP 8510 processor from the HP-IB to the system bus.

In order to use the pass-thru mode, two addresses must be set. The address the computer will talk to is the System bus address (normally 17), and it is specified with **ADDRSYSB**. The address of the device on the system bus is the pass-thru address, and is specified with **ADDRPASS**. For example, if the plotter on the system bus is at address 05 and it is desired to make a plot from the computer, use **ADDSYSB 17; ADDRPASS 05;**. This will allow the computer direct access to the plotter with the command **OUTPUT 717; "HPGL"**.

Note that the computer cannot control a disc drive on the HP 8510 system bus, because disc drive operation requires two-way handshaking. Thus, a second disc drive which is connected to the HP-IB is recommended.

### Peripheral control on the HP 8700 series

The HP 8700 series network analyzers do not have a system bus, and so peripherals are connected to the HP-IB bus and the computer has direct access to these peripherals always. However, analyzer access to these peripherals is sometimes necessary, as when making a plot of measurement data.

Thus the computer must relinquish active control of the HP-IB and allow the analyzer to become the active con-

troller, so in essence what is needed is a pass-thru capability whereby the analyzer can temporarily assume control of the HP-IB. This can be accomplished as follows.

The HP 8700 series has three operating modes with respect to HP-IB, as set under the LOCAL menu which is accessible via the [LOCAL] key. *System controller* mode is used when no computer is present. In this mode, the analyzer has full control over all peripherals on the HP-IB. The other two modes are used when a computer is on the HP-IB. *Talker/listener* mode allows the analyzer a one-way communication path to plotters and printers. *Pass control* mode allows the computer to pass active control of the peripherals to the analyzer, so that the analyzer can plot, print, or access the disc drive, and these peripherals can talk back to the analyzer. For disc drive operation, the pass control mode **MUST** be used, since two-way communication between the analyzer and the disc drive is required. For most plotting and printing operations, talker/listener mode is the easiest to use.

The HP 8700 series analyzers assume that the address of the computer is correctly stored in its HP-IB addresses menu under the [ADDRESS: CONTROLLER] entry. If this address is not correct, control will not return to the computer when the instrument is finished using the peripheral.

### HP 8700 series analyzer talker/listener mode

If it is desired to make plots or printouts from the analyzer in talker/listener mode, the commands **OUTPLOT** and **OUTPRIN** can be used. Talker/listener mode allows only one-way communication between the analyzer and

the peripheral, so error conditions such as no paper in the plotter cannot be detected by the analyzer. The following program shows how to generate a plot in talker/listener mode.

```

10 OUTPUT 716; "OUTPLOT; " Command the analyzer to plot.
20 SEND 7; UNL LISTEN 5 TALK 16 DATA Establish a data path from the analyzer to the
 plotter.
30 DISP "PLOTING"
40 STATUS 7, 7; Stat Wait for the analyzer to assert the EOI line,
 indicating the end of transmission.
50 IF NOT BIT(Stat, 11) THEN GOTO 40 If bit 11 is not set, the the EOI line is not being
 asserted by the analyzer, so loop and check
 again.

60 DISP "DONE"
70 END

```

## HP 8700 series analyzer pass control mode

Pass control mode allows two-way communication between the analyzer and the peripheral being accessed. While the analyzer is in this mode, it is free to address devices to talk and listen as needed. This allows the analyzer to send messages as well as read replies back from

printers, plotters, and disc drives. Use `PRINALL` to generate printouts of the analyzer display, `PLOT` for plots. `LISV` can be used to obtain tabular listings on a printer of trace values and frequencies. The following program gives an example.

```
10 OUTPUT 716;"CLES;ESE2;" Clear the status reporting system, and enable
 the Request Active Control bit in the event
 status register.
20 OUTPUT 716;"USEPASC;PRINALL;" Put the analyzer in pass control mode, and
 request a printer dump of the analyzer's
 display.
30 Stat=SPOLL(716) Get the status byte.
40 IF NOT BIT(Stat,5) THEN GOTO 30 If the analyzer is not requesting control, loop
 and wait.
50 SEND 7;TALK 16 CMD 9 Pass active control to device 16.
60 DISP "PRINTING"
70 STATUS 7,6;Hpib Load the interface 7 (HP-IB) register 6 into the
 variable Hpib. Bit 6 indicates whether or not
 the computer is the active controller.
80 IF NOT BIT(Hpib,6) THEN GOTO 70 If control has not returned, loop and wait.
90 DISP "DONE"
100 END
```

## User graphics

The screens of the HP 8510 and the HP 8700 series network analyzers can be written to as if they were a plotter using either a subset of the HP-GL commands, or all the HP-GL commands. This allows the operator to draw lines or text directly on the analyzer screen, for example when showing hookup diagrams.

With the HP 8510, plotting instructions are written to the system bus address after the pass-thru address is set to 31 (the default address of the display). The HP 8510 behaves as if the display were an external device hooked to the system bus at address 31. Plotting data must be scaled to the HP 8510 display coordinates ( $0 < X < 4095$  and  $0 < Y < 4095$ ). Send `ADDRSYSB 17; ADDRPASS 31`; to allow the computer to write HP-GL subset graphic commands such as `OUTPUT 717;"PG;"` to the screen. To use full HP-GL, send `ADDRPASS 31` followed by `PLOTTER IS 717,"HPGL"` to allow commands such as `DRAW`, `FRAME`, and so on. For more information on HP 8510 user graphics, refer to Example 10, *User Graphics*, in the HP 8510 *Introductory Programming Guide*.

With the HP 8700 series, plotting instructions are written to HP-IB address 17 (the default address of the display). Plotting data must be scaled to the HP 8700 series analyzer's display coordinates ( $0 < X < 5850$  and  $0 < Y < 4095$ ). To use the HP-GL subset (commands such as `PG`, `PU`, and so on), use `OUTPUT 717;"..."` where `...` is the desired sequence of commands. To write to the analyzer display with full access to HP-GL commands (commands such as `DRAW`, `FRAME` and so on), issue `PLOTTER IS 717,"HPGL"`. For more information on HP 8700 series, refer to the appropriate examples in their programming guides or appendices in their reference guides.

## Using the instrument status bytes

There are substantial differences between the status reporting mechanisms of the HP 8510 and the HP 8700 series. The HP 8510 has two status bytes, the primary status byte (#1) and the extended status byte (#2). The primary status byte can be read using `SPOLL(716)`. To read both status bytes simultaneously, use `OUTPSTAT`; followed by `ENTER 716; S1, S2` where `S1` and `S2` are two integer variables to contain the status bytes. Once the status byte(s) has been read into an integer variable, check the values of specific bits within the status byte(s) using `BIT(XX, n)` where `XX` is the status byte (`S1` or `S2`) and `n` is the bit to be checked. For an example on reading the HP 8510 front panel using the status byte, refer to Example 11 in the HP 8510 *Introductory Programming Guide*.

The HP 8700 series analyzers have one status byte, and two event status registers. The status byte can be read using `SPOLL(716)` or `OUTPSTAT`. The event status register can be read with `ESR?` and event status register B can be read with `ESB?`. Bits 2 and 5 of the status byte indicate the condition of the event status registers and can be checked using `BIT(XX, n)` where `XX` is the variable containing the status byte, and `n` is either 2 or 5, depending on which event status register is to be checked. The event status register is summarized by bit 5, and event status register B is summarized by bit 2. The event status registers can be used to determine if keypresses, limit test failures, marker search failures or errors have occurred. For more information regarding the HP 8700 series analyzers' status bytes and event status registers, consult the limit testing and user interface examples in their programming guides and appendices on status reporting in their quick reference guides.

## Section 2: Commands Common to Both the HP 8510B and HP 8720A

This section lists the HP-IB commands that can be used on both the HP 8510B and the HP 8720A to perform the same functions. The listing is set up as follows:

**COMMAND** Description

The left column gives the HP-IB mnemonic, and the right column gives a brief description of the function that the command performs. For more specific information about these commands refer to the documentation listed earlier.

| <b>COMMAND</b>  | <b>Description</b>                                      |
|-----------------|---------------------------------------------------------|
| <b>ADDRDISC</b> | Disc address.                                           |
| <b>ADDRPLOT</b> | Plotter address.                                        |
| <b>ADDRPRIN</b> | Printer address.                                        |
| <b>ASEG</b>     | Sweep all segments in frequency list mode. <sup>1</sup> |
| <b>AUTO</b>     | Auto scale.                                             |
| <b>AVEROFF</b>  | Averaging off.                                          |
| <b>AVERON</b>   | Averaging on.                                           |
| <b>AVER?</b>    | Query averaging on/off.                                 |
| <b>C0</b>       | Define open circuit capacitance values.                 |
| <b>C1</b>       | "                                                       |
| <b>C2</b>       | "                                                       |
| <b>C3</b>       | "                                                       |
| <b>CAL1</b>     | Begin cal sequence with cal kit 1.                      |
| <b>CALIFUL2</b> | Select full 2-port calibration.                         |
| <b>CALIRAI</b>  | Select response & isolation calibration.                |
| <b>CALIRESP</b> | Select response calibration.                            |
| <b>CALIS111</b> | Select S11 1-port calibration.                          |
| <b>CALIS221</b> | Select S22 1-port calibration.                          |
| <b>CENT</b>     | Set center stimulus value (frequency or time).          |
| <b>CHAN1</b>    | Channel 1 active channel.                               |
| <b>CHAN2</b>    | Channel 2 active channel.                               |
| <b>CLAD</b>     | Class done.                                             |
| <b>CLASS11A</b> | S11A: S11 opens.                                        |
| <b>CLASS11B</b> | S11A: S11 shorts.                                       |
| <b>CLASS11C</b> | S11A: S11 loads.                                        |
| <b>CLASS22A</b> | S22A: S22 opens.                                        |
| <b>CLASS22B</b> | S22A: S22 shorts.                                       |
| <b>CLASS22C</b> | S22A: S22 loads.                                        |
| <b>CLES</b>     | Clear status, event status, and enable registers.       |
| <b>COAX</b>     | Select coaxial offsets, modify cal kit.                 |
| <b>CONT</b>     | Continual sweep trigger mode.                           |
| <b>CORROFF</b>  | Error correction off.                                   |
| <b>CORRON</b>   | Error correction on.                                    |
| <b>CORR?</b>    | Query correction on/off.                                |
| <b>CWFREQ</b>   | Set CW frequency in frequency list mode.                |

1. HP 8510B Rev. 4.0 and higher only.

| COMMAND         | Description                                                 |
|-----------------|-------------------------------------------------------------|
| <b>DATI</b>     | Store trace data into memory.                               |
| <b>DEBUOFF</b>  | HP-IB debug mode off.                                       |
| <b>DEBUON</b>   | HP-IB debug mode on.                                        |
| <b>DEFS</b>     | Begin standard definition, modify cal kit.                  |
| <b>DELA</b>     | Display data in group delay format.                         |
| <b>DELO</b>     | Delta marker mode off.                                      |
| <b>DELR1</b>    | Delta reference marker.                                     |
| <b>DELR2</b>    | "                                                           |
| <b>DELR3</b>    | "                                                           |
| <b>DELR4</b>    | "                                                           |
| <b>DISCUNIT</b> | Specify disc unit number.                                   |
| <b>DISPDATA</b> | Display data only.                                          |
| <b>DISPDATM</b> | Display data and memory.                                    |
| <b>DISPMEMO</b> | Display memory only.                                        |
| <b>DIVI</b>     | Display data divided by memory.                             |
| <b>DONE</b>     | Class done, modify cal kit.                                 |
| <b>DOWN</b>     | Down step key.                                              |
| <b>EDITDONE</b> | Done with list edit.                                        |
| <b>EDITLIST</b> | Begin edit of frequency list table.                         |
| <b>ELED</b>     | Electrical delay under RESPONSE.                            |
| <b>ENTO</b>     | Entry off.                                                  |
| <b>FIXE</b>     | Specify fixed load standard type.                           |
| <b>FORM1</b>    | Data transfer: internal 6 byte binary format.               |
| <b>FORM2</b>    | Data transfer: IEEE 8 byte floating point format.           |
| <b>FORM3</b>    | Data transfer: IEEE 16 byte floating point format.          |
| <b>FORM4</b>    | Data transfer: ASCII format.                                |
| <b>FREQ</b>     | Frequency annotation off.                                   |
| <b>FRER</b>     | Select continual sweep (HP-IB free run) after <b>TRIG</b> . |
| <b>FULP</b>     | Select full page plot under COPY.                           |
| <b>FWDI</b>     | Forward isolation standard, modify cal kit.                 |
| <b>FWDM</b>     | Forward match standard, modify cal kit.                     |
| <b>FWDT</b>     | Forward transmission standard, modify cal kit.              |
| <b>GATE?</b>    | Query gating on/off.                                        |
| <b>GATECENT</b> | Specify center time of time domain gate.                    |
| <b>GATEOFF</b>  | Gating off.                                                 |
| <b>GATEON</b>   | Gating on.                                                  |
| <b>GATESPAN</b> | Specify span time of time domain gate.                      |
| <b>GATESTAR</b> | Specify start time of time domain gate.                     |
| <b>GATESTOP</b> | Specify stop time of time domain gate.                      |
| <b>GATSMAXI</b> | Gate shape maximum.                                         |
| <b>GATSMINI</b> | Gate shape minimum.                                         |
| <b>GATSNORM</b> | Gate shape normal.                                          |
| <b>GATSWIDE</b> | Gate shape wide.                                            |

| COMMAND           | Description                                |
|-------------------|--------------------------------------------|
| <b>HOLD</b>       | Hold sweep (sweep trigger in hold mode).   |
| <b>INID</b>       | Initialize disc media.                     |
| <b>INPUCALC01</b> | Input calibration coefficient data arrays. |
| <b>INPUCALC02</b> | "                                          |
| <b>INPUCALC03</b> | "                                          |
| <b>INPUCALC04</b> | "                                          |
| <b>INPUCALC05</b> | "                                          |
| <b>INPUCALC06</b> | "                                          |
| <b>INPUCALC07</b> | "                                          |
| <b>INPUCALC08</b> | "                                          |
| <b>INPUCALC09</b> | "                                          |
| <b>INPUCALC10</b> | "                                          |
| <b>INPUCALC11</b> | "                                          |
| <b>INPUCALC12</b> | "                                          |
| <b>INPU DATA</b>  | Input error corrected data array.          |
| <b>INPUFORM</b>   | Input formatted data array.                |
| <b>INPULEAS</b>   | Input learn string.                        |
| <b>INPURAW1</b>   | Input raw data array.                      |
| <b>INPURAW2</b>   | "                                          |
| <b>INPURAW3</b>   | "                                          |
| <b>INPURAW4</b>   | "                                          |
| <b>ISOD</b>       | Isolation done, full 2-port cal.           |
| <b>ISOL</b>       | Begin isolation, full 2-port cal.          |
| <b>KITD</b>       | Cal kit definition done, modify cal kit.   |
| <b>LABEFWDM</b>   | Label class forward match.                 |
| <b>LABEFWDT</b>   | Label class forward transmission.          |
| <b>LABERESP</b>   | Label class response.                      |
| <b>LABEREVM</b>   | Label class reverse match.                 |
| <b>LABEREVT</b>   | Label class reverse transmission.          |
| <b>LABES11A</b>   | Label class S11A: opens.                   |
| <b>LABES11B</b>   | Label class S11B: shorts.                  |
| <b>LABES11C</b>   | Label class S11C: loads.                   |
| <b>LABES22A</b>   | Label class S22A: opens.                   |
| <b>LABES22B</b>   | Label class S22B: shorts.                  |
| <b>LABES22C</b>   | Label class S22C: loads.                   |
| <b>LABK</b>       | Label cal kit, modify cal kit.             |
| <b>LABS</b>       | Label standard, modify cal kit.            |
| <b>LEFL</b>       | Left lower quadrant plot.                  |
| <b>LEFU</b>       | Left upper quadrant plot.                  |
| <b>LINM</b>       | Display data in linear magnitude format.   |
| <b>LISFREQ</b>    | Enable list frequency mode.                |
| <b>LOGM</b>       | Display data in log magnitude format.      |
| <b>LOWPIMPU</b>   | Low pass impulse time domain.              |
| <b>LOWPSTEP</b>   | Low pass step time domain.                 |

| COMMAND    | Description                                                   |
|------------|---------------------------------------------------------------|
| MARK1      | Marker 1 active.                                              |
| MARK2      | "                                                             |
| MARK3      | "                                                             |
| MARK4      | "                                                             |
| MARKCONT   | Markers in continuous mode.                                   |
| MARKDISC   | Markers in discrete mode.                                     |
| MARKMAXI   | Marker to maximum.                                            |
| MARKMINI   | Marker to minimum.                                            |
| MARKOFF    | Turn all markers and marker functions off.                    |
| MAXF       | Specify max frequency of cal standard, modify cal kit.        |
| MENUCAL    | CAL key menu.                                                 |
| MENUCOPY   | COPY key menu.                                                |
| MENUDISP   | DISPLAY key menu.                                             |
| MENUFORM   | FORMAT key menu.                                              |
| MENUMARK   | MKR key menu                                                  |
| MENUOFF    | Turn off soft key labels.                                     |
| MENUON     | Menu on.                                                      |
| MENURECA   | RECALL key menu.                                              |
| MENUSAVE   | SAVE key menu.                                                |
| MENUSTIM   | Stimulus MENU key.                                            |
| MENUSYST   | SYSTEM key menu.                                              |
| MINF       | Specify min frequency of cal standard, modify cal kit.        |
| MINU       | Display DATA minus memory.                                    |
| MOD11      | Begin modify cal kit sequence.                                |
| NEXP       | Next page op parameters (HP 8720A), tape directory (HP 8510). |
| NUMG       | Specify number of groups of sweeps.                           |
| OMII       | Omit isolation under CAL.                                     |
| OPEP       | Display operating parameters.                                 |
| OUTPACTI   | Output active function.                                       |
| OUTPCALC01 | Output calibration coefficient.                               |
| OUTPCALC02 | "                                                             |
| OUTPCALC03 | "                                                             |
| OUTPCALC04 | "                                                             |
| OUTPCALC05 | "                                                             |
| OUTPCALC06 | "                                                             |
| OUTPCALC07 | "                                                             |
| OUTPCALC08 | "                                                             |
| OUTPCALC09 | "                                                             |
| OUTPCALC10 | "                                                             |
| OUTPCALC11 | "                                                             |
| OUTPCALC12 | "                                                             |
| OUTPDATA   | Output error corrected data array.                            |
| OUTPERRO   | Output error number, string.                                  |
| OUTPFORM   | Output formatted array.                                       |
| OUTPIDEN   | Output identification string.                                 |
| OUTPKEY    | Output key code.                                              |

| COMMAND         | Description                                     |
|-----------------|-------------------------------------------------|
| <b>OUTPLEAS</b> | Output learn string.                            |
| <b>OUTPMARK</b> | Output marker value.                            |
| <b>OUTPMEMO</b> | Output memory trace if on.                      |
| <b>OUTPPLOT</b> | Output HP-GL plot string.                       |
| <b>OUTPRAW1</b> | Output raw array.                               |
| <b>OUTPRAW2</b> | "                                               |
| <b>OUTPRAW3</b> | "                                               |
| <b>OUTPRAW4</b> | "                                               |
| <b>OUTPSTAT</b> | Output status byte.                             |
| <b>OUTPTITL</b> | Output of last title.                           |
| <b>PHAO</b>     | Phase offset.                                   |
| <b>PHAS</b>     | Display data in phase format.                   |
| <b>POIN</b>     | Set the number of points.                       |
| <b>POIN?</b>    | Query number of points.                         |
| <b>PORT1</b>    | Set port 1 extension length.                    |
| <b>PORT2</b>    | Set port 2 extension length.                    |
| <b>POWE</b>     | Specify source power.                           |
| <b>PRES</b>     | Instrument preset.                              |
| <b>RAID</b>     | Response & isolation calibration done.          |
| <b>RAISOL</b>   | Call isolation class, response & isolation cal. |
| <b>RAIRESP</b>  | Call response class, response & isolation cal.  |
| <b>REAL</b>     | Display data in real format.                    |
| <b>RECA1</b>    | Recall from internal registers.                 |
| <b>RECA2</b>    | "                                               |
| <b>RECA3</b>    | "                                               |
| <b>RECA4</b>    | "                                               |
| <b>RECA5</b>    | "                                               |
| <b>REFD</b>     | Reflection done, full 2-port calibration.       |
| <b>REFL</b>     | Begin reflection, full 2-port calibration.      |
| <b>REFP</b>     | Reference position.                             |
| <b>REFV</b>     | Reference value (level).                        |
| <b>RESC</b>     | Resume cal sequence.                            |
| <b>RESD</b>     | Restore display after                           |
| <b>OPEP.</b>    |                                                 |
| <b>REST</b>     | Measurement restart.                            |
| <b>REVI</b>     | Reverse isolation class, full 2-port cal.       |
| <b>REVM</b>     | Reverse match class, full 2-port cal.           |
| <b>REVT</b>     | Reverse transmission class, full 2-port cal.    |
| <b>RIGL</b>     | Right lower quadrant plot.                      |
| <b>RIGU</b>     | Right upper quadrant plot.                      |



| COMMAND         | Description                                |
|-----------------|--------------------------------------------|
| <b>S11</b>      | Measure S11.                               |
| <b>S12</b>      | Measure S12.                               |
| <b>S21</b>      | Measure S21.                               |
| <b>S22</b>      | Measure S22.                               |
| <b>SADD</b>     | Add segment to list.                       |
| <b>SAV1</b>     | Done with 1-port CAL.                      |
| <b>SAV2</b>     | Done with 2-port CAL.                      |
| <b>SAVC</b>     | Done with transfer of error coefficients.  |
| <b>SAVE1</b>    | Save to internal registers.                |
| <b>SAVE2</b>    | "                                          |
| <b>SAVE3</b>    | "                                          |
| <b>SAVE4</b>    | "                                          |
| <b>SAVE5</b>    | "                                          |
| <b>SCAL</b>     | Sets trace scale factor.                   |
| <b>SDEL</b>     | Delete current segment.                    |
| <b>SDON</b>     | Edit segment done.                         |
| <b>SEAL</b>     | Search left for target value.              |
| <b>SEAR</b>     | Search right for target value.             |
| <b>SEDI</b>     | Enter segment number.                      |
| <b>SETF</b>     | Set frequency (low pass).                  |
| <b>SETZ</b>     | SET system $Z_0$ .                         |
| <b>SING</b>     | Single group of sweeps.                    |
| <b>SLID</b>     | Sliding load done.                         |
| <b>SLIL</b>     | Specify sliding load as standard.          |
| <b>SLIS</b>     | Slide is set (triggers a measurement).     |
| <b>SMIC</b>     | Display data in Smith chart format.        |
| <b>SMOO?</b>    | Query smoothing on/off.                    |
| <b>SMOOFF</b>   | Smoothing off.                             |
| <b>SMOON</b>    | Smoothing on.                              |
| <b>SOFR</b>     | Display software revision on screen.       |
| <b>SOFT1</b>    | Select softkey (same as pressing softkey). |
| <b>SOFT2</b>    | "                                          |
| <b>SOFT3</b>    | "                                          |
| <b>SOFT4</b>    | "                                          |
| <b>SOFT5</b>    | "                                          |
| <b>SOFT6</b>    | "                                          |
| <b>SOFT7</b>    | "                                          |
| <b>SOFT8</b>    | "                                          |
| <b>SPAN</b>     | Set span value (frequency or time).        |
| <b>SPECFWDM</b> | Specify forward match standard.            |
| <b>SPECFWDT</b> | Specify forward transmission standard.     |
| <b>SPECRESP</b> | Specify response standard.                 |
| <b>SPECREVM</b> | Specify reverse match standard.            |
| <b>SPECREVT</b> | Specify reverse transmission standard.     |
| <b>SPECS11A</b> | Specify S11A standard: opens.              |
| <b>SPECS11B</b> | Specify S11B standard: shorts.             |
| <b>SPECS11C</b> | Specify S11C standard: loads.              |

| COMMAND         | Description                                                  |
|-----------------|--------------------------------------------------------------|
| <b>SPECS22A</b> | Specify S22A standard: opens.                                |
| <b>SPECS22B</b> | Specify S22B standard: shorts.                               |
| <b>SPECS22C</b> | Specify S22C standard: loads.                                |
| <b>SSEG</b>     | Select a single segment in frequency list mode. <sup>1</sup> |
| <b>STANA</b>    | Select standard from class.                                  |
| <b>STANB</b>    | "                                                            |
| <b>STANC</b>    | "                                                            |
| <b>STAND</b>    | "                                                            |
| <b>STANE</b>    | "                                                            |
| <b>STANF</b>    | "                                                            |
| <b>STANG</b>    | "                                                            |
| <b>STAR</b>     | Start start value (frequency or time).                       |
| <b>STDD</b>     | Standard definition done, modify cal kit.                    |
| <b>STDTARBI</b> | Define standard type arbitrary $Z_0$ modify cal kit.         |
| <b>STDTDELA</b> | Define standard type delay/thru.                             |
| <b>STDTLOAD</b> | Define standard type load.                                   |
| <b>STDTOPEN</b> | Define standard type open.                                   |
| <b>STDTSHOR</b> | Define standard type short.                                  |
| <b>STOP</b>     | Specify stop value (frequency or time).                      |
| <b>STPSIZE</b>  | Step size for frequency list segments.                       |
| <b>SWET</b>     | Set sweep time.                                              |
| <b>SWR</b>      | Display data in SWR format.                                  |
| <b>TERI</b>     | Terminal impedance, modify cal kit.                          |
| <b>TITL</b>     | Title function.                                              |
| <b>TRAD</b>     | Transmission done.                                           |
| <b>TRAN</b>     | Call transmission standard.                                  |
| <b>TRIG</b>     | Wait for sweep trigger.                                      |
| <b>UP</b>       | Up step key.                                                 |
| <b>VELOFACT</b> | Enter velocity factor for transmission medium.               |
| <b>WAIT</b>     | Wait for clean sweep.                                        |
| <b>WAVE</b>     | Specify waveguide offsets, modify cal kit.                   |
| <b>WINDMAXI</b> | Set maximum time domain window.                              |
| <b>WINDMINI</b> | Set minimum time domain window.                              |
| <b>WINDNORM</b> | Set normal time domain window.                               |

1. HP 8510B Rev. 4.0 or higher only.

## Section 3: Complete listing of HP-IB commands

This section gives a complete listing of all the HP-IB commands including query commands for the HP 8510B<sup>1</sup>, HP 8720A, HP 8753A, and HP 8702A network analyzers. The list is set up as follows:

**COMMAND**           •     •     •     •     Description

The HP-IB mnemonic is in the left column, the next four columns indicate which particular instrument the command can be used with, and the right column gives a brief description of the command's function. For more detailed information about specific commands, refer to the documents listed earlier.

| COMMAND     | HP 8510B | HP 8720A | HP 8753A | HP 8702A | Description                                          |
|-------------|----------|----------|----------|----------|------------------------------------------------------|
| - A -       |          |          |          |          |                                                      |
| ADAP1       | •        |          |          |          | Specify adapter in cal kit 1 for adapter removal.    |
| ADAP2       | •        |          |          |          | Specify adapter in cal kit 2 for adapter removal.    |
| ADAR        | •        |          |          |          | Select adapter removal modify cal set.               |
| ADDR8510    | •        |          |          |          | HP-IB address of HP 8510.                            |
| ADDRCONT    |          | •        | •        | •        | Controller address (same as <b>PCB</b> ).            |
| ADDRDISC    | •        | •        | •        | •        | Disc address.                                        |
| ADDRPASS    | •        |          |          |          | System bus passthrough address.                      |
| ADDRPLOT    | •        | •        | •        | •        | Plotter address.                                     |
| ADDRPOWM    |          |          | •        | •        | Power meter address.                                 |
| ADDRPRIN    | •        | •        | •        | •        | Printer address.                                     |
| ADDRRFS     | •        |          |          |          | System bus address for RF switch (dual test set).    |
| ADDRSOU2    | •        |          |          |          | Source #2 system bus address.                        |
| ADDRSOUR    | •        |          |          |          | Source #1 system bus address.                        |
| ADDRSYSB    | •        |          |          |          | HP-IB address of system bus.                         |
| ADDRTESS    | •        |          |          |          | System bus address of test set.                      |
| ALIASPANON  |          |          | •        |          | Alias free range limit on.                           |
| ALIASPANOFF |          |          | •        |          | Alias free range off.                                |
| ALTAB       |          |          | •        | •        | Alternate samplers during measurement.               |
| ANAI        |          | •        | •        | •        | Measure auxilliary analog input. (ANALOG IN).        |
| ANAO?       | •        |          |          |          | Query analog output.                                 |
| ANAOFF      | •        |          |          |          | Analog output off.                                   |
| ANAOON      | •        |          |          |          | Analog output on.                                    |
| ANNOSPAR    |          |          | •        |          | Parameter annotation set to S-parameters.            |
| ANNOTRAR    |          |          | •        |          | Parameter annotation set to transmission/reflection. |
| APOWDONE    | •        |          |          |          | Done with A power cal.                               |

1. Including those new commands available with Revision 4.0 firmware.

| COMMAND     | HP 8510B | HP 8720A | HP 8753A | HP 8702A | Description                                   |
|-------------|----------|----------|----------|----------|-----------------------------------------------|
| ARPODONE    |          |          |          | •        | Done with A/R power cal.                      |
| AR          |          |          | •        | •        | A/R ratio measurement.                        |
| ASEG        |          | •        |          |          | Sweep over all segments, list frequency mode. |
| ATTP1       | •        |          | •        | •        | Port 1 attenuator.                            |
| ATTP2       | •        |          | •        | •        | Port 2 attenuator.                            |
| AUTD        | •        |          |          |          | Auto delay.                                   |
| AUTO        | •        | •        | •        | •        | Auto scale.                                   |
| AUXV        | •        |          |          |          | Aux. volt output under DOMAIN.                |
| AVER?       | •        | •        | •        | •        | Query averaging on/off.                       |
| AVERFACT    |          | •        | •        | •        | Set averaging factor on active channel.       |
| AVEROFF     | •        | •        | •        | •        | Averaging off.                                |
| AVERON      | •        | •        | •        | •        | Averaging on.                                 |
| AVERREST    |          | •        | •        | •        | Restart averaging.                            |
| — B —       |          |          |          |          |                                               |
| BANDPASS    |          | •        | •        | •        | Select time domain bandpass mode.             |
| BEEP?       | •        |          |          |          | Query beeper.                                 |
| BEEPDONEON  |          | •        | •        | •        | Beep when done with certain functions.        |
| BEEPDONEOFF |          | •        | •        | •        | Beep off.                                     |
| BEEPFAILON  |          | •        | •        | •        | Beep if failure.                              |
| BEEPFALLOFF |          | •        | •        | •        | Beep off.                                     |
| BEEPOFF     | •        |          |          |          | Beeper off.                                   |
| BEEPON      | •        |          |          |          | Beeper on.                                    |
| BEEPWARNON  |          | •        | •        | •        | Beep if warning.                              |
| BEEPWARNOFF |          | •        | •        | •        | Beep warning off.                             |
| BPOWDONE    |          |          |          | •        | Done with B power cal.                        |
| BRPODONE    |          |          |          | •        | Done with B/R power cal.                      |
| BR          |          |          | •        | •        | B/R ratio measurement.                        |
| — C —       |          |          |          |          |                                               |
| C0          | •        | •        | •        | •        | Define open circuit capacitance values.       |
| C1          | •        | •        | •        | •        | "                                             |
| C2          | •        | •        | •        | •        | "                                             |
| C3          | •        | •        | •        | •        | "                                             |
| CAL1        | •        | •        | •        | •        | Begin cal sequence with cal kit 1.            |
| CAL2        | •        |          |          |          | Begin cal sequence with cal kit 2.            |
| CALI?       | •        |          |          |          | Query cal type.                               |
| CALIFUL2    | •        | •        | •        | •        | Select full 2-port cal.                       |
| CALIONE2    | •        |          | •        | •        | Select one path 2-port cal.                   |
| CALIAPOW    |          |          |          | •        | Power cal on A input.                         |
| CALIARPO    |          |          |          | •        | Power cal on B/R.                             |

| COMMAND   | HP 8510B | HP 8720A | HP 8753A | HP 8702A | Description                                                |
|-----------|----------|----------|----------|----------|------------------------------------------------------------|
| CALIBPOW  |          |          |          |          | • Power cal on B input.                                    |
| CALIBRPO  |          |          |          |          | • Power cal A/R.                                           |
| CALIRAI   | •        | •        | •        |          | • Select response & isolation calibration.                 |
| CALIRESP  | •        | •        | •        |          | • Select response cal.                                     |
| CALIS111  | •        | •        | •        |          | • Select S11 1-port cal.                                   |
| CALIS221  | •        | •        | •        |          | • Select S22 1-port cal.                                   |
| CALITRL2  | •        |          |          |          | • Select TRL 2-port cal.                                   |
| CALK1     | •        |          |          |          | • Cal kit 1 data type under TAPE/DISC.                     |
| CALK2     | •        |          |          |          | • Cal kit 2 data type under TAPE/DISC.                     |
| CALK35MM  |          | •        | •        |          | • Cal kit — 3.5 mm.                                        |
| CALK7MM   |          | •        | •        |          | • Cal kit — 7 mm.                                          |
| CALKN50   |          | •        | •        |          | • Cal kit — type N, 50 ohm.                                |
| CALKN75   |          |          | •        |          | • Cal kit — type N, 75 ohm.                                |
| CALLOPTS  |          |          |          |          | • Cal kit — optical standard kit.                          |
| CALOPTU   |          |          |          |          | • Cal kit — optical user kit.                              |
| CALKUSED  |          | •        | •        |          | • Cal kit — user defined.                                  |
| CALPRECE  |          |          |          |          | • Select receiver class (O/E DUT's only).                  |
| CALPRES   |          |          |          |          | • Select response class (A/R and B/R only).                |
| CALPRFSC  |          |          |          |          | • Select RF source cable power cal class.                  |
| CALPRFTC  |          |          |          |          | • Select RF total cable power cal class.                   |
| CALS1     | •        |          |          |          | • Select cal set under TAPE/DISC and CAL.                  |
| CALS2     | •        |          |          |          | • "                                                        |
| CALS3     | •        |          |          |          | • "                                                        |
| CALS4     | •        |          |          |          | • "                                                        |
| CALS5     | •        |          |          |          | • "                                                        |
| CALS6     | •        |          |          |          | • "                                                        |
| CALS7     | •        |          |          |          | • "                                                        |
| CALS8     | •        |          |          |          | • "                                                        |
| CALS?     | •        |          |          |          | • Query active calibration set.                            |
| CALSALL   | •        |          |          |          | • Cal set all data type under TAPE/DISC.                   |
| CALSDIRE? | •        |          |          |          | • List of stored cal sets.                                 |
| CALSPORT1 | •        |          |          |          | • Select port 1 Cal Set in adapter removal.                |
| CALSPORT2 | •        |          |          |          | • Select port 2 Cal Set in adapter removal.                |
| CALSRECC  |          |          |          |          | • Select receiver coefficient standard.                    |
| CALSRECD  |          |          |          |          | • Select receiver disc standard.                           |
| CALSSOUC  |          |          |          |          | • Select source coefficient standard.                      |
| CALSSOUD  |          |          |          |          | • Select source disc standard.                             |
| CALZ?     | •        |          |          |          | • Cal TRL $Z_0$ (characteristic impedance) thru or system. |
| CALZLINE  | •        |          |          |          | • TRL $Z_0$ set to thru line $Z_0$ .                       |

| COMMAND  | HP 8510B | HP 8720A | HP 8753A | HP 8702A | Description                                        |
|----------|----------|----------|----------|----------|----------------------------------------------------|
| CALZSYST | •        |          |          |          | TRL $Z_0$ corrected to system $Z_0$ .              |
| CENT     | •        | •        | •        | •        | Set center stimulus value (frequency or time).     |
| CHAN1    | •        | •        | •        | •        | Channel 1 active channel.                          |
| CHAN2    | •        | •        | •        | •        | Channel 2 active channel.                          |
| CHAN?    | •        |          |          |          | Query active channel.                              |
| CHOPAB   |          |          | •        | •        | Chop samplers during measurement.                  |
| CLAD     | •        | •        | •        | •        | Class done.                                        |
| CLASS11A | •        | •        | •        | •        | S11A: S11 opens.                                   |
| CLASS11B | •        | •        | •        | •        | S11A: S11 shorts.                                  |
| CLASS11C | •        | •        | •        | •        | S11A: S11 loads.                                   |
| CLASS22A | •        | •        | •        | •        | S22A: S22 opens.                                   |
| CLASS22B | •        | •        | •        | •        | S22A: S22 shorts.                                  |
| CLASS22C | •        | •        | •        | •        | S22A: S22 loads.                                   |
| CLEARALL |          | •        | •        | •        | Clear all registers.                               |
| CLEARn   |          | •        | •        | •        | Clear selected register <b>n</b> , <b>n</b> = 1-5. |
| CLEL     | •        |          |          |          | Clear frequency list under FREQ LIST.              |
| CLES     | •        | •        | •        | •        | Clear status, event status, and enable registers.  |
| CLS      |          | •        | •        | •        | Same as <b>CLES</b> .                              |
| COAD     | •        |          |          |          | Coaxial (linear) electrical delay.                 |
| COAX     | •        | •        | •        | •        | Select coaxial offsets, modify cal kit.            |
| COEFA    |          |          |          | •        | Coefficient for source/receiver model.             |
| COEFB    |          |          |          | •        | "                                                  |
| COEFC    |          |          |          | •        | "                                                  |
| COEFD    |          |          |          | •        | "                                                  |
| COEFE    |          |          |          | •        | "                                                  |
| COEFF    |          |          |          | •        | "                                                  |
| COEFG    |          |          |          | •        | "                                                  |
| COEFH    |          |          |          | •        | "                                                  |
| COEFI    |          |          |          | •        | "                                                  |
| CONF     | •        |          |          |          | Constant frequency value under multiple source.    |
| CONT     | •        | •        | •        | •        | Continual sweep trigger mode.                      |
| CONV1DS  |          | •        | •        | •        | Convert S-parameter data to 1/S.                   |
| CONV1S   | •        |          |          |          | Convert S-parameter data to 1/S.                   |
| CONV?    | •        |          |          |          | Query parameter conversion type.                   |
| CONVOFF  |          | •        | •        | •        | Disable parameter conversion.                      |
| CONVS    | •        |          |          |          | Convert to S-parameters.                           |
| CONVY    | •        |          |          |          | Convert to Y-parameters.                           |
| CONVYREF |          | •        | •        | •        | Convert to Y:reflection.                           |
| CONVYTRA |          | •        | •        | •        | Convert to Y:transmission.                         |
| CONVZ    | •        |          |          |          | Convert to z parameters.                           |

| COMMAND   | HP 8510B | HP 8720A | HP 8753A | HP 8702A | Description                                              |
|-----------|----------|----------|----------|----------|----------------------------------------------------------|
| CONVZREF  | •        | •        | •        |          | Convert to Z:reflection.                                 |
| CONVZTRA  | •        | •        | •        |          | Convert to Z:tansmission.                                |
| COPYFRFT  | •        | •        | •        |          | Copy file titles to register titles.                     |
| COPYFRRT  | •        | •        | •        |          | Copy register titles to disc register titles.            |
| CORION    |          |          |          | •        | Error correction interpolation enabled.                  |
| CORIOFF   |          |          |          | •        | Error correction interpolation disabled.                 |
| CORR?     | •        | •        | •        | •        | Query correction on/off.                                 |
| CORROFF   | •        | •        | •        | •        | Error-correction off.                                    |
| CORRON    | •        | •        | •        | •        | Error-correction on.                                     |
| COUC      | •        |          |          |          | Couple channels.                                         |
| COUCOFF   |          | •        | •        | •        | Uncouple channels.                                       |
| COUCON    |          | •        | •        | •        | Couple channels.                                         |
| COUP?     | •        |          |          |          | Query coupled/uncoupled channels.                        |
| CRES      | •        |          |          |          | Create and save under FREQUENCY SUBSET.                  |
| CRT?      | •        |          |          |          | Query crt on/off.                                        |
| CRTO      | •        |          |          |          | CRT off.                                                 |
| CWEXT     |          |          | •        | •        | CW via external input.                                   |
| CWFREQ    | •        | •        | •        | •        | Set CW frequency in frequency list mode.                 |
| CWTIME    |          | •        | •        | •        | Select CW time sweep type.                               |
| -D-       |          |          |          |          |                                                          |
| DATACHAN1 | •        |          |          |          | Trace math uses data from channel 1.                     |
| DATACHAN2 | •        |          |          |          | Trace math uses data from channel 2.                     |
| DATADATA  | •        |          |          |          | Corrected data type under TAPE/DISC.                     |
| DATAFORM  | •        |          |          |          | Formatted data type under TAPE/DISC.                     |
| DATARAW   | •        |          |          |          | Raw data type under TAPE/DISC.                           |
| DATI      | •        | •        | •        | •        | Store trace data to memory.                              |
| DEBUOFF   | •        | •        | •        | •        | HP-IB debug mode off.                                    |
| DEBUON    | •        | •        | •        | •        | HP-IB debug mode on.                                     |
| DEFA      | •        |          |          |          | Equation default in multiple source.                     |
| DEFIRECV  | •        |          |          |          | Define receiver equation in multiple source.             |
| DEFISOUR1 | •        |          |          |          | Multiple source define source #1 equation (test signal). |
| DEFISOUR2 | •        |          |          |          | Multiple source define source #2 equation (local osc.).  |
| DEFM1     | •        |          |          |          | Define memory used for memory on selected channel.       |
| DEFM2     | •        |          |          |          | " Memories 1-4, non-volatile.                            |
| DEFM3     | •        |          |          |          | "                                                        |
| DEFM4     | •        |          |          |          | "                                                        |
| DEFM5     | •        |          |          |          | " Memories 5-8, volatile.                                |
| DEFM6     | •        |          |          |          | "                                                        |
| DEFM7     | •        |          |          |          | "                                                        |
| DEFM8     | •        |          |          |          | "                                                        |

| COMMAND  | HP 8510B | HP 8720A | HP 8753A | HP 8702A | Description                                            |
|----------|----------|----------|----------|----------|--------------------------------------------------------|
| DEFM?    | •        |          |          |          | Query default memory selection.                        |
| DEFS     | •        | •        | •        | •        | Begin standard definition, modify cal kit.             |
| DELA     | •        | •        | •        | •        | Display data in group delay format.                    |
| DELC     | •        |          |          |          | Delete cal set (followed by <b>CALSn</b> ).            |
| DELE     | •        |          |          |          | Delete file under TAPE/DISC.                           |
| DELM?    | •        |          |          |          | Query electrical delay type.                           |
| DELO     | •        | •        | •        | •        | Delta marker mode off.                                 |
| DELR1    | •        | •        | •        | •        | Delta reference marker.                                |
| DELR2    | •        | •        | •        | •        | "                                                      |
| DELR3    | •        | •        | •        | •        | "                                                      |
| DELR4    | •        | •        | •        | •        | "                                                      |
| DELR5    | •        |          |          |          | "                                                      |
| DELR?    | •        |          |          |          | Query delta reference marker.                          |
| DELRFIXM |          | •        | •        | •        | Delta fixed marker.                                    |
| DELT     | •        |          |          |          | Delay table data type under TAPE/DISC.                 |
| DEMOAMPL |          | •        | •        | •        | Sets transform demodulation to amplitude demodulation. |
| DEMOOFF  |          | •        | •        | •        | Transform demodulation off.                            |
| DEMOPHAS |          | •        | •        | •        | Sets transform demodulation to phase demodulation.     |
| DENO?    | •        |          |          |          | Query parameter denominator.                           |
| DENOA1   | •        |          |          |          | Define denominator under PARAMETER as a1.              |
| DENOA2   | •        |          |          |          | Define denominator under PARAMETER as a2.              |
| DENOB1   | •        |          |          |          | Define denominator under PARAMETER as b1.              |
| DENONOR  | •        |          |          |          | Define denominator under PARAMETER as b2.              |
| DEV1PE   |          |          |          | •        | Select device type, 1-port electrical.                 |
| DEV1PO   |          |          |          | •        | Select device type, 1-port optical.                    |
| DEVTEE   |          |          |          | •        | Select device type, electrical/electrical.             |
| DEVTEO   |          |          |          | •        | Select device type, electrical/optical.                |
| DEVTOE   |          |          |          | •        | Select device type, optical/electrical.                |
| DEVTOO   |          |          |          | •        | Select device type, optical/optical.                   |
| DFLT     |          | •        | •        | •        | Select default plotter setups.                         |
| DIRE     | •        |          |          |          | Display directory for current tape/disc.               |
| DISCUNIT | •        | •        | •        | •        | Specify disc unit number.                              |
| DISCVOL  | •        |          |          |          | Specify disc volume number.                            |
| DISCVOLU |          | •        | •        | •        | Specify disc volume number.                            |
| DISF     | •        |          |          |          | Disc file name entry.                                  |
| DISP?    | •        |          |          |          | Query display trace.                                   |
| DISPDATA | •        | •        | •        | •        | Display data only.                                     |
| DISPDATM | •        | •        | •        | •        | Display data and memory.                               |
| DISPDMM  |          | •        | •        | •        | Display data divided by memory (trace math).           |
| DISPDMM  |          | •        | •        | •        | Display data minus memory (trace math).                |



| COMMAND           | HP 8510B | HP 8720A | HP 8753A | HP 8702A | Description                                                             |
|-------------------|----------|----------|----------|----------|-------------------------------------------------------------------------|
| DISPMATH          | •        |          |          |          | Display current with math.                                              |
| DISPMEMO          | •        | •        | •        | •        | Display memory only.                                                    |
| DIVI              | •        | •        | •        | •        | Display data divided by memory.                                         |
| DOMA?             | •        |          |          |          | Query domain.                                                           |
| DONE              | •        | •        | •        | •        | Class done, modify cal kit.                                             |
| DOWN              | •        | •        | •        | •        | Down step key.                                                          |
| DRIV?             | •        |          |          |          | Query parameter drive.                                                  |
| DRIVNONE          | •        |          |          |          | Select drive port for current parameter.                                |
| DRIVPORT1         | •        |          |          |          | Select drive port for current parameter.                                |
| DRIVPORT2         | •        |          |          |          | Select drive port for current parameter.                                |
| DUAC              |          | •        | •        | •        | Activate dual channel display mode.                                     |
| DUPD              | •        |          |          |          | Delete duplicates under <b>FREQ LIST</b> .                              |
| DUPM              | •        |          |          |          | Measure duplicate points under <b>FREQ LIST</b> .                       |
| DUPP?             | •        |          |          |          | Query duplicate points (list freq).                                     |
| — E —             |          |          |          |          |                                                                         |
| EDITDONE          | •        | •        | •        | •        | Done with list edit.                                                    |
| EDITLIML          |          | •        | •        | •        | Begin edit of limit line table.                                         |
| EDITLIST          | •        | •        | •        | •        | Begin edit of frequency list table.                                     |
| EDITMULS          | •        |          |          |          | Edit multiple source equations.                                         |
| ELEA              |          |          |          | •        | Electrical attenuator.                                                  |
| ELED              | •        | •        | •        | •        | Electrical delay under <b>RESPONSE</b> .                                |
| ENTO              | •        | •        | •        | •        | Entry off.                                                              |
| EQUA              | •        |          |          |          | Set current active function equal to active marker value.               |
| ESB?              |          | •        | •        | •        | Output event status register B.                                         |
| ESE               |          | •        | •        | •        | Event status register summarized by bit 5 of status byte.               |
| ESNB              |          | •        | •        | •        | Event status register B summarized by bit 2 of status byte.             |
| ESR?              |          | •        | •        | •        | Output value of event status register.                                  |
| EXTMDATA          |          | •        | •        | •        | Error corrected data array storage on disc.                             |
| EXTMFORM          |          | •        | •        | •        | Formatted data array storage on disc.                                   |
| EXTMGRAP          |          | •        | •        | •        | User graphics storage on disc.                                          |
| EXTMRAW           |          | •        | •        | •        | Raw data array storage on disc.                                         |
| EXTT              |          | •        | •        | •        | Activate external trigger mode.                                         |
| — F —             |          |          |          |          |                                                                         |
| FASC              | •        |          |          |          | Fast CW data acquisition (ext. trigger). Exit with <b>SINP</b> .        |
| FILE <sub>n</sub> | •        |          |          |          | Select data type file <b>n</b> under <b>TAPE/DISC</b> , <b>n</b> = 1-8. |
| FIRP              | •        |          |          |          | Select first page of tape directory and operating parameters.           |
| FIXE              | •        | •        | •        | •        | Specify fixed load standard type.                                       |
| FOCU              |          | •        | •        | •        | Display focus, in percent.                                              |

| COMMAND  | HP 8510B | HP 8720A | HP 8753A | HP 8702A | Description                                                         |
|----------|----------|----------|----------|----------|---------------------------------------------------------------------|
| FORM1    | •        | •        | •        | •        | Data transfer: Internal 6 byte binary format.                       |
| FORM2    | •        | •        | •        | •        | Data transfer: IEEE 8 byte floating point format.                   |
| FORM3    | •        | •        | •        | •        | Data transfer: IEEE 16 byte floating point format.                  |
| FORM4    | •        | •        | •        | •        | Data transfer: ASCII format.                                        |
| FORM?    | •        |          |          |          | Query format.                                                       |
| FREA?    | •        |          |          |          | Query frequency annotation on/off.                                  |
| FREQ     | •        | •        | •        | •        | Frequency annotation off.                                           |
| FREQ     | •        |          |          |          | Frequency domain.                                                   |
| FRER     | •        | •        | •        | •        | Select continual sweep (HP-IB free run) after <b>TRIG</b> .         |
| FRES     | •        |          |          |          | Frequency subset under MODIFY CAL SET.                              |
| FREU     | •        |          |          |          | Update frequency annotation with no sweep.                          |
| FULP     | •        | •        | •        | •        | Select full page plot under COPY.                                   |
| FWDI     | •        | •        | •        | •        | Forward isolation standard, modify cal kit.                         |
| FWDM     | •        | •        | •        | •        | Forward match standard, modify cal kit.                             |
| FWDT     | •        | •        | •        | •        | Forward transmission standard, modify cal kit.                      |
| —G—      |          |          |          |          |                                                                     |
| GATE?    | •        | •        | •        | •        | Query gating on/off.                                                |
| GATECENT | •        | •        | •        | •        | Specify center time of time domain gate.                            |
| GATEOFF  | •        | •        | •        | •        | Gating off.                                                         |
| GATEON   | •        | •        | •        | •        | Gating on.                                                          |
| GATESPAN | •        | •        | •        | •        | Specify span time of time domain gate.                              |
| GATESTAR | •        | •        | •        | •        | Specify start time of time domain gate.                             |
| GATESTOP | •        | •        | •        | •        | Specify stop time of time domain gate.                              |
| GATS?    | •        |          |          |          | Query gate shape.                                                   |
| GATSMAXI | •        | •        | •        | •        | Gate shape maximum.                                                 |
| GATSMINI | •        | •        | •        | •        | Gate shape minimum.                                                 |
| GATSNORM | •        | •        | •        | •        | Gate shape normal.                                                  |
| GATSWIDE | •        | •        | •        | •        | Gate shape wide.                                                    |
| GROU?    | •        |          |          |          | Query continual or hold mode.                                       |
| —H—      |          |          |          |          |                                                                     |
| HARS     | •        |          |          |          | Hardware state data type under TAPE/DISC.                           |
| HOLD     | •        | •        | •        | •        | Hold sweep (sweep trigger in hold mode).                            |
| —I—      |          |          |          |          |                                                                     |
| IDN?     |          | •        | •        | •        | Output identification string. Same as <b>OUTPIDEN</b> (common cmd). |
| IFBW     |          | •        | •        | •        | Specify IF bandwidth.                                               |
| IFGREFA? | •        |          |          |          | Query reference gain.                                               |
| IFGTESA? | •        |          |          |          | Query test gain.                                                    |

| COMMAND    |          |          |          |          | Description                                                 |
|------------|----------|----------|----------|----------|-------------------------------------------------------------|
|            | HP 8510B | HP 8720A | HP 8753A | HP 8702A |                                                             |
| IMAG       | •        |          |          |          | Display data in imaginary format.                           |
| INDERFR    |          |          |          | •        | Index of refraction, reciprocal of velocity factor.         |
| INID       | •        | •        | •        | •        | Initialize disc media.                                      |
| INIT       | •        |          |          |          | Initialize tape.                                            |
| INPUCALC01 | •        | •        | •        | •        | Input calibration coefficient data arrays.                  |
| INPUCALC02 | •        | •        | •        | •        | "                                                           |
| INPUCALC03 | •        | •        | •        | •        | "                                                           |
| INPUCALC04 | •        | •        | •        | •        | "                                                           |
| INPUCALC05 | •        | •        | •        | •        | "                                                           |
| INPUCALC06 | •        | •        | •        | •        | "                                                           |
| INPUCALC07 | •        | •        | •        | •        | "                                                           |
| INPUCALC08 | •        | •        | •        | •        | "                                                           |
| INPUCALC09 | •        | •        | •        | •        | "                                                           |
| INPUCALC10 | •        | •        | •        | •        | "                                                           |
| INPUCALC11 | •        | •        | •        | •        | "                                                           |
| INPUCALC12 | •        | •        | •        | •        | "                                                           |
| INPUCALK   |          | •        | •        | •        | Input cal kit.                                              |
| INPUCALR   |          |          |          | •        | Input receiver cal data, stored as disc data.               |
| INPUCALS   |          |          |          | •        | Input source cal data, stored as disc data.                 |
| INPUDELA   | •        | •        | •        | •        | Input error corrected data array.                           |
| INPUDELA   | •        |          |          |          | Input delay table.                                          |
| INPUFORM   | •        | •        | •        | •        | Input formatted data array.                                 |
| INPUFREL   | •        |          |          |          | Input frequency list. (Use <b>INPULEAS</b> with HP 8700's). |
| INPULEAS   | •        | •        | •        | •        | Input learn string.                                         |
| INPURAW1   | •        | •        | •        | •        | Input raw data array 1.                                     |
| INPURAW2   | •        | •        | •        | •        | "                                                           |
| INPURAW3   | •        | •        | •        | •        | "                                                           |
| INPURAW4   | •        | •        | •        | •        | "                                                           |
| INSS1      | •        |          |          |          | Instrument states under TAPE/DISC.                          |
| INSS2      | •        |          |          |          | "                                                           |
| INSS3      | •        |          |          |          | "                                                           |
| INSS4      | •        |          |          |          | "                                                           |
| INSS5      | •        |          |          |          | "                                                           |
| INSS6      | •        |          |          |          | "                                                           |
| INSS7      | •        |          |          |          | "                                                           |
| INSS8      | •        |          |          |          | "                                                           |
| INSSALL    | •        |          |          |          | All instrument states under TAPE/DISC.                      |
| INTE       |          | •        | •        | •        | Intensity level for display, in percent.                    |
| INVS       | •        |          |          |          | Display data in inverted Smith chart format.                |
| ISOD       | •        | •        | •        | •        | Isolation done, full 2-port cal.                            |
| ISOL       | •        | •        | •        | •        | Begin isolation, full 2-port cal.                           |

| COMMAND     | HP 8510B | HP 8720A | HP 8753A | HP 8702A | Description                                               |
|-------------|----------|----------|----------|----------|-----------------------------------------------------------|
| -K-         |          |          |          |          |                                                           |
| KEY         |          | •        | •        | •        | Sends a keycode, same as actually pressing the key.       |
| KEYC        | •        |          |          |          | "                                                         |
| KITD        | •        | •        | •        | •        | Cal kit definition done, modify cal kit.                  |
| KOR?        |          | •        | •        | •        | Same as <b>OUTPKEY</b> (common command).                  |
| -L-         |          |          |          |          |                                                           |
| L0          | •        |          |          |          | L0 short circuit inductance.                              |
| L1          | •        |          |          |          | L1 short circuit inductance.                              |
| L2          | •        |          |          |          | L2 short circuit inductance.                              |
| L3          | •        |          |          |          | L3 short circuit inductance.                              |
| LABEADAP    | •        |          |          |          | Label class adapters.                                     |
| LABEFWDI    | •        |          |          |          | Label class forward isolation.                            |
| LABEFWDM    | •        | •        | •        | •        | Label class forward match.                                |
| LABEFWDT    | •        | •        | •        | •        | Label class forward transmission.                         |
| LABERESI    |          | •        | •        | •        | Label response standard for the response & isolation cal. |
| LABERESP    | •        | •        | •        | •        | Label class response.                                     |
| LABEREVI    | •        |          |          |          | Label class reverse isolation.                            |
| LABEREVM    | •        | •        | •        | •        | Label class reverse match.                                |
| LABEREVT    | •        | •        | •        | •        | Label class reverse transmission.                         |
| LABES11A    | •        | •        | •        | •        | Label class S11A: opens.                                  |
| LABES11B    | •        | •        | •        | •        | Label class S11B: shorts.                                 |
| LABES11C    | •        | •        | •        | •        | Label class S11C: loads.                                  |
| LABES22A    | •        | •        | •        | •        | Label class S22A: opens.                                  |
| LABES22B    | •        | •        | •        | •        | Label class S22B: shorts.                                 |
| LABES22C    | •        | •        | •        | •        | Label class S22C: loads.                                  |
| LABETRLL    | •        |          |          |          | Label TRL line.                                           |
| LABETRLR    | •        |          |          |          | Label reflect.                                            |
| LABETRLT    | •        |          |          |          | Label thru.                                               |
| LABK        | •        | •        | •        | •        | Label cal kit, modify cal kit.                            |
| LABS        | •        | •        | •        | •        | Label standard, standard definition.                      |
| LABO        |          |          |          | •        | Label optical kit under CAL.                              |
| LASP        | •        |          |          |          | Last page of tape directory.                              |
| LEFL        | •        | •        | •        | •        | Left lower quadrant plot.                                 |
| LEFU        | •        | •        | •        | •        | Left upper quadrant plot.                                 |
| LIMD        |          | •        | •        | •        | Set limit delta value.                                    |
| LIMIAMPO    |          | •        | •        | •        | Set limit table amplitude offset.                         |
| LIMILINEOFF |          | •        | •        | •        | Disable limit lines.                                      |
| LIMILINEON  |          | •        | •        | •        | Enable limit lines.                                       |
| LIMIMAOF    |          | •        | •        | •        | Marker to limit amplitude offset.                         |
| LIMISTIO    |          | •        | •        | •        | Limit table stimulus offset.                              |
| LIMITESTOFF |          | •        | •        | •        | Disable limit line test.                                  |

| COMMAND    | HP 8510B | HP 8720A | HP 8753A | HP 8702A | Description                                                |
|------------|----------|----------|----------|----------|------------------------------------------------------------|
| LIMITESTON | •        | •        | •        |          | Enable limit line test.                                    |
| LIML       | •        | •        | •        |          | Set limit lower value.                                     |
| LIMM       | •        | •        | •        |          | Set limit middle value.                                    |
| LIMS       | •        | •        | •        |          | Set limit stimulus value.                                  |
| LIMTFL     | •        | •        | •        |          | Make the segment a flat line.                              |
| LIMTSL     | •        | •        | •        |          | Make the segment a sloping line.                           |
| LIMTSP     | •        | •        | •        |          | Make the segment a single point.                           |
| LIMU       | •        | •        | •        |          | Set upper limit value.                                     |
| LINFREQ    | •        | •        | •        |          | Select linear frequency sweep.                             |
| LINM       | •        | •        | •        | •        | Display data in linear magnitude format.                   |
| LINP       | •        |          |          |          | Linear marker on polar format.                             |
| LINTDATA   | •        | •        | •        |          | Select line type—trace data plot.                          |
| LINTMEMO   | •        | •        | •        |          | Select line type—trace memory plot.                        |
| LISFREQ    | •        | •        | •        | •        | Select list frequency mode.                                |
| LIST       | •        |          |          |          | List trace values under COPY.                              |
| LISV       | •        | •        | •        |          | List trace values (use <b>PLOT/PRINALL</b> for hard copy). |
| LOAD       | •        |          |          |          | Load a TAPE/DISC data file.                                |
| LOADn      | •        | •        | •        |          | Recall from disc file <b>n</b> , <b>n</b> = 1-5.           |
| LOADREC1   |          |          |          | •        | Load calibrated receiver data from disc.                   |
| LOADREC2   |          |          |          | •        | "                                                          |
| LOADREC3   |          |          |          | •        | "                                                          |
| LOADREC4   |          |          |          | •        | "                                                          |
| LOADREC5   | •        |          |          |          | "                                                          |
| LOADSOU1   |          |          |          | •        | Load calibrated source data from disc.                     |
| LOADSOU2   |          |          |          | •        | "                                                          |
| LOADSOU3   |          |          |          | •        | "                                                          |
| LOADSOU4   |          |          |          | •        | "                                                          |
| LOADSOU5   |          |          |          | •        | "                                                          |
| LOAN       | •        |          |          |          | Measure load with no offset.                               |
| LOAO       | •        |          |          |          | Measure load with offset (offset load std).                |
| LOAT?      | •        |          |          |          | Query load type.                                           |
| LOCK?      | •        |          |          |          | Query parameter lock to.                                   |
| LOCKS?     | •        |          |          |          | Query phase lock speed.                                    |
| LOCKA1     | •        |          |          |          | Select phase lock to a1.                                   |
| LOCKA2     | •        |          |          |          | Select phase lock to a2.                                   |
| LOCKNONE   | •        |          |          |          | Select phase lock to none.                                 |
| LOCKSNORM  | •        |          |          |          | Redefine lockspeed, normal.                                |
| LOCKSFAS   | •        |          |          |          | Redefine lockspeed, fast.                                  |
| LOCT?      | •        |          |          |          | Query system phase lock.                                   |
| LOCTEXTE   | •        |          |          |          | Select 1st IF phase lock to external LO.                   |
| LOCTINTE   | •        |          |          |          | Select 1st IF phase lock to internal LO.                   |
| LOCTNONE   | •        |          |          |          | Do not phase lock 1st IF.                                  |
| LOGFREQ    | •        | •        | •        |          | Log frequency sweep.                                       |

| COMMAND   |          |          |          |          | Description                                                   |
|-----------|----------|----------|----------|----------|---------------------------------------------------------------|
|           | HP 8510B | HP 8720A | HP 8753A | HP 8702A |                                                               |
| LOGM      | •        | •        | •        | •        | Display data in log magnitude format.                         |
| LOGP      | •        |          |          |          | Log marker on polar format.                                   |
| LOWF      | •        |          |          |          | Specify TRL Lowband Frequency.                                |
| LOWP?     | •        |          |          |          | Query time stimulus.                                          |
| LOWPIMPU  | •        | •        | •        | •        | Low pass impulse time domain.                                 |
| LOWPSET?  | •        |          |          |          | Query low pass freq set on/off.                               |
| LOWPSTEP  | •        | •        | •        | •        | Low pass step time domain.                                    |
| LOWR      | •        |          |          |          | Begin TRL 2-port lowband reflection.                          |
| LRN       |          | •        | •        | •        | Same as <b>INPULEAS</b> .                                     |
| - M -     |          |          |          |          |                                                               |
| MACD      | •        |          |          |          | Machine dump data type under TAPE/DISC.                       |
| MAGO      | •        |          |          |          | Set magnitude offset for current parameter on active chan.    |
| MAGS      | •        |          |          |          | Set magnitude slope dB/GHz for current parameter/actv. ch.    |
| MARK1     | •        | •        | •        | •        | Make marker 1 the active marker.                              |
| MARK2     | •        | •        | •        | •        | Make marker 2 active.                                         |
| MARK3     | •        | •        | •        | •        | Make marker 3 active.                                         |
| MARK4     | •        | •        | •        | •        | Make marker 4 active.                                         |
| MARK5     | •        |          |          |          | Select marker 5.                                              |
| MARK?     | •        |          |          |          | Query active marker.                                          |
| MARKBUCK  |          | •        | •        | •        | Place marker on specific sweep point (bucket).                |
| MARKCENT  |          | •        | •        | •        | Marker stimulus value sets the center stimulus value.         |
| MARKCONT  | •        | •        | •        | •        | Markers in continuous mode.                                   |
| MARKCOUP  |          | •        | •        | •        | Enable channel coupled markers.                               |
| MARKDELA  |          | •        | •        | •        | Sets electrical delay so group delay is zero at marker.       |
| MARKDISC  | •        | •        | •        | •        | Markers in discrete mode.                                     |
| MARKFAUV  |          | •        | •        | •        | Sets auxiliary value of fixed marker position.                |
| MARKFSTI  |          | •        | •        | •        | Sets stimulus position of the fixed marker.                   |
| MARKFVAL  |          | •        | •        | •        | Sets the val. of the fixed marker position.                   |
| MARKMAXI  | •        | •        | •        | •        | Marker to maximum. Same as <b>SEAMAX</b> .                    |
| MARKMIDD  |          | •        | •        | •        | Sets the limit segment middle value to marker amplitude.      |
| MARKMINI  | •        | •        | •        | •        | Marker to minimum. Same as <b>SEAMIN</b> .                    |
| MARKMODE? | •        |          |          |          | Query marker mode.                                            |
| MARKOFF   | •        | •        | •        | •        | Turn all markers and marker functions off.                    |
| MARKREF   |          | •        | •        | •        | Sets the reference value to marker amplitude.                 |
| MARKSEAR? | •        |          |          |          | Query marker search mode.                                     |
| MARKSPAN  |          | •        | •        | •        | Sets the span to that between the act. mkr and delta ref.     |
| MARKSTAR  |          | •        | •        | •        | Sets the start stimulus value to that of the marker stimulus. |
| MARKSTIM  |          | •        | •        | •        | Sets the limit stimulus break pt to that of the mkr stimulus. |
| MARKSTOP  |          | •        | •        | •        | Sets the stop stimulus value to that of the marker stimulus.  |
| MARKTARG  | •        |          |          |          | Active marker to target trace value.                          |

| COMMAND    | HP 8510B | HP 8720A | HP 8753A | HP 8702A | Description                                                          |
|------------|----------|----------|----------|----------|----------------------------------------------------------------------|
| MARKUNCO   | •        | •        | •        |          | Enable channel uncoupled markers.                                    |
| MARKZERO   | •        | •        | •        |          | Place fixed marker at active marker and make it the delta reference. |
| MATH?      | •        |          |          |          | Query trace math type.                                               |
| MAXF       | •        | •        | •        | •        | Specify max frequency of cal standard, modify cal kit.               |
| MEASA      |          |          | •        | •        | A non-ratio measurement.                                             |
| MEASB      |          |          | •        | •        | B non-ratio measurement.                                             |
| MEASOFF    |          |          | •        | •        | Marker measure off, not Boolean.                                     |
| MEASR      |          |          | •        | •        | R non-ratio measurement.                                             |
| MEASTATOFF | •        | •        | •        | •        | Disable trace/marker statistics.                                     |
| MEASTATON  | •        | •        | •        | •        | Enable trace/marker statistics.                                      |
| MEDT?      | •        |          |          |          | Query cal std type — coax or waveguide.                              |
| MEMO1      | •        |          |          |          | Trace memory data type under tape/disc.                              |
| MEMO2      | •        |          |          |          | "                                                                    |
| MEMO3      | •        |          |          |          | "                                                                    |
| MEMO4      | •        |          |          |          | "                                                                    |
| MEMO5      | •        |          |          |          | "                                                                    |
| MEMO6      | •        |          |          |          | "                                                                    |
| MEMO7      | •        |          |          |          | "                                                                    |
| MEMO8      | •        |          |          |          | "                                                                    |
| MEMOALL    | •        |          |          |          | "                                                                    |
| MENU?      | •        |          |          |          | Query menu on/off.                                                   |
| MENUAVG    | •        | •        | •        | •        | AVG key menu.                                                        |
| MENUCAL    | •        | •        | •        | •        | CAL key menu.                                                        |
| MENUCOPY   | •        | •        | •        | •        | COPY key menu.                                                       |
| MENUDISP   | •        | •        | •        | •        | DISPLAY key menu.                                                    |
| MENUDOMA   | •        |          |          |          | DOMAIN menu.                                                         |
| MENUFORM   | •        | •        | •        | •        | FORMAT key menu.                                                     |
| MENUMARK   | •        | •        | •        | •        | MKR key menu.                                                        |
| MENUMEAS   |          | •        | •        | •        | MEAS key menu.                                                       |
| MENUMRKF   |          | •        | •        | •        | MKR FCTN key menu.                                                   |
| MENUOFF    | •        | •        | •        | •        | Turn off softkey labels.                                             |
| MENUON     | •        | •        | •        | •        | Menu on.                                                             |
| MENUPARA   | •        |          |          |          | PARAMETER menu.                                                      |
| MENUPRIO   | •        |          |          |          | Prior menu.                                                          |
| MENURECA   | •        | •        | •        | •        | RECALL key menu.                                                     |
| MENURESP   | •        |          |          |          | RESPONSE menu.                                                       |
| MENUSAVE   | •        | •        | •        | •        | SAVE key menu.                                                       |
| MENUSCAL   | •        | •        | •        | •        | SCALE REF key menu.                                                  |
| MENUSTIM   | •        | •        | •        | •        | Stimulus MENU key.                                                   |
| MENUSYST   | •        | •        | •        | •        | SYSTEM key menu.                                                     |

| COMMAND  | HP 8510B | HP 8720A | HP 8753A | HP 8702A | Description                                                   |
|----------|----------|----------|----------|----------|---------------------------------------------------------------|
| MENUTAPE | •        |          |          |          | TAPE/DISC menu.                                               |
| MENUTEST | •        |          |          |          | TEST menu.                                                    |
| MINF     | •        | •        | •        | •        | Specify min freq of cal standard, modify cal kit.             |
| MINU     | •        | •        | •        | •        | Display data minus memory.                                    |
| MODI1    | •        | •        | •        | •        | Begins modify cal kit sequence.                               |
| MODI2    | •        |          |          |          | Modify cal kit 2.                                             |
| MODIO    |          |          |          |          | Begin modify optical kit.                                     |
| MODS     | •        |          |          |          | Modify selected cal set and save (follow with <b>CALSn</b> ). |
| MULD     | •        |          |          |          | Multiplier denominator under MULTI SRC.                       |
| MULN     | •        |          |          |          | Multiplier numerator under MULTI SRC.                         |
| MULS?    | •        |          |          |          | Query multiple source on/off.                                 |
| MULSOFF  | •        |          |          |          | Multiple source mode off.                                     |
| MULSON   | •        |          |          |          | Multiple source mode on.                                      |
| MULT     | •        |          |          |          | Multiple data & memory under DISPLAY.                         |
| - N -    |          |          |          |          |                                                               |
| NEXP     |          | •        | •        | •        | Displays next page of operating parameters.                   |
| NEXP     | •        |          |          |          | Displays next page of tape directory.                         |
| NOOP     |          | •        | •        | •        | No operation.                                                 |
| NUME?    | •        |          |          |          | Query parameter numerator.                                    |
| NUMEA1   | •        |          |          |          | Define numerator under PARAMETER as a1.                       |
| NUMEA2   | •        |          |          |          | Define numerator under PARAMETER as a2.                       |
| NUMEB1   | •        |          |          |          | Define numerator under PARAMETER as b1.                       |
| NUMEB2   | •        |          |          |          | Define numerator under PARAMETER as b2.                       |
| NUMG     | •        | •        | •        | •        | Specifies number of groups of sweeps.                         |
| NUMS?    | •        |          |          |          | Query number of frequency list segments.                      |
| - O -    |          |          |          |          |                                                               |
| OFFD     | •        |          |          |          | Offset delay under CAL.                                       |
| OFFF     | •        |          |          |          | Freq offset under MULTI SRC.                                  |
| OFFL     | •        |          |          |          | Offset loss under CAL.                                        |
| OFFS     | •        |          |          |          | Define load or arbitrary impedance standard as offset type.   |
| OFFZ     | •        |          |          |          | Real imped (Z) of offset cal standard.                        |
| OFLD     | •        |          |          |          | Offset load done.                                             |
| OFSD     |          | •        | •        | •        | Offset delay under CAL.                                       |
| OFSL     |          | •        | •        | •        | Offset loss under CAL.                                        |
| OFSOINDR |          |          |          | •        | Set refractive index of offset (optical cal standard)         |
| OFSOLENG |          |          |          | •        | Length of optical offset (optical cal standard).              |
| OFSOLOSS |          |          |          | •        | Loss per length (optical cal standard).                       |
| OFSORPOW |          |          |          | •        | Per cent reflectance (optical cal standard).                  |
| OFSZ     |          | •        | •        | •        | Impedance offset under CAL.                                   |
| OMIA     |          |          |          | •        | Omit optical attenuation for power cal.                       |
| OMII     | •        | •        | •        | •        | Omit isolation under CAL.                                     |



| COMMAND    | HP 8510B | HP 8720A | HP 8753A | HP 8702A | Description                               |
|------------|----------|----------|----------|----------|-------------------------------------------|
| OPC        |          | •        | •        | •        | Operation complete (IEEE 488.2).          |
| OPEP       | •        | •        | •        | •        | Display operating parameters.             |
| OPTA       |          |          |          | •        | Optical attenuator.                       |
| OUTPACTI   | •        | •        | •        | •        | Output active function.                   |
| OUTPAPER   |          | •        | •        | •        | Output smoothing aperture.                |
| OUTPCALC01 | •        | •        | •        | •        | Output calibration coefficient.           |
| OUTPCALC02 | •        | •        | •        | •        | "                                         |
| OUTPCALC03 | •        | •        | •        | •        | "                                         |
| OUTPCALC04 | •        | •        | •        | •        | "                                         |
| OUTPCALC05 | •        | •        | •        | •        | "                                         |
| OUTPCALC06 | •        | •        | •        | •        | "                                         |
| OUTPCALC07 | •        | •        | •        | •        | "                                         |
| OUTPCALC08 | •        | •        | •        | •        | "                                         |
| OUTPCALC09 | •        | •        | •        | •        | "                                         |
| OUTPCALC10 | •        | •        | •        | •        | "                                         |
| OUTPCALC11 | •        | •        | •        | •        | "                                         |
| OUTPCALC12 | •        | •        | •        | •        | "                                         |
| OUTPCALK   |          | •        | •        | •        | Output currently active calibration kit.  |
| OUTPCALR   |          |          |          | •        | Output receiver cal data (disc standard). |
| OUTPCALS   |          |          |          | •        | Output source cal data (disc standard).   |
| OUTPDATA   | •        | •        | •        | •        | Output error corrected data array.        |
| OUTPDELA   | •        |          |          |          | Output delay table.                       |
| OUTPERRO   | •        | •        | •        | •        | Output error number,string.               |
| OUTPFORM   | •        | •        | •        | •        | Output formatted array.                   |
| OUTPFREL   | •        |          |          |          | Output frequency list.                    |
| OUTPIDEN   | •        | •        | •        | •        | Output identification string.             |
| OUTPKEY    | •        | •        | •        | •        | Output key code.                          |
| OUTPLEAS   | •        | •        | •        | •        | Output learn string.                      |
| OUTPLIMF   |          | •        | •        | •        | Output limit failures.                    |
| OUTPLIML   |          | •        | •        | •        | Output all limit points.                  |
| OUTPLIMM   |          | •        | •        | •        | Output limits at marker.                  |
| OUTPMARK   | •        | •        | •        | •        | Output marker value.                      |
| OUTPMEMO   | •        | •        | •        | •        | Output memory trace if on.                |
| OUTPMPUL   |          |          |          | •        | Pulse width, 3 values.                    |
| OUTPMRIS   |          |          |          | •        | Rise time, 3 values.                      |
| OUTPMSTA   |          | •        | •        | •        | Output trace/marker statistics.           |
| OUTPMWID   |          | •        | •        | •        | Output marker bandwidths search values.   |
| OUTPPLOT   | •        | •        | •        | •        | Output HP-GL plot string.                 |
| OUTPPRIN   |          | •        | •        | •        | Output raster data to printer.            |
| OUTPRAW1   | •        | •        | •        | •        | Output raw data array.                    |
| OUTPRAW2   | •        | •        | •        | •        | "                                         |
| OUTPRAW3   | •        | •        | •        | •        | "                                         |
| OUTPRAW4   | •        | •        | •        | •        | "                                         |
| OUTPSTAT   | •        | •        | •        | •        | Output status byte.                       |
| OUTPTITL   | •        | •        | •        | •        | Output of last title.                     |
| OVER       | •        |          |          |          | Dual channel overlay under DISPLAY.       |

| COMMAND  | Model    |          |          |          | Description                                   |
|----------|----------|----------|----------|----------|-----------------------------------------------|
|          | HP 8510B | HP 8720A | HP 8753A | HP 8702A |                                               |
| - P -    |          |          |          |          |                                               |
| PAGP     | •        |          |          |          | Page thru operating system parameters.        |
| PARA?    | •        |          |          |          | Query parameter selected.                     |
| PARL     | •        |          |          |          | Label current user parameter.                 |
| PDATAOFF |          | •        | •        | •        | Disable plot of trace data.                   |
| PDATAON  |          | •        | •        | •        | Enable plot of trace data.                    |
| PEN1     | •        |          |          |          | Plotter pen selection under COPY.             |
| PEN2     | •        |          |          |          | "                                             |
| PEN3     | •        |          |          |          | "                                             |
| PEN4     | •        |          |          |          | "                                             |
| PEN5     | •        |          |          |          | "                                             |
| PEN6     | •        |          |          |          | "                                             |
| PEN7     | •        |          |          |          | "                                             |
| PEN8     | •        |          |          |          | "                                             |
| PEN?     | •        |          |          |          | Query pen.                                    |
| PENNDATA |          | •        | •        | •        | Select pen for trace data plot.               |
| PENNGRAT |          | •        | •        | •        | Select pen for graticule plot.                |
| PENMARK  |          | •        | •        | •        | Select pen for marker plot.                   |
| PENMEMO  |          | •        | •        | •        | Select pen for trace memory plot.             |
| PENTEXT  |          | •        | •        | •        | Select pen for text plot.                     |
| PGRAT    |          | •        | •        | •        | Enable/disable plot of graticule.             |
| PHAO     | •        | •        | •        | •        | Phase offset.                                 |
| PHAS     | •        | •        | •        | •        | Display data in phase format.                 |
| PLOP     | •        |          |          |          | Plot operating/system parameters.             |
| PLOFAST  |          | •        | •        | •        | Select fast plot speed.                       |
| PLOSSLOW |          | •        | •        | •        | Select slow plot speed.                       |
| PLOT     |          | •        | •        | •        | Requests a plot (requires pass control mode). |
| PLOTALL  | •        |          |          |          | Plot complete meas. display.                  |
| PLOTGRAT | •        |          |          |          | Plot graticule.                               |
| PLOTMARK | •        |          |          |          | Plot marker(s).                               |
| PLOTTEXT | •        |          |          |          | Plot text.                                    |
| PLOTTRAC | •        |          |          |          | Plot trace.                                   |
| PLUS     | •        |          |          |          | Display data plus memory under DISPLAY.       |
| PMEMOFF  |          | •        | •        | •        | Disable plot of trace memory.                 |
| PMEMON   |          | •        | •        | •        | Enable plot of trace memory.                  |
| PMKROFF  |          | •        | •        | •        | Disable plot of markers.                      |
| PMKRON   |          | •        | •        | •        | Enable plot of markers.                       |
| POIN     | •        | •        | •        | •        | Set the number of points.                     |
| POIN?    | •        | •        | •        | •        | Query number of points.                       |
| POLA     |          | •        | •        | •        | Display data in the polar format.             |
| POLMLIN  |          | •        | •        | •        | Linear markers on polar format.               |

| COMMAND  | HP 8510B | HP 8720A | HP 8753A | HP 8702A | Description                                                    |
|----------|----------|----------|----------|----------|----------------------------------------------------------------|
| POLMLOG  |          | •        | •        | •        | Log markers on polar format.                                   |
| POLMRI   |          | •        | •        | •        | Real/imaginary markers on polar format.                        |
| POREOFF  |          | •        | •        | •        | Disable port extensions under CAL.                             |
| POREON   |          | •        | •        | •        | Enable port extensions under CAL.                              |
| PORTA    |          |          | •        | •        | Set port A extension length.                                   |
| PORTB    |          |          | •        | •        | Set port B extension length.                                   |
| PORT1    | •        | •        | •        | •        | Set port 1 extension length.                                   |
| PORT2    | •        | •        | •        | •        | Set port 2 extension length.                                   |
| POW2     | •        |          |          |          | Source 2 power under POWER MENU.                               |
| POWE     | •        | •        | •        | •        | Specify source power.                                          |
| POWMOFF  |          |          | •        | •        | Select HP 438A power meter.                                    |
| POWMON   |          |          | •        | •        | Select HP 436A power meter.                                    |
| POWS     |          |          | •        | •        | Activate power sweep.                                          |
| POWTOFF  |          | •        | •        | •        | Clears source power trip after overload.                       |
| POWTON   |          | •        | •        | •        | Source power trip.                                             |
| PREC     | •        |          |          |          | Continue one-path 2-port measurement (after reversing D.U.T.). |
| PREP     | •        |          |          |          | Previous page in a tape directory.                             |
| PRES     | •        | •        | •        | •        | Instrument preset.                                             |
| PRINALL  |          | •        | •        | •        | Copy display to printer (requires pass control mode).          |
| PRIP     | •        |          |          |          | Print operating/system parameters.                             |
| PSOFTOFF |          | •        | •        | •        | Disable plot/print of softkeys.                                |
| PSOFTON  |          | •        | •        | •        | Enable plot/print of softkeys.                                 |
| PTEXTOFF |          | •        | •        | •        | Disable plot of text.                                          |
| PTEXTON  |          | •        | •        | •        | Enable plot of text.                                           |
| PULV     |          |          |          | •        | Value for pulse search.                                        |
| PULW     |          |          |          | •        | Measure pulse width.                                           |
| PURGn    |          | •        | •        | •        | Delete disc file n, n = 1-5.                                   |
| —Q—      |          |          |          |          |                                                                |
| QUAD?    | •        |          |          |          | Query quadrant for plots.                                      |
| —R—      |          |          |          |          |                                                                |
| RAID     | •        | •        | •        | •        | Response & isolation calibration done.                         |
| RAISOL   | •        | •        | •        | •        | Call isolation class, response & isolation cal.                |
| RAIRESP  | •        | •        | •        | •        | Call response class, response & isolation cal.                 |
| RAMP     | •        |          |          |          | Ramp sweep under STIMULUS.                                     |
| READRECT |          |          |          | •        | Read receiver file titles from disc.                           |

| COMMAND  | HP 8510B | HP 8720A | HP 8753A | HP 8702A | Description                                      |
|----------|----------|----------|----------|----------|--------------------------------------------------|
| READSOUT |          |          |          | •        | Read source file titles from disc.               |
| REAL     | •        | •        | •        | •        | Display data in real format.                     |
| RECA1    | •        | •        | •        | •        | Recall instrument state from internal registers. |
| RECA2    | •        | •        | •        | •        | "                                                |
| RECA3    | •        | •        | •        | •        | "                                                |
| RECA4    | •        | •        | •        | •        | "                                                |
| RECA5    | •        | •        | •        | •        | "                                                |
| RECA6    | •        |          |          |          | "                                                |
| RECA7    | •        |          |          |          | "                                                |
| RECA8    | •        |          |          |          | "                                                |
| RECCSTDI |          |          |          | •        | Receiver coefficient standard into memory.       |
| RECDSTDI |          |          |          | •        | Receiver disc standard into memory.              |
| REDD     | •        |          |          |          | Done with redefining parameters.                 |
| REFA     | •        |          |          |          | Reference amp. gain under system.                |
| REFD     | •        | •        | •        | •        | Reflection done, full 2-port calibration.        |
| REFL     | •        | •        | •        | •        | Begin reflection, full 2-port calibration.       |
| REFP     | •        | •        | •        | •        | Reference position.                              |
| REFT     |          | •        | •        | •        | Recall reg titles from disc.                     |
| REFV     | •        | •        | •        | •        | Reference value (level).                         |
| REIP     | •        |          |          |          | Re/Im marker on POLAR format.                    |
| RESC     | •        | •        | •        | •        | Resume cal sequence.                             |
| RESD     | •        | •        | •        | •        | Restore display after <b>OPEP</b> .              |
| RESI     | •        |          |          |          | Reset IF correction.                             |
| RESPDONE |          | •        | •        | •        | Response calibration done.                       |
| REST     | •        | •        | •        | •        | Measurement restart.                             |
| REVI     | •        | •        | •        | •        | Reverse isolation class, 2-port cal.             |
| REVM     | •        | •        | •        | •        | Reverse match class, 2-port cal.                 |
| REVT     | •        | •        | •        | •        | Reverse transmission class, 2-port cal.          |
| RIGL     | •        | •        | •        | •        | Right lower quadrant plot.                       |
| RIGU     | •        | •        | •        | •        | Right upper quadrant plot.                       |
| RIST     |          |          |          | •        | Measure rise (fall) time.                        |
| RST      |          | •        | •        | •        | Same as <b>PRES</b> (instrument preset)          |

| COMMAND  | HP 8510B | HP 8720A | HP 8753A | HP 8702A | Description                                 |
|----------|----------|----------|----------|----------|---------------------------------------------|
| —S—      |          |          |          |          |                                             |
| S11      | •        | •        | •        | •        | Measure S11.                                |
| S12      | •        | •        | •        | •        | Measure S12.                                |
| S21      | •        | •        | •        | •        | Measure S21.                                |
| S22      | •        | •        | •        | •        | Measure S22.                                |
| SADD     | •        | •        | •        | •        | Add segment to list.                        |
| SAV1     | •        | •        | •        | •        | Done with 1-port cal.                       |
| SAV2     | •        | •        | •        | •        | Done with 2-port cal.                       |
| SAVC     | •        | •        | •        | •        | Done with transfer of error coefficients.   |
| SAVE1    | •        | •        | •        | •        | Save to internal registers.                 |
| SAVE2    | •        | •        | •        | •        | "                                           |
| SAVE3    | •        | •        | •        | •        | "                                           |
| SAVE4    | •        | •        | •        | •        | "                                           |
| SAVE5    | •        | •        | •        | •        | "                                           |
| SAVE6    | •        |          |          |          | "                                           |
| SAVE7    | •        |          |          |          | "                                           |
| SAVE8    | •        |          |          |          | "                                           |
| SAVEOPTK |          |          |          | •        | Save optical user kit.                      |
| SAVERECC |          |          |          | •        | Save receiver coefficient standard.         |
| SAVESOUC |          |          |          | •        | Save source coefficient standard.           |
| SAVEUSEK |          | •        | •        | •        | Store user defined cal kit.                 |
| SAVT     | •        |          |          |          | Done with TRL 2-port cal.                   |
| SAVU?    | •        |          |          |          | Query save using binary/ASCII.              |
| SAVUASCI | •        |          |          |          | Save data ASCII (disc only).                |
| SAVUBINA | •        |          |          |          | Save data BINARY (disc only).               |
| SCAL     | •        | •        | •        | •        | Sets trace scale factor.                    |
| SCAPFULL |          | •        | •        | •        | Select full scale plot.                     |
| SCAPGRAT |          | •        | •        | •        | Plot graticule expanded to P1, P2.          |
| SDEL     | •        | •        | •        | •        | Delete current segment.                     |
| SDON     | •        | •        | •        | •        | Edit segment done.                          |
| SEAL     | •        | •        | •        | •        | Search left for target value.               |
| SEAMAX   |          | •        | •        | •        | Search active marker to maximum.            |
| SEAMIN   |          | •        | •        | •        | Search active marker to minimum.            |
| SEAOFF   |          | •        | •        | •        | Turn off marker search.                     |
| SEAR     | •        | •        | •        | •        | Search right for target value.              |
| SEATARG  |          | •        | •        | •        | Specify search marker target value.         |
| SEDI     | •        | •        | •        | •        | Enter segment number.                       |
| SEGM     | •        |          |          |          | Segment number entry under FREQ LIST—STIM.  |
| SEG?     | •        |          |          |          | Query segment sweep mode (single or all).   |
| SETF     | •        | •        | •        | •        | Set frequency low pass.                     |
| SETR?    | •        |          |          |          | Query TRL reference plane, thru or reflect. |
| SETRREFL | •        |          |          |          | TRL ref plane reference to reflect.         |

| COMMAND  | HP 8510B | HP 8720A | HP 8753A | HP 8702A | Description                                 |
|----------|----------|----------|----------|----------|---------------------------------------------|
| SETRTHRU | •        |          |          |          | TRL ref plane reference to thru.            |
| SETZ     | •        | •        | •        | •        | Set system Z0.                              |
| SIMS     | •        |          |          |          | HP-IB only — simulate standard measured.    |
| SINC     | •        |          |          |          | Single channel display.                     |
| SING     | •        | •        | •        | •        | Single group of sweeps.                     |
| SINP     | •        |          |          |          | Single point under STIMULUS.                |
| SLID     | •        | •        | •        | •        | Sliding load done.                          |
| SLIL     | •        | •        | •        | •        | Specify sliding load as standard.           |
| SLIS     | •        | •        | •        | •        | Slide is set (triggers a measurement).      |
| SLOP?    | •        |          |          |          | Query slope on/off.                         |
| SLOPE    |          |          | •        | •        | Enter the power slope value.                |
| SLOPOFF  | •        |          | •        | •        | Power slope off under STIMULUS.             |
| SLOPON   | •        |          | •        | •        | Power slope on under STIMULUS.              |
| SMIC     | •        | •        | •        | •        | Display data in Smith chart format.         |
| SMIMGB   |          | •        | •        | •        | G +jB markers on Smith format.              |
| SMIMLIN  |          | •        | •        | •        | Linear markers on Smith format.             |
| SMIMLOG  |          | •        | •        | •        | Log markers on Smith format.                |
| SMIMRI   |          | •        | •        | •        | Real/imaginary markers on Smith format.     |
| SMIMRX   |          | •        | •        | •        | R +jX markers on Smith format.              |
| SMOO?    | •        | •        | •        | •        | Query smoothing on/off.                     |
| SMOOAPER |          | •        | •        | •        | Set smoothing aperature.                    |
| SMOOOFF  | •        | •        | •        | •        | Smoothing off.                              |
| SMOOON   | •        | •        | •        | •        | Smoothing on.                               |
| SOFR     | •        | •        | •        | •        | Display software revision on screen.        |
| SOFT1    | •        | •        | •        | •        | Select softkey. (Same as pressing softkey). |
| SOFT2    | •        | •        | •        | •        | "                                           |
| SOFT3    | •        | •        | •        | •        | "                                           |
| SOFT4    | •        | •        | •        | •        | "                                           |
| SOFT5    | •        | •        | •        | •        | "                                           |
| SOFT6    | •        | •        | •        | •        | "                                           |
| SOFT7    | •        | •        | •        | •        | "                                           |
| SOFT8    | •        | •        | •        | •        | "                                           |
| SOUCSTDI |          |          |          | •        | Source coefficient into memory.             |
| SODSTDI  |          |          |          | •        | Source disc into memory.                    |
| SPAN     | •        | •        | •        | •        | Set span value (frequency or time).         |
| SPAR     |          |          |          | •        | S-parameter annotation on.                  |
| SPECADAP | •        |          |          |          | Specify adapter standard, modify cal kit.   |
| SPECFWDI | •        |          |          |          | Specify forward isolation standard.         |
| SPECFWDI | •        | •        | •        | •        | Specify forward match standard.             |
| SPECFWDT | •        | •        | •        | •        | Specify forward transmission standard.      |

| COMMAND  | HP 8510B | HP 8720A | HP 8753A | HP 8702A | Description                                            |
|----------|----------|----------|----------|----------|--------------------------------------------------------|
| SPECRESI |          | •        | •        | •        | Specify response for response & isolation cal.         |
| SPECRESP | •        | •        | •        | •        | Specify response standard.                             |
| SPECREVI | •        |          |          |          | Specify reverse isolation standard.                    |
| SPECREVM | •        | •        | •        | •        | Specify reverse match standard.                        |
| SPECREVT | •        | •        | •        | •        | Specify reverse transmission standard.                 |
| SPECS11A | •        | •        | •        | •        | Specify S11A (opens).                                  |
| SPECS11B | •        | •        | •        | •        | Specify S11B (shorts).                                 |
| SPECS11C | •        | •        | •        | •        | Specify S11C (loads).                                  |
| SPECS22A | •        | •        | •        | •        | Specify S22A (opens).                                  |
| SPECS22B | •        | •        | •        | •        | Specify S22B (shorts).                                 |
| SPECS22C | •        | •        | •        | •        | Specify S22C (loads).                                  |
| SPECTRLL | •        |          |          |          | Specify TRL line standard.                             |
| SPECTRLR | •        |          |          |          | Specify TRL reflect standard.                          |
| SPECTRLT | •        |          |          |          | Specify TRL thru standard.                             |
| SPLDOFF  |          | •        | •        | •        | Disable split graticule display.                       |
| SPLDON   |          | •        | •        | •        | Enable split graticule display.                        |
| SPLI     | •        |          |          |          | Dual channel split under DISPLAY.                      |
| SRE      |          | •        | •        | •        | Status request enable.                                 |
| SRQM     | •        |          |          |          | Define SRQ mask.                                       |
| SSEG     |          | •        |          |          | Sweep single segment of frequency list.                |
| STANA    | •        | •        | •        | •        | Select standard from class.                            |
| STANB    | •        | •        | •        | •        | "                                                      |
| STANC    | •        | •        | •        | •        | "                                                      |
| STAND    | •        | •        | •        | •        | "                                                      |
| STANE    | •        | •        | •        | •        | "                                                      |
| STANF    | •        | •        | •        | •        | "                                                      |
| STANG    | •        | •        | •        | •        | "                                                      |
| STAR     | •        | •        | •        | •        | Specify start value (frequency or time).               |
| STB?     |          | •        | •        | •        | Output status byte.                                    |
| STDD     | •        | •        | •        | •        | Standard done, modify cal kit.                         |
| STDDEFI  |          |          |          | •        | Done with optical cal standards.                       |
| STDT?    | •        |          |          |          | Query standard type.                                   |
| STDTARBI | •        | •        | •        | •        | Define standard type arbitrary $Z_0$ , modify cal kit. |
| STDTDELA | •        | •        | •        | •        | Define standard type delay/thru.                       |
| STDTFRES |          |          |          | •        | Define standard type fresnel.                          |
| STDTLOAD | •        | •        | •        | •        | Define standard type load.                             |
| STDTOPEN | •        | •        | •        | •        | Define standard type open.                             |
| STDTOTHR |          |          |          | •        | Define standard type optical thru.                     |
| STDTRCE  |          |          |          | •        | Define coefficient receiver model.                     |
| STDTRFL  |          |          |          | •        | Define optical reflector.                              |

| COMMAND     |          |          |          |          | Description                                                                  |
|-------------|----------|----------|----------|----------|------------------------------------------------------------------------------|
|             | HP 8510B | HP 8720A | HP 8753A | HP 8702A |                                                                              |
| STDTSHOR    | •        | •        | •        | •        | Define standard type short.                                                  |
| STDTSOUR    |          |          |          | •        | Define coefficient source model.                                             |
| STDTHRR     |          |          |          | •        | Define standard type thru (thru/receiver).                                   |
| STEP        | •        |          |          |          | Stepped sweep under STIMULUS.                                                |
| STOI?       | •        |          |          |          | Query storage media disc/tape.                                               |
| STOIDISC    | •        |          |          |          | Select external disc as mass storage.                                        |
| STOITAPE    | •        |          |          |          | Select internal tape as mass storage.                                        |
| STOP        | •        | •        | •        | •        | Specify stop value (frequency or time).                                      |
| STOR        | •        |          |          |          | Store tape/disc data file.                                                   |
| STORn       |          | •        | •        | •        | Store inst. state and related data to file <b>n</b> on disc, <b>n</b> = 1-5. |
| STPSIZE     | •        | •        | •        | •        | Step size for frequency list segments.                                       |
| SUBSCENT    | •        |          |          |          | Frequency subset center under FREQUENCY SUBSET.                              |
| SUBSPAN     | •        |          |          |          | Frequency subset span under FREQUENCY SUBSET.                                |
| SUBSSTAR    | •        |          |          |          | Frequency subset start under FREQUENCY SUBSET.                               |
| SUBSSTOP    | •        |          |          |          | Frequency subset stop under FREQUENCY SUBSET.                                |
| SWEA        |          | •        |          |          | Auto sweep time.                                                             |
| SWEM?       | •        |          |          |          | Query sweep mode (ramp,stepped,single,list freq, etc.).                      |
| SWET        | •        | •        | •        | •        | Set sweep time.                                                              |
| SWR         | •        | •        | •        | •        | Display data in SWR format.                                                  |
| SYNM?       | •        |          |          |          | Query sync mode (triggered sweep,free run).                                  |
| SYSB?       | •        |          |          |          | Query system bus (local/remote).                                             |
| SYSBLOCA    | •        |          |          |          | System bus "LOCAL".                                                          |
| SYSBREMO    | •        |          |          |          | System bus "REMOTE".                                                         |
| SYSP        | •        |          |          |          | Display system parameters under COPY.                                        |
| -T-         |          |          |          |          |                                                                              |
| TABD        | •        |          |          |          | Use delay table for electrical delay.                                        |
| TALKLIST    |          | •        | •        | •        | Talker/listener HP-IB mode.                                                  |
| TARV        | •        |          |          |          | Marker target value for marker to target.                                    |
| TERI        | •        | •        | •        | •        | Terminal impedance, modify cal kit.                                          |
| TESA        | •        |          |          |          | Test amp. gain under SYSTEM.                                                 |
| TESS?       |          | •        | •        | •        | Query test set present (always a 1 on HP 8720A).                             |
| TIMB        | •        |          |          |          | Time band pass under DOMAIN.                                                 |
| TIMDTRANOFF |          | •        | •        | •        | Disable time domain.                                                         |
| TIMDTRANON  |          | •        | •        | •        | Enable time domain.                                                          |
| TIML        | •        |          |          |          | Time low pass under DOMAIN (TDR).                                            |
| TITFn       |          | •        | •        | •        | Title for file <b>n</b> , <b>n</b> = 1-5.                                    |
| TITL        | •        | •        | •        | •        | Title function.                                                              |
| TITRn       |          | •        | •        | •        | Title for register <b>n</b> , <b>n</b> = 1-5.                                |
| TRACKOFF    |          | •        | •        | •        | Disable marker tracking.                                                     |
| TRACKON     |          | •        | •        | •        | Enable marker tracking.                                                      |
| TRAD        | •        | •        | •        | •        | Transmission done.                                                           |
| TRAM?       | •        |          |          |          | Query trace mode.                                                            |
| TRAN        | •        | •        | •        | •        | Call transmission standard.                                                  |
| TRAR        |          |          |          | •        | Transmission/reflection annotation.                                          |
| TRIG        | •        | •        | •        | •        | Wait for sweep trigger.                                                      |



| COMMAND  | HP 8510B | HP 8720A | HP 8753A | HP 8702A | Description                                                   |
|----------|----------|----------|----------|----------|---------------------------------------------------------------|
| TRIS     | •        |          |          |          | Trim sweep under CAL.                                         |
| TRLL     | •        |          |          |          | Measure TRL line cal std.                                     |
| TRLO     | •        |          |          |          | Modify cal kit, TRL options defined.                          |
| TRLR1    | •        |          |          |          | Meas TRL Port 1 Reflection std.                               |
| TRLR2    | •        |          |          |          | Meas TRL Port 2 Reflection std.                               |
| TRLRT    | •        |          |          |          | Meas TRL Thru standard.                                       |
| TST?     |          | •        | •        | •        | Perform self test.                                            |
| -U-      |          |          |          |          |                                                               |
| UNCC     | •        |          |          |          | Uncouple channels (Use <b>COUC</b> for HP 8700 series).       |
| UNDE     | •        |          |          |          | Undelete last deleted tape/disc file.                         |
| UP       | •        | •        | •        | •        | Up step key.                                                  |
| USED     | •        |          |          |          | User display data type for TAPE/DISC.                         |
| USEPASC  |          | •        | •        | •        | Enable pass control HP-IB mode.                               |
| USER1    | •        |          |          |          | Measure user parameters.                                      |
| USER2    | •        |          |          |          | "                                                             |
| USER3    | •        |          |          |          | "                                                             |
| USER4    | •        |          |          |          | "                                                             |
| -V-      |          |          |          |          |                                                               |
| VELOFACT | •        | •        | •        | •        | Enter velocity factor for transmission medium.                |
| -W-      |          |          |          |          |                                                               |
| WAIT     | •        | •        | •        | •        | Wait for clean sweep, and completion of previous instruction. |
| WAVD     | •        |          |          |          | Waveguide delay for electrical delay.                         |
| WAVE     | •        | •        | •        | •        | Specify waveguide offsets, modify cal kit.                    |
| WIDTOFF  |          | •        | •        | •        | Disable bandwidth search.                                     |
| WIDTON   |          | •        | •        | •        | Enable bandwidth search.                                      |
| WIDV     |          | •        | •        | •        | Set width value.                                              |
| WIND?    | •        |          |          |          | Query window.                                                 |
| WINDMAXI | •        | •        | •        | •        | Set maximum time domain window.                               |
| WINDMINI | •        | •        | •        | •        | Set minimum time domain window.                               |
| WINDNORM | •        | •        | •        | •        | Set normal time domain window.                                |
| WINDOW   |          | •        | •        | •        | Enter arbitrary time domain window.                           |
| WINDUSEM |          | •        | •        | •        | Use trace memory as window.                                   |
| WRSKn    |          | •        | •        | •        | Write soft key label <b>n</b> , <b>n</b> = 1-8.               |





For more information, call your local HP sales office listed in your telephone directory or an HP regional office listed below for the location of your nearest sales office.

**United States:**

Hewlett-Packard Company  
4 Choke Cherry Road  
Rockville, MD 20850  
(301) 670-4300

Hewlett-Packard Company  
5201 Tollview Dr.  
Rolling Meadows, IL 60008  
(312) 255-9800

Hewlett-Packard Company  
5161 Lankershim Blvd.  
No. Hollywood, CA 91601  
(818) 505-5600

Hewlett-Packard Company  
2015 South Park Place  
Atlanta, GA 30339  
(404) 955-1500

**Canada:**

Hewlett-Packard Ltd.  
6877 Goreway Drive  
Mississauga, Ontario L4V1M8  
(416) 678-9430

**Japan:**

Yokogawa-Hewlett-Packard Ltd.  
29-21, Takaido-Higashi 3-chome  
Suginami-ku, Tokyo 168  
(03) 331-6111

**Latin America:**

Hewlett-Packard de Mexico,  
Sp.A. de C.V.  
Monte Pelvux No. 111  
Lomas de Chapultepec  
11000 Mexico D.F., Mexico  
(905) 596-7933

**Australia/New Zealand:**

Hewlett-Packard Australia Ltd.  
31-41 Joseph Street,  
Blackburn, Victoria 3130  
Melbourne, Australia  
(03) 895-2895

**Far East:**

Hewlett-Packard Asia Ltd.  
47/F China Resources Building  
26 Harbour Road, Hong Kong  
(5) 833-0833

**Germany:**

Hewlett-Packard GmbH  
Vertriebzentrale Deutschland  
Hewlett-Packard-Strasse  
Postfach 1641  
6380 Bad Homburg v.d.H.  
Federal Republic of Germany  
06172/400-0

**France:**

Hewlett-Packard France  
Parc d'activite du Bois Briard  
2, avenue du Lac  
91040 Evry Cedex  
01/60 77 83 83

**United Kingdom:**

Hewlett-Packard Ltd.  
Enquiry Group  
Customer Support Centre  
Eskdale Road  
Winnersh Triangle  
Wokingham  
Berkshire RG11 5DZ  
0734/69 66 22

**Italy:**

Hewlett-Packard Italiana S.p.A.  
Via G. di Vittorio, 9  
20063 Cernusco Sul Naviglio (MI)  
Milano  
02/923691

**Northern Europe:**

Hewlett-Packard S.A.,  
Van der Hooplaan 241  
1185 LN Amstelveen  
P.O. Box 999,  
1180 AZ Amstelveen,  
The Netherlands  
(31) 20/547 9999

**South East Europe:**

Hewlett-Packard S.A.  
World Trade Center  
110, Avenue Louis-Casai  
1215 Aeroport-Geneve  
Switzerland  
(41) 22/98 96 51

**Or write to:**

**United States:**

Hewlett-Packard Company  
P.O. Box 10301,  
Palo Alto, CA 94303-0890

**Europe/Middle East/Africa:**

Hewlett-Packard Company  
Central Mailing Department,  
P.O. Box 529  
1180 AM Amstelveen,  
The Netherlands

**For all other areas:**

Hewlett-Packard Company  
Intercontinental Headquarters  
3495 Deer Creek Rd.  
Palo Alto, CA 94304  
U.S.A.

**SYSTEM OPERATING AND PROGRAMMING MANUAL**

**HP 8753B  
NETWORK ANALYZER**

**Operating and  
Programming Reference**



**HEWLETT  
PACKARD**



# HP 8753B Operating and Programming Reference

## TABLE OF CONTENTS

### Chapter 1. System Overview

|                                        |     |
|----------------------------------------|-----|
| Guide to the Chapters in this Document | 1-1 |
| HP 8753B System Overview               | 1-2 |
| HP 8753B Data Processing               | 1-3 |

### Chapter 2. Front Panel and Softkey Operation

|                                     |      |
|-------------------------------------|------|
| Active Function                     | 2-1  |
| Front Panel Keys and Softkey Menus  | 2-1  |
| Front Panel Features                | 2-4  |
| CRT Display                         | 2-6  |
| Status Notations                    | 2-7  |
| Active Channel Keys                 | 2-8  |
| Entry Block Keys                    | 2-9  |
| Rear Panel Features and Connections | 2-11 |

### Chapter 3. Stimulus Function Block

|                                                                                  |     |
|----------------------------------------------------------------------------------|-----|
| Test Set Attenuator, Test Port Transfer Switch,<br>and Doubler Switch Protection | 3-2 |
| [START], [STOP], [CENTER], and [SPAN] keys                                       | 3-3 |
| [MENU] Key (Stimulus, Power, Trigger, Sweep<br>Type, and Frequency List)         | 3-4 |

### Chapter 4. Response Function Block

|                                                                                                                                                      |      |
|------------------------------------------------------------------------------------------------------------------------------------------------------|------|
| [MEAS] Key (S-Parameter, Input Port,<br>and Conversion)                                                                                              | 4-3  |
| [FORMAT] Key (Display Format and<br>Group Delay)                                                                                                     | 4-8  |
| [SCALE REF] Key (Scale Reference)                                                                                                                    | 4-16 |
| [DISPLAY] Key (Dual Channel, Split Display,<br>CRT control, Data and Memory Functions,<br>Beep Control, D2/D1 to D2, Frequency<br>Blank, and Titles) | 4-18 |
| [AVG] Key                                                                                                                                            | 4-24 |

### Chapter 5. Measurement Calibration

|                                                                                                                              |      |
|------------------------------------------------------------------------------------------------------------------------------|------|
| Accuracy Enhancement                                                                                                         | 5-2  |
| Sources of Measurement Errors                                                                                                | 5-2  |
| Correcting for Measurement Errors                                                                                            | 5-5  |
| Why, After Calibration, Does the Frequency<br>Response of Some Calibration Standards<br>Appear as a Curve Rather Than a Dot? | 5-8  |
| Menus and Softkeys                                                                                                           | 5-10 |
| [CAL] Key (Calibration Menus and Procedures)                                                                                 | 5-10 |
| Purpose and Use of Different Calibration<br>Procedures (Table)                                                               | 5-20 |
| Response Calibration for<br>Reflection Measurements                                                                          | 5-21 |
| Response Calibration for<br>Transmission Measurements                                                                        | 5-22 |
| Response and Isolation Calibration for<br>Reflection Measurements                                                            | 5-22 |

|                                                                             |      |
|-----------------------------------------------------------------------------|------|
| Response and Isolation Calibration for<br>Transmission Measurements         | 5-23 |
| S <sub>11</sub> 1-Port Calibration for<br>Reflection Measurements           | 5-24 |
| S <sub>22</sub> 1-Port Calibration                                          | 5-25 |
| Full 2-Port Calibration for Reflection<br>and Transmission Measurements     | 5-25 |
| One-Path 2-Port Calibration for Reflection and<br>Transmission Measurements | 5-27 |
| Power Meter Calibration                                                     | 5-28 |
| Using Power Meter Calibration                                               | 5-34 |
| Modifying Calibration Kits                                                  | 5-41 |
| Verify Performance                                                          | 5-51 |
| Example Procedure                                                           | 5-52 |
| Appendix: Accuracy<br>Enhancement Fundamentals                              | 5-53 |

### Chapter 6. Using Markers

|                                                     |      |
|-----------------------------------------------------|------|
| [MKR] Key (Delta, Fixed, Mode, Polar,<br>and Smith) | 6-1  |
| [MKR FCTN] Key (Marker Function and Search)         | 6-11 |

### Chapter 7. Instrument State Function Block

|                                                                                                                                           |     |
|-------------------------------------------------------------------------------------------------------------------------------------------|-----|
| Instrument State Features and Where They<br>Are Described                                                                                 | 7-2 |
| [LOCAL] Key (HP-IB Menu and Address Menu)                                                                                                 | 7-2 |
| [SYSTEM] Key (Limit Lines Description Only)                                                                                               | 7-7 |
| See <i>Instrument State Features and Where They<br/>    Are Described</i> to determine where other<br>[SYSTEM] Key features are described |     |

### Chapter 8. Time and Frequency

#### Domain Transforms

|                                                                |      |
|----------------------------------------------------------------|------|
| General Theory                                                 | 8-2  |
| Time Domain Concepts                                           | 8-12 |
| Transforming CW Time Measurements Into the<br>Frequency Domain | 8-19 |

### Chapter 9. Making a Hard Copy Output

|            |     |
|------------|-----|
| [COPY] Key | 9-2 |
|------------|-----|

### Chapter 10. Saving Instrument States

|                                                     |      |
|-----------------------------------------------------|------|
| Types of Memory                                     | 10-1 |
| Internal Save                                       | 10-4 |
| External Store                                      | 10-5 |
| [SAVE] and [RECALL] Keys<br>(With Associated Menus) | 10-5 |

|                                             |      |
|---------------------------------------------|------|
| <b>Chapter 11. HP-IB Remote Programming</b> |      |
| How HP-IB Works .....                       | 11-2 |
| HP-IB Bus Structure .....                   | 11-3 |
| HP-IB Requirements .....                    | 11-5 |
| HP 8753B HP-IB Capabilities .....           | 11-5 |
| Bus Mode .....                              | 11-6 |
| Setting Addresses .....                     | 11-7 |
| Valid Characters .....                      | 11-7 |
| Units and Terminators .....                 | 11-8 |
| HP-IB Debug Mode .....                      | 11-8 |
| CRT Graphics .....                          | 11-8 |

|                                          |      |
|------------------------------------------|------|
| <b>Chapter 12. Error Messages</b>        |      |
| Error Messages in Alphabetic Order ..... | 12-1 |
| Error Messages in Numerical Order .....  | 12-9 |

|                                           |      |
|-------------------------------------------|------|
| <b>Chapter 13. Test Sequence Function</b> |      |
| What is Test Sequencing? .....            | 13-1 |
| Creating a Sequence .....                 | 13-2 |
| Running a Sequence .....                  | 13-2 |
| Stopping a Sequence .....                 | 13-2 |
| Changing the Sequence Title .....         | 13-3 |
| Editing a Sequence .....                  | 13-3 |
| Clearing a Sequence from Memory .....     | 13-4 |
| Storing a Sequence to Disc .....          | 13-4 |
| Loading a Sequence from Disc .....        | 13-5 |
| Purging a Sequence from Disc .....        | 13-6 |

|                                         |       |
|-----------------------------------------|-------|
| Printing a Sequence .....               | 13-6  |
| In-Depth Sequencing Information .....   | 13-6  |
| Basic Sequencing Menus .....            | 13-8  |
| Sequencing Special Functions .....      | 13-15 |
| Important Concepts .....                | 13-15 |
| Autostarting Sequences .....            | 13-16 |
| Sequencing Special Function Menus ..... | 13-16 |
| HP-GL Considerations .....              | 13-20 |
| Entering Sequences Using HP-IB .....    | 13-21 |
| Reading Sequences Using HP-IB .....     | 13-21 |
| Decision-Making Example Sequences ..... | 13-21 |

|                                                                                                                    |       |
|--------------------------------------------------------------------------------------------------------------------|-------|
| <b>Chapter 14. Instrument Modes, 6 GHz, Frequency Offset, and Harmonic Operation</b>                               |       |
| Instrument Modes .....                                                                                             | 14-2  |
| Instrument Mode Overview .....                                                                                     | 14-2  |
| Network Analyzer Mode .....                                                                                        | 14-4  |
| External Source Mode .....                                                                                         | 14-4  |
| Tuned Receiver Mode .....                                                                                          | 14-6  |
| Other Features Available Under<br>the System Key .....                                                             | 14-8  |
| Feature Overview .....                                                                                             | 14-8  |
| Frequency Offset Operation .....                                                                                   | 14-8  |
| 6 GHz Operation (Option 006 Only) .....                                                                            | 14-12 |
| Harmonic Operation (Option 002 Only) .....                                                                         | 14-14 |
| Spurious Signal Passbands in External Source<br>Mode, Tuned Receiver Mode, and Frequency<br>Offset Operation ..... | 14-17 |



# Chapter 1. System Overview

---

## CHAPTER CONTENTS

- 1-2 HP 8753B System Overview
- 1-3 HP 8753B Data Processing

## GUIDE TO THE CHAPTERS IN THIS DOCUMENT

For information on specific topics, refer to the index at the end of this volume.

This section of the *HP 8753B System Operating and Programming Manual* is a complete reference for operation of the HP 8753B network analyzer using either front panel controls, test sequence function, or an external controller. The information in this reference is intended to supplement the separately bound tutorial documents in this volume with additional details. It is divided into chapters providing the following information:

- **Chapter 1** includes a block diagram and functional description of the HP 8753B system. This is followed by descriptions of the front panel features and CRT labels, and the rear panel features and connectors.
- **Chapters 2 through 10** provide detailed information on front panel keys and softkeys, their purpose and use, HP-IB equivalents in parentheses, and expected indications and results. Specific areas of operation described in these chapters include calibration procedures for accuracy enhancement, using markers, limit testing, time domain measurements (option 010), plotting and printing, and saving instrument states. Power meter calibration and interpolated error correction are described in chapter 5.
- **Chapter 11** contains information for operating the system remotely with a controller through HP-IB.
- **Chapter 12** lists HP 8753B error messages, with explanations.
- **Chapter 13** describes the test sequencing function.
- **Chapter 14** describes tuned receiver, external source, frequency offset, as well as optional harmonic and 6 GHz instrument modes. 6 GHz mode only functions when the HP 8753B is used with an HP 85047A 6 GHz S-parameter test set. The test set contains a frequency doubler. External source and tuned receiver modes allow an HP 8753B option 006 to make measurements up to 6 GHz without an HP 85047A test set. An external source and a signal separation device are required. In addition, tuned receiver mode requires a synthesized source.

An appendix at the end of the *Operating and Programming Reference* provides a complete listing of the instrument preset state, a data processing flow diagram, a map of the operating softkey menu structure, and an alphabetical index.

## HP 8753B SYSTEM OVERVIEW

Network analyzers measure the reflection and transmission characteristics of devices and networks by applying a known swept signal and measuring the responses of the test device. The signal transmitted through the device or reflected from its input is compared with the incident signal generated by a swept RF source. The signals are applied to a receiver for measurement, signal processing, and display. A network analyzer system consists of a source, signal separation devices, a receiver, and a display.

The HP 8753B vector network analyzer integrates a high resolution synthesized RF source and a dual channel three-input receiver to measure and display magnitude, phase, and group delay of transmitted and reflected power. The HP 8753B option 010 has the additional capability of transforming measured data from the frequency domain to the time domain. Other options are explained in the *General Information and Specifications* section. Figure 1-1 is a simplified block diagram of the HP 8753B network analyzer system. A detailed block diagram of the HP 8753B is provided in the *On-Site System Service Manual*, together with complete theory of system operation.

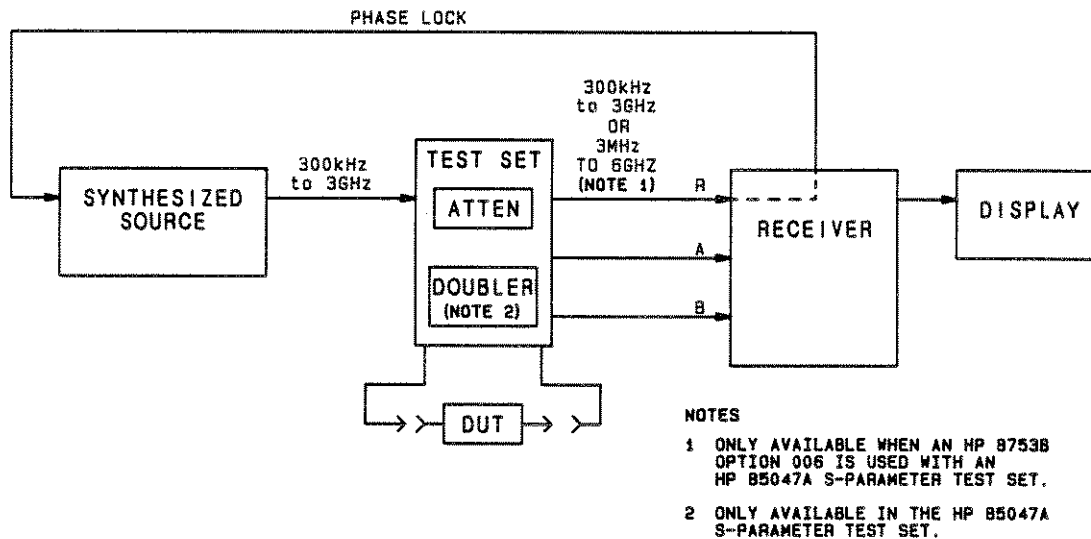

Figure 1-1. Simplified Block Diagram of the HP 8753B System

### The Built-In Synthesized Source

The built-in synthesized source of the HP 8753B produces a swept RF signal in the range of 300 kHz to 3.0 GHz. Option 006, 6 GHz receiver operation, does not change the frequency range of the HP 8753B internal source. Frequency coverage to 6 GHz must be provided by the doubler within the HP 85047A 6 GHz test set, or by an external source. The RF output power is leveled by an internal ALC (automatic leveling control) circuit. To achieve frequency accuracy and phase measuring capability, the HP 8753B is phase locked to a highly stable crystal oscillator. For this purpose, a portion of the transmitted signal is routed via the test set or other external coupling to the R input of the receiver, where it is sampled by the phase detection loop and fed back to the source.

### Test Sets

A test set provides connections to the device under test, as well as the signal separation devices that separate the incident signal from the transmitted and reflected signals. The incident signal is applied to the R (reference) input, and transmitted and reflected signals are applied to the A and/or B inputs.

The HP 85046A/B and 85047A S-parameter test sets contain the hardware required to make simultaneous transmission and reflection measurements in both the forward and reverse directions. An RF path switch in the test set is controlled by the network analyzer so that reverse measurements can be made without changing the connections to the device under test. The HP 85044A/B transmission/reflection test set contains the hardware required to make simultaneous transmission and reflection measurements in one direction only. The HP 11850C/D three-way power splitter or the HP 11667A two-way power splitter can be used for making transmission-only measurements.

**Test Set Step Attenuator.** The step attenuator contained in the test set is used to adjust the power level to the DUT without changing the level of the incident power in the reference path. The attenuator in the HP 85046A/B or 85047A test sets is controlled from the front panel of the HP 8753B. The attenuator in the HP 85044A/B test set is controlled manually.

## The Receiver Block

The receiver block contains three identical sampler/mixers for the R, A, and B inputs. The signals are sampled, and mixed to produce a 4 kHz IF (intermediate frequency). A multiplexer sequentially directs each of the three signals to the ADC (analog to digital converter) where it is converted from an analog to a digital signal to be measured and processed for display on the CRT. Both amplitude and phase information are measured simultaneously, regardless of what is displayed on the CRT.

**The Microprocessor.** A microprocessor takes the raw data and performs all the required error correction, trace math, formatting, scaling, and marker operations, according to the instructions from the front panel. The formatted data is then displayed on the CRT. The data processing sequence is described below.

## Calibration Standards

In addition to the HP 8753B and the test set (or power splitter), a measurement may require calibration standards for vector accuracy enhancement, and cables for interconnections. Model numbers and details of compatible power splitters, calibration kits, and cables are provided in the *General Information and Specifications* section of this manual.

## HP 8753B DATA PROCESSING

### Overview

The receiver of the HP 8753B converts the R, A, and B input signals into useful measurement information. This conversion occurs in two main steps. First, the swept high frequency input signals are translated to fixed low frequency IF signals, using analog sampling and/or mixing techniques. (Refer to *Theory of Operation* in the *On-Site System Service Manual* for details.) Second, the IF signals are converted into digital data by an analog-to-digital converter (ADC). From this point on, all further signal processing is performed mathematically by microprocessors in the HP 8753B. The following paragraphs describe the sequence of math operations and the resulting data arrays as the information flows from the ADC to the display. They provide a good foundation for understanding most of the response functions, and the order in which they are performed.

Figure 1-2 is a data processing flow diagram that represents the flow of numerical data from IF detection to display. The data passes through several math operations, denoted in the figure by single-line boxes. Most of these operations can be selected and controlled with the front panel RESPONSE block menus. The data is also stored in arrays along the way, denoted by double-line boxes. These arrays are places in the flow path where data is accessible, usually via HP-IB.

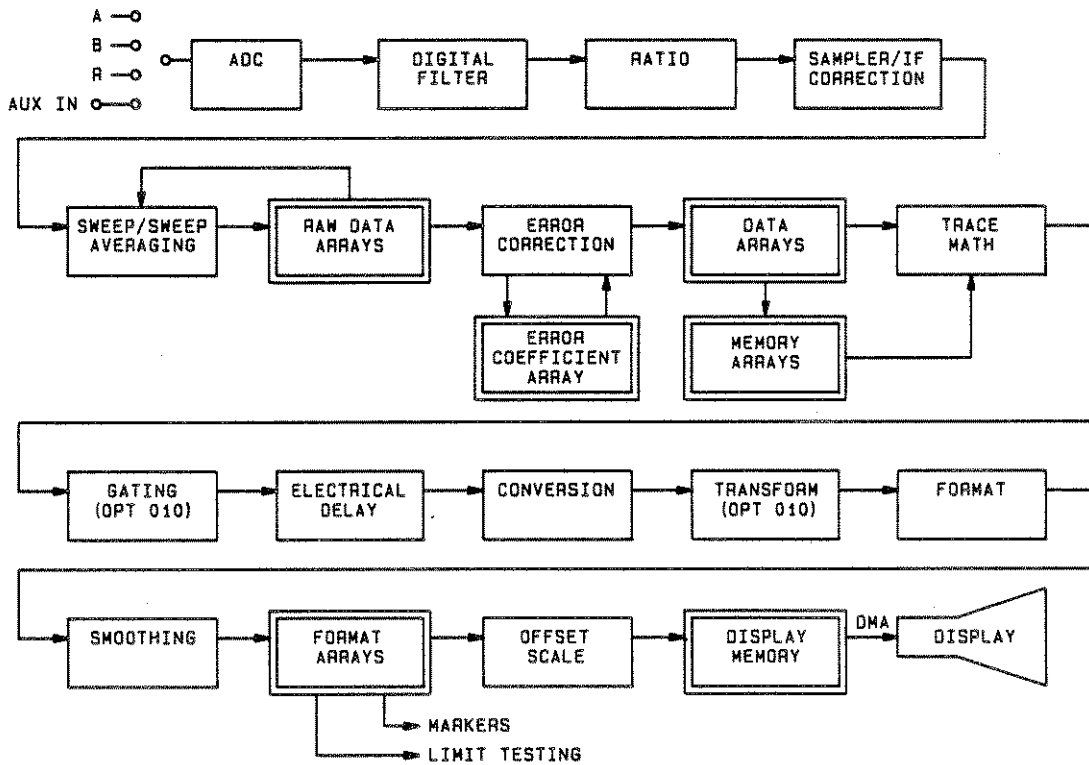

Figure 1-2. Data Processing Flow Diagram

While only a single flow path is shown, two identical paths are available, corresponding to channel 1 and channel 2. When the channels are uncoupled, each channel can be independently controlled, so that the data processing operations for one are different from the other.

Two definitions are necessary:

A "data point" or "point" is a single piece of data representing a measurement at a single stimulus value. Most data processing operations are performed point-by-point; some involve more than one point.

A "sweep" is a series of consecutive data point measurements, taken over a sequence of stimulus values. A few data processing operations require that a full sweep of data is available. The number of points per sweep can be defined by the user. Note that the meaning of the stimulus values (independent variables) can change, depending on the sweep mode, although this does not generally affect the data processing path.

## Processing Details

**The ADC.** The ADC converts the R, A, and B inputs (already down-converted to a fixed low frequency IF) into digital words. (The AUX INPUT connector on the rear panel is a fourth input.) The ADC switches rapidly between these inputs, so they are converted nearly simultaneously. (Refer to [MEAS] Key in Chapter 4 for more information on inputs.)

**IF Detection.** This occurs in the digital filter, which performs the discrete Fourier transform (DFT) on the digital words. The samples are converted into complex number pairs (real plus imaginary,  $R+jI$ ). The complex numbers represent both the magnitude and phase of the IF signal. If the AUX INPUT is selected, the imaginary part of the pair is set to zero. The DFT filter shape can be altered by changing the IF bandwidth, which is a highly effective technique for noise reduction. (Refer to [AVG] Key in Chapter 4 for information on different noise reduction techniques.)

**Ratio Calculations.** These are performed if the selected measurement is a ratio of two inputs (e.g. A/R or B/R). This is simply a complex divide operation. If the selected measurement is absolute (e.g. A or B), no operation is performed. The R, A, and B values are also split into channel data at this point. (Refer to [MEAS] Key in Chapter 4 for more information.)

**Sampler/IF Correction.** The next digital processing technique used is sampler/IF correction. This process digitally corrects for frequency response errors (both magnitude and phase, primarily sampler rolloff) in the analog down-conversion path.

**Sweep-to-sweep Averaging.** this is another noise reduction technique. This calculation involves taking the complex exponential average of several consecutive sweeps. This technique cannot be used with single-input measurements. (Refer to [AVG] Key in Chapter 4.)

**Raw Data Arrays.** These store the results of all the preceding data processing operations. (Up to this point, all processing is performed real-time with the sweep by the IF processor. The remaining operations are not necessarily synchronized with the sweep, and are performed by the main processor.) When full 2-port error correction is on, the raw arrays contain all four S-parameter measurements required for accuracy enhancement. When the channels are uncoupled (coupled channels off), there may be as many as eight raw arrays. These arrays are directly accessible via HP-IB. Note that the numbers here are still complex pairs.

**Vector Error Correction (accuracy enhancement).** Error Correction is performed next, if a measurement calibration has been performed and correction is turned on. Error correction removes repeatable systematic errors (stored in the error coefficient arrays) from the raw arrays. This can vary from simple vector normalization to full 12-term error correction. (Refer to Chapter 5 for details.)

The error coefficient arrays themselves are created during a measurement calibration using data from the raw arrays. These are subsequently used whenever correction is on, and are accessible via HP-IB.

The results of error correction are stored in the data arrays as complex number pairs. These arrays are accessible via HP-IB.

If the data-to-memory operation is performed, the data arrays are copied into the memory arrays. (Refer to [DISPLAY] Key in Chapter 4.)

**Trace Math Operation.** This selects either the data array, memory array, or both to continue flowing through the data processing path. In addition, the complex ratio of the two (data/memory) or the difference (data - memory) can also be selected. If memory is displayed, the data from the memory arrays goes through exactly the same data processing flow path as the data from the data arrays. (Refer to [DISPLAY] Key in Chapter 4 for information on memory math functions.)

**Gating.** This is a digital filtering operation associated with time domain transformation (option 010 only). Its purpose is to mathematically remove unwanted responses isolated in time. In the time domain, this can be viewed as a time-selective bandpass or band-stop filter. (If both data and memory are displayed, gating is applied to the memory trace only if gating was on when data was stored into memory.) (Refer to Chapter 8.)

**The Delay Block.** This involves adding or subtracting phase in proportion to frequency. This is equivalent to "line-stretching" or artificially moving the measurement reference plane. (Refer to [ELECTRICAL DELAY] under [SCALE/REF] Key in Chapter 4.)

**Conversion Transforms.** This transforms the measured S-parameter data to the equivalent complex impedance (Z) or admittance (Y) values, or to inverse S-parameters (1/S). (Refer to *Conversion Menu* under [MEAS] Key in Chapter 4.)

**Windowing.** This is a digital filtering operation that prepares (enhances) the frequency domain data for transformation to time domain. (Refer to Chapter 8, *Time and Frequency Domain Transforms*.)

**Time Domain Transform.** This converts frequency domain information into the time domain when transform is on (option 010 only). The results resemble time domain reflectometry (TDR) or impulse-response measurements. The transform employs the chirp-Z inverse fast Fourier transform (FFT) algorithm to accomplish the conversion. The windowing operation, if enabled, is performed on the frequency domain data just before the transform. (A special transform mode is available to "demodulate" CW sweep data, with time as the stimulus parameter, and display spectral information with frequency as the stimulus parameter.) (Refer to Chapter 8 for details.)

**Formatting.** This converts the complex number pairs into a scalar representation for display, according to the selected format. This includes group delay calculations. These formats are often easier to interpret than the complex number representation. (Polar and Smith chart formats are not affected by the scalar formatting.) Note that after formatting, it is impossible to recover the complex data. (Refer to [FORMAT] Key in Chapter 4 for information on the different formats available and on group delay principles.)

**Smoothing.** This is another noise reduction technique, that smoothes noise on the trace. When smoothing is on, each point in a sweep is replaced by the moving average value of several adjacent (formatted) points. The number of points included depends on the smoothing aperture, which can be selected by the user. The effect is similar to video filtering. If data and memory are displayed, smoothing is performed on the memory trace only if smoothing was on when data was stored into memory. (Refer to [AVG] Key in Chapter 4 for information about smoothing.)

**Format Arrays.** The results so far are stored in the format arrays. It is important to note that marker values and marker functions are all derived from the format arrays. Limit testing is also performed on the formatted data. The format arrays are accessible via HP-IB.

**Offset and Scale.** These operations prepare the formatted data for display on the CRT. This is where the reference line position, reference line value, and scale calculations are performed, as appropriate to the format. (Refer to [SCALE/REF] Key in Chapter 4.)

**Display Memory.** The display memory stores the display image for presentation on the CRT. The information here includes graticules, annotation, and softkey labels – everything visible on the CRT – in a form similar to plotter commands. If user display graphics are written, these are also stored in display memory. When hardcopy records are made, the information sent to the plotter or printer is taken from display memory.

Finally, the display memory data is sent to the CRT display. The display is updated (refreshed) frequently and asynchronously with the data processing operations, to provide a flicker-free image.

# Chapter 2. Front Panel and Softkey Operation

---

## CHAPTER CONTENTS

- 2-1 Introduction
- 2-1 Active Function
- 2-1 Front Panel Keys and Softkey Menus
- 2-4 Front Panel Features
- 2-6 CRT Display
- 2-7 Status Notations
- 2-8 Active Channel Keys
- 2-9 Entry Block Keys
- 2-11 Rear Panel Features and Connections

## INTRODUCTION

This chapter describes how to operate the HP 8753B using front panel controls, and explains the use of softkey menus. It provides illustrations and descriptions of the front panel features, the CRT display and its labels, and the rear panel features and connectors. In addition it provides details of the active channel keys and the entry block.

Functions of the HP 8753B are activated from the front panel by the operator using front panel keys or softkeys. (In this manual, all front panel keys and softkey labels are shown in brackets. Front panel keys are shown in bold print, softkeys are shown in italics.)

## ACTIVE FUNCTION

The function currently activated is called the active function, and is displayed in the active entry area at the upper left of the CRT. As long as a function is active it can be modified with the ENTRY keypad (refer to Figure 2-1). A function remains active until another function is selected, or [ENTRY OFF] is pressed.

## FRONT PANEL KEYS AND SOFTKEY MENUS

Some of the front panel keys are used to change instrument functions directly, and others provide access to additional functions available in softkey menus. Softkey menus are lists of up to eight related functions that can be displayed in the softkey label area at the right-hand side of the CRT. The eight keys to the right of the CRT are the softkeys. Pressing one of the softkeys selects the adjacent menu function. This either executes the labeled function and makes it the active function, or causes instrument status information to be displayed, or presents another softkey menu.

The HP 8753B provides more than 90 softkey menus for control of numerous operating capabilities. Some of the menus are accessed directly from front panel keys, and some from other menus. For example, the stimulus menu accessed by pressing the [MENU] key presents all the stimulus functions such as sweep type, number of points, power, sweep time, and trigger. Pressing [SWEEP TYPE] presents another menu for defining sweep type parameters, while pressing [SWEEP TIME] allows the required sweep time to be entered directly from the number pad. The [RETURN] softkeys are used to return to previous menus, while [DONE] is used both to indicate completion of a specific procedure and to return to an earlier menu. In this *Operating and Programming Reference*, the menus available from each front panel key are illustrated in "menu maps" to clearly show the sequence of keys that must be pressed to access each function. The first menu map, in Chapter 3, shows the softkey menus accessed from the [MENU] key. Detailed descriptions of each softkey function are provided with illustrations of the individual menus.

Usually, whenever a menu changes, the present active function is cleared, unless it is an active marker function.

### Why Some Softkeys are Joined by Vertical Lines

In cases where several possible choices are available for a function, they are joined by vertical lines. For example, in the input menu the available inputs and input ratios are listed: A, B, R, A/R, B/R, A/B, and only one can be selected at a time. When a selection has been made from the listed alternatives, that selection is underlined until another selection is made.

### Softkeys that Toggle On or Off

Some softkey functions can be toggled on or off, for example averaging, and this is indicated in the softkey label. The current state is reflected in the softkey label.

Example: [AVERAGING ON off] The word ON is capitalized, showing that averaging is currently on.

[AVERAGING on OFF] The word OFF is capitalized, showing that averaging is currently off.

### Softkeys that Show Status Indications in Brackets

Some softkey labels show the current status of a function in brackets. These include simple toggle functions and status-only indicators. An example of a toggled function is the [PLOT SPEED FAST] or [PLOT SPEED SLOW] softkey. The [IF BW] softkey is an example of a status-only indicator, where the selected value of the IF bandwidth is shown in brackets in the softkey label.

### Main Key Function Groups

The front panel keys that provide access to softkey menus are grouped in the STIMULUS, RESPONSE, and INSTRUMENT STATE function blocks.

**Stimulus Block.** The stimulus block keys and softkey menus control all the functions of the RF source.

**Response Block.** The response block keys and softkey menus control the measurement and display functions specific to the active channel.



**Instrument State Block.** Allows access to major instrument modes of operation shown below. The external source, tuned receiver, and frequency offset modes are described in Chapter 14.

- Network Analyzer Mode (standard analyzer operating mode).
- External Source Mode – allows phase lock to an external CW signal.
- Tuned Receiver Mode – Turns off phase locking circuitry, allows use on internal or external source.
- Frequency Offset Mode – Allows phase-locked operation for testing a frequency translating DUT such as a mixer. An external local oscillator is required.

The instrument state keys control channel-independent system functions such as copying, save/recall, HP-IB controller mode, limit testing, time domain transform (option 010) functions, 6 GHz mode (option 006), and the test sequence function.

The 6 GHz mode can only be used with HP 8753B option 006 instruments, and then only if used with an HP 85047A 6 GHz S-parameter test set. 6 GHz mode is explained in Chapter 14.

The test sequence function allows the operator to enter the keystrokes required for any given measurement, and then execute the entire test by pressing a single key. Test sequencing may also be configured to run automatically at power on. Chapter 13 describes this feature.

## **HP-IB Control**

The functions accessible from the front panel can also be accessed remotely by an external controller using HP-IB. Equivalent HP-IB commands are available for most of the front panel keys and softkey menu selections. The HP-IB programming command equivalent to each front panel and softkey function is provided in parentheses after the first reference. Additional information about HP-IB programming is provided in chapter 11.

## **Information on Keys and Softkeys that will be Provided in this Document**

The following chapters describe all the front panel keys and softkey menus in detail. The purpose and use of each function is detailed, together with expected indications and results, allowable values, and possible limitations. This information is presented in function block order. Each function block is illustrated and described in general terms. This is followed by information about each front panel key in the function block, together with a map and description of all the menus accessed from that key. Each menu is illustrated, and each softkey function in each menu is explained in detail. A complete map of the softkey menu structure is provided in Appendix A at the end of the *Operating and Programming Reference*, together with an alphabetical index.

## FRONT PANEL FEATURES

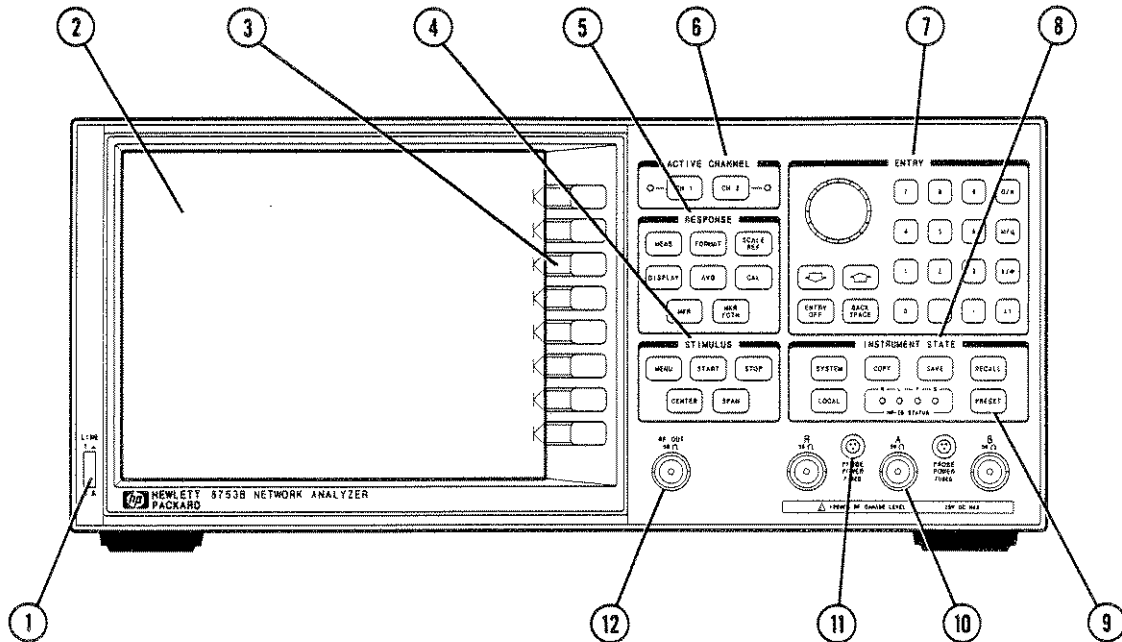

Figure 2-1. HP 8753B Front Panel

Figure 2-1 illustrates the following features and function blocks of the HP 8753B front panel. These features are described in more detail in this and subsequent chapters. Instructions for removal and cleaning of the CRT filter are provided in the *Operator's Check* section of this manual.

1. LINE switch. This controls AC power to the HP 8753B. 1 is on, 0 is off.
2. CRT display. This is used for display of data traces, measurement annotation, softkey labels, and other information. The display is divided into specific information areas, illustrated in Figure 2-2.
3. Softkeys. These keys expand the capabilities of the HP 8753B with additional functions beyond those of the front panel keys. They provide access to menu selections displayed on the CRT.
4. STIMULUS function block. The keys in this block are used to control the RF signal from the HP 8753B source, and other stimulus functions.
5. RESPONSE function block. The keys in this block are used to control the measurement and display functions of the active display channel.
6. ACTIVE CHANNEL keys. The HP 8753B has two independent display channels. These keys are used to select the active channel. Any functions that are then entered apply to this active channel.
7. The ENTRY block includes the knob, the step [▲][▼] keys, and the number pad. These are used for entering numerical data and controlling the marker.

8. INSTRUMENT STATE function block. These keys are used to control channel-independent system functions such as:

Copying, save/recall, and HP-IB controller mode.

Limit testing

External source mode

Tuned receiver mode

Frequency offset mode

Test sequence function

Time domain transform (option 010)

Harmonic Measurements (option 002)

6 GHz mode (option 006)

Also included in this block are the HP-IB STATUS indicators.

9. **[PRESET]** key. This key returns the instrument to a known standard preset state from any step of any manual procedure. A complete listing of the instrument preset condition is provided in Appendix A at the end of this *Operating and Programming Reference*.
10. Network analyzer inputs R, A, and B. These are used to receive input signals from a test set or source or device under test. Input R is used as the reference input, and a portion of the RF output signal must be routed to input R for proper phase-locked operation. The exception to this is when using tuned receiver mode. This mode is not phase-locked, and the signal may be input directly into the R, A, or B inputs. Inputs A or B are actually preferred because they offer greater dynamic range.
11. PROBE POWER connector (fused inside the instrument) supplies power to an active probe for in-circuit measurements of AC circuits.
12. RF OUT connector. This connects the RF output signal from the HP 8753B internal source to a test set or power splitter.

## CRT DISPLAY

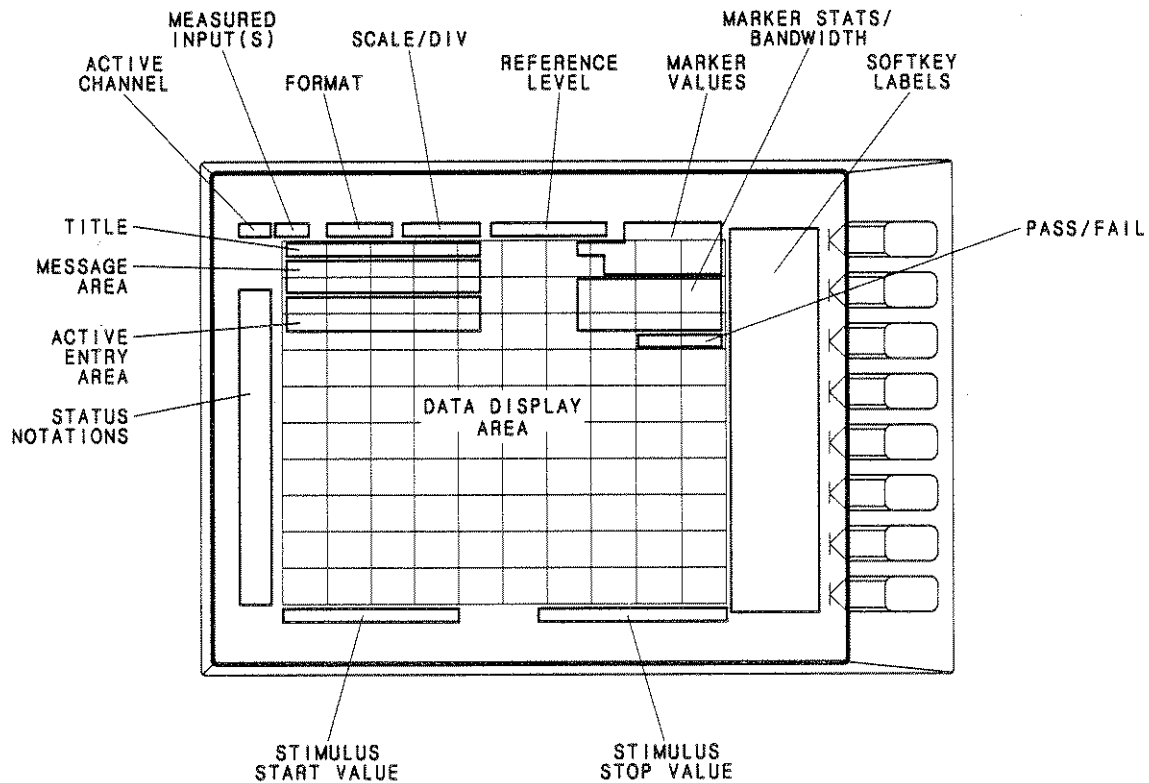

Figure 2-2. CRT Display (Single Channel, Cartesian Format)

The CRT displays the grid on which the measurement data is plotted, the currently selected measurement traces, and other information describing the measurement. Figure 2-2 illustrates the locations of the different CRT information labels, described below.

In addition to the full-screen display shown in Figure 2-2, a split display is available, as described under *[DISPLAY] Key, Display More Menu* in Chapter 4. In this case, information labels are provided for each half of the display.

Several different display formats for different measurements are illustrated and described in Chapter 4, under *[FORMAT] Key*.

**Stimulus Start Value** is the start frequency of the source in frequency domain measurements, the start time in CW mode (0 seconds) or time domain measurements, or the lower power value in power sweep. When the stimulus is in center/span mode, the center stimulus value is shown in this space.

**Stimulus Stop Value** is the stop frequency of the source in frequency domain measurements, the stop time in time domain measurements or CW sweeps, or the upper limit of a power sweep. When the stimulus is in center/span mode, the span is shown in this space. The stimulus values can be blanked, as described under *[DISPLAY] Key, Display More Menu*.

(For CW time and power sweep measurements, the CW frequency is displayed centered between the start and stop times or power values.)

**Status Notations.** This area is used to show the current status of various functions for the active channel. The following notations are used:

- Avg = Sweep-to-sweep averaging is on. The averaging count is shown immediately below (see Chapter 4, [AVG] Key).
- Cor = Error correction is on (see Chapter 5).
- C? = Stimulus parameters have changed, or interpolated error correction is on. (see Chapter 5, [CAL] Key).
- C2 = Two-port error correction is on (see Chapter 5).
- C2? = Two-port error correction is on, but stimulus parameters have changed.
- Del = Electrical delay has been added or subtracted (see Chapter 4, [SCALE REF] Key).
- x2 = 6 GHz mode is on (6 GHz receiver operation, option 006 only) (see Chapter 14).
- x2? = 6 GHz mode is on, but the user has changed the power setting. System performance is no longer specified (6 GHz receiver operation, option 006 only) (see Chapter 14).
- Ext = Waiting for an external trigger.
- OFs = Frequency Offset mode is on (see Chapter 14).
- OF? = Frequency Offset mode error, the IF frequency is not within 10 MHz of expected frequency. LO inaccuracy is the most likely cause (see Chapter 14).
- Gat = Gating is on (time domain option 010 only) (see Chapter 8).
- H=2 = Harmonic mode is on, and the second harmonic is being measured. (harmonics option 002 only) (see Chapter 14).
- H=3 = Harmonic mode is on, and the third harmonic is being measured. (harmonics option 002 only) (see Chapter 14).
- Hld = Hold sweep (see Chapter 3, *Trigger Menu*).
- man = Waiting for manual trigger.
- PC = Power meter calibration is on. (Refer to Chapter 5, [CAL] key)
- PCo = Power has been offset from the original power meter calibration sweep. (see Chapter 5).
- PC? = The HP 8753B source is in saturation. Power meter calibration is requesting more power than the internal source can supply. (see Chapter 5).
- P? = Source power is unlevelled at start or stop of sweep. (Refer to the *On-Site Service Manual* for troubleshooting.)
- P↓ = Source power has been automatically set to minimum due to overload (see Chapter 3, *Power Menu*).
- Smo = Trace smoothing is on (see Chapter 4, [AVG] Key).
- tsH = Applies only to systems equipped with an S-parameter test set. "tsH" indicates that the test set hold mode is engaged – the user has selected a mode of operation which would cause repeated switching of either the test port transfer switch or step attenuator. This hold mode may be overridden by either the [MEASUREMENT RESTART] or [NUMBER OF GROUPS] softkeys, described in Chapter 3, *Stimulus Function Block*.
- ↑ = Fast sweep indicator. This symbol is displayed in the status notation block when sweep time is less than 1.0 second. When sweep time is greater than 1.0 second, this symbol moves along the displayed trace.
- \* = Source parameters changed: measured data in doubt until a complete fresh sweep has been taken

**Active Entry Area** displays the active function and its current value.

**Message Area** displays prompts or error messages.

**Title** is a descriptive alpha-numeric string title defined by the user and entered as described under [DISPLAY] Key, *Title Menu*. (In HP-IB, the title block is replaced by HP-IB commands entered from the external controller, if the special debug mode is on. Refer to Chapter 11.)

**Active Channel** is the number of the current active channel, selected with the **[ACTIVE CHANNEL]** keys. If dual channel is on with an overlaid display, both channel 1 and channel 2 appear in this area.

**Measured Input(s)** shows the S-parameter or input or ratio of inputs currently measured, as selected using the **[MEAS]** key. Also indicated in this area is the current display memory status.

**Format** is the display format selected using the **[FORMAT]** key.

**Scale/Div** is the scale selected using the **[SCALE/REF]** key, in units appropriate to the current measurement.

**Reference Level** is the value of a reference line in Cartesian formats or the outer circle in polar formats, selected using the **[SCALE/REF]** key. The reference level is also indicated by a small triangle adjacent to the graticule, at the left for channel 1 and at the right for channel 2.

**Marker Values** are the values of the active marker, in units appropriate to the current measurement. Refer to *Using Markers*, in Chapter 6 of this section.

**Marker Stats, Bandwidth** are statistical marker values determined using the menus accessed with the **[MKR FCTN]** key. Refer to *Using Markers*.

**Softkey Labels** are menu labels displayed on the CRT that redefine the function of the softkeys immediately to the right of the CRT.

**NOTE:** The information provided here applies to Cartesian formats. In polar and Smith chart formats labeling may differ.

## ACTIVE CHANNEL KEYS (CHAN1, CHAN2)

The HP 8753B has two digital channels for independent measurement and display of data. Two different sets of data can be measured simultaneously, for example the reflection and transmission characteristics of a device, or one measurement with two different frequency spans. The data can be displayed separately or simultaneously, as described below.

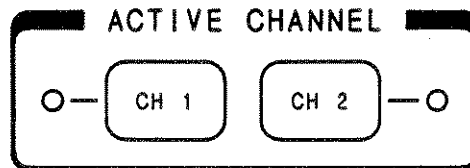

Figure 2-3

The **[CH 1]** and **[CH 2]** keys illustrated in Figure 2-3 are used to select one channel to be the "active channel". This is the channel currently controlled by the front panel keys, and its trace and data annotations are displayed on the CRT. All channel-specific functions selected apply to the active channel. The current active channel is indicated by an amber LED adjacent to the corresponding channel key.

The HP 8753B has dual trace capability, so that both the active and inactive channel traces can be displayed, either overlaid or on separate graticules one above the other (split display). When both channel traces are displayed, the annotations of the active channel are brighter. The dual channel and split display features are available in the display menus. Refer to Chapter 4 for illustrations and descriptions of the different display capabilities.

Source values can be coupled or uncoupled between the two channels, independent of the dual channel and split display functions. Refer to *Stimulus Menu* in Chapter 3 for a listing of the source values that are coupled in stimulus coupled mode.

A third coupling capability is coupled markers. Measurement markers can have the same stimulus values for the two channels, or they can be uncoupled for independent control in each channel. Refer to Chapter 6 for more information about markers.

## ENTRY BLOCK KEYS

The ENTRY block, illustrated in Figure 2-4, provides the numeric and units keypad, the knob, and the step keys. These are used in combination with other front panel keys and softkeys to modify the active entry, to enter or change numeric data, and to change the value of the active marker. In general the keypad, knob, and step keys can be used interchangeably.

Before a function can be modified, it must be made the active function by pressing a front panel key or softkey. It can then be modified directly with the knob, the step keys, or the digits keys and a terminator, as described below.

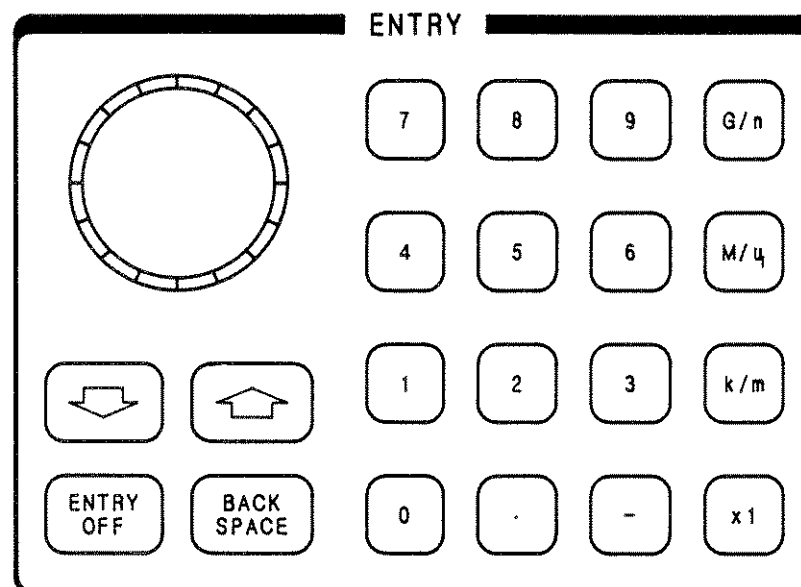

Figure 2-4

The numeric keypad is used to select digits, decimal point, and minus sign for numerical entries. A units terminator is required, as described below.

The units terminator keys are the four keys in the right-hand column of the keypad. These are used to specify units of numerical entries from the keypad and at the same time terminate the entries. A numerical entry is incomplete until a terminator is supplied, and this is indicated by the data entry arrow ← pointing at the last entered digit in the active entry area. When the units terminator key is pressed, the arrow is replaced by the units selected. The units are abbreviated on the terminator keys as follows:

G/n (HP-IB G, N) = Giga/nano ( $10^9 / 10^{-9}$ )  
M/μ(M, U) = Mega/micro ( $10^6 / 10^{-6}$ )  
k/m (K, M) = kilo/milli ( $10^3 / 10^{-3}$ )  
x1 (HZ, S, DB, V) = basic units: dB, dBm, degrees, seconds, Hz, or dB/GHz (may be used to terminate unitless entries such as averaging factor)

The knob is used to make continuous adjustments to current values for various functions such as scale, reference level, and others. If there is a marker turned on, and no other function is active, the knob can be used to adjust the marker stimulus values. Values changed by the knob are effective immediately, and require no units terminator.

The step keys [▲] (UP) and [▼] (DOWN) are used to step the current value of the active function up or down. The steps are defined by the HP 8753B for different functions and cannot be altered. No units terminator is required. For editing a test sequence, these keys allow you to scroll through the displayed sequence.

[ENTRY OFF] (ENTO) clears and turns off the active entry area, as well as any displayed prompts, error messages, or warnings. Use this function to clear the display before plotting. Another purpose of this softkey is to prevent changing of active values by accidentally moving the knob. The next selected function turns the active entry area back on.

[BACK SPACE] deletes the last entry, or the last digit entered from the number pad. For modifying a test sequence, the backspace key may be used in one of two ways:

- If pressed when modifying a single-key command like [A/R], the backspace key deletes the command.
- If pressed when entering a number like [START] [1] [2], and you have not yet pressed a terminator key ([G/n], etc), the backspace key will delete the last digit (in this example the 2 will be deleted).



## REAR PANEL FEATURES AND CONNECTORS

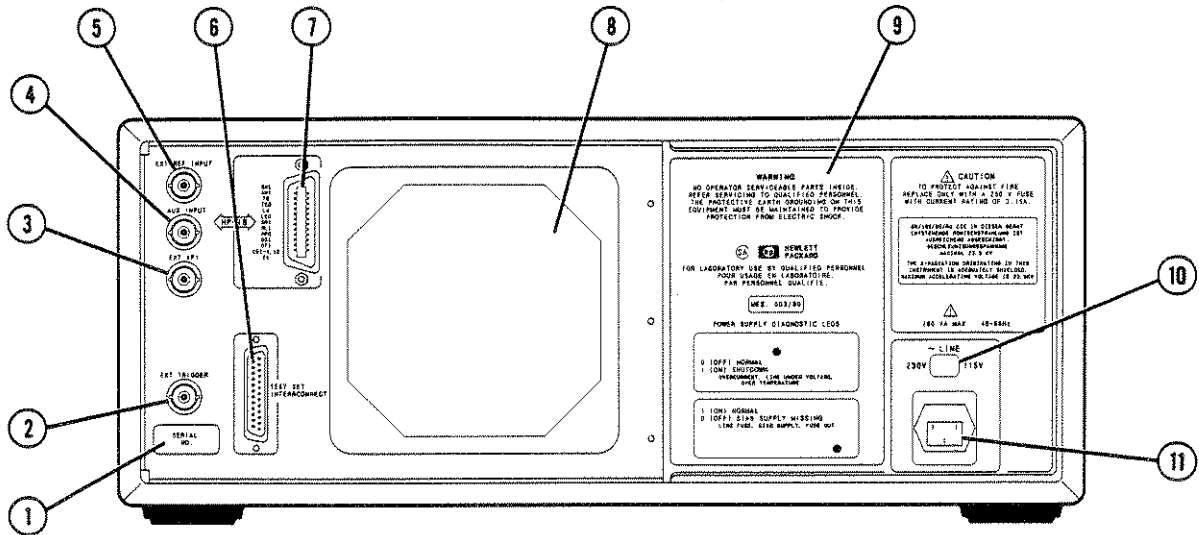

Figure 2-5

Figure 2-5 illustrates the features and connectors of the rear panel, described below. Requirements for input signals to the rear panel connectors are provided in the *Supplemental Characteristics* table of the *General Information and Specifications* section.

1. Serial number plate. For information about serial numbers, refer to *Instruments Covered by Manual* in the *General Information and Specifications* section.
2. EXT TRIGGER connector. This is used to connect an external negative-going TTL-compatible signal to trigger a measurement sweep. The trigger can be set to external through softkey functions (see Chapter 3, *Trigger Menu*).
3. EXT AM connector. This is used to connect an external analog signal to the ALC circuitry of the HP 8753B source to amplitude modulate the RF output signal.
4. AUX INPUT connector. This is used to connect a DC or AC voltage from an external signal source such as a detector or function generator, which can then be displayed and measured using the S-parameter menu. (It is also used as an analog output in service routines, as described in the service manual.)
5. EXT REF INPUT connector. This is used to input a frequency reference signal to phase lock the HP 8753B to an external frequency standard for increased frequency accuracy.

The external frequency reference feature is automatically enabled when a signal is connected to this input. When the signal is removed, the HP 8753B automatically switches back to its internal frequency reference.

6. TEST SET INTERCONNECT connects the HP 8753B to an HP 85046A/B or 85047A S-parameter test set using the interconnect cable supplied with the test set. The S-parameter test set is then fully controlled by the HP 8753B. The HP 85044A/B transmission/reflection test set does not use this interconnection.

7. HP-IB connector. This is used to connect the HP 8753B to an external controller and other instruments in an automated system. This connector is also used when the HP 8753B itself is the controller of compatible peripherals. Refer to *HP-IB Considerations* in the *System Installation* section of this manual for information and limitations. Information on different controller modes is provided in Chapter 7 under *Instrument State Function Block, [LOCAL] Key*.

8. Fan filter. This filter helps to protect the instrument from dust contamination, and should be cleaned regularly. Instructions for cleaning the filter, and other routine maintenance, are provided in the *Operator's Check* section of the manual. A minimum clearance of 15 cm (6 inches) should be maintained behind and on both sides of the instrument or rack to allow for air circulation.

**NOTE:** If using an HP 8753B with a serial prefix of 2828A and above, ignore manual references to the fan filter.

9. Safety warnings.

10. Line voltage selector switch. For more information refer to *Line Voltage and Fuse Selection* in the *System Installation* section of this manual.

11. Power cord receptacle, with fuse. For information on replacing the fuse, refer to the *System Installation* section of this manual.

# Chapter 3. Stimulus Function Block

---

## CHAPTER CONTENTS

- 3-1 Introduction
- 3-2 Test Set Attenuator, Test Port Transfer Switch, and Doubler Switch Protection
- 3-3 [START], [STOP], [CENTER], and [SPAN] Keys
- 3-4 [MENU] Key
  - 3-4 Stimulus Menu
  - 3-7 Power Menu
  - 3-9 Trigger Menu
  - 3-10 Sweep Type Menu
  - 3-13 Single/All Segment Menu
  - 3-14 Edit List Menu
  - 3-15 Edit Sub sweep Menu

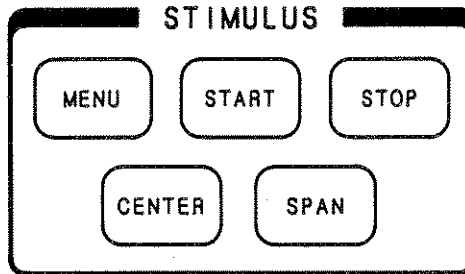

Figure 3-1

## INTRODUCTION

The stimulus function block keys and associated menus are used to define and control the source RF output signal to the device under test. The source signal can be swept over any portion of the instrument's frequency and power range. The stimulus keys also control the start and stop times in the optional time domain mode. The menus are used to set all other source characteristics such as sweep time and resolution, source RF power level, the number of data points taken during the sweep, and S-parameter test set attenuation.

# TEST SET ATTENUATOR, TEST PORT TRANSFER SWITCH, AND DOUBLER SWITCH PROTECTION

## Test Port Transfer Switch

An S-parameter test set can only send power to one test port at a time. A mechanical transfer switch sends power to either port 1 or port 2. Under some measurement conditions it would be necessary to repetitively switch power between port 1 and port 2. This cannot be allowed continuously or the switch would wear out prematurely. Two examples are listed below:

- During full two-port calibration operation: Full 12 term calibration requires that all four S-parameters ( $S_{21}$ ,  $S_{11}$ ,  $S_{12}$ ,  $S_{22}$ ) be measured for each sweep. This would require the transfer switch to engage twice each sweep. To avoid this, only the first measurement uses the transfer switch to measure all four S-parameters (12 term correction). Subsequent sweeps do not use the switch, and only two S-parameters are measured (8 term correction). The operator can make the instrument measure all four S-parameters again using the **[MEASUREMENT RESTART]** or **[NUMBER OF GROUPS]** softkeys described below.
- When port 1 and port 2 are driven by different channels: For example, when channel 1 is set to measure  $S_{21}$  and channel 2 is set to measure  $S_{12}$  – and dual channel display is turned on. This creates a condition which would cause repeated switching of the transfer switch. When this occurs, the “test set hold mode” engages. This mode will not allow switching to occur, and displays the status notation “tsH” on the left side of the screen. **[MEASUREMENT RESTART]** and **[NUMBER OF GROUPS]** softkeys will override the test set hold mode, and allow switching to occur. If averaging is on, the hold mode will not engage until the specified number of sweeps are completed.

## Attenuator

The S-parameter test set contains one programmable step attenuator, which is switched between port 1 and port 2 depending on measurement needs. In some circumstances, the two ports could be used alternately, with each requiring a different attenuation value. This would cause repeated switching of the mechanical attenuator, and therefore excessive wear. An example is given below:

- Channels 1 and 2 are decoupled, different attenuation values have been selected for each channel, and dual channel display is engaged. When this occurs, the test set hold mode engages, and does not allow repetitive attenuator switching. **[MEASURE RESTART]** and **[NUMBER OF GROUPS]** softkeys will override the test set hold mode. If averaging is on, the hold mode will not engage until the specified number of sweeps is completed.

## **[MEASURE RESTART]** and **[NUMBER OF GROUPS]** Softkeys

Both of these softkeys will allow measurements which demand repetitive switching of either the test port transfer switch or step attenuator.

- **[MEASURE RESTART]** will allow one such measurement to occur.
- **[NUMBER OF GROUPS]** will allow a specified number of such measurements to occur.

These two softkeys are explained in detail later in this chapter.

## **Doubler Switch Protection (Only Applies to the HP 85047A)**

The HP 85047A S-parameter test set uses a frequency doubler to switch between 3 and 6 GHz operation. Because the doubler uses a mechanical switch, operations which would require repetitive switching between the two modes are not permitted. For this reason, 6 GHz mode is either on or off for both channels. There is no override for this protective feature.

## **[START], [STOP], [CENTER], AND [SPAN] KEYS**

[START] (STAR)  
[STOP] (STOP)  
[CENTER] (CENT)  
[SPAN] (SPAN)

These keys are keys used to define the frequency range or other horizontal axis range of the stimulus. The range can be expressed as either start/stop or center/span. When one of these keys is pressed, its function becomes the active function. The value is displayed in the active entry area and can be changed with the knob, step keys, or number pad. Current stimulus values for the active channel are also displayed along the bottom of the graticule. Frequency values can be set to zero for security purposes, using the display menus.

The preset stimulus mode is frequency, and the start and stop stimulus values are set to 300 kHz and 3 GHz respectively. In the time domain (option 010) or in CW time mode, the stimulus keys refer to time (with certain exceptions that are explained in Chapter 8, *Time and Frequency Domain Transforms*). In power sweep, the stimulus value is in dBm.

Because the display channels are independent, the stimulus signals for the two channels can be uncoupled and their values set independently. The values are then displayed separately on the CRT if the instrument is in dual channel display mode. In the uncoupled mode with dual channel display the instrument takes alternate sweeps to measure the two sets of data. Channel stimulus coupling is explained in this chapter, and dual channel display capabilities are explained in Chapter 4, *Response Function Block*.

# [MENU] KEY

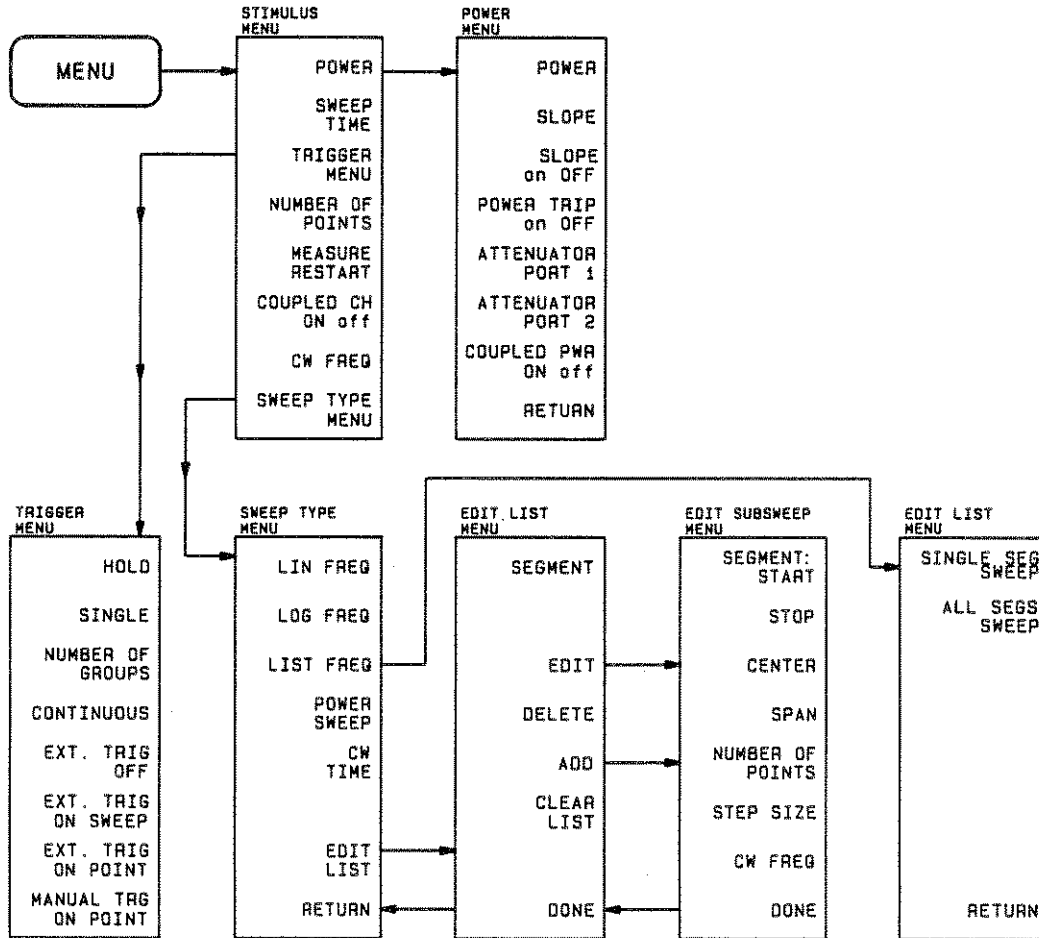

Figure 3-2. Softkey Menus Accessed from the [MENU] Key

The [MENU] (MENUSTIM) key provides access to the series of menus illustrated in Figure 3-2, which are used to define and control all stimulus functions other than start, stop, center, and span. When the [MENU] key is pressed, the stimulus menu is displayed. This in turn provides access to the other illustrated softkey menus. The functions available in these menus are described in the following pages.

## Stimulus Menu

The stimulus menu is used to specify the sweep time, number of measurement points per sweep, and CW frequency. It includes the capability to couple or uncouple the stimulus functions of the two display channels, and the measurement restart function. In addition, it leads to other softkey menus that define power level, trigger type, and sweep type. The individual softkey functions of the stimulus menu are described below.

**Continuous Switching of Test Set Attenuator or Port Transfer Switch.** To avoid premature wearing out of either the transfer switch or attenuator, measurement configurations requiring continuous switching are not allowed without direct intervention of the operator. Measurement configurations which would cause this to occur are listed in *Test Set Attenuator*, *Test Port Transfer Switch*, and *Doubler Switch Protection*, in the beginning of this chapter. Full two-port error correction is one such configuration, as well as any measurement which causes the status annotation "tsH" (test set hold) to appear on the left side of the screen. **[MEASUREMENT RESTART]** and **[NUMBER OF GROUPS]** softkeys can override this protection feature, and are described later in this chapter.

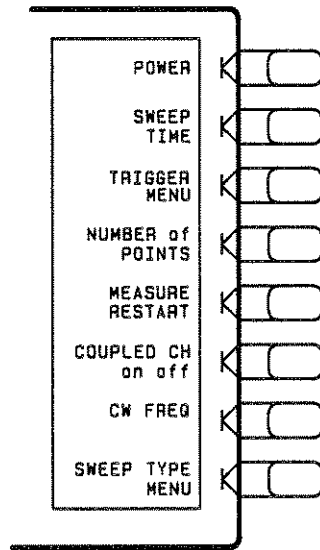

Figure 3-3

**[POWER]** (POWE) makes power level the active function and presents the power menu, which is used to set the output power level and slope compensation of the source, and control the attenuator in an HP 85046A/B or 85047A programmable S-parameter test set.

**[SWEEP TIME [ ]]** (SWET) toggles between automatic and manual sweep time. The difference between automatic and manual sweep time is:

- **Manual Sweep Time.** As long as the selected sweep speed is within the capability of the instrument, it will remain fixed, regardless of changes to other measurement parameters. If the operator changes measurement parameters such that the instrument can no longer maintain the selected sweep time, the HP 8753B will change to the best sweep time possible.
- **Auto Sweep Time.** Auto sweep time continuously maintains the fastest sweep speed possible with the selected measurement parameters.

Sweep time refers only to the time that the instrument is sweeping and taking data, and does not include the time required for internal processing of the data. A sweep speed indicator ↑ is displayed on the trace for sweep times slower than 1.0 second. For sweep times faster than 1.0 second the ↑ indicator is displayed in the status notations area at the left of the CRT.

**Minimum Sweep Time.** The minimum sweep time is dependent on several factors. These factors are referred to as "measurement parameters" in the following paragraphs.

- The number of points selected
- IF bandwidth
- Sweep-to-sweep averaging in dual channel display mode
- Smoothing
- Limit lines
- Error correction
- Trace math
- Marker statistics
- Time domain
- Type of sweep

The following table is a partial guide for determining the minimum sweep time for the listed measurement parameters. The values listed represent the minimum time required for a CW time measurement with averaging off. Values are given in seconds.

| Number of Points | IF Bandwidth |         |        |       |
|------------------|--------------|---------|--------|-------|
|                  | 3000 Hz      | 1000 Hz | 300 Hz | 10 Hz |
| 11               | 0.0055       | 0.012   | 0.036  | 1.14  |
| 51               | 0.0255       | 0.06    | 0.166  | 5.3   |
| 101              | 0.0505       | 0.12    | 0.328  | 10.5  |
| 201              | 0.1005       | 0.239   | 0.653  | 20.9  |
| 401              | 0.2005       | 0.476   | 1.303  | 41.7  |
| 801              | 0.4005       | 0.951   | 2.603  | 83.3  |
| 1601             | 0.8005       | 1.901   | 5.203  | 166.5 |

Sweep time may be used in manual or auto modes. These are explained below.

**Manual Sweep Time Mode.** When this mode is active, the softkey label reads **[SWEEP TIME [MANUAL]]**. This mode is engaged whenever the operator enters a sweep time greater than zero. This mode allows the operator to select a fixed sweep time. If the operator changes the measurement parameters such that the current sweep speed is no longer possible, the HP 8753B will automatically change to the fastest sweep speed possible.

**Auto Sweep Time Mode.** When this mode is active, the softkey label reads **[SWEEP TIME [AUTO]]**. This mode is engaged whenever the operator enters **[0] [x1]** as a sweep speed. Auto sweep time continuously maintains the fastest sweep speed possible with the selected measurement parameters.

**[TRIGGER MENU]** goes to the trigger menu, which is used to select the type and number of the sweep trigger.

**[NUMBER OF POINTS]** (POIN) is used to select the number of data points per sweep to be measured and displayed. Using fewer points allows a faster sweep time but the displayed trace shows less horizontal detail. Using more points gives greater data density and improved trace resolution, but slows the sweep and requires more memory for error correction or saving instrument states.

The possible values that can be entered for number of points are 3, 11, 26, 51, 101, 201, 401, 801, and 1601. The number of points can be different for the two channels if the stimulus values are uncoupled.



In list frequency sweep, the number of points displayed is the total number of frequency points for the defined list (see *Sweep Type Menu*).

**[MEASURE RESTART]** (REST) aborts the sweep in progress, then restarts the measurement. This can be used to update a measurement following an adjustment of the device under test. When a full two-port calibration is in use, the **[MEASURE RESTART]** key will initiate another update of both forward and reverse S-parameter data. This softkey will also override the test set hold mode, which inhibits continuous switching of either the test port transfer switch or step attenuator. The measurement configurations which cause this are described in *Test Set Attenuator, Test Port Transfer Switch, and Doubler Switch Protection*, at the beginning of this section. This softkey will override the test set hold mode for one measurement.

If the HP 8753B is taking a number of groups (see *Trigger Menu*), the sweep counter is reset at 1. If averaging is on, **[MEASURE RESTART]** resets the sweep-to-sweep averaging and is effectively the same as **[AVERAGING RESTART]**. If the sweep trigger is in **[HOLD]** mode, **[MEASURE RESTART]** executes a single sweep.

**[COUPLED CH on OFF]** (COUCON, COUCOFF) toggles the channel coupling of stimulus values. With **[COUPLED CH ON]** (the preset condition), both channels have the same stimulus values (the inactive channel takes on the stimulus values of the active channel).

In the stimulus coupled mode, the following parameters are coupled:

|                         |                       |
|-------------------------|-----------------------|
| Frequency               | Number of points      |
| Source power            | Number of groups      |
| Power slope             | IF bandwidth          |
| Sweep time              | Time domain transform |
| Trigger type            | Gating                |
| Sweep type              | Harmonic measurement  |
| Power meter calibration |                       |

Coupling of stimulus values for the two channels is independent of **[DUAL CHAN on OFF]** in the display menu and **[MARKERS: UNCOUPLED]** in the marker mode menu. **[COUPLED CH OFF]** becomes an alternate sweep function when dual channel display is on: in this mode the HP 8753B alternates between the two sets of stimulus values for measurement of data, and both are displayed.

**[CW FREQ]** (CWFREQ) is used to set the frequency for power sweep and CW time sweep modes. If the instrument is not in either of these two modes, it is automatically switched into CW time mode.

**[SWEEP TYPE MENU]** presents the sweep type menu, where one of the available types of stimulus sweep can be selected.

## Power Menu

The power menu is used to set the output power level of the source, to set power slope to compensate for measured power loss with frequency, and to control the programmable attenuator in an HP 85046A/B or 85047A S-parameter test set.

**Power Output During 6 GHz Operation.** When the HP 8753B option 006 and HP 85047A 6 GHz test set are used together in a system, the 6 GHz mode may be engaged. In this mode, the HP 8753B sets the RF output power to +20 dBm. This is the power level which allows optimum performance of the 6 GHz test set. Limited changes to power level may be allowed: refer to Chapter 14. If the system is changed back to the 3 GHz mode, the RF power output of the HP 8753B automatically changes to 0 dBm.

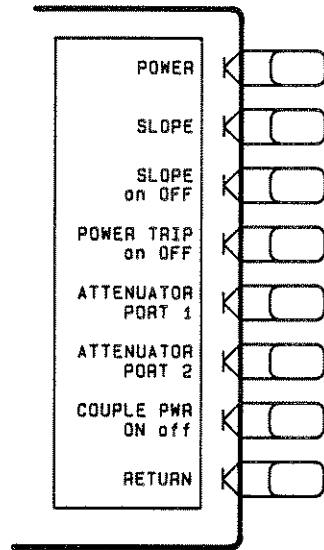

Figure 3-4

**[POWER]** (POWE) makes power level the active function and sets the RF output power level of the HP 8753B internal source. The HP 8753B will detect an input power overload at any of the three receiver inputs, and automatically reduce the output power of the source to  $-5$  dBm. This is indicated with the message "OVERLOAD ON INPUT (R, A, B)." In addition, the **[POWER TRIP ON]** flag (see below) is set, and the annotation "P↓" appears at the left side of the CRT. When this occurs, toggle the power trip off and reset the power at a lower level.

If the source power is unlevelled at the start or stop of a sweep, the notation "P?" is displayed at the left of the CRT. This indicates that the automatic leveling control circuit of the source is unable to keep the source power leveled to instrument specifications, and the power is therefore potentially uncalibrated. The "P?" notation is removed only after a sweep in which the source power is detected to be leveled at both the start and stop of the sweep. Refer to the *On-Site System Service Manual* for troubleshooting information.

**[SLOPE]** (SLOPE) compensates for power loss versus the frequency sweep, by sloping the output power upwards proportionally to frequency. Use this softkey to enter the power slope in dB per GHz of sweep.

**[SLOPE on OFF]** (SLOPON, SLOPOFF) toggles the power slope function on or off. With slope on, the output power increases with frequency, starting at the selected power level.

**[POWER TRIP on OFF]** (POWTON, POWTOFF) toggles the power trip function on or off. Power trip is a reduced power state triggered by a power overload. It forces the source output power to  $-5$  dBm regardless of the user-specified power level. The trip is set automatically whenever a power overload is detected on an input channel. When trip is on, the annotation "P↓" appears in the status notations area of the display.

To reset the power level following a power trip, toggle the power trip **OFF**.

**[ATTENUATOR PORT 1]** (ATTP1) controls the attenuation at port 1 of an HP 85046A/B or 85047A S-parameter test set connected to the HP 8753B. The attenuator range is 0 to 70 dB, controllable in 10 dB steps. Attenuation is used to reduce the signal level at the test port without reducing the reference signal, for example to perform measurements of amplifiers.

The S-parameter test set must be interfaced with the HP 8753B through the test set interconnect cable for the attenuator control signal to be enabled. Note that no warning is given if no test set is present, or if the test set has no programmable attenuator (as in the HP 85044A/B transmission/reflection test set).

**[ATTENUATOR PORT 2]** (ATTP2) serves the same function for the attenuation at port 2 of the HP 85046A/B or 85047A S-parameter test set.

**NOTE:** The HP 8753B does not allow port 1 and 2 to be set to different attenuator values. This is required because the same attenuator is used for both ports, and is mechanically switched between them. To prevent premature wearing out, continuous switching of attenuator values between ports is not allowed.

**[COUPLE PWR ON off]** (COUPON COUPOFF) is intended for use with the **[D2/D1 to D2 on OFF]** softkey. The D2/D1 to D2 function is used in harmonic measurements, where the fundamental is displayed on channel 1 and the harmonic on channel 2. D2/D1 to D2 ratios the two, displaying the fundamental and relative power of the measured harmonic in dBc. When making such measurements, channel 1 and 2 must be uncoupled with the **[COUPLED CHAN ON off]** softkey set to OFF to allow alternating sweeps.

After uncoupling channel 1 and 2, the operator may wish to change the power level of the fundamental and see resultant change in relative harmonic power (in dBc). **[COUPLE PWR ON off]** allows the operator to change the power of both channels simultaneously (coupled power), even though they are uncoupled in all other respects.

Turning **[COUPLE PWR ON off]** off can uncouple power only if channels 1 and 2 are uncoupled.

**[RETURN]** goes back to the stimulus menu.

## Trigger Menu

This menu is used to select the type and number of the sweep trigger.

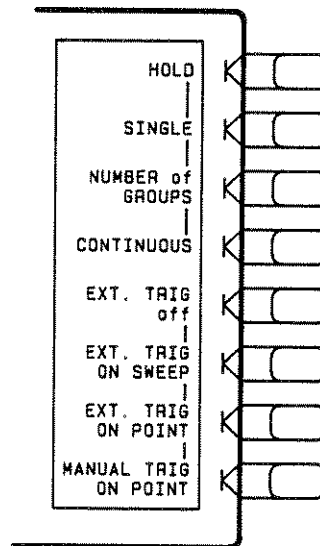

Figure 3-5

**[HOLD]** (HOLD) freezes the data trace on the display, and the HP 8753B stops sweeping and taking data. The notation "Hld" is displayed at the left of the graticule. If the \* indicator is on at the left side of the CRT, trigger a new sweep with **[SINGLE]**.

**[SINGLE]** (SING) takes one sweep of data and returns to the hold mode.

**[NUMBER OF GROUPS]** (NUMG) triggers a user-specified number of sweeps, and returns to the hold mode. This function can be used to override the test set hold mode, which protects the electro-mechanical transfer switch and attenuator against continuous switching. This is explained fully in the *Test Set Attenuator, Test Port Transfer Switch, and Double Switch Protection* description in the beginning of this chapter.

If averaging is on, the number of groups should be at least equal to the averaging factor selected, to allow measurement of a fully averaged trace. Entering a number of groups resets the averaging counter to 1.

**[CONTINUOUS]** (CONT) is the standard sweep mode of the HP 8753B, in which the sweep is triggered automatically and continuously and the trace is updated with each sweep.

**[EXT. TRIG OFF]** (EXTTOFF) turns off external trigger mode.

**[EXT TRIG ON SWEEP]** (EXTTON) is used when the sweep is triggered on an externally generated signal connected to the rear panel EXT TRIGGER input. The sweep is started with a high-to-low transition of a TTL signal. If this key is pressed when no external trigger signal is connected, the notation "Ext" is displayed at the left side of the CRT to indicate that the HP 8753B is waiting for a trigger. When a trigger signal is connected, the "Ext" notation is replaced by the sweep speed indicator ↑ either in the status notations area or on the trace. External trigger mode is allowed in every sweep mode.

**[EXT TRIG ON POINT]** (EXTTPOIN) is similar to the trigger on sweep, but triggers each data point in a sweep.

**[MANUAL TRG ON POINT]** waits for a manual trigger for each point. Subsequent pressing of this softkey triggers each measurement. The annotation "man" will appear at the left side of the CRT when the instrument is waiting for the trigger to occur. This feature is useful in a test sequence when an external device or instrument requires changes at each point.

## Sweep Type Menu

Five sweep types are available:

- Linear frequency sweeps in Hz. In the linear frequency sweep mode it is possible, with option 010, to transform the data for time domain measurements using the inverse Fourier transform technique.
- Logarithmic frequency sweeps in Hz.
- Power sweeps in dBm.
- CW time sweep in seconds. In the CW time sweep mode, the data can be transformed for frequency domain measurements. Refer to Chapter 8 for detailed information about time domain transform with option 010.
- List frequency sweep in Hz. A new feature is the single segment mode, where any single segment in a frequency list may be selected. The single segment will retain the same error correction as the original list of frequencies.

**Interpolated Error Correction.** The interpolated error correction feature will function with the following sweep types:

- Linear frequency
- Power sweep
- CW time

Interpolated error correction will not work in log or list sweep modes. Refer to Chapter 5 for more information on interpolated error correction.

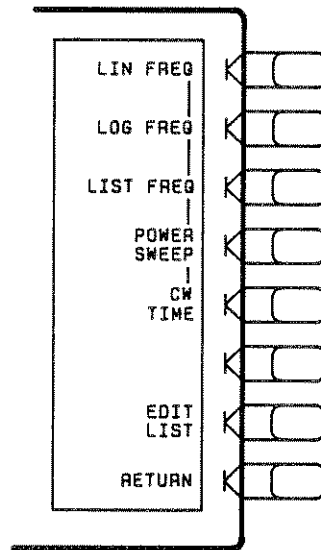

Figure 3-6

**[LIN FREQ]** (LINFREQ) activates a linear frequency sweep displayed on a standard graticule with ten equal horizontal divisions. This is the default preset sweep type.

For a linear sweep, sweep time is combined with the channel's frequency span to compute a source sweep rate:

$$\text{sweep rate} = (\text{frequency span}) / (\text{sweep time})$$

Since the sweep time may be affected by various factors (see *Stimulus Menu*), the equation provided here is merely an indication of the ideal (maximum) sweep rate. If the user-specified sweep time is greater than 15 ms times the number of points, the sweep changes from a continuous ramp sweep to a stepped CW sweep. Also for narrow IF bandwidths the sweep is automatically converted to a stepped CW sweep.

**[LOG FREQ]** (LOGFREQ) activates a logarithmic frequency sweep mode. The source is stepped in logarithmic increments and the data is displayed on a logarithmic graticule. This is slower than a continuous sweep with the same number of points, and the entered sweep time may therefore be changed automatically. For frequency spans of less than two octaves, the sweep type automatically reverts to linear sweep.

**[LIST FREQ]** (LISTFREQ) provides a user-definable arbitrary frequency list mode. This list is defined and modified using the edit list menu and the edit subsweep menu. Up to 30 frequency subsweeps (called "segments") of several different types can be specified, for a maximum total of 1632 points. One list is common to both channels. Once a frequency list has been defined and a measurement calibration performed on the full frequency list, one or all of the frequency segments can be measured and displayed without loss of calibration.

When the **[LIST FREQ]** key is pressed the network analyzer sorts all the defined frequency segments into CW points in order of increasing frequency. It then measures each point and displays a single trace that is a composite of all data taken. If duplicate frequencies exist, the HP 8753B makes multiple measurements on identical points to maintain the specified number of points for each subsweep. Since the frequency points may not be distributed evenly across the CRT, the display resolution may be uneven, and more compressed in some parts of the trace than in others. However, the stimulus and response readings of the markers are always accurate. Because the list frequency sweep is a stepped CW sweep, the sweep time is slower than for a continuous sweep with the same number of points.

The **[LIST FREQ]** softkey presents the segment menu, which allows the operator to select any single segment in the frequency list. Refer to *Edit List Menu* and *Edit Subsweep Menu* later in this chapter to see how to enter or modify the list frequencies. If no list has been entered, the message "CAUTION: LIST TABLE EMPTY" is displayed.

A tabular printout of the frequency list data can be obtained using the **[LIST VALUES]** function in the copy menu.

**[POWER SWEEP]** (POWS) turns on a power sweep mode that is used to characterize power-sensitive circuits. In this mode, power is swept at a single frequency, from a start power value to a stop power value, selected using the **[START]** and **[STOP]** keys and the entry block. This feature is convenient for such measurements as gain compression or AGC (automatic gain control) slope. To set the frequency of the power sweep, use **[CW FREQ]** in the stimulus menu. Refer to the *User's Guide* for an example of a gain compression measurement.

Note that the attenuator switch in the S-parameter test set is not switched in power sweep mode.

In power sweep, the entered sweep time may be automatically changed if it is less than the minimum required for the current configuration (number of points, IF bandwidth, averaging, etc.).

**[CW TIME]** (CWTIME) turns on a sweep mode similar to an oscilloscope. The HP 8753B is set to a single frequency, and the data is displayed versus time. The frequency of the CW time sweep is set with **[CW FREQ]** in the stimulus menu. In this sweep mode, the data is continuously sampled at precise, uniform time intervals determined by the sweep time and the number of points minus 1. The entered sweep time may be automatically changed if it is less than the minimum required for the current instrument configuration.

In time domain using option 010, the CW time mode data is translated to frequency domain, and the x-axis becomes frequency. This can be used like a spectrum analyzer to measure signal purity, or for low frequency (>1 kHz) analysis of amplitude or pulse modulation signals. For details, refer to Chapter 8.

**[EDIT LIST]** presents the edit list menu. This is used in conjunction with the edit subsweep menu to define or modify the frequency sweep list. The list frequency sweep mode is selected with the **[LIST FREQ]** softkey described above.

**[RETURN]** goes back to the stimulus menu.

## Single/All Segment Menu

When this menu is presented, the frequency list table is displayed in the center of the CRT. A segment can then be selected to be measured, and the choice of a full-trace measurement or a single-segment measurement can be made.

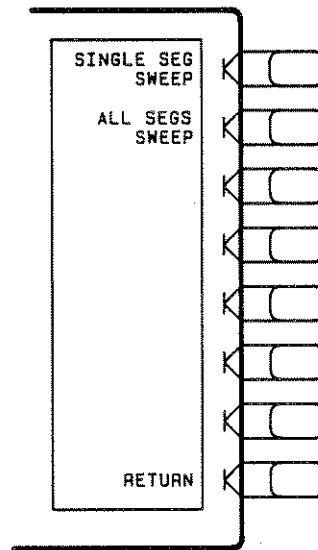

Figure 3-7

**[SINGLE SEG SWEEP]** (SSEG) enables a measurement of a single segment of the frequency list, without loss of calibration. The segment to be measured is selected using the entry block.

In single segment mode, selecting a measurement calibration will force the full list sweep before prompting for calibration standards. The calibration will then be valid for any single segment.

If an instrument state is saved in memory with a single-segment trace, a recall will re-display that segment while also recalling the entire list.

**[ALL SEGS SWEEP]** (ASEG) retrieves the full frequency list sweep.

**[RETURN]** goes back to the sweep type menu

## Edit List Menu

This menu is used to edit the list of frequency segments (subsweeps) defined with the edit subsweep menu, described next. Up to 30 frequency subsweeps can be specified, for a maximum of 1632 points. The segments do not have to be entered in any particular order: the HP 8753B automatically sorts them and lists them on the CRT in increasing order of start frequency. This menu determines which entry on the list is to be modified, while the edit subsweep menu is used to make changes in the frequency or number of points of the selected entry.

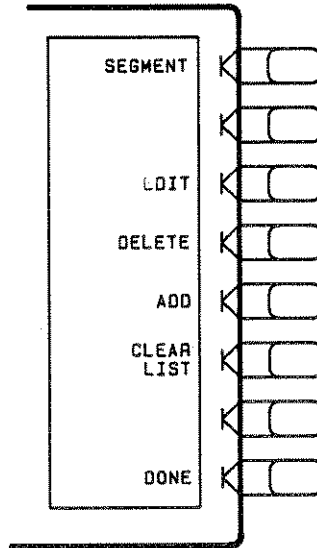

Figure 3-8

**[SEGMENT]** determines which segment on the list is to be modified. Enter the number of a segment in the list, or use the step keys to scroll the pointer > at the left to the required segment number. The indicated segment can then be edited or deleted.

**[EDIT]** goes to the edit subsweep menu, where the segment indicated by the pointer > at the left can be modified.

**[DELETE]** deletes the segment indicated by the pointer >.

**[ADD]** is used to add a new segment to be defined with the edit subsweep menu. If the list is empty, a default segment is added, and the edit subsweep menu is displayed so it can be modified. If the list is not empty, the segment indicated by the pointer > is copied and the edit subsweep menu is displayed.

**[CLEAR LIST]** clears the entire list.

**[DONE]** sorts the frequency points and returns to the sweep type menu.



## Edit Subsweep Menu

This menu lets you select measurement frequencies arbitrarily. Using this menu it is possible to define the exact frequencies to be measured on a point-by-point basis. For example the sweep could include 100 points in a narrow passband, 100 points across a broad stop band, and 50 points across the third harmonic response. The total sweep is defined with a list of subsweeps. Up to 30 subsweeps can be defined, with a total of up to 1632 data points.

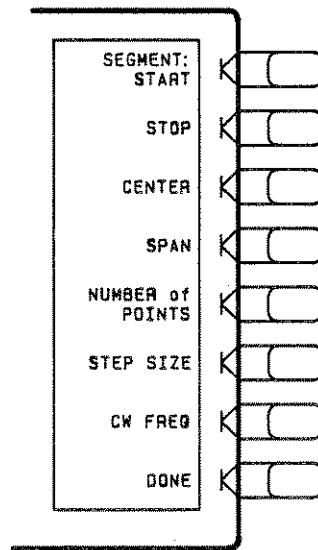

Figure 3-9

The frequency subsweeps, or segments, can be defined in any of the following terms:

- start / stop / number of points
- start / stop / step
- center / span / number of points
- center / span / step
- CW frequency

The subsweeps can overlap, and do not have to be entered in any particular order. The HP 8753B sorts the segments automatically and lists them on the CRT in order of increasing start frequency, even if they are entered in center/span format. If duplicate frequencies exist, the HP 8753B makes multiple measurements on identical points to maintain the specified number of points for each subsweep. The data is displayed on the CRT as a single trace that is a composite of all data taken. The trace may appear uneven because of the distribution of the data points, but the frequency scale is linear across the total range.

The list frequency sweep mode is selected with the **[LIST FREQ]** softkey in the sweep type menu.

The frequency list parameters can be saved with an instrument state.

**[SEGMENT START]** sets the start frequency of a subsweep.

**[STOP]** sets the stop frequency of a subsweep.

**[CENTER]** sets the center frequency of a subsweep.

**[SPAN]** sets the frequency span of a subsweep about a specified center frequency.

**[NUMBER OF POINTS]** sets the number of points for the subsweep. The total number of points for all the subsweeps cannot exceed 1632.

**[STEP SIZE]** is used to specify the subsweep in frequency steps instead of number of points. Changing the start frequency, stop frequency, span, or number of points may change the step size. Changing the step size may change the number of points and stop frequency in start/stop/step mode; or the frequency span in center/span/step mode. In each case, the frequency span becomes a multiple of the step size.

**[CW]** is used to set a subsweep consisting of a single CW frequency point.

**[DONE]** returns to the edit list menu.

# Chapter 4. Response Function Block

## CHAPTER CONTENTS

- 4-1 Introduction
- 4-3 **[MEAS]** Key
- 4-5 S-Parameter Menu
- 4-6 Input Ports Menu
- 4-7 Conversion Menu
- 4-8 **[FORMAT]** Key
- 4-8 Format Menu
- 4-13 Format More Menu
- 4-13 Group delay principles
- 4-16 **[SCALE REF]** Key
- 4-16 Scale Reference Menu
- 4-18 **[DISPLAY KEY]**
- 4-18 Display Menu
- 4-21 Display More Menu
- 4-22 Frequency Blank, D2/D1 to D2 Menu
- 4-23 Title Menu
- 4-24 Title More Menu
- 4-24 **[AVG]** Key
- 4-27 Average Menu

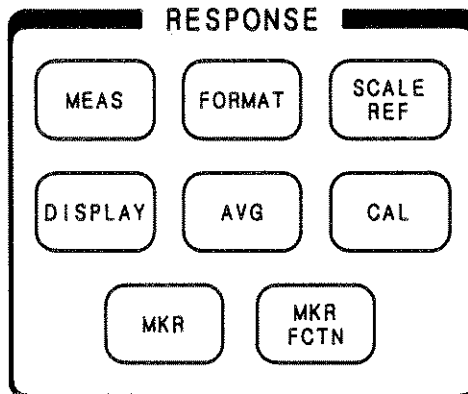

Figure 4-1

## INTRODUCTION

The keys in the RESPONSE block are used to control the measurement and display functions of the active channel. They provide access to many different softkey menus that offer selections for the parameters to be measured, the display mode and format of the data, the control of the display markers, and a variety of calibration functions.

The current values for the major response functions of the active channel are displayed in specific locations along the top of the CRT. In addition, certain functions accessed through the keys in this block are annotated in the status notations area at the left-hand side of the CRT. An illustration of the CRT showing the locations of these information labels is provided in Chapter 2, together with an explanation.

The RESPONSE block keys and their associated menus are described briefly below, and in more detail in this and the following chapters. General and specific measurement sequences are described in the *User's Guide*.

The **[MEAS]** (MENUMEAS) key provides access to a series of softkey menus for selecting the parameters or inputs to be measured.

The **[FORMAT]** (MENUFORM) key leads to a menu used to select the display format for the data. Various rectangular and polar formats are available for display of magnitude, phase, impedance, group delay, real data, and SWR.

The **[SCALE REF]** (MENUSCAL) key displays a menu used to modify the vertical axis scale and the reference line value, as well as to add electrical delay.

The **[DISPLAY]** (MENUDISP) key leads to a series of menus for instrument and active channel display functions. The first menu defines the displayed active channel trace in terms of the mathematical relationship between data and trace memory. Other functions include dual channel display (overlaid or split), display focus and intensity, active channel display title, and frequency blanking.

The **[AVG]** (MENUAVG) key is used to access three different noise reduction techniques: sweep-to-sweep averaging, trace smoothing, and variable IF bandwidth.

The **[CAL]** (MENUCAL) key leads to a series of menus to perform measurement calibrations for vector error correction (accuracy enhancement), and for specifying the calibration standards used. Calibration procedures are used to improve measurement accuracy by effectively removing systematic errors prior to making measurements. Several different levels of calibration are available for use in a variety of different measurement applications. Each calibration procedure features CRT prompts to guide you through the calibration sequence.

An explanation of vector error correction techniques to enhance measurement accuracy is included with the description of the calibration menus and procedures. Refer to Chapter 5, and to the Appendix to Chapter 5.

The **[CAL]** key also leads to softkeys which activate interpolated error correction and power meter calibration. These two features are fully explained in Chapter 5.

The **[MKR]** (MENUMARK) key displays an active marker (▽) on the screen and provides access to a series of menus to control from one to four display markers for each channel. Markers provide numerical readout of measured values at any point of the trace.

The menus accessed from the **[MKR]** key provide several basic marker operations. These include special marker modes for different display formats, and a marker delta mode that displays marker values relative to a specified value or another marker.

The **[MKR FCTN]** (MENUMRKF) key provides access to additional marker functions. These use the markers to search the trace for specified information, to analyze the trace statistically, or to quickly change the stimulus parameters.

## [MEAS] KEY

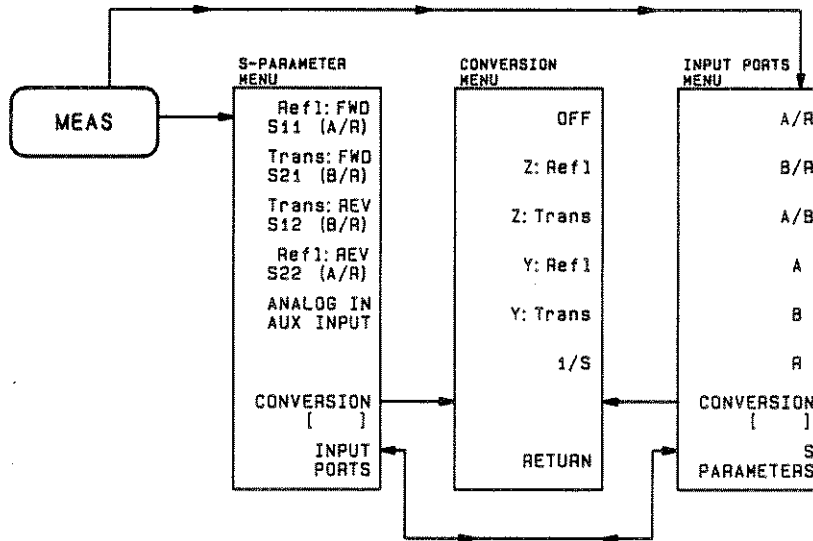

Figure 4-2. Softkey Menus Accessed from the [MEAS] Key

The [MEAS] (MENUMEAS) key leads to a series of softkey menus used to determine the parameters or inputs to be measured. If an HP 85046A/B or 85047A S-parameter test set is connected, all four S-parameters can be measured with a single connection. Or S-parameters can be measured using a transmission/reflection test set by reversing the device under test between measurements. S-parameters are explained briefly below.

Alternatively, the power ratio of any two inputs or the absolute power at a single input can be measured and displayed, using either test set.

S-parameters can be converted to impedance (Z), admittance (Y), or inverse S-parameters through internal math capabilities of the HP 8753B.

### S-Parameters

S-parameters (scattering parameters) are a convention used to characterize the way a device modifies signal flow. A brief explanation is provided here of the S-parameters of a two-port device. For additional details refer to Hewlett-Packard Application Notes A/N 95-1 and A/N 154.

S-parameters are always a ratio of two complex (magnitude and phase) quantities. S-parameter notation identifies these quantities using the numbering convention:

$$S_{out\ in}$$

where the first number (out) refers to the port where the signal is emerging and the second number (in) is the port where the signal is incident. For example, the S-parameter S<sub>21</sub> identifies the measurement as the complex ratio of the signal emerging at port 2 to the signal incident at port 1.

Figure 4-3 is a representation of the S-parameters of a two-port device, together with an equivalent flowgraph. In the illustration, "a" represents the signal entering the device and "b" represents the signal emerging. Note that a and b are not related to the A and B input ports on the HP 8753B.

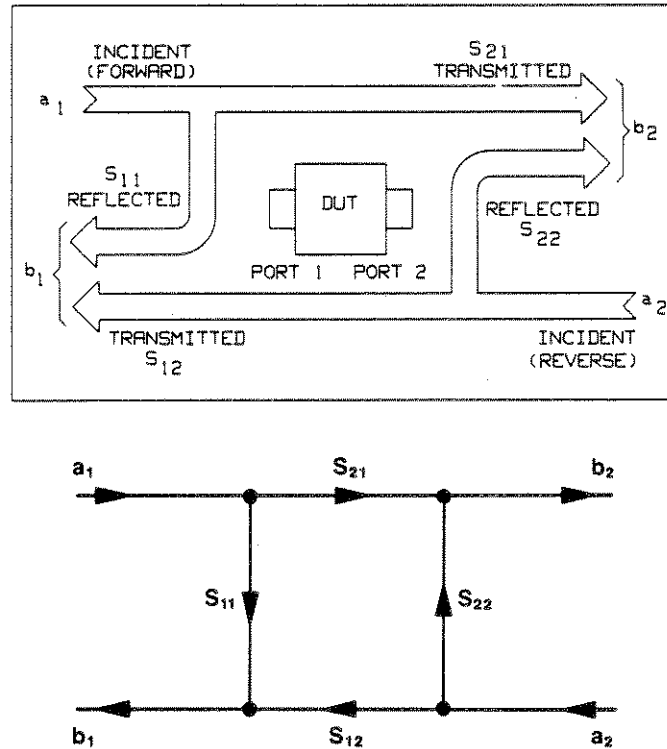

Figure 4-3. S-Parameters of a Two-Port Device

S-parameters are exactly equivalent to the more common description terms below, requiring only that the measurements be taken with all DUT ports properly terminated.

| S-Parameter | Definition                      | Test Set Description          | Direction |
|-------------|---------------------------------|-------------------------------|-----------|
| $S_{11}$    | $\frac{b_1}{a_1} \Big _{a_2=0}$ | Input reflection coefficient  | FWD       |
| $S_{21}$    | $\frac{b_2}{a_1} \Big _{a_2=0}$ | Forward gain                  | FWD       |
| $S_{12}$    | $\frac{b_1}{a_2} \Big _{a_1=0}$ | Reverse gain                  | REV       |
| $S_{22}$    | $\frac{b_2}{a_2} \Big _{a_1=0}$ | Output reflection coefficient | REV       |

## S-Parameter Menu

The S-parameter menu is presented automatically when the **[MEAS]** key is pressed, if an HP 85046A/B or 85047A S-parameter test set is connected to the HP 8753B or if two-port error correction is on. This menu is used to define the input ports and test set direction for S-parameter measurements. The HP 8753B controls the HP 85046A/B or 85047A S-parameter test set, and automatically switches the direction of the measurement according to the selections made in this menu. All four S-parameters can be measured with a single connection. The S-parameter being measured is labeled at the top left corner of the CRT.

S-parameter measurements can also be made using an HP 85044A/B transmission/reflection test set, by reversing the device under test after making the forward reflection and transmission measurements. In this case, the softkey labels are changed to indicate the actual input ratios being measured (A/R for reflection or B/R for transmission measurements). Thus **[Ref1: REV S22 (B/R)]** becomes **[Ref1: REV S22 (A/R)]**, and **[Trans: REV S12 (A/R)]** becomes **[Trans: REV S12 (B/R)]**. However, the annotation in the top left corner indicates the S-parameter being measured.

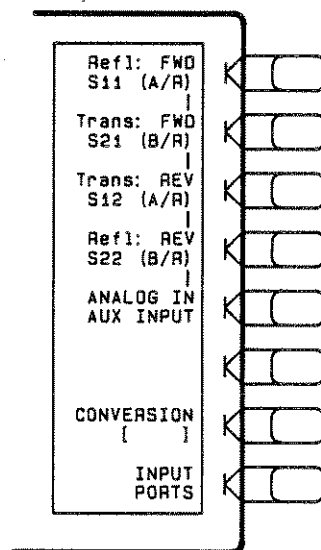

Figure 4-4. S-Parameter Menu

**[Ref1: FWD S11 (A/R)]** (S11) configures the S-parameter test set for a measurement of S11, the complex reflection coefficient (magnitude and phase) of the test device input.

**[Trans: FWD S21 (B/R)]** (S21) configures the S-parameter test set for a measurement of S21, the complex forward transmission coefficient (magnitude and phase) of the device under test.

**[Trans: REV S12 (A/R)]** (S12) configures the S-parameter test set for a measurement of S12, the complex reverse transmission coefficient (magnitude and phase) of the device under test.

If an HP 85044A/B transmission/reflection test set is being used to make S-parameter measurements, reverse the device under test before making this measurement.

**[Ref1: REV S22 (B/R)]** (S22) defines the measurement as S22, the complex reflection coefficient (magnitude and phase) of the output of the device under test.

If an HP 85044A/B transmission/reflection test set is being used to make S-parameter measurements, the device under test must be reversed before S12 and S22 are measured.

**[ANALOG IN]** (ANAI) displays a DC or low frequency AC auxiliary voltage on the vertical axis, using the real format. An external signal source such as a detector or function generator can be connected to the rear panel AUXILIARY INPUT connector. (For service purposes, one of numerous internal voltage nodes on the analog bus can be selected for measurement and display. Applications of this function are described in the *On-Site System Service Manual*.)

**[CONVERSION]** brings up the conversion menu which converts the measured data to impedance (Z) or admittance (Y). When a conversion parameter has been defined, it is shown in brackets under the softkey label. If no conversion has been defined, the softkey label reads **[CONVERSION OFF]**.

**[INPUT PORTS]** goes to the input ports menu, which is used to define a ratio or single-input measurement rather than an S-parameter measurement.

## Input Ports Menu

The input ports menu is presented when the **[MEAS]** key is pressed if there is no S-parameter test set connected and two-port error correction is not on. This menu is used to define the input ports for power ratio measurements, or a single input for magnitude only measurements of absolute power. Single inputs cannot be used for phase or group delay measurements, or any measurements with averaging turned on.

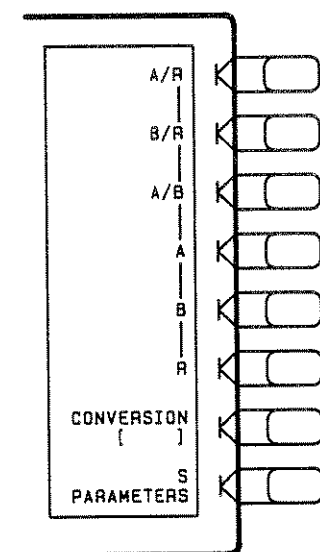

Figure 4-5

**[A/R]** (AR) calculates and displays the complex ratio of the signal at input A to the reference signal at input R.

**[B/R]** (BR) calculates and displays the complex ratio of input B to input R.

**[A/B]** (AB) calculates and displays the complex ratio of input A to input B.

**[A]** (MEASA) measures the absolute power amplitude at input A.

**[B]** (MEASB) measures the absolute power amplitude at input B.

**[R]** (MEASR) measures the absolute power amplitude at input R. The R input is part of the source phase locking scheme, and therefore has a limited dynamic range.



**[CONVERSION]** brings up the conversion menu, which converts the measured data to impedance (Z) or admittance (Y). When a conversion parameter has been defined, it is shown in brackets under the softkey label. If no conversion has been defined, the softkey label reads **[CONVERSION OFF]**.

**[S PARAMETERS]** goes to the S-parameter menu, which is used to define the input ports and test set direction for S-parameter measurements.

### Conversion Menu

This menu converts the measured reflection or transmission data to the equivalent complex impedance (Z) or admittance (Y) values. This is not the same as a two-port Y or Z parameter conversion, as only the measured parameter is used in the equations. Two simple one-port conversions are available, depending on the measurement configuration.

An S11 or S22 trace measured as reflection can be converted to equivalent parallel impedance or admittance using the model and equations shown in Figure 4-6.

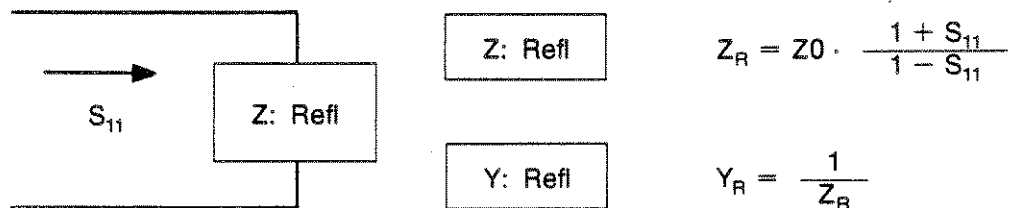

Figure 4-6. Reflection Impedance and Admittance Conversions

In a transmission measurement, the data can be converted to its equivalent series impedance or admittance using the model and equations shown in Figure 4-7.

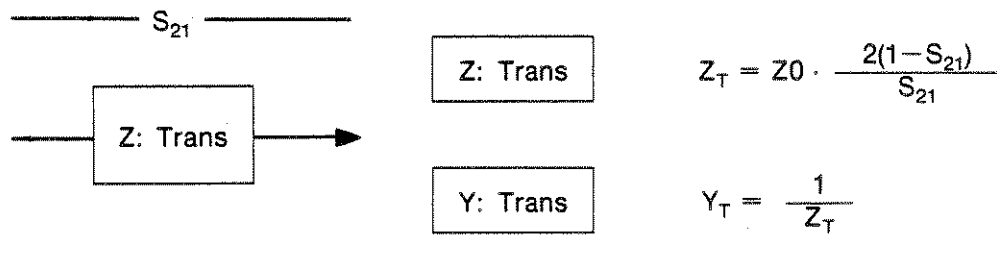

Figure 4-7. Transmission Impedance and Admittance Conversions

Avoid the use of Smith chart, SWR, and delay formats for display of Z and Y conversions, as these formats are not easily interpreted.

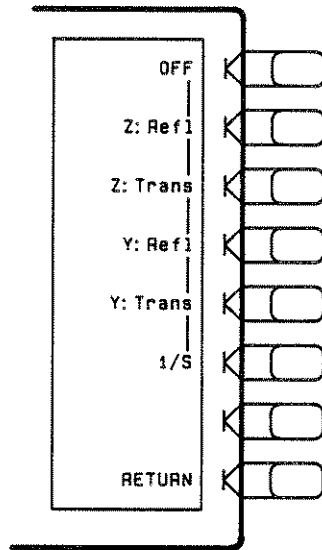

Figure 4-8. Conversion Menu

**[OFF]** (CONVOFF) turns off all parameter conversion operations.

**[Z: Refl]** (CONVZREF) converts reflection data to its equivalent impedance values.

**[Z: Trans]** (CONVZTRA) converts transmission data to its equivalent impedance values.

**[Y: Refl]** (CONVYREF) converts reflection data to its equivalent admittance values.

**[Y: Trans]** (CONVYTRA) converts transmission data to its equivalent admittance values.

**[1/S]** (CONV1DS) expresses the data in inverse S-parameter values, for use in amplifier and oscillator design. A convenient way to check for transistor stability is to compare S11 and 1/S22 on a Smith chart using a dual channel overlaid display (see *Display Menu*).

**[RETURN]** returns to the last menu, either the S-parameter or the input ports menu.

## **[FORMAT] KEY**

### **Format Menu**

The **[FORMAT]** (MENUFORM) key presents a menu used to select the appropriate display format for the measured data. Various rectangular and polar formats are available for display of magnitude, phase, real data, imaginary data, impedance, group delay, and SWR. The units of measurement are changed automatically to correspond with the displayed format. Special marker menus are available for the polar and Smith formats, each providing several different marker types for readout of values (see Chapter 6).

The format defined for display of a particular S-parameter or input is remembered with that parameter. Thus if different parameters are measured, even if only one channel is used, each parameter is shown in its selected format each time it is displayed.

The illustrations below show a reflection measurement of a bandpass filter displayed in each of the available formats.

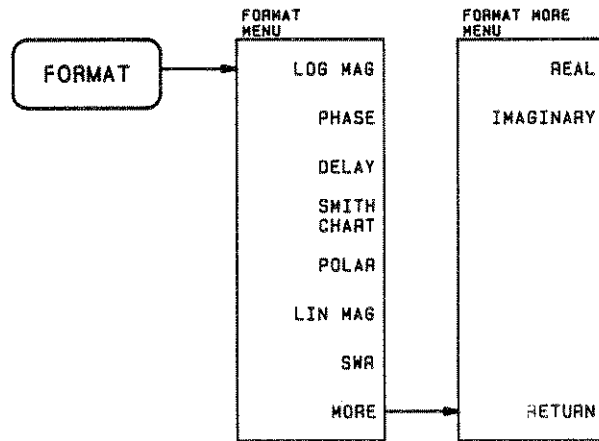

Figure 4-9. Format and Format More Menus

**[LOG MAG]** (LOGM) displays the log magnitude format. This is the standard Cartesian format used to display magnitude-only measurements of insertion loss, return loss, or absolute power in dB versus frequency. Figure 4-10 illustrates the bandpass filter reflection data in a log magnitude format.

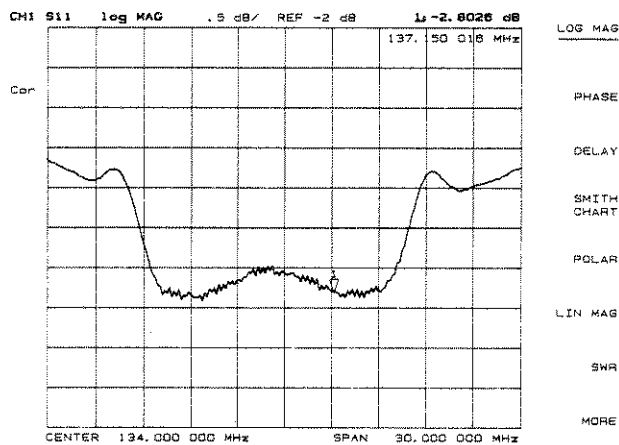

Figure 4-10. Log Magnitude Format

**[PHASE]** (PHAS) displays a Cartesian format of the phase portion of the data, measured in degrees. This format displays the phase shift versus frequency. Figure 4-11 illustrates the phase response of the same filter in a phase-only format. A measurement of phase response is described in the User's Guide.

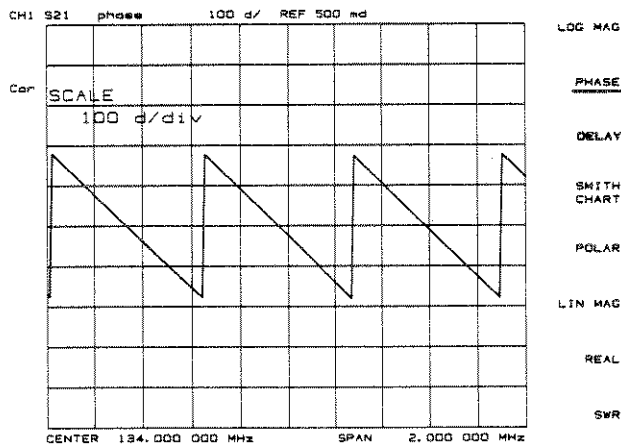

Figure 4-11. Phase Format

**[DELAY]** (DELA) selects the group delay format, with marker values given in seconds. Figure 4-12 shows the bandpass filter response formatted as group delay. Group delay principles are described in the next few pages.

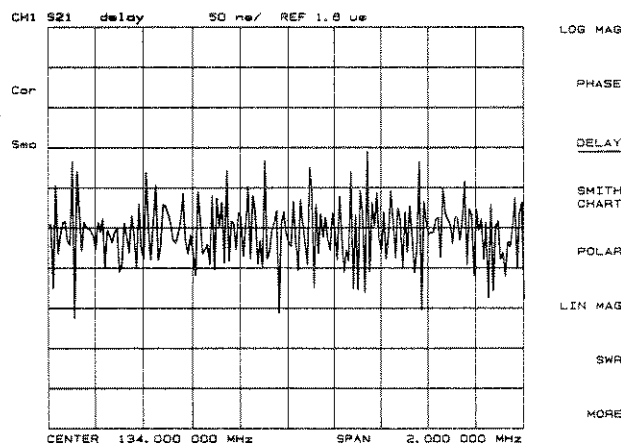

Figure 4-12. Group Delay Format

**[SMITH CHART]** (SMIC) displays a Smith chart format (Figure 4-13). This is used in reflection measurements to provide a readout of the data in terms of impedance. The intersecting dotted lines on the Smith chart represent constant resistance and constant reactance values, normalized to the characteristic impedance,  $Z_0$ , of the system. Reactance values in the upper half of the Smith chart circle are positive (inductive) reactance, and in the lower half of the circle are negative (capacitive) reactance. The default marker readout is in units of resistance and reactance ( $R + jX$ ). Additional marker types are available in the Smith marker menu (refer to Chapter 6).

The Smith chart is most easily understood with a full scale value of 1.0. If the scale per division is less than 0.2, the format switches automatically to polar.

If the characteristic impedance of the system is not 50 ohms, modify the impedance value recognized by the HP 8753B using the **[SET Z0]** softkey in the calibrate more menu. Refer to Chapter 5.

An inverted Smith chart format for admittance measurements (Figure 4-13) is also available. Access this by selecting **[SMITH CHART]** in the format menu, and pressing **[MKR] [MARKER MODE MENU] [SMITH MKR MENU] [G+jB MKR]**. The Smith chart is reversed and marker values are read out in units of conductance and susceptance ( $G+jB$ ).

Procedures for measuring impedance and admittance are provided in the *User's Guide*.

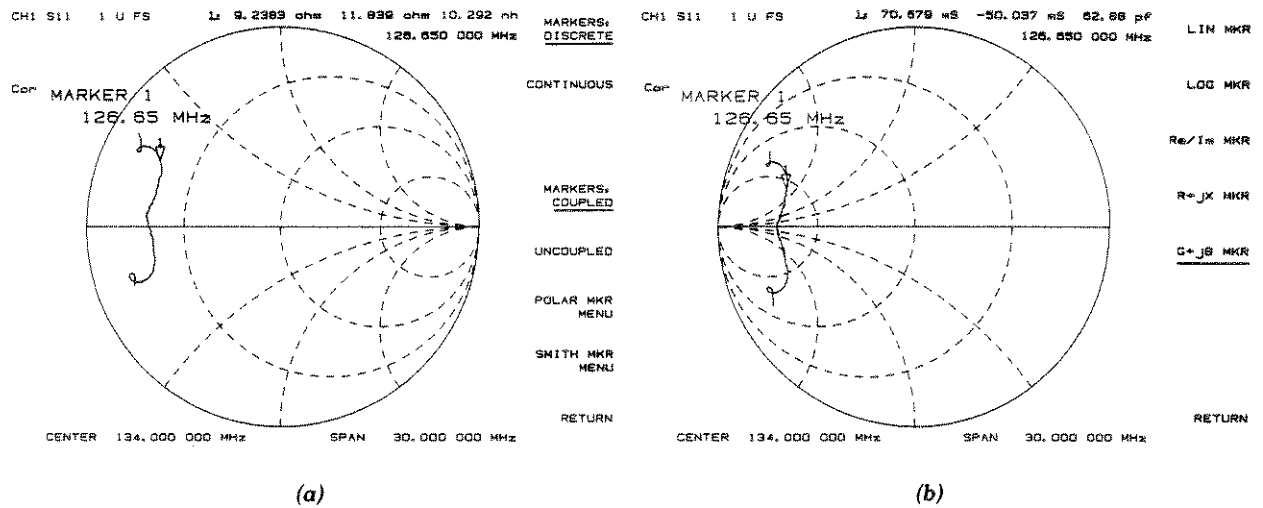

Figure 4-13. Standard and Inverse Smith Chart Formats

**[POLAR]** (POLA) displays a polar format (Figure 4-14). Each point on the polar format corresponds to a particular value of both magnitude and phase. Quantities are read vectorally: the magnitude at any point is determined by its displacement from the center (which has zero value), and the phase by the angle counterclockwise from the positive x-axis. Magnitude is scaled in a linear fashion, with the value of the outer circle usually set to a ratio value of 1. Since there is no frequency axis, frequency information is read from the markers.

The default marker readout for the polar format is in linear magnitude and phase. A log magnitude marker and a real/imaginary marker are available in the polar marker menu (refer to Chapter 6).

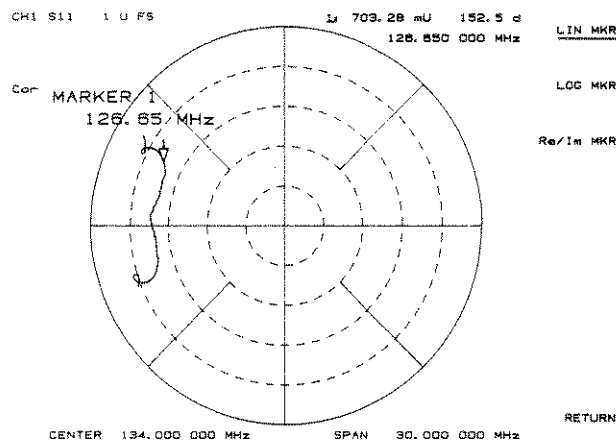

Figure 4-14. Polar Format

**[LIN MAG]** (LINM) displays the linear magnitude format (Figure 4-15). This is a Cartesian format used for unitless measurements such as reflection coefficient magnitude  $\rho$  or transmission coefficient magnitude  $\tau$ , and for linear measurement units. It is used for display of conversion parameters and time domain transform data.

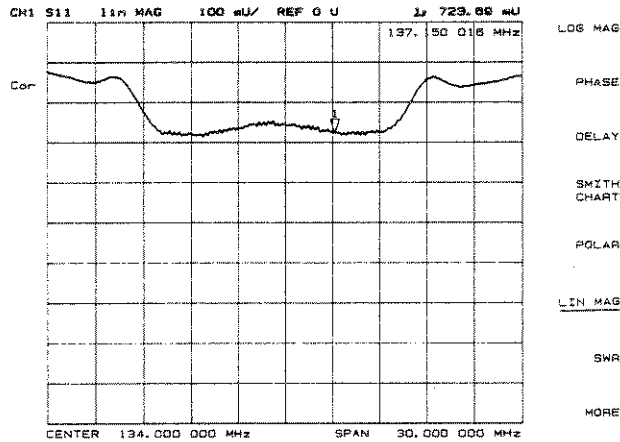

Figure 4-15. Linear Magnitude Format

**[SWR]** (SWR) reformats a reflection measurement into its equivalent SWR (standing wave ratio) value (Figure 4-16). SWR is equivalent to  $(1+\rho)/(1-\rho)$ , where  $\rho$  is the reflection coefficient. Note that the results are valid only for reflection measurements. If the SWR format is used for measurements of S21 or S12 the results are not valid.

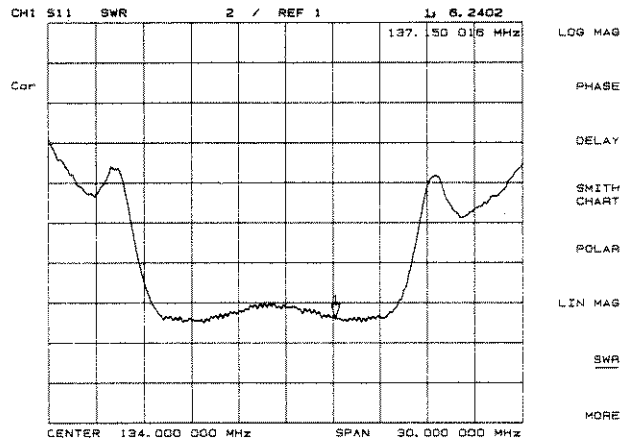

Figure 4-16. Typical SWR Display

**[MORE]** goes to the format more menu described on the next page.

## Format More Menu

This menu provides two additional softkey selections not available on the HP 8753A.

**[REAL]** (REAL) displays only the real (resistive) portion of the measured data on a Cartesian format (Figure 4-16). This is similar to the linear magnitude format, but can show both positive and negative values. It is primarily used for analyzing responses in the time domain, and also to display an auxiliary input voltage signal for service purposes.

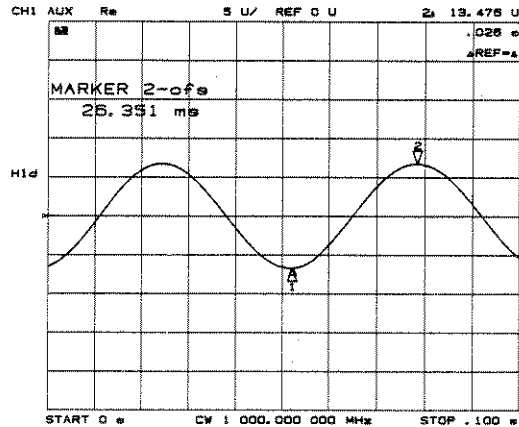

Figure 4-17. Real Format

**[IMAGINARY]** (IMAG) displays only the imaginary (reactive) portion of the measured data on a Cartesian format. This format is similar to the real format except that reactance data is displayed on the trace instead of impedance data.

**[RETURN]** goes back to the format menu.

## GROUP DELAY PRINCIPLES

For many networks, the amount of insertion phase is not as important as the linearity of the phase shift over a range of frequencies. The HP 8753B can measure this linearity and express it in two different ways: directly, as deviation from linear phase, or as group delay, a derived value. Refer to the **[SCALE REF] Key** description in this chapter for information on deviation from linear phase.

Group delay is the measurement of signal transmission time through a test device. It is defined as the derivative of the phase characteristic with respect to frequency. Since the derivative is basically the instantaneous slope (or rate of change of phase with frequency), a perfectly linear phase shift results in a constant slope, and therefore a constant group delay (Figure 4-18).

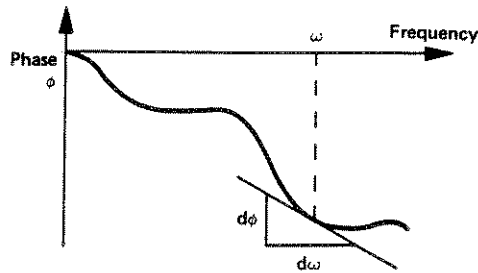
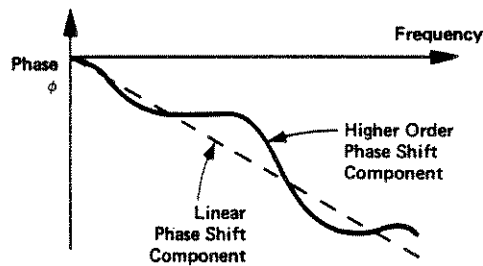

Figure 4-18

Note, however, that the phase characteristic typically consists of both linear and higher order (deviations from linear) components. The linear component can be attributed to the electrical length of the test device, and represents the average signal transit time. The higher order components are interpreted as variations in transit time for different frequencies, and represent a source of signal distortion (Figure 4-19).



$$\text{Group Delay} = \tau_g = \frac{-d\phi}{d\omega} \quad \begin{array}{l} \phi \text{ in Radians} \\ \omega \text{ in Radians} \end{array}$$

$$= \frac{-1}{360^\circ} \cdot \frac{d\phi}{df} \quad \begin{array}{l} \phi \text{ in Degrees} \\ f \text{ in Hz } (\omega = 2\pi f) \end{array}$$

Figure 4-19

The HP 8753B network analyzer computes group delay from the phase slope. Phase data is used to find the phase change,  $\Delta\phi$ , over a specified frequency aperture,  $\Delta f$ , to obtain an approximation for the rate of change of phase with frequency (Figure 4-20). This value,  $\tau_g$ , represents the group delay in seconds assuming linear phase change over  $\Delta f$ . It is important that  $\Delta\phi$  be  $\leq 180^\circ$ , or errors will result in the group delay data. These errors can be significant for long delay devices. You can verify that  $\Delta\phi$  is  $\leq 180^\circ$  by increasing the number of points or narrowing the frequency span (or both) until the group delay data no longer changes.



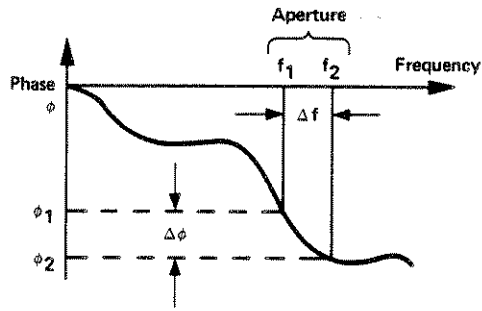

Figure 4-20

When deviations from linear phase are present, changing the frequency step can result in different values for group delay. Note that in this case the computed slope varies as the aperture  $\Delta f$  is increased (Figure 4-21). A wider aperture results in loss of the fine grain variations in group delay. This loss of detail is the reason that in any comparison of group delay data it is important to know the aperture used to make the measurement.

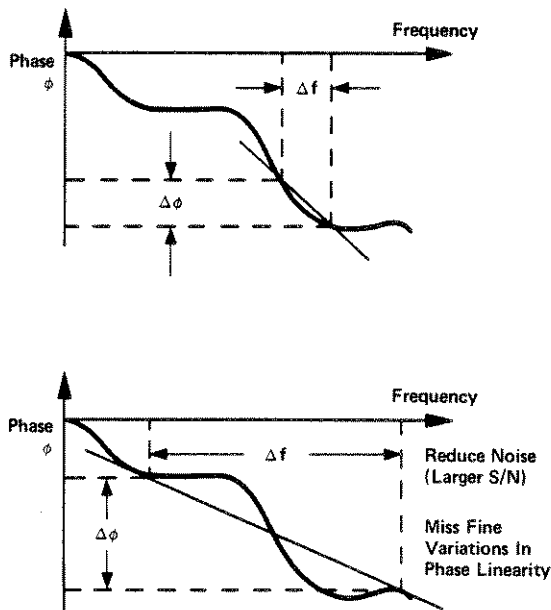

Figure 4-21

In determining the group delay aperture, there is a tradeoff between resolution of fine detail and the effects of noise. Noise can be reduced by increasing the aperture, but this will tend to smooth out the fine detail. More detail will become visible as the aperture is decreased, but the noise will also increase, possibly to the point of obscuring the detail. A good practice is to use a smaller aperture to assure that small variations are not missed, then increase the aperture to smooth the trace.

The default group delay aperture is the frequency span divided by the number of points across the display. To set the aperture to a different value, turn on smoothing in the average menu, and vary the smoothing aperture (see [AVG] Key). The aperture can be varied up to 20% of the span swept.

Group delay measurements can be made on linear frequency, log frequency, or list frequency sweep types (not in CW or power sweep). Group delay aperture varies depending on the frequency spacing and point density, therefore the aperture is not constant in log and list frequency sweep modes. In list frequency mode, extra frequency points can be defined to ensure the desired aperture.

To obtain a readout of aperture values at different points on the trace, turn on a marker. Then press **[AVG] [SMOOTHING APERTURE]**. Smoothing aperture becomes the active function, and as the aperture is varied its value in Hz is displayed below the active entry area.

A group delay measurement procedure is provided in the *User's Guide*.

## [SCALE REF] KEY

### Scale Reference Menu

The **[SCALE REF] (MENUSCAL)** key makes scale per division the active function. A menu is displayed that is used to modify the vertical axis scale and the reference line value and position. In addition this menu provides electrical delay offset capabilities for adding or subtracting linear phase to maintain phase linearity.

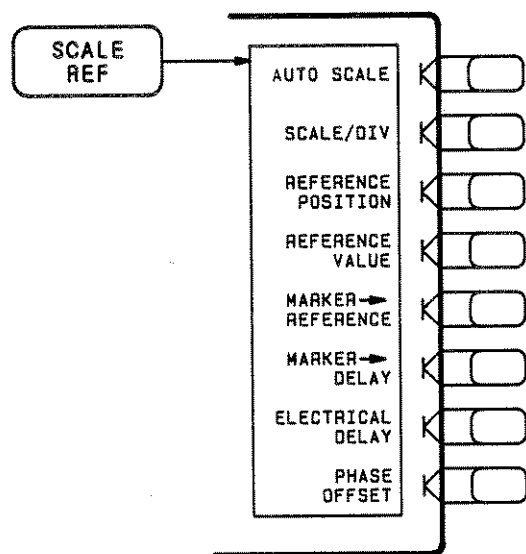

Figure 4-22

**[AUTO SCALE] (AUTO)** brings the trace data in view on the CRT with one keystroke. Stimulus values are not affected, only scale and reference values. The HP 8753B determines the smallest possible scale factor that will put all displayed data onto 80% of the vertical graticule. The reference value is chosen to put the trace in center screen, then rounded to an integer multiple of the scale factor.

**[SCALE/DIV] (SCAL)** changes the response value scale per division of the displayed trace. In polar and Smith chart formats, this refers to the full scale value at the outer circumference, and is identical to reference value.

**[REFERENCE POSITION]** (REFP) sets the position of the reference line on the graticule of a Cartesian display, with 0 the bottom line of the graticule and 10 the top line. It has no effect on a polar or Smith display. The reference position is indicated with a small triangle just outside the graticule, on the left side for channel 1 and the right side for channel 2.

**[REFERENCE VALUE]** (REFV) changes the value of the reference line, moving the measurement trace correspondingly. In polar and Smith chart formats, the reference value is the same as the scale, and is the value of the outer circle.

**[MARKER → REFERENCE]** (MARKREF) makes the reference value equal to the active marker's absolute value (regardless of the delta marker value). The marker is effectively moved to the reference line position. This softkey also appears in the marker function menu accessed from the **[MKR FCTN]** key. In polar and Smith chart formats this function makes the full scale value at the outer circle equal to the active marker response value.

**[MARKER → DELAY]** (MARKDELA) adjusts the electrical delay to balance the phase of the DUT. This is performed automatically, regardless of the format and the measurement being made. Enough line length is added to or subtracted from the receiver input to compensate for the phase slope at the active marker position. This effectively flattens the phase trace around the active marker, and can be used to measure electrical length or deviation from linear phase. Additional electrical delay adjustments are required on DUTs without constant group delay over the measured frequency span. Since this feature adds phase to a variation in phase versus frequency, it is applicable only for ratioed inputs.

**[ELECTRICAL DELAY]** (ELED) adjusts the electrical delay to balance the phase of the DUT. It simulates a variable length lossless transmission line, which can be added to or removed from a receiver input to compensate for interconnecting cables, etc. This function is similar to the mechanical or analog "line stretchers" of other network analyzers. Delay is annotated in units of time with secondary labeling in distance for the current velocity factor.

With this feature, and with **[MARKER → DELAY]**, an equivalent length of air is added or subtracted according to the following formula:

$$\text{Length (metres)} = \frac{\phi}{F(\text{MHz}) \times 1.20083}$$

Once the linear portion of the DUT's phase has been removed, the equivalent length of air can be read out in the active marker area. If the average relative permittivity ( $\epsilon_r$ ) of the DUT is known over the frequency span, the length calculation can be adjusted to indicate the actual length of the DUT more closely. This can be done by entering the relative velocity factor for the DUT using the calibrate more menu. The relative velocity factor for a given dielectric can be calculated by:

$$\text{Velocity factor} = 1/\sqrt{\epsilon_r}$$

assuming a relative permeability of 1.

A procedure for measuring electrical length or deviation from linear phase using the **[ELECTRICAL DELAY]** or **[MARKER → DELAY]** features is provided in the *User's Guide*.

**[PHASE OFFSET]** (PHAO) adds or subtracts a phase offset that is constant with frequency (rather than linear). This is independent of **[MARKER → DELAY]** and **[ELECTRICAL DELAY]**.

## [DISPLAY] KEY

The [DISPLAY] (MENUDISP) key provides access to the memory math functions, and other display functions including dual channel display, active channel display title, frequency blanking, and display focus and intensity.

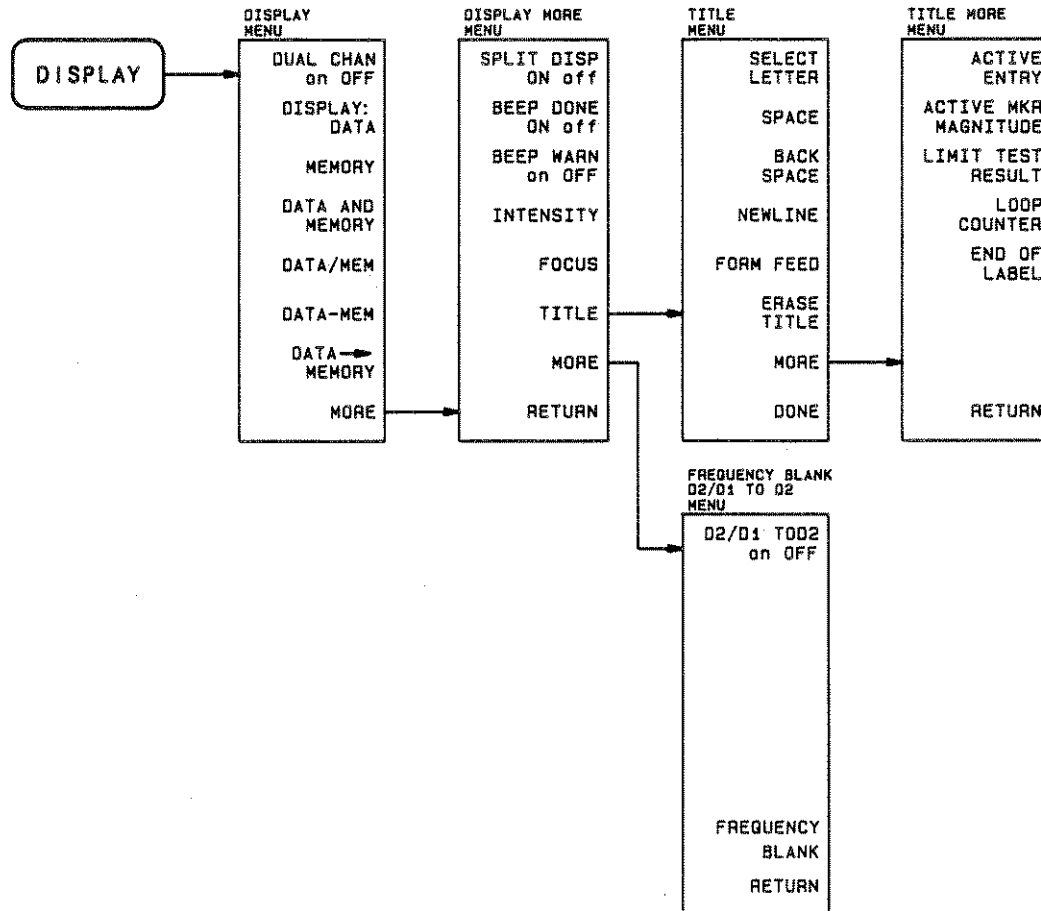

Figure 4-23. Softkey Menus Accessed from the [DISPLAY] Key

### Display Menu

This menu provides trace math capabilities for manipulating data, as well as the capability of displaying both channels simultaneously, either overlaid or split.

The HP 8753B has two available memory traces, one per channel. Memory traces are totally channel dependent: channel 1 cannot access the channel 2 memory trace or vice versa. Memory traces can be saved with instrument states: one memory trace can be saved per channel per saved instrument state. Five save/recall registers are available for each channel, so the total number of memory traces that can be saved is 12 including the two active for the current instrument state. The memory data is stored as full precision, complex data. (Refer to Chapter 10.)

Two trace math operations are implemented, data/memory and data-memory. (Note that normalization is data/memory not data-memory.) Memory traces are saved and recalled and trace math is done immediately after error correction. This means that any additional post-processing done after error correction, including parameter conversion, time domain transformation (option 010), scaling, etc., can be performed on the memory trace. (Refer to *HP 8753B Data Processing* in Chapter 1.) Trace math can also be used as a simple means of error correction, although that is not its main purpose.

All data processing operations that occur after trace math, except smoothing and gating, are identical for the data trace and the memory trace. If smoothing or gating is on when a memory trace is saved, this state is maintained regardless of the data trace smoothing or gating status. If a memory trace is saved with gating or smoothing on, these features can be turned on or off in the memory-only display mode.

The actual memory for storing a memory trace is allocated only as needed. The memory trace is cleared on instrument preset, power on, or instrument state recall.

If sweep mode or sweep range is different between the data and memory traces, trace math is allowed, and no warning message is displayed. If the number of points in the two traces is different, the memory trace is not displayed nor rescaled. However, if the number of points for the data trace is changed back to the number of points in the memory, the memory trace can then be displayed.

If trace math or display memory is requested and no memory trace exists, the message "CAUTION: NO VALID MEMORY TRACE" is displayed.

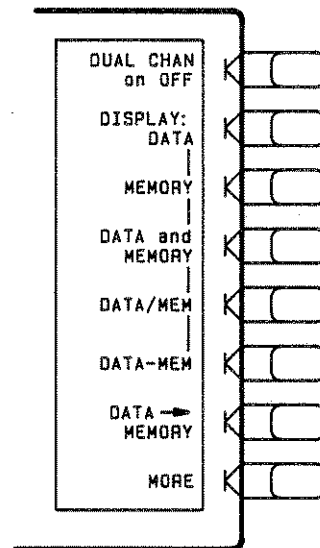

Figure 4-24. Display Menu

**[DUAL CHAN on OFF]** (DUACON, DUACOFF) toggles between display of both measurement channels or the active channel only. This is used in conjunction with **[SPLIT DISP ON off]** in the display more menu to display both channels. With **[SPLIT DISP OFF]** the two traces are overlaid on a single graticule (Figure 4-25 part a); with **[SPLIT DISP ON]** the measurement data is displayed on two half-screen graticules one above the other (Figure 4-25 part b). Current parameters for the two displays are annotated separately.

The stimulus functions of the two channels can also be controlled independently using **[COUPLED CH ON]** in the stimulus menu. In addition, the markers can be controlled independently for each channel using **[MARKERS: UNCOUPLED]** in the marker mode menu.

**If the Measurement does not Function Properly in Dual Channel Mode.** If you have decoupled channels 1 and 2, and are using dual channel, there are two measurement configurations which may not appear to function "properly".

The two configurations, shown below, would cause repeated switching of either the test port transfer switch or the step attenuator. To avoid premature wearing out of these mechanical devices, the test set will not allow such measurements to occur without direct intervention by the operator. The two affected measurement conditions are:

- If channel 1 is driving one test port and channel 2 is driving the other. For example, you are making an  $S_{21}$  measurement on channel 1 and an  $S_{12}$  measurement on channel 2. This configuration, if allowed unchecked, would cause the test port transfer switch to continually cycle.
- Channel 1 requires one attenuation value, and channel 2 requires a different value. Since one attenuator is used for both test ports, this would cause the attenuator to continuously switch settings.

If either of the above conditions exist, the test set hold mode will engage, and the status notation "tsH" will appear on the left side of the screen. The hold mode may be overridden by either the **[MEASUREMENT RESTART]** or **[NUMBER OF GROUPS]** softkeys, described in Chapter 3, *Stimulus Function Block*. For more information, refer to *Test Set Attenuator, Test Port Transfer Switch, and Doubler Switch Protection*, in the beginning of Chapter 3.

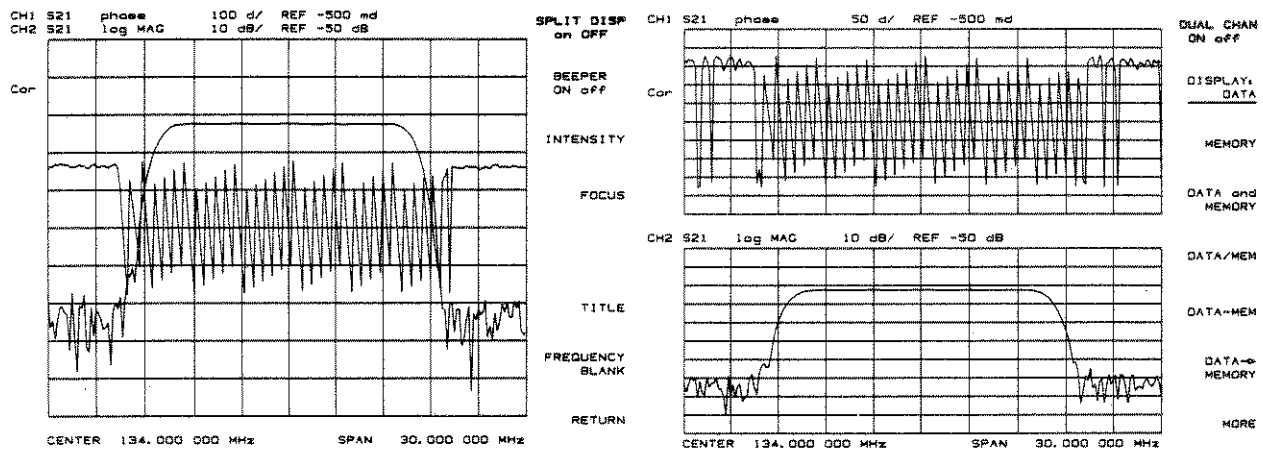

(a) Overlaid Traces

(b) Split Display

Figure 4-25. Dual Channel Displays

**[DISPLAY: DATA]** (DISPDATA) displays the current measurement data for the active channel.

**[MEMORY]** (DISPMEMO) displays the trace memory for the active channel. This is the only memory display mode where the smoothing and gating of the memory trace can be changed. If no data has been stored in memory for this channel, a warning message is displayed.

**[DATA and MEMORY]** (DISPDATM) displays both the current data and memory traces.

**[DATA/MEM]** (DISPDDM) divides the data by the memory, normalizing the data to the memory, and displays the result. This is useful for ratio comparison of two traces, for instance in measurements of gain or attenuation.

**[DATA — MEM]** (DISPDMM) subtracts the memory from the data. The vector subtraction is performed on the complex data. This is appropriate for storing a measured vector error, for example directivity, and later subtracting it from the device measurement.

**[DATA → MEMORY]** (DATI) stores the current active measurement data in the memory of the active channel. It then becomes the memory trace, for use in subsequent math manipulations or display. If a parameter has just been changed and the \* status notation is displayed at the left of the CRT, the data is not stored in memory until a clean sweep has been executed. The gating and smoothing status of the trace are stored with the measurement data.

**[MORE]** leads to the display more menu.

## Display More Menu

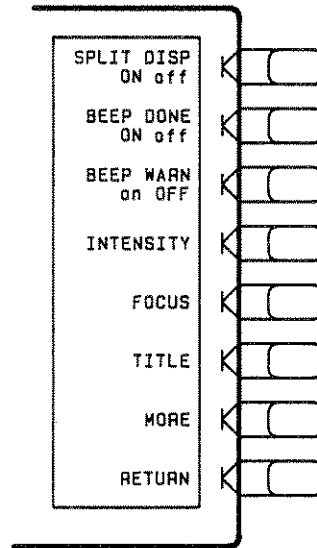

Figure 4-26. Display More Menu

**[SPLIT DISP on OFF]** (SPLDON, SPLDOFF) toggles between a full-screen single graticule display of one or both channels, and a split display with two half-screen graticules one above the other. Both displays are illustrated in Figure 4-25. The split display can be used in conjunction with **[DUAL CHAN ON]** in the display menu to show the measured data of each channel simultaneously on separate graticules. In addition, the stimulus functions of the two channels can be controlled independently using **[COUPLED CH ON]** in the stimulus menu. The markers can also be controlled independently for each channel using **[MARKERS: UNCOUPLED]** in the marker mode menu.

**[BEEP DONE ON off]** (BEEPDONEON, BEEPDONEOFF) toggles an annunciator which sounds to indicate completion of certain operations such as calibration or instrument state save.

**[BEEP WARN on OFF]** (BEEPWARNON, BEEPWARNOFF) toggles the warning annunciator. When the annunciator is on it sounds a warning when a cautionary message is displayed.

**[INTENSITY]** (INTE) sets the CRT intensity as a percent of the brightest setting. The factory-set default value is stored in non-volatile memory.

**[FOCUS]** (FOCU) sets the CRT focus as a percent of the maximum focus voltage. The factory-set default value is stored in non-volatile memory.

**[TITLE]** (TITL) presents the title menu in the softkey labels area and the character set in the active entry area. These are used to label the active channel display. A title more menu allows up to four values to be included in the printed title; active entry, active marker amplitude, limit test results, and loop counter value.

**[MORE]** goes to the "frequency blank, D2/D1 to D2 menu"

**[RETURN]** goes back to the display menu.

### Frequency Blank, D2/D1 to D2 Menu

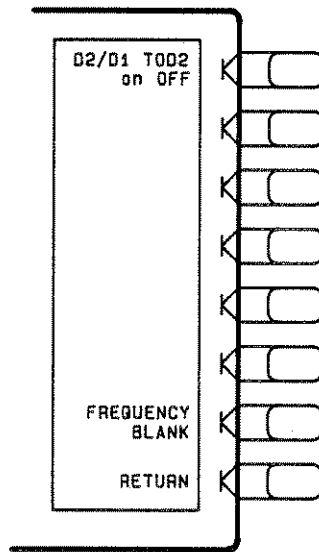

Figure 4-27. Frequency Blank, D2/D1 to D2 Menu

**[FREQUENCY BLANK]** (FREO) blanks the displayed frequency notation for security purposes. Frequency labels cannot be restored except by instrument preset or turning the power off and then on.

**[D2/D1 toD2]** (D1DIVD2) this math function ratios channels 1 and 2, and puts the results in the channel 2 data array. Both channels must be on and have the same number of points. This feature is particularly useful for making harmonic measurements in an HP 8753B equipped with option 002. With the fundamental frequency displayed on channel 1 and the measured harmonic on channel 2, this key displays the relative amplitude of the harmonic with respect to the fundamental.

**[RETURN]** goes back to the display menu.



## Title Menu

Use this menu to specify a title for the active channel. The title identifies the display regardless of stimulus or response changes, and is printed or plotted with the data. If the display is saved in a register with the instrument state, the title is saved with it.

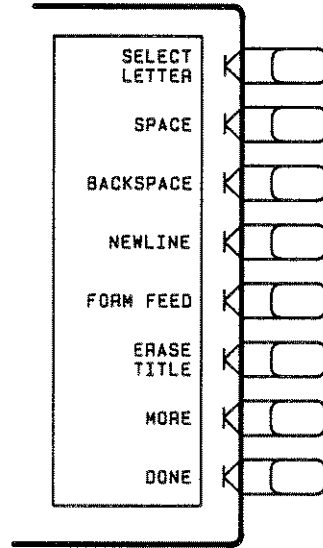

Figure 4-28. Title Menu

**[SELECT LETTER]**. The active entry area displays the letters of the alphabet, digits 0 through 9, and mathematical symbols. To define a title, rotate the knob until the arrow  $\uparrow$  points at the first letter, then press **[SELECT LETTER]**. Repeat this until the complete title is defined, for a maximum of 50 characters. As each character is selected, it is appended to the title at the top of the graticule.

**[SPACE]** inserts a space in the title.

**[BACK SPACE]** deletes the last character entered.

**[NEWLINE]** sends a new line command to the printer.

**[FORM FEED]** advances the printer paper to the next page.

**[ERASE TITLE]** deletes the entire title.

**[MORE]** leads to the title more menu.

**[DONE]** terminates the title entry, and returns to the display more menu.

## Title More Menu

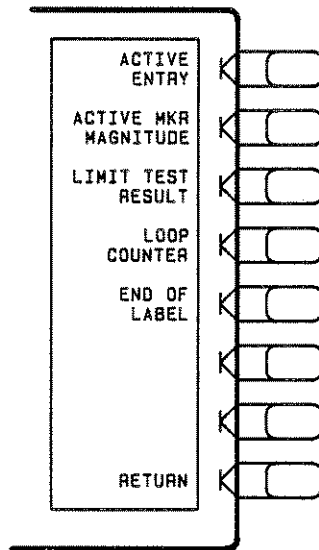

Figure 4-29. Title More Menu

The following softkeys cause the named data to be printed out with the title. This is especially useful when used with the test sequence function, described in Chapter 13.

**[ACTIVE ENTRY]** prints the name of the active entry.

**[ACTIVE MRK AMPLITUDE]** prints the active marker amplitude.

**[LIMIT TEST RESULT]** prints the result of a limit test.

**[LOOP COUNTER]** prints the current value of the loop counter. Refer to chapter 13.

**[END OF LABEL]** terminates the HP-GL "LB" command. Refer to chapter 13.

**[RETURN]** returns to the previous menu.

## [AVG] KEY

The **[AVG]** (MENUAVG) key is used to access three different noise reduction techniques: sweep-to-sweep averaging, display smoothing, and variable IF bandwidth. Any or all of these can be used simultaneously. Averaging and smoothing can be set independently for each channel, and the IF bandwidth can be set independently if the stimulus is uncoupled.

**Averaging** computes each data point based on an exponential average of consecutive sweeps weighted by a user-specified averaging factor. Each new sweep is averaged into the trace until the total number of sweeps is equal to the averaging factor, for a fully averaged trace. Each point on the trace is the vector sum of the current trace data and the data from the previous sweep. A high averaging factor gives the best signal-to-noise ratio, but slows down the trace update time. Doubling the averaging factor reduces the noise by 3 dB. Averaging is used for ratioed measurements: if it is attempted for a single-input measurement (e.g. A or B), the message "CAUTION: AVERAGING INVALID ON NON-RATIO MEASURE" is displayed. Figure 4-30 illustrates the effect of averaging on a log magnitude format trace.

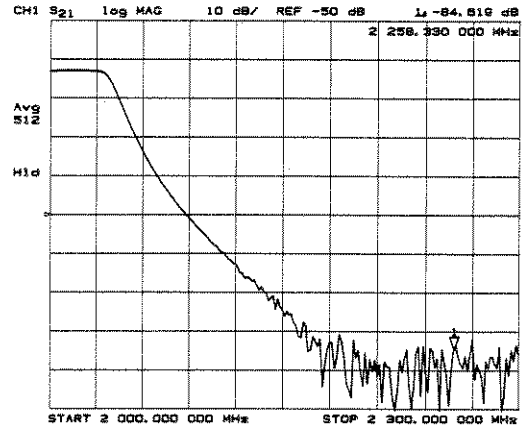
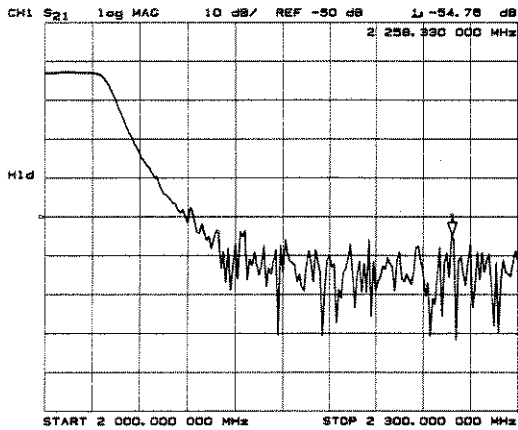

Figure 4-30. Effect of Averaging on a Trace

**Smoothing** (similar to video filtering) averages the formatted active channel data over a portion of the displayed trace. Smoothing computes each displayed data point based on one sweep only, using a moving average of several adjacent data points for the current sweep. The smoothing aperture is a percent of the stimulus span swept, up to a maximum of 20%.

Rather than lowering the noise floor, smoothing finds the mid-value of the data. Use it to reduce relatively small peak-to-peak noise values on broadband measured data. Use a sufficiently high number of display points to avoid misleading results. Do not use smoothing for measurements of high resonance devices or other devices with wide variations in trace, as it will introduce errors into the measurement.

Smoothing is used with Cartesian and polar display formats. It is also the primary way to control the group delay aperture, given a fixed frequency span (refer to *Group Delay Principles* earlier in this chapter). In polar display format, large phase shifts over the smoothing aperture will cause shifts in amplitude, since a vector average is being computed. Figure 4-31 illustrates the effect of smoothing on a log magnitude format trace.

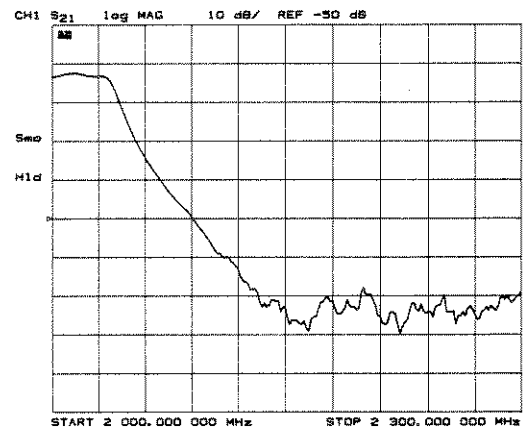
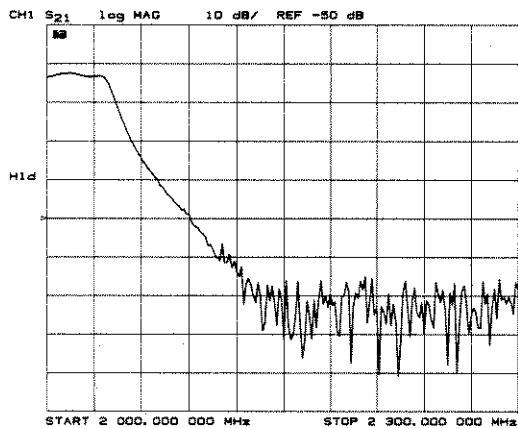
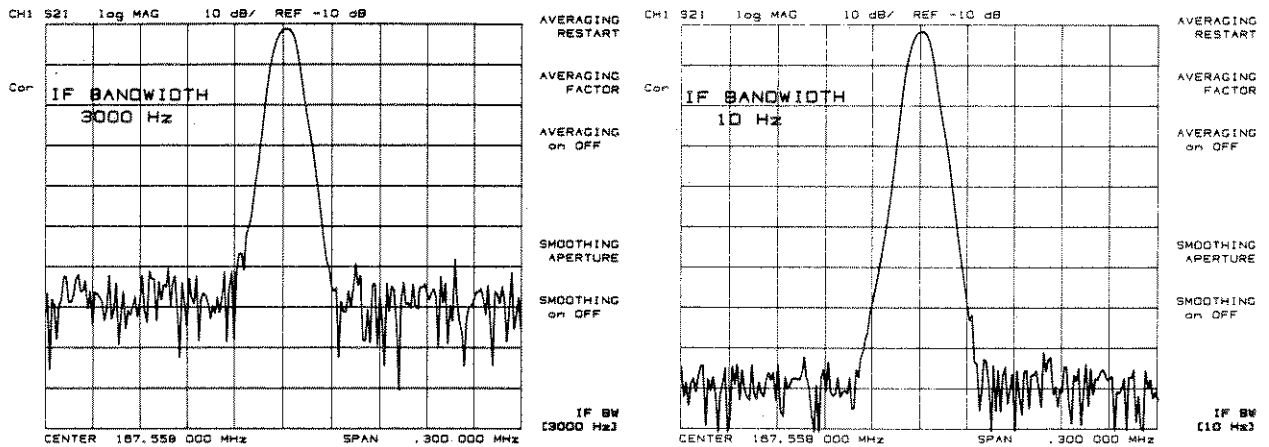

Figure 4-31. Effect of Smoothing on a Trace

**IF Bandwidth Reduction** lowers the noise floor by digitally reducing the receiver input bandwidth, and works in all ratio and non-ratio modes. It has an advantage over averaging in reliably filtering out unwanted responses such as spurs, odd harmonics, higher frequency spectral noise, and line-related noise. Sweep-to-sweep averaging, however, is better at filtering out very low frequency noise. A tenfold reduction in IF bandwidth lowers the measurement noise floor by about 10 dB. Bandwidths less than 300 Hz provide better harmonic rejection than higher bandwidths.

Another difference between sweep-to-sweep averaging and variable IF bandwidth is the sweep time. Averaging displays the first complete trace faster but takes several sweeps to reach a fully averaged trace. IF bandwidth reduction lowers the noise floor in one sweep, but the sweep time may be slower. Figure 4-32 illustrates the difference in noise floor between a trace measured with a 3000 Hz IF bandwidth and with a 10 Hz IF bandwidth.



**Figure 4-32. IF Bandwidth Reduction**

Another capability that can be used for effective noise reduction is the marker statistics function, which computes the average value of part or all of the formatted trace. Refer to Chapter 6.

Another way of increasing dynamic range is to increase the input power to the device under test using an HP 8347A amplifier. Refer to the *User's Guide* for an example.

## Average Menu

The average menu (Figure 4-33) is used to select the desired noise-reduction technique, and to set the parameters for the technique selected. It is also used to set the aperture for group delay measurements.

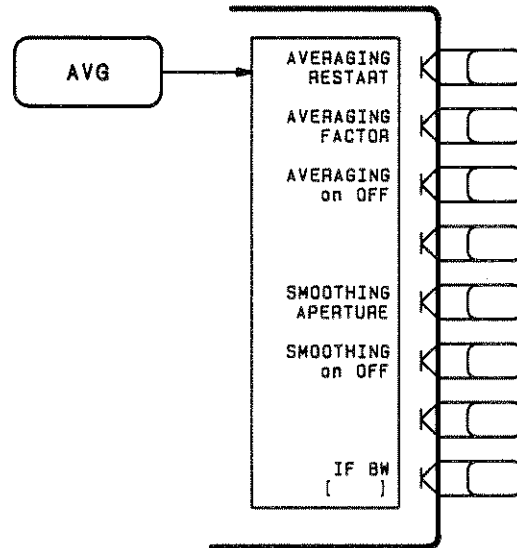

Figure 4-33. Average Menu

**[AVERAGING RESTART]** (AVERREST) resets the sweep-to-sweep averaging and restarts the sweep count at 1 at the beginning of the next sweep. The sweep count for averaging is displayed at the left of the CRT.

**[AVERAGING FACTOR]** (AVERFACT) makes averaging factor the active function. Any value up to 999 can be used. The algorithm used for averaging is:

$$A(n) = S(n)/F + (1-1/F) \times A(n-1)$$

where

A(n) = current average

S(n) = current measurement

F = average factor

**[AVERAGING on OFF]** (AVERON, AVEROFF) turns the averaging function on or off for the active channel. "Avg" is displayed in the status notations area at the left of the CRT, together with the sweep count for the averaging factor, when averaging is on. The sweep count for averaging is reset to 1 whenever an instrument state change affecting the measured data is made.

At the start of averaging or following **[AVERAGING RESTART]**, averaging starts at 1 and averages each new sweep into the trace until it reaches the specified averaging factor. The sweep count is displayed in the status notations area below "Avg" and updated every sweep as it increments. When the specified averaging factor is reached, the trace data continues to be updated, weighted by that averaging factor.

**[SMOOTHING APERTURE]** (SMOOPER) lets you change the value of the smoothing aperture as a percent of the span. When smoothing aperture is the active function, its value in stimulus units is displayed below its percent value in the active entry area.

Smoothing aperture is also used to set the aperture for group delay measurements (refer to *Group Delay Principles* earlier in this chapter). Note that the displayed smoothing aperture is not the group delay aperture unless smoothing is on.

**[SMOOTHING on OFF]** (SMOON, SMOOFF) turns the smoothing function on or off for the active channel. When smoothing is on, the annotation "Smo" is displayed in the status notations area.

**[IF BW]** (IFBW) is used to select the bandwidth value for IF bandwidth reduction. Settable values (in Hz) are 3000, 1000, 300, 100, 30, and 10. Any other value will default to the next allowable value. A narrow bandwidth slows the sweep speed but provides better signal-to-noise ratio. The selected bandwidth value is shown in brackets in the softkey label.

# Chapter 5. Measurement Calibration

## CHAPTER CONTENTS

|      |                                                                                                                        |      |                                                                          |
|------|------------------------------------------------------------------------------------------------------------------------|------|--------------------------------------------------------------------------|
| 5-1  | Introduction                                                                                                           | 5-25 | Full 2-Port Calibration for Reflection and Transmission Measurements     |
| 5-2  | Accuracy Enhancement                                                                                                   |      |                                                                          |
| 5-2  | Sources of Measurement Errors                                                                                          | 5-27 | One-Path 2-Port Calibration for Reflection and Transmission Measurements |
| 5-5  | Correcting for Measurement Errors                                                                                      |      |                                                                          |
| 5-8  | Why, After Calibration, Does the Frequency Response of Some Calibration Standards Appear as a Curve Rather Than a Dot? | 5-28 | Power Meter Calibration                                                  |
| 5-10 | Menus and Softkeys                                                                                                     | 5-30 | The Two Modes of Operation in Power Meter Calibration                    |
| 5-10 | [CAL] Key                                                                                                              | 5-34 | Using Power Meter Calibration                                            |
| 5-11 | Interpolated Error Correction                                                                                          | 5-36 | Power Meter Calibration Menus                                            |
| 5-13 | Correction Menu                                                                                                        | 5-38 | Power Loss/Sensor Lists Menu                                             |
| 5-14 | Cal Kit Menu                                                                                                           | 5-39 | Segment Modify Menu                                                      |
| 5-15 | Calibrate More Menu                                                                                                    | 5-40 | Segment Edit (Calibration Factor %) Menu                                 |
| 5-17 | Reference Plane Menu                                                                                                   | 5-41 | Segment Edit (Power Loss) Menu                                           |
| 5-18 | Calibration Menu                                                                                                       | 5-41 | Modifying Calibration Kits                                               |
| 5-20 | Purpose and Use of Different Calibration Procedures (table)                                                            | 5-43 | Modify Cal Kit Menu                                                      |
| 5-21 | Response Calibration for Reflection Measurements                                                                       | 5-44 | Define Standard Menus                                                    |
| 5-22 | Response Calibration for Transmission Measurements                                                                     | 5-46 | Specify Offset Menu                                                      |
| 5-22 | Response and Isolation Calibration for Reflection Measurements                                                         | 5-48 | Label Standard Menu                                                      |
| 5-23 | Response and Isolation Calibration for Transmission Measurements                                                       | 5-49 | Specify Class Menus                                                      |
| 5-24 | $S_{11}$ 1-Port Calibration for Reflection Measurements                                                                | 5-51 | Label Class Menus                                                        |
| 5-25 | $S_{22}$ 1-Port Calibration                                                                                            | 5-51 | Label Kit Menu                                                           |
|      |                                                                                                                        | 5-51 | Verify Performance                                                       |
|      |                                                                                                                        | 5-52 | Example Procedure                                                        |
|      |                                                                                                                        | 5-53 | Appendix: Accuracy Enhancement Fundamentals                              |
|      |                                                                                                                        | 5-53 | One-Port Error Model                                                     |
|      |                                                                                                                        | 5-59 | Two-Port Error Model                                                     |

## INTRODUCTION

Measurement calibration is an accuracy enhancement procedure that effectively removes the system errors that cause uncertainty in measuring a device under test. It measures known standard devices, and uses the results of these measurements to characterize the system.

This chapter explains the theoretical fundamentals of accuracy enhancement and the sources of measurement errors. It describes the different measurement calibration procedures available in the HP 8753B, which errors they correct, and the measurements for which each should be used. An appendix at the end of this chapter provides further information on characterizing systematic errors and using error models to analyze overall measurement performance.

## **ACCURACY ENHANCEMENT**

If it were possible for a perfect measurement system to exist, it would have infinite dynamic range, isolation, and directivity characteristics, no impedance mismatches in any part of the test setup, and flat frequency response. Vector accuracy enhancement, also known as measurement calibration or error correction, provides the means to simulate a perfect measurement system.

In any high frequency measurement there are certain measurement errors or ambiguities associated with the system that contribute uncertainty to the results. Parts of the measurement setup such as interconnecting cables and signal separation devices (as well as the network analyzer itself) all introduce variations in magnitude and phase that can mask the actual performance of the device under test.

For example, crosstalk due to the channel isolation characteristics of the network analyzer can contribute an error equal to the transmission signal of a high-loss test device. Similarly, for reflection measurements, the primary limitation of dynamic range is the directivity of the test setup. The measurement system cannot distinguish the true value of the signal reflected by the device under test from the signal arriving at the receiver input due to leakage in the system. For both transmission and reflection measurements, impedance mismatches within the test setup cause measurement uncertainties that appear as ripples superimposed on the measured data.

Measurement calibration simulates a perfect network analyzer system. It measures the magnitude and phase responses of known standard devices, and compares the measurement with actual device data. It uses the results to characterize the system and effectively remove the system errors from the measurement data of a test device, using vector math capabilities internal to the network analyzer.

When measurement calibration is used, the dynamic range and accuracy of the measurement are limited only by system noise and stability, connector repeatability, and the accuracy to which the characteristics of the calibration standards are known.

## **SOURCES OF MEASUREMENT ERRORS**

Network analysis measurement errors can be separated into systematic, random, and drift errors.

Correctable systematic errors are the repeatable errors that the system can measure. These are errors due to mismatch and leakage in the test setup, isolation between the reference and test signal paths, and system frequency response.

Random and drift errors are the non-repeatable errors that the system itself cannot measure, and therefore cannot correct for. These errors affect both reflection and transmission measurements. Random errors are measurement variations due to noise and connector repeatability. Drift errors include frequency drift, temperature drift, and other physical changes in the test setup between calibration and measurement.

The resulting measurement is the vector sum of the device under test response plus all error terms. The precise effect of each error term depends upon its magnitude and phase relationship to the actual test device response.

In most high frequency measurements the systematic errors are the most significant source of measurement uncertainty. Since each of these errors can be characterized, their effects can be effectively removed to obtain a corrected value for the test device response. For the purpose of vector accuracy enhancement these uncertainties are quantified as directivity, source match, load match, isolation (crosstalk), and frequency response (tracking). Each of these systematic errors is described below.



Random and drift errors cannot be precisely quantified, so they must be treated as producing a cumulative ambiguity in the measured data.

## Directivity

Normally a device that can separate the reverse from the forward traveling waves (a directional bridge or coupler) is used to detect the signal reflected from the device under test. Ideally the coupler would completely separate the incident and reflected signals, and only the reflected signal would appear at the coupled output, as illustrated in Figure 5-1a.

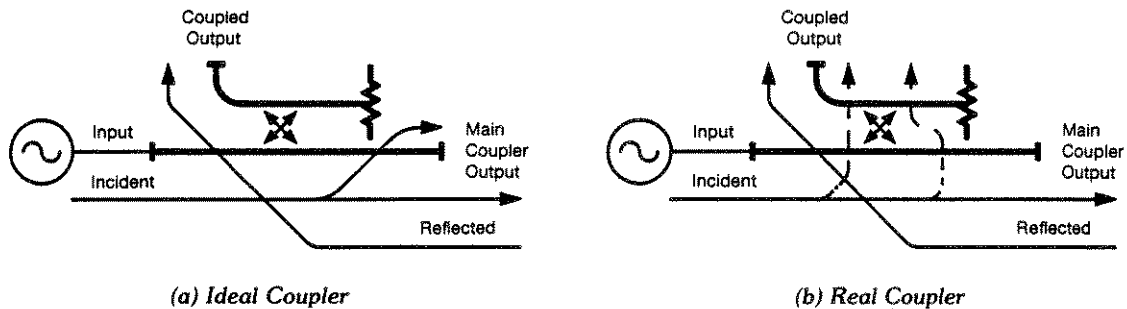

Figure 5-1. Directivity

However, a real coupler is not perfect, as illustrated in Figure 5-1b. A small amount of the incident signal appears at the coupled output due to leakage as well as to reflection from the termination in the coupled arm. Also reflections from the coupler output connector appear at the coupled output, adding uncertainty to the signal reflected from the device. The figure of merit for how well a coupler separates forward and reverse waves is directivity. The greater the directivity of the device, the better the signal separation. System directivity is the vector sum of all leakage signals appearing at the network analyzer receiver input due to the inability of the signal separation device to absolutely separate incident and reflected waves, and to residual reflection effects of test cables and adapters between the signal separation device and the measurement plane. The error contributed by directivity is independent of the characteristics of the test device and it usually produces the major ambiguity in measurements of low reflection devices.

## Source Match

Source match is defined as the vector sum of signals appearing at the network analyzer receiver input due to the impedance mismatch at the test device looking back into the source, as well as to adapter and cable mismatches and losses. In a reflection measurement, the source match error signal is caused by some of the reflected signal from the DUT being reflected from the source back towards the DUT and re-reflected from the DUT (Figure 5-2). In a transmission measurement, the source match error signal is caused by reflection from the test device that is re-reflected from the source. Source match is most often given in terms of return loss in dB: thus the larger the number, the smaller the error.

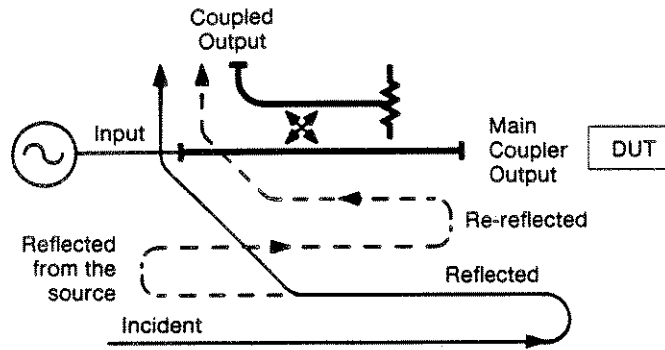

Figure 5-2. Source Match

The error contributed by source match is dependent on the relationship between the actual input impedance of the test device and the equivalent match of the source, and it is a factor in both transmission and reflection measurements. Source match is particularly a problem in measurements where there is a large impedance mismatch at the measurement plane.

### Load Match

Load match error results from an imperfect match at the output of the test device. It is caused by impedance mismatches between the test device output port and port 2 of the measurement system. As illustrated in Figure 5-3, some of the transmitted signal is reflected from port 2 back to the test device. A portion of this wave may be re-reflected to port 2, or part may be transmitted through the device in the reverse direction to appear at port 1. If the DUT has low insertion loss (for example a transmission line), the signal reflected from port 2 and re-reflected from the source causes a significant error because the DUT does not attenuate the signal significantly on each reflection. Load match is usually given in terms of return loss in dB: thus the larger the number, the smaller the error

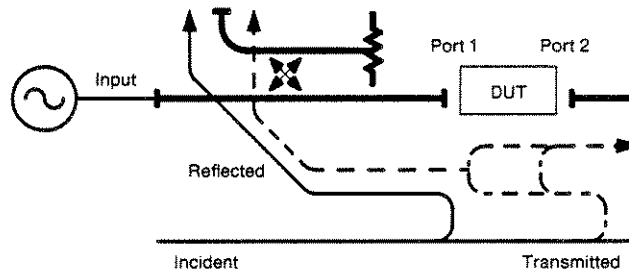

Figure 5-3. Load Match

The error contributed by load match is dependent on the relationship between the actual output impedance of the test device and the effective match of the return port (port 2), and is a factor in all transmission measurements and in reflection measurements of two-port devices. Load and source match are usually ignored when the test device insertion loss is greater than about 6 dB, because the error signal is greatly attenuated each time it passes through the DUT. However, load match effects produce major transmission measurement errors for a test device with a highly reflective output port.

## Isolation (Crosstalk)

Leakage of energy between network analyzer signal paths contributes to error in a transmission measurement much like directivity does in a reflection measurement. Isolation is the vector sum of signals appearing at the network analyzer samplers due to crosstalk between the reference and test signal paths, including signal leakage within the test set and in both the RF and IF sections of the receiver.

The error contributed by isolation depends on the characteristics of the device under test. Isolation is a factor in high-loss transmission measurements. However, HP 8753B system isolation is more than sufficient for most measurements, and correction for it may be unnecessary. For measuring devices with high dynamic range, accuracy enhancement can provide improvements in isolation that are limited only by the noise floor.

## Frequency Response (Tracking)

This is the vector sum of all test setup variations in which magnitude and phase change as a function of frequency. This includes variations contributed by signal separation devices, test cables, and adapters, and variations between the reference and test signal paths. This error is a factor in both transmission and reflection measurements.

For further explanation of systematic error terms and the way they are combined and represented graphically in error models, refer to the appendix at the end of this chapter, titled *Accuracy Enhancement Fundamentals – Characterizing Microwave Systematic Errors*.

## CORRECTING FOR MEASUREMENT ERRORS

In all, there are twelve different error terms for a two-port measurement that can be corrected by accuracy enhancement in the HP 8753B. These are directivity, source match, load match, isolation, reflection tracking, and transmission tracking, each in both the forward and reverse direction. The HP 8753B has several different measurement calibration routines to characterize one or more of the systematic error terms and remove their effects from the measured data. The procedures range from a simple frequency response calibration to a full two-port calibration that effectively removes all twelve error terms.

**The Response Calibration** effectively removes the frequency response errors of the test setup for reflection or transmission measurements. This calibration procedure may be adequate for measurement of well matched low-loss devices. This is the simplest error correction to perform, and should be used when extreme measurement accuracy is not required.

**The Response and Isolation Calibration** effectively removes frequency response and crosstalk errors in transmission measurements, or frequency response and directivity errors in reflection measurements. This procedure may be adequate for measurement of well matched high-loss devices.

**The  $S_{11}$  and  $S_{22}$  One-Port Calibration** procedures provide directivity, source match, and frequency response vector error correction for reflection measurements. These procedures provide high accuracy reflection measurements of one-port devices or properly terminated two-port devices.

**The Full Two-Port Calibration** provides directivity, source match, load match, isolation, and frequency response vector error correction, in both forward and reverse directions, for transmission and reflection measurements of two-port devices. This calibration provides the best magnitude and phase measurement accuracy for both transmission and reflection measurements of two-port devices, and requires an S-parameter test set.

**The One-Path Two-Port Calibration** provides directivity, source match, load match, isolation, and frequency response vector error correction in one direction. It is used for high accuracy transmission and reflection measurements using a transmission/reflection test set, such as the HP 85044A. (The device under test must be manually reversed between sweeps to accomplish measurements in both the forward and reverse directions.)

All the calibration procedures described above are accessed from the [CAL] key and are described in the following pages.

The uncorrected performance of the HP 8753B is sufficient for many measurements. However, the vector accuracy enhancement techniques described in this chapter will provide a much higher level of accuracy. Figures 5-4, 5-5, and 5-6 illustrate the improvements that can be made in measurement accuracy by using a more complete calibration routine. Figure 5-4a shows a measurement in log magnitude format with a response calibration only. Figure 5-4b shows the improvement in the same measurement using an  $S_{11}$  one-port calibration. Figure 5-5a shows the measurement on a Smith chart with response calibration only, and Figure 5-5b shows the same measurement with an  $S_{11}$  one-port calibration.

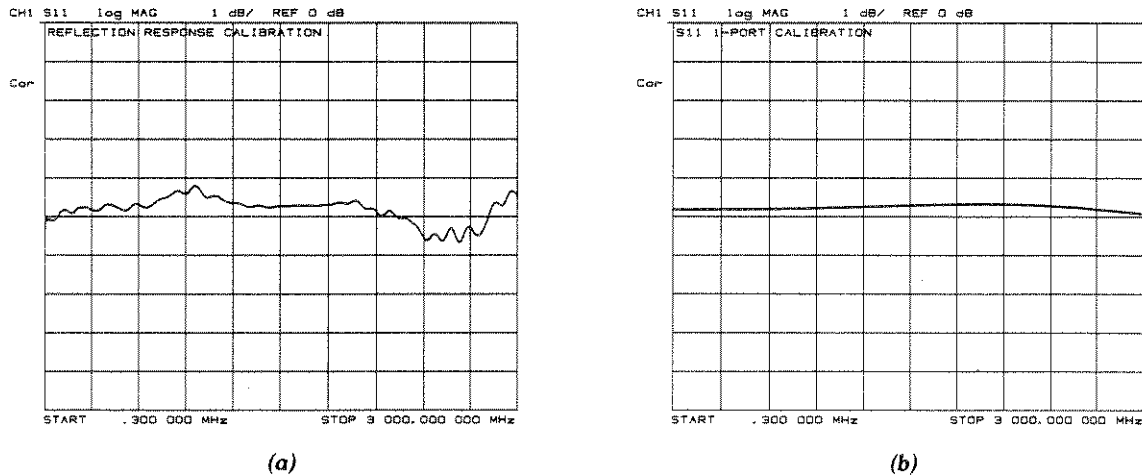
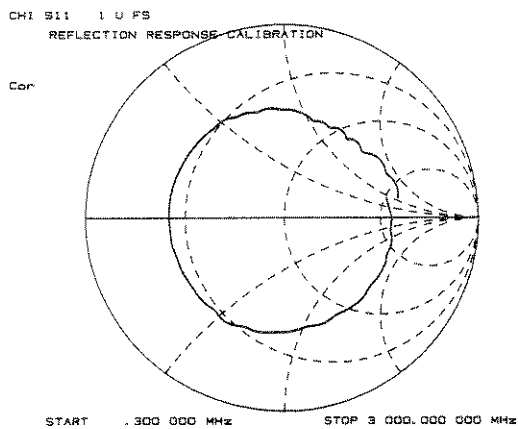
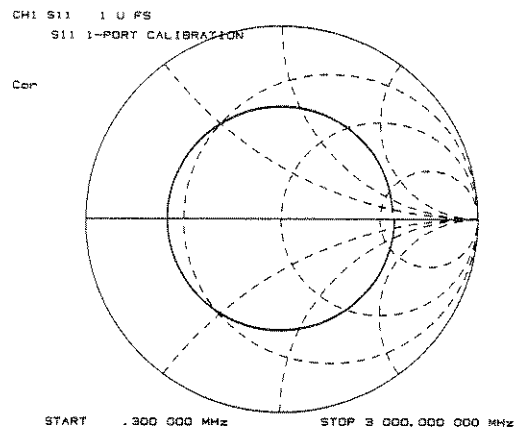

Figure 5-4. Response vs.  $S_{11}$  1-Port Calibration on Log Magnitude Format



(a)



(b)

Figure 5-5. Response vs.  $S_{11}$  1-Port Calibration on Smith Chart

Figure 5-6 shows the response of a low-loss device in a log magnitude format, using a response calibration in Figure 5-6a and a full two-port calibration in Figure 5-6b.

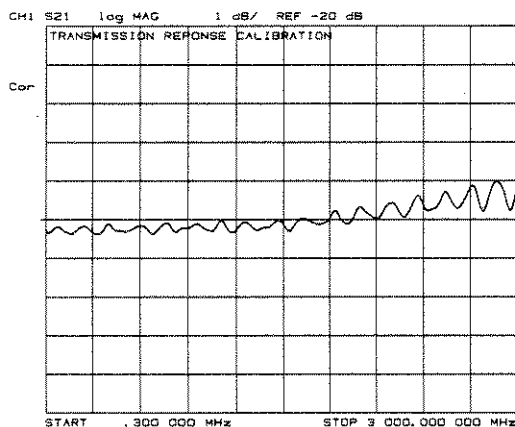

(a)

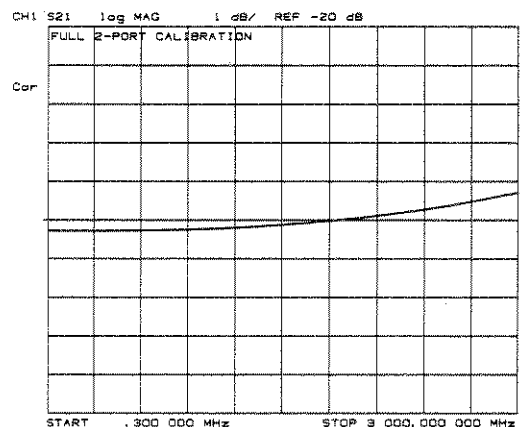

(b)

Figure 5-6. Response vs. Full Two-Port Calibration

After the correctable systematic errors are effectively removed using accuracy enhancement, residual uncertainties remain. In addition to random and drift errors, these include residual systematic errors resulting from imperfections in the calibration standards, the connector interface, the interconnecting cables, and the instrumentation. Refer to *System Performance* in the *General Information and Specifications* section of this manual. This provides information for calculating the system's total error-corrected measurement uncertainty performance.

## Why, After Calibration, Does the Frequency Response of Some Calibration Standards Appear as a Curve Rather Than a Dot?

In order for the response of a reference standard to show as a dot on the display, it must have no phase shift with respect to frequency. Standards that exhibit such "perfect" response are shown below:

- 7 mm short (with no offset)
- type-N male short (with no offset)

There are two reasons why other types of reference standards show phase shift after calibration:

- The reference plane of the standard is electrically offset from the mating plane of the test port. Such devices exhibit the properties of a small length of transmission line, including a certain amount of phase shift.
- The standard is an open termination, which by definition exhibits a certain amount of fringe capacitance (and therefore phase shift). Open terminations which are offset from the mating plane will exhibit a phase shift due to the offset in addition to the phase shift caused by the fringe capacitance.

The most important point to remember is that these properties will not affect your measurements. The HP 8753B compensates for them during measurement. Figure 5-7 shows sample displays of various calibration standards after calibration.

**Electrical Offset.** Some standards have reference planes that are electrically offset from the mating plane of the test port. These devices will show a phase shift with respect to frequency. The master reference table (Table 5-1) shows which reference devices exhibit an electrical offset phase shift. The amount of phase shift can be calculated with the formula:

$$\phi = (360 \times f \times l)/c \text{ where:}$$

f = frequency

l = electrical length of the offset

c = speed of light ( $3 \times 10^8$  meters/second).

**Fringe Capacitance.** All open circuit terminations exhibit a phase shift over frequency due to fringe capacitance. And offset open circuits additionally have increased phase shift because the offset acts as a small length of transmission line. Refer to the master reference table.

Table 5-1. Master Reference Table Showing Calibration Standard Types and Expected Phase Shift

| Test Port Connector Type                      | Standard Type | Expected Phase Shift                                              |
|-----------------------------------------------|---------------|-------------------------------------------------------------------|
| 7 mm<br>type-N male                           | Short         | 180° (ideal)                                                      |
| 3.5 mm male<br>3.5 mm female<br>type-N female | Offset Short  | $180^\circ + (360 \times f \times l)/c$                           |
| 7 mm<br>type-N male                           | Open          | $0^\circ + \phi_{\text{capacitance}}$                             |
| 3.5 mm male<br>3.5 mm female<br>type-N female | Offset Open   | $0^\circ + \phi_{\text{capacitance}} + (360 \times f \times l)/c$ |

**NOTE:** The sex associated with a reference standard refers to the sex of the test port, not the sex of the standard itself.

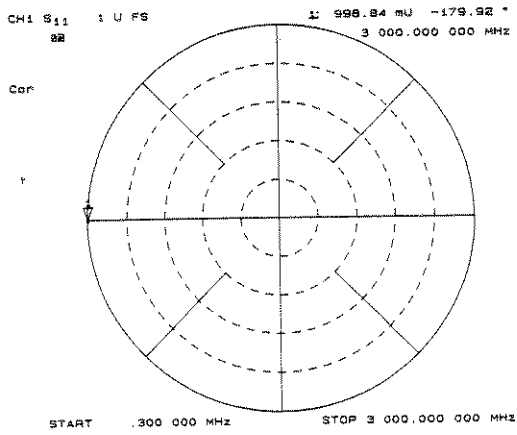

**7 mm or Type-N Male  
Short (No Offset)**

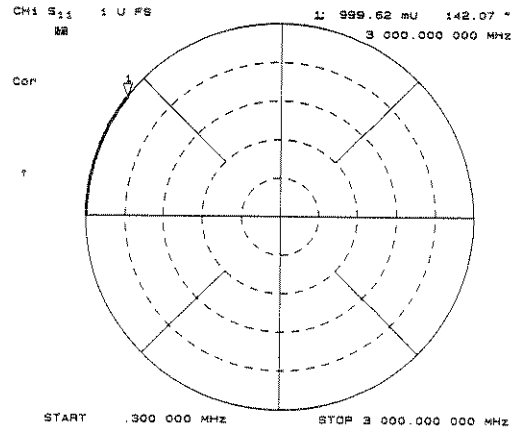

**Type-N Female,  
3.5 mm Male or Female Offset Short**

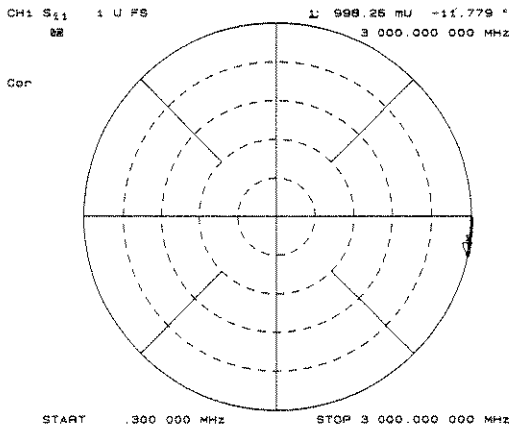

**7 mm or Type-N Male  
Open (No Offset)**

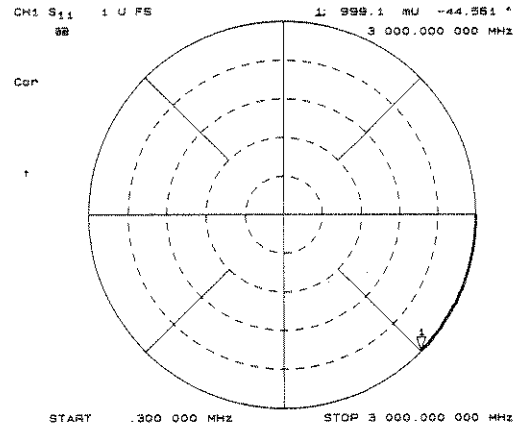

**Type-N Female,  
3.5 mm Male or Female Offset Open**

**Figure 5-7. Typical Responses of Calibration Standards after Calibration**

# MENUS AND SOFTKEYS

## [CAL] Key

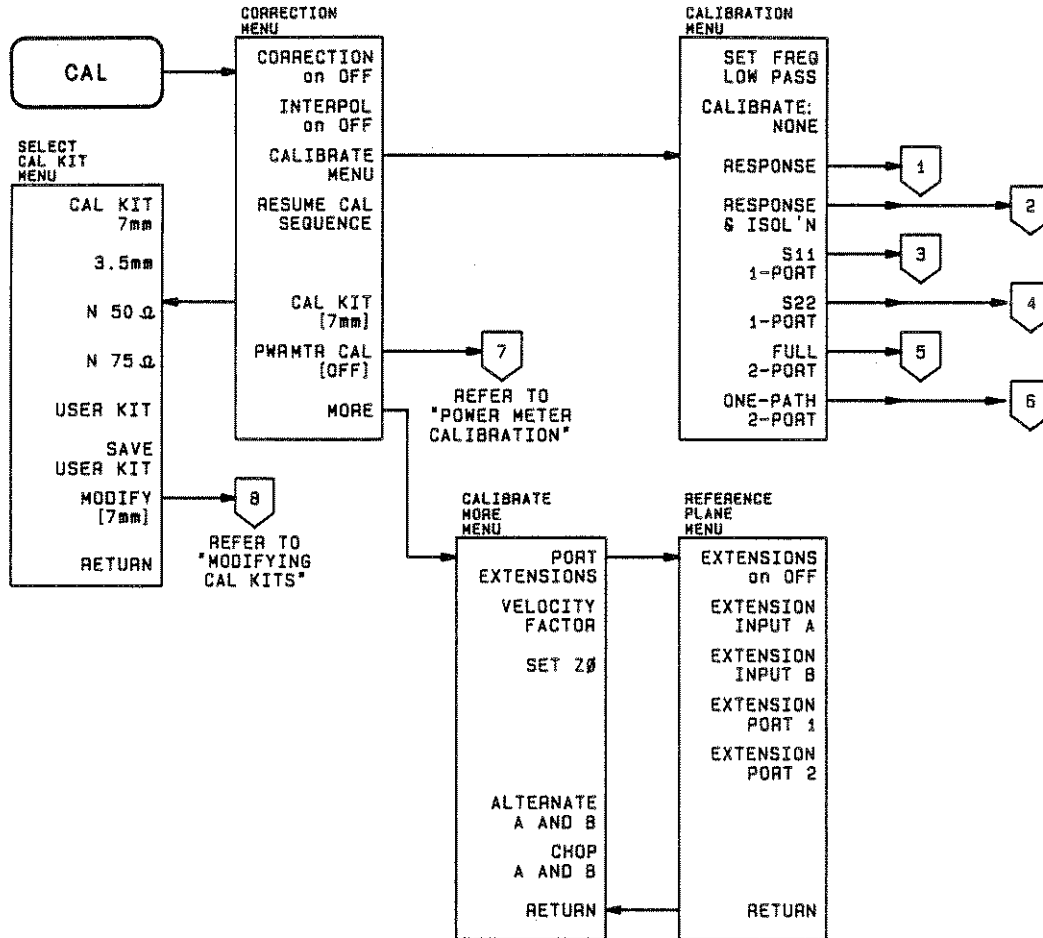

Figure 5-8. Relationship of the Menus Accessed from the [CAL] Key

The [CAL] (MENCAL) key leads to a series of menus that implement the accuracy enhancement procedures described in the preceding pages (see Figure 5-8). Accuracy enhancement (error correction) is performed as a calibration step before measurement of a test device. The HP 8753B uses one of several different procedures to measure the systematic (repeatable) errors of the system and remove their effects from the measured data. The calibration menus and procedures are described and illustrated in the following pages. Each procedure compensates for one or more of the systematic error terms. These range from a simple response calibration that removes the frequency response errors of the test setup to a full two-port vector calibration that removes all twelve error terms. Measurements of standard devices are used to solve for the error terms.



**Standard Devices.** The standard devices required for calibration of the HP 8753B system are available in compatible calibration kits with different connector types. The model numbers and contents of these calibration kits are listed in the *General Information and Specifications* section of this manual. Each kit contains at least one short circuit, one open circuit, and two impedance-matched loads. In kits that require adapters for interface to the test set ports, the adapters are phase-matched for calibration prior to measurement of non-insertable and non-reversible devices. Other standard devices can be used by specifying their characteristics in a user-defined kit, as described later in this chapter under *Modifying Calibration Kits*.

The accuracy improvement of the correction is limited by the quality of the standard devices, and by the connection techniques used. For information about connector care and connection techniques, refer to the *Microwave Connector Care* manual or the application note, *Principles of Microwave Connector Care*. Both of these documents are provided in the *HP 8753B Test Sets and Accessories Manual*. For maximum accuracy, use a torque wrench for final connections. The techniques for torquing connections and the part numbers for torque wrenches recommended for different connector types are provided in the connector care documents listed above.

**Calibration Validity.** Unless interpolated error correction is on, measurement calibrations are valid only for a specific stimulus state, which must be set before calibration is begun. The stimulus state consists of the selected frequency range, number of points, sweep time, output power, and sweep type. Changing the frequency range, number of points, or sweep type with correction on invalidates the calibration and turns it off. Changing the sweep time or output power changes the status notation "Cor" at the left of the screen to "C?", to indicate that the calibration is in question. If correction is turned off or in question after the stimulus changes are made, pressing [**CORRECTION ON**] recalls the original stimulus state for the current calibration.

**Interpolated Error Correction.** The interpolated error correction feature allows the operator to select a subset of the frequency range or a different number of points without recalibration. Interpolation must be activated by softkey before it will function. When interpolation is on, the system errors for the newly selected frequencies are calculated from the system errors of the original calibration.

System performance is unspecified when using interpolated error correction. The quality of the interpolated error correction is dependent on the amount of phase shift and the amplitude change between measurement points. If phase shift is no greater than 180° per approximately 5 measurement points, interpolated error correction offers a great improvement over uncorrected measurements. The accuracy of interpolated error correction improves as the phase shift and amplitude change between adjacent points decrease. When using an HP 8753B in linear frequency sweep with an HP 85046A/B or 85047A test set, it is recommended that the original calibration be performed with at least 67 points per 1 GHz of frequency span.

Interpolated error correction functions in three sweep modes: linear frequency, power sweep, and CW time.

If there is a valid correction array for a linear frequency sweep, this may be interpolated to provide correction at the CW frequency used in power sweep or CW time modes. This correction is part of the interpolated error correction feature and is not specified.

**Channel Coupling.** Up to two sets of measurement calibration data can be defined for each instrument state, one for each channel. If the two channels are stimulus coupled and the input ports are the same for both channels, they share the same calibration data. If the two channel inputs are different, they can have different calibration data. If the two channels are stimulus uncoupled, the measurement calibration applies to only one channel. For information on stimulus coupling, refer to Chapter 3, *Stimulus Function Block*.

**Measurement Parameters.** Calibration procedures are parameter-specific, rather than channel-specific. When a parameter is selected, the instrument checks the available calibration data, and uses the data found for that parameter. For example, if a transmission response calibration is performed for B/R, and an  $S_{11}$  1-port calibration for A/R, the HP 8753B retains both calibration sets and corrects whichever parameter is displayed. Once a calibration has been performed for a specific parameter or input, measurements of that parameter remain calibrated in either channel, as long as stimulus values are coupled. In the response and response and isolation calibrations, the parameter must be selected before calibration: other correction procedures select parameters automatically. Changing channels during a calibration procedure invalidates the part of the procedure already performed.

**Device Measurements.** In procedures that require measurement of several different devices, for example a short, an open, and a load, the order in which the devices are measured is not critical. Any standard can be re-measured, until the **[DONE]** key is pressed. The change in trace during measurement of a standard is normal.

Response and response and isolation calibrations require measurement of only one standard device. If more than one device is measured, only the data for the last device is retained.

**Omitting Isolation Calibration.** Isolation calibration can be omitted for most measurements, except where wide dynamic range is a consideration. Use the following guidelines. When the measurement requires a dynamic range of:

- 80 dB: Omit isolation calibration for most measurements.
- 80 to 100 dB: Isolation calibration is recommended with approximately 0 dBm into the R input.
- 100 dB: Averaging should be on with an averaging factor  $\geq 16$ , both for isolation calibration and for measurement after calibration.

**Restarting a Calibration.** A calibration that is interrupted to go to another menu can be continued with the **[RESUME CAL SEQUENCE]** key in the correction menu.

**Saving Calibration Data.** It is recommended that calibration data be saved, either in internal volatile memory or on an external disc. Refer to Chapter 10, *Saving Instrument States*. If a calibration is not saved, it will be lost if another calibration procedure is selected for the same channel, or if stimulus values are changed. Instrument preset, power on, and instrument state recall will also clear the calibration data.

**Specifying Calibration Kits.** In addition to the menus for the different calibration procedures, the **[CAL]** key provides access to a series of menus used to specify the characteristics of the calibration standards used. Several default calibration kits with different connector types are predefined, or the definitions can be modified to any set of standards used.

## Correction Menu

The correction menu is the first menu presented by the [CAL] key, and it provides access to numerous menus of additional calibration features.

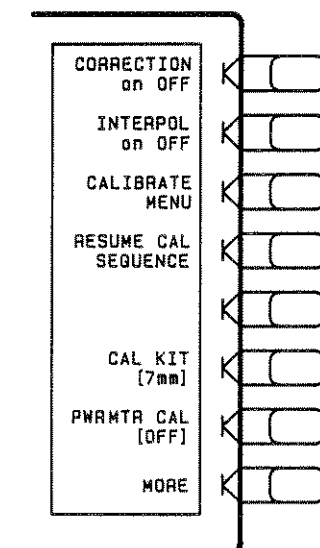

Figure 5-9. Correction Menu

**[CORRECTION on OFF]** (CORRON, CORROFF) turns error correction on or off. The HP 8753B uses the most recent calibration data for the displayed parameter. If the stimulus state has been changed since calibration, the original state is recalled, and the message "SOURCE PARAMETERS CHANGED" is displayed.

A calibration must be performed before correction can be turned on. If no valid calibration exists, the message "CALIBRATION REQUIRED" is displayed on the CRT. If interpolated error correction is on, this message is not displayed if you have selected a subset of a previously calibrated frequency range. See the **[INTERPOL on OFF]** description, below.

It is recommended that calibration data be saved, either in internal volatile memory or on an external disc, using capabilities described in Chapter 10, *Saving Instrument States*.

**[INTERPOL on OFF]** (CORION, CORIOFF) turns interpolated error correction on or off. The interpolated error correction feature allows the operator to calibrate the system, then select a subset of the frequency range or a different number of points. Interpolated error correction functions in linear frequency, power sweep and CW time modes. If using an HP 8753B in linear sweep with an HP 85046A/B or 85047A test set, it is recommended that the original calibration be performed with at least 67 points per 1 GHz of frequency span.

**[CALIBRATE MENU]** leads to the calibration menu, which provides several accuracy enhancement procedures ranging from a simple frequency response calibration to a full two-port calibration. At the completion of a calibration procedure, this menu is returned to the screen, correction is automatically turned on, and the notation "Cor" or "C2" is displayed at the left of the screen.

**[RESUME CAL SEQUENCE]** (RESC) eliminates the need to restart a calibration sequence that was interrupted to access some other menu. This softkey goes back to the point where the calibration sequence was interrupted.

**[CAL KIT]** leads to the select cal kit menu, which is used to select one of the default HP 8753B compatible calibration kits available for different connector types. This in turn leads to additional menus used to define calibration standards other than those in the default kits (refer to *Modifying Calibration Kits*, later in this chapter). When a calibration kit has been specified, its connector type is displayed in brackets in the softkey label.

**[PWR METER CAL]** leads to the power meter calibration menu which provides two types of power meter calibration, continuous and single-sample. Power meter calibration is described later in this chapter.

**[MORE]** provides access to the calibrate more menu, which is used to extend the test port reference plane, to specify the characteristic impedance of the system, to select the optimum receiver sweep mode, and to specify the relative propagation velocity factor for distance-to-fault measurements using the time domain option.

## Cal Kit Menu

The cal kit menu is used to select the calibration kit to be used for a measurement calibration. Selecting a cal kit chooses the model that mathematically describes the standard devices actually used. (Refer to the beginning of this chapter, and the appendix at the end of this chapter, for more background on measurement calibrations and error correction.)

The HP 8753B has the capability to calibrate with four predefined cal kits in four different connector types. The models for these cal kits correspond to the standard calibration kits available as accessories for the HP 8753B:

|        |                                         |
|--------|-----------------------------------------|
| 7 mm   | HP 85031B 7 mm calibration kit          |
| 3.5 mm | HP 85033C 3.5 mm calibration kit        |
| N 50Ω  | HP 85032B 50 ohm type-N calibration kit |
| N 75Ω  | HP 85036B 75 ohm type-N calibration kit |

How closely must the model match the actual device? The answer depends on the accuracy required. Certainly *any* calibration provides better accuracy than none at all, in fact simple normalization is adequate for many applications. The errors introduced by using the internal 7 mm model with a Hewlett-Packard 7 mm cal kit other than the HP 85031B are vanishingly small. Yet for the highest accuracy, the more closely the model matches the device, the better.

In addition to the four predefined cal kits, a fifth choice is a "user kit" that is defined or modified by the user. This is described under *Modifying Calibration Kits* later in this chapter.

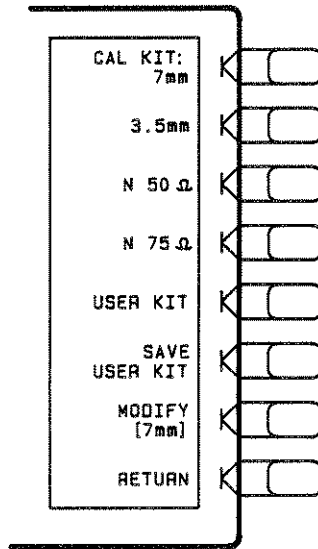

Figure 5-10. Select Cal Kit Menu

**[CAL KIT: 7mm]** (CALK7MM) selects the 7 mm cal kit model.

**[3.5mm]** (CALK35MM) selects the 3.5 mm cal kit model.

**[N 50Ω]** (CALKN50) selects the 50 ohm type-N model.

**[N 75Ω]** (CALKN75) selects the 75 ohm type-N model.

**NOTE:** If **[N 50Ω]** or **[N 75Ω]** is selected, additional menus are provided during calibration procedures to select the connector sex. (This is the connector sex of the input port, not the actual calibration standard.)

**[USER KIT]** (CALKUSED) selects a cal kit model defined or modified by the user. For information, refer to *Modifying Calibration Kits*, later in this chapter.

**[SAVE USER KIT]** (SAVEUSEK) stores the user-modified or user-defined kit into memory, after it has been modified.

**[MODIFY]** (MODI1) leads to the modify cal kit menu, where a predefined cal kit can be user-modified.

**[RETURN]** returns to the correction menu.

## Calibrate More Menu

This menu is used to extend the test port reference plane, to specify the characteristic impedance of the system, to select the optimum receiver sweep mode, and to specify the relative propagation velocity factor for distance-to-fault measurements.

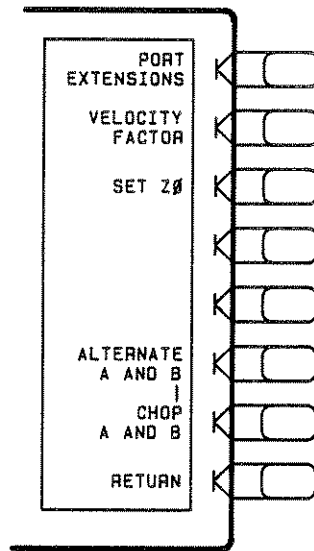

Figure 5-11

**[PORT EXTENSIONS]** goes to the reference plane menu, which is used to extend the apparent location of the measurement reference plane or input.

The differences between the **[PORT EXTENSIONS]** and **[ELECTRICAL DELAY]** functions are shown below:

|                                | <b>[PORT EXTENSIONS]</b>                                                                                                   | <b>[ELECTRICAL DELAY]</b>                                                                                                                                                                          |
|--------------------------------|----------------------------------------------------------------------------------------------------------------------------|----------------------------------------------------------------------------------------------------------------------------------------------------------------------------------------------------|
| <b>Main Effect</b>             | The end of a cable becomes the test port plane for all S-parameter measurements.                                           | Compensates for the electrical length of a cable for the current type of measurement only.<br>Reflection = 2 times cable's electrical length.<br>Transmission = 1 times cable's electrical length. |
| <b>Measurements Affected</b>   | All S-parameters.                                                                                                          | Only the currently selected S-parameter.                                                                                                                                                           |
| <b>Electrical Compensation</b> | Intelligently compensates for 1 times or 2 times the cable's electrical delay, depending on which S-parameter is computed. | Only compensates as necessary for the currently selected S-parameter.                                                                                                                              |

**[VELOCITY FACTOR]** (VELOFACT) Enters the velocity factor used by the HP 8753B to calculate equivalent electrical length in distance-to-fault measurements using the time domain option. Values entered should be less than 1. For example, the velocity factor of teflon is:

$$V_f = \frac{1}{\sqrt{\epsilon_R}} = 0.666$$

**[SET Z0]** (SETZ) sets the characteristic impedance used by the HP 8753B in calculating measured impedance with Smith chart markers and conversion parameters. If the test set used is an HP 85046B S-parameter test set or an HP 85044B transmission/reflection test set, set Z0 to 75 ohms. Characteristic impedance must be set correctly before calibration procedures are performed.

**[ALTERNATE A and B]** (ALTAB) measures only one input per frequency sweep, in order to reduce spurious signals. Thus, this mode optimizes the dynamic range for all four S-parameter measurements. This is the default measurement mode.

The disadvantages of this mode are associated with simultaneous transmission/reflection measurements or full two-port calibrations: this mode takes twice as long as the chop mode to make these measurements. In addition, the port match changes due to either input A or B being inactive during each sweep, which are in the order of  $< -55$  dB, may affect transmission measurements.

**[CHOP A and B]** (CHOPAB) measures both inputs A and B during each sweep. Thus, if each channel is measuring a different parameter and both channels are displayed, the chop mode offers the fastest measurement time. This is the preferred measurement mode for full two-port calibrations because both inputs remain active.

The disadvantage of this mode is that in measurements of high rejection devices, such as filters with a low-loss passband ( $>400$  MHz wide), maximum dynamic range may not be achieved.

**NOTE:** If more dynamic range is desired for a measurement of  $S_{21}$  in either the chop or the alternate mode, a 10 dB attenuator can be connected to input A and another to input R. This improves the crosstalk into input B. The dynamic range of input B is increased, but the usable dynamic range of input A is reduced.

**[RETURN]** goes back to the correction menu.

## Reference Plane Menu

This menu adds electrical delay in seconds to the measurement ports to extend the apparent location of the measurement reference plane to the ends of the cables. This is equivalent to adding a length of perfect air line, and makes it possible to measure the delay response of the device only instead of the device plus the cable.

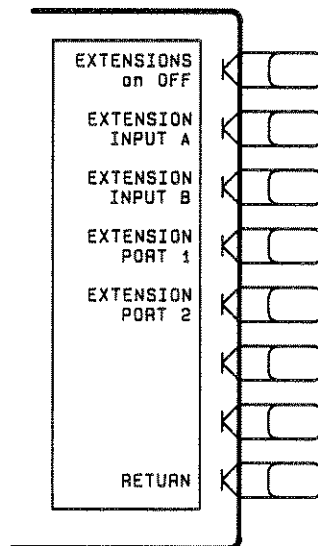

Figure 5-12

**[EXTENSIONS on OFF]** (POREON, POREOFF) toggles the reference plane extension mode. When this function is on, all extensions defined below are enabled; when off, none of the extensions is enabled.

**[EXTENSION INPUT A]** (PORTA). Use this feature to add electrical delay in seconds to extend the reference plane at input A to the end of the cable. This is used for any input measurements including S-parameters.

**[EXTENSION INPUT B]** (PORTB) adds electrical delay to the input B reference plane for any B input measurements including S-parameters.

**[EXTENSION PORT 1]** (PORT1) extends the reference plane for measurements of  $S_{11}$ ,  $S_{21}$ , and  $S_{12}$ .

**[EXTENSION PORT 2]** (PORT2) extends the reference plane for measurements of  $S_{22}$ ,  $S_{12}$ , and  $S_{21}$ .

**[RETURN]** goes back to the calibrate more menu.

## Calibration Menu

The calibration menu is used to select the appropriate accuracy enhancement procedure for calibration before a measurement is performed. Six different calibration routines are available, each of which effectively removes from one to twelve systematic errors from the measurement data. Each calibration procedure features CRT prompts to guide you through the calibration sequence. The available calibrations are described below, and a comparative summary is provided in Table 5-2. Procedures for performing each of the calibrations are provided in the following pages, together with illustrations of the corresponding menus.

Note that all instrument parameters should be established before a calibration procedure is started, including stimulus values, calibration kit, system characteristic impedance  $Z_0$ , and receiver sweep mode. (To modify the characteristic impedance and receiver sweep mode, refer to *Calibrate More Menu*.) If interpolated error correction is on, and you are in linear frequency sweep, power sweep, or CW time sweep, you may choose a subset of frequency range or a different number of points after the system has been calibrated. The performance of interpolated error correction is not specified.

**NOTE:** By convention, when the connector sex is provided in parentheses for a calibration standard, it refers to the sex of the test port connector, not the sex of the standard. For example, short (m) indicates that the test port connector is male, not the short circuit connector.

**NOTE:** The compatible type-N and 3.5 mm calibration kits for the HP 8753B provide open circuits with center conductor extenders. For maximum accuracy in calibration with these devices, follow these steps: First connect the outer conductor by hand and torque wrench. Then insert the center conductor extender into the outer conductor. The fit should be snug but free. Push gently until the center conductors mate.

For measurement of test devices following calibration, refer to the *User's Guide*.



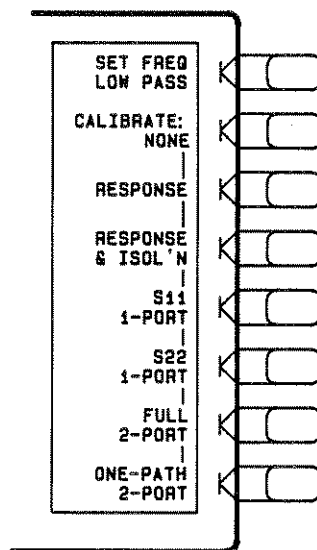

Figure 5-13. Calibration Menu

**[SET FREQ LOW PASS]** changes the frequency sweep to harmonic intervals to accommodate time domain low-pass operation (option 010). If this mode is to be used, the frequencies must be set before calibration. Refer to Chapter 8, *Time and Frequency Domain Transforms*, for more information.

**[CALIBRATE: NONE]** is underlined if no calibration has been performed or if the calibration data has been cleared. Unless a calibration is saved in memory, the calibration data is lost on instrument preset, power on, instrument state recall, or if stimulus values are changed.

**[RESPONSE]** (CALIRESP) leads to the frequency response calibration. This is the simplest and fastest accuracy enhancement procedure, but should be used when extreme accuracy is not required. It effectively removes the frequency response errors of the test setup for reflection or transmission measurements.

For transmission-only measurements or reflection-only measurements, only a single calibration standard is required with this procedure. The standard for transmission measurements is a thru, and for reflection measurements can be either an open or a short. If more than one device is measured, only the data for the last device is retained. The procedures for response calibration for a reflection measurement and a transmission measurement are described in the following pages.

**[RESPONSE & ISOL'N]** (CALIRAI) leads to the menus used to perform a response and isolation measurement calibration, for measurement of devices with wide dynamic range. This procedure effectively removes the same frequency response errors as the response calibration. In addition, it effectively removes the isolation (crosstalk) error in transmission measurements or the directivity error in reflection measurements. As well as the devices required for a simple response calibration, an isolation standard is required. The standard normally used to correct for isolation is an impedance-matched load (usually 50 or 75 ohms). Response and directivity calibration procedures for reflection and transmission measurements are provided in the following pages.

**[S11 1-PORT]** (CALIS111) provides a measurement calibration for reflection-only measurements of one-port devices or properly terminated two-port devices, at port 1 of an S-parameter test set or the test port of a transmission/reflection test set. This procedure effectively removes the directivity, source match, and frequency response errors of the test setup, and provides a higher level of measurement accuracy than the response and isolation calibration. It is the most accurate calibration procedure for reflection-only measurements. Three standard devices are required: a short, an open, and an impedance-matched load. The procedure for performing an  $S_{11}$  one-port calibration is described in the following pages.

**[S22 1-PORT]** (CALIS221) is similar to **[S11 1-PORT]**. It is used for reflection-only measurements of one-port devices or properly terminated two-port devices in the reverse direction: that is, for devices connected to port 2 of the S-parameter test set.

**[FULL 2-PORT]** (CALIFUL2) leads to the series of menus used to perform a complete calibration for measurement of all four S-parameters of a two-port device. This is the most accurate calibration for measurements of two-port devices. It effectively removes all correctable systematic errors (directivity, source match, load match, isolation, reflection tracking, and transmission tracking) in both the forward and the reverse direction. Isolation correction can be omitted for measurements of devices with limited dynamic range.

The standards for this procedure are a short, an open, a thru, and an impedance-matched load (two loads if isolation correction is required). An S-parameter test set is required. The procedure is described in the following pages.

**[ONE-PATH 2-PORT]** (CALIONE2) leads to the series of menus used to perform a high-accuracy two-port calibration without an S-parameter test set. This calibration procedure effectively removes directivity, source match, load match, isolation, reflection tracking, and transmission tracking errors in one direction only. Isolation correction can be omitted for measurements of devices with limited dynamic range. (The device under test must be manually reversed between sweeps to accomplish measurement of both input and output responses.) The required standards are a short, an open, a thru, and an impedance-matched load. The procedure for performing a one-path 2-port calibration is described in the following pages.

Table 5-2. Purpose and Use of Different Calibration Procedures

| Calibration Procedure | Corresponding Measurement                                                                                                               | Errors Removed                                                                            | Standard Devices                                         |
|-----------------------|-----------------------------------------------------------------------------------------------------------------------------------------|-------------------------------------------------------------------------------------------|----------------------------------------------------------|
| Response              | Transmission or reflection measurement when the highest accuracy is not required.                                                       | Freq. response                                                                            | Thru for trans., open OR short for reflection            |
| Response & isolation  | Transmission of high insertion loss devices or reflection of high return loss devices. Not as accurate as 1-port or 2-port calibration. | Freq. response PLUS isolation in transmission or directivity in reflection                | Same as response PLUS isolation std (load)               |
| $S_{11}$ 1-port       | Reflection of any one-port device or well terminated two-port device.                                                                   | Directivity, source match, freq. response.                                                | Short AND open AND load                                  |
| $S_{22}$ 1-port       | Reflection of any one-port device or well terminated two-port device.                                                                   | Directivity, source match, freq. response.                                                | Short AND open AND load                                  |
| Full 2-port           | Transmission or reflection of highest accuracy for two-port devices. HP 85046A/B or 85047A S-parameter test set is required.            | Directivity, source match, load match, isolation, freq. response, forward and reverse.    | Short AND open AND load AND thru (2 loads for isolation) |
| One-path 2-port       | Transmission or reflection of highest accuracy for two-port devices. (Reverse test device between forward and reverse measurements.)    | Directivity, source match, load match, isolation, freq. response, forward direction only. | Short AND open AND load AND thru                         |

## Response Calibration for Reflection Measurements

The procedure described here uses the menu illustrated in Figure 5-14 to perform a frequency response only calibration with an S-parameter test set for a measurement of  $S_{11}$ . It can also be used for  $S_{22}$  by substituting the corresponding softkey in the S-parameters menu.

A similar procedure can be performed with a transmission/reflection test set, using the input ports menu instead of the S-parameters menu (described in Chapter 4, *Response Function Block*).

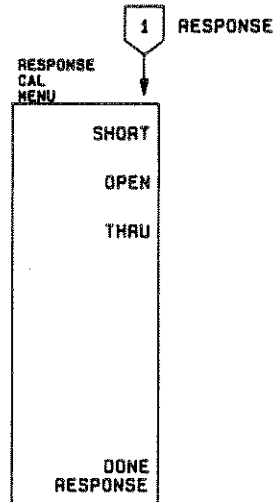

Figure 5-14

- Press **[MEAS]** [*Ref: FWD S11 A/R*].
- Press **[CAL]**.
- Select the proper calibration kit. If the connector type or cal kit name shown in the **[CAL KIT]** softkey label is not the same as the calibration kit to be used, refer to *Select Cal Kit Menu*.
- Press **[CALIBRATE MENU]** **[RESPONSE]**.
- At port 1, connect either a short OR a shielded open circuit.
- When the trace settles, press **[SHORT]** or **[OPEN]**, depending on the standard used. (If more than one device is measured, only the data for the last device is retained.)
- The message "WAIT - MEASURING CAL STANDARD" is displayed while the data is measured. The softkey label **[SHORT]** or **[OPEN]** is then underlined.
- Press **[DONE: RESPONSE]**. The error coefficients are computed and stored. The correction menu is displayed with **[CORRECTION ON]**. A corrected trace is displayed.
- This completes the response calibration for a reflection measurement. Now the test device can be connected and measured.

It is recommended that calibration data be saved, either in internal volatile memory or on an external disc. Refer to Chapter 10, *Saving Instrument States*.

## Response Calibration for Transmission Measurements

The procedure described here uses the menu in Figure 5-14 to perform a frequency response only calibration with an S-parameter test set for a measurement of  $S_{21}$ . To calibrate for a combined transmission and reflection measurement, perform the transmission calibration on one channel and the reflection calibration described above on the other channel.

A similar procedure can be performed with a transmission/reflection test set, using the input ports menu instead of the S-parameters menu (see Chapter 4, *Response Function Block*).

- Press [MEAS] [Trans: FWD  $S_{21}$  B/R].
- Press [CAL].
- Select the proper calibration kit. If the connector type or cal kit name shown in the [CAL KIT] softkey label is not the same as the calibration kit to be used, refer to *Select Cal Kit Menu*.
- Press [CALIBRATE MENU] [RESPONSE].
- Make a thru connection (connect together the points at which the test device will be connected).
- When the trace settles, press [THRU].
- The message "WAIT - MEASURING CAL STANDARD" is displayed while the  $S_{21}$  data is measured. The softkey label [THRU] is then underlined.
- Press [DONE: RESPONSE]. The error coefficients are computed and stored. The correction menu is displayed with [CORRECTION ON]. Corrected  $S_{21}$  data is displayed.
- This completes the response calibration for a transmission measurement. Now the test device can be connected and measured.

It is recommended that calibration data be saved, either in internal volatile memory or on an external disc. Refer to Chapter 10, *Saving Instrument States*.

## Response and Isolation Calibration for Reflection Measurements

The procedure described here effectively removes the frequency response and directivity errors for reflection measurements. The menus illustrated in Figure 5-15 are used to perform a calibration with an S-parameter test set for a measurement of  $S_{11}$ . The same calibration can be used for  $S_{22}$  by substituting the corresponding softkey in the S-parameters menu.

A similar procedure can be performed with a transmission/reflection test set, using the input ports menu instead of the S-parameters menu (described in Chapter 4, *Response Function Block*).

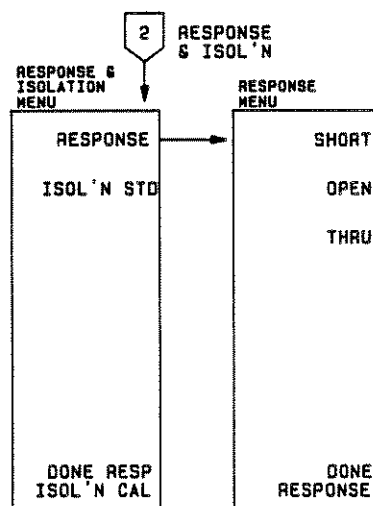

Figure 5-15

- Press **[MEAS]** [*Refl: FWD S11 A/R*].
- Press **[CAL]**.
- Select the proper calibration kit. If the connector type or cal kit name shown in the **[CAL KIT]** softkey label is not the same as the calibration kit to be used, refer to *Select Cal Kit Menu*.
- Press **[CALIBRATE MENU]** **[RESPONSE & ISOL'N]** **[RESPONSE]**.
- At port 1, connect either a short OR a shielded open circuit.
- When the trace settles, press **[SHORT]** or **[OPEN]**, depending on the standard used. (If more than one standard is measured, only the data for the last device is retained.)
- The message "WAIT – MEASURING CAL STANDARD" is displayed while the response data is measured. The softkey label **[SHORT]** or **[OPEN]** is then underlined.
- Press **[DONE: RESPONSE]**. The error coefficients are computed and stored. The response and isolation menu is displayed.
- Connect the isolation standard to port 1. This is an impedance-matched load (usually 50 or 75 ohms).
- Press **[ISOL'N STD]**. The  $S_{11}$  isolation data is measured. The softkey label is underlined.
- Press **[DONE RESP ISOL'N CAL]**. The directivity error coefficients are computed and stored. The correction menu is displayed with **[CORRECTION ON]**. A corrected trace is displayed.
- This completes the response and isolation calibration for correction of frequency response and directivity errors for reflection measurements. Now the test device can be connected and measured.

It is recommended that calibration data be saved, either in internal volatile memory or on an external disc. Refer to Chapter 10, *Saving Instrument States*.

## Response and Isolation Calibration for Transmission Measurements

The procedure described here effectively removes the frequency response and isolation errors for transmission measurements of devices with wide dynamic range, using the menus illustrated in Figure 5-15. To calibrate for a combined transmission and reflection measurement, perform the transmission calibration on one channel and the reflection calibration described above on the other channel.

This procedure uses an S-parameter test set. A similar procedure can be performed with a transmission/reflection test set, using the input ports menu instead of the S-parameters menu (see Chapter 4, *Response Function Block*).

- Press **[MEAS]** [*Trans: FWD S21 B/R*].
- Press **[CAL]**.
- Select the proper calibration kit. If the connector type or cal kit name shown in the **[CAL KIT]** softkey label is not the same as the calibration kit to be used, refer to *Select Cal Kit Menu*.
- Press **[CALIBRATE MENU]** **[RESPONSE & ISOL'N]** **[RESPONSE]**.
- Make a thru connection between port 1 and port 2 (connect together the points at which the test device will be connected).
- When the trace has settled, press **[THRU]**.  $S_{21}$  response data is measured. The softkey label **[THRU]** is underlined.
- Press **[DONE: RESPONSE]**.
- Connect impedance-matched loads to port 1 and port 2. Press **[ISOL'N STD]**. The  $S_{21}$  isolation data is measured. The softkey label is underlined.
- Press **[DONE RESP ISOL'N CAL]**. The  $S_{21}$  error coefficients are computed and stored. The correction menu is displayed with **[CORRECTION ON]**. Corrected  $S_{21}$  data is displayed and the notation "Cor" at the left of the screen indicates that correction is on for this channel.

A similar procedure is used to calibrate for measurement of  $S_{12}$ , using the **[Trans: REV S12 B/R]** softkey in the S-parameters menu.

It is recommended that calibration data be saved, either in internal volatile memory or on an external disc. Refer to Chapter 10, *Saving Instrument States*.

### **$S_{11}$ 1-Port Calibration for Reflection Measurements**

This procedure uses the  $S_{11}$  1-port menu illustrated in Figure 5-16 to perform a complete vector error correction for reflection measurements of one-port devices or properly terminated two-port devices. This is a high-accuracy calibration that effectively removes the directivity, source match, and frequency response errors from the measured data. The calibration described here uses an S-parameter test set: a similar procedure can be performed with a transmission/reflection test set, using the input ports menu instead of the S-parameters menu (described in Chapter 4, *Response Function Block*).

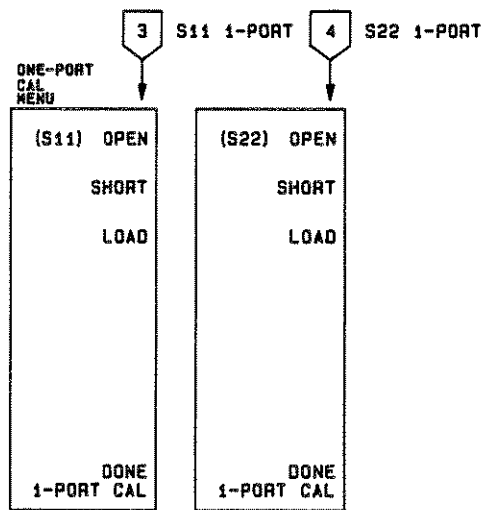

Figure 5-16

- Press **[CAL]**.
- Select the proper calibration kit. If the connector type or cal kit name shown in the **[CAL KIT]** softkey label is not the same as the calibration kit to be used, refer to *Select Cal Kit Menu*.
- Press **[CALIBRATE MENU] [S11 1-PORT]**.
- Connect a shielded open circuit to port 1.
- When the trace settles, press **(S<sub>11</sub>) [OPEN]**.
- The message "WAIT – MEASURING CAL STANDARD" is displayed while the open circuit data is measured. The softkey label **[OPEN]** is then underlined.
- Disconnect the open, and connect a short circuit to port 1.
- When the trace settles, press **[SHORT]**. The short circuit data is measured and the softkey label is underlined.
- Disconnect the short, and connect an impedance-matched load (usually 50 or 75 ohms) at port 1.
- When the trace settles, press **[LOAD]**. The load data is measured and the softkey label is underlined.
- Press **[DONE 1-PORT CAL]**. (If you press **[DONE]** without measuring all the required standards, the message "CAUTION: ADDITIONAL STANDARDS NEEDED" will be displayed.) The error coefficients are computed, and the correction menu is returned to the screen with **[CORRECTION ON]**. A corrected  $S_{11}$  trace is displayed, and the notation "Cor" appears at the left side of the screen.
- This completes the  $S_{11}$  1-port calibration. The test device can now be connected and measured.

It is recommended that calibration data be saved, either in internal volatile memory or on an external disc. Refer to Chapter 10, *Saving Instrument States*.

### S<sub>22</sub> 1-Port Calibration

This procedure performs a complete vector error correction for a reverse reflection measurement of a one-port device or a properly terminated two-port device. It is similar to the S<sub>11</sub> 1-port calibration except that S<sub>22</sub> is selected automatically.

This calibration is used only with an S-parameter test set. For S-parameter measurements in the reverse direction with a transmission/reflection test set use the S<sub>11</sub> 1-port or one-path 2-port calibration and reverse the device under test between measurement sweeps.

### Full 2-Port Calibration for Reflection and Transmission Measurements

This procedure uses the menu sequence illustrated in Figure 5-17 to perform complete vector error correction for measurement of all four S-parameters. This is the most accurate calibration for measurements of two-port devices, and effectively removes all correctable systematic errors in both the forward and reverse directions.

An S-parameter test set is required for this calibration. The procedure automatically switches the test set to select the appropriate S-parameter at each step. A similar two-port procedure can be performed with a transmission/reflection test set using the one-path 2-port calibration.

To extend the life of the mechanical transfer switch in the HP 85046A/B or 85047A S-parameter test sets, switching occurs only once in a measurement sequence using full two-port error correction. On the first sweep all four S-parameters are measured. On subsequent sweeps, the assumption is made that the reverse parameters have not changed, and only the forward parameters are measured. It is possible to override this protection feature for applications where extreme accuracy is required or in cases where the data changes significantly. To perform an override, use **[MEASURE RESTART]** in the stimulus menu, or for repeated update of all four S-parameters set an appropriate number of groups using the **[NUMBER OF GROUPS]** softkey. These menus are described in Chapter 3.

Isolation calibration can be omitted for most measurements, except where wide dynamic range is a consideration. Refer to the explanation under **[CAL] Key**.

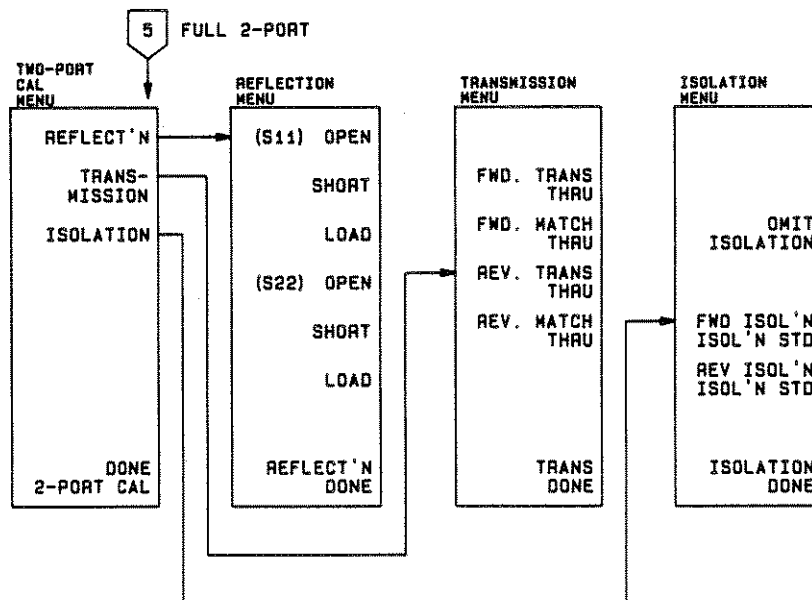

Figure 5-17

- Press **[CAL]**.
- Select the proper calibration kit. If the connector type or cal kit name shown in the **[CAL KIT]** softkey label is not the same as the calibration kit to be used, refer to *Select Cal Kit Menu*.
- Press **[CALIBRATE MENU] [FULL 2-PORT] [REFLECT'N]**.
- Connect a shielded open circuit to port 1.
- When the trace settles, press ( $S_{11}$ ) **[OPEN]**. The open circuit data is measured, and the softkey label **[OPEN]** is underlined.
- Disconnect the open, and connect a short circuit to port 1.
- When the trace settles, press ( $S_{11}$ ) **[SHORT]**. The short circuit data is measured and the softkey label **[SHORT]** is underlined.
- Disconnect the short, and connect an impedance-matched load (usually 50 or 75 ohms) at port 1.
- When the trace settles, press ( $S_{11}$ ) **[LOAD]**. The load data is measured, and the softkey label **[LOAD]** is underlined.
- Repeat the open-short-load measurements described above, connecting the devices in turn to port 2 and using the ( $S_{22}$ ) softkeys.
- Press **[REFLECT'N DONE]**. (If you press **[DONE]** without measuring all the required standards, the message "CAUTION: ADDITIONAL STANDARDS NEEDED" will be displayed.)
- The reflection calibration coefficients are computed and stored. The two-port cal menu is displayed, with the **[REFLECT'N]** softkey underlined.
- Press **[TRANSMISSION]**.
- Make a thru connection between port 1 and port 2 (connect together the points at which the test device will be connected).
- When the trace settles, press **[FWD. TRANS. THRU]**.  $S_{21}$  frequency response is measured, and the softkey is underlined.
- Press **[FWD. MATCH THRU]**.  $S_{11}$  load match is measured, and the softkey is underlined.
- Press **[REV. TRANS. THRU]**.  $S_{12}$  frequency response is measured, and the softkey is underlined.
- Press **[REV. MATCH THRU]**.  $S_{22}$  load match is measured, and the softkey is underlined.
- Press **[TRANS. DONE]**. The transmission coefficients are computed and stored. The two-port cal menu is displayed, with the **[TRANSMISSION]** softkey underlined.
- If correction for isolation is not required, press **[ISOLATION] [OMIT ISOLATION] [ISOLATION DONE]**.
- If correction for isolation is required, connect impedance-matched loads to port 1 and port 2.
- Press **[FWD ISOL'N ISOL'N STD]**.  $S_{21}$  isolation is measured, and the softkey label is underlined.
- Press **[REV ISOL'N ISOL'N STD]**.  $S_{12}$  isolation is measured, and the softkey label is underlined.
- Press **[ISOLATION DONE]**. The isolation error coefficients are stored. The two-port cal menu is displayed, with the **[ISOLATION]** softkey underlined.
- Press **[DONE 2-PORT CAL]**. The error coefficients are computed and stored. The correction menu is displayed with **[CORRECTION ON]**. A corrected trace is displayed, and the notation "C2" at the left of the screen indicates that two-port error correction is on.
- This completes the full two-port calibration procedure. Now the test device can be connected and measured.

It is recommended that calibration data be saved, either in internal volatile memory or on an external disc. Refer to Chapter 10, *Saving Instrument States*.



## One-Path 2-Port Calibration for Reflection and Transmission Measurements

This procedure performs a two-port calibration without an S-parameter test set, using the series of menus illustrated in Figure 5-18. This is a highly accurate calibration for measurements of two-port devices, and effectively removes all correctable systematic errors in one direction only.

Isolation calibration can be omitted for most measurements, except where wide dynamic range is a consideration. Refer to the explanation under *[CAL] Key*.

For measurements of all four S-parameters, the device under test must be reversed between sweeps. The HP 8753B compatible calibration kits contain sets of phase-matched adapters that can be interchanged for measurements of non-insertable, non-reversible devices.

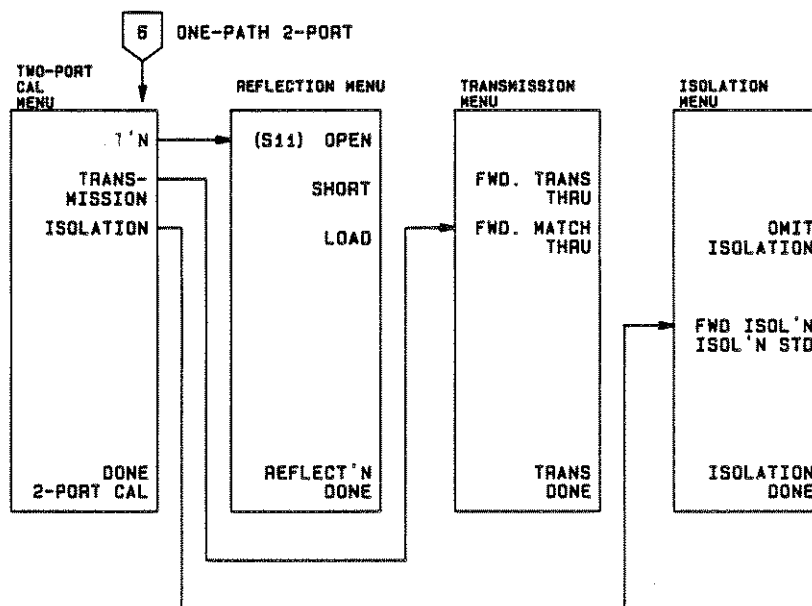

Figure 5-18

- Press **[CAL]**.
- Select the proper calibration kit. If the connector type or cal kit name shown in the **[CAL KIT]** softkey label is not the same as the calibration kit to be used, refer to *Select Cal Kit Menu*.
- Press **[CALIBRATE MENU] [ONE-PATH 2-PORT] [REFLECT'N]**.
- Connect a shielded open circuit to the test port.
- When the trace settles, press  $(S_{11})$  **[OPEN]**. The open circuit data is measured, and the softkey label **[OPEN]** is underlined.
- Disconnect the open, and connect a short circuit to the test port.
- When the trace settles, press **[SHORT]**. The short circuit data is measured and the softkey label **[SHORT]** is underlined.
- Disconnect the short, and connect an impedance-matched load (50 or 75 ohms) to the test port.
- When the trace settles, press **[LOAD]**. The load data is measured, and the softkey label **[LOAD]** is underlined.
- Press **[REFLECT'N DONE]**. (If you press **[DONE]** without measuring all the required standards, the message "CAUTION: ADDITIONAL STANDARDS NEEDED" will be displayed.)

- The reflection calibration coefficients are computed and stored. The two-port cal menu is displayed, with the **[REFLECT'N]** softkey underlined.
- Make a thru connection between the test port and the return cable to the network analyzer (connect together the points at which the test device will be connected). Press **[TRANSMISSION]**.
- When the trace settles, press **[FWD. TRANS. THRU]**.  $S_{21}$  frequency response is measured, and the softkey is underlined.
- Press **[FWD. MATCH THRU]**.  $S_{11}$  load match is measured, and the softkey is underlined.
- Press **[TRANS. DONE]**. The transmission coefficients are computed and stored. The two-port cal menu is displayed, with the **[TRANSMISSION]** softkey underlined.
- If correction for isolation is not required, press **[ISOLATION] [OMIT ISOLATION] [ISOLATION DONE]**.
- If correction for isolation is required, connect impedance-matched loads to the test port and the return port.
- Press **[FWD ISOL'N ISOL'N STD]**.  $S_{21}$  isolation is measured, and the softkey label is underlined.
- Press **[ISOLATION DONE]**. The isolation error coefficients are stored. The two-port cal menu is displayed, with the **[ISOLATION]** softkey underlined.
- Press **[DONE 2-PORT CAL]**. The error coefficients are computed and stored. The correction menu is displayed with **[CORRECTION ON]**. A corrected trace is displayed, and the notation "C2" at the left of the screen indicates that 2-port error correction is on.
- This completes the one-path 2-port calibration procedure. Now the test device can be connected and measured in the forward direction. When forward measurement is complete, disconnect the test device and manually reverse it, then press the softkey **[PRESS to CONTINUE]**, or trigger another sweep using the trigger menu (Chapter 3).

It is recommended that calibration data be saved, either in internal volatile memory or on an external disc. Refer to Chapter 10, *Saving Instrument States*.

## POWER METER CALIBRATION

An HP-IB compatible power meter can monitor and correct RF source power to achieve leveled power at the test port. To correct the power going to the DUT, power meter calibration samples the power at each measurement point across the frequency band of interest. It then constructs a correction data table which the instrument uses to correct the power output of the internal source. The correction table may be saved in an instrument state register with the **[SAVE]** key.

The correction table may be updated on each sweep (in a leveling application) or during an initial single sweep. In the sample-and-sweep mode the power meter is not needed for subsequent sweeps. The correction table may be read or modified through HP-IB. Refer to the *HP-IB Quick Reference Guide* for details.

**NOTE:** Instructions for using power meter calibration are provided later in this chapter. Refer to the chapter table of contents for the page number.

### Primary Applications

- When using a test system with significant frequency response errors. For example, if using a coupler with significant roll-off, or a long cable with a significant amount of loss.
- When measuring devices that are very sensitive to actual input power for proper operation.

- To allow measurements where power meter accuracy is required to meet a specification.

## Calibrated Power Level

By setting the HP 8753B calibrated power to the desired value at the power meter, this power level will be maintained at that port during the entire sweep. It is recommended that the operator first set the source power such that the power at the DUT is approximately correct. This reduces residual power errors when only one number of readings is taken (see [NUMBER OF READINGS] softkey description). When power meter calibration is on, the annotation "PC" is displayed. This indicates that the source power is being changed during the sweep. Calibrated power level becomes the active entry if any of the following softkeys are pressed:

[PWRMTR CAL OFF]    [EACH SWEEP]    [ONE SWEEP]

Regardless of the measurement application, the HP 8753B source can only supply power from +20 to -5 dBm. If power outside this range is requested, the annotation will change to "PC?".

## Compatible Sweep Types

Power meter calibration may be used in linear, log, list, CW, and power sweep modes. In power sweep, the power at each point is the true power at the power meter, not the power at the HP 8753B source output.

## Loss of Power Meter Calibration Data

**Turning Power Off.** Turning off the instrument erases the power meter calibration table and all instrument save/recall registers.

**Changing Sweep Type When Power Meter Calibration is Turned On.** If the sweep type is changed (linear, log, list, CW, power) while power meter calibration is on, the calibration data will be lost. However, calibration data is retained if you change the sweep type while power meter calibration is off.

**Frequency is Changed in Log or List Sweep Type.** Power meter calibration data will also be lost if the frequency is changed in log or list mode, but it is retained in linear sweep mode.

**Pressing [PRESET] if the Table Has Not Been Saved in an Instrument State Register.** Presetting the instrument will erase power meter calibration data. If the instrument state has been saved in a register using the [SAVE] key, the user may recall the instrument state and the data will be restored. Saving the instrument state will not protect the data if the instrument is turned off.

## Interpolation Feature in Power Meter Calibration

If the frequency is changed in linear sweep, or the start/stop power is changed in power sweep, then the calibration data is interpolated for the new range.

If calibration power is changed in any of the sweep types, the data array is increased or decreased to reflect the new power level. Some accuracy is lost when this occurs.

## Power Meter Calibration Use Above 3 GHz

When an HP 85047A 6 GHz test set is used with an HP 8753B option 006, a doubler in the test set provides 3 MHz to 6 GHz frequency range. This doubler mode requires a constant, high input power to work properly. In the 6 GHz mode, the default power output of the internal source is +20 dBm. The test set is designed to operate with this input level in the 3 MHz to 6 GHz range. If power meter calibration forces the power level to change more than a few dB, the performance of the RF signal may degrade. Refer to Chapter 14.

## THE TWO MODES OF OPERATION IN POWER METER CALIBRATION

### Continuous Correction [EACH SWEEP]

Refer to Figure 5-19. A power splitter or directional coupler samples the actual power going to the DUT and is measured by the power meter. This sampling occurs once at each measurement point. The operator may ask for more than one sample/correction iteration at each frequency point. This is explained in the [NUMBER OF READINGS] softkey description. Continuous correction slows the sweep speed considerably, especially when low power levels are being measured by the power meter. It may take up to 10 seconds per point if the power level is less than -20 dBm. For faster operation, the sample-and-sweep mode may be used. If a directional coupler is used, the attenuation of the coupled arm with respect to the through arm must be entered using the [POWER LOSS] softkey.

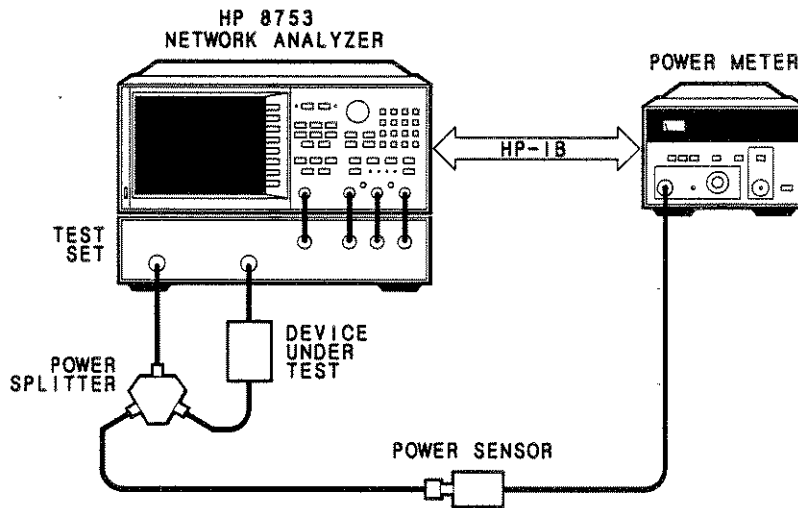

Figure 5-19. Typical Test Setup for Continuous Correction

## Sample-and-Sweep Correction [ONE SWEEP]

Refer to Figure 5-20. You may use a power splitter or directional coupler, or simply remove the DUT and measure the power at that point in the measurement setup. The sample-and-sweep mode allows you to measure the power characteristics across the frequency band of interest with a single sweep. The speed of the calibration will be slow while power meter readings are taken (see the *Typical Speed and Accuracy* table shown on a following page). However, once the sample sweep is finished, subsequent sweeps are power-corrected using the data table, and sweep speed increases significantly. Once the initial sweep is taken, sample-and-sweep correction is much faster than continuous sweep correction.

If the calibrated power level is changed after the initial measurement sweep is done, the entire correction table is increased or decreased by that amount and the annotation "PCo" appears on the CRT. The resulting power will no longer be as accurate as the original calibration.

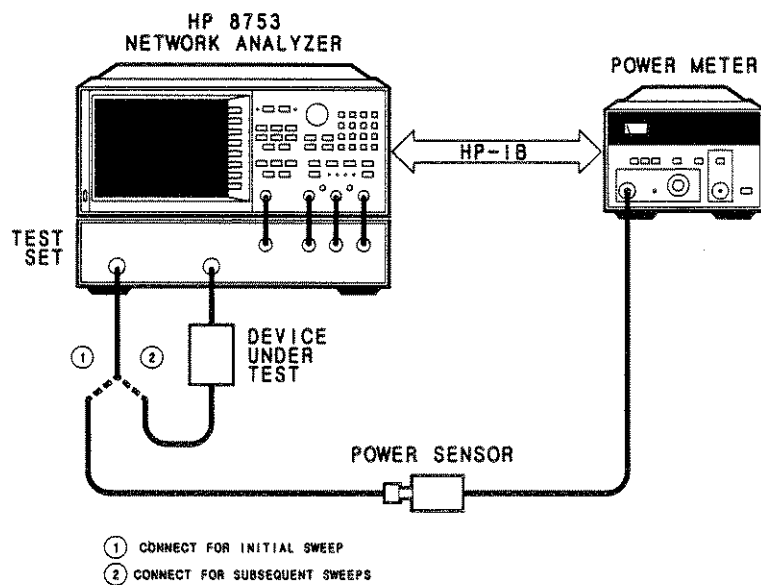

Figure 5-20. Typical Test Setup for Sample-and-Sweep Correction

### Other Details

**Power Meter HP-IB Address.** Before using power meter calibration, you must select the power meter address using the [LOCAL] [SET ADDRESSES] keys and address menu. Then select the type of power meter in use with the [P MTR/HPIB] softkey.

**System Controller Mode.** The HP 8753B must be set to the system controller mode using the [LOCAL] [SYSTEM CONTROLLER] keys.

**Power Loss Correction List.** If a directional coupler or power splitter is used to sample the RF power output of the HP 8753B, the RF signal going to the power meter may be different than that going to the DUT. A directional coupler will attenuate by its specified coupling factor. The difference in attenuation between the through arm and the coupled arm (coupling factor) must be entered using the loss/sensor list menu. Non-linearities in either the directional coupler or power splitter may be corrected in the same way.

Power loss information is entered in much the same way as limit line parameters. Up to 12 segments may be entered, each with a different attenuation value.

**Power Sensor Calibration Factor List.** Two power sensor calibration data lists can be created in the HP 8753B. The second list is primarily for use with an HP 8753B option 006 (6 GHz) system. Since no single power sensor covers the entire frequency range of 300 kHz to 6 GHz, the calibration data for two different power sensors must be available. Refer to the loss/sensor list menu explained later in this chapter.

### **Typical Speed and Accuracy of Power Meter Calibration**

The speed and accuracy of a power meter calibration vary depending on the test setup and the measurement parameters. When the number of readings = 1, accuracy is improved if the operator sets the source power such that it is approximately correct at the measurement port. Power meter calibration should then be turned on.

Table 5-3 shows typical sweep speed and power accuracy. The times given apply only to the test setup described, for continuous calibration or for the first sweep of sample-and-sweep correction. Subsequent sweeps in the sample-and-sweep mode will be much faster than the values shown in Table 5-3. Several power levels and numbers of readings are shown.

The typical values given in the table were derived under the following conditions:

**Test Setup:** The test setup used the following instruments:

- Instrument/Test Set: HP 8753B with HP 85046A.
- Power Meter/Power Sensor: HP 436A with HP 8482A.

**Stimulus Parameters:** The time required to perform a power meter calibration is greatly affected by the source power and number of points tested. The parameters used to derive the typical values in Table 5-3 are as follows:

- Number of Points: 51
- Source Power: +10 dBm
- Attenuator Port 1: 0 dB

Sweep time is linearly proportional to the number of points measured. For example, a sweep taking 33 seconds at 51 points will take approximately 66 seconds if 101 points are measured.

Table 5-3. Typical Speed and Accuracy

| Power Desired at Test Port (dBm) | Number of Readings | Sweep Time (seconds) <sup>1</sup> | Typical Accuracy (dB) |
|----------------------------------|--------------------|-----------------------------------|-----------------------|
| +5                               | 1                  | 33                                | ±0.7                  |
|                                  | 2                  | 64                                | ±0.2                  |
|                                  | 3                  | 95                                | ±0.1                  |
| -15                              | 1                  | 48                                | ±0.7                  |
|                                  | 2                  | 92                                | ±0.2                  |
|                                  | 3                  | 123                               | ±0.1                  |
| -30 <sup>2</sup>                 | 1                  | 194                               | ±0.7                  |
|                                  | 2                  | 360                               | ±0.2                  |
|                                  | 3                  | 447                               | ±0.1                  |

1 Sweep speed applies to every sweep in continuous correction mode, and to the first sweep in sample-and-sweep mode. Subsequent sweeps in sample-and-sweep mode will be much faster.

2 The port 1 attenuator was set at 20 dB, allowing the HP 8753B source to deliver -30 dBm at the test port.

**Notes on Accuracy.** The accuracy values in Table 5-3 were derived by combining the accuracy of the power meter and linearity of the HP 8753B internal source, as well as the mismatch uncertainty associated with the test set and the power sensor.

Power meter calibration measures the source power output (at the measurement port) at a single stimulus point, and compares it to the calibrated power selected by the operator. If the two values are different, power meter calibration changes the source output power by the difference. This process is repeated at every stimulus point. The accuracy of the result depends on the amount of correction required. If the selected number of readings = 1, the final measurement accuracy is significantly affected by a large power change. However, if the selected number of readings is >1, the power change on the second or third reading is much smaller: thus accuracy is much better.

Two methods can be used to perform power meter calibration. If the selected number of readings is >1, then it makes little difference which method is used. However, if number of readings = 1, then the first method provides better accuracy. The values in Table 5-3 were derived using the second (worst case) method.

- **The operator sets source power such that it is approximately correct at the measurement port, then activates power meter calibration.** This method can significantly increase the accuracy of the measurement when the selected number of readings = 1. Smaller accuracy improvements occur with a higher number of readings. Remember that mismatch errors affect accuracy as well.
- **The operator activates power meter calibration without regard for the source's current power setting.** There may be a large difference between the current power level and the desired calibrated power level. Power meter calibration will automatically adjust the power at the measurement port to match the desired calibrated power level. However, a large change in power affects accuracy, especially if the number of readings = 1. The accuracy values given in Table 5-3 were calculated with an initial power setting of +10 dB. The power range of the HP 8753B source is +20 to -5 dBm, so the worst-case power correction is 25 dB.

## USING POWER METER CALIBRATION

To use power meter calibration you must perform the following steps:

### Before Turning Power Meter Calibration On

- Enter the HP-IB address of the power meter into the HP 8753B. Press **[LOCAL] [SET ADDRESSES] [P MTR/HPIB] [#] [#] [x1]**, where ## is the two digit HP-IB address currently in use by the power meter.
- Press **[POWER MTR: [43X] ]** until the softkey label shows the power meter in use. Currently three power meters are supported: HP 436A, 437B, and 438A.
- Set the HP 8753B to system controller mode. Press **[LOCAL] [SYSTEM CONTROLLER]**.
- Enter the power sensor calibration data. Press **[CAL] [PWR MTR [43X] ] [LOSS/SENSR LISTS] [CAL FACTOR SENSOR A]** and enter the power sensor calibration factors for each desired frequency segment. Details on the segment edit menus are provided later in this chapter.

If using an HP 8753B option 006 (6 GHz operation), enter the power meter calibration factors for the higher frequency power sensor. Select **[CAL FACTOR SENSOR B]** and enter the calibration factors for each desired segment.

- Press **[CAL] [PWR METER [43X] ]** to enter the main power meter calibration menu.

### Using the Power Loss Feature to Compensate for Power Splitter/ Directional Coupler Attenuation Non-Linearities

Power loss data can be entered at up to 12 segments. The correction values between segments are interpolated by the HP 8753B.

**Directional Couplers.** If a directional coupler is used, the power loss through the coupled arm should be entered for at least one frequency point with the **[POWER LOSS]** softkey. You can enter the loss information in a single segment, and the HP 8753B will assume that the value applies to the entire frequency range of the instrument. Or actual measured power loss values may be input at several frequencies using multiple segments, enhancing power accuracy.

**Power Splitters.** Power accuracy can be improved when using a power splitter to sample the RF output. Using the power loss feature, the user can compensate for tracking errors.

- Press **[LOSS/SENSR LISTS] [POWER LOSS]**. Enter the attenuation of the power splitter or directional coupler at as many frequency segments as needed, depending on the required accuracy. The power loss submenus are explained later in this chapter. When finished, press **[DONE]** to get back to the power loss menu and **[RETURN]** to get back to the power meter calibration menu.
- Press **[POWER LOSS on OFF]** to turn on power loss compensation.

### Using Continuous Sample Mode

The **[EACH SWEEP]** function continuously checks power at every point in each sweep. The power meter must remain connected as shown in Figure 5-19.

- Cal power becomes the active function. Enter the desired test port power level (the power level you wish to maintain at the input to the DUT).



- Use a power splitter or directional coupler to tap off RF power going to the DUT. Compensate for power loss if using a directional coupler.
- If you wish more than one power measurement at each frequency point in the stimulus range, press **[NUMBER OF READINGS] [n] [x1]**, where n = the number of desired iterations. (Note that this will substantially increase the power meter calibration time.)
- Press **[EACH SWEEP]** to turn on power meter calibration.

## Using Sample-and-Sweep Mode

When the **[ONE SWEEP]** softkey is pressed, the instrument corrects the output power using the power meter calibration data table. Pressing **[TAKE CAL SWEEP]** causes the initial measurement sweep to occur, which updates the data table. After that, remove the power meter sensor and connect the DUT. Subsequent sweeps will use the data table to correct the output power level at each point. A typical setup is shown in Figure 5-20.

- Cal power becomes the active function. Enter the desired test port power level (the power level you wish to maintain at the input to the DUT).
- Measure the power at the DUT input node directly.
- If you wish more than one power measurement at each frequency point in the stimulus range, press **[NUMBER OF READINGS] [#] [x1]**. (Note that this will substantially increase the power meter calibration time.)
- Press **[ONE SWEEP] [TAKE CAL SWEEP]**. The actual power at each frequency point will be measured with the initial sweep. During this sweep, sweep speed will slow significantly.
- Remove the power meter sensor and connect the DUT.

## Calibration Data Table

Valid calibration data will be in the power correction table if one of the following has occurred:

- Either **[TAKE CAL SWEEP]** or **[EACH SWEEP]** has been pressed.
- Calibration data has been placed in the table via HP-IB.

# Power Meter Calibration Menus

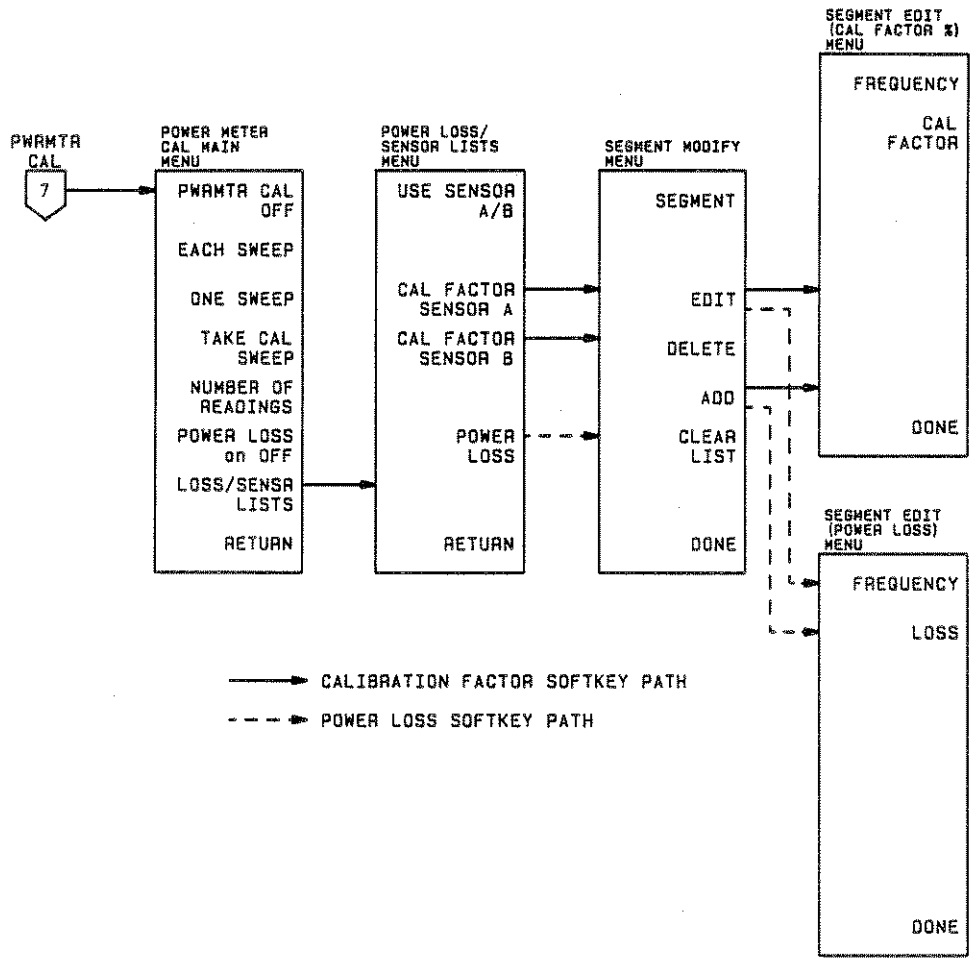

Figure 5-21. Relationship of the Menus Accessed with the [PWRMTR CAL] Softkey.

## Power Meter Calibration Main Menu

Refer to Figure 5-21.

**[PWRMTR CAL OFF]** (PVMCOFF) turns off power meter calibration.

**[EACH SWEEP]** (PVMCEACS). Power meter calibration occurs on each sweep. Each measurement point is measured by the power meter, which provides the HP 8753B with the actual power reading. The HP 8753B corrects the power level at that point. The number of measurement/correction iterations performed on each point is determined by the **[NUMBER OF READINGS]** softkey. This measurement mode sweeps slowly, especially when the measured power is small. Small power levels require more time for the power meter to settle. The power meter correction table in memory is updated after each sweep. This table can be read or changed via HP-IB.

**[ONE SWEEP]** (PVMCONES). This mode does not measure each sweep, but corrects each point with the data currently in the power meter correction table. The **[TAKE CAL SWEEP]** softkey may be used to measure the power level at each point during a single sweep, and place correction data in the table. If the **[EACH SWEEP]** function was used earlier, correction data already exists in the table.

As with the **[EACH SWEEP]** softkey, the number of measurement iterations at each point can be selected using the **[NUMBER OF READINGS]** softkey.

**[TAKE CAL SWEEP]** (TAKCS) Each data point is measured during the initial sweep and the correction data is placed in the power meter correction table. This provides data usable in the **[ONE SWEEP]** mode.

**[NUMBER OF READINGS]** (NUMR) determines the number of measurement/correction iterations performed on each point. This feature helps eliminate residual power errors after the initial correction. The amount of residual error is directly proportional to the magnitude of the initial correction. It is assumed that the user has initially set the source power so that it is approximately correct when it arrives at the DUT. If power uncertainty at the DUT is expected to be greater than a few dB, it is recommended that the number of readings be greater than 1.

**[PWR LOSS on OFF]** (PWRLOSSON, PWRLOSSOFF) turns on or off power loss correction. Power loss correction should be used when the power output is measured by a directional coupler. The power loss caused by the coupled arm should be entered by using the **[LOSS/SENSR LISTS]** softkey submenus described below.

**[LOSS/SENSR LISTS]** presents the power loss/sensor lists menu. This menu performs two functions:

- Corrects coupled-arm power loss when a directional coupler is used to sample the RF output.
- Allows calibration factor data to be entered for one or two power sensors.

Each function provides up to 12 separate frequency points, called segments, at which the user may enter a different power loss or calibration factor. The instrument interpolates between the selected points. Two power sensor lists are provided because no single power sensor can cover the frequency range possible with an HP 8753B option 006 (6 GHz operation)/ HP 85047A test set system.

**[RETURN]** goes back to the main calibration menu.

## Power Loss/Sensor Lists Menu

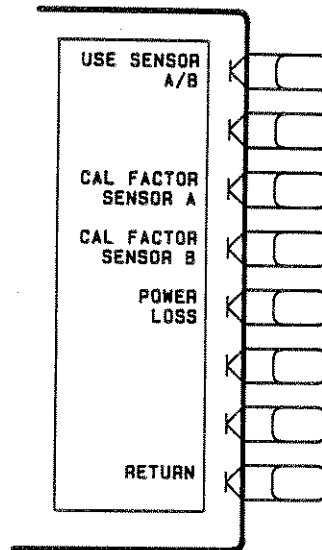

Figure 5-22. Power Loss/Sensor List Menu

**[USE SENSOR A / B]** (USESENSA, USESENSB) selects the A or B power sensor calibration factor list for use in power meter calibration measurements.

**[CAL FACTOR SENSOR A]** (CALFSENA) brings up the segment modify menu and segment edit (calibration factor %) menu explained on the following pages. The calibration factor data entered in this menu will be stored for power sensor A.

**[CAL FACTOR SENSOR B]** (CALFSENB) brings up the segment modify menu and segment edit (calibration factor %) menu explained on the following pages. The calibration factor data entered in this menu will be stored for power sensor B.

**[POWER LOSS]** (POWLLIST) brings up the segment modify menu and segment edit (power loss) menu explained in the following pages. This softkey is intended for use when the power output is being sampled by a directional coupler or power splitter. In the case of the directional coupler, enter the power loss caused by the coupled arm. Refer to *Power Loss Feature* on a previous page.

This feature may be used to compensate for attenuation non-linearities in either a directional coupler or a power splitter. Up to 12 segments may be entered, each with a different frequency and power loss value.

## Segment Modify Menu

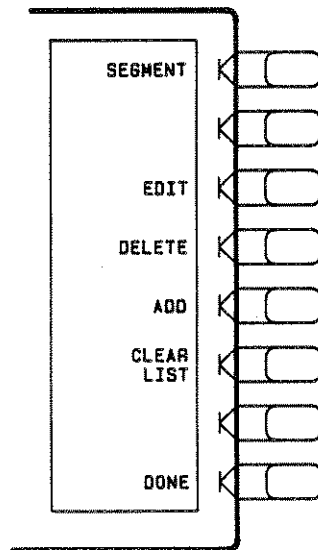

Figure 5-23. Segment Modify Menu

This menu performs two tasks:

- It allows the user to enter power sensor calibration data for one or two power sensors.
- It enters power loss data (refer to the **[POWER LOSS]** softkey description, above).

For either power loss or power sensor calibration data, the user may select from one to 12 frequency segments. Multiple segments do not have to be entered in any particular order; the HP 8753B automatically sorts them and lists them on the CRT in increasing order of frequency.

You may wish to use only one segment. In this case, the instrument assumes that the single value is valid over the entire frequency range of the calibration.

For high accuracy, actual measured power loss and/or power sensor calibration data may be entered for as many as 12 separate frequency points (segments). The frequencies between the points are interpolated by the instrument.

**Instructions for Using the Segment Modify Menu.** Before any segment information is entered in the list, the word "EMPTY" is displayed on the CRT. You can create the first segment by pressing either **[EDIT]** or **[ADD]**. Enter the desired frequency and cal factor/power loss data when the appropriate segment edit menu appears.

Example, in the segment edit (power loss) menu, press: **[FREQUENCY] [1] [G/n] [LOSS] [6] [x1]** to add a segment to the power loss list. Now press **[DONE]**.

Once an entry has been made, use the **[ADD]** softkey to enter additional segments. The default segment number when **[ADD]** is pressed is the next consecutive whole number above the last segment number. Follow the above instructions to define the next segment in the list.

To delete an entry in the list, press **[SEGMENT]** and use the entry block controls to select the desired segment. Press **[DELETE]**.

To erase all entries, press the **[CLEAR LIST]** softkey.

**[SEGMENT]** specifies which segment in the list is to be modified. A maximum of two segments is displayed at one time, and the list can be scrolled up or down to show other segment entries. Use the entry block controls to move the pointer > to the desired segment number. The selected segment can now be edited or deleted.

**[EDIT]** (SEDIn, where "n" is the segment number). This softkey brings up the appropriate segment edit menu described in the following pages. The edit command modifies the segment previously selected with the **[SEGMENT]** softkey.

**[DELETE]** (SDEL) Deletes the segment previously selected with the **[SEGMENT]** softkey.

**[ADD]** (SADD) adds another segment to the bottom of the list and presents the appropriate segment edit menu described in the following pages.

**[CLEAR LIST]** (CLEL) deletes all segments in the list.

**[DONE]** (EDITDONE) goes back to the power loss/sensor list menu.

### Segment Edit (Calibration Factor %) Menu

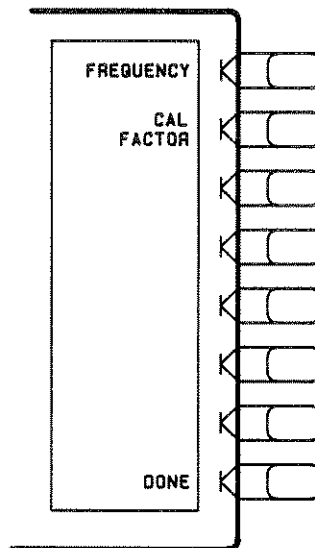

Figure 5-24. Segment Edit (Calibration Factor %) Menu

This menu defines the frequency and calibration factor % for the segment being added or edited.

**[FREQUENCY]** (CALFFREQ) accepts a frequency value for the segment.

**[CAL FACTOR]** (CALFCALF) accepts a calibration factor % for the segment.

**[DONE]** (SDON) goes back to the segment modify menu and sorts the list according to increasing frequency.

### Segment Edit (Power Loss) Menu

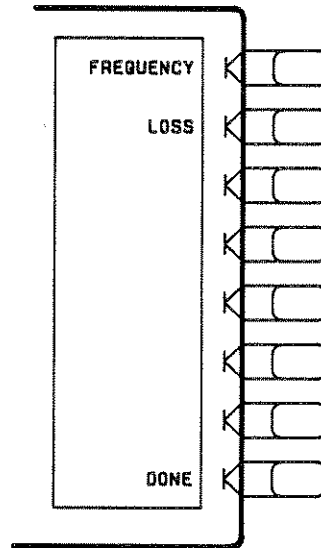

Figure 5-25. Segment Edit (Power Loss) Menu

This menu defines the frequency and power loss for the segment being added or edited.

**[FREQUENCY]** (POWLFFREQ) accepts a frequency value for the segment.

**[LOSS]** (POWLLOSS) accepts a power loss value for the segment. This value, for example, could be the difference (in dB) between the coupled arm and through arm of a directional coupler.

**[DONE]** (SDON) goes back to the segment modify menu and sorts the list according to increasing frequency.

### MODIFYING CALIBRATION KITS

**NOTE:** Hewlett-Packard strongly recommends that you read application note 8510-5A before attempting to view or modify calibration standard definitions. The part number of this application note is 5956-4352. Although the application note is written for the HP 8510 family of network analyzers, it also applies to the HP 8753B. This portion of the calibration chapter provides a summary of the information in the application note, as well as HP 8753B menu-specific information.

For most applications, use the default cal kit models provided in the select cal kit menu described earlier in this chapter. Modifying calibration kits is necessary only if unusual standards are used or the very highest accuracy is required. Unless a cal kit model is provided with the calibration devices used, a solid understanding of error correction and the system error model are absolutely essential to making modifications. Read the introductory part of this chapter for more information, and refer to the Appendix to Chapter 5 and to *System Performance* in the *General Information and Specifications* section.

**NOTE:** Numerical data for most Hewlett-Packard calibration kits is provided in the calibration kit manuals.

During measurement calibration, the HP 8753B measures actual, well-defined standards and mathematically compares the results with ideal "models" of those standards. The differences are separated into error terms which are later removed during error correction. Most of the differences are due to systematic errors – repeatable errors introduced by the network analyzer, test set, and cables – which are correctable. However, differences between the model for a standard and the actual performance of the standard reduce the system's ability to remove systematic errors, and thus degrade error-corrected accuracy. Therefore, in addition to the predefined default cal kit models, a "user kit" is provided that can be modified to an alternate calibration standards model.

Several situations exist that may require a user-defined cal kit:

- A calibration is required for a connector interface different from the four built-in cal kits. (Examples: SMA, TNC, or waveguide.)
- A calibration with standards (or combinations of standards) that are different from the predefined cal kits is required. (Example: Using three offset shorts instead of open, short, and load to perform a 1-port calibration.)
- The built-in standard models for predefined kits can be improved or refined. Remember that the more closely the model describes the actual performance of the standard, the better the calibration. (Example: The 7 mm load is determined to be 50.4 ohms instead of 50.0 ohms.)
- Unused standards for a given cal type can be eliminated from the predefined set, to eliminate possible confusion during calibration. (Example: A certain application requires calibrating a male test port. The standards used to calibrate a female test port can be eliminated from the set, and will not be displayed during calibration.)

## Definitions

It is necessary to define some of the terms used:

- A "standard" is a specific, well-defined, physical device used to determine systematic errors.
- A standard "type" is one of five basic types that define the form or structure of the model to be used with that standard (e.g. short or load).
- Standard "coefficients" are numerical characteristics of the standards used in the model selected.
- A standard "class" is a grouping of one or more standards that determines which standards are used in a particular calibration procedure.



## Procedure

Basically, the following steps are used to modify or define a user kit:

1. To modify a cal kit, first select the predefined kit to be modified. This is not necessary for defining a new cal kit.
2. Define the standards. For each standard, define which "type" of standard it is and its electrical characteristics.
3. Specify the class where the standard is to be assigned.
4. Store the modified cal kit.

Following the descriptions of the menus for modifying calibration kits, a procedure is provided that enters the HP 85033C 3.5 mm calibration kit values as a "user kit."

## Modify Cal Kit Menu

This menu is accessed from the [CAL] key (refer to Figure 5-8). This leads in turn to additional series of menus associated with modifying cal kits.

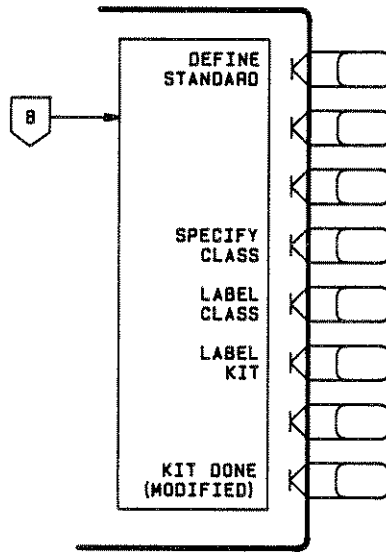

Figure 5-26. Modify Cal Kit Menu

[**DEFINE STANDARD**] (DEFS) makes the standard number the active function, and brings up the define standard menus. The standard number (1 to 8) is an arbitrary reference number used to reference standards while specifying a class. The standard numbers for the predefined calibration kits are as follows:

- |                  |                |
|------------------|----------------|
| 1 short          | 5 sliding load |
| 2 open           | 6 lowband load |
| 3 broadband load | 7 short        |
| 4 thru           | 8 open         |

**[SPECIFY CLASS]** leads to the specify class menu. After the standards are modified, use this key to specify a class to consist of certain standards.

**[LABEL CLASS]** leads to the label class menu, to give the class a meaningful label for future reference.

**[LABEL KIT]** (LBEK) leads to a menu for constructing a label for the user-modified cal kit. If a label is supplied, it will appear as one of the five softkey choices in the select cal kit menu. The approach is similar to defining a display title, except that the kit label is limited to ten characters. Refer to **[DISPLAY] Key, Title Menu** in Chapter 4 for details.

**[KIT DONE]** (KITD) terminates the cal kit modification process, after all standards are defined and all classes are specified. Be sure to save the kit with the **[SAVE USER KIT]** softkey, if it is to be used later.

## Define Standard Menus

Standard definition is the process of mathematically modeling the electrical characteristics (delay, attenuation, and impedance) of each calibration standard. These electrical characteristics (coefficients) can be mathematically derived from the physical dimensions and material of each calibration standard, or from its actual measured response. The parameters of the standards can be listed in *Standards Definitions*, Table 5-4. The menus illustrated in Figure 5-27 are used to specify the type and characteristics for each user-defined standard.

Table 5-4. Standard Definitions

| STANDARD |      | C0<br>x10 <sup>-15</sup> F | C1<br>x10 <sup>-27</sup> F/<br>Hz | C2<br>x10 <sup>-36</sup> F/<br>Hz | C3<br>x10 <sup>-45</sup> F/<br>Hz | FIXED OR<br>SLIDING | OFFSET      |              |                     | FREQUENCY (GHz) |         | COAX or<br>WAVEGUIDE | STANDARD<br>LABEL |
|----------|------|----------------------------|-----------------------------------|-----------------------------------|-----------------------------------|---------------------|-------------|--------------|---------------------|-----------------|---------|----------------------|-------------------|
| NO.      | TYPE |                            |                                   |                                   |                                   |                     | DELAY<br>ps | LOSS<br>MΩ/s | Z <sub>0</sub><br>Ω | MINIMUM         | MAXIMUM |                      |                   |
| 1        |      |                            |                                   |                                   |                                   |                     |             |              |                     |                 |         |                      |                   |
| 2        |      |                            |                                   |                                   |                                   |                     |             |              |                     |                 |         |                      |                   |
| 3        |      |                            |                                   |                                   |                                   |                     |             |              |                     |                 |         |                      |                   |
| 4        |      |                            |                                   |                                   |                                   |                     |             |              |                     |                 |         |                      |                   |
| 5        |      |                            |                                   |                                   |                                   |                     |             |              |                     |                 |         |                      |                   |
| 6        |      |                            |                                   |                                   |                                   |                     |             |              |                     |                 |         |                      |                   |
| 7        |      |                            |                                   |                                   |                                   |                     |             |              |                     |                 |         |                      |                   |
| 8        |      |                            |                                   |                                   |                                   |                     |             |              |                     |                 |         |                      |                   |

Each standard must be identified as one of five "types": open, short, load, delay/thru, or arbitrary impedance.

After a standard number is entered, selection of the standard type will present one of five menus for entering the electrical characteristics (model coefficients) corresponding to that standard type. These menus are tailored to the current type, so that only characteristics applicable to the standard type can be modified.

Any standard type can be further defined with offsets in delay, loss, and standard impedance; assigned minimum or maximum frequencies over which the standard applies; and defined as coax or waveguide. Press the **[SPECIFY OFFSET]** key, and refer to the specify offset menu.

A distinct label can be defined and assigned to each standard, so that the HP 8753B can prompt the user with explicit standard labels during calibration (e.g. "SHORT"). Press the **[LABEL STD]** softkey. The function is similar to defining a display title, except that the label is limited to ten characters. Refer to **[DISPLAY] Key, Title Menu** in Chapter 4 for details.

After each standard is defined, including offsets, press **[STD DONE (DEFINED)]** to terminate the standard definition.

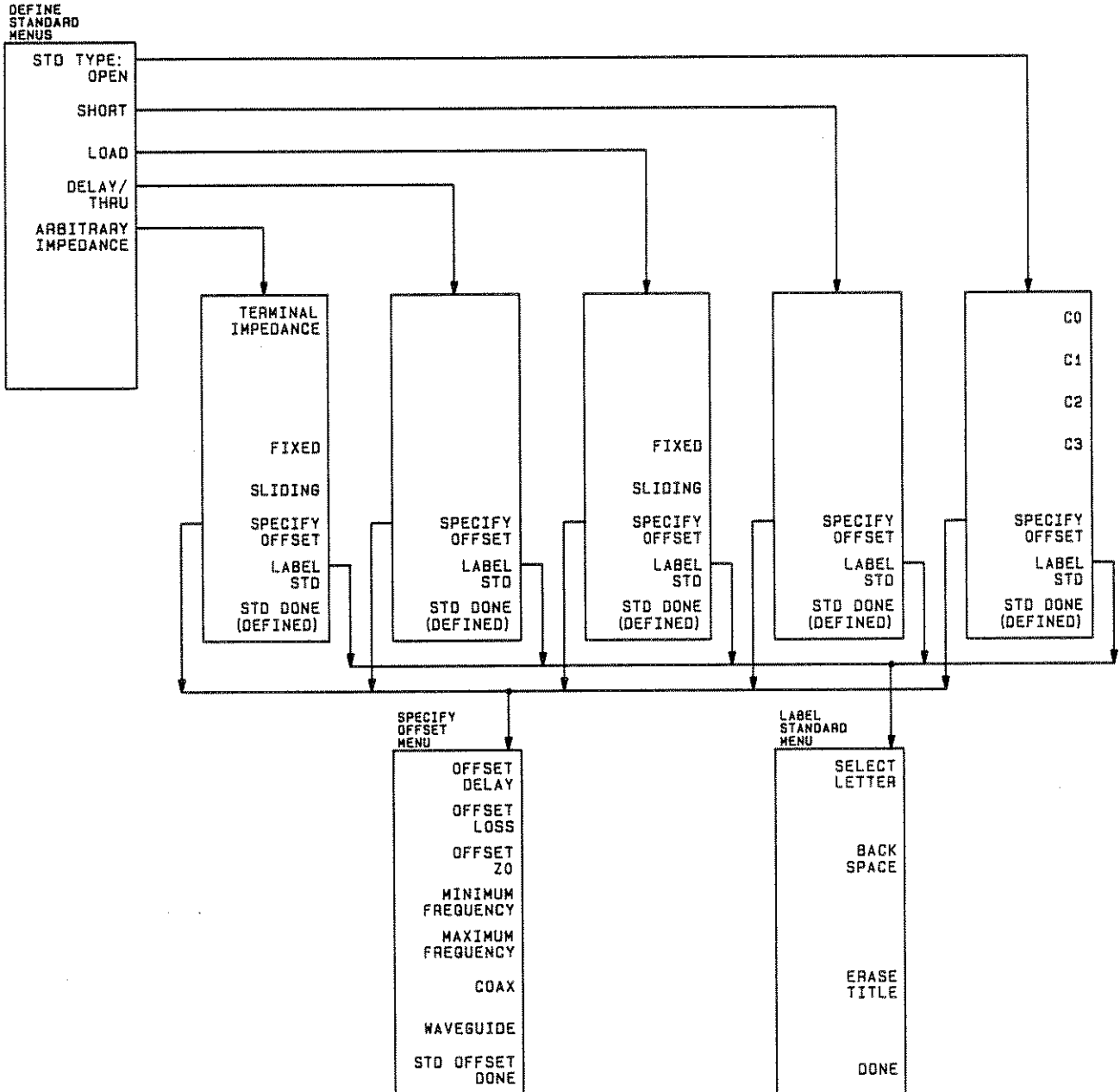

Figure 5-27. Define Standard Menus

**[OPEN]** (STDTOPEN) defines the standard type as an open, used for calibrating reflection measurements. Opens are assigned a terminal impedance of infinity ohms, but delay and loss offsets may still be added. Pressing this key also brings up a menu for defining the open, including its capacitance.

As a reflection standard, an open termination offers the advantage of broadband frequency coverage. At microwave frequencies, however, an open rarely has perfect reflection characteristics because fringing (capacitance) effects cause phase shift that varies with frequency. This can be observed in measuring an open termination after calibration, when an arc in the lower right circumference of the Smith chart indicates capacitive reactance. These effects are impossible to eliminate, but the calibration kit models include the open termination capacitance at all frequencies for compatible calibration kits. The capacitance model is a cubic polynomial, as a function of frequency, where the polynomial coefficients are user-definable. The capacitance model equation is:

$$C = (C0) + (C1 * F) + (C2 * F^2) + (C3 * F^3)$$

where F is the measurement frequency.

The terms in the equation are defined with the specify open menu as follows:

**[C0]** (C0) is used to enter the C0 term, which is the constant term of the cubic polynomial and is scaled by  $10^{-15}$  Farads.

**[C1]** (C1) is used to enter the C1 term, expressed in F/Hz (Farads/Hz) and scaled by  $10^{-27}$ .

**[C2]** (C2) is used to enter the C2 term, expressed in F/Hz<sup>2</sup> and scaled by  $10^{-36}$ .

**[C3]** (C3) is used to enter the C3 term, expressed in F/Hz<sup>3</sup> and scaled by  $10^{-45}$ .

**[SHORT]** (STDTSHOR) defines the standard type as a short, for calibrating reflection measurements. Shorts are assigned a terminal impedance of 0 ohms, but delay and loss offsets may still be added.

**[LOAD]** (STDTLOAD) defines the standard type as a load (termination). Loads are assigned a terminal impedance equal to the system characteristic impedance Z0, but delay and loss offsets may still be added. If the load impedance is not Z0, use the arbitrary impedance standard definition.

**[FIXED]** (FIXE) defines the load as a fixed (not sliding) load.

**[SLIDING]** (SLIL) defines the load as a sliding load. When such a load is measured during calibration, the HP 8753B will prompt for several load positions, and calculate the ideal load value from it.

**[DELAY/THRU]** (STDTDELA) defines the standard type as a transmission line of specified length, for calibrating transmission measurements.

**[ARBITRARY IMPEDANCE]** (STDTARBI) defines the standard type to be a load, but with an arbitrary impedance (different from system Z0).

**[TERMINAL IMPEDANCE]** (TERI) is used to specify the (arbitrary) impedance of the standard, in ohms.

**[FIXED]** (FIXE) defines the load as a fixed (not sliding) load.

**[SLIDING]** (SLIL) defines the load as a sliding load. When such a load is measured during calibration, the HP 8753B will prompt for several load positions, and calculate the ideal load value from it.

## Specify Offset Menu

The specify offset menu allows additional specifications for a user-defined standard. Features specified in this menu are common to all five types of standards.

Offsets may be specified with any standard type. This means defining a uniform length of transmission line to exist between the standard being defined and the actual measurement plane. (Example: a waveguide short circuit terminator, offset by a short length of waveguide.) For reflection standards, the offset is assumed to be between the measurement plane and the standard (one-way only). For transmission standards, the offset is assumed to exist between the two reference planes (in effect, the offset *is* the thru). Three characteristics of the offset can be defined: its delay (length), loss, and impedance.

In addition, the frequency range over which a particular standard is valid can be defined with a minimum and maximum frequency. This is particularly important for a waveguide standard, since its behavior changes rapidly beyond its cutoff frequency. Note that several band-limited standards can together be defined as the same "class" (see specify class menu). Then, if a measurement calibration is performed over a frequency range exceeding a single standard, additional standards can be used for each portion of the range.

Lastly, the standard must be defined as either coaxial or waveguide. If it is waveguide, dispersion effects are calculated automatically and included in the standard model.

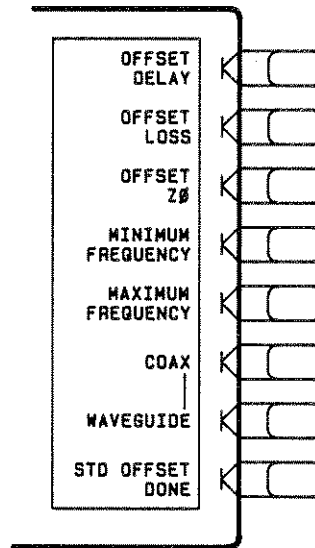

Figure 5-28. Specify Offset Menu

**[OFFSET DELAY]** (OFSD) is used to specify the one-way electrical delay from the measurement (reference) plane to the standard, in seconds (s). (In a transmission standard, offset delay is the delay from plane to plane.) Delay can be calculated from the precise physical length of the offset, the permittivity constant of the medium, and the speed of light.

In coax, group delay is considered constant. In waveguide, however, group delay is dispersive, that is, it changes significantly as a function of frequency. Hence, for a waveguide standard, offset delay must be defined at an infinitely high frequency.

**[OFFSET LOSS]** (OFSL) is used to specify energy loss, due to skin effect, along a one-way length of coax offset. The value of loss is entered as ohms/nanosecond (or Giga ohms/second) at 1 GHz. (Such losses are negligible in waveguide, so enter 0 as the loss offset.)

**[OFFSET Z0]** (OFSZ) is used to specify the characteristic impedance of the coax offset. (Note: This is *not* the impedance of the standard itself.) (For waveguide, the offset impedance is always assigned a value equal to the system Z0.)

**[MINIMUM FREQUENCY]** (MINF) is used to define the lowest frequency at which the standard can be used during measurement calibration. In waveguide, this *must* be the lower cutoff frequency of the standard, so that the HP 8753B can calculate dispersive effects correctly (see **[OFFSET DELAY]** above).

**[MAXIMUM FREQUENCY]** (MAXF) is used to define the highest frequency at which the standard can be used during measurement calibration. In waveguide, this is normally the upper cutoff frequency of the standard.

**[COAX]** (COAX) defines the standard (and the offset) as coaxial. This causes the HP 8753B to assume linear phase response in any offsets.

**[WAVEGUIDE]** (WAVE) defines the standard (and the offset) as rectangular waveguide. This causes the HP 8753B to assume a dispersive delay (see **[OFFSET DELAY]** above).

### Label Standard Menu (LABS)

This menu is used to label (reference) individual standards during the menu-driven measurement calibration sequence. The labels are user-definable using a character set displayed on the CRT that includes letters, numbers, and some symbols, and they may be up to ten characters long. The HP 8753B will prompt you to connect standards using these labels, so they should be meaningful to you, and distinct for each standard.

By convention, when sexed connector standards are labeled male (m) or female (f), the designation refers to the test port connector sex, not the connector sex of the standard.

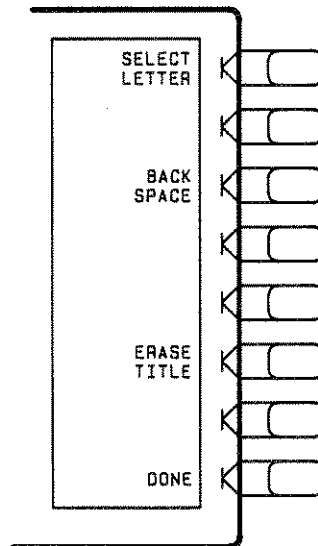

Figure 5-29. Label Standard Menu

Standard labels are created in the same way as titles. Refer to **[DISPLAY] Key, Title Menu** in Chapter 4.

## Specify Class Menus

Once a standard is specified, it must be assigned to a standard "class". This is a group of from one to seven standards that is required to calibrate for a single error term. The standards within a single class are assigned to locations A through G as listed on the *Standard Class Assignments Table* (Table 5-5). A class often consists of a single standard, but may be composed of more than one standard if band-limited standards are used. (Example: All predefined calibration kits for the HP 8753B have a single load standard per class, since all are broadband in nature. However, if there were two load standards – a fixed load for low frequencies, and a sliding load for high frequencies – then that class would have two standards.)

Table 5-5. *Standard Class Assignments Table*

|                      | A | B | C | D | E | F | G | STANDARD CLASS LABEL |
|----------------------|---|---|---|---|---|---|---|----------------------|
| S <sub>11</sub> A    |   |   |   |   |   |   |   |                      |
| S <sub>11</sub> B    |   |   |   |   |   |   |   |                      |
| S <sub>11</sub> C    |   |   |   |   |   |   |   |                      |
| S <sub>22</sub> A    |   |   |   |   |   |   |   |                      |
| S <sub>22</sub> B    |   |   |   |   |   |   |   |                      |
| S <sub>22</sub> C    |   |   |   |   |   |   |   |                      |
| Forward Transmission |   |   |   |   |   |   |   |                      |
| Reverse Transmission |   |   |   |   |   |   |   |                      |
| Forward Match        |   |   |   |   |   |   |   |                      |
| Reverse Match        |   |   |   |   |   |   |   |                      |
| Response             |   |   |   |   |   |   |   |                      |
| Response & Isolation |   |   |   |   |   |   |   |                      |

The number of standard classes required depends on the type of calibration being performed, and is identical to the number of error terms corrected. (Examples: A response cal requires only one class, and the standards for that class may include an open and/or short and/or thru. A 1-port cal requires three classes. A full 2-port cal requires 10 classes, not including two for isolation.)

The number of standards that can be assigned to a given class may vary from none (class not used) to one (simplest class) to seven. When a certain class of standards is required during calibration, the HP 8753B will display the labels for *all* the standards in that class (except when the class consists of a single standard). This does not, however, mean that all standards in a class must be measured during calibration. Unless band-limited standards are used, only a single standard per class is required. Note that it is often simpler to keep the number of standards per class to the bare minimum needed (often one) to avoid confusion during calibration.

Standards are assigned to a class simply by entering the standard's reference number (established while defining a standard) under a particular class.

Each class can be given a user-definable label as described under *Label Class Menus*.

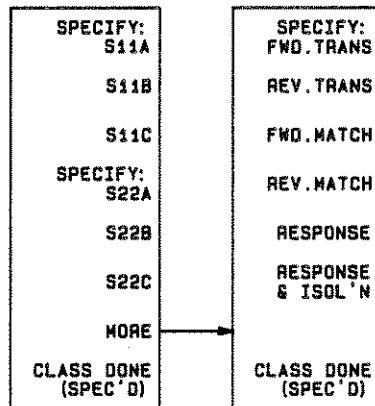

Figure 5-30. Specify Class Menus

**[SPECIFY: S11A]** (SPECS11A) is used to enter the standard number(s) for the first class required for an  $S_{11}$  1-port calibration. (For predefined cal kits, this is the open.)

**[S11B]** (SPECS11B) is used to enter the standard number(s) for the second class required for an  $S_{11}$  1-port calibration. (For predefined cal kits, this is the short.)

**[S11C]** (SPECS11C) is used to enter the standard number(s) for the third class required for an  $S_{11}$  1-port calibration. (For predefined kits, this is the load.)

**[SPECIFY: S22A]** (SPECS22A) is used to enter the standard number(s) for the first class required for an  $S_{22}$  1-port calibration. (For predefined cal kits, this is the open.)

**[S22B]** (SPECS22B) is used to enter the standard number(s) for the second class required for an  $S_{22}$  1-port calibration. (For predefined cal kits, this is the short.)

**[S22C]** (SPECS22C) is used to enter the standard number(s) for the third class required for an  $S_{22}$  1-port calibration. (For predefined kits, this is the load.)

**[MORE]** leads to the following softkeys.

**[FWD.TRANS.]** (SPECFWDT) is used to enter the standard number(s) for the forward transmission thru calibration. (For predefined kits, this is the thru.)

**[REV.TRANS.]** (SPECREVT) is used to enter the standard number(s) for the reverse transmission (thru) calibration. (For predefined kits, this is the thru.)

**[FWD.MATCH]** (SPECFWDM) is used to enter the standard number(s) for the forward match (thru) calibration. (For predefined kits, this is the thru.)

**[REV.MATCH]** (SPECREVM) is used to enter the standard number(s) for the reverse match (thru) calibration. (For predefined kits, this is the thru.)

**[RESPONSE]** (SPECRESP) is used to enter the standard number(s) for a response calibration. This calibration corrects for frequency response in either reflection or transmission measurements, depending on the parameter being measured when a calibration is performed. (For predefined kits, the standard is either the open or short for reflection measurements, or the thru for transmission measurements.)

**[RESPONSE & ISOL'N]** (SPECRESI) is used to enter the standard number(s) for a response & isolation calibration. This calibration corrects for frequency response and directivity in reflection measurements, or frequency response and isolation in transmission measurements.



## Label Class Menus

The label class menus are used to define meaningful labels for the calibration classes. These then become softkey labels during a measurement calibration. Labels can be up to ten characters long.

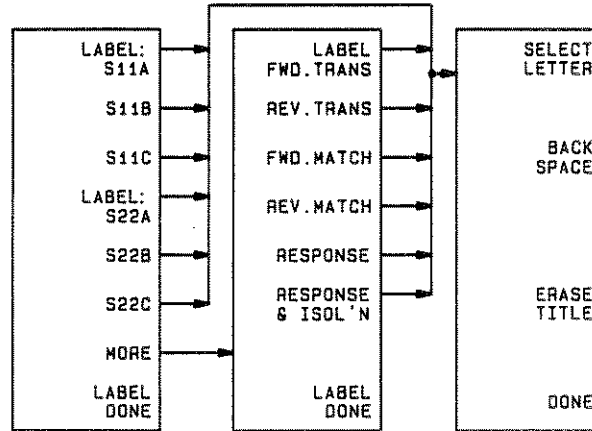

Figure 5-31. Label Class Menus

Labels are created in the same way as display titles. Refer to *[DISPLAY] Key, Title Menu* in Chapter 4.

## Label Kit Menu

After a new calibration kit has been defined, be sure to specify a label for it. Choose a label that describes the connector type of the calibration devices. This label will then appear in the **[CAL KIT]** softkey label in the correction menu and the **[MODIFY]** label in the select cal kit menu. It will be saved with calibration sets.

This menu is accessed with the **[LABEL KIT]** softkey in the modify cal kit menu, and is identical to the label class menu and the label standard menu described above. It allows definition of a label up to eight characters long.

## Verify Performance

Once a measurement calibration has been generated with a user-defined calibration kit, its performance should be checked before making device measurements. To check the accuracy that can be obtained using the new calibration kit, a device with a well-defined frequency response (preferably unlike any of the standards used) should be measured. The verification device must not be one of the calibration standards: measurement of one of these standards is merely a measure of repeatability.

To achieve more complete verification of a particular measurement calibration, accurately known verification standards with a diverse magnitude and phase response should be used. NBS traceable or HP standards are recommended to achieve verifiable measurement accuracy.

**NOTE:** The published specifications for the HP 8753B network analyzer system include accuracy enhancement with compatible calibration kits. Measurement calibrations made with user-defined or modified calibration kits are not subject to the HP 8753B specifications, although a procedure similar to the system verification procedure may be used.

## Example Procedure for Specifying a User-Defined Calibration Kit

The following procedure enters the HP 85033C 3.5 mm calibration kit values as a "user kit." This is provided as an example to illustrate the steps required in defining a calibration kit model.

**NOTE:** Numerical data for most Hewlett-Packard calibration kits is provided in the calibration kit manuals.

The first keystroke sequence enters the values for standard #1, the short circuit.

- **[CAL] [CAL KIT] [MODIFY]**
- **[DEFINE STANDARD] [SHORT]**
- **[SPECIFY OFFSET] [OFFSET DELAY] [.] [0] [1] [6] [6] [9] [5] [G/n]**
- **[STD OFFSET DONE] [STD DONE (DEFINED)]**

The next sequence specifies standard #2, the open circuit.

- **[DEFINE STANDARD] [2] [x1] [OPEN]**
- **[C0] [5] [3] [x1]**
- **[C1] [1] [5] [0] [x1]**
- **[C2] [0] [x1]**
- **[C3] [0] [x1]**
- **[SPECIFY OFFSET] [OFFSET DELAY] [.] [0] [1] [4] [4] [9] [1] [G/n]**
- **[STD OFFSET DONE] [STD DONE (DEFINED)]**

The next sequence specifies standard #3, the lowband load.

- **[DEFINE STANDARD] [3] [x1] [LOAD]**
- **[SPECIFY OFFSET] [MAXIMUM FREQUENCY] [6] [.] [0] [0] [1] [G/n]**
- **[STD OFFSET DONE] [STD DONE (DEFINED)]**

The final sequence labels the kit and saves it in memory.

- **[LABEL KIT]**
- Use the knob and softkeys to modify the label to read "3.5mmC"
- **[DONE] [KIT DONE (MODIFIED)]**
  
- **[CAL]**
- **[CAL KIT 3.5mmC]**
- **[SAVE USER KIT] [USER KIT]**

The **[USER KIT]** softkey is now underlined, and the user-specified kit definition is saved in non-volatile memory.

## ACCURACY ENHANCEMENT FUNDAMENTALS—CHARACTERIZING MICROWAVE SYSTEMATIC ERRORS

### One-Port Error Model

In a measurement of the reflection coefficient (magnitude and phase) of an unknown device, the measured data differs from the actual, no matter how carefully the measurement is made. Directivity, source match, and reflection signal path frequency response (tracking) are the major sources of error (Figure 5-32).

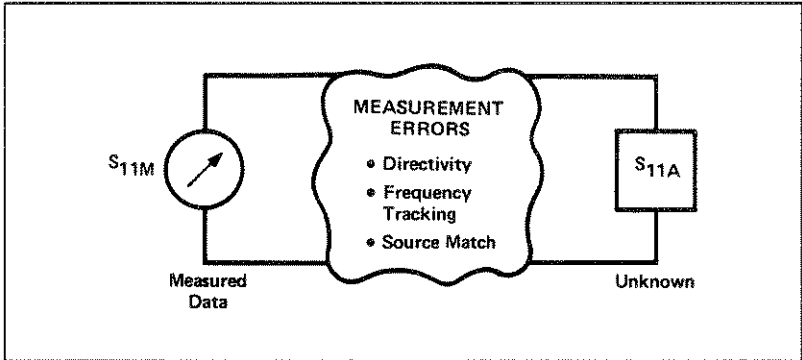

Figure 5-32. Sources of Error in a Reflection Measurement

The reflection coefficient is measured by first separating the incident signal (I) from the reflected signal (R), then taking the ratio of the two values (Figure 5-33). Ideally, (R) consists only of the signal reflected by the test device (S11A).

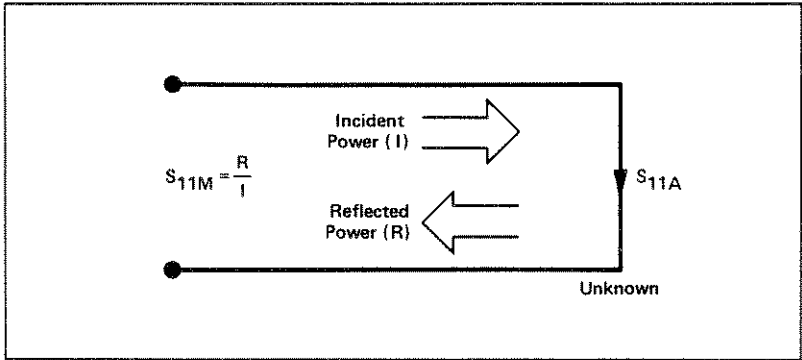

Figure 5-33

However, all of the incident signal does not always reach the unknown (see Figure 5-34). Some of (I) may appear at the measurement system input due to leakage through the test set or other signal separation device. Also, some of (I) may be reflected by imperfect adapters between signal separation and the measurement plane. The vector sum of the leakage and miscellaneous reflections is directivity, EDF. Understandably, the measurement is distorted when the directivity signal combines vectorally with the actual reflected signal from the unknown, S<sub>11A</sub>.

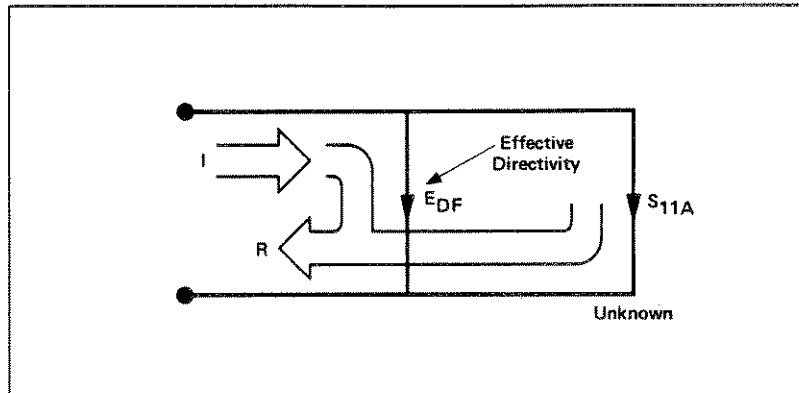

Figure 5-34

Since the measurement system test port is never exactly the characteristic impedance (50 ohms or 75 ohms), some of the reflected signal bounces off the test port, or other impedance transitions further down the line, and back to the unknown, adding to the original incident signal (I). This effect causes the magnitude and phase of the incident signal to vary as a function of S<sub>11A</sub> and frequency. Leveling the source to produce constant (I) reduces this error, but since the source cannot be exactly leveled at the test device input, leveling cannot eliminate all power variations. This re-reflection effect and the resultant incident power variation are caused by the source match error, ESF (Figure 5-35).

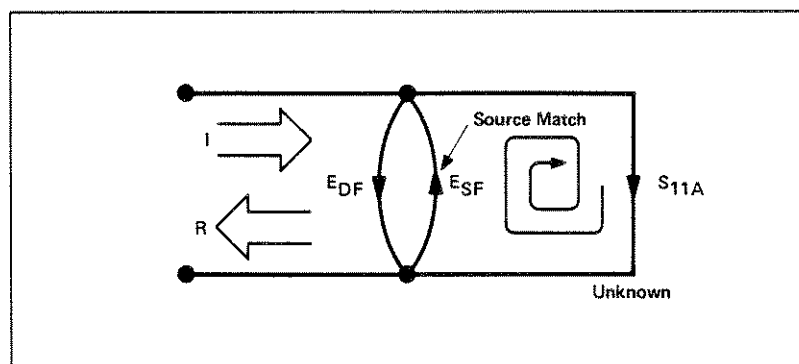

Figure 5-35

Frequency response (tracking) error is caused by variations in magnitude and phase flatness versus frequency between the test and reference signal paths. These are due mainly to imperfectly matched samplers and differences in length and loss between incident and test signal paths. The vector sum of these variations is the reflection signal path tracking error, E<sub>RF</sub> (Figure 5-36).

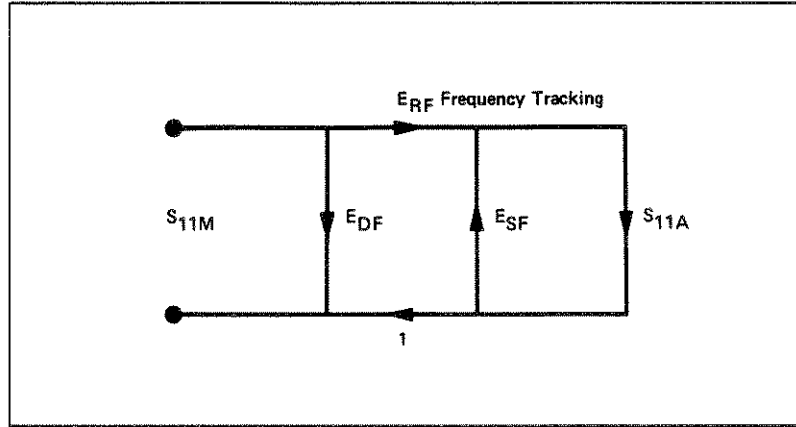

Figure 5-36

It can be shown that these three errors are mathematically related to the actual data, S<sub>11A</sub>, and measured data, S<sub>11M</sub>, by the following equation:

$$S_{11M} = E_{DF} + \frac{S_{11A} (E_{RF})}{1 - E_{SF} S_{11A}}$$

If the value of these three "E" errors and the measured test device response were known for each frequency, the above equation could be solved for S<sub>11A</sub> to obtain the actual test device response. Because each of these errors changes with frequency, it is necessary that their values be known at each test frequency. These values are found by measuring the system at the measurement plane using three independent standards whose S<sub>11A</sub> is known at all frequencies.

The first standard applied is a "perfect load", which makes  $S_{11A} = 0$  and essentially measures directivity (Figure 5-37). "Perfect load" implies a reflectionless termination at the measurement plane. All incident energy is absorbed. With  $S_{11A} = 0$  the equation can be solved for EDF, the directivity term. In practice, of course, the "perfect load" is difficult to achieve, although very good broadband loads are available in the HP 8753B compatible calibration kits.

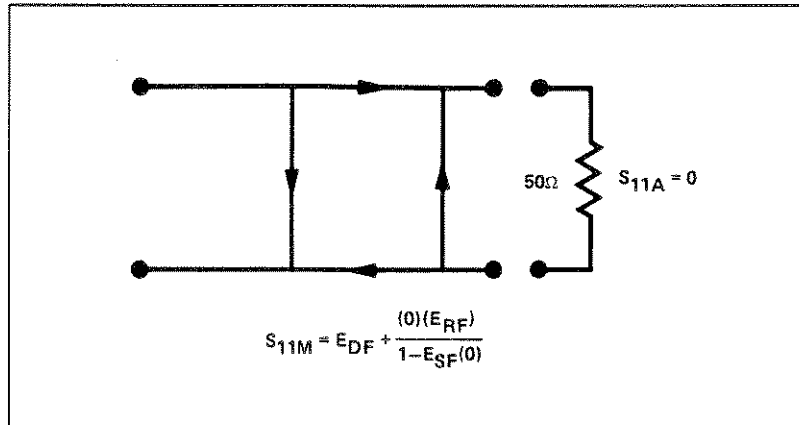

Figure 5-37

Since the measured value for directivity is the vector sum of the actual directivity plus the actual reflection coefficient of the "perfect load," any reflection from the termination represents an error. System effective directivity becomes the actual reflection coefficient of the "perfect load" (Figure 5-38). In general, any termination having a return loss value greater than the uncorrected system directivity reduces reflection measurement uncertainty.

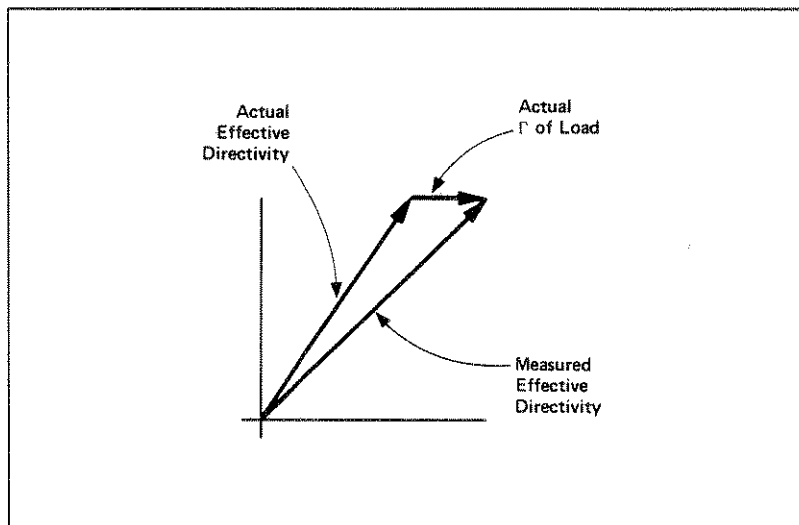

Figure 5-38

Next, a short circuit termination whose response is known to a very high degree is used to establish another condition (Figure 5-39).

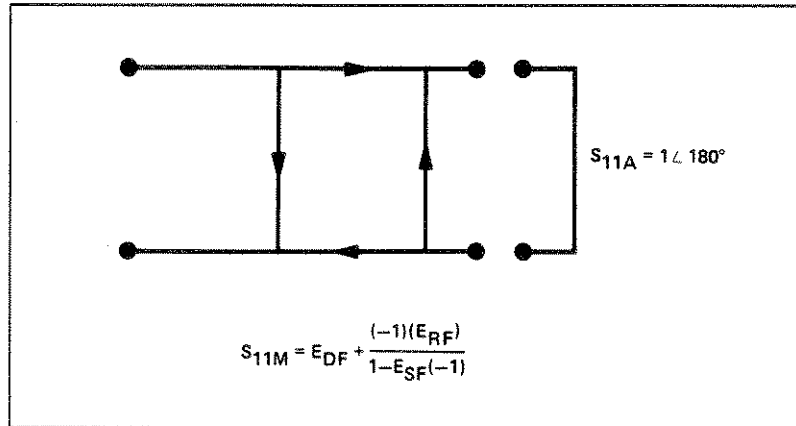

Figure 5-39

The open circuit gives the third independent condition. In order to accurately model the phase variation with frequency due to radiation from the open connector, a specially designed shielded open circuit is used for this step. (The open circuit capacitance is different with each connector type). Now the values for EDF, directivity, ESF, source match, and ERF, reflection frequency response, are computed and stored (Figure 5-40).

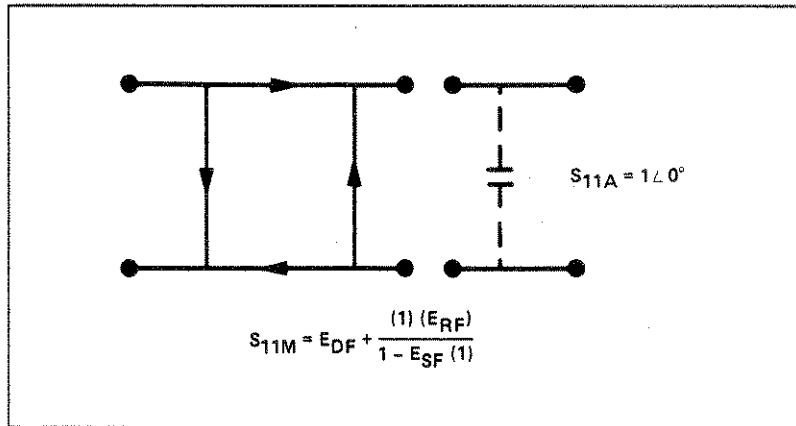

Figure 5-40

Now the unknown is measured to obtain a value for the measured response, S<sub>11M</sub>, at each frequency (Figure 5-41).

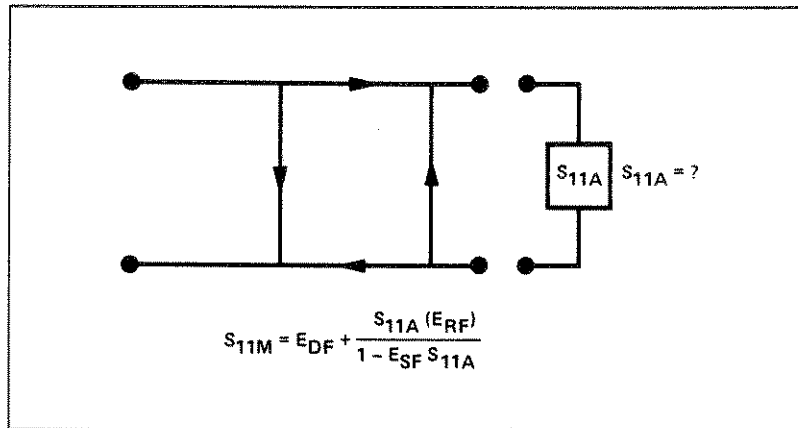

Figure 5-41

This is the one-port error model equation solved for S<sub>11A</sub>. Since the three errors and S<sub>11M</sub> are now known for each test frequency, S<sub>11A</sub> can be computed as follows:

$$S_{11A} = \frac{S_{11M} - E_{DF}}{E_{SF} (S_{11M} - E_{DF}) + E_{RF}}$$

For reflection measurements on two-port devices, the same technique can be applied, but the test device output port must be terminated in the system characteristic impedance. This termination should be at least as good (have as low a reflection coefficient) as the load used to determine directivity. The additional reflection error caused by an improper termination at the test device output port is not incorporated into the one-port error model.



## Two-Port Error Model

The error model for measurement of the transmission coefficients (magnitude and phase) of a two-port device is derived in a similar manner. The major sources of error are frequency response (tracking), source match, load match, and isolation (Figure 5-42). These errors are effectively removed using the full two-port error model.

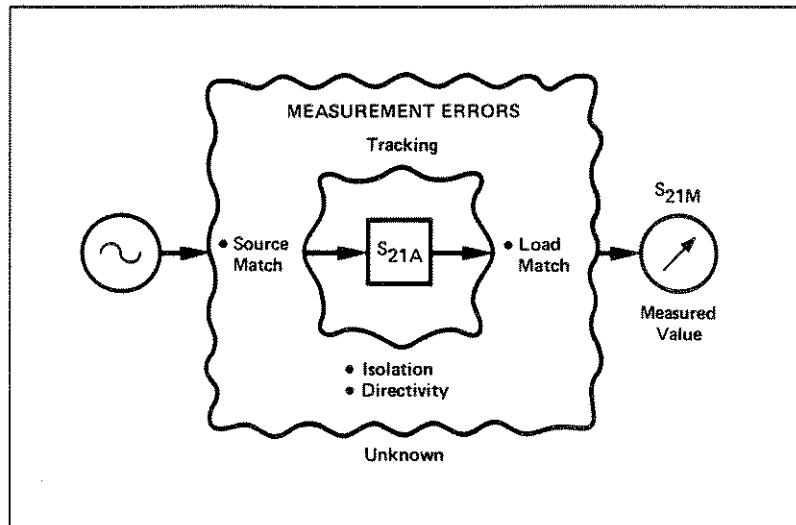

Figure 5-42

The transmission coefficient is measured by taking the ratio of the incident signal (I) and the transmitted signal (T) (Figure 5-43). Ideally, (I) consists only of power delivered by the source, and (T) consists only of power emerging at the test device output.

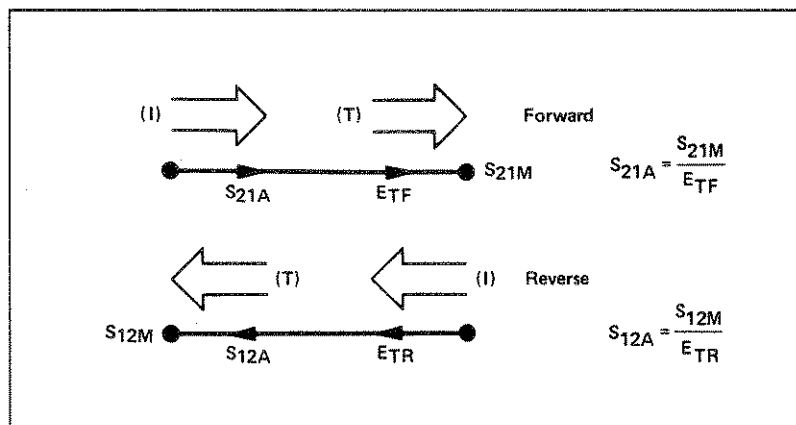

Figure 5-43

As in the reflection model, source match can cause the incident signal to vary as a function of test device S11A. Also, since the test setup transmission return port is never exactly the characteristic impedance, some of the transmitted signal is reflected from the test set port 2, and from other mismatches between the test device output and the receiver input, to return to the test device. A portion of this signal may be re-reflected at port 2, thus affecting S21M, or part may be transmitted through the device in the reverse direction to appear at port 1, thus affecting S11M. This error term, which causes the magnitude and phase of the transmitted signal to vary as a function of S22A, is called load match, ELF (Figure 5-44).

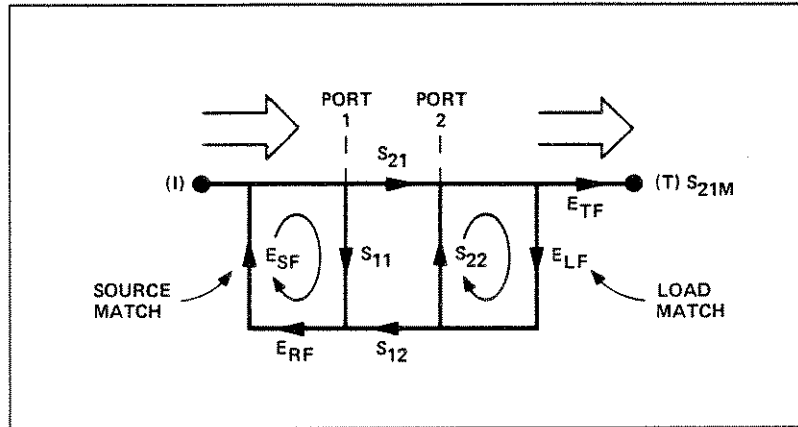

Figure 5-44

The measured value, S21M, consists of signal components that vary as a function of the relationship between ESF and S11A as well as ELF and S22A, so the input and output reflection coefficients of the test device must be measured and stored for use in the S21A error correction computation. Thus, the test setup is calibrated as described above for reflection to establish the directivity, EDF, source match, ESF, and reflection frequency response, ERF, terms for the reflection measurements.

Now that a calibrated port is available for reflection measurements, the thru is connected and load match, ELF, is determined by measuring the reflection coefficient of the thru connection.

Transmission signal path frequency response is then measured with the thru connected. The data is corrected for source and load match effects, then stored as transmission frequency response, ETF.

Isolation, EXF, represents the part of the incident signal that appears at the receiver without actually passing through the test device (Figure 5-45). Isolation is measured with the test set in the transmission configuration and with terminations installed at the points where the test device will be connected.

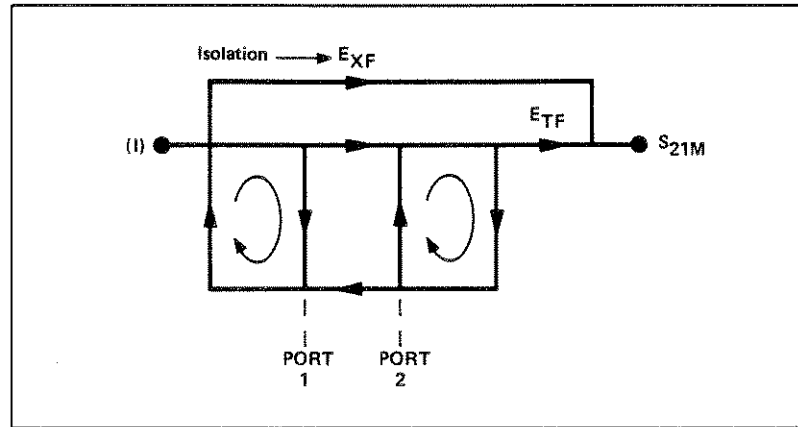

Figure 5-45

Thus there are two sets of error terms, forward and reverse, with each set consisting of six error terms, as follows:

- Directivity, EDF (forward) and EDR (reverse)
- Isolation, EXF and EXR
- Source Match, ESF and ESR
- Load Match, ELF and ELR
- Transmission Tracking, ETF and ETR
- Reflection Tracking, ERF and ERR.

The HP 85046A/B and 85047A S-parameter test sets can measure both the forward and reverse characteristics of the test device without the need to manually remove and physically reverse it. With these test sets, the full two-port error model illustrated in Figure 5-46 effectively removes both the forward and reverse error terms for transmission and reflection measurements.

The HP 85044A/B transmission/reflection test sets cannot switch between forward and reverse directions, so the reverse error terms cannot be automatically measured. Therefore, with the one-path two-port calibration, the forward error terms are duplicated and used for both forward and reverse measurements by manually reversing the test device.

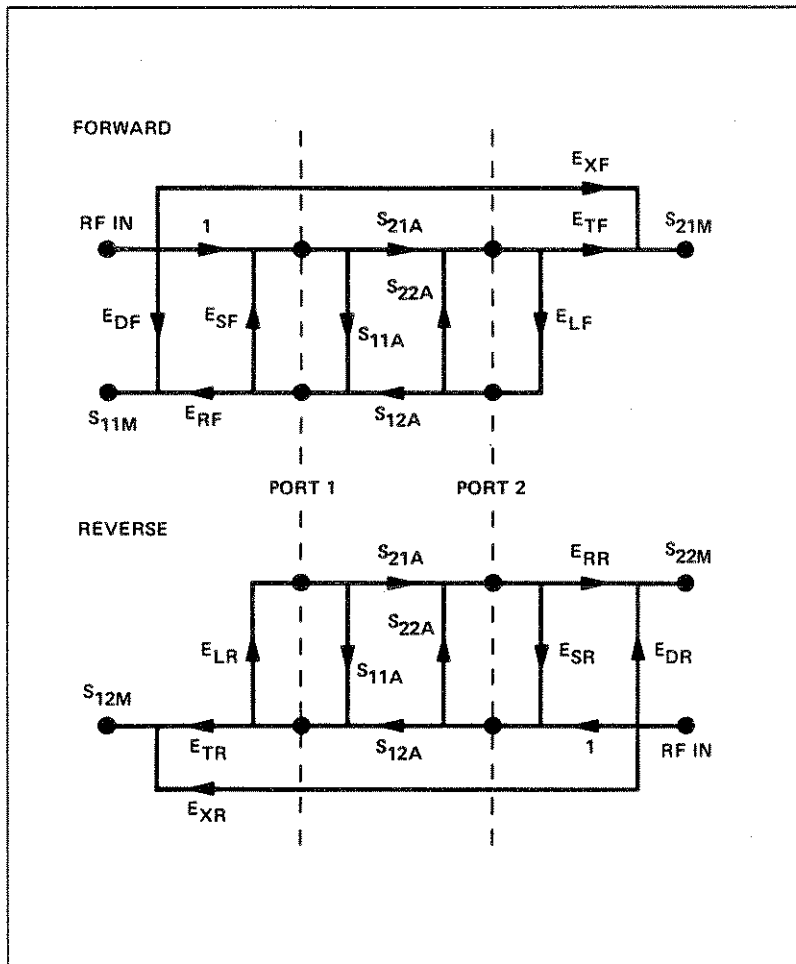

Figure 5-46

Figure 5-47 shows the full two-port error model equations for all four S-parameters of a two-port device. Note that the mathematics for this comprehensive model use all forward and reverse error terms and measured values. Thus, to perform full error correction for any one parameter, all four S-parameters must be measured.

Applications of these error models are provided in the calibration procedures described in Chapter 5.

$$S_{11A} = \frac{\left[ \left( \frac{S_{11M} - E_{DF}}{E_{RF}} \right) \left[ 1 + \left( \frac{S_{22M} - E_{DR}}{E_{RR}} \right) E_{SR} \right] \right] - \left[ \left( \frac{S_{21M} - E_{XF}}{E_{TF}} \right) \left( \frac{S_{12M} - E_{XR}}{E_{TR}} \right) E_{LF} \right]}{\left[ 1 + \left( \frac{S_{11M} - E_{DF}}{E_{RF}} \right) E_{SF} \right] \left[ 1 + \left( \frac{S_{22M} - E_{DR}}{E_{RR}} \right) E_{SR} \right] - \left[ \left( \frac{S_{21M} - E_{XF}}{E_{TF}} \right) \left( \frac{S_{12M} - E_{XR}}{E_{TR}} \right) E_{LF} E_{LR} \right]}$$

$$S_{21A} = \frac{\left[ 1 + \left( \frac{S_{22M} - E_{DR}}{E_{RR}} \right) (E_{SR} - E_{LF}) \right] \left( \frac{S_{21M} - E_{XF}}{E_{TF}} \right)}{\left[ 1 + \left( \frac{S_{11M} - E_{DF}}{E_{RF}} \right) E_{SF} \right] \left[ 1 + \left( \frac{S_{22M} - E_{DR}}{E_{RR}} \right) E_{SR} \right] - \left[ \left( \frac{S_{21M} - E_{XF}}{E_{TF}} \right) \left( \frac{S_{12M} - E_{XR}}{E_{TR}} \right) E_{LF} E_{LR} \right]}$$

$$S_{12A} = \frac{\left[ 1 + \left( \frac{S_{11M} - E_{DF}}{E_{RF}} \right) (E_{SF} - E_{LR}) \right] \left( \frac{S_{12M} - E_{XR}}{E_{TR}} \right)}{\left[ 1 + \left( \frac{S_{11M} - E_{DF}}{E_{RF}} \right) E_{SF} \right] \left[ 1 + \left( \frac{S_{22M} - E_{DR}}{E_{RR}} \right) E_{SR} \right] - \left[ \left( \frac{S_{21M} - E_{XF}}{E_{TF}} \right) \left( \frac{S_{12M} - E_{XR}}{E_{TR}} \right) E_{LF} E_{LR} \right]}$$

$$S_{22A} = \frac{\left[ \left( \frac{S_{22M} - E_{DR}}{E_{RR}} \right) \left[ 1 + \left( \frac{S_{11M} - E_{DF}}{E_{RF}} \right) E_{SF} \right] \right] - \left[ \left( \frac{S_{21M} - E_{XF}}{E_{TF}} \right) \left( \frac{S_{12M} - E_{XR}}{E_{TR}} \right) E_{LR} \right]}{\left[ 1 + \left( \frac{S_{11M} - E_{DF}}{E_{RF}} \right) E_{SF} \right] \left[ 1 + \left( \frac{S_{22M} - E_{DR}}{E_{RR}} \right) E_{SR} \right] - \left[ \left( \frac{S_{21M} - E_{XF}}{E_{TF}} \right) \left( \frac{S_{12M} - E_{XR}}{E_{TR}} \right) E_{LF} E_{LR} \right]}$$

Figure 5-47

In addition to the errors removed by accuracy enhancement, other systematic errors exist due to limitations of dynamic accuracy, test set switch repeatability, and test cable stability. These, combined with random errors, also contribute to total system measurement uncertainty. Therefore, after accuracy enhancement procedures are performed, residual measurement uncertainties remain. *System Performance* in the *General Information and Specifications* section of this manual provides information for calculating the system's total error-corrected measurement uncertainty performance.

# Chapter 6. Using Markers

## CHAPTER CONTENTS

- 6-1 [MKR] Key
- 6-4 Marker Menu
- 6-5 Delta Marker Mode Menu
- 6-6 Fixed Marker Menu
- 6-8 Marker Mode Menu
- 6-9 Polar Marker Menu
- 6-10 Smith Marker Menu
- 6-11 [MKR FCTN] Key
- 6-11 Marker Function Menu
- 6-13 Marker Search Menu
- 6-14 Target Menu

## [MKR] KEY

The [MKR] (MENUMARK) key displays a movable active marker ( $\nabla$ ) on the screen and provides access to a series of menus to control from one to four display markers for each channel (a total of eight). Markers are used to obtain numerical readings of measured values. They also provide capabilities for reducing measurement time by changing stimulus parameters, searching the trace for specific values, or statistically analyzing part or all of the trace. Figure 6-1 illustrates the displayed trace with all markers on and marker 1 the active marker.

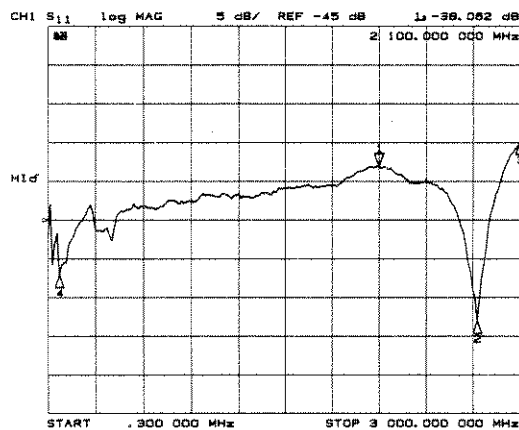

Figure 6-1. Markers on Trace

Markers have a stimulus value (the x-axis value in a Cartesian format) and a response value (the y-axis value in a Cartesian format). In a polar or Smith chart format, the second part of a complex data pair is also provided as an auxiliary response value. When a marker is turned on and no other function is active, its stimulus value is displayed in the active entry area and can be controlled with the knob, the step keys, or the numerical keypad. The active marker can be moved to any point on the trace, and its response and stimulus values are displayed at the top right corner of the graticule for each displayed channel, in units appropriate to the display format. The displayed marker response values are valid even when the measured data is above or below the range displayed on the graticule.

Marker values are normally continuous: that is, they are interpolated between measured points. Alternatively, they can be set to read only discrete measured points. The markers for the two channels normally have the same stimulus values, or they can be uncoupled so that each channel has independent markers, regardless of whether stimulus values are coupled or dual channel display is on.

If both data and memory are displayed, the marker values apply to the data trace. If memory only is displayed, the marker values apply to the memory trace. In a memory math display (data/memory or data-memory), the marker values apply to the trace resulting from the memory math function.

With the use of a reference marker, a delta marker mode is available that displays both the stimulus and response values of the active marker relative to the reference. Any of the four markers or a fixed point can be designated as the delta reference marker. If the delta reference is one of the four markers, its stimulus value can be controlled by the user and its response value is the value of the trace at that stimulus value. If the delta reference is a fixed marker, both its stimulus value and its response value can be set arbitrarily by the user anywhere in the display area (not necessarily on the trace).

Markers can be used to search for the trace maximum or minimum point or any other point on the trace. The four markers can be used together to search for specified bandwidth cutoff points and calculate the bandwidth and Q values. Statistical analysis uses markers to provide a readout of the mean, standard deviation, and peak-to-peak values of all or part of the trace.

Basic marker operations are available in the menus accessed from the **[MKR]** key. The marker search and statistical functions, together with the capability for quickly changing stimulus parameters with markers, are provided in the menus accessed from the **[MKR FCTN]** key.



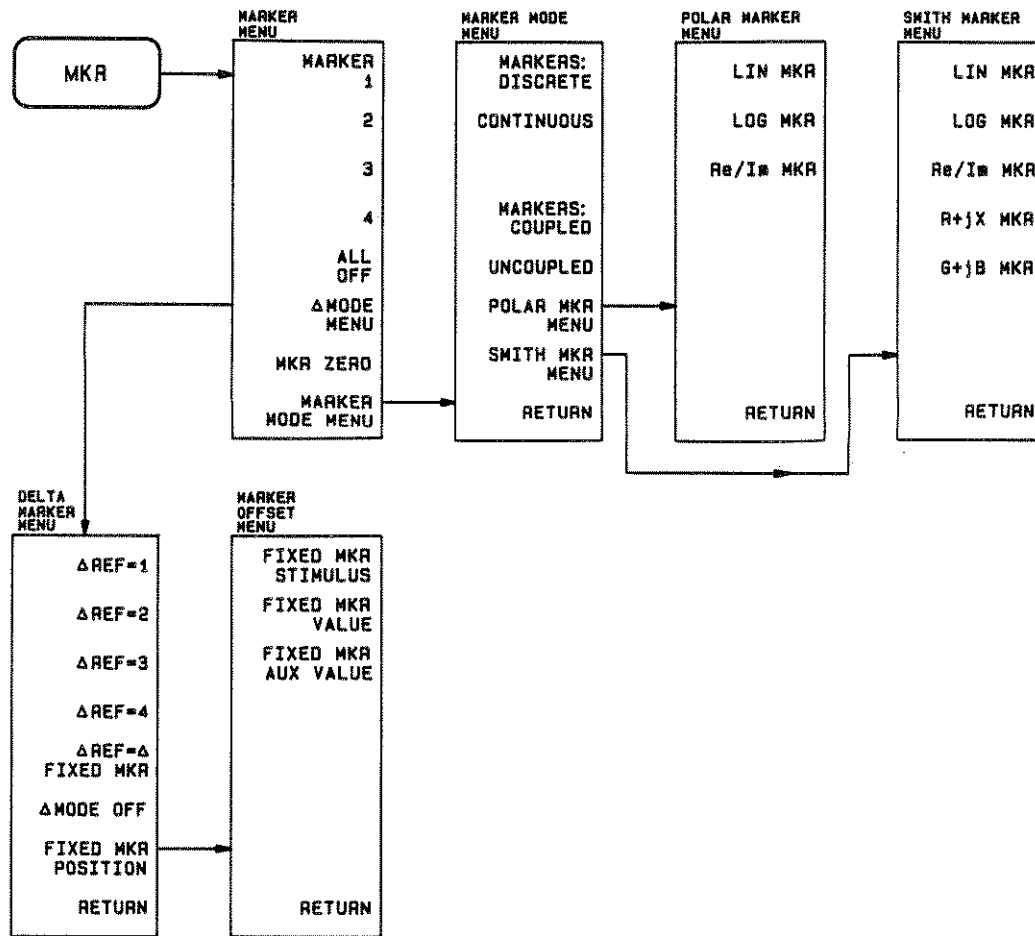

Figure 6-2. Menus Accessed from the [MKR] Key

The menus accessed from the [MKR] key (Figure 6-2) provide several basic marker operations. These include different marker modes for different display formats, and the delta marker mode that displays marker values relative to a specified value.

## Marker Menu

The marker menu (Figure 6-3) is used to turn the display markers on or off, to designate the active marker, and to gain access to the marker delta mode and other marker modes and formats.

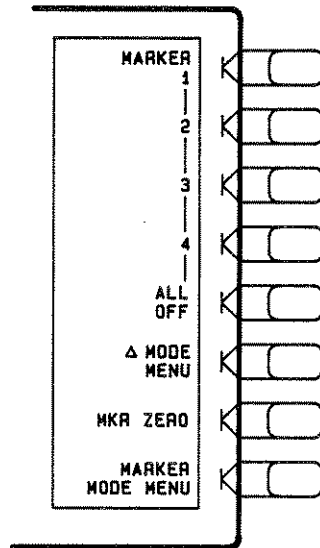

Figure 6-3

**[MARKER 1]** (MARK1) turns on marker 1 and makes it the active marker. The active marker appears on the CRT as  $\nabla$ . The active marker stimulus value is displayed in the active entry area, together with the marker number. If there is a marker turned on, and no other function is active, the stimulus value of the active marker can be controlled with the knob, the step keys, or the number pad. The marker response and stimulus values are displayed in the upper right-hand corner of the screen.

**[MARKER 2]** (MARK2) turns on marker 2 and makes it the active marker. If another marker is present, that marker becomes inactive and is represented on the CRT as  $\Delta$ .

**[MARKER 3]** (MARK3) turns on marker 3 and makes it the active marker.

**[MARKER 4]** (MARK4) turns on marker 4 and makes it the active marker.

**[ALL OFF]** (MARKOFF) turns off all the markers and the delta reference marker, as well as the tracking and bandwidth functions that are accessed with the **[MKR FCTN]** key.

**[ $\Delta$  MODE MENU]** goes to the delta marker menu, which is used to read the difference in values between the active marker and a reference marker.

**[MKR ZERO]** (MARKZERO) puts a fixed reference marker at the present active marker position, and makes the fixed marker stimulus and response values at that position equal to zero. All subsequent stimulus and response values of the active marker are then read out relative to the fixed marker. The fixed marker is shown on the CRT as a small triangle  $\Delta$  (delta), smaller than the inactive marker triangles. The softkey label changes from **[MKR ZERO]** to **[MKR ZERO  $\Delta$  REF =  $\Delta$ ]** and the notation " $\Delta$ REF= $\Delta$ " is displayed at the top right corner of the graticule. Marker zero is canceled by turning delta mode off in the delta marker menu or turning all the markers off with the **[ALL OFF]** softkey.

**[MARKER MODE MENU]** provides access to the marker mode menu, where several marker modes can be selected including special markers for polar and Smith formats.

## Delta Marker Mode Menu

The delta marker mode is used to read the difference in stimulus and response values between the active marker and a designated delta reference marker. Any of the four markers or a fixed point can be designated as the reference marker. If the reference is one of the four markers, its stimulus value can be controlled by the user and its response value is the value of the trace at that stimulus value. If the reference is a fixed marker, both its stimulus value and its response value can be set arbitrarily by the user anywhere in the display area. The delta reference is shown on the CRT as a small triangle  $\Delta$  (delta), smaller than the inactive marker triangles. If one of the markers is the reference, the triangle appears next to the marker number on the trace.

The marker values displayed in this mode are the stimulus and response values of the active marker minus the reference marker. If the active marker is also designated as the reference marker, the marker values are zero.

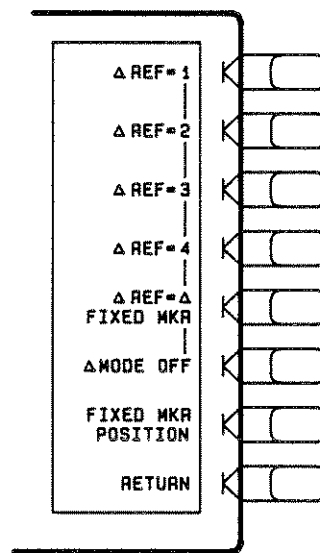

Figure 6-4. Delta Marker Mode Menu

[ $\Delta$  REF = 1] (DELR1) establishes marker 1 as a reference. The active marker stimulus and response values are then shown relative to this delta reference. Once marker 1 has been selected as the delta reference, the softkey label [ $\Delta$  REF = 1] is underlined in this menu, and the marker menu is returned to the screen. In the marker menu, the first key is now labeled [MARKER  $\Delta$  REF = 1]. The notation " $\Delta$ REF=1" appears at the top right corner of the graticule.

[ $\Delta$  REF = 2] (DELR2) makes marker 2 the delta reference. Active marker stimulus and response values are then shown relative to this reference.

[ $\Delta$  REF = 3] (DELR3) makes marker 3 the delta reference.

[ $\Delta$  REF = 4] (DELR4) makes marker 4 the delta reference.

**[ $\Delta$  REF =  $\Delta$  FIXED MKR]** (DELRFIXM) sets a user-specified fixed reference marker. The stimulus and response values of the reference can be set arbitrarily, and can be anywhere in the display area. Unlike markers 1 to 4, the fixed marker need not be on the trace. The fixed marker is indicated by a small triangle  $\Delta$ , and the active marker stimulus and response values are shown relative to this point. The notation " $\Delta$ REF= $\Delta$ " is displayed at the top right corner of the graticule.

Pressing this softkey turns on the fixed marker. Its stimulus and response values can then be changed using the fixed marker menu, which is accessed with the **[FIXED MKR POSITION]** softkey described below. Alternatively, the fixed marker can be set to the current active marker position, using the **[MKR ZERO]** softkey in the marker menu.

**[ $\Delta$  MODE OFF]** (DELO) turns off the delta marker mode, so that the values displayed for the active marker are absolute values.

**[FIXED MKR POSITION]** leads to the fixed marker menu, where the stimulus and response values for a fixed reference marker can be set arbitrarily.

Alternatively, the current position of the active marker can be entered as the fixed reference by using **[MARKER ZERO]** in the marker menu.

**[RETURN]** goes back to the marker menu.

## Fixed Marker Menu

This menu is used to set the position of a fixed reference marker, indicated on the display by a small triangle  $\Delta$ . Both the stimulus value and the response value of the fixed marker can be set arbitrarily anywhere in the display area, and need not be on the trace. The units are determined by the display format, the sweep type, and the marker type.

There are two ways to turn on the fixed marker. One way is with the **[ $\Delta$  REF =  $\Delta$  FIXED MKR]** softkey in the delta marker menu. The other is with the **[MKR ZERO]** function in the marker menu, which puts a fixed reference marker at the present active marker position and makes the marker stimulus and response values at that position equal to zero.

The softkeys in this menu make the values of the fixed marker the active function. The marker readings in the top right corner of the graticule are the stimulus and response values of the active marker minus the fixed reference marker. Also displayed in the top right corner is the notation " $\Delta$ REF= $\Delta$ ."

The stimulus value, response value, and auxiliary response value (the second part of a complex data pair) can be individually examined and changed. This allows active marker readings that are relative in amplitude yet absolute in frequency, or any combination of relative/absolute readouts. Following a **[MKR ZERO]** operation, this menu can be used to reset any of the fixed marker values to absolute zero for absolute readings of the subsequent active marker values.

If the format is changed while a fixed marker is on, the fixed marker values become invalid. For example, if the value offset is set to 10 dB with a log magnitude format, and the format is then changed to phase, the value offset becomes 10 degrees. However, in polar and Smith chart formats, the specified values remain consistent between different marker types for those formats. Thus an R+jX marker set on a Smith chart format will retain the equivalent values if it is changed to any of the other Smith chart markers.

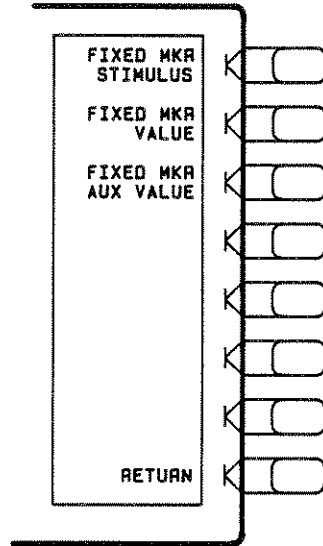

Figure 6-5. The Fixed Marker Menu

**[FIXED MKR STIMULUS]** (MARKFSTI) changes the stimulus value of the fixed marker. Fixed marker stimulus values can be different for the two channels if the channel markers are uncoupled using the marker mode menu.

To read absolute active marker stimulus values following a **[MKR ZERO]** operation, the stimulus value can be reset to zero.

**[FIXED MKR VALUE]** (MARKFVAL) changes the response value of the fixed marker. In a Cartesian format this is the y-axis value. In a polar or Smith chart format with a magnitude/phase marker, a real/imaginary marker, an  $R+jX$  marker, or a  $G+jB$  marker, this applies to the first part of the complex data pair. Fixed marker response values are always uncoupled in the two channels.

To read absolute active marker response values following a **[MKR ZERO]** operation, the response value can be reset to zero.

**[FIXED MKR AUX VALUE]** (MARKFAUV) is used only with a polar or Smith format. It changes the auxiliary response value of the fixed marker. This is the second part of a complex data pair, and applies to a magnitude/phase marker, a real/imaginary marker, an  $R+jX$  marker, or a  $G+jB$  marker. Fixed marker auxiliary response values are always uncoupled in the two channels.

To read absolute active marker auxiliary response values following a **[MKR ZERO]** operation, the auxiliary value can be reset to zero.

**[RETURN]** goes back to the delta marker menu.

## Marker Mode Menu

This menu provides different marker modes and makes available two additional menus of special markers for use with Smith chart or polar formats.

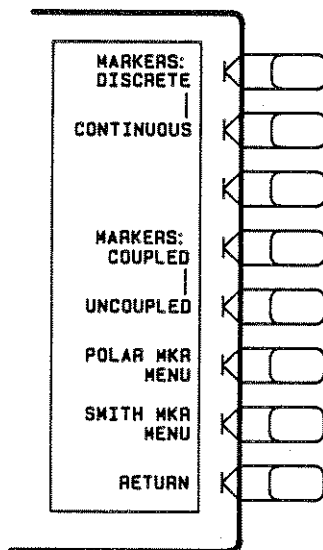

Figure 6-6

**[MARKERS: DISCRETE]** (MARKDISC) places markers only on measured trace points determined by the stimulus settings.

**[CONTINUOUS]** (MARKCONT) interpolates between measured points to allow the markers to be placed at any point on the trace. Displayed marker values are also interpolated. This is the default marker mode.

**[MARKERS: COUPLED]** (MARKCOUP) couples the marker stimulus values for the two display channels. Even if the stimulus is uncoupled and two sets of stimulus values are shown, the markers track the same stimulus values on each channel as long as they are within the displayed stimulus range.

**[UNCOUPLED]** (MARKUNCO) allows the marker stimulus values to be controlled independently on each channel.

**[POLAR MKR MENU]** leads to a menu of special markers for use with a polar format.

**[SMITH MKR MENU]** leads to a menu of special markers for use with a Smith chart format.

**[RETURN]** goes back to the marker menu.

## Polar Marker Menu

This menu is used only with a polar display format, selectable using the **[FORMAT]** key. In a polar format, the magnitude at the center of the circle is zero and the outer circle is the full scale value set in the scale reference menu. Phase is measured as the angle counterclockwise from  $0^\circ$  at the positive x-axis. The HP 8753B automatically calculates different mathematical forms of the marker magnitude and phase values, selected using the softkeys in this menu. Marker frequency is displayed in addition to other values regardless of the selection of marker type.

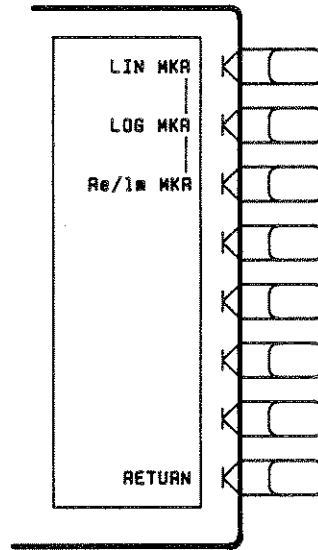

Figure 6-7

**[LIN MKR]** (POLMLIN) displays a readout of the linear magnitude and the phase of the active marker. This is the preset marker type for a polar display. Magnitude values are read in units and phase in degrees.

**[LOG MKR]** (POLMLOG) displays the logarithmic magnitude and the phase of the active marker. Magnitude values are expressed in dB and phase in degrees. This is useful as a fast method of obtaining a reading of the log magnitude value without changing to log magnitude format.

**[Re/Im MKR]** (POLMRI) displays the values of the active marker as a real and imaginary pair. The complex data is separated into its real part and imaginary part. The first marker value given is the real part  $M \cos \theta$ , and the second value is the imaginary part  $M \sin \theta$ , where  $M$  = magnitude.

**[RETURN]** goes back to the marker mode menu.

## Smith Marker Menu

This menu is used only with a Smith chart format, selected from the format menu. The HP 8753B automatically calculates different mathematical forms of the marker magnitude and phase values, selected using the softkeys in this menu. Marker frequency is displayed in addition to other values for all marker types.

For additional information about the Smith chart display format, refer to *[FORMAT]* Key.

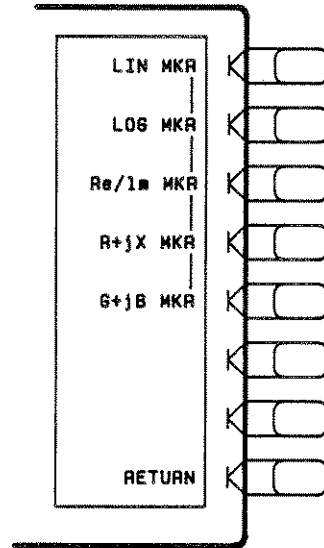

Figure 6-8

**[LIN MKR]** (SMIMLIN) displays a readout of the linear magnitude and the phase of the active marker. Marker magnitude values are expressed in units and phase in degrees.

**[LOG MKR]** (SMIMLOG) displays the logarithmic magnitude value and the phase of the active marker. Magnitude values are expressed in dB and phase in degrees. This is useful as a fast method of obtaining a reading of the log magnitude value without changing to log magnitude format.

**[Re/Im MKR]** (SMIMRI) displays the values of the active marker on a Smith chart as a real and imaginary pair. The complex data is separated into its real part and imaginary part. The first marker value given is the real part  $M \cos \theta$ , and the second value is the imaginary part  $M \sin \theta$ , where  $M$  = magnitude.

**[R+jX MKR]** (SMIMRX) converts the active marker values into rectangular form. The complex impedance values of the active marker are displayed in terms of resistance, reactance, and equivalent capacitance or inductance. This is the default Smith chart marker.

The normalized impedance  $Z_0$  for characteristic impedances other than 50 ohms can be selected in the calibrate more menu (chapter 5).

**[G+jB MKR]** (SMIMGB) displays the complex admittance values of the active marker in rectangular form. The active marker values are displayed in terms of conductance (in Siemens), susceptance, and equivalent capacitance or inductance. Siemens are the international units of admittance, and are equivalent to mhos (the inverse of ohms).

**[RETURN]** goes back to the marker mode menu.



## [MKR FCTN] KEY

The [MKR FCTN] (MENUMRKF) key activates a marker if one is not already active, and provides access to additional marker functions. These can be used to quickly change the measurement parameters, to search the trace for specified information, and to analyze the trace statistically.

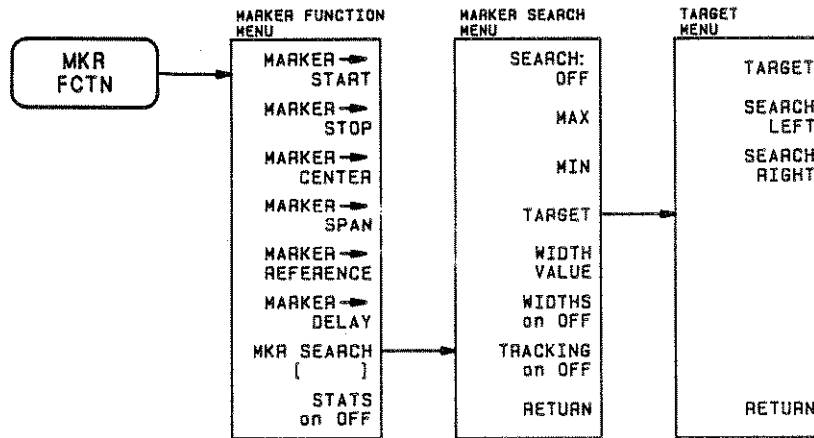

Figure 6-9. Menus Accessed from the [MKR FCTN] Key

## Marker Function Menu

This menu provides softkeys that use markers to quickly modify certain measurement parameters without going through the usual key sequence. In addition, it provides access to two additional menus used for searching the trace and for statistical analysis.

The [MARKER →] functions change certain stimulus and response parameters to make them equal to the current active marker value. Use the knob or the keypad to move the marker to the desired position on the trace, and press the appropriate softkey to set the specified parameter to that trace value. When the values have been changed, the marker can again be moved within the range of the new parameters.

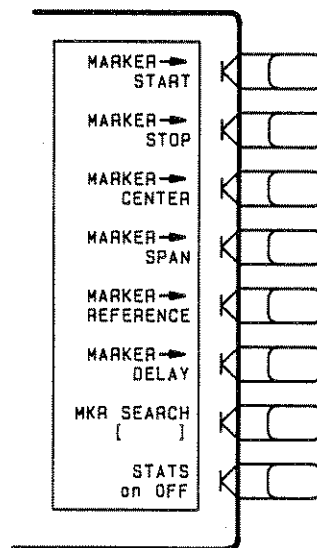

Figure 6-10

**[MARKER → START]** (MARKSTAR) changes the stimulus start value to the stimulus value of the active marker.

**[MARKER → STOP]** (MARKSTOP) changes the stimulus stop value to the stimulus value of the active marker.

**[MARKER → CENTER]** (MARKCENT) changes the stimulus center value to the stimulus value of the active marker, and centers the new span about that value.

**[MARKER → SPAN]** (MARKSPAN) changes the start and stop values of the stimulus span to the values of the active marker and the delta reference marker. If there is no reference marker, the message "NO MARKER DELTA – SPAN NOT SET" is displayed.

**[MARKER → REFERENCE]** (MARKREF) makes the reference value equal to the active marker's response value, without changing the reference position. In a polar or Smith chart format, the full scale value at the outer circle is changed to the active marker response value. This softkey also appears in the scale reference menu.

**[MARKER → DELAY]** (MARKDELA) adjusts the electrical delay to balance the phase of the DUT. This is performed automatically, regardless of the format and the measurement being made. Enough line length is added to or subtracted from the receiver input to compensate for the phase slope at the active marker position. This effectively flattens the phase trace around the active marker, and can be used to measure electrical length or deviation from linear phase. Additional electrical delay adjustments are required on DUTs without constant group delay over the measured frequency span. Since this feature adds phase to a variation in phase versus frequency, it is applicable only for ratioed inputs. This softkey also appears in the scale reference menu.

**NOTE:** A new marker function, **[MARKER → CW]**, is available in the test sequence function softkey menus described in Chapter 13. This feature is intended for use in automated compression measurements. Test sequences allow the instrument to automatically find a maximum or minimum point on a response trace. The **[MARKER → CW]** command sets the instrument to the CW frequency of the active marker. When power sweep is engaged, the CW frequency will already be selected.

**[MARKER SEARCH]** leads to the marker search menu, which is used to search the trace for a particular value or bandwidth.

**[STATS on OFF]** (MEASTATON, MEASTATOFF) calculates and displays the mean, standard deviation, and peak-to-peak values of the section of the displayed trace between the active marker and the delta reference marker. If there is no delta reference, the statistics are calculated for the entire trace. A convenient use of this feature is to find the peak-to-peak value of passband ripple without searching separately for the maximum and minimum values.

The statistics are absolute values: the delta marker here serves to define the span. For polar and Smith formats the statistics are calculated using the first value of the complex pair (magnitude, real part, resistance, or conductance).

## Marker Search Menu

This menu is used to search the trace for a specific amplitude-related point, and place the marker on that point. The capability of searching for a specified bandwidth is also provided. Tracking is available for a continuous sweep-to-sweep search. If there is no occurrence of a specified value or bandwidth, the message "TARGET VALUE NOT FOUND" is displayed.

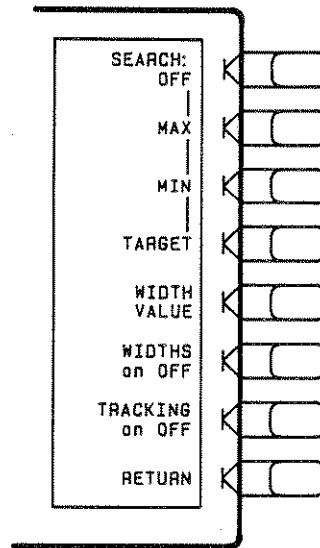

Figure 6-11

**[SEARCH: OFF]** (SEAOFF) turns off the marker search function.

**[MAX]** (SEAMAX) moves the active marker to the maximum point on the trace.

**[MIN]** (SEAMIN) moves the active marker to the minimum point on the trace.

**[TARGET]** (SEATARG) makes target value the active function, and places the active marker at a specified target point on the trace. The default target value is  $-3$  dB. The target menu is presented, providing search right and search left options to resolve multiple solutions.

For relative measurements, a search reference must be defined with a delta marker or a fixed marker before the search is activated.

**[WIDTH VALUE]** (WIDV) is used to set the amplitude parameter (for example 3 dB) that defines the start and stop points for a bandwidth search. The bandwidth search feature analyzes a bandpass or band reject trace and calculates the center point, bandwidth, and Q (quality factor) for the specified bandwidth. Bandwidth units are the units of the current format.

**[WIDTHS on OFF]** (WIDTON, WIDTOFF) turns on the bandwidth search feature and calculates the center stimulus value, bandwidth, and Q of a bandpass or band reject shape on the trace. The amplitude value that defines the passband or rejectband is set using the **[WIDTH VALUE]** softkey.

All four markers are turned on, and each has a dedicated use. Marker 1 is a starting point from which the search is begun. Marker 2 goes to the bandwidth center point. Marker 3 goes to the bandwidth cutoff point on the left, and marker 4 to the cutoff point on the right.

If a delta marker or fixed marker is on, it is used as the reference point from which the bandwidth amplitude is measured. For example, if marker 1 is the delta marker and is set at the passband maximum, and the width value is set to  $-3$  dB, the bandwidth search finds the bandwidth cutoff points 3 dB below the maximum and calculates the 3 dB bandwidth and Q.

If marker 2 (the dedicated bandwidth center point marker) is the delta reference marker, the search finds the points 3 dB down from the center.

If no delta reference marker is set, the bandwidth values are absolute values.

**[TRACKING on OFF]** (TRACKON, TRACKOFF) is used in conjunction with other search features to track the search with each new sweep. Turning tracking on makes the HP 8753B search every new trace for the specified target value and put the active marker on that point. If bandwidth search is on, tracking searches every new trace for the specified bandwidth, and repositions the dedicated bandwidth markers.

When tracking is off, the target is found on the current sweep and remains at the same stimulus value regardless of changes in trace response value with subsequent sweeps.

A maximum and a minimum point can be tracked simultaneously using two channels and uncoupled markers.

**[RETURN]** goes back to the marker function menu.

## Target Menu

The target menu places the marker at a specified target response value on the trace, and provides search right and search left options. If there is no occurrence of the specified value, the message "TARGET VALUE NOT FOUND" is displayed.

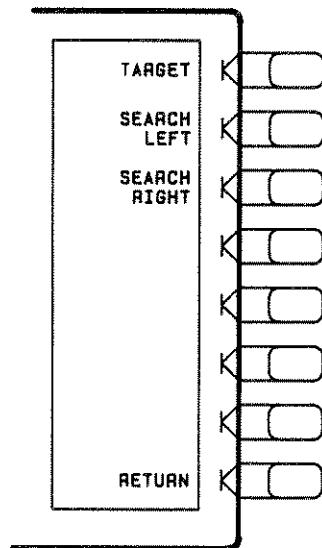

Figure 6-12

**[TARGET]** (SEATARG) places the marker at the specified target response value. If tracking is on (see previous menu) the target is automatically tracked with each new trace. If tracking is off, the target is found each time this key is pressed. The target value is in units appropriate to the current format. The default target value is  $-3$  dB.

In delta marker mode, the target value is the value relative to the reference marker. If no delta reference marker is on, the target value is an absolute value.

**[SEARCH LEFT]** (SEAL) searches the trace for the next occurrence of the target value to the left.

**[SEARCH RIGHT]** (SEAR) searches the trace for the next occurrence of the target value to the right.

**[RETURN]** goes back to the marker search menu.



# Chapter 7. Instrument State Function Block

## CHAPTER CONTENTS

- 7-1 Introduction
- 7-2 Instrument State Functions and Where They Are Described
- 7-2 [LOCAL] Key
- 7-3 HP-IB Menu
- 7-5 Address Menu
- 7-7 [SYSTEM] Key
- 7-8 Limit Lines and Limit Testing
- 7-10 Limits Menu
- 7-12 Edit Limits Menu
- 7-13 Edit Segment Menu
- 7-15 Limit Type Menu
- 7-16 Offset Limits Menu

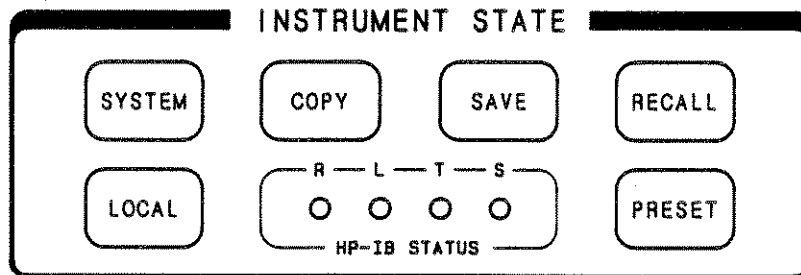

Figure 7-1

## INTRODUCTION

The instrument state function block keys and associated menus provide control of channel-independent system functions. These include instrument modes, sequencing, controller modes, instrument addresses, HP-IB status information, plotting or printing, and saving instrument states either in internal memory or on an external disc.

## INSTRUMENT STATE FUNCTIONS AND WHERE THEY ARE DESCRIBED

Functions accessible in the instrument state function block are described in several different chapters of this *Operating and Programming Reference*, and in portions of the *On-Site System Service Manual*.

Table 7-1 lists each function and where it is discussed. Unless otherwise noted, all references are in this *Operating and Programming Reference* and are marked with the acronym "OPR".

Table 7-1. Instrument State Functions and Where They Are Described

| Instrument State Key | Function                                                                                                                                                                                                                               | Chapter or Manual                                                                                                                                                                        |
|----------------------|----------------------------------------------------------------------------------------------------------------------------------------------------------------------------------------------------------------------------------------|------------------------------------------------------------------------------------------------------------------------------------------------------------------------------------------|
| [SYSTEM]             | 6 GHz Operation (option 006)<br>Test Sequence Function<br>Limit Lines and Limit Testing<br>Time Domain Transform<br>Harmonic Measurements<br>External Source Mode<br>Tuned Receiver Mode<br>Frequency Offset Operation<br>Service Menu | Chapter 14, OPR<br>Chapter 13, OPR<br>This Chapter<br>Chapter 8, OPR<br>Chapter 14, OPR<br>Chapter 14, OPR<br>Chapter 14, OPR<br>Chapter 14, OPR<br><i>On-Site System Service Manual</i> |
| [COPY]               | All Features – including printing and plotting                                                                                                                                                                                         | Chapter 9, OPR                                                                                                                                                                           |
| [SAVE]               | All Features – including saving instrument states and saving to external disc.                                                                                                                                                         | Chapter 10, OPR                                                                                                                                                                          |
| [RECALL]             | All Features – including recall of instrument state, and recall from external disc drive.                                                                                                                                              | Chapter 10, OPR                                                                                                                                                                          |
| [LOCAL]              | All Features – including HP-IB and address menus.                                                                                                                                                                                      | This Chapter                                                                                                                                                                             |
| [PRESET]             | Preset State                                                                                                                                                                                                                           | Appendix A, OPR                                                                                                                                                                          |

### [LOCAL KEY]

This key is used to return the HP 8753B to local (front panel) operation from remote (computer controlled) operation. This key will also abort a test sequence or hardcopy print/plot. In this local mode, with a controller still connected on HP-IB, the HP 8753B can be operated manually (locally) from the front panel. This is the only front panel key that is not disabled when the HP 8753B is remotely controlled over HP-IB by a computer. The exception to this is when local lockout is in effect: this is a remote command that disables the [LOCAL] key, making it difficult to interfere with the HP 8753B while the network analyzer is under computer control.

In addition, this key gives access to the HP-IB menu, which sets the controller mode, and to the address menu, where the HP-IB addresses of peripheral devices are entered.



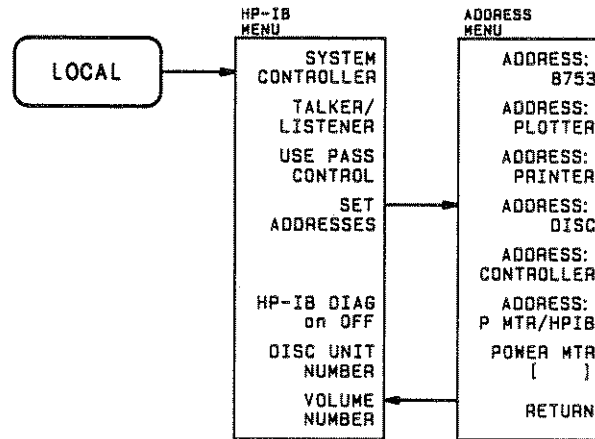

Figure 7-2. Softkey Menus Accessed from the [LOCAL] Key

## HP-IB Menu

The HP 8753B is factory-equipped with a remote programming interface using the Hewlett-Packard Interface Bus (HP-IB). This enables communication between the HP 8753B and a controlling computer as well as other peripheral devices. This menu indicates the present HP-IB controller mode of the HP 8753B. Three HP-IB modes are possible: system controller, talker/listener, and pass control.

Talker/listener is the mode of operation most often used. In this mode, a computer controller communicates with the HP 8753B and other compatible peripherals over the bus. The computer sends commands or instructions to and receives data from the HP 8753B. All of the capabilities available from the HP 8753B front panel can be used in this remote operation mode, except for control of the power line switch and some internal tests.

In the system controller mode, the HP 8753B itself can use HP-IB to control compatible peripherals, without the use of an external computer. It can output measurement results directly to a compatible printer or plotter, store instrument states using a compatible disc drive, or control a power meter for performing service routines. The power meter calibration function requires system controller or pass control mode.

A third mode of HP-IB operation is the pass control mode. In an automated system with a computer controller, the controller can pass control of the bus to the HP 8753B on request from the network analyzer. The HP 8753B is then the controller of the peripherals, and can direct them to plot, print, or store without going through the computer. When the peripheral operation is complete, control is passed back to the computer. Only one controller can be active at a time. The computer remains the system controller, and can regain control at any time.

Preset does not affect the selected controller mode, but cycling the power returns the HP 8753B to talker/listener mode.

Information on compatible peripherals is provided in the *General Information and Specifications* section of this manual.

**HP-IB Status Indicators.** When the HP 8753B is connected to other instruments over HP-IB, the HP-IB STATUS indicators in the instrument state function block light up to display the current status of the HP 8753B.

- R = Remote operation.
- L = Listen mode.
- T = Talk mode.
- S = Service request (SRQ) asserted by the HP 8753B.

Information on HP-IB operation is provided in Chapter 11.

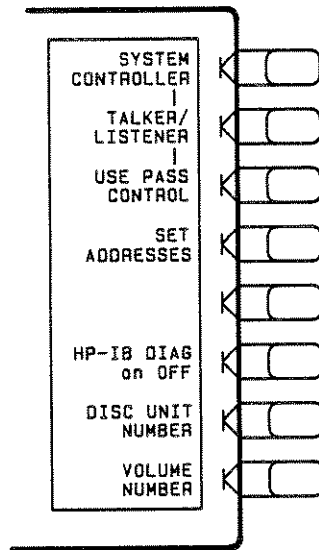

Figure 7-3. HP-IB Menu

**[SYSTEM CONTROLLER]** is the mode used when peripheral devices are to be used and there is no external controller. In this mode, the HP 8753B can directly control peripherals (plotter, printer, disc drive, or power meter). System controller mode must be set in order for the HP 8753B to access peripherals from the front panel to plot, print, store on disc, or perform power meter functions, if there is no other controller on the bus.

The system controller mode can be used without knowledge of HP-IB programming. However, the HP-IB address must be entered for each peripheral device.

This mode can only be selected manually from the network analyzer front panel, and can be used only if no active computer controller is connected to the system through HP-IB. If you try to set system controller mode when another controller is present, the message "CAUTION: CAN'T CHANGE - ANOTHER CONTROLLER ON BUS" is displayed. Do not attempt to use this mode for programming.

**[TALKER/LISTENER]** (TALKLIST) is the mode normally used for remote programming of the HP 8753B. In this mode, the HP 8753B and all peripheral devices are controlled from the external controller. The controller can command the HP 8753B to talk, and the plotter or other device to listen. The HP 8753B and peripheral devices cannot talk directly to each other unless the computer sets up a data path between them.

This mode allows the HP 8753B to be either a talker or a listener, as required by the controlling computer for the particular operation in progress.

A talker is a device capable of sending out data when it is addressed to talk. There can be only one talker at any given time. The HP 8753B is a talker when it sends information over the bus.

A listener is a device capable of receiving data when it is addressed to listen. There can be any number of listeners at any given time. The HP 8753B is a listener when it is controlled over the bus by a computer.

**[USE PASS CONTROL]** (USEPASC) lets you control the HP 8753B with the computer over HP-IB as with the talker/listener mode, and also allows the HP 8753B to become a controller in order to plot, print, or directly access an external disc. During this peripheral operation, the host computer is free to perform other internal tasks that do not require use of the bus (the bus is tied up by the network analyzer during this time).

The pass control mode requires that the external controller is programmed to respond to a request for control and to issue a take control command. When the peripheral operation is complete, the HP 8753B passes control back to the computer. Refer to the *HP-IB Introductory Programming Guide* for more information.

In general, use the talker/listener mode for programming the HP 8753B unless direct peripheral access is required.

**[SET ADDRESSES]** goes to the address menu, which is used to set the HP-IB address of the HP 8753B, and to display and modify the addresses of peripheral devices in the system.

**[HP-IB DIAG on off]** (DEBUON, DEBUOFF) toggles the HP-IB diagnostic feature (debug mode). This mode should only be used the first time a program is written: if a program has already been debugged, it is unnecessary.

When diagnostics are on, the network analyzer scrolls a history of incoming HP-IB commands across the display in the title line. Nonprintable characters are represented as  $\pi$ . If a syntax error is received, the commands halt and a pointer  $\wedge$  indicates the misunderstood character. To clear a syntax error, refer to the *HP-IB Introductory Programming Guide*.

**[DISC UNIT NUMBER]** (DISCUNIT) specifies the number of the disc unit in the disc drive that is to be accessed in an external disc store or load routine. This is used in conjunction with the HP-IB address of the disc drive, and the volume number, to gain access to a specific area on a disc. The access hierarchy is HP-IB address, disc unit number, disc volume number. More information on storing information to an external disc is provided in Chapter 10, *Saving Instrument States*.

**[VOLUME NUMBER]** (DISCVOLU) specifies the number of the disc volume to be accessed. In general, all 3.5 inch floppy discs are considered one volume (volume 0). For hard disc drives, such as the HP 9153A (Winchester), a switch in the disc drive must be set to define the number of volumes on the disc. For more information, refer to the manual for the individual hard disc drive.

## Address Menu

In communications through the Hewlett-Packard Interface Bus (HP-IB), each instrument on the bus is identified by an HP-IB address. This decimal-based address code must be different for each instrument on the bus.

This menu sets the HP-IB address of the HP 8753B, and to enter the addresses of peripheral devices so that the HP 8753B can communicate with them.

Most of the HP-IB addresses are set at the factory and need not be modified for normal system operation. The standard factory-set addresses for instruments that may be part of the system are as follows:

| Instrument          | HP-IB Address (decimal) |
|---------------------|-------------------------|
| HP 8753B            | 16                      |
| Plotter             | 05                      |
| Printer             | 01                      |
| External Disc Drive | 00                      |
| Controller          | 21                      |
| Power Meter         | 13                      |

The address displayed in this menu for each peripheral device must match the address set on the device itself. If the addresses do not match, they can be matched in one of two ways. Either the address in the HP 8753B softkey label for the device can be modified using the entry controls; or the address of the device can be changed using instructions provided in the device's manual. The HP 8753B does not have an HP-IB switch: its address is set only from the front panel.

These addresses are stored in short-term non-volatile memory and are not affected by preset or by cycling the power.

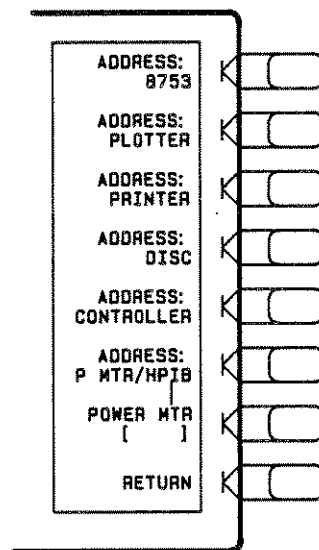

Figure 7-4. Address Menu

**[ADDRESS: 8753]** sets the HP-IB address of the HP 8753B, using the entry controls. There is no physical address switch to set in the HP 8753B.

**[ADDRESS: PLOTTER]** (ADDRPLOT) sets the HP-IB address the HP 8753B will use to communicate with the plotter.

**[ADDRESS: PRINTER]** (ADDRPRIN) sets the HP-IB address the HP 8753B will use to communicate with the printer.

**[ADDRESS: DISC]** (ADDRDISC) sets the HP-IB address the HP 8753B will use to communicate with the disc drive.

**[ADDRESS: CONTROLLER]** (ADDRCONT) sets the HP-IB address the HP 8753B will use to communicate with the external controller.

**[ADDRESS: P MTR/HPIB]** (ADDRPOWM) sets the HP-IB address the HP 8753B will use to communicate with the power meter used in service routines.

**[POWER MTR]** (POWM) toggles between **[436A]** or **[438A/437]**. These power meters are HP-IB compatible with the HP 8753B. The model number in the softkey label must match the power meter to be used.

**[RETURN]** goes back to the HP-IB menu.

## **[SYSTEM] KEY (MENUSYST)**

This key presents the system menu.

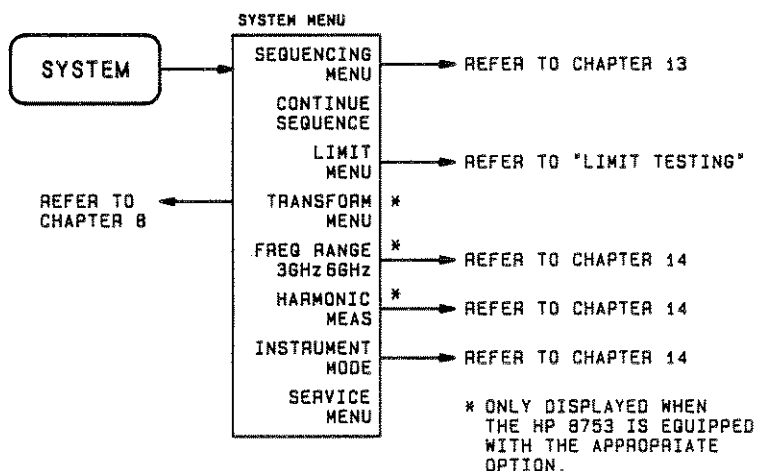

Figure 7-5. The System Menu

**[SEQUENCING MENU]** leads to the test sequence function menus. Sequencing allows the operator to define a series of test keystrokes which may then be run automatically. This function is described in Chapter 13.

**[LIMIT MENU]** leads to a series of menus used to define limits or specifications with which to compare a test device. Refer to *Limit Lines and Limit Testing*.

**[TRANSFORM MENU]** (option 010) leads to a series of menus that transform the measured data from the frequency domain to the time domain. Time domain modes and features are explained in Chapter 8, *Time and Frequency Domain Transforms*. This softkey is present only in instruments purchased with option 010.

**[FREQ RANGE 3GHz 6GHz]** (option 006) only appears on the menu if an HP 85047A 6 GHz test set is connected to the HP 8753B. This softkey toggles the system between a maximum frequency of 3 and 6 GHz. Refer to Chapter 14.

**[HARMONIC MEASUREMENTS]** (option 002 only) leads to the harmonics menu. This feature phase locks to the 2nd or 3rd harmonic of the fundamental signal. Measured harmonics can not exceed the frequency range of the HP 8753B receiver. Refer to Chapter 14.

**[INSTRUMENT MODE]** presents the instrument mode menu. This provides access to the primary modes of operation (analyzer modes), each of which is described fully in Chapter 14. The following is a list of available instrument (analyzer) modes:

- Network Analyzer. This is the “normal” operating mode.
- External Source Auto. This allows the HP 8753B to phase lock to an external CW signal. This feature works only in CW time sweep type. The external source auto mode searches for the incoming CW signal. The search range is  $\pm 10\%$  of the selected CW frequency ( $\pm 5$  MHz below 50 MHz). The manual mode does not have this search capability, and the incoming signal must be within  $-0.5$  to  $+5.0$  MHz of the entered frequency value. The manual mode is faster than the auto mode.

The external source should not exhibit noise or significant sidebands, as the HP 8753B may phase-lock onto a spur instead of the fundamental.

- External Source Manual. This allows the HP 8753B to phase lock to an external CW signal. This feature works only in CW time sweep type. The incoming signal should not have large spurs or sidebands for the reason explained above. This mode is faster than the auto mode, but it does not search for the incoming signal. The frequency of the incoming signal should be within  $-0.5$  to  $+5.0$  MHz of the selected frequency or the HP 8753B will not be able to phase lock to it.
- Tuned Receiver. In this mode the receiver operates independently of any source. All phase lock routines are bypassed, increasing sweep speed significantly. This function only works in CW time sweep. The external source must be synthesized and drive the HP 8753B's external frequency reference. Refer to Chapter 14.

In Addition to the above instrument modes, frequency offset operation is available under the **[INSTRUMENT MODE]** softkey. Frequency offset is a feature of the network analyzer mode, it is not an instrument mode itself. The HP 8753B must be in network analyzer mode before frequency offset can be turned on.

- Frequency Offset. This allows phase locked operation with a frequency offset between the internal source and receiver. In a typical mixer application; the internal source is input to the mixer's RF input, an external source is input to the mixer's LO input, and the resultant IF signal is input to the receiver. The upper frequency limit of this function is 3 GHz. When using frequency offset mode, the frequency of the internal source must be greater than the LO frequency. Both of these frequencies must be greater than the IF used for phase-locking.

**[SERVICE MENU]** leads to a series of service menus described in detail in the *On-Site System Service Manual*.

## LIMIT LINES AND LIMIT TESTING

Limit lines are lines drawn on the CRT to represent upper and lower limits or device specifications with which to compare the device under test. Limits are defined in segments, where each segment is a portion of the stimulus span. Each limit segment has an upper and a lower starting limit value. Three types of segments are available: flat line, sloping line, and single point.

Limits can be defined independently for the two channels, up to 18 segments for each channel (a total of 36 for both channels). These can be in any combination of the three limit types.

Limit testing compares the measured data with the defined limits, and provides pass or fail information for each measured data point. An out-of-limit test condition is indicated in five ways: with a FAIL message on the screen, with a beep, by blanking of portions of the trace, with an asterisk in tabular listings of data, and with a bit in the HP-IB event status register B. An HP 85047A test set has a BNC output that includes this status.

Limit lines and limit testing can be used simultaneously or independently. If limit lines are on and limit testing is off, the limit lines are displayed on the CRT for visual comparison and adjustment of the measurement trace. However, no pass/fail information is provided. If limit testing is on and limit lines are off, the specified limits are still valid and the pass/fail status is indicated even though the limit lines are not displayed on the CRT.

Limits are entered in tabular form. Limit lines and limit testing can be either on or off while limits are defined. As new limits are entered, the tabular columns on the CRT are updated, and the limit lines (if on) are modified to the new definitions. The complete limit set can be offset in either stimulus or amplitude value.

Limits are checked only at the actual measured data points. It is possible for a device to be out of specification without a limit test failure indication if the point density is insufficient. Be sure to specify a high enough number of measurement points in the stimulus menu.

Limit lines are displayed only on Cartesian formats. In polar and Smith chart formats, limit testing of one value is available: the value tested depends on the marker mode and is the magnitude or the first value in a complex pair. The message "NO LIMIT LINES DISPLAYED" is shown on the CRT in polar and Smith formats.

The list values feature in the copy menu provides tabular listings to the CRT or a printer for every measured stimulus value. These include limit line and/or limit test information if these functions are turned on. If limit testing is on, an asterisk \* is listed next to any measured value that is out of limits. If limit lines are on, and other listed data allows sufficient space, the upper limit and lower limit are listed, together with the margin by which the device data passes or fails the nearest limit. For more information about the list values feature, refer to Chapter 9, *Making a Hard Copy Output*.

If limit lines are on, they are plotted with the data on a plot. If limit testing is on, the PASS or FAIL message is plotted, and the failing portions of the trace that are blanked on the CRT are also blanked on the plot. If limits are specified, they are saved in memory with an instrument state.

An example of a measurement using limit lines and limit testing is provided in the *User's Guide*.

The series of menus for defining limits is accessed from the **[SYSTEM]** key. These menus are illustrated in Figure 7-6.

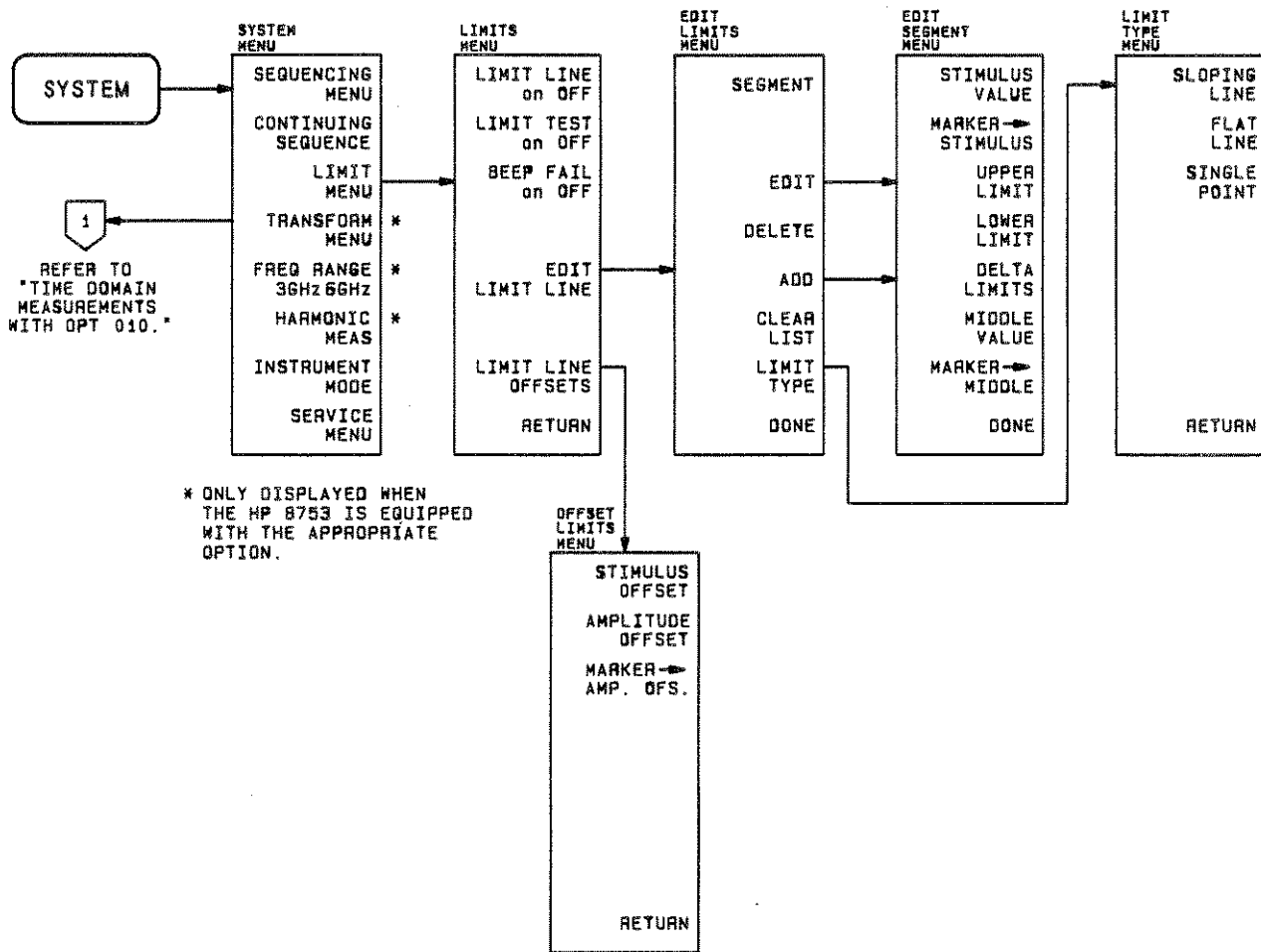

Figure 7-6. The Limit Softkey Menu Series

## Limits Menu

This menu independently toggles the limit lines, limit testing, and limit fail beeper. In addition, it leads to the menus used to define and modify the limits.



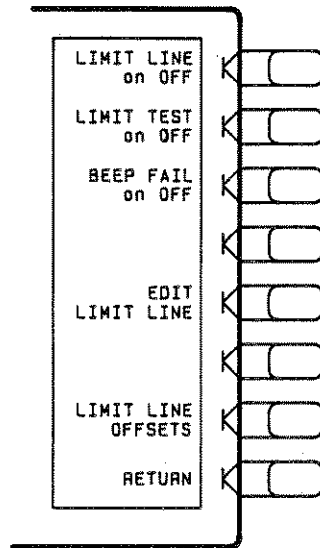

Figure 7-7

**[LIMIT LINE on OFF]** (LIMILINEON, LIMILINEOFF) turns limit lines on or off. To define limits, use the **[EDIT LIMIT LINE]** softkey described below. If limits have been defined and limit lines are turned on, the limit lines are displayed on the CRT for visual comparison of the measured data in all Cartesian formats.

If limit lines are on, they are plotted with the data on a plot, and saved in memory with an instrument state. In a listing of values from the copy menu with limit lines on, the upper limit and lower limit are listed together with the pass or fail margin, as long as other listed data allows sufficient space.

**[LIMIT TEST on OFF]** (LIMITESTON, LIMITESTOFF) turns limit testing on or off. When limit testing is on, the data is compared with the defined limits at each measured point. Limit tests occur at the end of each sweep, whenever the data is updated, when formatted data is changed, and when limit testing is first turned on.

Limit testing is available for both magnitude and phase values in Cartesian formats. In polar and Smith chart formats, the value tested depends on the marker mode and is the magnitude or the first value in a complex pair. The message "NO LIMIT LINES DISPLAYED" is displayed in polar and Smith formats if limit lines are turned on.

Five indications of pass or fail status are provided when limit testing is on. A PASS or FAIL message is displayed at the right of the CRT. The trace vector leading to any measured point that is out of limits is blanked at the end of every limit test, both on a CRT plot and a hard copy plot. The limit fail beeper sounds if it is turned on. In a listing of values using the copy menu, an asterisk \* is shown next to any measured point that is out of limits. A bit is set in the HP-IB status byte.

**[BEEP FAIL on OFF]** (BEEPFAILON, BEEPFAIloff) turns the limit fail beeper on or off. When limit testing is on and the fail beeper is on, a beep is sounded each time a limit test is performed and a failure detected. The limit fail beeper is independent of the warning beeper and the operation complete beeper, both of which are in the display more menu (Chapter 4).

**[EDIT LIMIT LINE]** (EDITLIML) displays a table of limit segments on the CRT, superimposed on the trace. The edit limits menu is presented so that limits can be defined or changed. It is not necessary for limit lines or limit testing to be on while limits are defined.

**[LIMIT LINE OFFSETS]** leads to the offset limits menu, which is used to offset the complete limit set in either stimulus or amplitude value.

**[RETURN]** goes back to the system menu.

## Edit Limits Menu

This menu is used to specify limits for limit lines and/or limit testing, and presents a table of limit values on the CRT. Limits are defined in segments. Each segment is a portion of the stimulus span. Up to 18 limit segments can be specified for each channel (a total of 36 for both channels). The limit segments do not have to be entered in any particular order: the HP 8753B automatically sorts them and lists them on the CRT in increasing order of start stimulus value.

For each segment, the table lists the segment number, the starting stimulus value, upper limit, lower limit, and limit type. The ending stimulus value is the start value of the next segment, or a segment can be terminated with a single point segment. Limit values are entered as upper and lower limits or delta limits and middle value. As new limit segments are defined the tabular listing is updated, and if limit lines are switched on they are plotted on the CRT.

If no limits have been defined, the table of limit values shows the notation "EMPTY." Limit segments are added to the table using the **[ADD]** softkey or edited with the **[EDIT]** softkey, as described below. The last segment on the list is followed by the notation "END."

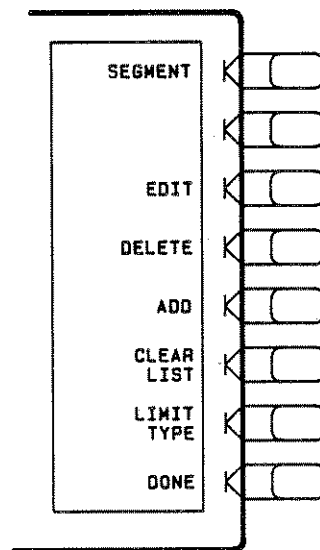

Figure 7-8. Edit Limits Menu

**[SEGMENT]** specifies which limit segment in the table is to be modified. A maximum of three sets of segment values are displayed at one time, and the list can be scrolled up or down to show other segment entries. Use the entry block controls to move the pointer > to the required segment number. The indicated segment can then be edited or deleted. If the table of limits is designated "EMPTY," new segments can be added using the **[ADD]** or **[EDIT]** softkey.

**[EDIT]** (SEDI) displays the edit segment menu, which is used to define or modify the stimulus value and limit values of a specified segment. If the table was empty, a default segment is displayed. The default segment is a sloping line with zero limits and stimulus values that vary according to the current stimulus mode (frequency, power, or time).

**[DELETE]** (SDEL) deletes the limit segment indicated by the pointer >.

**[ADD]** (SADD) displays the edit segment menu and adds a new segment to the end of the list. The new segment is initially a duplicate of the segment indicated by the pointer > and selected with the **[SEGMENT]** softkey. If the table was empty, a default segment is displayed, as described under **[EDIT]** above.

**[CLEAR LIST]** (CLEL) Clears all of the segments in the limit test.

**[LIMIT TYPE]** leads to the limit type menu, where one of three segment types can be selected.

**[DONE]** (EDITDONE) sorts the limit segments and displays them on the CRT in increasing order of stimulus value. The limits menu is returned to the screen.

## **Edit Segment Menu**

This menu sets the values of the individual limit segments. The segment to be modified, or a default segment, is selected in the edit limits menu. The stimulus value can be set with the controls in the entry block or with a marker (the marker is turned on automatically when this menu is presented). The limit values can be defined as upper and lower limits, or delta limits and middle value. Both an upper limit and a lower limit (or delta limits) must be defined: if only one limit is required for a particular measurement, force the other out of range (for example +500 dB or -500 dB).

As new values are entered, the tabular listing of limit values is updated.

Segments do not have to be listed in any particular order: the HP 8753B sorts them automatically in increasing order of start stimulus value when the **[DONE]** key in the edit limits menu is pressed. However, the easiest way to enter a set of limits is to start with the lowest stimulus value and define the segments from left to right of the display, with limit lines turned on as a visual check.

Phase limit values can be specified between +500° and -500°. Limit values above +180° and below -180° are mapped into the range of -180° to +180° to correspond with the range of phase data values.

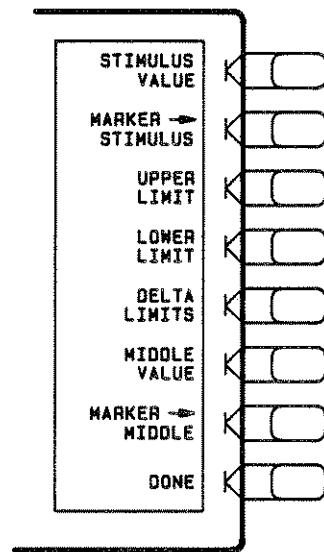

Figure 7-9. Edit Segment Menu

**[STIMULUS VALUE]** (LIMS) sets the starting stimulus value of a segment, using entry block controls. The ending stimulus value of the segment is defined by the start of the next line segment. No more than one segment can be defined over the same stimulus range.

**[MARKER → STIMULUS]** (MARKSTIM) sets the starting stimulus value of a segment using the active marker. Move the marker to the desired starting stimulus value before pressing this key, and the marker stimulus value is entered as the segment start value.

**[UPPER LIMIT]** (LIMU) sets the upper limit value for the start of the segment. If a lower limit is specified, an upper limit must also be defined. If no upper limit is required for a particular measurement, force the upper limit value out of range (for example +500 dB).

When **[UPPER LIMIT]** or **[LOWER LIMIT]** is pressed, all the segments in the table are displayed in terms of upper and lower limits, even if they were defined as delta limits and middle value.

If you attempt to set an upper limit that is lower than the lower limit, or vice versa, both limits will be automatically set to the same value.

**[LOWER LIMIT]** (LIML) sets the lower limit value for the start of the segment. If an upper limit is specified, a lower limit must also be defined. If no lower limit is required for a particular measurement, force the lower limit value out of range (for example -500 dB).

**[DELTA LIMITS]** (LIMD) sets the limits an equal amount above and below a specified middle value, instead of setting upper and lower limits separately. This is used in conjunction with **[MIDDLE VALUE]** or **[MARKER → MIDDLE]**, to set limits for testing a device that is specified at a particular value plus or minus an equal tolerance.

For example, a device may be specified at 0 dB ± 3 dB. Enter the delta limits as 3 dB and the middle value as 0 dB.

When **[DELTA LIMITS]** or **[MIDDLE VALUE]** is pressed, all the segments in the table are displayed in these terms, even if they were defined as upper and lower limits.

**[MIDDLE VALUE]** (LIMM) sets the midpoint for **[DELTA LIMITS]**. It uses the entry controls to set a specified amplitude value vertically centered between the limits.

**[MARKER → MIDDLE]** (MARKMIDD) sets the midpoint for **[DELTA LIMITS]** using the active marker to set the middle amplitude value of a limit segment. Move the marker to the desired value or device specification, and press this key to make that value the midpoint of the delta limits. The limits are automatically set an equal amount above and below the marker.

**[DONE]** (SDON) terminates a limit segment definition, and returns to the edit limits menu.

## Limit Type Menu

This menu defines the selected limit segment as a sloping line, a flat line, or a single point.

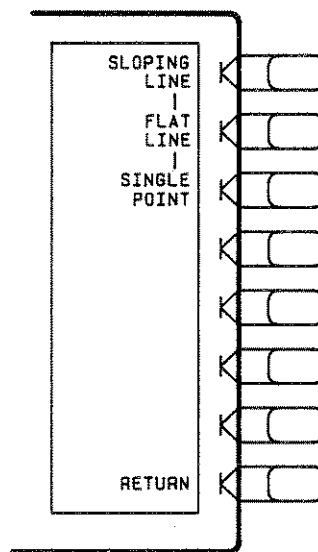

Figure 7-10

**[SLOPING LINE]** (LIMTSL) defines a sloping limit line segment that is linear with frequency or other stimulus value, and is continuous to the next stimulus value and limit. If a sloping line is the final segment it becomes a flat line terminated at the stop stimulus. A sloping line segment is indicated as SL on the displayed table of limits.

**[FLAT LINE]** (LIMTFL) defines a flat limit line segment whose value is constant with frequency or other stimulus value. This line is continuous to the next stimulus value, but is not joined to a segment with a different limit value. If a flat line segment is the final segment it terminates at the stop stimulus. A flat line segment is indicated as FL on the table of limits.

**[SINGLE POINT]** (LIMTSP) sets the limits at a single stimulus point. If limit lines are on, the upper limit value of a single point limit is displayed as  $\nabla$ , and the lower limit is displayed as  $\triangle$ . A limit test at a single point not terminating a flat or sloped line tests the nearest actual measured data point.

A single point limit can be used as a termination for a flat line or sloping line limit segment. When a single point terminates a sloping line or when it terminates a flat line and has the same limit values as the flat line, the single point is not displayed as  $\nabla$  and  $\triangle$ . The indication for a sloping line segment in the displayed table of limits is SP.

**[RETURN]** goes back to the edit limits menu.

## Offset Limits Menu

This menu allows the complete limit set to be offset in either stimulus value or amplitude value. This is useful for changing the limits to correspond with a change in the test setup, or for device specifications that differ in stimulus or amplitude. It can also be used to move the limit lines away from the data trace temporarily for visual examination of trace detail.

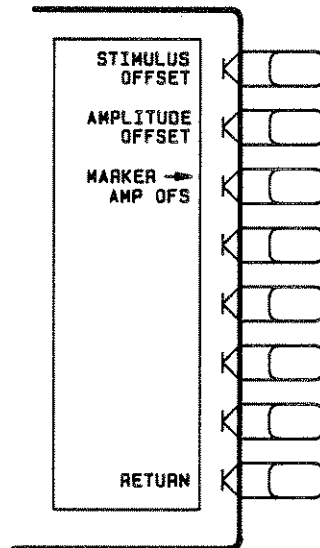

Figure 7-11

**[STIMULUS OFFSET]** (LIMISTIO) adds or subtracts an offset in stimulus value. This allows limits already defined to be used for testing in a different stimulus range. Use the entry block controls to specify the offset required.

**[AMPLITUDE OFFSET]** (LIMIAMPO) adds or subtracts an offset in amplitude value. This allows limits already defined to be used for testing at a different response level. For example, if attenuation is added to or removed from a test setup, the limits can be offset an equal amount. Use the entry block controls to specify the offset.

**[MARKER → AMP. OFS.]** (LIMIMAOF) uses the active marker to set the amplitude offset. Move the marker to the desired middle value of the limits and press this key. The limits are then moved so that they are centered an equal amount above and below the marker at that stimulus value.

**[RETURN]** goes back to the limits menu.

# Chapter 8. Time and Frequency Domain Transforms

---

## INTRODUCTION

With option 010, the HP 8753B can transform frequency domain data to the time domain or time domain data to the frequency domain. In normal operation, the analyzer measures the characteristics of a device under test (DUT) as a function of frequency. Using a mathematical technique (the inverse Fourier transform), the HP 8753B transforms frequency domain information into the time domain, with time as the horizontal display axis. Response values (measured on the vertical axis) now appear separated in time or distance, providing valuable insight into the behavior of the DUT beyond simple frequency characteristics.

**NOTE:** An HP 8753B can be ordered with option 010, or the option can be added at a later date using the HP 85019B time domain retrofit kit.

The transform used by the HP 8753B resembles time domain reflectometry (TDR) measurements. TDR measurements, however, are made by launching an impulse or step into the DUT and observing the response in time with a receiver similar to an oscilloscope. In contrast, the HP 8753B makes swept frequency response measurements, and mathematically transforms the data into a TDR-like display.

The HP 8753B has three frequency-to-time transform modes:

**Time Domain Bandpass Mode** is designed to measure band-limited devices and is the easiest mode to use. This mode simulates the time domain response to an impulse input.

**Time Domain Low Pass Step Mode** simulates the time domain response to a step input. As in a traditional TDR measurement, the distance to the discontinuity in the DUT, and the type of discontinuity (resistive, capacitive, inductive) can be determined.

**Time Domain Low Pass Impulse Mode** simulates the time domain response to an impulse input (like the bandpass mode). Both low pass modes yield better time domain resolution for a given frequency span than does the bandpass mode. In addition, using the low pass modes you can determine the type of discontinuity. However, these modes have certain limitations that are defined in the low pass section of this chapter.

The HP 8753B has one time-to-frequency transform mode:

**Forward Transform Mode** transforms CW signals measured over time into the frequency domain, to measure the spectral content of a signal. This mode is known as the CW time mode.

In addition to these transform modes, this chapter discusses special transform concepts such as masking, windowing, and gating.

## GENERAL THEORY

The relationship between the frequency domain response and the time domain response of a network analyzer is defined by the Fourier transform. Because of this transform, it is possible to measure, in the frequency domain, the response of a linear DUT and mathematically calculate the inverse Fourier transform of the data to find the time domain response. The HP 8753B internal computer makes this calculation using the chirp-Z Fourier transform technique. The resulting measurement is the fully error-corrected time domain reflection or transmission response of the DUT, displayed in near real time.

Table 8-1 lists the useful formats for time domain reflection measurements. Time domain transmission measurements are displayed using the linear magnitude or log magnitude formats, as described later in this chapter.

Table 8-1. Time Domain Reflection Formats

| Format  | Parameter                                                |
|---------|----------------------------------------------------------|
| LIN MAG | Reflection Coefficient (unitless)<br>( $0 < \rho < 1$ )  |
| REAL    | Reflection Coefficient (unitless)<br>( $-1 < \rho < 1$ ) |
| LOG MAG | Return Loss (dB)                                         |
| SWR     | Standing Wave Ratio (unitless)                           |

Figure 8-1 illustrates the frequency and time domain reflection responses of a device. The frequency domain reflection measurement is the composite of all the signals reflected by the discontinuities present in the DUT over the measured frequency range.

**NOTE:** In this chapter, all points of reflection are referred to as discontinuities.

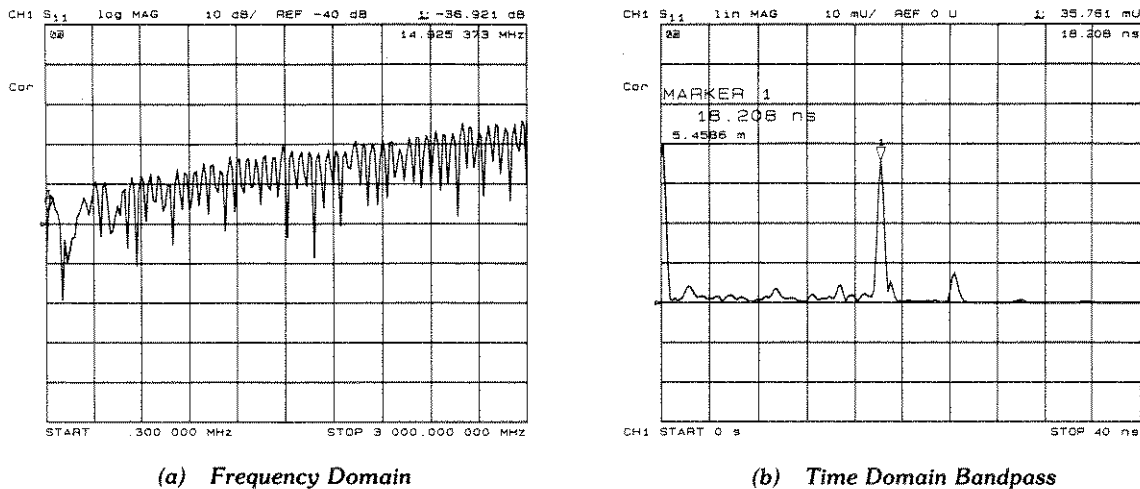
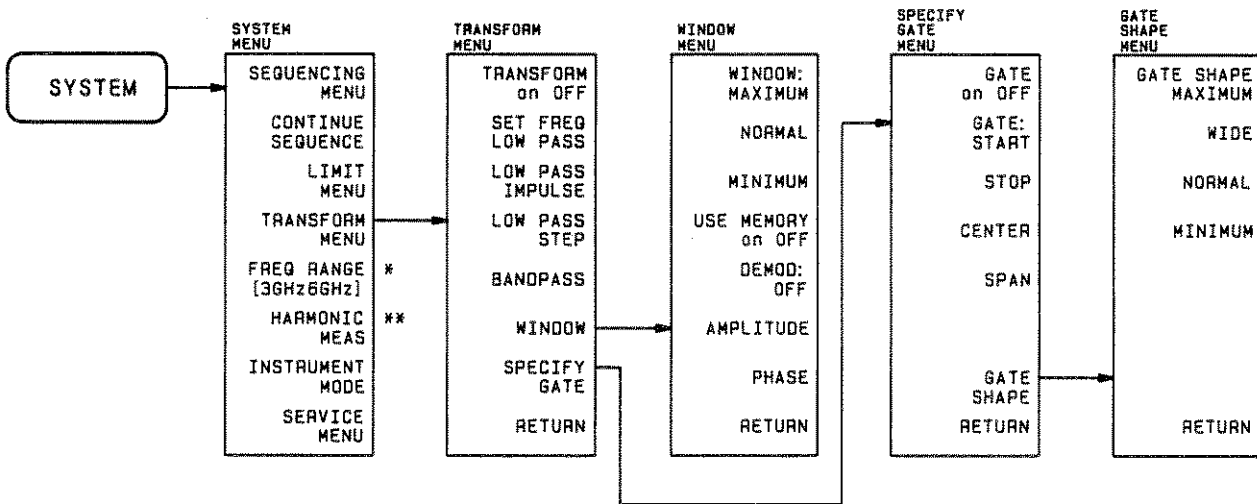

Figure 8-1. Device Frequency Domain and Time Domain Reflection Responses



The time domain measurement shows the effect of each discontinuity as a function of time (or distance), and shows that the device response consists of three separate impedance changes. The second discontinuity has a reflection coefficient magnitude of 0.035 (i.e. 3.5% of the incident signal is reflected). Marker 1 on the time domain trace shows the round-trip time to the discontinuity and back to the reference plane (where the calibration standards are connected): 18.2 nanoseconds. The distance shown (5.45 metres) assumes that the signal travels at the speed of light. The signal travels slower than the speed of light in most media (e.g. coax cables). This slower velocity (relative to light) can be compensated for by adjusting the HP 8753B relative velocity factor. This procedure is described later in this chapter.

Figure 8-2 illustrates the transform menus, which are accessed from the [SYSTEM] key.



\* Displayed only in instruments equipped with option 006.  
 \*\*Displayed only in instruments equipped with option 002.

Figure 8-2. The Time Domain Transform Menus

## TIME DOMAIN BANDPASS

This mode is called bandpass because it works with band-limited devices. Traditional TDR requires that the DUT be able to operate down to DC. Using bandpass mode, there are no restrictions on the measurement frequency range. Bandpass mode characterizes the DUT impulse response.

### Reflection Measurements Using Bandpass Mode

**NOTE:** Before making time domain reflection measurements, perform the appropriate calibration.

Example:

1. Press [PRESET]. The default measurement at preset (with an S-parameter test set) is S11 on channel 1.
2. Press [CAL] [CALIBRATE MENU] [S11 1-PORT] and perform an S11 1-port calibration using an open, a short, and a load connected to port 1. Press [DONE 1-PORT CAL], then save the configuration in one of the save registers.

3. Connect one or more lengths of cable, with adapters between cable sections, as shown at the top of Figure 8-3.
4. Press [SYSTEM] [TRANSFORM MENU] [BANDPASS] [TRANSFORM ON].
5. Press [START] [0] [x1] to select a start time of zero seconds.
6. Press [STOP] [4] [0] [G/n] to select a stop time of 40 nanoseconds.

**NOTE:** In the time domain, the STIMULUS keys ([START], [STOP], [CENTER] and [SPAN]) refer to time, and can be used to change the horizontal (time) axis of the display, independent of the chosen frequency range. To set the STOP time long enough to let you "see" the end of the cable under test, enter a STOP time of 10 nanoseconds per metre of cable under test. This is a good rule-of-thumb number that accounts for the approximate round-trip time for most cables.

7. Press [FORMAT] [LIN MAG] for a display of reflection coefficient versus time (or distance).
8. Press [SCALE REF] [AUTO SCALE].

Figure 8-3 shows typical frequency and time domain responses of a reflection measurement of two sections of cable.

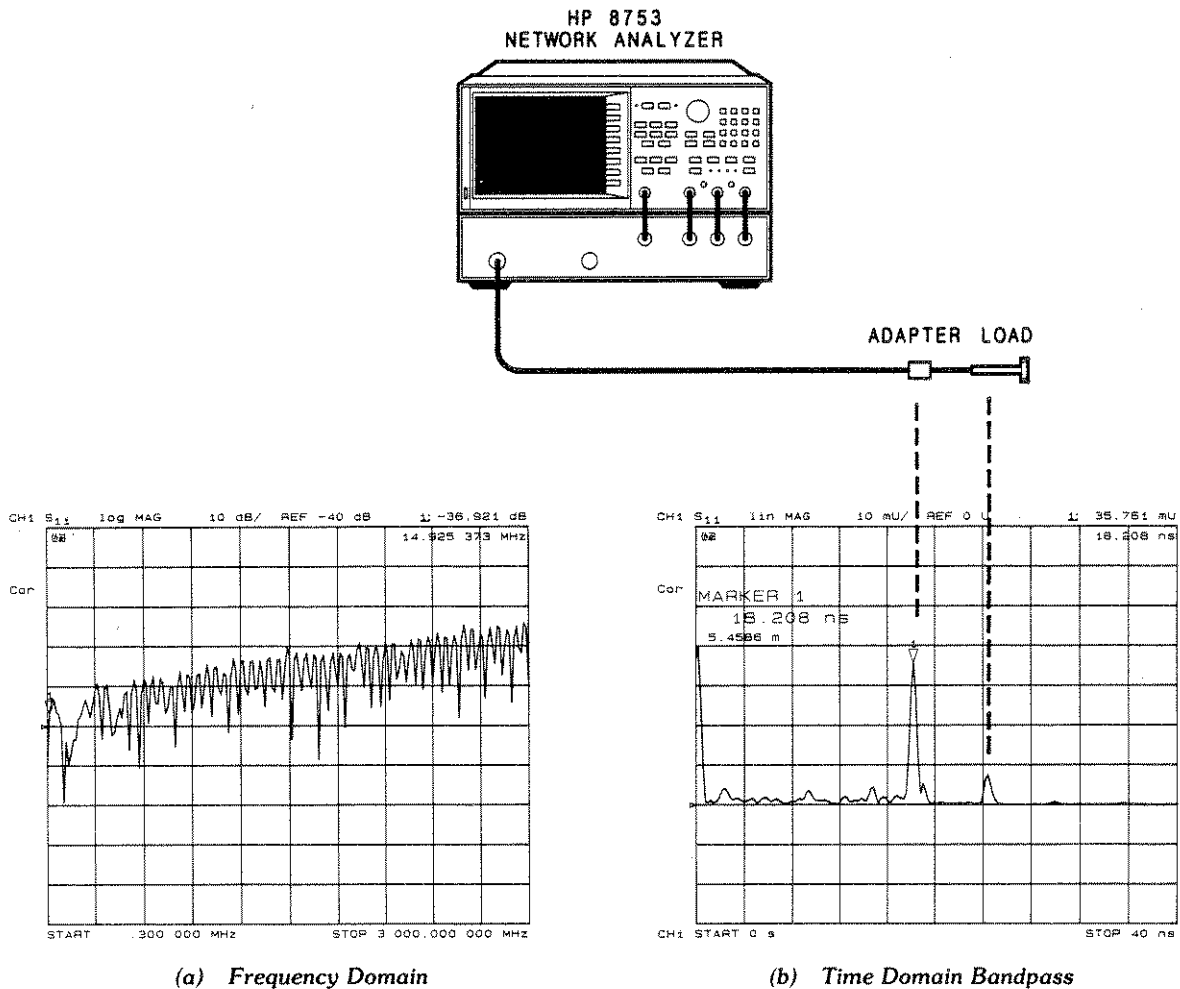

Figure 8-3. A Reflection Measurement of Two Cables

The ripples in reflection coefficient versus frequency in the frequency domain measurement are caused by the reflections at each connector “beating” against each other.

One at a time, loosen the connectors at each end of the cable and observe the response in both the frequency domain and the time domain. The frequency domain ripples grow as each connector is loosened, corresponding to a larger reflection adding in and out of phase with the other reflections. The time domain responses grow as you loosen the connector that corresponds to each response.

**Interpreting the Bandpass Reflection Response Horizontal Axis.** In bandpass reflection measurements, the horizontal axis represents the time it takes for an impulse launched at the test port to reach a discontinuity and return to the test port (the two-way travel time). In Figure 8-3, each connector is a discontinuity.

**Interpreting the Bandpass Reflection Response Vertical Axis.** The quantity displayed on the vertical axis depends on the selected format. The common formats are listed in Table 8-1. The default format is LOG MAG (logarithmic magnitude), which displays the return loss in decibels (dB). LIN MAG (linear magnitude) is a format that displays the response as reflection coefficient ( $\rho$ ). This can be thought of as an average reflection coefficient of the discontinuity over the frequency range of the measurement. Use the REAL format only in low pass mode.

### Adjusting the Relative Velocity Factor

A marker provides both the time (x2) and the electrical length (x2) to a discontinuity. To determine the physical length, rather than the electrical length, change the velocity factor to that of the medium under test:

1. Press [CAL] [MORE] [VELOCITY FACTOR].
2. Enter a velocity factor between 0 and 1.0 (1.0 corresponds to the speed of light in a vacuum). Most cables have a velocity factor of 0.66 (polyethylene dielectrics) or 0.70 (teflon dielectrics).

**NOTE:** To cause the markers to read the actual one-way distance to a discontinuity, rather than the round trip distance, enter one-half the actual velocity factor.

### Transmission Measurements Using Bandpass Mode

The bandpass mode can also transform transmission measurements to the time domain. For example, this mode can provide information about a surface acoustic wave (SAW) filter that is not apparent in the frequency domain. Figure 8-4 illustrates a time domain bandpass measurement of a 321 MHz SAW filter.

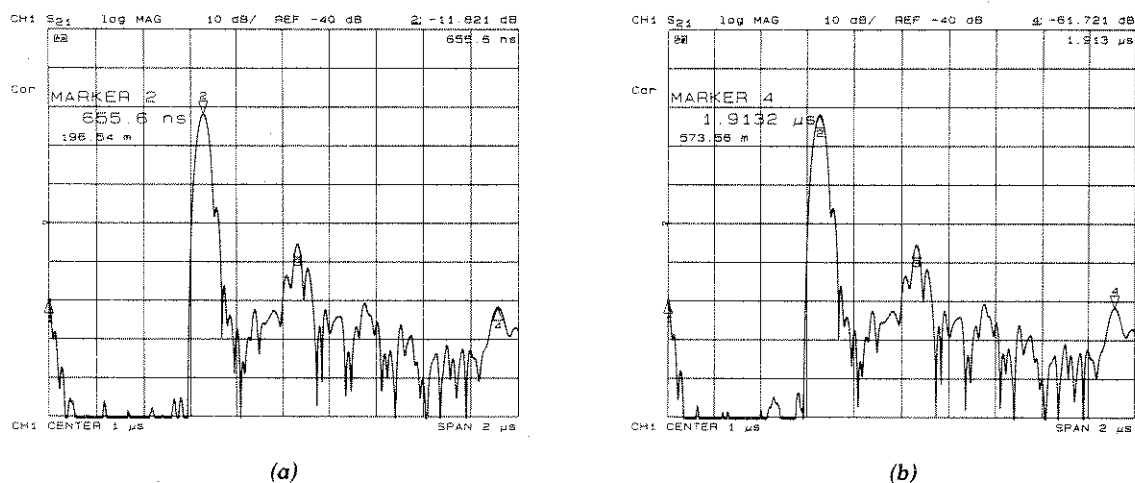

Figure 8-4. Transmission Measurement in Time Domain Bandpass Mode

**Interpreting the Bandpass Transmission Response Horizontal Axis.** In time domain transmission measurements, the horizontal axis is displayed in units of time. The time axis indicates the propagation delay through the device. Note that in time domain transmission measurements, the value displayed is the actual delay (not x2). The marker provides the propagation delay in both time and distance.

Marker 2 in Figure 8-4 (a) indicates the main path response through the device, which has a propagation delay of 655.6 ns, or about 196.5 meters in electrical length. Marker 4 in Figure 8-4 (b) indicates the triple-travel path response at 1.91  $\mu$ s, or about 573.5 meters. The response at marker 1 (at 0 seconds) is an RF feedthrough leakage path. In addition to the triple travel path response, there are several other multi-path responses through the device, which are inherent in the design of a SAW filter.

**Interpreting the Bandpass Transmission Response Vertical Axis.** In the log magnitude format, the vertical axis displays the transmission loss or gain in dB; in the linear magnitude format it displays the transmission coefficient ( $\tau$ ). Think of this as an average of the transmission response over the measurement frequency range.

## TIME DOMAIN LOW PASS

This mode is used to simulate a traditional time domain reflectometry (TDR) measurement. It provides information to determine the type of discontinuity (resistive, capacitive, or inductive) that is present. Low pass provides the best resolution for a given bandwidth in the frequency domain. It may be used to give either the step or impulse response of the DUT.

The low pass mode is less general-purpose than the bandpass mode because it places strict limitations on the measurement frequency range. The low pass mode requires that the frequency domain data points are harmonically related from DC to the stop frequency. That is,  $\text{stop} = n \times \text{start}$ , where  $n$  = number of points. For example, with a start frequency of 300 kHz and 101 points, the stop frequency would be 30.3 MHz. Since the frequency range of the HP 8753B starts at 300 kHz (3 MHz in the option 006 6 GHz mode with an HP 85047A test set), the DC frequency response is extrapolated from the lower frequency data. The requirement to pass DC is the same limitation that exists for traditional TDR.

### Setting Frequency Range for Time Domain Low Pass

Before a low pass measurement is made, the measurement frequency range must meet the ( $\text{stop} = n \times \text{start}$ ) requirement described above. The **[SET FREQ LOW PASS]** softkey performs this function automatically: the stop frequency is set close to the entered stop frequency, and the start frequency is set equal to  $\text{stop}/n$ . For convenience, the **[SET FREQ LOW PASS]** softkey is in both the transform menu and the calibration menu.

If the low end of the measurement frequency range is critical, it is best to calculate approximate values for the start and stop frequencies before pressing **[SET FREQ LOW PASS]** and calibrating. This avoids distortion of the measurement results. To see an example, select the preset values of 201 points and a 300 kHz to 3 GHz frequency range. Now press **[SET FREQ LOW PASS]** and observe the change in frequency values. The stop frequency changes to 2.999 GHz, and the start frequency changes to 14.925 MHz. This would cause a distortion of measurement results for frequencies from 300 kHz to 14.925 MHz.

**NOTE:** If the start and stop frequencies do not conform to the low pass requirement before a low pass mode (step or impulse) is selected and transform is turned on, the analyzer resets the start and stop frequencies. If error correction is on when the frequency range is changed, this turns it off.

**Minimum Allowable Stop Frequencies.** The lowest HP 8753B measurement frequency is 300 kHz (3 MHz in the option 006 6 GHz mode), therefore for each value of n there is a minimum allowable stop frequency that can be used. That is, the minimum stop frequency = n x 300 kHz (or n x 3 MHz). Table 8-2 lists the minimum frequency range that can be used for each value of n for low pass time domain measurements.

**NOTE:** In the 6 GHz mode (option 006 only), the minimum frequency can be set below 3 MHz, although instrument specifications do not apply in this case.

Table 8-2. Minimum Frequency Ranges for Time Domain Low Pass

| Number of Points | Minimum Frequency Range |                       |
|------------------|-------------------------|-----------------------|
|                  | Standard Instrument     | Option 006 6 GHz Mode |
| 3                | 300 kHz to 0.9 MHz      | 3 MHz to 9 MHz        |
| 11               | 300 kHz to 3.3 MHz      | 3 MHz to 33 MHz       |
| 26               | 300 kHz to 7.8 MHz      | 3 MHz to 78 MHz       |
| 51               | 300 kHz to 15.3 MHz     | 3 MHz to 153 MHz      |
| 101              | 300 kHz to 30.3 MHz     | 3 MHz to 303 MHz      |
| 201              | 300 kHz to 60.3 MHz     | 3 MHz to 603 MHz      |
| 401              | 300 kHz to 120.3 MHz    | 3 MHz to 1.203 GHz    |
| 801              | 300 kHz to 240.3 MHz    | 3 MHz to 2.403 GHz    |
| 1601             | 300 kHz to 480.3 MHz    | 3 MHz to 4.803 GHz    |

## Reflection Measurements in Time Domain Low Pass

Example:

1. Press **[PRESET]**. The default measurement at preset (with an S-parameter test set) is S11 on channel 1.
2. Press **[CAL] [CALIBRATE MENU] [SET FREQ LOW PASS]**. The message "LOW PASS: FREQ LIMITS CHANGED" will be displayed.
3. Press **[S11 1-PORT]**, and perform an S11 1-port calibration.
4. Connect one or more lengths of cable, with adapters between cable sections. Leave the last cable unterminated.
5. Press **[SYSTEM] [TRANSFORM MENU] [LOW PASS STEP] [TRANSFORM ON]**.
6. Press **[START] [0] [x1]** to select a start time of 0 seconds.
7. Press **[STOP] [4] [0] [G/n]** to select a stop time of 40 nanoseconds.

**NOTE:** In the time domain, the STIMULUS keys (**[START]**, **[STOP]**, **[CENTER]** and **[SPAN]**) refer to time, and can be used to change the horizontal (time) axis of the display, independent of the chosen frequency range.

8. Press **[FORMAT] [MORE] [REAL] [SCALE REF] [AUTO SCALE]** to view the step response, which will be similar to Figure 8-5 (a). (The step response is reflected back from the unterminated cable.)

9. Press **[SYSTEM] [TRANSFORM MENU] [LOW PASS IMPULSE]** to view the impulse response, similar to Figure 8-5 (b).

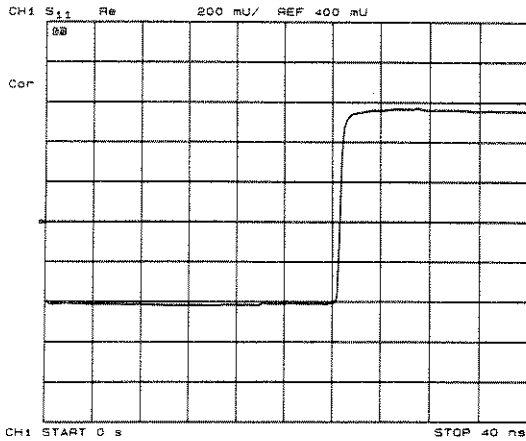

(a) Low Pass Step

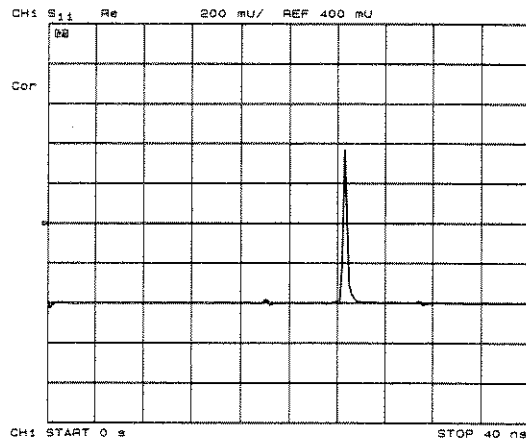

(b) Low Pass Impulse

Figure 8-5. Time Domain Low Pass Measurements of an Underterminated Cable

10. Now connect a short circuit to the unterminated cable and press **[SCALE REF] [AUTO SCALE]** to center the display. The polarity of the impulse response is now reversed.
11. Press **[SYSTEM] [TRANSFORM MENU] [LOW PASS STEP]** to view the low pass step response with the polarity reversed.

**Interpreting the Low Pass Response Horizontal Axis.** The low pass measurement horizontal axis is the two-way travel time to the discontinuity (as in the bandpass mode). The marker displays both the two-way time and the electrical length along the trace. To determine the actual physical length, enter the appropriate velocity factor as described earlier in this chapter under *Adjusting the Relative Velocity Factor*.

**Interpreting the Low Pass Response Vertical Axis.** The vertical axis depends on the chosen format. In the low pass mode, the frequency domain data is taken at harmonically related frequencies and extrapolated to DC. Because this results in the inverse Fourier transform having only a real part (the imaginary part is zero), the most useful low pass step mode format in this application is the real format. It displays the response in reflection coefficient units. This mode is similar to the traditional TDR response, which displays the reflected signal in a real format (volts) versus time (or distance) on the horizontal axis.

The real format can also be used in the low pass impulse mode, but for the best dynamic range for simultaneously viewing large and small discontinuities, use the log magnitude format.

## Fault Location Measurements Using Low Pass

As described, the low pass mode can simulate the TDR response of the device under test. This response contains information useful in determining the type of discontinuity present. Figure 8-6 illustrates the low pass responses of known discontinuities. Each circuit element was simulated to show the corresponding low pass time domain S11 response waveform. The low pass mode gives the device response either to a step or to an impulse stimulus. Mathematically, the low pass impulse stimulus is the derivative of the step stimulus.









| Element               | Step Response                                                                                                       | Impulse Response                                                                                                      |
|-----------------------|---------------------------------------------------------------------------------------------------------------------|-----------------------------------------------------------------------------------------------------------------------|
| Open                  | <br>Unity Reflection               | <br>Unity Reflection               |
| Short                 | <br>Unity Reflection, $-180^\circ$ | <br>Unity Reflection, $-180^\circ$ |
| Resistor<br>$R > Z_0$ | <br>Positive Level Shift         | <br>Positive Peak                |
| Resistor<br>$R < Z_0$ | <br>Negative Level Shift         | <br>Negative Peak                |
| Inductor              | <br>Positive Peak                | <br>Positive Then Negative Peaks |
| Capacitor             | <br>Negative Peak                | <br>Negative Then Positive Peaks |

Figure 8-6. Simulated Low Pass Step and Impulse Response Waveforms (Real Format)

Figure 8-7 shows example cables with discontinuities (faults) using the low pass step mode with the real format.



(a) Crimped Cable (Capacitive)

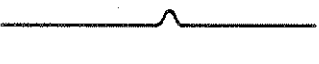
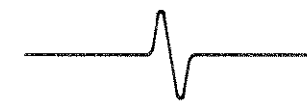
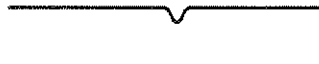
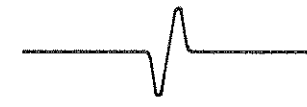
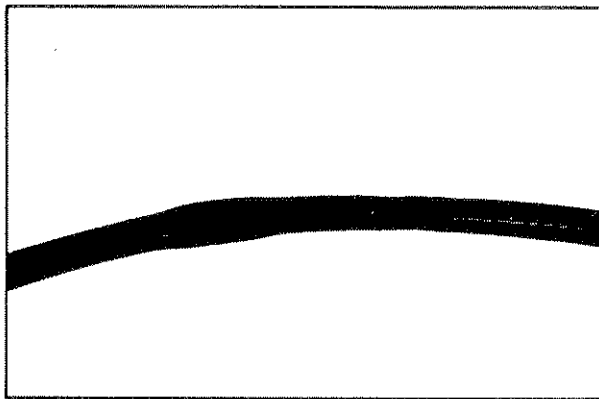
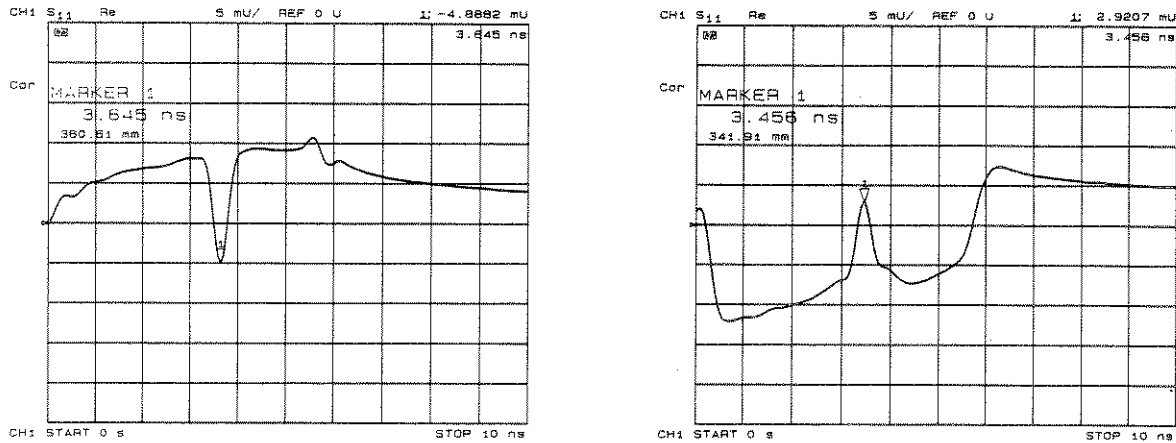
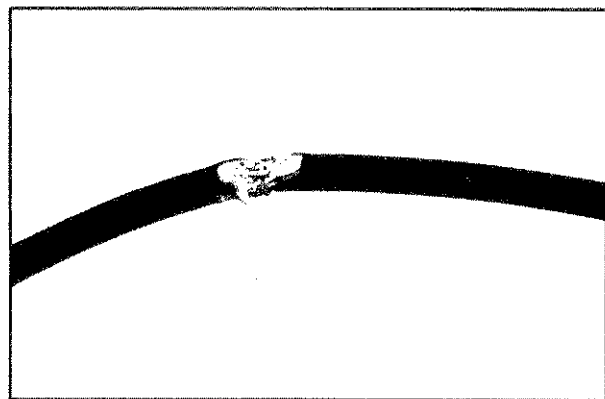

(b) Frayed Cable (Inductive)

Figure 8-7. Low Pass Step Measurements of Common Cable Faults (Real Format)

## Transmission Measurements in Time Domain Low Pass

**Measuring Small Signal Transient Response Using Low Pass Step.** Use the low pass mode to analyze the DUT small signal transient response. The transmission response of a device to a step input is often measured at lower frequencies, using a function generator (to provide the step to the DUT) and a sampling oscilloscope (to analyze the DUT output response). The low pass step mode extends the frequency range of this type of measurement to 3 GHz (6 GHz with an HP 8753B option 006 and 85047A test set).

The step input shown in Figure 8-8 is the inverse Fourier transform of the frequency domain response of a thru measured at calibration. The step rise time is proportional to the highest frequency in the frequency domain sweep; the higher the frequency, the faster the rise time. The frequency sweep in Figure 8-8 is from 10 MHz to 1 GHz.



Figure 8-8 also illustrates the time domain low pass response of an amplifier under test. The average group delay over the measurement frequency range is the difference in time between the step and the amplifier response. This time domain response simulates an oscilloscope measurement of the amplifier's small signal transient response. Note the ringing in the amplifier response that indicates an underdamped design.

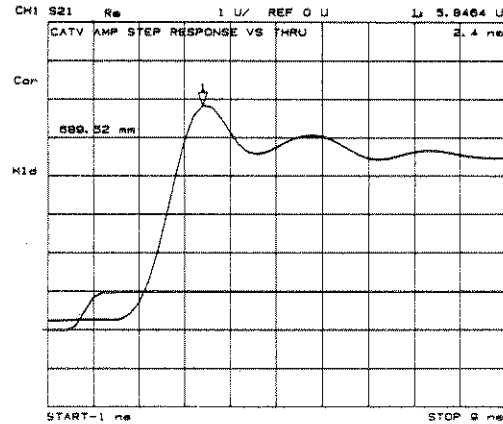

Figure 8-8. Time Domain Low Pass Measurement of an Amplifier Small Signal Transient Response

**Interpreting the Low Pass Step Transmission Response Horizontal Axis.** The low pass transmission measurement horizontal axis displays the average transit time through the device over the frequency range used in the measurement. The response of the thru connection used in the calibration is a step that reaches 50% unit height at approximately time = 0. The rise time is determined by the highest frequency used in the frequency domain measurement. The step is a unit high step, which indicates no loss for the thru calibration. When a device is inserted, the time axis indicates the propagation delay or electrical length of the device. The markers read the electrical delay in both time and distance. The distance can be scaled by an appropriate velocity factor as described earlier in this chapter under *Adjusting the Relative Velocity Factor*.

**Interpreting the Low Pass Step Transmission Response Vertical Axis.** In the real format, the vertical axis displays the transmission response in real units (e.g. volts). For the amplifier example in Figure 8-8, if the amplifier input is a step of 1 volt, the output, 2.4 nanoseconds after the step (indicated by marker 1), is 5.84 volts.

In the log magnitude format, the amplifier gain is the steady state value displayed after the initial transients die out.

**Measuring Separate Transmission Paths through the DUT Using Low Pass Impulse Mode.** The low pass impulse mode can be used to identify different transmission paths through a DUT that has a response at frequencies down to DC (or at least has a predictable response, above the noise floor, below 300 kHz). For example, use the low pass impulse mode to measure the relative transmission times through a multipath device such as a power divider. Another example is to measure the pulse dispersion through a broadband transmission line, such as a fiber optic cable. Both examples are illustrated in Figure 8-9. The horizontal and vertical axes can be interpreted as already described in this chapter under *Transmission Measurements Using Bandpass Mode*.

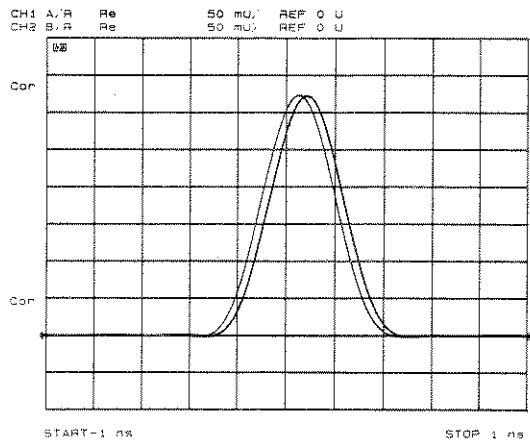

(a) Comparing Transmission Paths through a Power Divider

THRU LINE

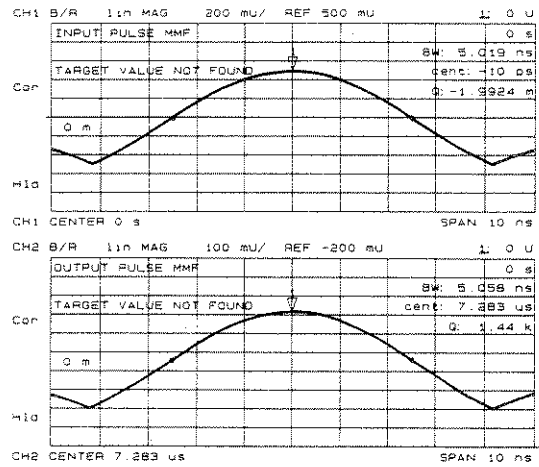

(b) Measuring Pulse Dispersion on a 1.5 km Fiber Optic Cable

Figure 8-9. Transmission Measurements Using Low Pass Impulse Mode

## TIME DOMAIN CONCEPTS

### Masking

Masking occurs when a discontinuity (fault) closest to the reference plane affects the response of each subsequent discontinuity. This happens because the energy reflected from the first discontinuity never reaches subsequent discontinuities. For example, if a transmission line has two discontinuities that each reflect 50% of the incident voltage, the time domain response (real format) shows the correct reflection coefficient for the first discontinuity ( $\rho=0.50$ ). However, the second discontinuity appears as a 25% reflection ( $\rho=0.25$ ) because only half the incident voltage reached the second discontinuity.

**NOTE:** This example assumes a lossless transmission line. Real transmission lines, with non-zero loss, attenuate signals as a function of the distance from the reference plane.

As an example of masking due to line loss, consider the time domain response of a 3 dB attenuator and a short circuit. The impulse response (log magnitude format) of the short circuit alone is a return loss of 0 dB, as shown in Figure 8-10 (a). When the short circuit is placed at the end of the 3 dB attenuator, the return loss is -6 dB, as shown in Figure 8-10 (b). This value actually represents the forward and return path loss through the attenuator, and illustrates how a lossy network can affect the responses that follow it.

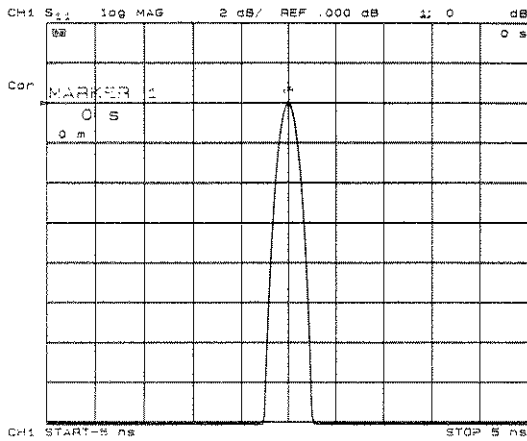

(a) Short Circuit

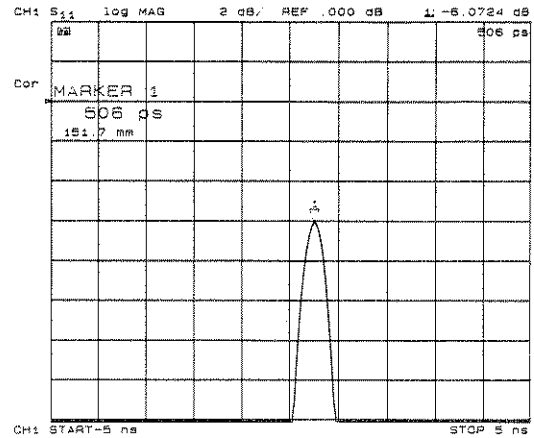

(b) Short Circuit at the End of a 3 dB Pad

Figure 8-10. Masking Example

## Windowing

The HP 8753B provides a windowing feature that makes time domain measurements more useful for isolating and identifying individual responses. Windowing is needed because of the abrupt transitions in a frequency domain measurement at the start and stop frequencies. The band limiting of a frequency domain response causes overshoot and ringing in the time domain response, and causes a non-windowed impulse stimulus to have a  $\sin(kt)/kt$  shape, where  $k = \pi/\text{frequency span}$  (see Figure 8-11). This has two effects that limit the usefulness of the time domain measurement:

1. Finite impulse width (or rise time). This limits the ability to resolve between two closely spaced responses. The effects of the finite impulse width cannot be improved without increasing the frequency span of the measurement (see Table 8-3).
2. Sidelobes. The impulse sidelobes limit the dynamic range of the time domain measurement by hiding low-level responses within the sidelobes of higher level responses. The effects of sidelobes can be improved by windowing (see Table 8-3).

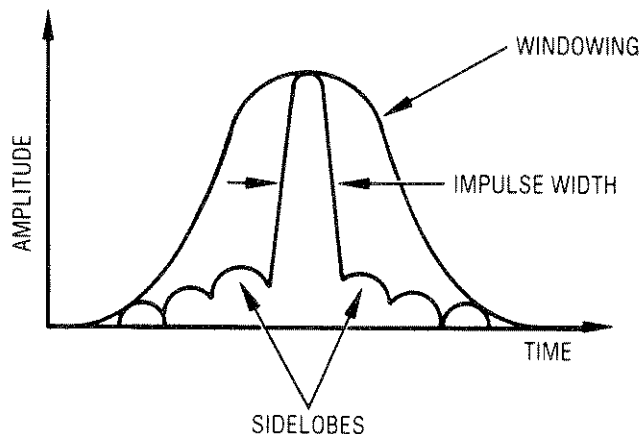

Figure 8-11. Impulse Width, Sidelobes, and Windowing

Windowing improves the dynamic range of a time domain measurement by filtering the frequency domain data prior to converting it to the time domain, producing an impulse stimulus that has lower sidelobes. This makes it much easier to see time domain responses that are very different in magnitude. The sidelobe reduction is achieved, however, at the expense of increased impulse width. The effect of windowing on the step stimulus (low pass mode only) is a reduction of overshoot and ringing at the expense of increased rise time.

To select a window, press **[SYSTEM] [TRANSFORM MENU] [WINDOW]**. A menu is presented that allows the selection of three window types (see Table 8-3).

*Table 8-3. Impulse Width, Sidelobe Level, and Windowing Values*

| Window Type | Impulse Sidelobe Level | Low Pass Impulse Width (50%) | Step Sidelobe Level | Step Rise Time (10 - 90%) |
|-------------|------------------------|------------------------------|---------------------|---------------------------|
| Minimum     | -13 dB                 | 1.20/Freq Span               | -21 dB              | 0.45/Freq Span            |
| Normal      | -44 dB                 | 1.92/Freq Span               | -60 dB              | 0.99/Freq Span            |
| Maximum     | -90 dB                 | 2.88/Freq Span               | -90 dB              | 1.48/Freq Span            |

**NOTE:** The bandpass mode simulates an impulse stimulus. Bandpass impulse width is twice that of lowpass impulse width. The bandpass impulse sidelobe levels are the same as lowpass impulse sidelobe levels.

Choose one of the three window shapes listed in Table 8-3. Or you can use the knob to select any windowing pulse width (or rise time for a step stimulus) between the softkey values. The time domain stimulus sidelobe levels depend only on the window selected.

**[MINIMUM]** is essentially no window. Consequently, it gives the highest sidelobes.

**[NORMAL]** (the preset mode) gives reduced sidelobes and is the mode most often used.

**[MAXIMUM]** window gives the minimum sidelobes, providing the greatest dynamic range.

**[USE MEMORY on OFF]** remembers a user-specified window pulse width (or step rise time) different from the standard window values.

A window is turned on only for viewing a time domain response, and does not affect a displayed frequency domain response. Figure 8-12 shows the typical effects of windowing on the time domain response of a short circuit reflection measurement.

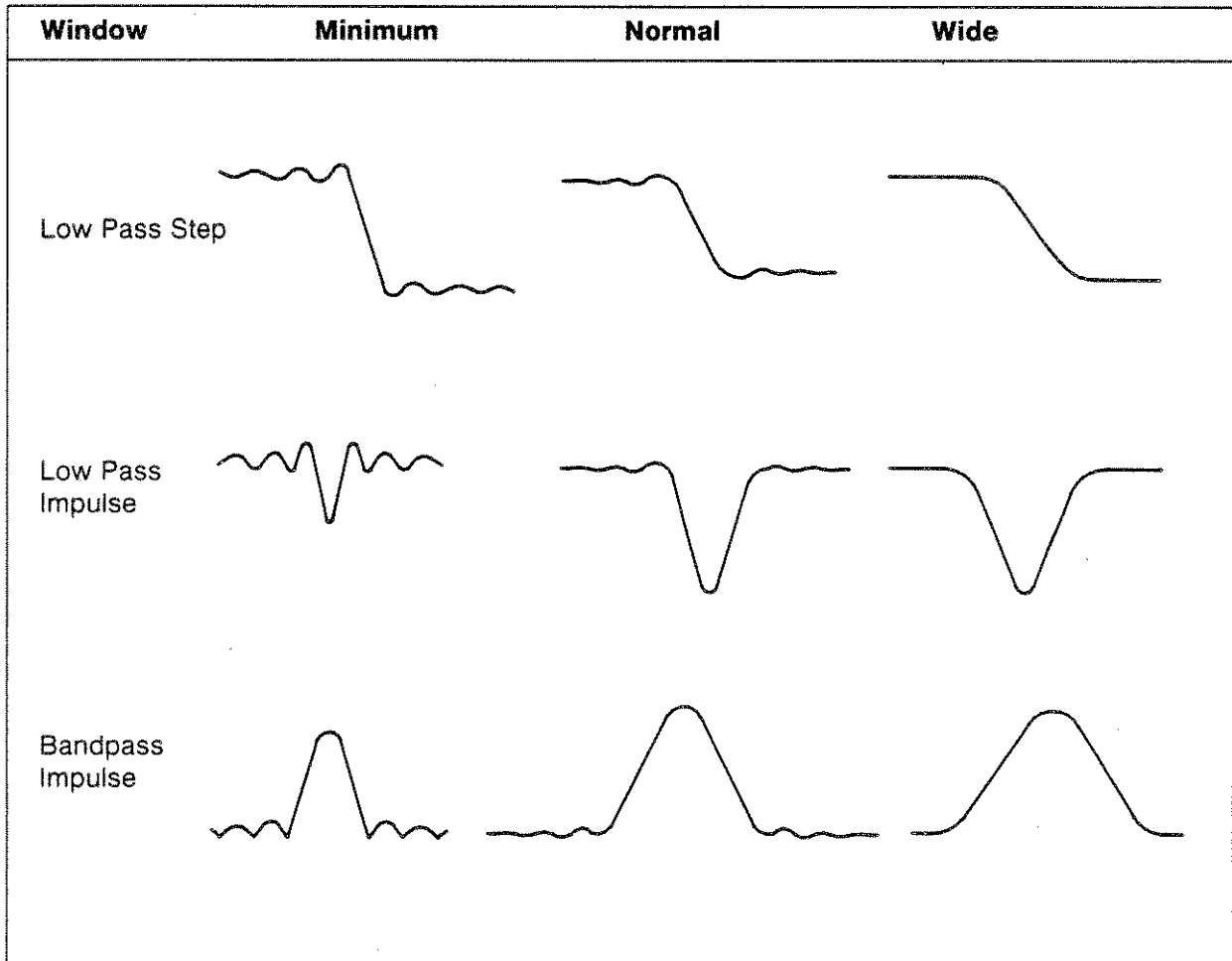

Figure 8-12. The Effects of Windowing on the Time Domain Responses of a Short Circuit

## Range

In the time domain, range is defined as the length in time that a measurement can be made without encountering a repetition of the response, called aliasing. A time domain response repeats at regular intervals because the frequency domain data is taken at discrete frequency points, rather than continuously over the frequency band.

Measurement range is equal to  $1/\Delta F$  ( $\Delta F$  is the spacing between frequency data points). Measurement range = (number of points - 1)/frequency span (Hz).

Example:

$$\begin{aligned} \text{Measurement} &= 201 \text{ points} \\ &1 \text{ MHz to } 2.001 \text{ GHz} \end{aligned}$$

$$\begin{aligned} \text{Range} &= 1/\Delta F \text{ or } (\text{number of points} - 1)/\text{frequency span} \\ &= 1/(10 \times 10^6) \text{ or } (201 - 1)/(2 \times 10^9) \\ &= 100 \times 10^{-9} \text{ seconds} \end{aligned}$$

$$\begin{aligned} \text{Electrical length} &= \text{range} \times \text{the speed of light } (3 \times 10^8 \text{ m/s}) \\ &= (100 \times 10^{-9} \text{ s}) \times (3 \times 10^8 \text{ m/s}) \\ &= 30 \text{ metres} \end{aligned}$$

In this example, the range is 100 ns, or 30 metres electrical length. To prevent the time domain responses from overlapping, the DUT must be 30 metres or less in electrical length for a transmission measurement (15 metres for a reflection measurement). The HP 8753B limits the stop time to prevent the display of aliased responses.

To increase the time domain measurement range, first increase the number of points, but remember that as the number of points increases, the sweep speed decreases. Decreasing the frequency span also increases range, but reduces resolution.

## Resolution

Two different resolution terms are used in the time domain:

1. Response Resolution
2. Range Resolution

**Response Resolution.** Time domain response resolution is defined as the ability to resolve two closely-spaced responses, or a measure of how close two responses can be to each other and still be distinguished from each other. For responses of equal amplitude, the response resolution is equal to the 50% (–6 dB) impulse width. It is inversely proportional to the measurement frequency span, and is also a function of the window used in the transform. The approximate formulas for calculating the 50% impulse width are given in Table 8-3.

For example, using the formula for the bandpass mode with a normal windowing function for a 1 MHz to 3.001 GHz measurement (3 GHz span):

$$\begin{aligned} 50\% \text{ calculated impulse width} &= 1.2 \times (1/3 \text{ GHz}) \times 1.6 \\ &= 0.64 \text{ nanoseconds} \end{aligned}$$

$$\begin{aligned} \text{Electrical length (in air)} &= (0.64 \times 10^{-9} \text{ s}) \times (30 \times 10^9 \text{ cm/s}) \\ &= 19.2 \text{ centimetres} \end{aligned}$$

With this measurement, two equal responses can be distinguished when they are separated by at least 19.2 centimetres. In a 6 GHz measurement with an option 006 instrument and an HP 85047A test set, two equal responses can be distinguished when they are separated by at least 9.6 cm.

Using the low pass mode (the low pass frequencies are slightly different) with a minimum windowing function, you can distinguish two equal responses that are about 6 centimetres or more apart.

For reflection measurements, which measure the round trip time to the response, divide the response resolution by 2. Using the example above, you can distinguish two faults of equal magnitude provided they are 3 centimetres (electrical length) or more apart.

**NOTE:** Remember, to determine the physical length, enter the relative velocity factor of the transmission medium under test.

For example, a cable with a teflon dielectric (0.7 relative velocity factor), measured under the conditions stated above, has a fault location measurement response resolution of 2.1 centimetres. This is the maximum fault location response resolution. Factors such as reduced frequency span, greater frequency domain data windowing, and a large discontinuity shadowing the response of a smaller discontinuity, all act to degrade the effective response resolution.

Figure 8-13 illustrates the effects of response resolution. The solid line shows the actual reflection measurement of two approximately equal discontinuities (the input and output of an SMA barrel). The dashed line shows the approximate effect of each discontinuity, if they could be measured separately.

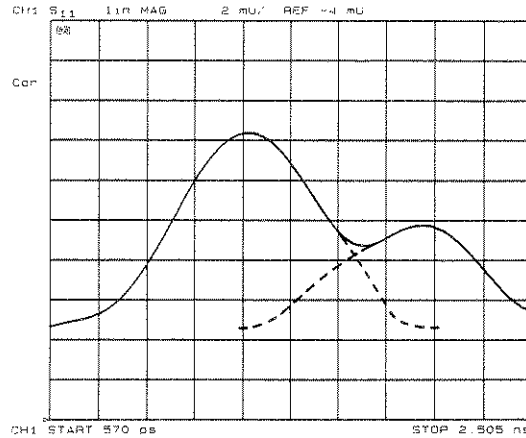

Figure 8-13. Response Resolution

While increasing the frequency span increases the response resolution, keep the following points in mind:

1. The time domain response noise floor is directly related to the frequency domain data noise floor. Because of this, if the frequency domain data points are taken at or below the measurement noise floor, the time domain measurement noise floor is degraded.
2. The time domain measurement is an average of the response over the frequency range of the measurement. If the frequency domain data is measured out-of-band, the time domain measurement is also the out-of-band response.

You may (with these limitations in mind) choose to use a frequency span that is wider than the DUT bandwidth to achieve better resolution.

**Range Resolution.** Time domain range resolution is defined as the ability to locate a single response in time. If only one response is present, range resolution is a measure of how closely you can pinpoint the peak of that response. The range resolution is equal to the digital resolution of the display, which is the time domain span divided by the number of points on the display. To get the maximum range resolution, center the response on the display and reduce the time domain span. The range resolution is always much finer than the response resolution.

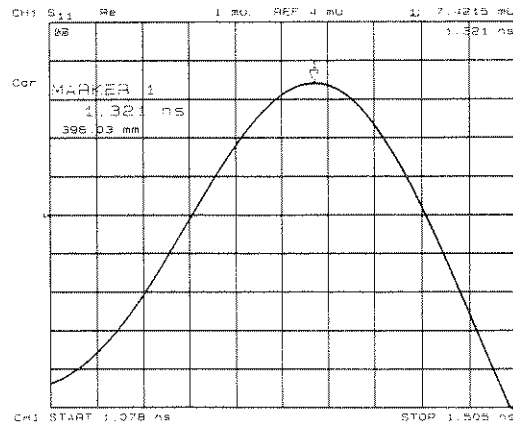

Figure 8-14. Range Resolution of a Single Discontinuity

## Gating

Gating provides the flexibility of selectively removing time domain responses. The gated time domain responses can then be transformed back to the frequency domain. For reflection (or fault location) measurements, use this feature to remove the effects of unwanted discontinuities in the time domain. You can then view the frequency response of the remaining discontinuities. In a transmission measurement, you can remove the effects of multiple transmission paths.

Figure 8-15 illustrates the time domain response of a SAW filter. Gating has been applied in the time domain to remove the effects of all but the main signal path response. When the gated response is transformed back to the frequency domain, the display shows only the direct path response.

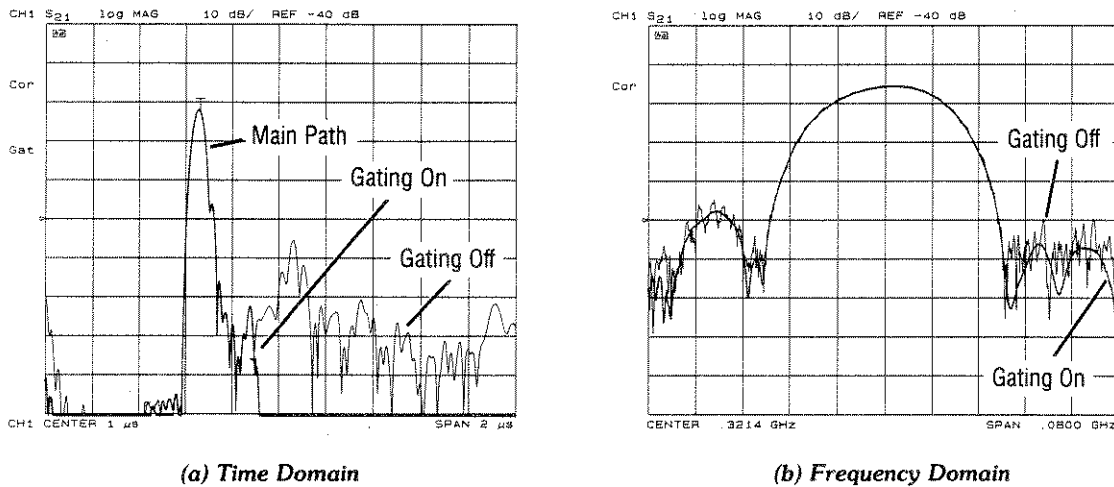

Figure 8-15. SAW Filter Transmission Measurement with Gating

**Setting the Gate.** Think of a gate as a bandpass filter in the time domain (Figure 8-16). When the gate is on, responses outside the gate are mathematically removed from the time domain trace. Enter the gate position as a start and stop time (not frequency) or as a center and span time. The start and stop times are the bandpass filter  $-6$  dB cutoff times. Gates can have a negative span, in which case the responses *inside* the gate are mathematically removed.

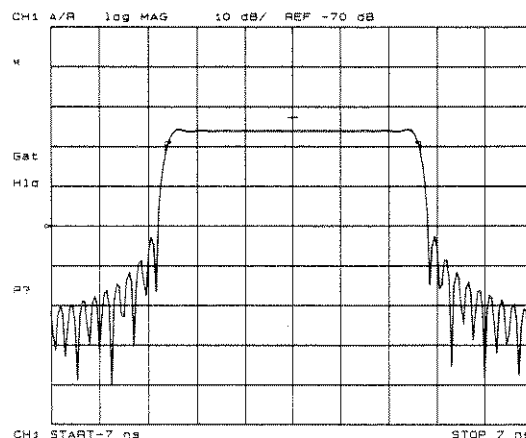

Figure 8-16. Gate Shape



**Selecting Gate Shape.** The four gate shapes available are listed in Table 8-4. Each gate has a different passband flatness, cutoff rate, and sidelobe levels.

Table 8-4. Gate Characteristics

| Gate Shape        | Passband Ripple | Sidelobe Levels | Cutoff Time    | Minimum Gate Span |
|-------------------|-----------------|-----------------|----------------|-------------------|
| Gate Span Minimum | $\pm 0.40$ dB   | -24 dB          | 0.6/Freq Span  | 1.2/Freq Span     |
| Normal            | $\pm 0.04$ dB   | -45 dB          | 1.4/Freq Span  | 2.8/Freq Span     |
| Wide              | $\pm 0.02$ dB   | -52 dB          | 4.0/Freq Span  | 8.0/Freq Span     |
| Maximum           | $\pm 0.01$ dB   | -80 dB          | 11.2/Freq Span | 22.4/Freq Span    |

**NOTE:** With 1601 frequency points, gating is available only in the passband mode.

The passband ripple and sidelobe levels are descriptive of the gate shape. The cutoff time is the time between the stop time (-6 dB on the filter skirt) and the peak of the first sidelobe, and is equal on the left and right side skirts of the filter. Because the minimum gate span has no passband, it is just twice the cutoff time. Always choose a gate span wider than the minimum. For most applications, do not be concerned about the minimum gate span, simply use the knob to position the gate markers around the desired portion of the time domain trace.

## TRANSFORMING CW TIME MEASUREMENTS INTO THE FREQUENCY DOMAIN

The HP 8753B can display the amplitude and phase of continuous wave (CW) signals versus time. For example, use this mode for measurements such as amplifier gain as a function of warm-up time (i.e. drift). In the past, drift measurements were often made using strip chart recorders. The HP 8753B can display the measured parameter (e.g. amplifier gain) for periods of up to 24 hours and then output the data to a digital plotter for hardcopy results.

These "strip chart" plots are actually measurements as a function of time (time is the independent variable), and the horizontal display axis is scaled in time units. Transforms of these measurements result in frequency domain data. Such transforms are called forward transforms because the transform from time to frequency is a forward Fourier transform, and can be used to measure the spectral content of a CW signal. For example, when transformed into the frequency domain, a pure CW signal measured over time appears as a single frequency spike. The transform into the frequency domain yields a display that looks similar to a spectrum analyzer display of signal amplitude versus frequency.

### Forward Transform Measurements

This is an example of a measurement using the Fourier transform in the forward direction, from the time domain to the frequency domain (see Figure 8-17):

1. Press **[PRESET]**.
2. Press **[MEAS]** and select the desired measurement (in this case B/R).
3. Press **[MENU] [CW FREQ]** and set the CW frequency to the desired value (here 250 MHz). The CW time mode is now active.

4. Press **[STOP]** and enter the time over which you wish to take data (up to 24 hours, in this case 0.1 second).
5. Press **[SYSTEM] [TRANSFORM MENU] [TRANSFORM ON]** to transform the data into the frequency domain.
6. Press **[SPAN]** and set the desired frequency span. For this example, press **[5] [0] [0] [x1]** to increase the frequency span to 500 Hz. The displayed center frequency of 0 Hz represents the CW frequency of 250 MHz entered earlier. The maximum span is 4000 Hz for the default sweep time (100 ms) and number of points (201) (see *Forward Transform Range*).

**NOTE:** In the forward transform mode, the k/m, M/ $\mu$ , and G/n keys terminate a selection as millihertz, microhertz, and nanohertz.

7. Press **[SCALE REF]** and adjust the scale per division and reference position to view the trace centered on the screen.
8. Press **[MKR FCTN] [MKR SEARCH] [MAX]** to see the peak value.

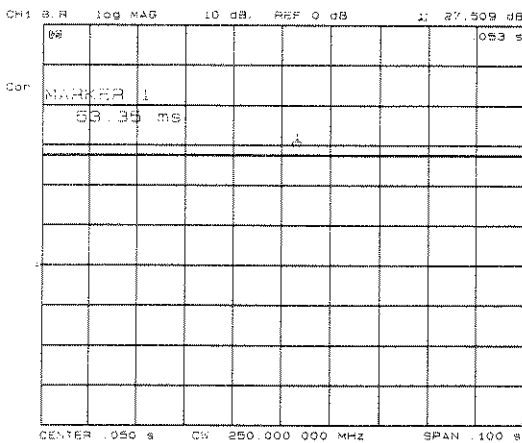

(a) CW Time

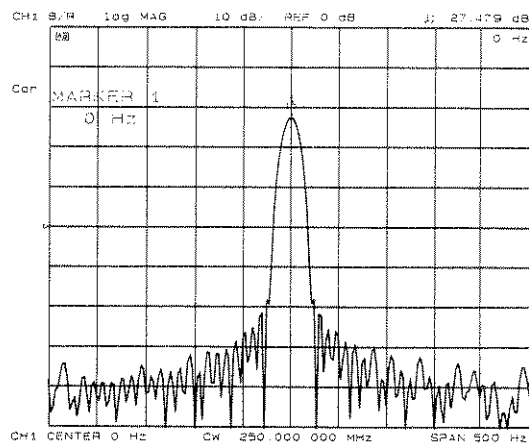

(b) Transform to Frequency Domain

Figure 8-17. Amplifier Gain Measurement

**Interpreting the Forward Transform Vertical Axis.** With the log magnitude format selected, the vertical axis displays dB. This format simulates a spectrum analyzer display of power versus frequency.

**Interpreting the Forward Transform Horizontal Axis.** In a frequency domain transform of a CW time measurement, the horizontal axis is measured in units of frequency. The center frequency is the offset of the CW frequency. For example, with a center frequency of 0 Hz, the CW frequency (250 MHz in the example) is in the center of the display. If the center frequency entered is a positive value, the CW frequency shifts to the right half of the display; a negative value shifts it to the left half of the display. The span value entered with the transform on is the total frequency span shown on the display. (Alternatively, the frequency display values can be entered as start and stop.)

## Demodulating the Results of the Forward Transform

The forward transform can separate the effects of the CW frequency modulation amplitude and phase components. For example, if a DUT modulates the transmission response (S21) with a 500 Hz AM signal, you can see the effects of that modulation as shown in Figure 8-18. To simulate this effect, connect a 500 Hz sine wave to the HP 8753B rear panel EXT AM input.

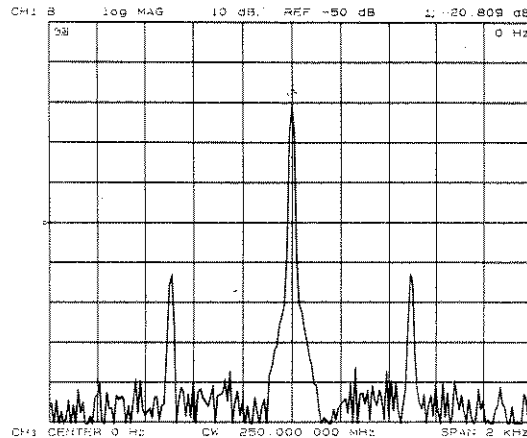

Figure 8-18. Combined Effects of Amplitude and Phase Modulation

Using the demodulation capabilities of the HP 8753B, it is possible to view the amplitude or the phase component of the modulation separately. The window menu (see Figure 8-2) includes the following softkeys to control the demodulation feature:

**[DEMODOFF]** This is the normal preset state, in which both the amplitude and phase components of any DUT modulation appear on the display.

**[AMPLITUDE]** displays only the amplitude modulation (AM), as illustrated in Figure 8-19 (a).

**[PHASE]** displays only the phase modulation (PM), as shown in Figure 8-19 (b).

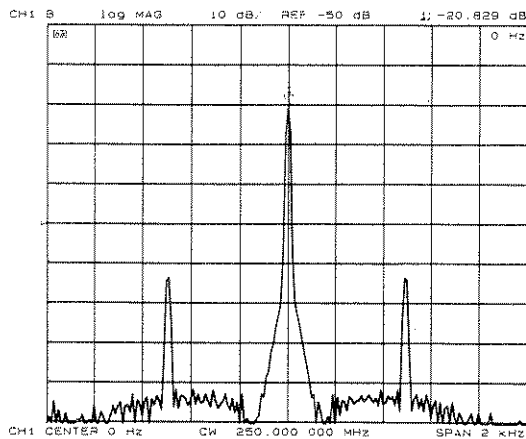

(a) Amplitude Modulation Component

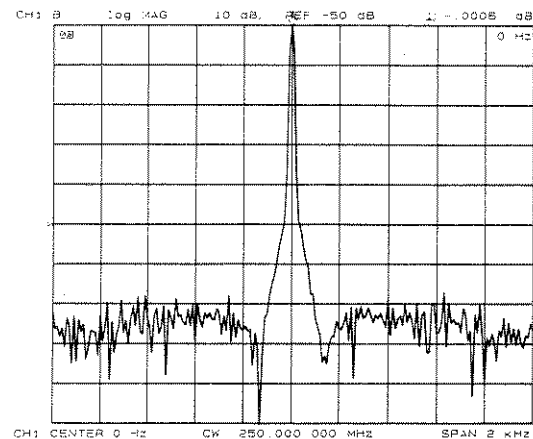

(b) Phase Modulation Component

Figure 8-19. Separating the Amplitude and Phase Components of DUT-Induced Modulation

## Forward Transform Range

In the forward transform (from CW time to the frequency domain), range is defined as the frequency span that can be displayed before aliasing occurs, and is similar to range as defined for time domain measurements. In the range formula, substitute time span for frequency span.

Example:

$$\begin{aligned}\text{Range} &= (\text{Number of points} - 1)/\text{time span} \\ &= (201 - 1)/(200 \times 10^{-3}) \\ &= 1000 \text{ Hertz}\end{aligned}$$

For the example given above, a 201 point CW time measurement made over a 200 ms time span, choose a span of 1 kHz or less on either side of the center frequency (Figure 8-20). That is, choose a total span of 2 kHz or less.

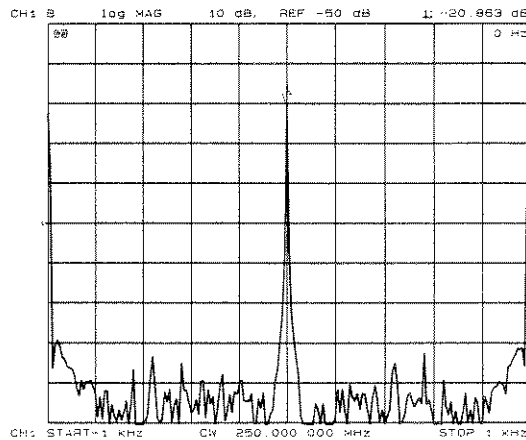

Figure 8-20. Range of a Forward Transform Measurement

To increase the frequency domain measurement range, increase the span. The maximum range is inversely proportional to the sweep time, therefore it may be necessary to increase the number of points or decrease the sweep time. Because increasing the number of points increases the auto sweep time, the maximum range is 2 kHz on either side of the selected CW time measurement center frequency (4 kHz total span). To display a total frequency span of 4 kHz, enter the span as 4000 Hz.

# Chapter 9. Making a Hard Copy Output

---

## CHAPTER CONTENTS

- 9-1 Introduction
- 9-2 [COPY] Key
- 9-2 Copy Menu
- 9-4 Select Quadrant Menu
- 9-5 Define Plot Menu
- 9-6 Configure Plot Menu
- 9-8 Screen Menu

## INTRODUCTION

The HP 8753B can use HP-IB to output measurement results directly to a compatible printer or plotter, without the use of an external controller. The information displayed on the CRT can be copied to a compatible Hewlett-Packard plotter or graphics printer. A plotter provides better resolution than a printer for data displays, while a printer provides higher speed for tabular listings. Refer to the *General Information and Specifications* section of this manual for information about compatible plotters and printers.

To generate a plot or printout from the front panel when there is no other controller on the bus, the HP 8753B must be in system controller HP-IB mode. To take control from the computer and initiate a plot or printout, the HP 8753B must be in pass control mode. If it is not in one of these modes, the message "SYST CTRL or PASS CTRL in LOCAL menu" is displayed. Refer to [LOCAL] Key in Chapter 7 for information on HP-IB controller modes and setting addresses.

### Print/Plot Buffer

The instrument can continue operation while a plot or printout is run. To abort a plot or print in progress, press [LOCAL]. If a print or plot is in progress and a second print or plot is attempted, the message "PRINT/PLOT IN PROGRESS, ABORT WITH LOCAL" is displayed and the second attempt is ignored. An aborted plot or printout cannot be continued: the process must be initiated again if a copy is still required.

## [COPY] KEY

The [COPY] key provides access to the menus used for controlling external plotters and printers and defining the plot parameters.

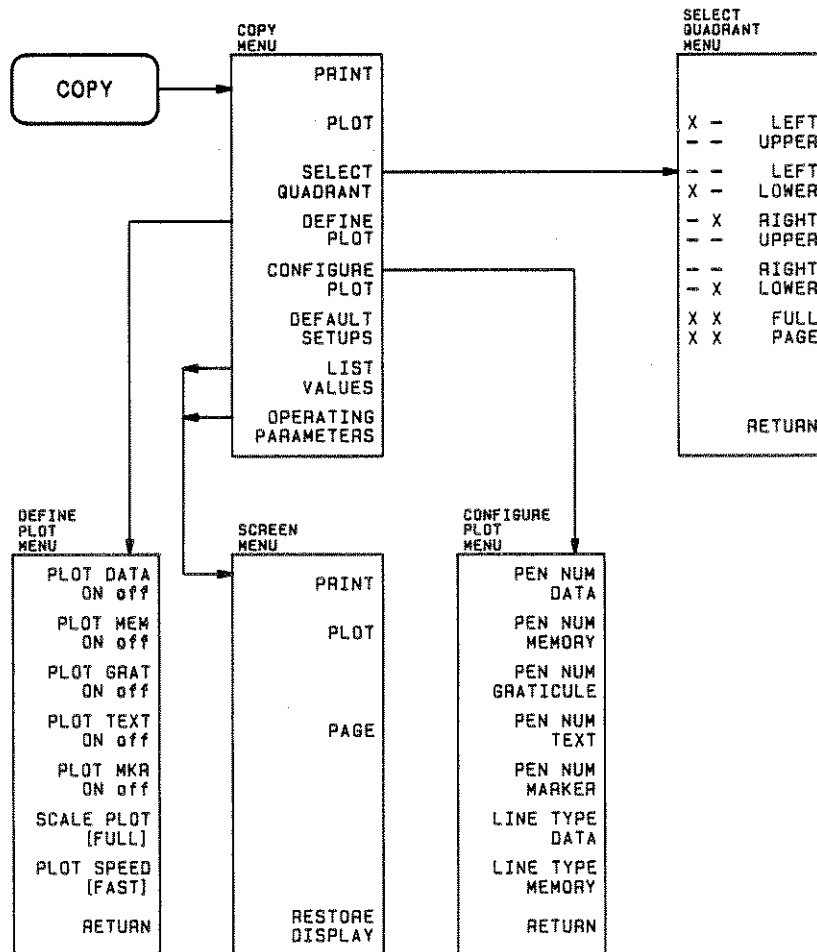

Figure 9-1. Softkey Menus Accessed from the [COPY] Key

## Copy Menu

The copy menu can be used to copy to a printer or to plot using default plot parameters, without the need to access other menus. For user-defined plot parameters, a series of additional menus is available.

This menu also provides tables of operating parameters and measured data values, which can be copied from the screen to a printer or plotter.

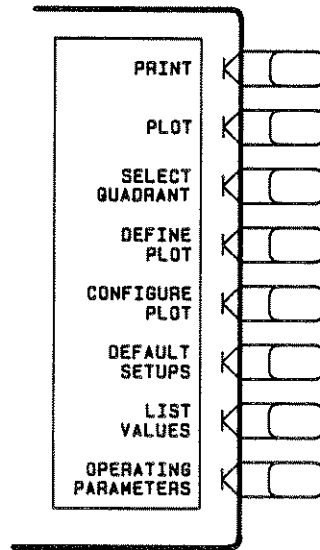

Figure 9-2. Copy Menu

**[PRINT]** (PRINALL) copies the CRT display to a compatible HP graphics printer. Tabular listings or data displays can be printed, although a plotter provides better resolution for data displays. All information from the CRT display is printed except the softkey labels.

**[PLOT]** (PLOT) plots the CRT display to a compatible HP graphics plotter, using the currently defined plot parameters (or default parameters). Any or all displayed information can be plotted, except the softkey labels and CRT listings such as the frequency list table or limit table. (List values and operating parameters can be plotted using the screen menu explained later in this chapter. However, this is considerably slower than printing.)

**[SELECT QUADRANT]** leads to the the select quadrant menu, which provides the capability of drawing quarter-page plots. This is not used for printing.

**[DEFINE PLOT]** leads to the define plot menu, which is used to specify which elements of the display are to be plotted. This is not used for printing.

**[CONFIGURE PLOT]** leads to the configure plot menu, which defines the pen number and line type for each of the plot elements. This is not used for printing.

**[DEFAULT SETUPS]** (DFLT) resets the plotting parameters to their default values. These defaults are as follows:

|                  |                      |
|------------------|----------------------|
| Select quadrant: | Full page            |
| Define plot:     | All plot elements on |
| Plot scale:      | Full                 |
| Plot speed:      | Fast                 |
| Line type:       | 7 (solid line)       |
| Pen numbers:     | Default values       |

Default setups do not apply to printing.

**[LIST VALUES]** (LISV) provides a tabular listing of all the measured data points and their current values, together with limit information if it is turned on. At the same time, the screen menu is presented, to enable hard copy listings and access new pages of the table. 30 lines of data are listed on each page, and the number of pages is determined by the number of measurement points specified in the stimulus menu.

Up to five columns of data are provided. The specific information listed for each measured data point varies depending on the display format, the limit testing status, and whether or not dual channel display or stimulus coupling is selected. If limit testing is on, an asterisk \* is listed next to any measured value that is out of limits. If limit lines are on, and other listed data allows sufficient space, the limits are listed together with the margin by which the device data passes or fails the nearest limit.

**[OPERATING PARAMETERS]** (OPEP) provides a tabular listing on the CRT of the key parameters for both HP 8753B channels. The screen menu is presented to allow hard copy listings and access new pages of the table. Four pages of information are supplied. The first two pages list operating parameters. The third page lists marker parameters. The fourth page lists system parameters that relate to control of peripheral devices rather than selection of measurement parameters.

### Select Quadrant Menu

This menu offers the selection of a full-page plot, or a quarter-page plot in any quadrant of the page.

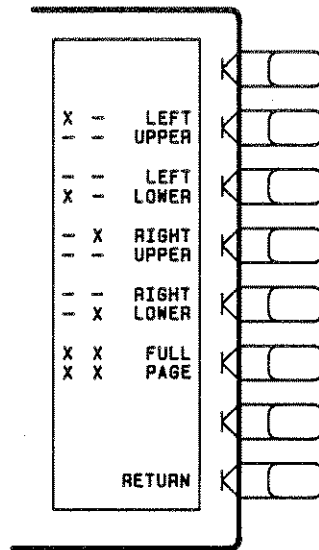

Figure 9-3. Select Quadrant Menu

**[LEFT UPPER]** (LEFU) draws a quarter-page plot in the upper left quadrant of the page.

**[LEFT LOWER]** (LEFL) draws a quarter-page plot in the lower left quadrant of the page.

**[RIGHT UPPER]** (RIGU) draws a quarter-page plot in the upper right quadrant of the page.

**[RIGHT LOWER]** (RIGL) draws a quarter-page plot in the lower right quadrant of the page.



**[FULL PAGE]** (FULP) draws a full-size plot according to the scale defined with **[SCALE PLOT]** in the define plot menu (described next).

**[RETURN]** goes back to the copy menu.

## Define Plot Menu

This menu allows selective plotting of portions of the measurement display. Different plot elements can be turned on or off as required. In addition, different selections are available for plot speed and plot scale, to allow plotting on transparencies and preprinted forms.

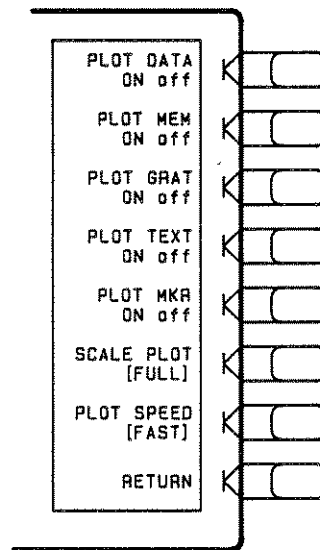

Figure 9-4. Define Plot Menu

**[PLOT DATA ON off]** (PDATAON, PDATAOFF) specifies whether the data trace is to be drawn (on) or not drawn (off) on the plot.

**[PLOT MEM ON off]** (PMEON, PMEMOFF) specifies whether the memory trace is to be drawn (on) or not drawn (off) on the plot. Memory can only be plotted if it is displayed (refer to *Display Menu* in Chapter 4).

**[PLOT GRAT ON off]** (PGRATON, PGRATOFF) specifies whether the graticule and the reference line are to be drawn (on) or not drawn (off) on the plot. Turning **[PLOT GRAT ON]** and all other elements off is a convenient way to make preplotted grid forms. However, when data is to be plotted on a preplotted form, **[PLOT GRAT OFF]** should be selected.

**[PLOT TEXT ON off]** (PTEXTON, PTEXTOFF) selects plotting of all displayed text except the marker values, softkey labels, and CRT listings such as the frequency list table or limit table. (Softkey labels can be plotted under the control of an external controller. Refer to the *Introductory Programming Guide*.)

**[PLOT MKR ON off]** (PMKRON, PMKROFF) specifies whether the markers and marker values are to be drawn (on) or not drawn (off) on the plot.

**[SCALE PLOT]** (SCAPFULL, SCAPGRAT) provides two selections for plot scale, **[FULL]** and **[GRAT]**. **[FULL]** is the normal scale selection for plotting on blank paper, and includes space for all display annotations such as marker values, stimulus values, etc. The entire CRT display fits within the user-defined boundaries of P1 and P2 on the plotter, while maintaining the exact same aspect ratio as the CRT display.

With the selection of **[GRAT]**, the horizontal and vertical scale are expanded or reduced so that the graticule lower left and upper right corners exactly correspond to the user-defined P1 and P2 scaling points on the plotter. This is convenient for plotting on preprinted rectangular or polar forms (for example, on a Smith chart).

To plot on a rectangular preprinted graticule, set P1 of the plotter at the lower left corner of the preprinted graticule, and set P2 at the upper right corner.

To plot on a polar format, set P1 to either the left (or bottom) end point of a diameter and P2 to the right (or top) end point. The HP 8753B will then compute and set new P1 and P2 values to obtain the current circularity. If P1 and P2 are set to within 10% of already being a perfect square, the HP 8753B will not change the boundaries but will distort the circles to fit the user-defined boundaries.

The procedure for plotting on a Smith chart format depends on the plotter capabilities. Some HP plotters have a 90° rotate feature that enables plotting on a portrait (vertical) format rather than a landscape (horizontal) format. Since most Smith charts are printed in portrait format, this rotate feature should be used prior to setting the P1 and P2 points as described above for a polar format.

**[PLOT SPEED]** (PLOSFAST, PLOSSLOW) provides two plot speeds, **[FAST]** and **[SLOW]**. Fast is the proper plot speed for normal plotting. Slow plot speed is used for plotting directly on transparencies; the slower speed provides a more consistent line width. A color plot can be prepared directly on a transparency so that the color is not lost in converting a paper plot to a transparency.

**[RETURN]** goes back to the copy menu.

## **Configure Plot Menu**

This menu is used to select the pens to be used for plotting different elements of a plot, and the line types for the data and memory traces.

Pen numbers 0 through 10 can be selected (0 indicates no pen). It is possible to select a pen number higher than the number of pens in the plotter used. The convention in most Hewlett-Packard plotters is that when the pen number count reaches its maximum number it starts again at 1. Thus in a four-pen plotter, pen #5 actually calls pen #1.

The default pen numbers for the different plot elements vary between channels 1 and 2, so that when a color plotter is used the plots for the two channels can be identified quickly by their colors.

Line types 0 through 10 can be selected. The line types depend on the model of plotter used. In general, however, line type 0 specifies dots only at the points that are plotted; line types 1 through 6 specify broken lines with different spacing; and lines 7 through 10 are solid lines. Refer to the plotter manual for specific line type information.

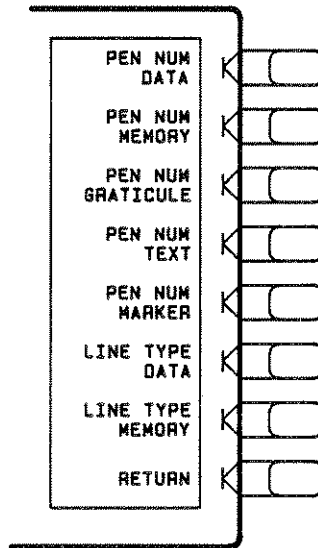

Figure 9-5. Configure Plot Menu

**[PEN NUM DATA]** (PENNDATA) selects the number of the pen to plot the data trace. The default pen for channel 1 is pen #1, and for channel 2 is pen #2.

**[PEN NUM MEMORY]** (PENMEMO) selects the number of the pen to plot the memory trace. The default pen for channel 1 is pen #1, and for channel 2 is pen #2.

**[PEN NUM GRATICULE]** (PENNGRAT) selects the pen number for plotting the graticule. The default pen for channel 1 is pen #3, and for channel 2 is pen #4.

**[PEN NUM TEXT]** (PENNTXT) selects the pen number for plotting the text. The default pen for channel 1 is pen #1, and for channel 2 is pen #2.

**[PEN NUM MARKER]** (PENMARK) selects the pen number for plotting both the markers and the marker values. The default pen for channel 1 is pen #5, and for channel 2 is pen #6.

**[LINE TYPE DATA]** (LINTDATA) selects the line type for the data trace plot. The default line type is 7, which is a solid unbroken line.

**[LINE TYPE MEMORY]** (LINTMEMO) selects the line type for the memory trace plot. The default line type is 7.

**[RETURN]** goes back to the copy menu.

## Screen Menu

This menu is used in conjunction with the **[LIST VALUES]** and **[OPERATING PARAMETERS]** features, to make hard copy listings of the tables displayed on the screen. To make copies from the front panel, make sure that the HP 8753B is in system controller or pass control mode (see Chapter 7).

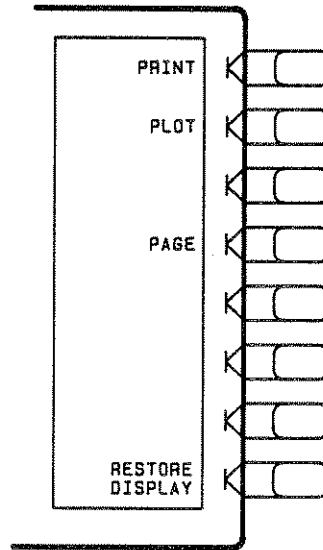

Figure 9-6. Screen Menu

**[PRINT]** (PRINALL) copies one page of the tabular listings to a compatible HP graphics printer connected to the HP 8753B over HP-IB.

**[PLOT]** (PLOT) makes a hard copy plot of one page of the tabular listing on the CRT, using a compatible HP plotter connected to the HP 8753B through HP-IB. This method is appropriate when speed of output is not a critical factor.

**[PAGE]** (NEXP) displays the next page of information in a tabular listing onto the CRT.

**[RESTORE DISPLAY]** (RESD) turns off the tabular listing and returns the measurement display to the screen.

# Chapter 10. Saving Instrument States

## INTRODUCTION

The HP 8753B has the capability of saving complete instrument states for later retrieval. It has five internal registers for this purpose, and can use direct disc access as an extension to internal memory. This chapter discusses instrument state definition, memory allocation, and internal and external memory storage. Refer to the *Introductory Programming Guide* for information on external disc storage using a computer controller. Refer to Chapter 13 for information on saving and recalling keystroke sequences.

## TYPES OF MEMORY

The HP 8753B can utilize three types of memory to store instrument states:

- **Volatile Memory.** This is dynamic read/write memory, containing the current instrument state, calibration sets, and the variables listed in Table 2. It is cleared upon power cycle to the instrument and, except as noted, upon instrument preset.
- **Non-Volatile Memory.** This is CMOS read/write memory, providing short term (minimum 72 hour) storage of data when line power to the instrument is turned off.
- **External Memory.** This utilizes disc media for unlimited storage of instrument states, as well as calibration and measurement data.

Table 1 lists the information that is or can be stored in each type of memory.

Table 1. HP 8753B Memory Usage

|                                                                                                                                                                                                                                                                                                                                                                                                                                                                                                                                                                                                                                                                                |
|--------------------------------------------------------------------------------------------------------------------------------------------------------------------------------------------------------------------------------------------------------------------------------------------------------------------------------------------------------------------------------------------------------------------------------------------------------------------------------------------------------------------------------------------------------------------------------------------------------------------------------------------------------------------------------|
| <p><b>Volatile Memory</b> (see Table 2)</p> <ul style="list-style-type: none"><li>User graphics (16 Kbytes)</li><li>Calibration data</li><li>Current instrument state</li><li>Data processing and display</li><li>5 keystroke sequences</li></ul> <p><b>Non-Volatile Memory</b></p> <ul style="list-style-type: none"><li>Five learn string registers</li><li>CRT focus and intensity defaults</li><li>HP-IB configuration</li><li>User calibration kit definition</li><li>Power sensor cal factor and loss tables</li></ul> <p><b>External Memory</b></p> <ul style="list-style-type: none"><li>Instrument states</li><li>Calibration sets</li><li>Measurement data</li></ul> |
|--------------------------------------------------------------------------------------------------------------------------------------------------------------------------------------------------------------------------------------------------------------------------------------------------------------------------------------------------------------------------------------------------------------------------------------------------------------------------------------------------------------------------------------------------------------------------------------------------------------------------------------------------------------------------------|

## INSTRUMENT STATES

An instrument state consists of all the stimulus and response parameters that set up the HP 8753B to make a specific measurement. This part of the instrument state is called the learn string and, when saved, is saved to non-volatile memory. (Power sensor cal factor and loss tables are independent of the instrument state, although they are also stored in non-volatile memory.)

The learn string is an encoded array containing only the data needed to re-create the state. For example, to re-create a frequency list the HP 8753B only needs to save the start frequency, frequency span, and number of points in each segment. Each point is not recorded. Thus the size of the learn string is not proportional to the number of points in the sweep.

An instrument state also includes calibration data and memory traces, which do vary in size with the number of points.

**NOTE:** Calibration data and memory traces are stored in *volatile* memory. While this data will survive an instrument preset if it has been saved, it is *lost* when line power to the instrument is turned off.

## MEMORY REQUIREMENTS

Because instrument states can be of varying complexities, it is possible to fill the available internal memory with less than five states. Also, it is possible to fill memory with instrument states and prevent such memory-intensive functions as two-port error correction, interpolated error correction, 1601 measurement points, or time domain (option 010).

Calibration sets compete with other instrument processes for volatile memory space. Table 2 contains the memory requirements of calibration arrays and other functions such as list frequency mode and limit testing. As you turn on more functions, it is very likely that more memory space is being used. Use Table 2 to approximate available space. Following Table 2, examples are given of different instrument states and their memory requirements.

Table 2. HP 8753B User Allocatable Memory ( $\cong 960$  Kbytes Total) (1 of 2)

| Variable                      | Data Length (Bytes)                      | Approximate Total (Bytes) |         |          |         |
|-------------------------------|------------------------------------------|---------------------------|---------|----------|---------|
|                               |                                          | 401 pts                   | 801 pts | 1601 pts |         |
|                               |                                          | 1 chan                    |         | 1 chan   | 2 chans |
| <b>Calibration Arrays</b>     |                                          |                           |         |          |         |
| Response                      | $N \times 6 + 52$                        | 2.5k                      | 5k      | 10k      | 19k     |
| Response and Isolation        | $N \times 6 \times 2 + 52$               | 5k                        | 10k     | 19k      | 38k     |
| 1-Port                        | $N \times 6 \times 3 + 52$               | 7k                        | 14k     | 29k      | 58k     |
| 2-Port                        | $N \times 6 \times 12 + 52$              | 29k                       | 58k     | 115k     | 230k    |
| Interpolated Cal              | Same as above in addition to regular cal |                           |         |          |         |
| Power Meter Cal <sup>1</sup>  | $N \times 2 + 208$                       | 1k                        | 1.8k    | 3.4k     | 6.6k    |
| <b>Measurement Data</b>       |                                          |                           |         |          |         |
| Raw Data <sup>1</sup>         | $N \times 6 + 52$                        | 2.5k                      | 4.9k    | 9.7k     | 19k     |
| Plus 2-Port Cal               | $N \times 6 \times 3 + 52$               | 7.3k                      | 14.5k   | 29k      | 58k     |
| Data Array <sup>1</sup>       | $N \times 6 + 52$                        | 2.5k                      | 4.9k    | 9.7k     | 19k     |
| Formatted Array <sup>1</sup>  | $N \times 6 + 52$                        | 2.5k                      | 4.9k    | 9.7k     | 19k     |
| Memory Array <sup>1</sup>     | $N \times 6 + 52$                        | 2.5k                      | 4.9k    | 9.7k     | 19k     |
| Scratchpad Array <sup>2</sup> | $N \times 6 + 52$                        | 2.5k                      | 4.9k    | 9.7k     | 19k     |

Table 2. HP 8753B User Allocatable Memory ( $\cong 960$  Kbytes Total) (2 of 2)

| Variable                                                                               | Data Length (Bytes)                       | Approximate Total (Bytes) |         |          |         |
|----------------------------------------------------------------------------------------|-------------------------------------------|---------------------------|---------|----------|---------|
|                                                                                        |                                           | 401 pts                   | 801 pts | 1601 pts |         |
|                                                                                        |                                           | 1 chan                    |         | 1 chan   | 2 chans |
| <b>Display Memory<sup>1</sup></b>                                                      |                                           |                           |         |          |         |
| Trace (data or memory)                                                                 | N x 2                                     | 0.8k                      | 1.6k    | 3.2k     | 6.4k    |
| In polar format, log frequency, or frequency list mode                                 | N x 4                                     | 1.6k                      | 3.2k    | 6.4k     | 12.8k   |
| Graticule                                                                              |                                           |                           |         |          |         |
| Rectangular                                                                            | 196                                       | 0.2k                      | 0.2k    | 0.2k     | 0.4k    |
| Semilog                                                                                | 420                                       | 0.4k                      | 0.4k    | 0.4k     | 0.8k    |
| Polar                                                                                  | 1956                                      | 2k                        | 2k      | 2k       | 4k      |
| Smith/Inverted Smith                                                                   | 4000                                      | 4k                        | 4k      | 4k       | 8k      |
| Limit Lines <sup>1</sup>                                                               | 32 x number of segments (max 18 per chan) | 0.6k                      | 0.6k    | 0.6k     | 1.1k    |
| <b>Operating Modes</b>                                                                 |                                           |                           |         |          |         |
| Sampler Correction Arrays <sup>1</sup>                                                 |                                           |                           |         |          |         |
| With 2-Port Cal                                                                        | N x 2                                     | 0.8k                      | 1.6k    | 3.2k     | 6.4k    |
| In Frequency List Mode                                                                 | N x 4                                     | 1.6k                      | 3.2k    | 6.4k     | 12.8k   |
| Freq List + 2-Port                                                                     | N x 4                                     | 1.6k                      | 3.2k    | 6.4k     | 12.8k   |
|                                                                                        | N x 4 x 2                                 | 3.2k                      | 6.4k    | 12.8k    | 25.6k   |
| Frequency List Mode <sup>1</sup>                                                       | N x 12                                    | 4.8k                      | 9.6k    | 19k      | 38k     |
| Log Frequency Mode <sup>1</sup>                                                        | N x 12                                    | 4.8k                      | 9.6k    | 19k      | 38k     |
| Smoothing on <sup>1</sup><br>(20% aperture, 1601 points)                               | 2000                                      | 2k                        | 4k      | 2k       | 4k      |
| Print/Plot Buffer <sup>3</sup><br>(in addition to trace, graticule, limit lines, etc.) |                                           | 1k                        | 1k      | 1k       | 1k      |
| Sequencing<br>(5 of 2 Kbytes each)                                                     |                                           | 10k                       | 10k     | 10k      | 10k     |
| Time Domain                                                                            |                                           |                           |         |          |         |
| FFT Array                                                                              |                                           |                           |         |          |         |
| ≤51 points                                                                             | 128 x 6 = 0.8k                            |                           |         |          |         |
| 101 points                                                                             | 256 x 6 = 1.5k                            |                           |         |          |         |
| 201 points                                                                             | 512 x 6 = 3k                              |                           |         |          |         |
| 401 points                                                                             | 1024 x 6                                  | 6k                        |         |          |         |
| 801 points                                                                             | 2048 x 6                                  |                           | 12.3k   |          |         |
| 1601 points                                                                            | 2048 x 6                                  |                           |         | 12.3k    | 24.6k   |
| Window & Chirp Array                                                                   | N x 4 + FFT array                         | 6.4k                      | 13k     | 18k      | 37k     |
| Gating Array                                                                           | $\cong 5/3$ x FFT array                   | 8k                        | 16k     | 20k      | 41k     |

**Notes:**

N = number of points

1. This variable is allocated once per active channel.
2. Insufficient memory for allocation of this array is not fatal. The array is used to recalculate the data for display any time formatting factors are changed. If sufficient memory is not allocated, trace data will not be redisplayed after a scaling change until a new sweep occurs.
3. Insufficient memory for allocation of this array is not fatal, but instrument operation cannot be continued while printing or plotting is in progress.

## Memory Allocation Examples

The following examples show the basic memory requirements of various memory-intensive instrument states, and the extra memory needed as features are added. These examples assume that no other instrument states or calibration sets are saved.

|                                                                                                                                               | Total (Bytes) |
|-----------------------------------------------------------------------------------------------------------------------------------------------|---------------|
| ● 401 points, 2 channels, full 2-port cal, no interpolated cal, no time domain, no list mode, no memory arrays                                | 93k           |
| add memory trace                                                                                                                              | 100k          |
| add interpolated cal                                                                                                                          | 158k          |
| add time domain, with windowing and gating                                                                                                    | 199k          |
| add frequency list mode                                                                                                                       | 215k          |
| ● 401 points, 1 channel, full 2-port interpolated cal with original cal arrays at 1601 points, no time domain, no list mode, no memory arrays | 159k          |
| add memory trace                                                                                                                              | 162k          |
| add frequency list mode                                                                                                                       | 169k          |
| add time domain, with windowing and gating                                                                                                    | 189k          |
| all of the above on both channels                                                                                                             | 378k          |
| ● 801 points, 1 channel, full 2-port cal, no interpolated cal, no time domain, no list mode, no memory arrays                                 | 93k           |
| add memory trace                                                                                                                              | 100k          |
| add interpolated cal                                                                                                                          | 158k          |
| add time domain, with windowing and gating                                                                                                    | 199k          |
| add frequency list mode                                                                                                                       | 212k          |
| all of the above on both channels                                                                                                             | 418k          |
| ● 1601 points, 1 channel, full 2-port cal, no interpolated cal, no time domain, no list mode, no memory arrays                                | 183k          |
| add memory trace                                                                                                                              | 196k          |
| add interpolated cal                                                                                                                          | 311k          |
| add time domain, with windowing and gating                                                                                                    | 361k          |
| add list mode                                                                                                                                 | 387k          |
| all of the above on both channels                                                                                                             | 773k          |

## INTERNAL SAVE

A maximum of six instrument states can reside in internal memory at any one time: five saved states and the active instrument state. Up to 12 calibrations can exist if they are saved at the end of the calibration procedure (the actual number may be limited by available memory). Remember, however, that calibrations are lost when instrument power is turned off.

Calibration sets are linked to the instrument state and measurement parameter for which the calibration was done. Therefore a saved calibration can be used for multiple instrument states as long as the measurement parameter, frequency range, and number of points are the same. A full 2-port calibration is valid for any S-parameter measurement with the same frequency range and number of points. When an instrument state is deleted from memory (see *[CLEAR REGISTER]*), the associated calibration set is also deleted.

If a measurement is saved with calibration and interpolated calibration on, it will be restored with interpolated calibration on.



## EXTERNAL STORE

When the HP 8753B is in system controller mode or pass control mode, it can access an external CS80 disc drive such as the HP 9122. Storing to disc records not only the instrument state, but also calibration sets and measurement data (see [DEFINE STORE]).

The HP 8753B uses one file name per stored instrument state when communicating with the user via the front panel display. In reality, several files are actually stored to the disc when an instrument state is stored. Thus, when the disc catalog is accessed from a remote system controller, the directory will show several files associated with a particular saved state. The maximum number of files that can be stored on a disc depends on the directory size: the default is 256. Refer to the *Introductory Programming Guide* for further information.

A disc file created by the HP 8753B appends a suffix to the file name. (This is used by an external controller for cataloguing files, and is not visible to a local user.) The suffix consists of one or two characters: the first character is the file type and the second is a data index. The *Quick Reference Guide* includes a list of the characters used in file name suffixes, and their meanings.

If correction is on at the time of an external store, the calibration set is stored to disc. (Note that inactive calibrations are not stored to disc.) When an instrument state is loaded into the HP 8753B from disc, the learn string is restored first. If correction is on for the loaded state, the HP 8753B will load a calibration set from disc that carries the same title as the one stored for the instrument state.

If an instrument state is stored with interpolated calibration on, the restored instrument state will be interpolated.

**NOTE:** A calibration stored from one instrument and recalled by a different one will be invalid. To ensure maximum accuracy, always recalibrate in these circumstances.

**NOTE:** No record is kept in memory of the temperature when a calibration set was stored. Instrument characteristics change as a function of temperature, and a calibration stored at one temperature may be inaccurate if recalled and used at a different temperature. Refer to the *Specifications* tables in the *General Information* section for allowable temperature ranges for individual specifications.

**NOTE:** HP 8753B and 8753A instrument states are not compatible, therefore discs stored by one cannot be used by the other.

## [SAVE] AND [RECALL] KEYS

The [SAVE] key provides access to all the menus used for saving instrument states in internal memory and for storing to external disc. This includes the menus used to define titles for internal registers and external disc files, to define the content of disc files, to initialize discs for storage, and to clear data from the registers or purge files from disc.

The [RECALL] key leads to the menus that recall the contents of internal registers, or load files from external disc back into the HP 8753B.

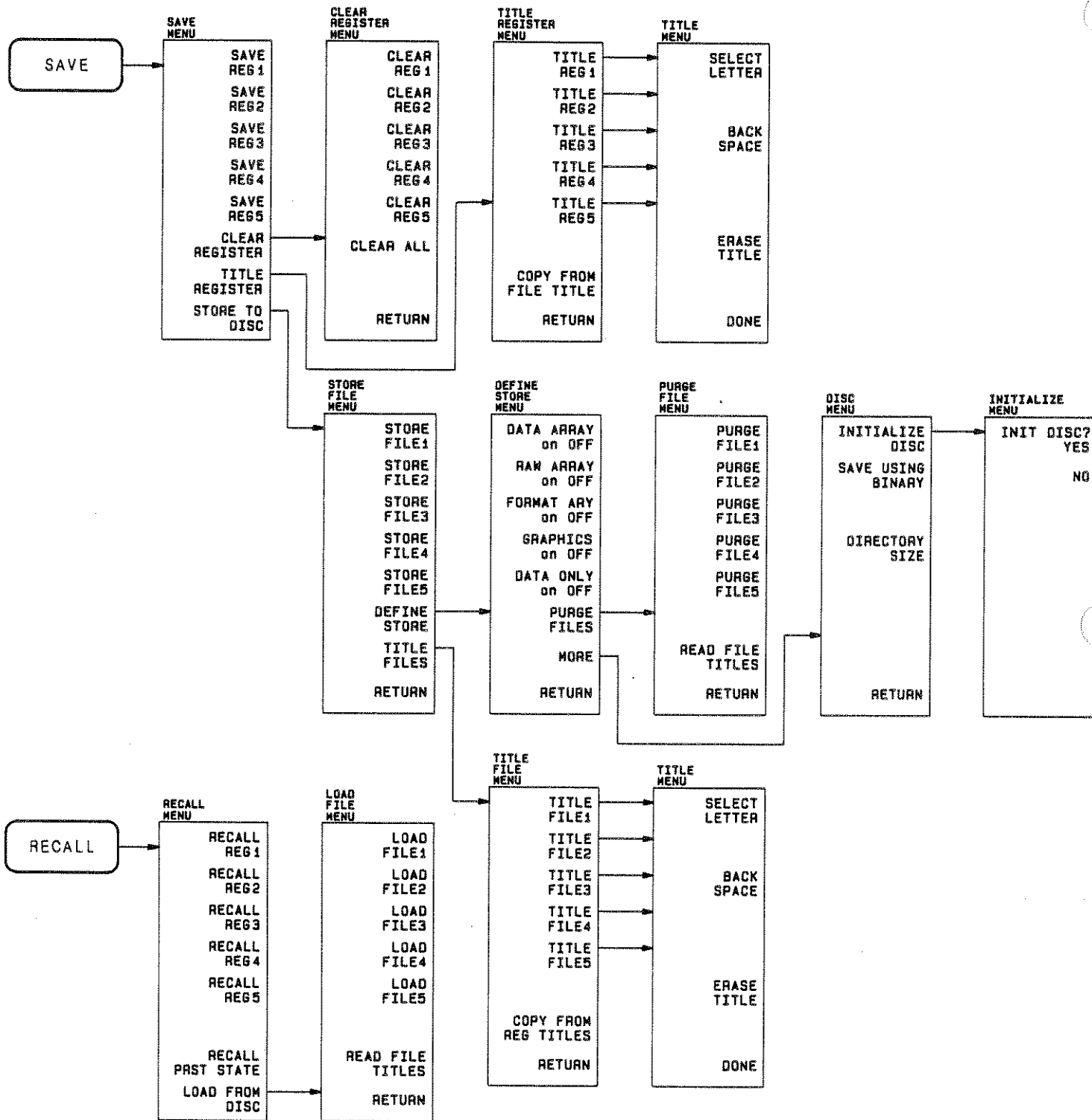

Figure 10-1. Softkey Menus Accessed from the [SAVE] and [RECALL] Keys

## Save Menu

This menu (Figure 10-2) selects an internal memory register to store the current instrument state. If a register contains a previously saved instrument state, the softkey label changes to **[RESAVE]**. This is intended to prevent inadvertent destruction of saved states. Pressing **[RESAVE]** removes the contents of the register and saves the new instrument state.

This also leads to the series of menus for external disc storage.

The default titles for the save registers are REG1 through REG5, but these titles can be modified using the title register menu and the title menu.

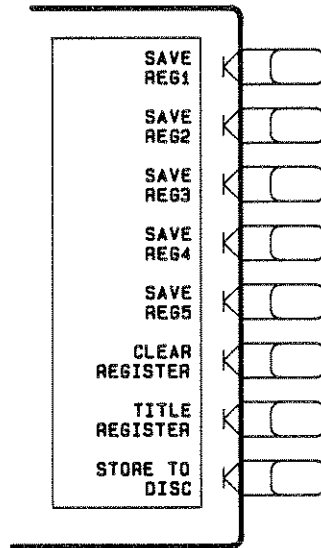

Figure 10-2. Save Menu

**[SAVE REG1]** (SAVE1) saves the present instrument state in an internal register titled REG1.

**[SAVE REG2]** (SAVE2) saves the present instrument state in internal register REG2.

**[SAVE REG3]** (SAVE3) saves the present instrument state in internal register REG3.

**[SAVE REG4]** (SAVE4) saves the present instrument state in internal register REG4.

**[SAVE REG5]** (SAVE5) saves the present instrument state in internal register REG5.

**[CLEAR REGISTER]** leads to the clear register menu, described on the next page.

**[TITLE REGISTER]** leads to the title register menu, where the default register titles can be modified.

**[STORE TO DISC]** leads to the store file menu, which introduces a series of menus for disc storage.

## Clear Register Menu

This menu (Figure 10-3) allows unused instrument states to be cleared from save registers, making the assigned memory available for other uses. When an instrument state is deleted from memory, the associated calibration set is also deleted. You can choose to selectively clear individual registers, or clear all registers with one keystroke.

Clearing of registers is performed internally with 100 alternating 0 and 1 rewrite operations over the entire non-volatile portion of the specified register memory.

Only registers that have instrument states previously stored in them are listed in this menu.

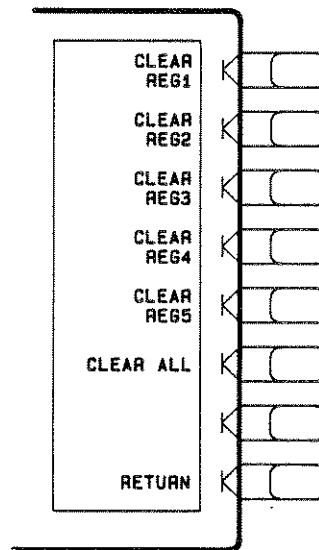

Figure 10-3. Clear Register Menu

**[CLEAR REG1]** (CLEA1) clears a previously saved instrument state from register 1.

**[CLEAR REG2]** (CLEA2) clears a saved instrument state from register 2.

**[CLEAR REG3]** (CLEA3) clears a saved instrument state from register 3.

**[CLEAR REG4]** (CLEA4) clears a saved instrument state from register 4.

**[CLEAR REG5]** (CLEA5) clears a saved instrument state from register 5.

**[CLEAR ALL]** (CLEARALL) clears all instrument states.

**[RETURN]** goes back to the save menu.

## Title Register Menu

This menu can be used to select a register to be retitled. All registers are listed, regardless of whether or not they contain saved instrument states. When any of the title register softkeys is pressed, the title menu is presented and the character set is displayed in the active entry area.

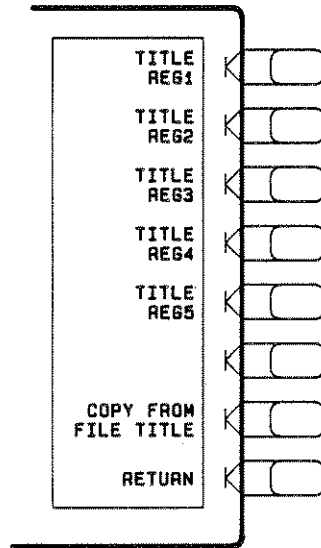

Figure 10-4. Title Register Menu

**[TITLE REG1]** (TITR1) selects register 1 to be retitled and presents the title menu and the character set.

**[TITLE REG2]** (TITR2) selects register 2 to be retitled.

**[TITLE REG3]** (TITR3) selects register 3 to be retitled.

**[TITLE REG4]** (TITR4) selects register 4 to be retitled.

**[TITLE REG5]** (TITR5) selects register 5 to be retitled.

**[COPY FROM FILE TITLE]** (COPYFRFT) renames the internal registers to match the current names of the store files. For example, the default names of the internal registers are REG1 through REG5. The default names of the store files are FILE1 through FILE5. Pressing this key would rename the internal registers FILE1 through FILE5. If you have modified the names of the store files, the modified names would be copied as the internal save register names.

**[RETURN]** goes back to the save menu.

## Title Menu

Use this menu (Figure 10-5) to define a title for the register selected in the title register menu. The title replaces the default register title in the softkey label, and is recalled with the saved instrument state.

The register title is limited to eight characters. If more than eight characters are selected, the last character is repeatedly written over. The title must be all alpha-numeric, and must start with an alpha character. If the first character selected is not an alpha character, the message "CAUTION: FIRST CHARACTER MUST BE A LETTER" is displayed when the **[DONE]** key is pressed. No special characters or spaces are allowed. If a disallowed character is selected, the message "CAUTION: ONLY LETTERS & NUMBERS ARE ALLOWED" is displayed. (The special characters are used only for the display title, described in Chapter 4.)

The save register title is independent of the display title, which is also saved and recalled as part of the display.

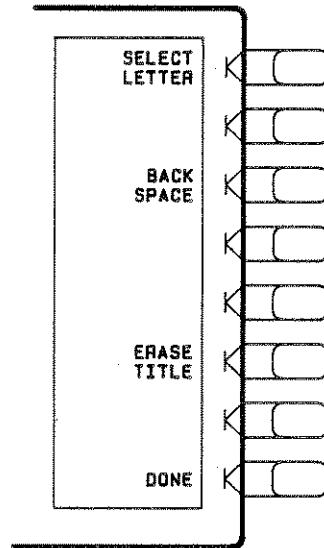

Figure 10-5. Title Menu

**[SELECT LETTER]**. The active entry area displays the letters of the alphabet, digits 0 through 9, and mathematical symbols. The mathematical symbols are not used in register titles. To define a title, rotate the knob until the arrow ↑ points at the first letter, then press **[SELECT LETTER]**. Repeat this until the complete title is defined, for a maximum of eight characters. As each character is selected, it is appended to the title at the top left corner of the graticule.

**[BACK SPACE]** deletes the last character entered.

**[ERASE TITLE]** deletes the entire register title.

**[DONE]** terminates the title entry, and returns to the title register menu. The new title appears in the softkey label in all applicable menus.

## Store File Menu

This menu (Figure 10-6) is used to store instrument states to an external disc rather than to internal memory registers. The HP 8753B can use HP-IB to store directly to a compatible disc drive, without the use of an external controller. Refer to the *General Information* section of this manual for information about compatible disc drives. Refer to the first part of this chapter for information about disc storage.

To store information on an external disc from the front panel when there is no other controller on the bus, the HP 8753B must be in system controller HP-IB mode. To take control from the computer and initiate a store operation, the HP 8753B must be in pass control mode. If it is not in one of these modes, the message "SYST CTRL OR PASS CTRL IN LOCAL MENU" is displayed. Refer to [LOCAL] Key in Chapter 7 for information on HP-IB controller modes and setting addresses.

If you attempt to store a file and the message "CAUTION: DISC: not on, not connected, wrong addr" is displayed, check the disc drive line power and HP-IB cable connection. Also make sure that the HP-IB address of the disc drive matches the address set in the address menu (see Chapter 7).

The HP 8753B uses one file name per instrument state for communicating with the user via the front panel display. In reality, several files might actually be stored to the disc when an instrument state is saved, depending on the functions being saved. This does not affect operation from the front panel. The default names for the stored files are FILE1 through FILE5. These file names can be modified using the title file menu.

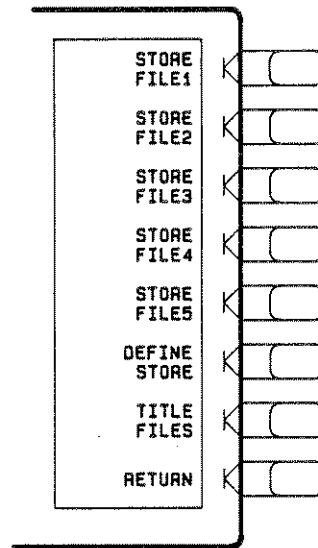

Figure 10-6. Store File Menu

[STORE FILE1] (STOR1) stores the current instrument state in disc file 1, together with any data specified in the define store menu (see next page).

[STORE FILE2] (STOR2) stores the current instrument state and specified data in file 2.

[STORE FILE3] (STOR3) stores the current instrument state and specified data in file 3.

[STORE FILE4] (STOR4) stores the current instrument state and specified data in file 4.

[STORE FILE5] (STOR5) stores the current instrument state and specified data in file 5.

**[DEFINE STORE]** leads to the define store menu. Use this menu to specify the data to be stored on disc in addition to the instrument state.

**[TITLE FILES]** leads to the title file menu, where the default file titles can be modified.

**[RETURN]** goes back to the save menu.

## Define Store Menu

Data and user graphics can be stored on disc along with the basic instrument state. The data can be stored from different points in the data processing flow. It is possible to store raw, error-corrected, or formatted data, or any combination of the three. This menu allows the option of specifying what data is to be stored. Refer to *Data Processing Flow* in Chapter 1 for more information about data arrays and the sequence of data processing events.

If a memory trace exists and is displayed, either alone or in a memory math function, it is automatically stored with the data.

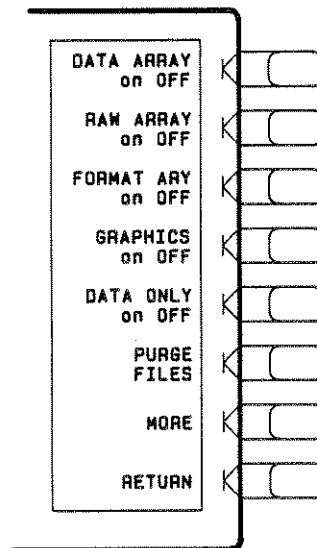

Figure 10-7. Define Store Menu

**[DATA ARRAY on OFF]** (EXTMDATAON, EXTMDATAOFF) specifies whether or not to store the error-corrected data on disc with the instrument state.

**[RAW ARRAY on OFF]** (EXTMRAWON, EXTMRAWOFF) specifies whether or not to store the raw data (ratioed and averaged) on disc with the instrument state.

**[FORMAT ARY on OFF]** (EXTMFORMON, EXTMFORMOFF) specifies whether or not to store the formatted data on disc with the instrument state.

**[GRAPHICS on OFF]** (EXTMGRAPON, EXTMGRAPOFF) specifies whether or not to store display graphics on disc with the instrument state.



**[DATA ONLY on OFF]** stores only the measurement data of the device under test. The instrument state and calibration are not stored. This is faster than storing with the instrument state, and uses less disc space. It is intended for use in archiving data that will later be used with an external controller, and cannot be read back by the HP 8753B.

**[PURGE FILES]** leads to the purge files menu, which is used to remove the information stored on an external disc.

**[MORE]** leads to the disc menu, where additional parameters are defined for storing to disc. This in turn leads to the initialize menu.

**[RETURN]** goes back to the store file menu.

## Purge File Menu

This menu is used to remove (purge) stored information from a disc. When the purge file menu is entered, the file titles currently in HP 8753B memory are displayed. (File titles are stored in non-volatile memory.) These titles may or may not reside on the disc currently being used. The file titles can be updated to match the files on disc by reading the disc's directory with the **[READ FILE TITLES]** key.

The purge file menu is the external storage equivalent of the clear register menu.

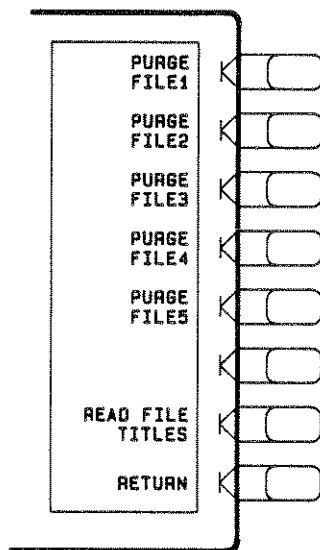

Figure 10-8. Purge File Menu

**[PURGE FILE1]** (PURG1) purges FILE1 from the disc. If no file of that name exists on the disc, the message "CAUTION: NO FILE(S) FOUND ON DISC" will appear.

**[PURGE FILE2]** (PURG2) purges FILE2 from the disc.

**[PURGE FILE3]** (PURG3) purges FILE3 from the disc.

**[PURGE FILE4]** (PURG4) purges FILE4 from the disc.

**[PURGE FILE5]** (PURG5) purges FILE5 from the disc.

**[READ FILE TITLES]** (REFT) searches the directory of the disc for file names recognized as belonging to an instrument state, and displays them in the softkey labels. No more than five titles are displayed at one time. If there are more than five, repeatedly pressing this key causes the next five to be displayed. If there are fewer than five, the remaining softkey labels are blanked.

**[RETURN]** goes back to the define store menu.

## Disc Menu

This menu provides additional parameters for defining disc storage.

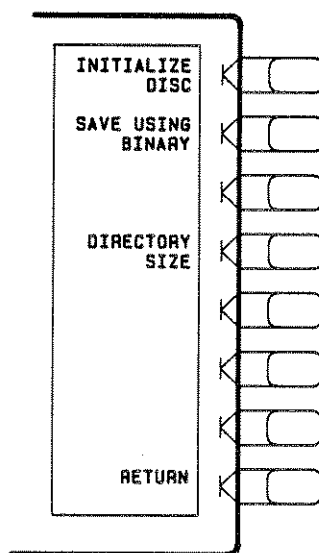

Figure 10-9. Disc Menu

**[INITIALIZE DISC]** leads to the initialize menu. Before data can be stored on a disc, the disc must be initialized for format compatibility. (This is *disc* format: the *data* format is binary, as explained below.) If you attempt to store without initializing the disc, the message "CAUTION: DISC MEDIUM NOT INITIALIZED" is displayed.

**[SAVE USING BINARY]** stores the instrument state and data in binary format. This is presently the appropriate data format for all file storage. (This softkey is for information only.)

If a disc was formatted with another operating system such as UNIX or MS-DOS, the HP 8753B will not read from it nor write to it, nor alter it in any way. If a store operation is attempted with such a disc, the message "WRONG DISC FORMAT, INITIALIZE DISC" is displayed.

**[DIRECTORY SIZE]** lets you specify the number of directory files to be initialized on a disc. This is particularly useful with a hard disc, where you may want a directory larger than the default 256 files. Or with a floppy disc you may want to reduce the directory to allow extra space for data files. The number of directory files must be a multiple of 8. The minimum number is 8, and there is no practical maximum limit. Set the directory size before initializing a disc.

**[RETURN]** goes back to the define store menu.

## Initialize Menu

Initializing a disc prepares it to store data. A disc must be initialized for format compatibility before it can be used for storage. (This is *disc* format: the *data* format is binary, as explained above.) This menu initializes discs using LIF (logical interchange format) to provide compatibility with HP 9000 series 200/300 computers. A disc initialized on one of these computers will work with the HP 8753B. The recommended interleave factor is 7. Either the Hewlett-Packard black or gray double-sided discs can be used with the HP 9122 disc drive: if high transfer speed is a consideration, gray is recommended. Refer to the *General Information and Specifications* section for information about discs.

Initializing a disc removes all existing data. When this menu is presented, the message "INIT DISC removes all data from disc" is displayed. If other error messages are encountered, refer to Chapter 12, *Error Messages*, for help.

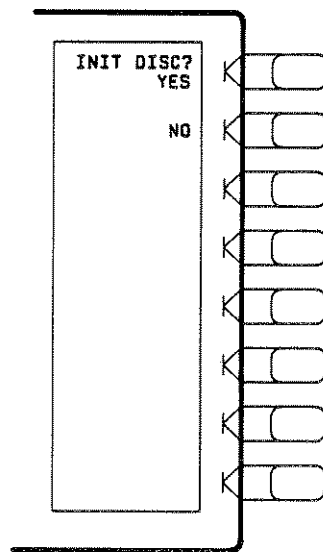

Figure 10-10. Initialize Menu

**[INIT DISC? YES]** initializes the disc unit number and volume number selected in the HP-IB menu (see Chapter 7), then returns to the disc menu. If more than one hard disc volume is to be initialized, each volume must be selected and initialized individually.

During the initialization process, the message "WAITING FOR DISC" is displayed: this is normal. If the disc is damaged, the message "INITIALIZATION FAILED" is displayed.

**[NO]** leaves this menu without initializing the disc, and returns to the disc menu.

## Title File Menu

This menu (Figure 10-11) is used to select a disc file to be retitled. When the softkey for the selected file is pressed, the title menu is presented and the character set is displayed in the active entry area. The title menu is described earlier in this chapter. The same restrictions apply to file titles as to internal register titles: that is, a file title is limited to eight characters, must be all alpha-numeric, and must begin with an alpha character.

A file title defined with the title menu replaces the default file title in the softkey label, and is stored to disc with the corresponding file.

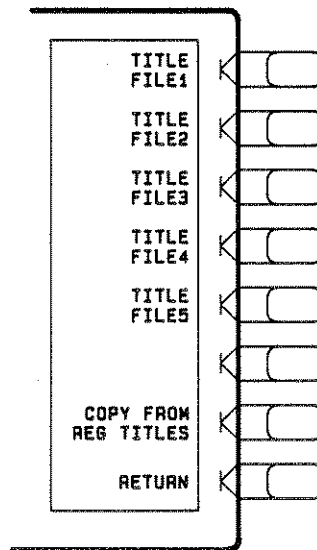

Figure 10-11. Title File Menu

**[TITLE FILE1]** (TITF1) selects file 1 to be retitled, and leads to the title menu.

**[TITLE FILE2]** (TITF2) selects file 2 to be retitled.

**[TITLE FILE3]** (TITF3) selects file 3 to be retitled.

**[TITLE FILE4]** (TITF4) selects file 4 to be retitled.

**[TITLE FILE5]** (TITF5) selects file 5 to be retitled.

**[COPY FROM REG TITLES]** renames the store files to match the current names of the internal registers. (It does not alter the names of any files already stored to disc). For example, the default names of the internal registers are REG1 through REG5. The default file names of the store files are FILE1 through FILE5. Pressing this key would rename the store files REG1 through REG5. If you have modified the names of the internal save registers, the modified names are copied as the store file names.

**[RETURN]** goes back to the store file menu.

## Recall Menu

This menu is used to recall instrument states from internal memory. It is also used to access the load file menu, which loads files from external disc.

When the recall menu is displayed, only the names of registers containing instrument states are displayed in the top five softkey labels. Any register that does not currently contain a saved instrument state has its softkey label blanked.

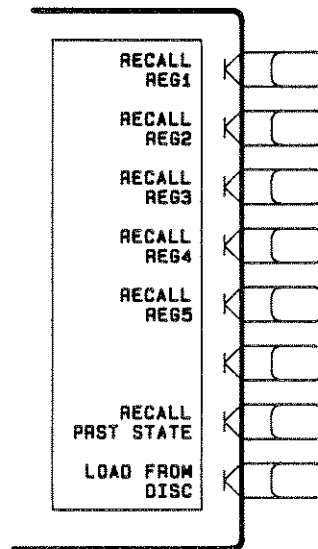

Figure 10-12. Recall Menu

**[RECALL REG1]** (RECA1) recalls the instrument state saved in register 1. The current instrument state is overwritten.

**[RECALL REG2]** (RECA2) recalls the instrument state saved in register 2.

**[RECALL REG3]** (RECA3) recalls the instrument state saved in register 3.

**[RECALL REG4]** (RECA4) recalls the instrument state saved in register 4.

**[RECALL REG5]** (RECA5) recalls the instrument state saved in register 5.

**[RECALL PRST STATE]** is used in conjunction with sequencing, to return the instrument to the known preset state without turning off the sequencing function. This is not the same as pressing the **[PRESET]** key: no preset tests are run, and the HP-IB and sequencing activities are not changed.

**[LOAD FROM DISC]** accesses the load file menu. Use this menu to restore instrument states previously stored to disc.

## Load File Menu

This menu (Figure 10-13) is used to search the directory of a disc and restore previously stored instrument state files.

There are three ways to locate a file on disc.

1. The HP 8753B remembers the names of the last five files it previously found on any disc. (File titles are stored in non-volatile memory.) Therefore, when you enter this menu, the file titles in memory will appear in the top five softkeys, whether or not they reside on the disc currently in the drive.
2. The **[READ FILE TITLES]** key in this menu causes the HP 8753B to search the directory of the current disc and display any file titles recognized as compatible.
3. From the store file menu, use the **[TITLE FILES]** key to title a store file softkey with the name of the file you want to restore. Return to the load file menu. The title you just created will appear in one of the load file softkey labels. Press that softkey. If the file does not exist, the message "CAUTION: NO FILE(S) FOUND ON DISC" will be displayed. This method is useful only if you know the exact name of the instrument state to be restored. Using **[READ FILE TITLES]** is a more efficient method of finding file names, unless a large number of instrument states has been stored to the disc.

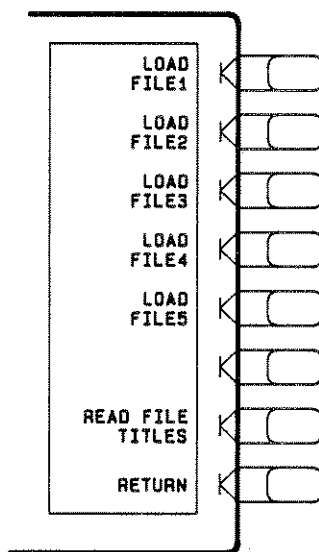

Figure 10-13. Load File Menu

**[LOAD FILE1]** (LOAD1) restores the instrument state contained in FILE1. The current instrument state is overwritten.

**[LOAD FILE2]** (LOAD2) restores the instrument state contained in FILE2.

**[LOAD FILE3]** (LOAD3) restores the instrument state contained in FILE3.

**[LOAD FILE4]** (LOAD4) restores the instrument state contained in FILE4.

**[LOAD FILE5]** (LOAD5) restores the instrument state contained in FILE5.

**[READ FILE TITLES]** (REFT) searches the directory of the disc for file names recognized as belonging to an instrument state. No more than five titles are displayed at one time. If there are more than five, repeatedly pressing this key causes the next five to be displayed. If there are fewer than five, the remaining softkey labels are blanked.

**[RETURN]** goes back to the recall menu.





# Chapter 11. HP-IB Remote Programming

---

## CHAPTER CONTENTS

|      |                                 |
|------|---------------------------------|
| 11-1 | Introduction                    |
| 11-2 | How HP-IB Works                 |
| 11-3 | HP-IB Bus Structure             |
| 11-5 | HP-IB Requirements              |
| 11-5 | HP 8753B HP-IB Capabilities     |
| 11-6 | Bus Mode                        |
| 11-7 | Setting Addresses               |
| 11-7 | Valid Characters                |
| 11-7 | HP 8753B Code Naming Convention |
| 11-8 | Units and Terminators           |
| 11-8 | HP-IB Debug Mode                |
| 11-8 | CRT Graphics                    |

## INTRODUCTION

The HP 8753B is factory-equipped with a remote programming digital interface using the Hewlett-Packard Interface Bus (HP-IB). (HP-IB is Hewlett-Packard's hardware, software, documentation, and support for IEEE 488.1 and IEC-625, worldwide standards for interfacing instruments.) This allows the HP 8753B to be controlled by an external computer that sends commands or instructions to and receives data from the HP 8753B using the HP-IB. In this way, a remote operator has the same control of the instrument available to a local operator from the front panel, except for control of the line power switch.

In addition, the HP 8753B itself can use HP-IB to directly control compatible peripherals, without the use of an external controller. It can output measurement results directly to a compatible printer or plotter, or store instrument states to a compatible disc drive.

This chapter provides an overview of HP-IB operation. Chapter 7 provides information on different controller modes, and on setting up the HP 8753B as a controller of peripherals. Chapters 9 and 10 explain how to use the HP 8753B as a controller to print, plot, and store to an external disc. In addition, HP-IB equivalent mnemonics for front panel functions are provided in parentheses throughout this *Operating and Programming Reference*.

More complete information on programming the HP 8753B remotely over HP-IB is provided in the following documents:

- *Introductory Programming Guide for the HP 8753B Using Series 200/300 Computers*. This is a tutorial introduction to remote operation of the HP 8753B network analyzer using an HP 9000 series 200 or 300 computer. It includes examples of remote measurements using BASIC programming. These examples are also stored on the example programs disc provided with the HP 8753B. The *Introductory Programming Guide* assumes familiarity with front panel operation of the instrument.

- *HP 8753B Quick Reference Guide*. This is a complete reference summary for remote operation of the HP 8753B with a controller. It includes both functional and alphabetical lists of all HP 8753B HP-IB commands. This guide is intended for use by those familiar with HP-IB programming and the basic functions of the HP 8753B.
- *Network Analyzer Compatibility Guide*. This document is designed for use as a reference when information is required regarding HP-IB compatibility between network analyzers in the HP 8510 and 8700 series. Commands are listed for the HP 8510, 8753A, and 8720A network analyzers and the HP 8702A lightwave component analyzer. Future revisions will include HP-IB commands specific to the HP 8753B.

A complete general description of the HP-IB is available in *Tutorial Description of the Hewlett-Packard Interface Bus*, HP publication 5952-0156. For more information on the IEEE-488.1 standard refer to *IEEE Standard Digital Interface for Programmable Instrumentation*, published by the Institute of Electrical and Electronics Engineers, Inc., 345 East 47th Street, New York, New York 10017.

## HOW HP-IB WORKS

The HP-IB uses a party-line bus structure in which up to 15 devices can be connected on one contiguous bus. The interface consists of 16 signal lines and 8 ground lines in a shielded cable. With this cabling system, many different types of devices including instruments, computers, plotters, printers, and disc drives can be connected in parallel.

Every HP-IB device must be capable of performing one or more of the following interface functions:

### Talker

A talker is a device capable of sending device-dependent data when addressed to talk. There can be only one talker at any given time. Examples of this type of device are voltmeters, counters, and tape readers. The HP 8753B is a talker when it sends trace data or marker information over the bus.

### Listener

A listener is a device capable of receiving device-dependent data when addressed to listen. There can be any number of listeners at any given time. Examples of this type of device are printers, power supplies, and signal generators. The HP 8753B is a listener when it is controlled over the bus by a computer.

### Controller

A controller is a device capable of managing the operation of the bus and addressing talkers and listeners. There can be only one active controller at any time. Examples of controllers include desktop computers and minicomputers. In a multiple-controller system, active control can be passed between controllers, but there can only be one *system controller*, which acts as the master, and can regain active control at any time. The HP 8753B is an active controller when it plots, prints, or stores to an external disc drive in the pass control mode. The HP 8753B is a system controller when it is in the system controller mode. These modes are discussed in more detail in Chapter 7 under *HP-IB Menu*.

## HP-IB BUS STRUCTURE

### Data Bus

The data bus consists of eight bidirectional lines that are used to transfer data from one device to another. Programming commands and data are typically encoded on these lines in ASCII, although binary encoding is often used to speed up the transfer of large arrays. Both ASCII and binary data formats are available to the HP 8753B. In addition, every byte transferred over HP-IB undergoes a *handshake* to ensure valid data.

### Handshake Lines

A three-line handshake scheme coordinates the transfer of data between talkers and listeners. This technique forces data transfers to occur at the speed of the slowest device, and ensures data integrity in multiple listener transfers. With most computing controllers and instruments, the handshake is performed automatically, which makes it transparent to the programmer.

### Control Lines

The data bus also has five control lines that the controller uses both to send bus commands and to address devices.

**IFC.** Interface Clear. Only the system controller uses this line. When this line is true (low), all devices (addressed or not) unaddress and go to an idle state.

**ATN.** Attention. The active controller uses this line to define whether the information on the data bus is a *command* or is *data*. When this line is true (low), the bus is in the command mode and the data lines carry bus commands. When this line is false (high), the bus is in the data mode and the data lines carry device-dependent instructions or data.

**SRQ.** Service Request. This line is set true (low) when a device requests service: the active controller services the requesting device. The HP 8753B can be enabled to pull the SRQ line for a variety of reasons.

**REN.** Remote Enable. Only the system controller uses this line. When this line is set true (low), the bus is in the remote mode, and devices are addressed either to listen or to talk. When the bus is in remote and a device is addressed, it receives instructions from HP-IB rather than from its front panel (the [LOCAL] key returns the device to front panel operation). When this line is set false (high), the bus and all devices return to local operation.

**EOI.** End or Identify. This line is used by a talker to indicate the last data byte in a multiple byte transmission, or by an active controller to initiate a parallel poll sequence. The HP 8753B recognizes the EOI line as a terminator, and it pulls the EOI line with the last byte of a message output (data, markers, plots, prints, error messages). The HP 8753B does not respond to parallel poll.

Figure 11-1 illustrates the structure of the HP-IB bus lines.

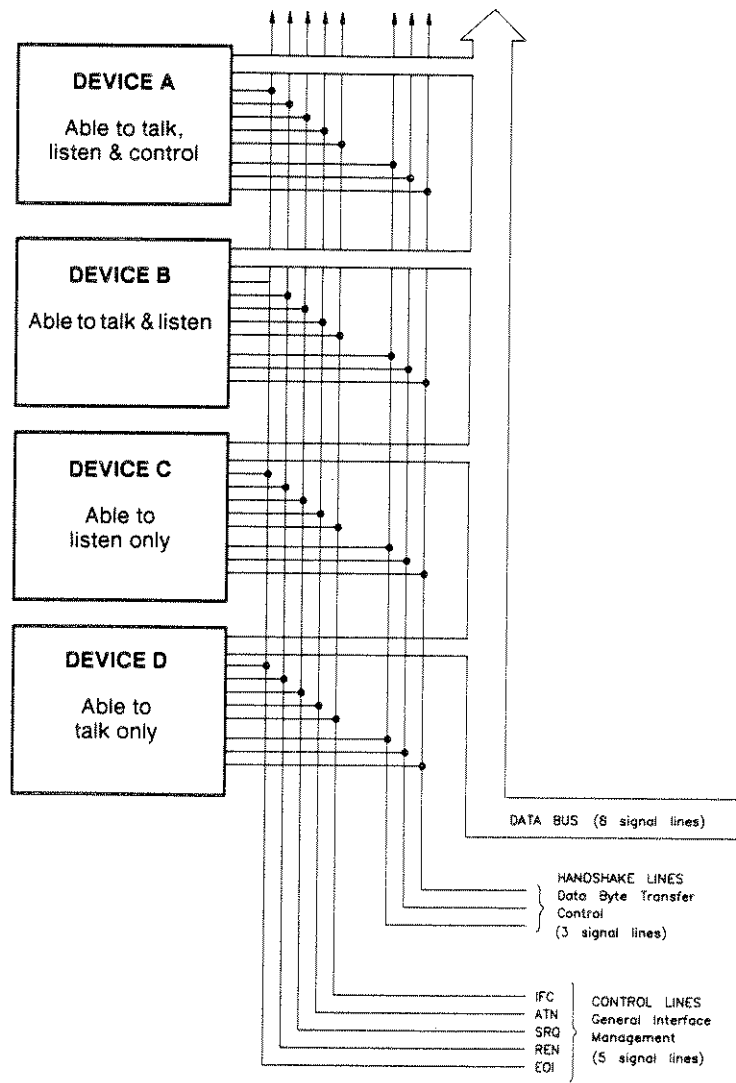

Figure 11-1. HP-IB Structure

## HP-IB REQUIREMENTS

|                                                        |                                                                                                                                                                                                                                                                                                                                                               |
|--------------------------------------------------------|---------------------------------------------------------------------------------------------------------------------------------------------------------------------------------------------------------------------------------------------------------------------------------------------------------------------------------------------------------------|
| <b>Number of Interconnected Devices:</b>               | 15 maximum.                                                                                                                                                                                                                                                                                                                                                   |
| <b>Interconnection Path/<br/>Maximum Cable Length:</b> | 20 metres maximum or 2 metres per device, whichever is less.                                                                                                                                                                                                                                                                                                  |
| <b>Message Transfer Scheme:</b>                        | Byte serial/ bit parallel asynchronous data transfer using a 3-line handshake system.                                                                                                                                                                                                                                                                         |
| <b>Data Rate:</b>                                      | Maximum of 1 megabyte per second over limited distances with tri-state drivers. Actual data rate depends on the transfer rate of the slowest device involved.                                                                                                                                                                                                 |
| <b>Address Capability:</b>                             | Primary addresses: 31 talk, 31 listen. A maximum of 1 talker and 14 listeners at one time.                                                                                                                                                                                                                                                                    |
| <b>Multiple Controller Capability:</b>                 | In systems with more than one controller (like the HP 8753B system), only one can be active at a time. The active controller can pass control to another controller, but only the system controller can assume unconditional control. Only one system controller is allowed. The system controller is hard-wired to assume bus control after a power failure. |

## HP 8753B HP-IB CAPABILITIES

As defined by the IEEE 488.1 standard, the HP 8753B has the following capabilities:

|                 |                                                                                     |
|-----------------|-------------------------------------------------------------------------------------|
| <b>SH1</b>      | Full source handshake.                                                              |
| <b>AH1</b>      | Full acceptor handshake.                                                            |
| <b>T6</b>       | Basic talker, answers serial poll, unaddresses if MLA is issued. No talk-only mode. |
| <b>L4</b>       | Basic listener, unaddresses if MTA is issued. No listen-only mode.                  |
| <b>SR1</b>      | Complete service request (SRQ) capabilities.                                        |
| <b>RL1</b>      | Complete remote/local capability including local lockout.                           |
| <b>PP0</b>      | Does not respond to parallel poll.                                                  |
| <b>DC1</b>      | Complete device clear.                                                              |
| <b>DT1</b>      | Responds to a group execute trigger in the hold trigger mode.                       |
| <b>C1,C2,C3</b> | System controller capabilities in system controller mode.                           |
| <b>C10</b>      | Pass control capabilities in pass control mode.                                     |
| <b>E2</b>       | Tri-state drivers.                                                                  |

## BUS MODE

The HP 8753B uses a single-bus architecture. The single bus allows both the HP 8753B and the host controller to have complete access to the peripherals in the system.

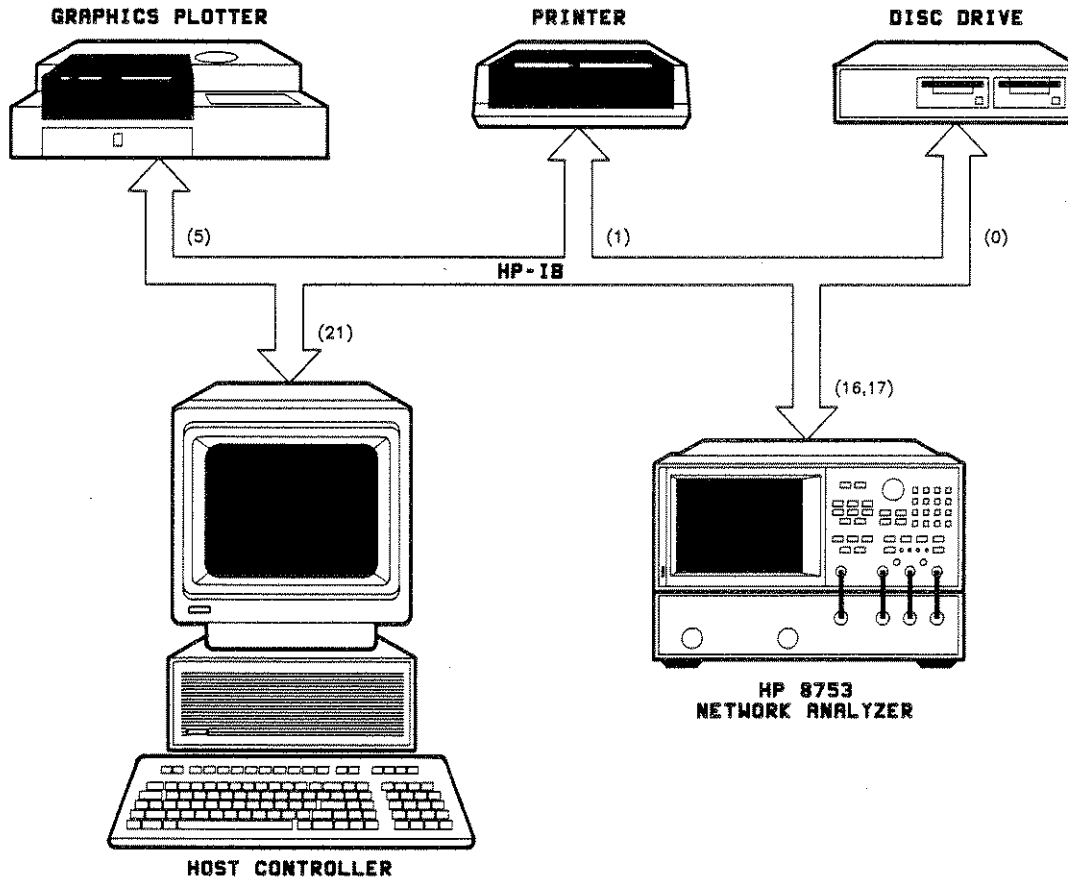

Figure 11-2. HP 8753B Single Bus Concept

Three different controller modes are possible, system controller, talker/listener, and pass control.

**System Controller.** This mode allows the HP 8753B to control peripherals directly in a stand-alone environment (without an external controller). This mode can only be selected manually from the network analyzer front panel. Use this mode for operation when no computer is connected to the HP 8753B. Do not use this mode for programming.

**Talker/Listener.** This is the traditional programming mode, in which the computer is involved in all peripheral access operations. Peripheral access (plotting and printing only) is also possible by addressing the HP 8753B to talk, addressing the peripheral to listen, and placing the HP-IB in the data mode.

**Pass Control.** This mode allows you to control the HP 8753B over HP-IB as with the talker/listener mode, and also allows the HP 8753B to take or pass control in order to plot, print, and access a disc. During the peripheral operation, the host computer is free to perform other internal tasks such as data or display manipulation (the bus is tied up by the analyzer during this time). After a task is completed, the host controller accepts control again when the analyzer returns it.

In general, use the talker/listener mode for programming the HP 8753B unless you desire direct peripheral access. Preset does not affect the selected bus mode, but the bus mode returns talker/listener if power is cycled.

Chapter 7 explains the three different bus modes in detail, and provides information on setting the correct bus mode. Programming information for talker/listener mode and pass control mode is provided in the *Introductory Programming Guide*.

## SETTING ADDRESSES

In communications through HP-IB, each instrument on the bus is identified by an HP-IB address. This address code must be different for each instrument on the bus. Refer to *Address Menu* in Chapter 7 for information on default addresses, and on setting and changing addresses. These addresses are stored in short-term non-volatile memory and are not affected when you press [PRESET] or cycle the power (although the [PRESET] key must be pressed to implement a change to the HP 8753B address).

## VALID CHARACTERS

The HP 8753B accepts ASCII letters, numbers, decimal points, +/–, semicolons, quotation marks ("), carriage returns (CR), and linefeeds (LF). Both upper and lower case are acceptable. Leading zeros, spaces, carriage returns, and unnecessary terminators are ignored, except those within a command or appendage. Carriage returns are ignored. An invalid character causes a syntax error. Syntax errors are described in more detail under in the *Introductory Programming Guide*.

## HP 8753B CODE NAMING CONVENTION

The HP 8753B HP-IB commands are derived from their front panel key titles (where possible), according to the naming convention below.

| Convention           | Key Title                     | For HP-IB Code Use                                                                                   | Example              |
|----------------------|-------------------------------|------------------------------------------------------------------------------------------------------|----------------------|
| One Word             | Power Start                   | First Four Letters                                                                                   | POWE<br>STAR         |
| Two Words            | Electrical Delay Search Right | First Three Letters of First Word<br>First Letter of Second Word                                     | ELED<br>SEAR         |
| Two Words in a Group | Marker →Center Gate →Span     | First Four Letters of Both                                                                           | MARKCENT<br>GATESPAN |
| Three Words          | Cal Kit N 50Ω Pen Num Data    | First Three Letters of First Word<br>First Letter of Second Word<br>First Four Letters of Third Word | CALKN50<br>PENNDATA  |

Some codes require appendages (on, off, 1, 2, etc.). Codes that have no front panel equivalent are HP-IB only commands, and use a similar convention based on the common name of the function. Where possible, HP 8753B codes are compatible with HP 8510A/B codes.

Front panel equivalent codes and HP-IB only codes are summarized in the *HP-IB Quick Reference Guide*.

## UNITS AND TERMINATORS

The HP 8753B outputs data in basic units and assumes these basic units when it receives an input, unless the input is otherwise qualified. The basic units and allowable expressions follow; either upper or lower case is acceptable.

| Basic Units  | Allowable Expressions |
|--------------|-----------------------|
| Seconds      | S                     |
| Milliseconds | MS                    |
| Microseconds | US                    |
| Nanoseconds  | NS                    |
| Picoseconds  | PS                    |
| Femtoseconds | FS                    |
| Hertz        | HZ                    |
| Kilohertz    | KHZ                   |
| Megahertz    | MHZ                   |
| Gigahertz    | GHZ                   |
| dB or dBm    | DB                    |
| Volts        | V                     |

Terminators are used to indicate the end of a command to allow the HP 8753B to recover to the next command in the event of a syntax error. The semicolon is the recommended command terminator. The line feed (LF) character and the HP-IB EOI line can also be used as terminators. The HP 8753B ignores the carriage return (CR) character.

## HP-IB DEBUG MODE

An HP-IB diagnostic feature (debug mode) is available in the HP-IB menu. Activating the debug mode causes the analyzer to scroll incoming HP-IB commands across the display. Nonprintable characters are represented with a  $\pi$ . Any time the HP 8753B receives a syntax error, the commands halt, and a pointer  $\wedge$  indicates the misunderstood character. The *Introductory Programming Guide* explains how to clear a syntax error.

## CRT GRAPHICS

The HP 8753B CRT can be used as a graphics display for displaying connection diagrams or custom instructions to an operator. The CRT accepts a subset of Hewlett-Packard Graphics Language (HP-GL) commands.

**NOTE:** The HP 8753B display occupies an additional address on the HP-IB. Determine the CRT bus address by adding 1 to the HP 8753B address if the analyzer address is an even number, or subtracting 1 if it is an odd number. Thus the factory default CRT address for graphics is 17.



# Chapter 12. Error Messages

---

## INTRODUCTION

This chapter lists the error messages that may be displayed on the HP 8753B CRT or transmitted by the instrument over HP-IB. Each error message is accompanied by an explanation, and suggestions are provided to help in solving the problem. Where applicable, references are given to related sections of the operating and service manuals.

When displayed, error messages are usually preceded with the word CAUTION:. That part of the error message has been omitted here for the sake of brevity. Some messages are for information only, and do not indicate an error condition. Two listings are provided: the first is in alphabetical order, and the second in numerical order.

In addition to error messages, instrument status is indicated by status notations in the left margin of the CRT. Examples are "\*", "tsH," and "P↓." Sometimes these appear in conjunction with error messages. A complete listing of status notations and their meanings is provided in Chapter 2, *Front Panel and Softkey Operation*.

## ERROR MESSAGES IN ALPHABETICAL ORDER

(Error numbers are provided in parentheses.)

**ADDITIONAL STANDARDS NEEDED** (error #68). Error correction for the selected calibration class cannot be computed until all the necessary standards have been measured.

**ADDRESSED TO TALK WITH NOTHING TO SAY** (error #31). An enter command was sent to the HP 8753B without first requesting data with an appropriate output command (such as OUTPDATA). The HP 8753B has no data in the output queue to satisfy the request.

**AIR FLOW RESTRICTED: CHECK FAN FILTER** (error #20). An inadequate air flow condition has been detected. Clean the fan filter. For most efficient cooling, the instrument covers should be in place. If the problem persists, troubleshoot the power supply.

**AVERAGING INVALID ON NON-RATIO MEASURE** (error #13). This error occurs only in single-input measurements. Sweep-to-sweep averaging is valid only for ratioed measurements (A/R, B/R, A/B, and S-parameters). Other noise reduction techniques are available for single input measurements. Refer to [AVG] Key in Chapter 4 for a discussion of trace smoothing and variable IF bandwidths.

**BLOCK INPUT ERROR** (error #34). The HP 8753B did not receive a complete data transmission. This is usually caused by an interruption of the bus transaction. Clear by pressing the [LOCAL] key or aborting the IO process at the controller.

**BLOCK INPUT LENGTH ERROR** (error #35). The length of the header received by the HP 8753B did not agree with the size of the internal array block. Refer to the *Introductory Programming Guide* for instructions on using HP 8753B input commands.

**CALIBRATION ABORTED** (error #74). The calibration in progress was terminated due to change of the active channel.

**CALIBRATION REQUIRED** (error #63). A calibration set could not be found that matched the current stimulus state or measurement parameter. Refer to Chapter 5, *Measurement Calibration*. Calibration sets can be saved in internal or external memory. Refer to [SAVE] Key in Chapter 10.

**CAN'T CHANGE-ANOTHER CONTROLLER ON BUS** (error #37). The HP 8753B cannot assume the mode of system controller until the active controller is removed from the bus or relinquishes the bus.

**CAN'T STORE/LOAD SEQUENCE, INSUFFICIENT MEMORY** (error #127). A sequence transfer to or from an external disc could not be completed because of insufficient memory.

**CH1 (CH2) TARGET VALUE NOT FOUND** (error #159). The target value for the marker search function does not exist on the current data trace.

**CONTINUOUS SWITCHING NOT ALLOWED** (error #10). The current measurement requires the S-parameter test set to switch automatically between forward and reverse measurements (driving test port 1, then test port 2). To protect the transfer switch against undue mechanical wear, it will not switch continuously. The "tsH" (test set hold) indicator in the left margin of the display indicates that the inactive channel has been put in the sweep hold mode.

**CORRECTION CONSTANTS NOT STORED** (error #3). A store operation to the EEPROM was not successful. The position of the jumper on the A9 CPU assembly must be changed. Refer to *A9 CC Jumper Position Procedure* in the *Adjustments and Correction Constants* section of the service manual.

**CORRECTION TURNED OFF** (error #66). Critical parameters in the current instrument state do not match the parameters for the calibration set, therefore correction has been turned off. The critical instrument state parameters are sweep type, start frequency, frequency span, and number of points.

**CURRENT PARAMETER NOT IN CAL SET** (error #64). Correction is not valid for the selected measurement parameter. Refer to Chapter 5, *Measurement Calibration*.

**D2/D1 INVALID WITH SINGLE CHANNEL** (error #130). A D2/D1 measurement can only be made if both channels are on.

**D2/D1 INVALID. CH1 CH2 NUM PTS DIFFERENT** (error #152). A D2/D1 measurement can only be made if both channels have the same number of points.

**DEADLOCK** (error #111). A fatal firmware error occurred before instrument preset completed. Refer to *Troubleshooting* in the service manual.

**DEMODULATION NOT VALID** (error #17). Demodulation is only valid for the CW time mode. Refer to Chapter 8, *Time and Frequency Domain Transforms*.

**DEVICE: not on, not connect, wrong addr** (error #119). The device at the power meter address cannot be accessed by the HP 8753B. Verify power to the device, and check the HP-IB connection between the HP 8753B and the device. Ensure that the device address recognized by the network analyzer matches the HP-IB address set on the device itself. Refer to [LOCAL] Key in Chapter 7 for instructions on setting peripheral addresses.

**DISC HARDWARE PROBLEM** (error #39). The disc drive is not responding correctly. Refer to the disc drive operating manual.

**DISC IS WRITE PROTECTED** (error #48). The store operation cannot write to a write-protected disc. Slide the write-protect tab over the write-protect opening in order to write data on the disc.

**DISC MEDIUM NOT INITIALIZED** (error #40). The disc must be initialized before it can be used. Refer to *Initialize Menu* in Chapter 10.

**DISC: not on, not connected, wrong addr**s (error #38). The disc cannot be accessed by the HP 8753B. Verify power to the disc drive, and check the HP-IB connection between the HP 8753B and the disc drive. Ensure that the disc drive address recognized by the network analyzer matches the HP-IB address set on the disc drive itself. Refer to *[LOCAL] Key* in Chapter 7 for instructions on setting peripheral addresses.

**DISC WEAR – REPLACE DISC SOON** (error #49). Cumulative use of the disc is approaching the maximum. Copy files as necessary using an external controller. If no controller is available, load instrument states from the old disc and store them to a newly initialized disc using the save/recall features of the HP 8753B. Refer to Chapter 10, *Saving Instrument States*, for information. Discard the old disc.

**DUPLICATING TO THIS SEQUENCE NOT ALLOWED** (error #125). A sequence cannot be duplicated to itself.

**EXCEEDED 7 STANDARDS PER CLASS** (error #72). A maximum of seven standards can be defined for any class. Refer to *Modifying Calibration Kits* in Chapter 5.

**EXTERNAL SOURCE MODE REQUIRES CW TIME** (error #148). An external source can only be phase locked and measured in the CW time sweep mode. Refer to Chapter 14 for information on the external source mode. Refer to *Sweep Type Menu* in Chapter 3 for information on CW time sweep.

**FIRST CHARACTER MUST BE A LETTER** (error #42). The first character of a disc file title or an internal save register title must be an alpha character.

**FREQ OFFSET ONLY VALID IN NETWORK ANALYZER MODE** (error #140). Frequency offset measurements can only be made in the network analyzer mode because this is the only mode that controls the source.

**FUNCTION NOT VALID** (error #14). The requested function is incompatible with the current instrument state.

**FUNCTION NOT VALID DURING MOD SEQUENCE** (error #131). Sequencing operations cannot be performed while a sequence is being modified.

**ILLEGAL UNIT OR VOLUME NUMBER** (error #46). The disc unit or volume number set in the HP 8753B is not valid. Refer to *HP-IB Menu* in Chapter 7 and to the disc drive operating manual.

**INIT DISC removes all data from disc** (information message, not an error). Continuing with the initialize operation will DESTROY any data currently on the disc.

**INITIALIZATION FAILED** (error #47). Disc initialization failed, probably because the disc is damaged.

**INPUT OVERLOAD, ATTENUATOR SET TO MAX** (error #160). This message occurs only with an HP 85047A test set when the instrument is in 6 GHz mode. The power level at the A or B input has exceeded the maximum allowed, and the attenuator has been set automatically to 70 dB to reduce the power. The annotation P↓ appears in the left margin of the display to indicate that power trip has been activated. Refer to *Power Menu* in Chapter 3. Toggle the *[POWER TRIP]* softkey off, and insert attenuation either with the internal attenuator or an external pad.

**INSTRUMENT STATE MEMORY CLEARED** (error #56). The five instrument state registers have been cleared from memory along with any saved calibration data or calibration kit definitions.

**INSUFFICIENT MEMORY** (error #51). The last front panel or HP-IB request could not be implemented due to insufficient memory space. In some cases, this is a fatal error which can only be escaped by presetting the instrument. See Chapter 10 for information on memory allocation.

**INSUFFICIENT MEMORY, PWR MTR CAL OFF** (error #154). A power meter calibration array requires more memory space than is currently available. Increase the available memory by clearing one or more save/recall registers, or by reducing the number of points.

**INVALID KEY** (error #2). An undefined softkey was pressed.

**LIST TABLE EMPTY** (error #9). The frequency list is empty. To implement list frequency mode, add segments to the list table. Refer to *Edit List Menu* in Chapter 3.

**LOG SWEEP REQUIRES 2 OCTAVE MINIMUM SPAN** (error #150). A logarithmic sweep is only valid if the stop frequency is greater than 4 times the start frequency. For frequency spans of less than two octaves, the sweep type automatically reverts to linear sweep.

**LOW PASS: FREQ LIMITS CHANGED** (information message, not an error). The frequency domain data points must be harmonically related from DC to the stop frequency. That is,  $\text{stop} = n \times \text{start}$ , where  $n$  = number of points. If this condition is not true when a low pass mode (step or impulse) is selected and transform is turned on, the network analyzer resets the start and stop frequencies. The stop frequency is set close to the entered stop frequency, and the start frequency is set equal to  $\text{stop}/n$ . Refer to *Time Domain Low Pass* in Chapter 8.

**LOW PASS MODE NOT ALLOWED** (error #18). Low pass time domain mode is allowed only with 801 points or less.

**MEMORY FOR CURRENT SEQUENCE IS FULL** (error #132). All the memory in the sequence being modified is filled with instrument commands.

**MORE SLIDES NEEDED** (error #71). When a sliding load is used (in a user-defined calibration kit), at least three slide positions are required to complete the calibration.

**NO 6 GHZ TEST SET PRESENT** (error #120). Sampler correction cannot be performed on an option 006 (6 GHz) instrument unless an HP 85047A 6 GHz test set is connected. Refer to *Sampler Magnitude and Phase Correction Constants* in the *Adjustments* section of the service manual.

**NO CALIBRATION CURRENTLY IN PROGRESS** (error #69). The *[RESUME CAL SEQUENCE]* softkey is not valid unless a calibration was already in progress. Start a new calibration. Refer to *Correction Menu* in Chapter 5.

**NO DISC MEDIUM IN DRIVE** (error #41). No disc was found in the current disc unit. Insert a disc, or check the disc unit number stored in the HP 8753B. Refer to *HP-IB Menu* in Chapter 7.

**NO FAIL FOUND** (service error #114). The self-diagnose function of the instrument operates on an internal test failure. At this time, no failure has been detected. Refer to *Internal Tests* in the *Service Key Menus* section of the *On-Site System Service Manual*.

**NO FILE(S) FOUND ON DISC** (error #45). No files of the type created by an HP 8753B store operation were found on the disc. Or if a specific file title was requested, that file was not found on the disc.

**NO IF FOUND: CHECK R INPUT LEVEL** (error #5). The first IF signal was not detected during pretune. Make sure the RF output is connected externally to the R input, with at least  $-35$  dBm input power to R.

**NO LIMIT LINES DISPLAYED** (error #144). Limit lines are turned on but cannot be displayed on polar or Smith chart display formats.

**NO MARKER DELTA — SPAN NOT SET** (error #15). The *[MARKER → SPAN]* softkey function requires that delta marker mode be turned on, with at least two markers displayed. Refer to Chapter 6, *Using Markers*.

**NO MEMORY AVAILABLE FOR INTERPOLATION** (error #123). Interpolated error correction cannot be performed due to insufficient memory. Increase the available memory by clearing one or more save/recall registers.

**NO MEMORY AVAILABLE FOR SEQUENCING** (error #126). The sequence cannot be modified due to insufficient memory. Increase the available memory by clearing one or more save/recall registers.

**NO PHASE LOCK: CHECK R INPUT LEVEL** (error #7). The first IF signal was detected at pretune, but phase lock could not be acquired. Refer to *Troubleshooting* in the *On-Site System Service Manual*.

**NO SPACE FOR NEW CAL. CLEAR REGISTERS** (error #70). Insufficient memory is available to store a calibration set. Memory can be freed by clearing a saved instrument state, which will result in the deletion of a saved calibration set. The saved instrument state and calibration set can be stored to an external disc before being cleared from the internal register. Refer to Chapter 10 for information on the allocation of memory.

**NO VALID MEMORY TRACE** (error #54). If a memory trace is to be displayed or otherwise used, a data trace must first be stored to memory. Refer to *Display Menu* in Chapter 4.

**NO VALID STATE IN REGISTER** (error #55). A request to load an instrument state from an internal register was received over HP-IB, and that register is empty.

**NOT ENOUGH SPACE ON DISC FOR STORE** (error #44). The store operation will overflow the available disc space. Insert a new disc or purge the files appearing last in the directory, to create free disc space.

**NOT VALID FOR PRESENT TEST SET** (error #62). The calibration requested is inconsistent with the test set present. This message occurs in the following situations:

- A full 2-port calibration is requested with a test set other than an HP 85046A/B or 85047A S-parameter test set.
- A one-path 2-port calibration is requested with an S-parameter test set (this procedure is typically used with a transmission/reflection test set).

**ONLY LETTERS AND NUMBERS ARE ALLOWED** (error #43). Only alpha-numeric characters are allowed in disc file titles or internal save register titles. Other symbols are not allowed.

**OPTIONAL FUNCTION; NOT INSTALLED** (error #1). The function you requested requires a capability provided by an option to the standard HP 8753B. That option is not currently installed. (Options are 002 harmonic measurement capability, 006 6 GHz receiver operation, and 010 time domain transform.)

**OVERLOAD ON INPUT A, POWER REDUCED** (error #58)

**OVERLOAD ON INPUT B, POWER REDUCED** (error #59)

**OVERLOAD ON INPUT R, POWER REDUCED** (error #57). When the power level at one of the three receiver inputs exceeds approximately +4 dBm, the RF output power level is automatically reduced to -5 dBm. The annotation P↓ appears in the left margin of the display to indicate that the power trip function has been activated. When this occurs, toggle the *[POWER TRIP]* softkey off and reset the power at a lower level. Refer to *Power Menu* in Chapter 3. (In certain circumstances, power trip is indicated by error #160, INPUT OVERLOAD, ATTENUATOR SET TO MAX.)

**PHASE LOCK CAL FAILED** (error #4). An internal phase lock calibration routine is automatically executed at power-on and preset any time a loss of phase lock is detected. This message indicates that phase lock calibration was initiated and the first IF detected, but a problem prevented the calibration from completing successfully. Refer to the *Troubleshooting* section of the *On-Site System Service Manual*, and execute pretune correction test 48.

If a mixer is connected between the RF output and R input before frequency offset mode is turned on, this message may appear. Ignore it: it will go away when frequency offset is turned on. Or it may appear if frequency offset mode is entered before the offset is defined. Refer to Chapter 14 for information.

**PHASE LOCK LOST** (error #8). Phase lock was acquired but then lost. Refer to the *Troubleshooting* section of the service manual, and to *Service Modes Menu* in the *Service Key Menus* section.

**PLOT ABORTED** (error #27). Pressing the **[LOCAL]** key causes the HP 8753B to abort the plot in progress.

**PLOTTER: not on, not connect, wrong addr**s (error #26). The plotter does not respond to control. Verify power to the plotter, and check the HP-IB connection between the HP 8753B and the plotter. Ensure that the plotter address recognized by the network analyzer matches the HP-IB address set on the plotter itself. Refer to *[LOCAL] Key* in Chapter 7 for instructions on setting peripheral addresses.

**PLOTTER NOT READY-PINCH WHEELS UP** (error #28). The plotter pinch wheels clamp the paper in place. When the pinch wheels are raised, the plotter indicates a "not ready" status on the bus.

**POSSIBLE FALSE LOCK** (error #6). Phase lock has been achieved, but the source may be phase locked to the wrong harmonic of the synthesizer. Perform the source pretune correction routine in the *Adjustments* section of the service manual.

**POW MET INVALID** (error #116). The power meter indicates an out-of-range condition. Check the test setup.

**POW MET NOT SETTLED** (error #118). Sequential power meter readings are not consistent. Verify that the equipment is set up correctly. If so, preset the instrument and restart the routine.

**POW MET: not on, not connected, wrong addr**s (error #117). The power meter cannot be accessed by the HP 8753B. Verify that the power meter address and model number set in the HP 8753B match the address and model number of the actual power meter. Refer to *[LOCAL] Key* in Chapter 7 for more information.

**POWER SUPPLY HOT!** (error #21). The temperature sensors on the A8 post-regulator assembly have detected an overtemperature condition. The power supplies regulated on the post-regulator have been shut down.

**POWER SUPPLY SHUT DOWN!** (error #22). One or more supplies on the A8 post-regulator assembly have been shut down due to an overcurrent, overvoltage, or undervoltage condition.

**PRESENT LIST FREQ INVALID IN 3 GHZ RANGE** (error #139). Frequency list segments above 3 GHz were set while the instrument was in 6 GHz mode using the HP 85047A test set. These frequencies can only be used in the 6 GHz mode. Either change the frequency list or press **[FREQ RANGE 3GHz6GHz]** to turn on the 6 GHz mode.

**PRINT ABORTED** (error #25). Pressing the **[LOCAL]** key causes the HP 8753B to abort output to the printer.

**PRINTER: not on, not connected, wrong addr** (error #24). The printer does not respond to control. Verify power to the printer, and check the HP-IB connection between the HP 8753B and the printer. Ensure that the printer address recognized by the network analyzer matches the HP-IB address set on the printer itself. Refer to *[LOCAL] Key* in Chapter 7 for instructions on setting peripheral addresses.

**PRINT/PLOT IN PROGRESS, ABORT WITH LOCAL** (information message, not an error). If a print or plot is in progress and a second print or plot is attempted, this message is displayed and the second attempt is ignored. To abort a print or plot in progress, press **[LOCAL]**.

**PROBE POWER SHUT DOWN!** (error #23). The HP 8753B biasing supplies to the HP 85024A external probe are shut down due to excessive current. Troubleshoot the probe, and refer to the *Power Supply* troubleshooting section of the service manual.

**REQUESTED DATA NOT CURRENTLY AVAILABLE** (error #30). The HP 8753B does not currently contain the data being requested. For example, this condition occurs when error term arrays are requested and no calibration is active.

**SAVE FAILED. INSUFFICIENT MEMORY** (error #151). The instrument state could not be saved in an internal register because of insufficient memory. Increase the available memory by clearing one or more save/recall registers, or by storing files to an external disc. Refer to Chapter 10 for information.

**SELECTED SEQUENCE IS EMPTY** (error #124). The sequence you tried to run does not contain instrument commands.

**SELF TEST #n FAILED** (service error #112). Internal test #n has failed. Several internal test routines are executed at instrument preset. The HP 8753B reports the first failure detected. Refer to the *Troubleshooting* section of the *On-Site System Service Manual* for more information on internal tests and the self-diagnose feature.

**SEQUENCE ABORTED** (error #157). The running sequence was stopped prematurely when the operator pressed the **[LOCAL]** key.

**SEQUENCE MAY HAVE CHANGED, CAN'T CONTINUE** (error #153). The sequence that was paused cannot be continued because it has been modified. The sequence must be started again.

**SLIDES ABORTED (MEMORY REALLOCATION)** (error #73). Insufficient memory is available for sliding load measurements. Reduce memory usage by clearing save/recall registers (see Chapter 10, *Saving Instrument States*), then repeat the sliding load measurements.

**SOURCE PARAMETERS CHANGED** (error #61). Some of the stimulus parameters of the instrument state have been changed, due to a request to turn correction on. A calibration set for the current measurement parameter was found and activated. The instrument state was updated to match the stimulus parameters of the calibration state.

This message also appears when harmonic mode or frequency offset is turned on and the present frequency range cannot be used with one of these modes.

**SOURCE POWER TRIPPED, RESET UNDER POWER MENU** (information message, not an error). The power level at one of the inputs has exceeded the maximum allowed, and power has been automatically reduced. The annotation P↓ indicates that power trip has been activated. Press **[MENU] [POWER] [POWER TRIP ON]** to turn off the power trip, then reset the power at a lower level. This message follows error #57-59, OVERLOAD ON INPUT A (B, R), POWER REDUCED and error #160, INPUT OVERLOAD, ATTENUATOR SET TO MAX, and repeats every sweep until the power trip is cleared.

**SWEEP TIME INCREASED** (error #11). Sweep time is automatically increased to compensate for other instrument state changes. Some parameter changes that cause an increase in sweep time are narrower IF bandwidth, an increase in the number of points, and a change in sweep type.

**SWEEP TIME TOO FAST** (error #12). The fractional-N and digital IF circuits have lost synchronization. Refer to the *Troubleshooting* section in the *On-Site System Service Manual*.

**SWEEP TRIGGER SET TO HOLD** (information message, not an error). The instrument is in a hold state and is no longer sweeping.

**SWEEP TYPE CHANGED TO LINEAR SWEEP** (error #145). If the frequency list mode is active when the *[FREQ RANGE 3GHz6GHz]* softkey is pressed, or when the instrument mode is changed to harmonic measurements, and the list frequencies do not fall in the allowable frequency range of these modes, the list mode is turned off.

**SYNTAX ERROR** (error #33). An improperly formatted command was received over HP-IB. Refer to the *HP-IB Quick Reference Guide* for proper command syntax.

**SYST CTRL OR PASS CTRL IN LOCAL MENU** (error #36). The HP 8753B cannot control a peripheral device on the bus while it is in talker/listener mode. Use the local menu to change to system controller or pass control mode. Refer to *[LOCAL] Key* in Chapter 7 for information on HP-IB controller modes.

**SYSTEM IS NOT IN REMOTE** (error #52). The HP 8753B is in local mode. In this mode, the HP 8753B will not respond to HP-IB commands with front panel key equivalents. It will, however, respond to commands that have no such equivalents, such as status requests.

**TEST ABORTED** (error #113). A service test has been prematurely stopped at the operator's request.

**THIS LIST FREQ INVALID IN HARM/3 GHZ RNG** (error #133). The frequencies in the list do not fall in the allowable frequency range for harmonic measurements, or for 6 GHz operation with an HP 85047A test set. Reduce the frequency range of the list.

**TOO MANY SEGMENTS OR POINTS** (error #50). Frequency list mode is limited to 30 segments or 1632 points. Refer to *Edit List Menu* in Chapter 3 for more information.

In power meter calibration, the power sensor cal factor and power loss functions are limited to 12 segments. Refer to *Power Meter Calibration* in Chapter 5.

**TRANSFORM, GATE NOT ALLOWED** (error #16). Transformation to the time domain is only possible in linear and CW sweep types.

**TROUBLE! CHECK SETUP AND START OVER** (service error #115). The equipment setup for the adjustment procedure in progress is not correct. Check the setup diagram and instructions in the *Adjustments and Correction Constants* section of the *On-Site System Service Manual*. Start the procedure again.

**WAITING FOR CLEAN SWEEP** (information message, not an error). In single sweep mode, the instrument ensures that all changes to the instrument state, if any, have been implemented before taking the sweep. The command that the instrument is currently processing will not complete until the new sweep completes. An asterisk \* is displayed in the left margin of the CRT until a complete fresh sweep has been taken.

**WAITING FOR DISC** (information message, not an error). This message is displayed between the start and finish of a read or write operation to a disc.



**WAITING FOR HP-IB CONTROL** (information message, not an error). The HP 8753B has been instructed to use pass control (USEPASC). When the instrument next receives an instruction requiring active controller mode, it requests control of the bus and simultaneously displays this message. If the message remains, the system controller is not relinquishing the bus.

**WRITE ATTEMPTED WITHOUT SELECTING INPUT TYPE** (error #32). The data header "#A" for the HP 8753B was received with no preceding input command (such as INPUDATA). The instrument recognized the header but did not know what type of data to receive. Refer to the *HP-IB Quick Reference Guide* for command syntax information.

**WRONG DISC FORMAT, INITIALIZE DISC** (error #77). A command to store, load, or read file titles has been received, but the disc format does not conform to the Logical Interchange Format (LIF). The instrument must initialize the disc before reading or writing to it. Refer to *Initialize Menu* in Chapter 10.

**3GHZ MAX FREQ. USE FREQ RANGE KEY (UNDER SYSTEM)** (information message, not an error). Frequencies above 3 GHz can only be set when the instrument has been set to 6 GHz mode. Press **[SYSTEM] [FREQ RANGE 3GHZ]** so that it changes to **[FREQ RANGE 6GHZ]**. This message occurs only with an option 006 instrument used with an HP 85047A test set.

## **ERROR MESSAGES IN NUMERICAL ORDER**

Refer to the alphabetical listing for explanations and suggestions for solving the problems.

ERROR #1. OPTIONAL FUNCTION; NOT INSTALLED

ERROR #2. INVALID KEY

ERROR #3. CORRECTION CONSTANTS NOT STORED

ERROR #4. PHASE LOCK CAL FAILED

ERROR #5. NO IF FOUND: CHECK R INPUT LEVEL

ERROR #6. POSSIBLE FALSE LOCK

ERROR #7. NO PHASE LOCK: CHECK R INPUT LEVEL

ERROR #8. PHASE LOCK LOST

ERROR #9. LIST TABLE EMPTY

ERROR #10. CONTINUOUS SWITCHING NOT ALLOWED

ERROR #11. SWEEP TIME INCREASED

ERROR #12. SWEEP TIME TOO FAST

ERROR #13. AVERAGING INVALID ON NON-RATIO MEASURE

ERROR #14. FUNCTION NOT VALID

ERROR #15. NO MARKER DELTA – SPAN NOT SET

ERROR #16. TRANSFORM, GATE NOT ALLOWED

ERROR #17. DEMODULATION NOT VALID

ERROR #18. LOW PASS MODE NOT ALLOWED

ERROR #20. AIR FLOW RESTRICTED: CHECK FAN FILTER

ERROR #21. POWER SUPPLY HOT!

ERROR #22. POWER SUPPLY SHUT DOWN!

ERROR #23. PROBE POWER SHUT DOWN!

ERROR #24. PRINTER: not on, not connected, wrong addr

ERROR #25. PRINT ABORTED

ERROR #26. PLOTTER: not on, not connect, wrong addr

ERROR #27. PLOT ABORTED

ERROR #28. PLOTTER NOT READY-PINCH WHEELS UP

ERROR #30. REQUESTED DATA NOT CURRENTLY AVAILABLE

ERROR #31. ADDRESSED TO TALK WITH NOTHING TO SAY

ERROR #32. WRITE ATTEMPTED WITHOUT SELECTING INPUT TYPE

ERROR #33. SYNTAX ERROR

ERROR #34. BLOCK INPUT ERROR

ERROR #35. BLOCK INPUT LENGTH ERROR

ERROR #36. SYST CTRL OR PASS CTRL IN LOCAL MENU

ERROR #37. CAN'T CHANGE-ANOTHER CONTROLLER ON BUS

ERROR #38. DISC: not on, not connected, wrong addr

ERROR #39. DISC HARDWARE PROBLEM

ERROR #40. DISC MEDIUM NOT INITIALIZED

ERROR #41. NO DISC MEDIUM IN DRIVE

ERROR #42. FIRST CHARACTER MUST BE A LETTER

ERROR #43. ONLY LETTERS AND NUMBERS ARE ALLOWED

ERROR #44. NOT ENOUGH SPACE ON DISC FOR STORE

ERROR #45. NO FILE(S) FOUND ON DISC

ERROR #46. ILLEGAL UNIT OR VOLUME NUMBER

ERROR #47. INITIALIZATION FAILED

ERROR #48. DISC IS WRITE PROTECTED

ERROR #49. DISC WEAR-REPLACE DISC SOON

ERROR #50. TOO MANY SEGMENTS OR POINTS

ERROR #51. INSUFFICIENT MEMORY  
ERROR #52. SYSTEM IS NOT IN REMOTE  
ERROR #54. NO VALID MEMORY TRACE  
ERROR #55. NO VALID STATE IN REGISTER  
ERROR #56. INSTRUMENT STATE MEMORY CLEARED  
ERROR #57. OVERLOAD ON INPUT R, POWER REDUCED  
ERROR #58. OVERLOAD ON INPUT A, POWER REDUCED  
ERROR #59. OVERLOAD ON INPUT B, POWER REDUCED  
ERROR #61. SOURCE PARAMETERS CHANGED  
ERROR #62. NOT VALID FOR PRESENT TEST SET  
ERROR #63. CALIBRATION REQUIRED  
ERROR #64. CURRENT PARAMETER NOT IN CAL SET  
ERROR #66. CORRECTION TURNED OFF  
ERROR #68. ADDITIONAL STANDARDS NEEDED  
ERROR #69. NO CALIBRATION CURRENTLY IN PROGRESS  
ERROR #70. NO SPACE FOR NEW CAL. CLEAR REGISTERS  
ERROR #71. MORE SLIDES NEEDED  
ERROR #72. EXCEEDED 7 STANDARDS PER CLASS  
ERROR #73. SLIDES ABORTED (MEMORY REALLOCATION)  
ERROR #74. CALIBRATION ABORTED  
ERROR #77. WRONG DISC FORMAT, INITIALIZE DISC  
ERROR #111. DEADLOCK.  
ERROR #112. SELF TEST #n FAILED  
ERROR #113. TEST ABORTED  
ERROR #114. NO FAIL FOUND  
ERROR #115. TROUBLE! CHECK SETUP AND START OVER  
ERROR #116. POW MET INVALID  
ERROR #117. POW MET: not on, not connected, wrong addr  
ERROR #118. POW MET NOT SETTLED  
ERROR #119. DEVICE: not on, not connect, wrong addr  
ERROR #120. NO 6 GHZ TEST SET PRESENT  
ERROR #123. NO MEMORY AVAILABLE FOR INTERPOLATION

ERROR #124. SELECTED SEQUENCE IS EMPTY  
ERROR #125. DUPLICATING TO THIS SEQUENCE NOT ALLOWED  
ERROR #126. NO MEMORY AVAILABLE FOR SEQUENCING  
ERROR #127. CAN'T STORE/LOAD SEQUENCE, INSUFFICIENT MEMORY  
ERROR #130. D2/D1 INVALID WITH SINGLE CHANNEL  
ERROR #131. FUNCTION NOT VALID DURING MOD SEQUENCE  
ERROR #132. MEMORY FOR CURRENT SEQUENCE IS FULL  
ERROR #133. THIS LIST FREQ INVALID IN HARM/3 GHZ RNG  
ERROR #139. PRESENT LIST FREQ INVALID IN 3 GHZ RANGE  
ERROR #140. FREQ OFFSET ONLY VALID IN NETWORK ANALYZER MODE  
ERROR #144. NO LIMIT LINES DISPLAYED  
ERROR #145. SWEEP TYPE CHANGED TO LINEAR SWEEP  
ERROR #148. EXTERNAL SOURCE MODE REQUIRES CW TIME  
ERROR #150. LOG SWEEP REQUIRES 2 OCTAVE MINIMUM SPAN  
ERROR #151. SAVE FAILED. INSUFFICIENT MEMORY  
ERROR #152. D2/D1 INVALID. CH1 CH2 NUM PTS DIFFERENT  
ERROR #153. SEQUENCE MAY HAVE CHANGED, CAN'T CONTINUE  
ERROR #154. INSUFFICIENT MEMORY, PWR MTR CAL OFF  
ERROR #157. SEQUENCE ABORTED  
ERROR #159. CH1 (CH2) TARGET VALUE NOT FOUND  
ERROR #160. INPUT OVERLOAD, ATTENUATOR SET TO MAX

# Chapter 13. Test Sequence Function

---

## CHAPTER CONTENTS

|       |                                   |       |                                       |
|-------|-----------------------------------|-------|---------------------------------------|
| 13-1  | What is Test Sequencing?          | 13-12 | Load Sequence from Disc Menu          |
| 13-2  | Creating a Sequence               | 13-13 | Purge Sequence from Disc Menu         |
| 13-2  | Running a Sequence                | 13-14 | Sequence More Menu                    |
| 13-2  | Stopping a Sequence               |       |                                       |
| 13-3  | Changing the Sequence Title       | 13-15 | Sequencing Special Functions          |
| 13-3  | Editing a Sequence                | 13-15 | Important Concepts                    |
| 13-4  | Clearing a Sequence from Memory   | 13-16 | Autostarting Sequences                |
| 13-4  | Storing a Sequence to Disc        | 13-16 | Sequencing Special Function Menu      |
| 13-5  | Loading a Sequence from Disc      | 13-17 | Sequencing Decision Making Menu       |
| 13-6  | Purging a Sequence from Disc      | 13-19 | Sequencing Special Function More Menu |
| 13-6  | Printing a Sequence               |       |                                       |
| 13-6  | In-Depth Sequencing Information   | 13-20 | HP-GL Considerations                  |
| 13-8  | Basic Sequencing Menus            | 13-21 | Entering Sequences Using HP-IB        |
| 13-9  | Do Sequence Menu                  | 13-21 | Reading Sequences Using HP-IB         |
| 13-10 | New Sequence/Modify Sequence Menu |       |                                       |
| 13-11 | Store Sequence to Disc Menu       | 13-21 | Decision-Making Example Sequences     |

## WHAT IS TEST SEQUENCING?

Test sequencing automates repetitive tasks. In sequencing mode you make the measurement once and the HP 8753B memorizes the keystrokes. Later the entire sequence can be repeated by pressing a single key. Because the sequence is defined with normal measurement keystrokes, no additional programming expertise is required. Limited decision-making increases the flexibility of test sequences.

The test sequence function allows the user to create, title, save, and execute up to six independent sequences internally. Test sequences can dramatically reduce the time required to make a multiple step measurement, and can greatly reduce operator errors.

Sequences may be saved to external disc and can be transferred between the HP 8753B and an external computer controller.

The following procedures are based on an actual measurement example, and show you how to create, title, edit, clear, and (optionally) store, load, or purge a sequence. Performing these sample procedures will teach you how to use basic test sequencing in a very short amount of time.

## CREATING A SEQUENCE

1. Press **[SYSTEM] [SEQUENCING MENU] [NEW SEQ/MODIFY SEQ]**.
2. The HP 8753B will display the six available sequences. Press **[SEQUENCE 1 SEQ1]** to select sequence number one. ("SEQ1" is the default title of that sequence.)
3. The following list will appear on the screen with an arrow cursor.

```
=> Start of Sequence
 1996 empty bytes available
```

4. Press the appropriate keys for the desired measurement. Note that the **[RECALL PRST STATE]** (recall preset state) softkey is available under the **[RECALL]** key. This command is the only way to preset the instrument in a sequence. It is recommended that sequences begin with this command.

### Example Sequence:

Connect a test cable between the RF output and R input. Enter the following commands on the HP 8753B:

```
[RECALL] [RECALL PRST STATE]
[MEAS] [R]
[SCALE REF] [SCALE/DIV] [1] [x1]
[START] [1] [G/n]
[AVG] [SMOOTHING APERTURE] [5] [x1]
[SMOOTHING ON]
[DISPLAY] [DUAL CHAN ON]
[CH 2] [FORMAT] [SMITH CHART]
```

As you enter front panel commands, the list on the screen will show each entry. The available number of bytes for that sequence is displayed at the bottom of the list. If you make a mistake, refer to *Editing a Sequence*.

5. Press **[SYSTEM] [SEQUENCING MENU] [DONE MODIFY]**. The sequence is now ready to run.

**NOTE:** A sequence created in sequence position 6 is stored in nonvolatile memory and will survive if line power is turned off.

## RUNNING A SEQUENCE

To run the sequence right after creating it, press the **[DO SEQUENCE]** softkey. While a sequence is running the HP 8753B's remote light is on, indicating that the HP 8753B can not be operated manually.

If **[PRESET]** is pressed, all sequences currently in memory are immediately presented in the softkey menu. To run a sequence, press the appropriate softkey.

1. Press **[PRESET]** now, followed by **[SEQUENCE 1 SEQ1]**. Notice the display changes (split display and Smith chart) caused by the sequence.

## STOPPING A SEQUENCE

To stop a sequence before it has finished, press **[LOCAL]**.

## CHANGING THE SEQUENCE TITLE

If sequences are to be stored to disc, it is recommended that they be given titles other than the default (SEQ1, SEQ2...). Titles entered from the front panel can be no longer than eight characters, must begin with a letter, and can contain only letters and numbers.

1. Press **[SYSTEM] [SEQUENCING MENU] [MORE] [TITLE SEQUENCE] [TITLE SEQ1]**. The screen now provides the available title characters. The current title is displayed in the upper left-hand corner of the screen.
2. Press the **[ERASE TITLE]** softkey. Move the knob until the arrow cursor is under the "A," and press **[SELECT LETTER]**. Continue until the title "ALPHA" has been entered, then press **[DONE] [PRESET]**. **[SEQUENCE ALPHA]** is now displayed as a softkey label.

## EDITING A SEQUENCE

The sample measurement entered earlier will be used to demonstrate sequence editing.

1. Press **[PRESET] [SYSTEM] [SEQUENCING MENU] [NEW SEQ/MODIFY SEQ]**.
2. Press **[SEQUENCE 1 ALPHA]** to edit the sequence created earlier. The following is the list of commands entered in *Creating a Sequence*. Note that only part of the list can be shown on the screen at one time.

```
=> Start of Sequence
 RECALL PRST STATE
 R
 SCALE/DIV
 SCALE/DIV
 1 x1
 START
 1 G/n
 SMOOTHING APERTURE
 5 x1
 SMOOTHING
 ON
 DUAL CHAN
```

The following lines are off screen:

```
ON
CH 2
SMITH CHART
1944 empty bytes available
```

## The Active Line

The active line is always the line next to the => cursor.

## Scrolling the Sequence Command List

The position of the cursor is fixed, and the command list moves up or down when the operator uses the rotary knob or the **[▲]** and **[▼]** keys. If you press the **[▲]** key, the list moves up, and the cursor points to the next command line.

3. Press the [**▲**] key until you reach the bottom of the list. Notice that the commands in the list are actually performed when the cursor points to them. This feature allows the sequence to be tested one command at a time. If you scroll past the end of the list, it will wrap-around back to the beginning. If the list is scrolled by pressing [**▼**] key the commands will not execute.

## Editing Features

Three editing features are available in sequencing:

- Insert a command
- Delete a command
- Backspace (before the entry is terminated)

**Inserting lines.** Inserting requires no special keystrokes. Just type in the command to be inserted, and it will appear below the active line.

**Deleting lines.** Pressing the [**BACK SP**] (backspace) key deletes the entry next to the cursor.

To replace a command, delete the original and insert a new command in its place.

**Backspacing Before the Entry is Terminated.** When entering a command such as start frequency, you can backspace over an incorrect number before the units terminator key is pressed. For example, if [**START**] [**1**] [**2**] is pressed, followed by the backspace key, the 2 is deleted. However, if a terminator key is pressed (such as G/n), backspacing deletes the whole command.

4. Press the [**▼**] key until the cursor points to the line shown:

```
SCALE/DIV
=> 1 x1
 START
 1 G/n
```

5. Press [**BACK SP**]. The line will disappear.
6. Press [**2**] [**x1**]. The sequence, when run, will now choose a scale factor of 2 dB/div.
7. Press [**SYSTEM**] [**SEQUENCING MENU**] [**DONE MODIFY**] to exit the modify (edit) mode.

## CLEARING A SEQUENCE FROM MEMORY

This procedure is given for reference only. Do not clear the sequence "ALPHA" created in previous steps, as it is used in later examples.

1. Press [**SYSTEM**] [**SEQUENCING MENU**] [**MORE**] [**CLEAR SEQUENCE**]. Press the softkey of the sequence to be cleared.

## STORING A SEQUENCE TO DISC

### Set Up the Disc Drive and Set the HP 8753B to System Controller Mode

1. Connect an HP 9122 (or other CS-80 compatible disc drive) to the HP 8753B. The disc drive must be HP-IB compatible. Make sure the HP 8753B is programmed with the disc drive's HP-IB address using the [**LOCAL**] [**SET ADDRESSES**] [**ADDRESS: DISC**] keys.
2. Disconnect the HP 8753B from any computer controller. Set the instrument to system controller mode by pressing [**LOCAL**] [**SYSTEM CONTROLLER**].



## Format a Blank Disc

3. If necessary, format a blank disc by inserting it into drive 0 and pressing **[SAVE] [STORE TO DISC] [DEFINE STORE] [MORE] [INITIALIZE DISC] [INIT DISC? YES]**.

## Save Sequence to Disc

4. Press **[SYSTEM] [SEQUENCING MENU] [STORE SEQ TO DISC]**. The sequences currently in memory will be displayed in the softkey labels.
5. Select the desired sequence to store. To store the sequence created in the above example, press **[STORE SEQ ALPHA]**. If "CAUTION: SYST CTRL OR PASS CTRL in LOCAL menu" appears on the screen, the HP 8753B is not in system controller mode. Perform step 2 before saving a sequence to disc.



**The save sequence to disc function will overwrite a file on the disc that has the same title. There is no warning to the user when a file is to be overwritten.**

6. The disc drive access light should turn on briefly. When it goes out, the sequence has been saved.

## LOADING A SEQUENCE FROM DISC

This procedure assumes the disc drive and HP 8753B have been set up as described in *Storing a Sequence to Disc*, and that a sequence titled "ALPHA" has been saved. Sequences are saved to disc independently of instrument state information.

There are two methods of loading a sequence:

- **If the sequence title is known.** Use the title menu to rename one of the six sequence softkeys with the name of the desired sequence. The procedure is described below.
- **If the sequence title is not known,** the contents of the disc can be viewed (six titles at a time). When the desired title appears on the display it can be loaded. Files are stored on disc in chronological order. The procedure is described below.

### Loading a Sequence When the Title Is Known

1. Press **[SYSTEM] [SEQUENCING MENU] [LOAD SEQ FROM DISC]**. If the desired sequence name is not on the load sequence from disc menu, perform step 2.
2. Change one of the six sequence titles to match that of the desired sequence by pressing **[SYSTEM] [SEQUENCING MENU] [MORE] [TITLE SEQUENCE]** followed by one of the six sequence softkeys. Press **[ERASE TITLE]** if necessary and change the title as explained in *Creating a Sequence*. Press **[DONE] [RETURN] [LOAD SEQ FROM DISC]**.
3. Press the softkey next to the title of the desired sequence. The disc access light should come on briefly. When it goes out the sequence is loaded.

## Loading a Sequence When the Title Is Not Known

This procedure assumes the desired file exists on the disc in drive 0.

1. Press **[SYSTEM] [SEQUENCING MENU] [LOAD SEQ FROM DISC] [READ SEQ FILE TITLS]**. The titles of the first six sequences on the disc will appear. If the desired sequence is not among the first six files, keep pressing **[READ SEQ FILE TITLS]** until the desired file name appears. Files are stored in chronological order.
2. Press the softkey next to the title of the desired sequence. The disc access light should come on briefly. When it goes out the sequence is loaded.

## PURGING A SEQUENCE FROM DISC

1. Press **[SYSTEM] [SEQUENCING MENU] [STORE SEQ TO DISC] [PURGE SEQUENCES]**. The name of the desired sequence must show on the menu before it can be purged. As with loading a file, the title in one of the sequence softkey labels can be changed to the desired filename, or the disc can be searched. Refer to *Loading a Sequence From Disc* for details.
2. Once the proper sequence name is in one of the purge sequence softkey labels, press the softkey. The disc access light will turn on briefly. When it goes out the file is purged. Once purged, a file cannot be retrieved.

## PRINTING A SEQUENCE

### Set Up the Printer and Set the HP 8753B to System Controller Mode

1. Connect a compatible printer to the HP 8753B (refer to *Plotters and Printers* in the *Other Accessories Available* portion of *General Information and Specifications*). Make sure the HP 8753B is programmed with the printer's HP-IB address using the **[LOCAL] [SET ADDRESSES] [ADDRESS: PRINTER]** keys.
2. Disconnect the HP 8753B from any external computer controller. Set the instrument to system controller mode by pressing **[LOCAL] [SYSTEM CONTROLLER]**.
3. The sequence to be printed must be in HP 8753B memory. When the printer is ready to print, press **[SYSTEM] [SEQUENCING MENU] [MORE] [PRINT SEQUENCE]**. Press the softkey for the desired sequence.

## IN-DEPTH SEQUENCING INFORMATION

The following information explains details of the basic sequencing operation.

### Features That Operate Differently When Executed in a Sequence

The knob, step keys, **[PRESET]** key, and **[BACK SP]** softkey cannot be used in a sequence.

**Commands That Sequencing Completes Before the Next Sequence Command Begins.** Sequencing completes all operations related to the following commands before continuing.

- Single sweep
- Number of groups
- Auto scale
- Marker search
- Marker function
- Data → memory
- Recall or save (internal or external)
- Copy list values and operating parameters
- CH1, CH2, Wait 0\*

\*Wait 0 is the special sequencing function **[WAIT x]** with a zero entered for the delay value.

**Commands That Require a Clean Sweep.** Many front panel commands disrupt the sweep in progress. Changing the channel or measurement type are examples. When a disruptive command is executed in a sequence, it inhibits some instrument functions until a complete sweep is taken. This applies to the following functions:

- Autoscale
- Data → memory

### **Forward Stepping in Edit Mode**

Forward stepping through the sequence list executes each step. Decision making calls to other sequences do not occur, however. Instead, the cursor jumps to the end of the sequence.

### **Titles**

A title may contain non-printable or special ASCII characters if it is downloaded from an external controller. A non-printable character is represented on the display as  $\pi$ .

### **Sequence Size**

A sequence may contain up to 2 kbytes of instructions. Typically, this is around 200 sequence command lines. To estimate a sequence's size (in kBytes), use the following guidelines.

| Type of Command        | Size in Bytes |
|------------------------|---------------|
| Typical command        | 2             |
| Title string character | 1             |
| Active entry command   | 1 per digit   |

### **Embedding the Value of the Loop Counter in a Title**

The title of stored data can have a sequentially increasing or decreasing numeric value appended to it by placing a **[DISPLAY] [MORE] [TITLE] [MORE] [LOOP COUNTER]** command after the title string. (The title itself must be limited to three characters if it is to be used as a disc filename. The three-character title and five-digit loop counter number reach the eight-character limit for disc filenames.) This feature is useful in data logging applications. The loop counter example given later in this chapter shows how to perform this operation.

# BASIC SEQUENCING MENUS

Figure 13-1 shows all basic sequencing menus. Special functions and their menus are described later in this chapter.

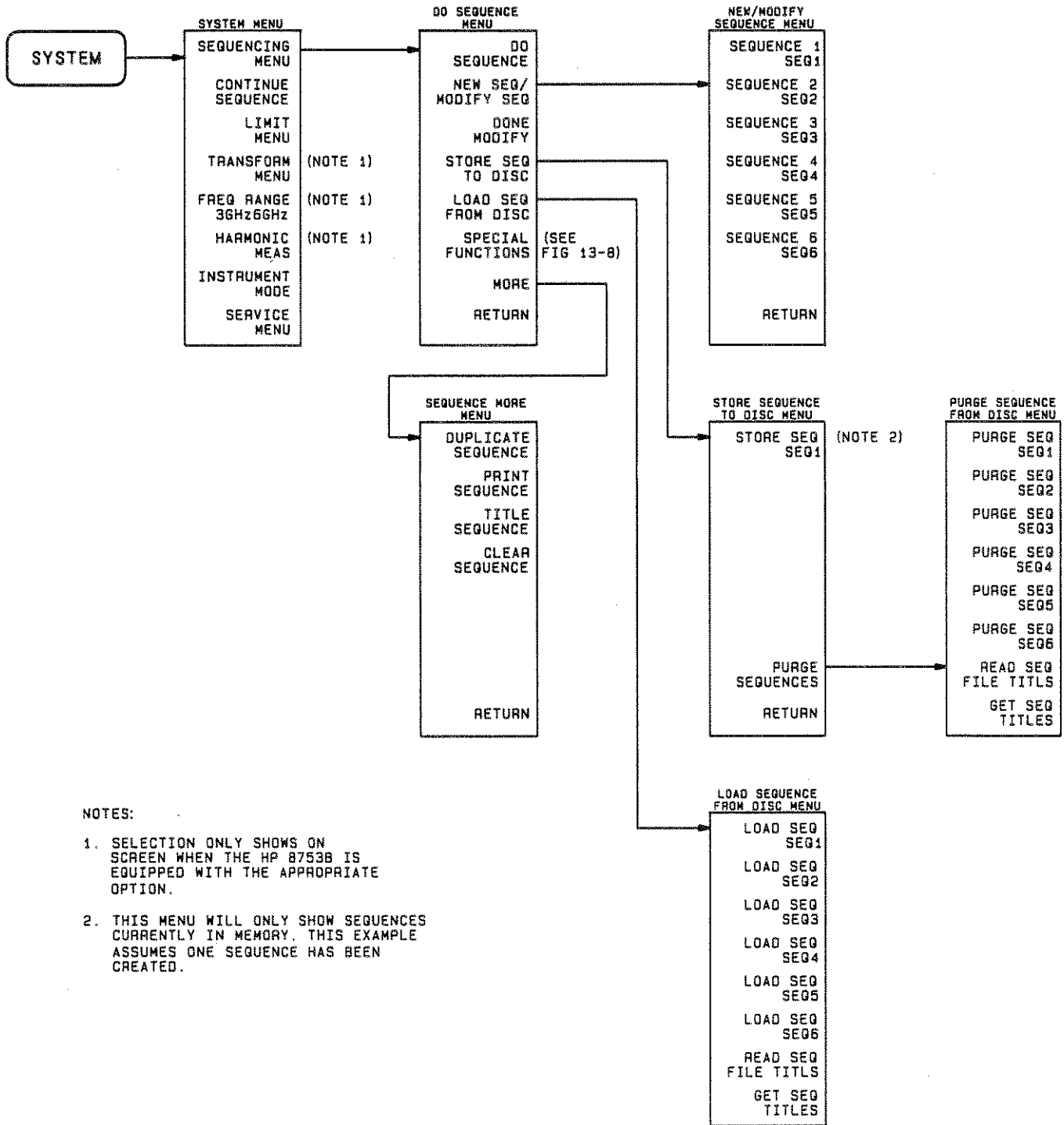

**NOTES:**

1. SELECTION ONLY SHOWS ON SCREEN WHEN THE HP 8753B IS EQUIPPED WITH THE APPROPRIATE OPTION.
2. THIS MENU WILL ONLY SHOW SEQUENCES CURRENTLY IN MEMORY. THIS EXAMPLE ASSUMES ONE SEQUENCE HAS BEEN CREATED.

Figure 13-1. Basic Sequencing Menus

## Do Sequence Menu

Figure 13-2 shows the commands available in the do sequence menu.

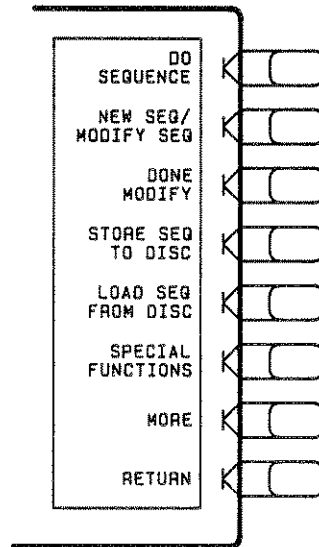

Figure 13-2. Do Sequence Menu

**[DO SEQUENCE]** (DOSEQn) has two functions:

- It shows the current sequences in memory. To run a sequence, press the softkey next to the desired sequence title.
- When entered into a sequence, this command performs a one-way jump to the sequence residing in the specified sequence position (SEQUENCE 1 through 6). **[DO SEQUENCE]** jumps to a softkey position, not to a specific sequence title. Whatever sequence is in the selected softkey position will run when the **[DO SEQUENCE]** command is executed. This command prompts the operator to select a destination sequence position.

**[NEW SEQ/MODIFY SEQ]** (NEWSEQn) activates the edit mode and presents the new/modify sequence menu with a list of sequences that can be created or modified.

**[DONE MODIFY]** (DONM) terminates the edit mode.

**[STORE SEQ TO DISC]** (STORSEQn) presents the store sequence to disc menu with a list of sequences that can be stored.

**[LOAD SEQ FROM DISC]** (LOADSEQn) presents the load sequence from disc menu. Select the desired sequence and the HP 8753B will load it from disc.

**[SPECIAL FUNCTIONS]** presents the special function menu. Available selections include:

- Jump to a sequence (**[DO SEQUENCE]**)
- Limit test decision (**[IF LIMIT TEST PASS]** **[IF LIMIT TEST FAIL]**)
- Loop counter value manipulation (increment/decrement, set value)
- Loop counter decision (**[IF COUNTER = 0]**, **[IF COUNTER <>0]**)

- Send command to printer (**[TITLE TO PRINTER]**)
- Send command to HP-IB device (**[TITLE TO P MTR/HPIB]**)
- Wait
- Pause
- Set CW stimulus frequency to frequency of active marker (**[MARKER → CW]**)
- Emit beep
- Assert SRQ
- Output TTL high or TTL low
- Show menu to operator/show menu in sequence listing (**[SHOW MENUS]**)
- Read data from HP-IB device (**[P MTR/HPIB TO TITLE]**) followed by **[TITLE TO MEMORY]**)
- Move data to data array memory (**[TITLE TO MEMORY]**)

**[MORE]** presents the sequence more menu.

**[RETURN]** returns to the system menu.

### New/Modify Sequence Menu

Procedures for creating and editing sequences are provided at the beginning of this chapter. Figure 13-3 shows the commands available in this menu: Use this to select the sequence to be created or modified. Sequences in positions 1 through 5 are stored in volatile memory and are erased if line power is turned off. Sequence position 6 is stored in non-volatile memory and will survive if line power is turned off.

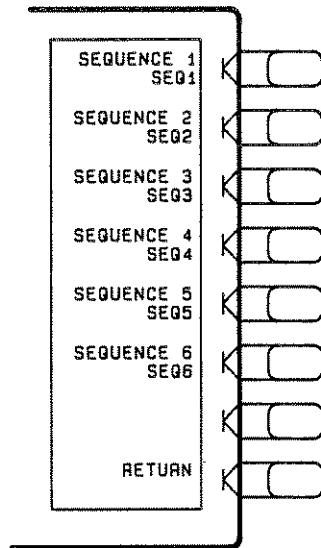

Figure 13-3. New/Modify Sequence Menu

**[SEQUENCE 1 SEQ1]** (NEWSEQ1) activates editing mode for the segment titled "SEQ1" (default title).

**[SEQUENCE 2 SEQ2]** (NEWSEQ2) activates editing mode for the segment titled "SEQ2" (default title).

**[SEQUENCE 3 SEQ3]** (NEWSEQ3) activates editing mode for the segment titled "SEQ3" (default title).

**[SEQUENCE 4 SEQ4]** (NEWSEQ4) activates editing mode for the segment titled "SEQ4" (default title).

**[SEQUENCE 5 SEQ5]** (NEWSEQ5) activates editing mode for the segment titled "SEQ5" (default title).

**[SEQUENCE 6 SEQ6]** (NEWSEQ6) activates editing mode for the segment titled "SEQ6" (default title).

**[RETURN]** returns to the do sequence menu

### Store Sequence to Disc Menu

A procedure for storing a sequence to disc is provided at the beginning of this chapter. Figure 13-4 shows the commands available in this menu. Select the desired sequence and the HP 8753B will store it to a compatible disc drive.

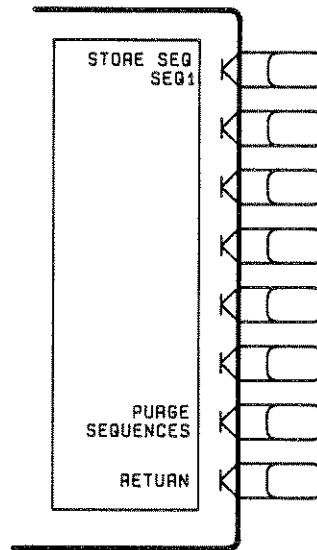

**NOTE:**

THIS MENU ONLY SHOWS SEQUENCES CURRENTLY IN MEMORY. THIS FIGURE ASSUMES ONE SEQUENCE HAS BEEN CREATED.

Figure 13-4. Store Sequence to Disc menu

The store sequence to disc menu shows only the titles of sequences currently in memory. Figure 13-4 is an example menu showing a single sequence in memory. Storing to disc requires a CS-80 compatible HP-IB disc drive such as the HP 9122. The HP 8753B must have the address of the disc drive and be in system controller mode.

**[STORE SEQ SEQ1]** (STORSEQ1) the sequence "SEQ1" is in memory. Pressing this softkey will store "SEQ1" to the disc.

**[PURGE SEQUENCES]** presents the purge sequence from disc menu.

**[RETURN]** returns to the do sequence menu.

## Load Sequence from Disc Menu

Loading a sequence from disc is explained at the beginning of this chapter. Use this menu to select the desired sequence and the HP 8753B will load it from disc.

This menu shows default sequence names unless:

1. The operator has changed one or more of the titles, or...
2. A sequence with a different title has been loaded.

In these cases, the softkey labels will show any 8-character title the operator has entered.

Figure 13-5 shows the load sequence from disc menu.

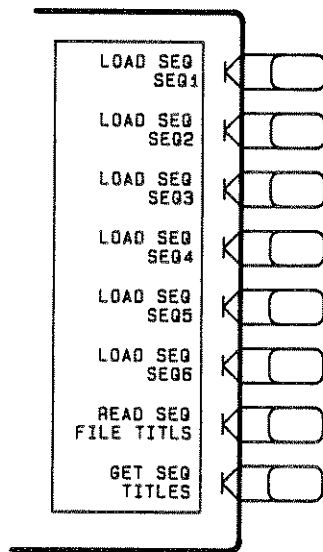

Figure 13-5. Load Sequence from Disk Menu

**[LOAD SEQ SEQ1]** (LOADSEQ1) loads SEQ1 from disc to internal memory.

**[LOAD SEQ SEQ2]** (LOADSEQ2) loads SEQ2 from disc to internal memory.

**[LOAD SEQ SEQ3]** (LOADSEQ3) loads SEQ3 from disc to internal memory.

**[LOAD SEQ SEQ4]** (LOADSEQ4) loads SEQ4 from disc to internal memory.

**[LOAD SEQ SEQ5]** (LOADSEQ5) loads SEQ5 from disc to internal memory.

**[LOAD SEQ SEQ6]** (LOADSEQ6) loads SEQ6 from disc to internal memory.

**[READ SEQ FILE TITLS]** is a disc file directory command. Pressing this softkey will read the first six sequence titles and display them in the softkey labels as described in *Loading a Sequence When the Title Is Not Known*. These sequences can then be loaded into internal memory.

If **[READ SEQ FILE TITLS]** is pressed again, the next six sequence titles on the disc will be displayed. To read the contents of the disc starting again with the first sequence: remove the disc, reinsert it into the drive, and press **[READ SEQ FILE TITLS]**.

**[GET SEQ TITLES]** copies the sequence titles currently in memory into the six softkey positions.



## Purge Sequence from Disc Menu

A procedure for purging a sequence from disc is provided at the beginning of this chapter. Use this menu to select the sequence to be purged from disc. This menu shows default sequence names unless:

1. The operator has changed one or more of the titles, or...
2. A sequence with a different title has been loaded.

In these cases, the softkey labels will show any 8-character title the operator has entered.

Figure 13-6 shows the purge sequence from disc menu.

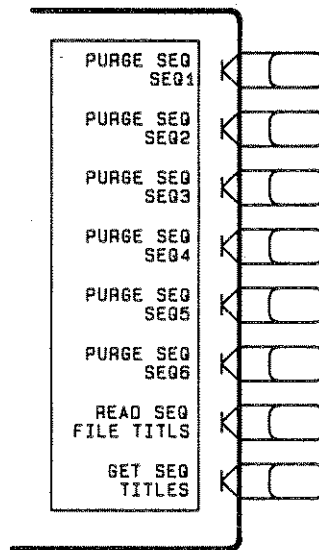

Figure 13-6. Purge Sequence from Disk Menu

**[PURGE SEQ SEQ1]** purges SEQ1 from disc.

**[PURGE SEQ SEQ2]** purges SEQ2 from disc.

**[PURGE SEQ SEQ3]** purges SEQ3 from disc.

**[PURGE SEQ SEQ4]** purges SEQ4 from disc.

**[PURGE SEQ SEQ5]** purges SEQ5 from disc.

**[PURGE SEQ SEQ6]** purges SEQ6 from disc.

**[READ SEQ FILE TITLS]** is a disc file directory command. Pressing this softkey will read the first six sequence titles and display them in the softkey labels as described in *Loading a Sequence When the Title Is Not Known*. These sequences can then be loaded into internal memory.

If **[READ SEQ FILE TITLS]** is pressed again, the next six sequence titles on the disc will be displayed. To read the contents of the disc starting again with the first sequence: remove the disc, reinsert it into the drive, and press **[READ SEQ FILE TITLS]**.

**[GET SEQ TITLES]** copies the sequence titles currently in memory into the six softkey positions.

## Sequence More Menu

Figure 13-7 shows the commands available in the sequence more menu.

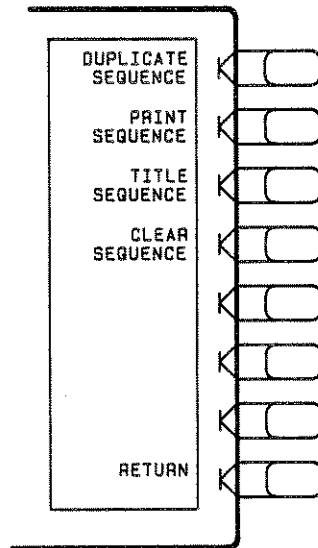

Figure 13-7. Sequence More Menu

**[DUPLICATE SEQUENCE]** (DUPLSEQxSEQy) duplicates a sequence currently in memory into a different softkey position. Duplicating a sequence is straightforward. Follow the prompts on the HP 8753B screen. This command does not affect the original sequence.

**[PRINT SEQUENCE]** (PRINSEQn) prints any sequence currently in memory to a compatible printer. Refer to *Accessories Available* in the *General Information and Specifications* section for a list of compatible printers. A procedure for printing a sequence is provided at the beginning of this chapter.

**[TITLE SEQUENCE]** (TITSEQn) allows the operator to rename any sequence with an eight character title. All titles entered from the front panel must begin with a letter, and may only contain letters and numbers. A procedure for changing the title of a sequence is provided at the beginning of this chapter.

**[CLEAR SEQUENCE]** (CLEASEn) clears a sequence from memory. The titles of cleared sequences will remain in load, store, and purge menus. This is done as a convenience for those who often reuse the same titles. A procedure for clearing a sequence is provided at the beginning of this chapter.

**[RETURN]** returns to the do sequence menu.

## SEQUENCING SPECIAL FUNCTIONS

The purposes of some special functions are not obvious from the softkey label. Figure 13-8 shows all special function menus.

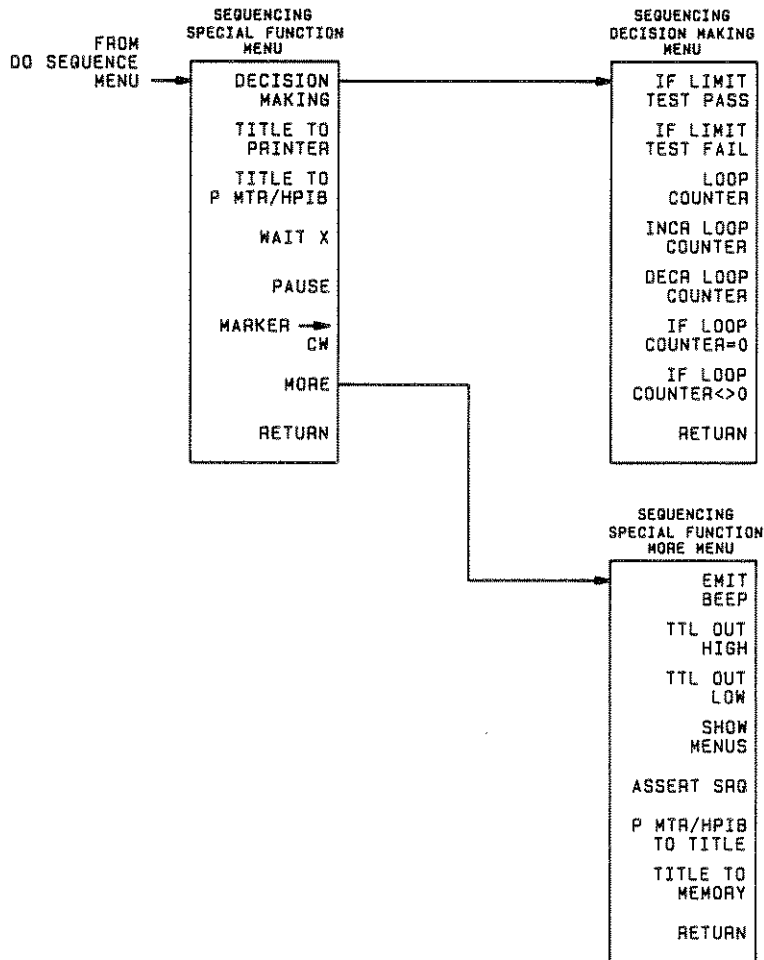

Figure 13-8. Sequencing Special Function Menus

### Important Concepts

Some concepts presented in this chapter require explanation. Key concepts are explained below:

**Sequence Title and Sequence Position.** There are two attributes to any sequence. Each sequence has a title, and exists in one of the six sequence softkey positions. Softkey positions are referred to as SEQUENCE 1 through SEQUENCE 6, with position 1 at the top.

**Decision Making Functions.** Decision making functions are explained in more detail below. These functions check a condition and jump to a specified sequence if the condition is true. The sequence called must be in memory. A sequence call is a one-way jump, there is no equivalent to computer subroutines in sequencing. A sequence can jump to itself, or to any of the other five sequences currently in memory. Use of these features is explained under the specific softkey descriptions.

**Decision making functions jump to a softkey location, not to a specific sequence title.** Limit test, loop counter, and do sequence commands jump to any sequence residing in the specified sequence position (SEQUENCE 1 through 6). These commands do not jump to a specific sequence title. Whatever sequence is in the selected softkey position will run when these commands are executed.

**Having a Sequence Jump to Itself.** A decision making command can jump to the sequence it is in. When this occurs, the sequence starts over and all commands in the sequence are repeated. This is used a great deal in conjunction with loop counter commands. See the loop counter description below.

**Limit Test Decision Making.** A sequence can jump to another sequence or start over depending on the result of a limit test. When entered into a sequence, the **[IF LIMIT TEST PASS]** and **[IF LIMIT TEST FAIL]** commands require the operator to enter the destination sequence.

**Loop Counter/Loop Counter Decision Making.** The HP 8753B has a numeric register called a loop counter. The value of this register can be set by a sequence, and it can be incremented or decremented each time a sequence repeats itself. The decision making commands **[IF LOOP COUNTER = 0]** and **[IF LOOP COUNTER <> 0]** jump to another sequence if the stated condition is true. When entered into the sequence, these commands require the operator to enter the destination sequence. Either command can jump to another sequence, or restart the current sequence.

As explained later, the loop counter value can be appended to a title. This allows customized titles for data printouts or for data files saved to disc.

## Autostarting Sequences

A sequence can be defined that will run automatically when power is applied to the HP 8753B. To make an autostarting sequence, create a sequence in position six and title it "AUTO". To stop an autostarting sequence, press **[LOCAL]**. To stop an autostarting sequence from engaging at power on, you must clear it from memory or rename it. Instructions for performing either task are provided near the beginning of this chapter.

## Sequencing Special Function Menu

Figure 13-9 shows the commands available in this menu.

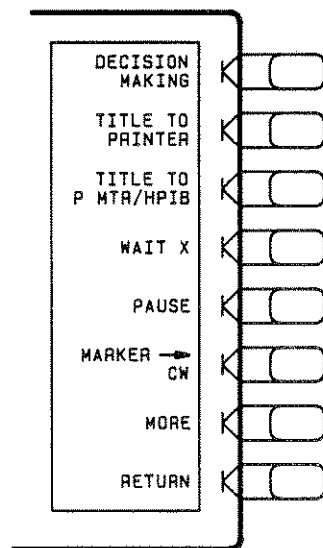

Figure 13-9. Sequencing Special Function Menu

**[DECISION MAKING]** presents the sequencing decision making menu.

**[TITLE TO PRINTER]** (TITTPRIN) outputs a title string to any device with an HP-IB address that matches the address set with the HP 8753B **[LOCAL]** **[SET ADDRESSES]** **[ADDRESS: PRINTER]** commands. This softkey is generally used for two purposes:

- Sending a title to a printer for data logging or documentation purposes.
- Sending commands to a printer or other HP-IB device.

When entering a sequence, create a display title and press **[TITLE TO PRINTER]**. When the sequence is run, the title will be sent to the printer. This command appends a carriage-return line feed (CR-LF) to the end of the string. The HP 8753B must be in system controller or pass control mode. To send a command to a printer or other HP-IB device, use the same procedure but enter the desired command as the title string.

**[TITLE TO P MTR/HPIB]** (TITTPMTR) outputs a title string to any device with an HP-IB address that matches the address set with the HP 8753B **[LOCAL]** **[SET ADDRESSES]** **[ADDRESS: P MTR/HPIB]** commands. This softkey is generally used for two purposes:

- Sending a title to a printer when a CR-LF is not desired.
- Sending commands to an HP-IB device.

When entering a sequence, create a display title containing a command or text string and press **[TITLE TO P MTR/HPIB]**. When the sequence is run, the string will be sent to the HP-IB device. The HP 8753B must be in system controller or pass control mode.

**[WAIT X]** (SEQWAIT) pauses the execution of subsequent sequence commands for x number of seconds. Terminate this command with **[x1]**.

Entering a 0 in wait x causes the instrument to wait for prior sequence command activities to finish before allowing the next command to begin. The wait 0 command only affects the command immediately following it, and does not affect commands later in the sequence.

**[PAUSE]** (PAUS) pauses the sequence so the operator can perform a needed task, such as changing the DUT, changing the calibration standard, or other similar task. Press **[CONTINUE SEQUENCE]** when ready.

**[MARKER → CW]** (MARKCW) sets the CW frequency of the HP 8753B to the frequency of the active marker.

**[MORE]** presents the sequencing special function more menu.

**[RETURN]** returns to the do sequence menu.

## Sequencing Decision Making Menu

Figure 13-10 shows the commands available in this menu.

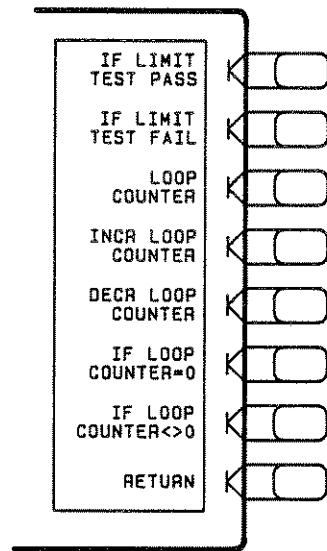

Figure 13-10. Sequencing Decision Making Menu

**Limit Test Commands.** Limit lines must be set up in the sequence before limit test pass/fail commands are performed. The limit test decision-making commands jump to a specified sequence if the conditions of the command are met.

**Decision-Making Sequence Examples.** Examples of limit test and loop counter sequences are provided at the end of this chapter.

**[IF LIMIT TEST PASS]** (IFLTPASS) jumps to one of the six sequence positions (SEQUENCE 1 through 6) if the limit test passes. This command executes any sequence residing in the selected position. Sequences may jump to themselves as well as to any of the other sequences in memory. When this softkey is pressed, the HP 8753B presents a softkey menu showing the six sequence positions, and the titles of the sequences located in them. Choose the sequence to be called if the limit test passes (destination sequence).

**[IF LIMIT TEST FAIL]** (IFLTFAIL) jumps to one of the six sequence positions (SEQUENCE 1 through 6) if the limit test fails. This command executes any sequence residing in the selected position. Sequences may jump to themselves as well as to any of the other sequences in memory. When this softkey is pressed, the HP 8753B presents a softkey menu showing the six sequence positions and the titles of the sequences located in them. Choose the destination sequence to be called if the limit test fails.

**[LOOP COUNTER]** (LOOC) sets the value of the loop counter. Enter any number from 0 to 32767 and terminate with the [x1] key. The default value of the counter is zero. This command should be placed in a sequence that is separate from the measurement sequence. For this reason: the measurement sequence containing a loop decision command must call itself in order to function. The **[LOOP COUNTER]** command must be in a separate sequence or the counter value would always be reset to the initial value.

**[INCR LOOP COUNTER]** (INCRLOOC) increments the value of the loop counter by 1.

**[DECR LOOP COUNTER]** (DECRLOOC) decrements the value of the loop counter by 1.

**[IF LOOP COUNTER = 0]** (IFLCEQZE) prompts the user to select a destination sequence position (SEQUENCE 1 through 6). When the value of the loop counter reaches zero, the sequence in the specified position will run.

**[IF LOOP COUNTER <> 0]** (IFLCNEZE) prompts the user to select a destination sequence position (SEQUENCE 1 through 6). When the value of the loop counter is no longer zero, the sequence in the specified position will run.

## Sequencing Special Function More Menu

Figure 13-11 shows the commands available in this menu.

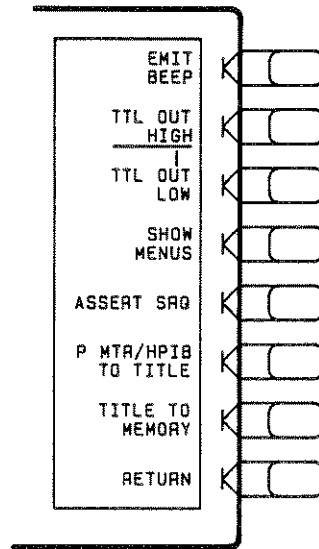

Figure 13-11. Sequencing Special Function More Menu

**[EMIT BEEP]** (EMIB) causes the instrument to beep once.

**[TTL OUT HIGH]** (TTLOH) sets the TTL output BNC on the back of the HP 85047A high.

**[TTL OUT LOW]** (TTLOL) sets the TTL output BNC on the back of the HP 85047A low.

**[SHOW MENUS]** (SHOM) used to display a specific menu prior to a pause statement.

Normally, the sequence list does not show menu softkeys. When **[SHOW MENUS]** is entered into a sequence, subsequent menu names will appear in the sequence list until a key is pressed that actually performs a function.

**[ASSERT SRQ]** (ASSS) sends an SRQ (service request) to the system controller.

**[P MTR/HPIB TO TITLE]** (PMTRTTIT) gets data from an HP-IB device set to the address at which the HP 8753B expects to find a power meter. The data is stored in a title string. The HP 8753B must be in system controller or pass control mode.

The external device should be given an interrogation command with the **[TITLE TO P MTR/HPIB]** or **[TITLE TO PRINTER]** command. When **[P MTR/HPIB TO TITLE]** is sent, the HP 8753B will wait indefinitely (or until **[LOCAL]** is pressed) for a string of up to 80 characters. The HP 8753B expects an EOI or line feed as a string terminator. This command can be used in conjunction with **[TITLE TO MEMORY]**, below.

**[TITLE TO MEMORY]** (TITTMEM) moves the title string data obtained with the **[P MTR/HPIB TO TITLE]** command into a data array. **[TITLE TO MEMORY]** strips off leading characters that are not numeric, reads the numeric value, and then discards everything else. The number is converted into HP 8753B internal format, and is placed into the real portion of the memory trace at:

Display point = total points - 1 - loop counter

If the value of the loop counter is zero, then the title number goes in the last point of memory. If the loop counter is greater than or equal to the current number of measurement points, the number is placed in the first point of memory. A data to memory command must be executed before using the title to memory command.

**[RETURN]** returns to the sequencing special functions menu.

## HP-GL CONSIDERATIONS

### HP-GL Commands Can Be Entered Locally, or Be Included in a Sequence

HP-GL (Hewlett-Packard Graphics Language) can create customized messages or illustrations on the screen of the HP 8753B. To use HP-GL, the instrument must be in system controller mode.

HP-GL commands should be entered into a title string using the **[DISPLAY]** **[MORE]** **[TITLE]** and character selection menu.

The **[TITLE TO P MTR/HPIB]** or **[TITLE TO PRINTER]** sequencing commands send the HP-GL command string to the instrument's HP-GL address. The HP 8753B needs no HP-IB cables connected to it to perform HP-GL commands. The address of the HP 8753B HP-GL graphics interface is always offset from the instrument's HP-IB address by 1:

- If the current instrument address is an even number:  
HP-GL address = instrument address + 1.
- If the current instrument address is an odd number:  
HP-GL address = instrument address - 1.

### Special Commands Required for HP-GL

Two HP-GL commands require special consideration when used in local operation or in sequencing. These are explained below:

**Plot Absolute (HP-GL command: PA).** The syntax for this command is PAx,y where x and y are screen location coordinates separated by a comma. The title function on the HP 8753B does not have a comma, so the HP 8753B allows x and y coordinates to be separated with a forward slash "/".

**Label (HP-GL command: LB).** The syntax for this command is LB[text][etx]. The label command will print ASCII characters until the etx command is seen. The etx is the ASCII value 3 (not the ASCII character 3).

The HP 8753B title function does not have the ASCII value 3, so the instrument allows the LB command to be terminated with the **[END OF LABEL]** command (accessed by pressing **[DISPLAY]** **[MORE]** **[TITLE]** **[MORE]** **[END OF LABEL]**).

HP-GL is described in Appendix D of the *HP-IB Quick Reference Guide* and in *Example 3, User Interface*, in the *HP-IB Introductory Programming Guide*.



## ENTERING SEQUENCES USING HP-IB

A sequence can be created in a computer controller using HP-IB codes and entered into the HP 8753B over HP-IB. The process is the same as entering a sequence locally – the same keystrokes are used. This method replaces the keystrokes with HP-IB commands. The following is a procedure for entering a sequence over HP-IB:

1. Send the HP-IB command NEWSEQx where x is a number from 1 to 6.
2. Send the HP-IB commands for the measurement.
3. Terminate with the HP-IB command DONM (done modify).

## READING SEQUENCES USING HP-IB

An external controller can read the commands in any sequence (in HP-IB command format). Send the following command to the HP 8753B:

OUTPSEQx where x is a number from 1 to 6.

Allocate an adequate amount of string variable space in the external controller and execute an ENTER statement.

## DECISION-MAKING SEQUENCE EXAMPLES

### Limit Test Example Sequence:

This example assumes limit line setup commands have been entered earlier in the sequence:

| Keys Pressed                                                                                                           | Sequence List<br>On Screen               | Explanation                                                                  |
|------------------------------------------------------------------------------------------------------------------------|------------------------------------------|------------------------------------------------------------------------------|
| [SYSTEM] [LIMIT MENU]<br>[LIMIT LINE ON]                                                                               | LIMIT LINE<br>ON                         | Turn on previously set up limit lines.                                       |
| [LIMIT TEST ON]                                                                                                        | LIMIT TEST<br>ON                         | Turn limit testing on.                                                       |
| [MEAS] [B/R]<br>[SCALE REF]<br>[2] [x1]                                                                                | B/R<br>SCALE/DIV<br>2 x 1                | Measurement commands.                                                        |
| [MENU] [TRIGGER MENU]<br>[SINGLE]                                                                                      | SINGLE                                   | Update the data and limit test.                                              |
| [SYSTEM]<br>[SEQUENCING MENU]<br>[SPECIAL FUNCTIONS]<br>[DECISION MAKING]<br>[IF LIMIT TEST PASS]<br>[SEQUENCE 4 SEQ4] | IF LIMIT TEST PASS THEN DO<br>SEQUENCE 4 | Jump to the sequence in sequence position 4 if the limit test passes.        |
| [RETURN] [MORE]<br>[EMIT BEEP]                                                                                         | EMIT BEEP                                | Test failed, beep to inform operator.                                        |
| [RETURN] [PAUSE]<br>[RETURN]                                                                                           | PAUSE                                    | Pause to let the operator change DUT.                                        |
| [DO SEQUENCE]<br>[SEQUENCE 1 SEQ1]<br>[DONE MODIFY]                                                                    | DO SEQUENCE<br>SEQUENCE 1                | Jump back to the start of this sequence.<br><br>Exit the modify (edit) mode. |

## Loop Counter Example Sequence:

Initial Sequence Position and Title: SEQUENCE 1 SEQ1

| Key Pressed                                                                                           | Sequence List On Screen   | Explanation                                 |
|-------------------------------------------------------------------------------------------------------|---------------------------|---------------------------------------------|
| [SYSTEM]<br>[SEQUENCING MENU]<br>[NEW SEQ/MODIFY SEQ]<br>[SEQUENCE 1 SEQ1]                            | Start of Sequence         | Enter modify (edit) mode.                   |
| [RECALL]<br>[RECALL PRST STATE]                                                                       | RECALL PRST STATE         | Preset the instrument                       |
| [MEAS]<br>[Trans: FWD S21 (B/R)]                                                                      | Trans: FWD S21 (B/R)      | Set up an S21 measurement                   |
| [LOCAL]<br>[SYSTEM CONTROLLER]                                                                        | SYSTEM CONTROLLER         | Set the HP 8753B to system controller mode  |
| [SET ADDRESSES]<br>[ADDRESS: PRINTER]<br>[1] [x1]                                                     | ADDRESS: PRINTER<br>1 x1  | Set the HP 8753B's address for the printer  |
| [SYSTEM]<br>[SEQUENCE MENU]<br>[SPECIAL FUNCTIONS]<br>[DECISION MAKING]<br>[LOOP COUNTER]<br>[5] [x1] | LOOP COUNTER<br>5 x1      | Set loop counter value to 5                 |
| [RETURN] [RETURN]<br>[DO SEQUENCE]<br>[SEQUENCE 2 SEQ2]                                               | DO SEQUENCE<br>SEQUENCE 2 | Jump to the sequence in sequence position 2 |
| [DONE MODIFY]                                                                                         |                           | Leave the modify (edit) mode.               |

Second Sequence Position and Title: SEQUENCE 2 SEQ2

| Key Pressed                                                                                                          | Sequence List On Screen | Explanation                                   |
|----------------------------------------------------------------------------------------------------------------------|-------------------------|-----------------------------------------------|
| [SYSTEM]<br>[SEQUENCING MENU]<br>[NEW SEQ/MODIFY SEQ]<br>[SEQUENCE 1 SEQ1]                                           | Start of Sequence       | Enter modify (edit) mode.                     |
| [DISPLAY] [MORE]<br>[TITLE]<br>Press [ERASE TITLE].<br>Enter "DUT" with knob<br>and [SELECT LETTER].<br>Press [MORE] | TITLE                   | Enter the title "DUT[LOOP]"*                  |
| [LOOP COUNTER]<br>[RETURN] [DONE]                                                                                    | DUT[LOOP]*              | Create customized title.                      |
| [SYSTEM]<br>[SEQUENCING MENU]<br>[SPECIAL FUNCTIONS]<br>[PAUSE]                                                      | SYSTEM<br>PAUSE         | The operator should connect or change the DUT |

\* When the test results are printed, each title will have a different numeric value at the end (DUT00005, DUT00004, DUT00003, DUT00002, and DUT00001). Note that the loop counter value always contains five digits.

| Key Pressed                                                                                                                                   | Sequence List On Screen                                         | Explanation                                                                                                                                     |
|-----------------------------------------------------------------------------------------------------------------------------------------------|-----------------------------------------------------------------|-------------------------------------------------------------------------------------------------------------------------------------------------|
| [MENU] [TRIGGER MENU]<br>[SINGLE]<br>[COPY] [PRINT]                                                                                           | SINGLE<br>PRINT                                                 | Take a sweep to update the data<br>Results are printed with title DUTx<br>(x=loop #)                                                            |
| [SYSTEM]<br>[SEQUENCING MENU]<br>[SPECIAL FUNCTIONS]<br>[DECISION MAKING]<br>[DECR LOOP COUNTER]<br>[IF LOOP COUNTER <> 0]                    | DECR LOOP COUNTER<br>IF LOOP COUNTER <> 0 THEN DO<br>SEQUENCE 2 | Decrement loop counter<br>If the value of the loop counter is not<br>equal to zero, loop back and test<br>another DUT.                          |
| [DISPLAY] [MORE] [TITLE]<br><br>Press [ERASE TITLE].<br>Enter "TEST IS FINISHED"<br>with knob and<br>[SELECT LETTER] softkey.<br>Press [DONE] | TITLE<br><br><br><br><br><br><br>TEST IS FINISHED               | If loop counter = zero, exit loop and<br>display "TEST IS FINISHED"<br><br><br><br><br><br><br>"TEST IS FINISHED" is displayed on<br>the screen |
| [SYSTEM]<br>[SEQUENCING MENU]<br>[DONE MODIFY]                                                                                                |                                                                 | Exit modify (edit) mode.                                                                                                                        |



# Chapter 14. Instrument Modes, 6 GHz, Frequency Offset, and Harmonic Operation

---

## CHAPTER CONTENTS

- 14-1 Introduction
- 14-2 Instrument Modes
- 14-2 Instrument Mode Overview
- 14-4 Network Analyzer Mode
- 14-4 External Source Mode
- 14-6 Tuned Receiver Mode
  
- 14-8 Other Features Available Under the System Key
- 14-8 Feature Overview
- 14-8 Frequency Offset Operation
- 14-12 6 GHz Operation (Option 006 Only)
- 14-14 Harmonic Operation (Option 002 Only)
- 14-17 Spurious Signal Passbands in External Source Mode, Tuned Receiver Mode, and Frequency Offset Operation

## INTRODUCTION

This chapter describes the three major instrument modes of the HP 8753B:

- Network analyzer mode
- External source mode
- Tuned receiver mode

In addition, three features are described:

- Frequency offset operation
- 6 GHz mode operation (option 006 only)
- Harmonic mode operation (option 002 only)

For each of these topics, the following information is provided:

- The primary measurement application in which each mode or feature is used.
- A complete description of each mode or feature with a typical test setup.
- Formulas for calculating spurious signal passbands for external source mode, tuned receiver mode, and for frequency offset operation.

All of the features described in this chapter are accessible under the **[SYSTEM]** key. Figure 14-1 shows the relationship of the menus described in this chapter.

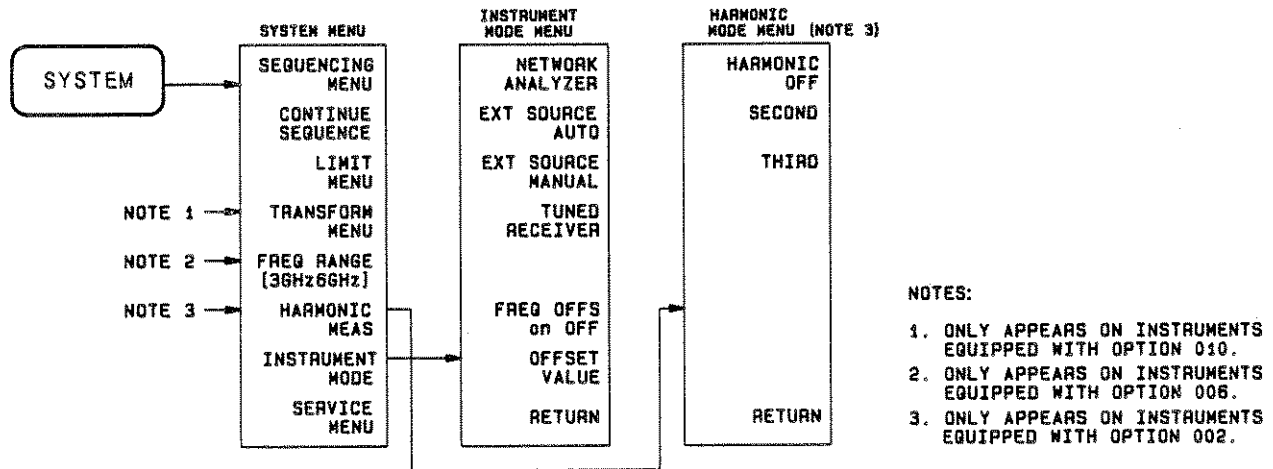

Figure 14-1. Relationship of Applicable [SYSTEM] Key Menus

## Instrument Modes

### INSTRUMENT MODE OVERVIEW

There are three major modes of operation in the HP 8753B:

#### Network Analyzer Mode

This is the standard mode of operation for the HP 8753B, and is active after preset or power-on. Network analyzer mode in the HP 8753B is similar to the operation of the HP 8753A.

#### External Source Mode

This mode allows the HP 8753B to phase lock to an external CW signal. External source mode has the following features and limitations:

- It is phase-locked.
- It functions only in CW time sweep.
- It does not require a synthesized source.

The external source's signal should not have large sidebands or spurs.

## Tuned Receiver Mode

In tuned receiver mode, the HP 8753B receiver operates independently of any signal source. The following features and limitations apply to the tuned receiver mode:

- It is not phase-locked
- It functions in all sweep types
- It requires a synthesized CW source
- It is much faster than external source mode

## Getting to the Instrument Mode Menu

Pressing **[SYSTEM]** **[INSTRUMENT MODE]** brings up the instrument mode menu, illustrated in Figure 14-2.

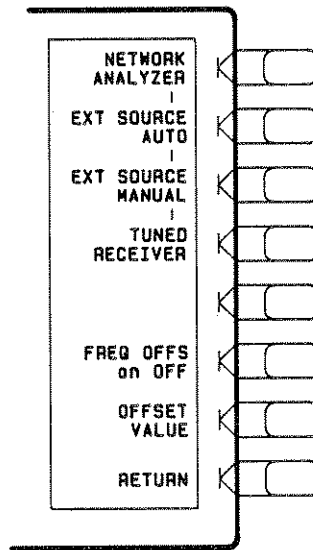

Figure 14-2. Instrument Mode Menu

**[NETWORK ANALYZER]** returns the HP 8753B to the "normal" network analyzer operating mode. This mode uses the HP 8753B built-in source.

**[EXTERNAL SOURCE AUTO]** turns on the external source auto mode. This mode allows the HP 8753B to phase lock to an external CW signal. This works only in CW time sweep. The incoming signal should not have large spurs or sidebands, as the HP 8753B may phase lock on a spur instead of the fundamental. The auto mode has a wider capture range than the manual mode. Refer to *External Source Mode* for details.

**[EXTERNAL SOURCE MANUAL]** Turns on the external source manual mode. This mode has a smaller capture range than the auto mode. However, manual mode is much faster than auto mode. This feature works only in CW time sweep type.

**[TUNED RECEIVER]** The HP 8753B receiver operates independently of any signal source. This mode is not phase locked and functions in all sweep types. The HP 8753B tunes the receiver for a synthesized CW input signal at a precisely specified frequency. All phase lock routines are bypassed, increasing sweep speed significantly. The external source must be synthesized, and must drive the HP 8753B's external frequency reference.

**[FREQ OFFS on OFF]** (frequency offset operation) allows phase-locked operation with a frequency offset between the internal source and receiver. Frequency offset is not an instrument mode, it is a feature accessible in the network analyzer mode. This feature is used in swept RF mixer measurements and has an upper frequency limit of 3 GHz.

**[OFFSET VALUE]** Press this softkey to enter the offset (LO) frequency for frequency offset operation.

## **NETWORK ANALYZER MODE**

The network analyzer mode is the standard mode of operation for the HP 8753B, and is active at power-on or preset.

## **EXTERNAL SOURCE MODE**

The receiver (input R) detects and phase locks to an externally generated CW signal. Receiver inputs A and B can measure this same frequency for comparison or tracking measurements. Two types of external source operation are provided, automatic and manual. Refer to the *External Source Mode In-Depth Description* on the next page.

If a synthesized external source is used, the tuned receiver mode is recommended because it is faster. External source mode is best used for unknown signals, or for signals that drift.

## **Primary Applications**

External source mode is useful in several applications:

- When the DUT is a mixer or other frequency translation device.
- In automated test applications where a source is already connected to the system, and the operator does not wish to switch between the system source and the HP 8753B's internal source.
- When an HP 8753B option 006 is used above 3 GHz without an HP 85047A test set. (This requires an external source and signal separation device.)



## Typical Test Setup

Figure 14-3 shows a typical test setup using the external source mode. The same test setup is applicable to either manual or automatic external source mode operation.

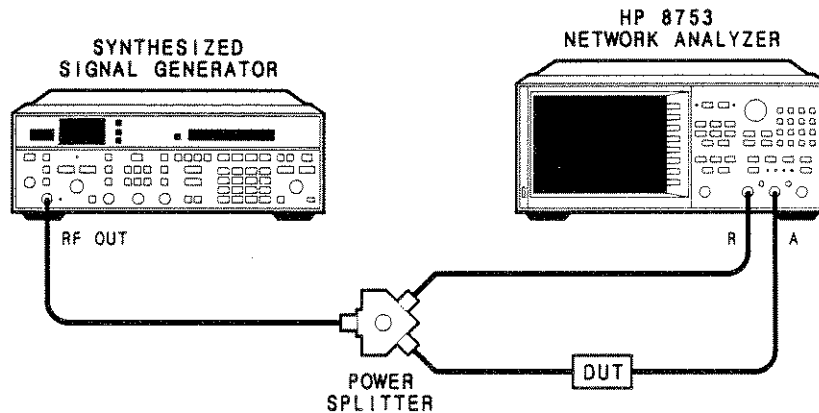

Figure 14-3. Typical Test Setup for External Source Mode

## External Source Mode In-Depth Description

External source may be used in automatic or manual mode. External source mode phase locks the HP 8753B to an external CW signal. This feature only works in CW time sweep.

**External Source Auto.** The external source auto mode searches for the incoming CW signal. The capture range is typically 10% of the selected CW frequency. The manual mode is faster than the auto mode. The frequency the instrument has locked onto is displayed on the CRT, and is also available via HP-IB.

The external source should not exhibit noise or significant sidebands, as this may cause the 8753B to phase lock on a spur or not lock at all.

**External Source Manual.** The incoming signal should not have large spurs or sidebands for the reasons explained above. This mode is faster than the auto mode, but it does not search for the incoming signal. The frequency of the incoming signal should be within  $-0.5$  to  $+5.0$  MHz of the selected frequency or the HP 8753B will not be able to phase lock to it.

**Frequency Range.** 300 kHz to 3 GHz (6 GHz for option 006)

**Compatible Sweep Types.** The external source mode will only function in CW time sweep. If the instrument is in any other sweep type when external source is activated, the warning message "CHANGED TO CW TIME MODE" will appear on the display.

**External Source Requirements.** The external source mode has spectral purity and power input requirements, which are described in the specifications table in the *General Information and Specifications* section of his manual.

Input Channels: R, A, B

**Capture Range.** In either automatic or manual mode, the operator enters the frequency of the external CW signal using the **[CW FREQ]** softkey (located under the Stimulus **[MENU]** key). The actual signal must be within a certain frequency capture range.

*External Source Capture Ranges*

|                                |                                                                           |
|--------------------------------|---------------------------------------------------------------------------|
| <b>Automatic Mode</b>          |                                                                           |
| Above 50 MHz:<br>Below 50 MHz: | $\pm 10\%$ of nominal CW frequency<br>$\pm 5$ MHz of nominal CW frequency |
| <b>Manual Mode</b>             |                                                                           |
| All frequencies                | $-0.5$ to $+5$ MHz of nominal CW frequency                                |

If the incoming signal is not within the capture range, the HP 8753B will not phase lock properly. Also, the signal should not be sweeping.

**Locking Onto a Signal with a Frequency Modulation Component.** Although the HP 8753B may phase-lock onto a signal with FM on it, it may not accurately show the signal's amplitude. The accuracy of such measurements depends greatly on the chosen IF bandwidth. Use the widest IF bandwidth available (3 kHz) if this problem occurs.

**Spurious Signal Passband Frequencies.** Because of the characteristics of the sampler, spurious signals present at certain frequencies can cause measurement inaccuracy. These frequencies can be calculated. Refer to *Spurious Signal Passbands In External Source Mode, Tuned Receiver Mode, and Frequency Offset Operation* at the end of this chapter.

## TUNED RECEIVER MODE

In tuned receiver mode, the HP 8753B's receiver operates independently of any signal source. This mode is not phase locked and functions in all sweep types. The HP 8753B tunes the receiver to a synthesized CW input signal at a precisely specified frequency. All phase lock routines are bypassed, increasing sweep speed significantly. The external source must be synthesized, and must drive the HP 8753B external frequency reference.

### Primary Applications

The tuned receiver mode is useful for:

- Automated test applications where an external synthesized source is available.
- In applications where speed is important. This mode does not phase lock and is much faster than the external source mode.

## Typical Test Setup

Figure 14-4 shows a typical test setup using tuned receiver mode in a CW measurement. The incoming signal can be input to either the A, B, or R inputs. Inputs A and B have greater dynamic range.

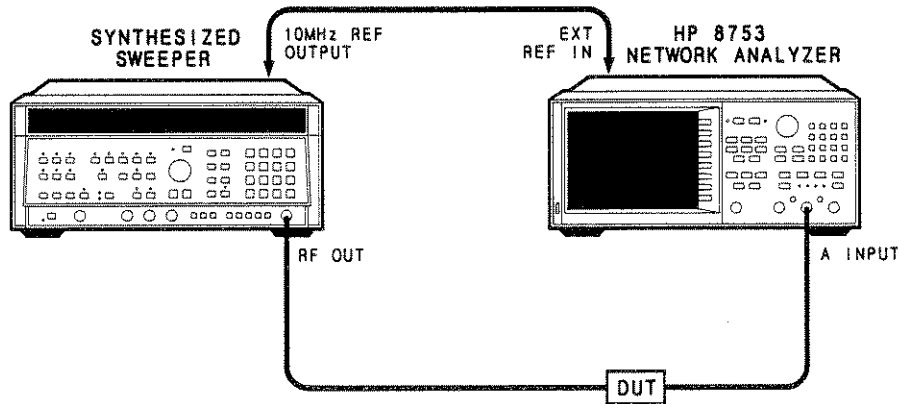

Figure 14-4. Typical Test Setup for Tuned Receiver Mode

The tuned receiver mode is typically used in CW applications. An example of non-CW operation is a third order intermodulation measurement using list mode, manual trigger, and an external synthesized source. Refer to the third order intermodulation measurement description in product note 8753-1, *Amplifier Measurements with the HP 8753*, HP part number 5956-4361.

### Tuned Receiver Mode In-Depth Description

**Frequency Range.** 300 kHz to 3 GHz (6 GHz for option 006)

**Compatible Sweep Types.** All sweep types may be used.

**External Source Requirements.** The tuned receiver mode has the following input requirements:

Input: A, B, or R

Input power range specifications are provided in the specifications table, located in the *General Information and Specifications* section of this manual.

**Spurious Signal Passband Frequencies.** Because of the characteristics of the sampler, spurious signals present at certain frequencies can cause measurement inaccuracy. These frequency passbands in the sampler can be calculated. Refer to *Spurious Signal Passbands In External Source Mode, Tuned Receiver Mode, and Frequency Offset Operation* at the end of this chapter.

## Other Features Available Under the System Key

### FEATURE OVERVIEW

Three features are described:

- Frequency offset operation
- 6 GHz operation (option 006 only)
- Harmonic operation (option 002 only)

The applicable system-related softkeys are shown in Figure 14-1, at the beginning of this chapter.

### Frequency Offset Operation

Sets the RF source to a fixed offset frequency above the receiver as required in a mixer test using a swept RF/IF and fixed LO. This allows a device to be stimulated over one frequency range and its response to be viewed over another. Frequency offset can be used in any sweep type, and in external source or tuned receiver instrument modes.

### 6 GHz Operation (Option 006 Only)

6 GHz operation is activated by the **[FREQ RANGE 3GHz6GHz]** softkey. This feature toggles the receiver between two frequency ranges:

- 300 kHz to 3 GHz
- 3 MHz to 6 GHz

The frequency range softkey appears only on an HP 8753B equipped with option 006, and then only when connected to an HP 85047A 6 GHz test set. The receiver may be used up to 6 GHz without the HP 85047A test set, in external source or tuned receiver modes or in harmonic operation. 6 GHz operation can be used in any sweep type or instrument mode.

### Harmonic Measurements (Option 002 Only)

The harmonics feature measures the second or third harmonic as the HP 8753B source sweeps fundamental frequencies above 16 MHz. Harmonic measurements may be made in any sweep type or instrument mode.

### FREQUENCY OFFSET OPERATION

This sets the RF source to a fixed offset frequency above the receiver as required in a mixer test using a swept RF/IF and fixed LO. This allows a device to be stimulated over one frequency range and its response to be viewed over another. The maximum delay between the RF source and the R input is 3 microseconds. The displayed signal is a composite of the desired RF signal, image response, and spurious signals.

Frequency offset can be used in any sweep type in network analyzer mode. The two user-defined variables in this mode are receiver frequency (IF) and offset frequency (LO). Source frequency (RF) is automatically set by the instrument and equals  $IF + LO$ .

Mixer measurements and frequency offset mode applications are explained in application note 8753-2, *RF Component Measurements – Mixer measurements using the HP 8753B network analyzer*, HP part number 5956-4362.

## Primary Applications

Frequency offset mode is useful for the following types of measurements on a frequency-translating device:

- Conversion loss
- Conversion compression
- Amplitude and phase tracking

## Typical Test Setup

Figure 14-5 shows a typical test setup using frequency offset mode. Instructions are provided in *Using Frequency Offset Mode*. The attenuators shown reduce mismatch uncertainties. The low pass filter keeps unwanted mixing products out of the HP 8753B sampler.

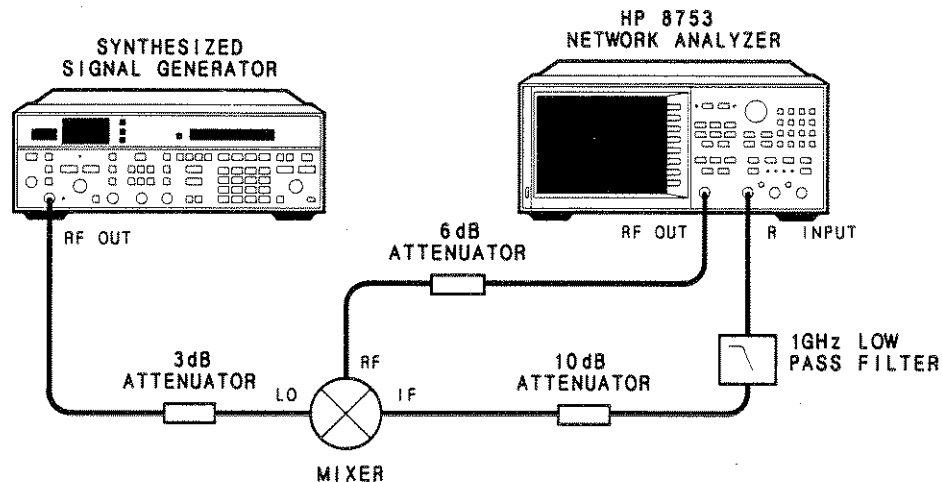

Figure 14-5. Typical Test Setup for a Frequency Offset Measurement

## Frequency Offset In-Depth Description

In frequency offset operation, the source and the receiver operate at two different frequencies. The difference between the source and receiver frequencies is the user-specified offset frequency.

The two user-defined variables in frequency offset are the receiver (IF) frequency, and the offset (LO) frequency. The source frequency (RF) is automatically set by the instrument and equals  $IF + LO$ .

- **The receiver frequency (IF)** is the CW or start and stop frequencies chosen by the operator. These are entered in the normal way using the **[CW FREQ]** softkey or **[START]** and **[STOP]** keys. It is very important to understand that the stimulus values only affect the receiver (IF). The CRT always displays IF frequencies.
- **The offset frequency (LO)** is the difference between the source and receiver frequencies.

**NOTE:** The HP 8753B source locks to the  $IF + LO$  frequency, regardless of the selected offset value. Once the source is phase locked and sweeping, the HP 8753B source frequency is not known precisely. As the LO frequency changes, the source tracks it to maintain the requested IF frequency (the receiver start/stop or CW frequency).

**Frequency Hierarchy.** The source frequency must be greater than the LO frequency, and both source and LO frequencies must be greater than the receiver frequency. This means that the frequency offset mode can only measure the lower of the two IF mixing products (lower sideband).

**Example:**

| <b>Right</b><br>(lower sideband)  | <b>Wrong</b><br>(upper sideband)  |
|-----------------------------------|-----------------------------------|
| Source frequency (RF) = 3 GHz     | Source frequency (RF) = 3 GHz     |
| Offset frequency (LO) = 2.5 GHz   | Offset frequency (LO) = 0.5 GHz   |
| Receiver frequency (IF) = 0.5 GHz | Receiver frequency (IF) = 2.5 GHz |

**Frequency Ranges.** Receiver (IF) frequency range = 300 KHz to 2.984 GHz.  
Minimum recommended offset (LO) frequency = 16 MHz.

The receiver frequency plus the offset frequency cannot exceed 3 GHz. (This is because the source must be able to supply the sum of the receiver frequency plus the offset frequency.) If the operator enters IF and LO frequencies that would require >3 GHz from the source, the HP 8753B automatically limits the requested IF frequency.

**Compatible Instrument Modes and Sweep Types.** Frequency offset is compatible with all sweep types in network analyzer mode.

**Receiver and Source Requirements.** Refer to the specifications table located in the *General Information and Specifications* section of this manual.

IF Input: A, B, or R

**CRT Annotations.** The annotation "ofs" is displayed when the frequency offset mode is on. The annotation "of?" indicates that the source frequency is approximately  $\geq 10$  MHz away from the sum of the requested IF and LO frequencies. This is most likely caused by the LO frequency being outside the  $-1$  to  $+5$  MHz accuracy requirement.

**Error Message.** If the operator connects a DUT before turning on the frequency offset function, the error message "PHASE LOCK CAL FAILED" will appear on the screen. This is normal, and will go away when the **[FREQ OFFS on OFF]** softkey is pressed.

**Spurious Signal Passband Frequencies.** Because of the characteristics of a sampler, unwanted mixing products (or spurious LO signals) at specific frequencies can cause measurement inaccuracy. These specific frequencies can be calculated. Refer to *Spurious Signal Passbands In External Source Mode, Tuned Receiver Mode, and Frequency Offset Operation*, at the end of this chapter. A low pass filter on the DUT's IF output can reduce unwanted mixing products going to the sampler.

## Using Frequency Offset Mode

Activate frequency offset mode using the following sequence:

1. Press **[FREQ OFFS on OFF]** to turn on the frequency offset mode.
2. Connect the DUT and set the external LO source to the desired frequency and power level.
3. Set the receiver (IF) frequencies using the **[CW FREQ]** softkey or **[START]** and **[STOP]** keys. Set the output power of the RF source and select the input (R, A, or B).
4. Set the offset (nominally the LO frequency) using the **[OFFSET VALUE]** softkey.

**Example Measurement.** The following example measures conversion loss in a typical mixer application. The frequencies to be used in this measurement are:

RF = 1400 MHz (automatically set by the HP 8753B)  
LO = 800 MHz (entered by the operator using the **[OFFSET VALUE]** softkey)  
IF = 600 MHz (entered by the operator using the stimulus keys)

Remember that during frequency offset measurements the HP 8753B displays IF frequencies on the CRT.

1. Press **[PRESET]** on the front panels of the HP 8753B and local oscillator (LO) source.
2. Press **[FREQ OFFS on OFF]** to activate the frequency offset mode. Connect the equipment as shown in Figure 14-5.

**NOTE:** If you connect the DUT before turning on frequency offset, the error message "PHASE LOCK CAL FAILED" may be displayed. This is normal, and will go away when frequency offset mode is turned on.

3. Set the LO signal generator to a CW frequency of 800 MHz at +13 dBm.
4. From the front panel of the HP 8753B, set the IF frequency and RF source output power. Select the R input.

**[MENU]**  
**[CW FREQ] [6] [0] [0] [M/u]**  
**[POWER] [6] [x1]**  
**[MEAS] [R]**

5. Enter the LO (offset) frequency.

**[SYSTEM] [INSTRUMENT MODE]**  
**[OFFSET VALUE] [8] [0] [0] [M/U]**

6. Figure 14-6 shows the attenuated output power of the mixer's IF at the receiver. The conversion loss of the mixer is found by subtracting the attenuation from the total loss between the RF source and IF receiver.

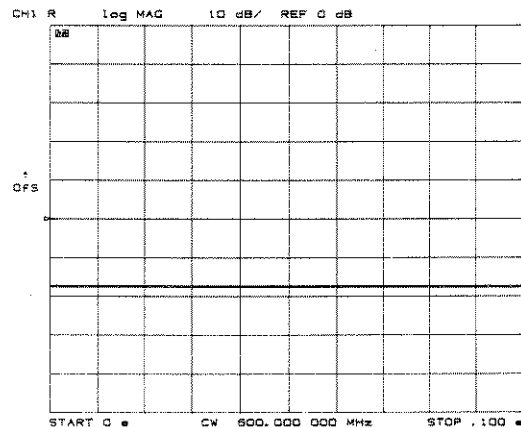

Figure 14-6. Mixer Output

|                   |   |           |
|-------------------|---|-----------|
| Source power      | = | 6 dBm     |
| Output power      | = | -17.5 dBm |
| Total loss        | = | 23.5 dB   |
| Total attenuation | = | 16 dB     |
| Conversion loss   | = | 7.5 dB    |

Refer to application note 8753-2, *RF Component Measurements – Mixer Measurements using the HP 8753B network analyzer* (HP part number 5956-4362), for more information and examples of mixer measurements.

## 6 GHz OPERATION (OPTION 006)

6 GHz operation is activated by the **[FREQ RANGE 3GHz6GHz]** softkey. The frequency range softkey appears only on an HP 8753B equipped with option 006, and then only when it is connected to an HP 85047A 6 GHz test set. The softkey appears in two instances:

- On the screen after power-on or instrument preset.
- Under the system menu as shown in Figure 14-1.

**[FREQ RANGE 3GHz6GHz]** (FREQRANG3GHZ, FREQRANGE6GHZ) toggles between two frequency ranges:

- 300 kHz to 3 GHz
- 3 MHz to 6 GHz

The current maximum frequency is highlighted in the softkey title. For example, when 300 kHz to 3 GHz is selected, the **[3GHz]** portion of the softkey title will be highlighted, while the **[6GHz]** portion will appear dim.

## Compatible Instrument Modes

6 GHz operation works in all instrument modes: network analyzer, external source, and tuned receiver.



## Activating 6 GHz Operation

In network analyzer mode, 6 GHz operation must be turned on directly with the **[FREQ RANGE 3GHz6GHz]** softkey, or by HP-IB command. It can not be activated by simply selecting frequencies above 3 GHz. If this is attempted, the message "3GHz MAX FREQ. USE FREQ RANGE KEY (UNDER SYSTEM)" will be displayed. This stipulation also applies to using frequencies above 3 GHz during frequency offset operation.

When activated, the power output of the internal source will automatically change to +20 dBm. Start and Stop frequencies change to 3 MHz and 6 GHz respectively. The reason the power level changes is explained under *RF Power Requirements*, below. When the operator changes the HP 8753B back to the 3 GHz mode, power changes to 0 dBm and Start/Stop frequencies change to 300 kHz and 3 GHz respectively. In addition, the sweep type changes to linear sweep.

When using an HP 8753B option 006 in external source mode, tuned receiver mode, or harmonic operation, frequencies above 3 GHz can be measured without turning on 6 GHz operation.

When 6 GHz mode is on, the status annotation "x2" is displayed on the CRT.

## Doubler Switch Protection (Only Applies to the HP 85047A)

The HP 85047A S-parameter test set uses a frequency doubler to switch between 3 and 6 GHz operation. Because the doubler uses a mechanical switch, operations that would require repetitive switching between the two modes are not permitted. For this reason, 6 GHz mode is either on or off for both channels. There is no override for this protection feature.

## RF Power Requirements

The doubler requires high, fixed power (+20 dBm). When the operator selects 6 GHz operation, the HP 8753B RF power output automatically changes to +20 dBm and the message "SOURCE FREQUENCIES AND POWER CHANGED" is displayed. If the operator then changes the source power, a warning message appears, and the status annotation changes from "x2" to "x2?"

**Receiver-Only Use of the HP 8753B Option 006.** Three modes allow the HP 8753B option 006 receiver to measure up to 6 GHz without an HP 85047A test set. Each mode can measure signals up to 6 GHz without activating the 6 GHz mode. (In fact, without the HP 85047A test set, the HP 8753B will not display the **[FREQ RANGE 3GHz6GHz]** softkey.)

**Receiver-Only use in External Source and Tuned Receiver modes.** The external source or tuned receiver modes allow the HP 8753B to measure frequencies up to 6 GHz without an HP 85047A test set. However, an external source and signal separation device must be supplied. Refer to *External Source Mode* or *Tuned Receiver Mode* descriptions in this chapter.

**Receiver-Only use in Harmonic Mode (option 002).** With option 002, harmonic operation, the fundamental frequency can not exceed 3 GHz. However, harmonic frequencies up to 6 GHz can be measured without activating 6 GHz operation. Receiver-only use is limited to simple transmission measurements. The HP 85047A test set is required for reflection measurements because its couplers can operate to 6 GHz. If using the 6 GHz test set, it should be left in the 3 GHz mode. Refer to *Harmonic Operation (Option 002 Only)* on the next page.

The second harmonic of fundamental frequencies up to 3 GHz can be measured, as well as the third harmonic of fundamental frequencies up to 2 GHz.

## HARMONIC OPERATION (OPTION 002 ONLY)

The harmonic measurement mode measures the second or third harmonic as the HP 8753B source sweeps fundamental frequencies above 16 MHz.

### Typical Test Setup

Figure 14-7 shows a typical test setup using the HP 85047A 6 GHz test set.

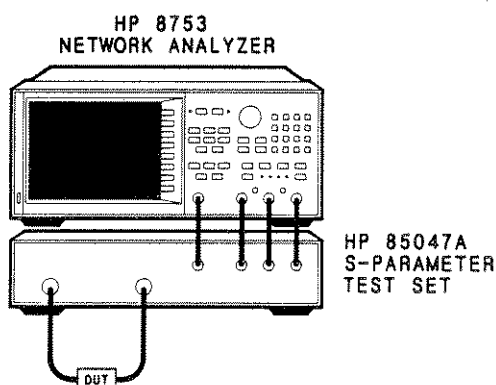

Figure 14-7. Typical Harmonic Mode Test Setup

### When an HP 85047A Test Set Is Required

For measuring harmonic responses above 3 GHz, the HP 85047A 6 GHz test set is required for reflection measurements since its couplers work above 3 GHz. A test set is not required for a simple transmission measurement. This is because the selected frequency is the fundamental, which never exceeds 3 GHz. If using an HP 8753B option 006 with an HP 85047A test set, keep the HP 8753B in the 300 kHz to 3 GHz range.

Harmonic measurements may be made in any sweep type.

### Single-Channel Operation

The second or third harmonic can be displayed alone using channel 1 or 2.

### Dual-Channel Operation

To make the following types of measurements, channels 1 and 2 must be uncoupled, and dual channel must be turned on.

- The fundamental can be displayed on one channel while the second or third harmonic is displayed on the other channel.
- The second harmonic can be displayed on one channel while the third harmonic is displayed on the other.

- The **[D2/D1 toD2]** softkey allows the fundamental to be measured on channel 1 while the second or third harmonic is measured in dBc on channel 2.
- The **[COUPLE PWR ON off]** softkey couples power between channels 1 and 2. This is useful when using the D2/D1 to D2 feature; the user can change fundamental power and see the resultant change in the harmonic power.

The display (stimulus annotation and marker stimulus) will display the fundamental frequency. However, a marker in the active entry area will show the harmonic frequency in addition to the fundamental. If the harmonic mode is used, the annotation "H=2" or "H=3" will appear on the left-hand side of the display. The measured harmonic cannot not exceed the frequency limitations of the network analyzer's receiver.

## Coupling Power Between Channels 1 and 2

**[COUPLE PWR ON off]** is intended for use with the **[D2/D1 toD2 on OFF]** softkey. The D2/D1 to D2 function is used in harmonic measurements, where the fundamental is displayed on channel 1 and the harmonic on channel 2. D2/D1 to D2 ratios the two, displaying the fundamental and the relative power of the measured harmonic in dBc. For these measurements, channels 1 and 2 must be uncoupled with the **[COUPLED CHAN ON off]** softkey set to OFF to allow alternating sweeps.

After uncoupling channels 1 and 2, you may wish to change the fundamental power and see the resultant change in relative harmonic power (in dBc). **[COUPLE PWR ON off]** allows the operator to change the power of both channels simultaneously, even though they are uncoupled in all other respects.

## Frequency Range

The frequency range is determined by the upper frequency range of the instrument or system (3 or 6 GHz) and by the harmonic being displayed. 6 GHz operation requires an HP 8753B option 006. The following table shows the highest fundamental frequency for maximum frequency and harmonic mode.

|              | Maximum Frequency |                    |
|--------------|-------------------|--------------------|
|              | 3 GHz             | 6 GHz (Option 006) |
| 2nd Harmonic | 1.5 GHz           | 3 GHz              |
| 3rd Harmonic | 1.0 GHz           | 2.0 GHz            |

**Example:** A standard HP 8753B has a maximum frequency range of 3 GHz. If the second harmonic is being measured, the highest fundamental frequency allowed is 1.5 GHz.

## Accuracy and Input Power

Refer to the specifications table located in the *General information and specifications* section of this manual. Related specifications are the maximum recommended input power and maximum recommended source power.

Using power levels greater than the recommended values causes undesired harmonics in the source and receiver. The recommended power levels ensure that these harmonics are less than 45 dBc. Use port attenuation in an S-parameter test set to limit the input power to the DUT.

## Harmonic Measurement Menu

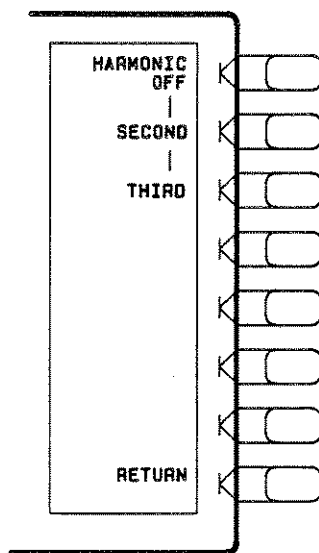

Figure 14-8. Harmonic Measurement Menu

**[HARMONIC OFF]** (HARMOFF) turns off the harmonic measurement mode.

**[SECOND]** (HARMSEC) selects measurement of the second harmonic.

**[THIRD]** (HARMTHIR) selects measurement of the third harmonic.

**[RETURN]** goes back to the system menu.

Getting to the **[D2/D1 toD2]** or **[COUPLE PWR ON off]** Softkeys.

- Press **[DISPLAY] [MORE] [MORE]** to access the **[D2/D1 toD2]** softkey.
- Press **[MENU] [POWER]** to access the **[COUPLE PWR ON off]** softkey.

## **SPURIOUS SIGNAL PASSBANDS IN EXTERNAL SOURCE MODE, TUNED RECEIVER MODE, AND FREQUENCY OFFSET OPERATION**

The external source mode, tuned receiver mode, and frequency offset feature respond to spurious signals at certain passband frequencies. A signal at any of these frequencies affects the accuracy of the measurement. Filters can be used to reduce the effect of spurious signals at passband frequencies. Refer to the following information to calculate the passband frequencies.

### **Calculating the Spurious Signal Passband at RF Frequencies Below 16 MHz**

Below 16 MHz, spurious signals in a single frequency range will affect the accuracy of measurements. This frequency range is centered around the selected RF frequency, and is the width of the selected IF bandwidth.

$$\text{Spurious signal Passband} = \text{RF} \pm 0.5 \times \text{IF Bandwidth}$$

For example: A 10 MHz signal is measured with an IF bandwidth of 1 kHz. The spurious signal passband = 10 MHz  $\pm$  500 Hz

### **Calculating Susceptible Spurious Signal Frequencies at RF Frequencies Above 16 MHz**

Above 16 GHz, there are a series of frequencies at which spurious signals will affect the accuracy of the measurement. The following information explains how to calculate these frequencies.

The variables in this calculation are:

n = numbers 1 through 300.

FN = fractional-N frequency (calculate as explained later)

The basic formula is:

$$\text{Spurious Signal frequencies} = (n \times \text{FN}) + 1 \text{ MHz}$$

The calculation must be repeated with n values from 1 to 300. This will provide the frequency of all significant spurious passbands.

**Calculating FN.** FN is dependent upon RF frequency, the Mth harmonic number, and the IF frequency. The formula is:

$$\text{FN} = \frac{\text{RF} - \text{IF}}{\text{Mth Harmonic}}$$

Convenient lookup tables are provided so the operator may easily find IF and Mth harmonic values.

Three lookup tables are provided because the values of IF and Mth harmonic depend on if the harmonics operation (option 002) mode is turned on. The three tables are:

- Table 14-1, Harmonics Mode Off
- Table 14-2, Harmonics Mode On, Second Harmonic Selected (option 002 only)
- Table 14-3, Harmonics Mode On, Third Harmonic Selected (option 002 only)

**Using a table.** The following are instructions for using the FN lookup tables.

1. Choose the proper table given non-harmonic, second harmonic, or third harmonic mode.
2. Find the appropriate RF frequency row.
3. Look in the IF and Mth harmonic columns for the applicable values.

### Example Passband Calculation for a CW Frequency Above 16 MHz

In this example, harmonics mode is off and the RF frequency is 62 MHz. Table 14-1 indicates an IF value of 1 MHz and an Mth harmonic value of 2.

$$FN = \frac{RF - IF}{\text{Mth Harmonic}}$$

$$\frac{62 \text{ MHz} - 1 \text{ MHz}}{2} = 30.5 \text{ MHz}$$

Now using the formula for determining spurious passbands:

$$\text{Passband Frequencies} = (n \times FN) + 1 \text{ MHz}$$

(where n = 1 to 300)

$$(1 \times 30.5 \text{ MHz}) + 1 \text{ MHz} = 31.5 \text{ MHz}$$

$$(2 \times 30.5 \text{ MHz}) + 1 \text{ MHz} = 62 \text{ MHz}$$

$$(3 \times 30.5 \text{ MHz}) + 1 \text{ MHz} = 92.5 \text{ MHz}$$

and so on...

*Table 14-1. IF and Mth Harmonic Values with Harmonic Mode Off  
(Or if Option 002, Harmonic Operation, is Not Installed)*

| RF (MHz)       | Mth Harmonic | IF (MHz) |
|----------------|--------------|----------|
| ≥16 to <61     | 1            | 1        |
| ≥61 to <121    | 2            | 1        |
| ≥121 to <178   | 3            | 1        |
| ≥178 to <296   | 5            | 1        |
| ≥296 to <536   | 9            | 1        |
| ≥536 to <893   | 15           | 1        |
| ≥893 to <1607  | 27           | 1        |
| ≥1607 to <3060 | 51           | 1        |
| ≥3060 to 6000  | 101          | 1        |

**Table 14-2. IF and Mth Harmonic Values with Harmonic Mode On, Second Harmonic Selected**

| <b>RF<br/>(MHz)</b>  | <b>Mth<br/>Harmonic</b> | <b>IF<br/>(MHz)</b> |
|----------------------|-------------------------|---------------------|
| ≥ 15.5 to < 60.5     | 1                       | 0.5                 |
| ≥ 60.5 to < 120.5    | 2                       | 0.5                 |
| ≥ 120.5 to < 177.5   | 3                       | 0.5                 |
| ≥ 177.5 to < 295.5   | 5                       | 0.5                 |
| ≥ 295.5 to < 535.5   | 9                       | 0.5                 |
| ≥ 535.5 to < 892.5   | 15                      | 0.5                 |
| ≥ 892.5 to < 1606.5  | 27                      | 0.5                 |
| ≥ 1606.5 to < 3059.5 | 51                      | 0.5                 |
| ≥ 3059.5 to 6000     | 101                     | 0.5                 |

**Table 14-3. IF and Mth Harmonic Values with Harmonic Mode On, Third Harmonic Selected**

| <b>RF<br/>(MHz)</b>      | <b>Mth<br/>Harmonic</b> | <b>IF<br/>(MHz)</b> |
|--------------------------|-------------------------|---------------------|
| ≥ 15.333 to < 60.333     | 1                       | 0.333               |
| ≥ 60.333 to < 120.333    | 2                       | 0.333               |
| ≥ 120.333 to < 177.333   | 3                       | 0.333               |
| ≥ 177.333 to < 295.333   | 5                       | 0.333               |
| ≥ 295.333 to < 535.333   | 9                       | 0.333               |
| ≥ 535.333 to < 892.333   | 15                      | 0.333               |
| ≥ 892.333 to < 1606.333  | 27                      | 0.333               |
| ≥ 1606.333 to < 3059.333 | 51                      | 0.333               |
| ≥ 3059.333 to 6000       | 101                     | 0.333               |





## PRESET STATE

When the [PRESET] key is pressed, the HP 8753B reverts to a known state. This state is defined in Table A-1, below. There are subtle differences between the preset state and the power-up state. These differences are documented in Table A-2. If power to non-volatile memory is lost, the HP 8753B will have certain parameters set to default settings. Table A-3 shows the affected parameters.

When line power is cycled, or the [PRESET] key pressed, the HP 8753B performs a self-test routine. Upon successful completion of that routine, the instrument state is set to the following preset conditions. The same conditions are true following a "PRES;" or "RST;" command over HP-IB, although the self-test routines are not executed.

*Table A-1. Preset Conditions (1 of 2)*

| Operating Parameter                   | Preset Value                      | Operating Parameter | Preset Value                                                                                              |
|---------------------------------------|-----------------------------------|---------------------|-----------------------------------------------------------------------------------------------------------|
| <b>Analyzer Mode</b>                  |                                   | CONVERSION          | off                                                                                                       |
| ANALYZER MODE                         | Network Analyzer Mode             | FORMAT              | log magnitude (all inputs)                                                                                |
| FREQUENCY OFFSET OPERATION            | off                               | DISPLAY             | data                                                                                                      |
| OFFSET VALUE                          | 0                                 | DUAL CHANNEL        | off                                                                                                       |
| HARMONIC OPERATION                    | off                               | ACTIVE CHANNEL      | channel 1                                                                                                 |
| 3 GHz/6 GHz OPERATION                 | 3 GHz                             | FREQUENCY BLANK     | disabled                                                                                                  |
| <b>Stimulus Conditions</b>            |                                   | SPLIT DISPLAY       | on                                                                                                        |
| SWEEP TYPE                            | linear frequency                  | INTENSITY           | If set to $\geq 15\%$ , [PRESET] has no effect. If set to $< 15\%$ , [PRESET] increases intensity to 15%. |
| DISPLAY MODE                          | start/stop                        | BEEPER: DONE        | on                                                                                                        |
| TRIGGER TYPE                          | continuous                        | BEEPER: WARNING     | off                                                                                                       |
| EXTERNAL TRIGGER                      | off                               | D2/D1 TO D2         | off                                                                                                       |
| SWEEP TIME                            | 100 milliseconds, manual mode     | TITLE               | channel 1 = [hp]<br>channel 2 = empty                                                                     |
| START FREQUENCY                       | .300 MHz                          | NUMBER OF POINTS    | 201                                                                                                       |
| FREQUENCY SPAN                        | 2999.7 MHz                        | IF BANDWIDTH        | 3000 Hz                                                                                                   |
| START TIME                            | 0                                 | IF AVERAGING FACTOR | 16; off                                                                                                   |
| TIME SPAN                             | 100 milliseconds                  | SMOOTHING APERTURE  | 1% SPAN; off                                                                                              |
| CW FREQUENCY                          | 1000 MHz                          | PHASE OFFSET        | 0 degrees                                                                                                 |
| SOURCE POWER                          | 0 dBm                             | ELECTRICAL DELAY    | 0 seconds (all parameters)                                                                                |
| POWER SLOPE                           | 0 dB/GHz; off                     | <b>Calibration</b>  |                                                                                                           |
| START POWER                           | -5.0 dBm                          | CORRECTION          | off                                                                                                       |
| POWER SPAN                            | 5 dB                              | CALIBRATION TYPE    | none                                                                                                      |
| COUPLED POWER                         | on                                | CALIBRATION KIT     | 7 millimeter                                                                                              |
| POWER TRIP                            | off                               | SYSTEM Z0           | 50 ohms                                                                                                   |
| COUPLED CHANNELS                      | on                                | VELOCITY FACTOR     | 1                                                                                                         |
| <b>Frequency List</b>                 |                                   | EXTENSIONS          | off                                                                                                       |
| FREQUENCY LIST                        | empty                             | PORT 1              | 0                                                                                                         |
| EDIT MODE                             | start/stop, number of points      | PORT 2              | 0                                                                                                         |
| <b>Response Conditions</b>            |                                   | INPUT A             | 0                                                                                                         |
| PARAMETER (with S-parameter test set) | channel 1: S11;<br>channel 2: S21 | INPUT B             | 0                                                                                                         |
| (without S-parameter test set)        | channel 1: A/R;<br>channel 2: B/R |                     |                                                                                                           |

Table A-1. Preset Conditions (2 of 2)

| Operating Parameter                  | Preset Value           | Operating Parameter                         | Preset Value   |                  |              |                      |
|--------------------------------------|------------------------|---------------------------------------------|----------------|------------------|--------------|----------------------|
| <b>Calibration (Cont'd)</b>          |                        | <b>External Memory Array (Define Store)</b> |                |                  |              |                      |
| ALTERNATE A and B                    | on                     | DATA                                        | off            |                  |              |                      |
| POWER METER CALIBRATION <sup>1</sup> | off                    | RAW DATA                                    | off            |                  |              |                      |
| NUMBER OF READINGS                   | 1                      | FORMATTED DATA                              | off            |                  |              |                      |
| POWER LOSS CORRECTION                | off                    | GRAPHICS                                    | off            |                  |              |                      |
| SENSOR A/B                           | A                      | DATA ONLY                                   | off            |                  |              |                      |
| INTERPOLATED ERROR CORRECTION        | off                    | DIRECTORY SIZE                              | 256 files      |                  |              |                      |
| <b>Markers (coupled)</b>             |                        | <b>Sequencing<sup>2</sup></b>               |                |                  |              |                      |
| MARKERS 1,2,3,4                      | 1 GHz; all markers off | LOOP COUNTER                                | 0              |                  |              |                      |
| LAST ACTIVE MARKER                   | 1                      | TTL OUT                                     | high           |                  |              |                      |
| REFERENCE MARKER                     | none                   | <b>Service Modes</b>                        |                |                  |              |                      |
| MARKER MODE                          | continuous             | HP-IB DIAGNOSTIC                            | off            |                  |              |                      |
| DELTA MARKER MODE                    | off                    | SOURCE PHASE LOCK LOOP                      | on             |                  |              |                      |
| COUPLING                             | on                     | SAMPLER CORRECTION                          | on             |                  |              |                      |
| MARKER SEARCH                        | off                    | SPUR AVOIDANCE                              | on             |                  |              |                      |
| MARKER TARGET VALUE                  | -3 dB                  | AUX INPUT RESOLUTION                        | high           |                  |              |                      |
| MARKER WIDTH VALUE                   | -3 dB; off             | ANALOG BUS NODE                             | 11 (aux input) |                  |              |                      |
| MARKER TRACKING                      | off                    | <b>Plot</b>                                 |                |                  |              |                      |
| MARKER STIMULUS OFFSET               | 0                      | PLOT DATA                                   | on             |                  |              |                      |
| MARKER VALUE OFFSET                  | 0                      | PLOT MEMORY                                 | on             |                  |              |                      |
| MARKER AUX OFFSET (PHASE)            | 0 degrees              | PLOT GRATICULE                              | on             |                  |              |                      |
| MARKER STATISTICS                    | off                    | PLOT TEXT                                   | on             |                  |              |                      |
| POLAR MARKER                         | LIN MKR                | PLOT MARKER                                 | on             |                  |              |                      |
| SMITH MARKER                         | R + jX                 | PLOT QUADRANT                               | FULL PAGE      |                  |              |                      |
| <b>Limit Lines</b>                   |                        | SCALE PLOT                                  | FULL           |                  |              |                      |
| LIMIT LINES                          | off                    | PLOT SPEED                                  | FAST           |                  |              |                      |
| LIMIT TESTING                        | off                    |                                             |                |                  |              |                      |
| LIMIT LIST                           | empty                  | <b>Plot (Cont'd)</b>                        |                |                  |              |                      |
| EDIT MODE                            | upper/lower limits     | PEN NUMBER:                                 |                |                  |              |                      |
| STIMULUS OFFSET                      | 0 Hz                   | Data                                        | Channel 1      | Channel 2        |              |                      |
| AMPLITUDE OFFSET                     | 0                      | Memory                                      | 1              | 2                |              |                      |
| LIMIT TYPE                           | sloping line           | Graticule                                   | 1              | 2                |              |                      |
| BEEP FAIL                            | off                    | Text                                        | 3              | 4                |              |                      |
| <b>Time Domain</b>                   |                        | Text                                        | 1              | 2                |              |                      |
| TRANSFORM                            | off                    | Marker                                      | 5              | 6                |              |                      |
| TRANSFORM TYPE                       | bandpass               | LINE TYPE                                   |                |                  |              |                      |
| START TRANSFORM                      | -20 nanoseconds        | Data, Memory                                | 7              | 7                |              |                      |
| TRANSFORM SPAN                       | 40 nanoseconds         |                                             |                |                  |              |                      |
| GATING                               | off                    |                                             |                |                  |              |                      |
| GATE SHAPE                           | normal                 |                                             |                |                  |              |                      |
| GATE START                           | -10 nanoseconds        |                                             |                |                  |              |                      |
| GATE SPAN                            | 20 nanoseconds         |                                             |                |                  |              |                      |
| DEMODULATION                         | off                    |                                             |                |                  |              |                      |
| WINDOW                               | normal                 |                                             |                |                  |              |                      |
| USE MEMORY                           | off                    |                                             |                |                  |              |                      |
| <b>System Parameters</b>             |                        |                                             |                |                  |              |                      |
| HP-IB ADDRESSES                      | last active state      |                                             |                |                  |              |                      |
| HP-IB MODE                           | last active state      |                                             |                |                  |              |                      |
| INTENSITY and FOCUS                  | last active state      |                                             |                |                  |              |                      |
| <b>Test Set Attenuation</b>          |                        |                                             |                |                  |              |                      |
| PORT 1                               | 0                      |                                             |                |                  |              |                      |
| PORT 2                               | 0                      |                                             |                |                  |              |                      |
|                                      |                        | <b>Format Table</b>                         | <b>Scale</b>   | <b>Reference</b> |              | <b>Marker Offset</b> |
|                                      |                        |                                             |                | <b>Position</b>  | <b>Value</b> |                      |
|                                      |                        | LOG MAGNITUDE (dB)                          | 10.0           | 5.0              | 0.0          | 0.0                  |
|                                      |                        | PHASE (degree)                              | 90.0           | 5.0              | 0.0          | 0.0                  |
|                                      |                        | GROUP DELAY (ns)                            | 10.0           | 5.0              | 0.0          | 0.0                  |
|                                      |                        | SMITH CHART                                 | 1.00           | -                | 1.0          | 0.0                  |
|                                      |                        | POLAR                                       | 1.00           | -                | 1.0          | 0.0                  |
|                                      |                        | LINEAR MAGNITUDE                            | 0.1            | 0.0              | 0.0          | 0.0                  |
|                                      |                        | REAL                                        | 0.2            | 5.0              | 0.0          | 0.0                  |
|                                      |                        | IMAGINARY                                   | 0.2            | 5.0              | 0.0          | 0.0                  |
|                                      |                        | SWR                                         | 1.00           | 0.0              | 1.0          | 0.0                  |

1. The power sensor calibration data and power loss tables are not affected by preset or by cycling line power.

2. Pressing preset turns off sequencing modify (edit) mode and stops any running sequence.

*Table A-2. Power-on Conditions (versus Preset)*

HP-IB MODE: Talker/listener.

SAVE REGISTERS: Memory, error correction data, and power meter calibration data in save registers are cleared.

TEST SET: The HP 8753B checks for presence of HP 85046A/B or 85047A.

INTENSITY and FOCUS: These values are set to factory encoded values. The factory values can be changed by running the appropriate service routine. Refer to the Troubleshooting Reference section of the service manual.

SEQUENCES: Sequence 1 through 5 are erased.

*Table A-3. Results of Power Loss to Non-Volatile Memory*

HP-IB ADDRESSES are set to the following defaults:

|                          |    |
|--------------------------|----|
| HP 8753B .....           | 16 |
| USER DISPLAY .....       | 17 |
| PLOTTER .....            | 5  |
| PRINTER .....            | 1  |
| POWER METER .....        | 13 |
| DISC .....               | 0  |
| DISC UNIT NUMBER .....   | 0  |
| DISC VOLUME NUMBER ..... | 0  |

POWER METER TYPE is set to HP 438/437A

INTERNAL REGISTER TITLES are set to defaults: REG1 through REG5.

EXTERNAL REGISTER TITLES (store files) are set to defaults: FILE1 through FILE 5.

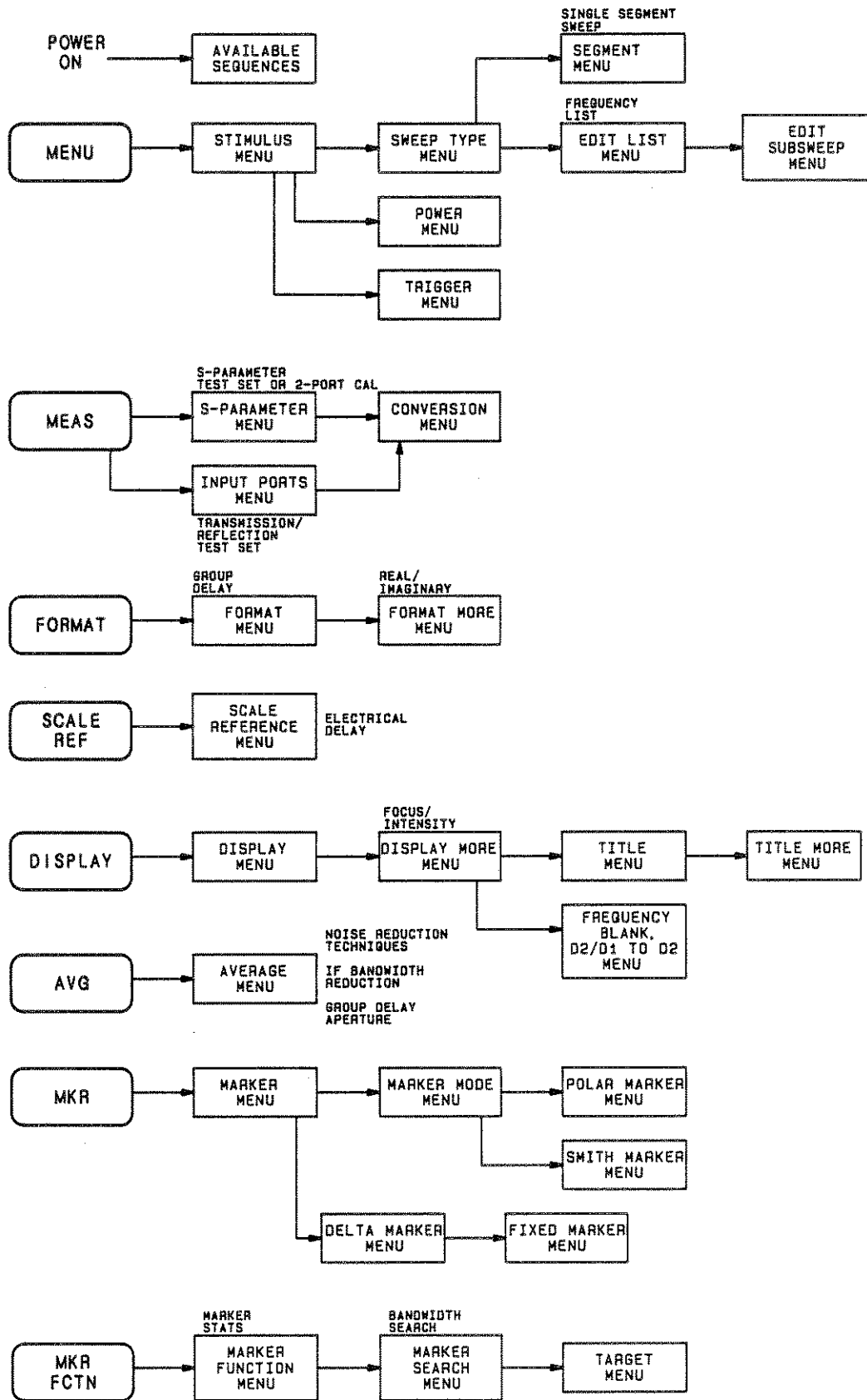

Figure A-1. Operating Softkey Menu Map (1 of 4)

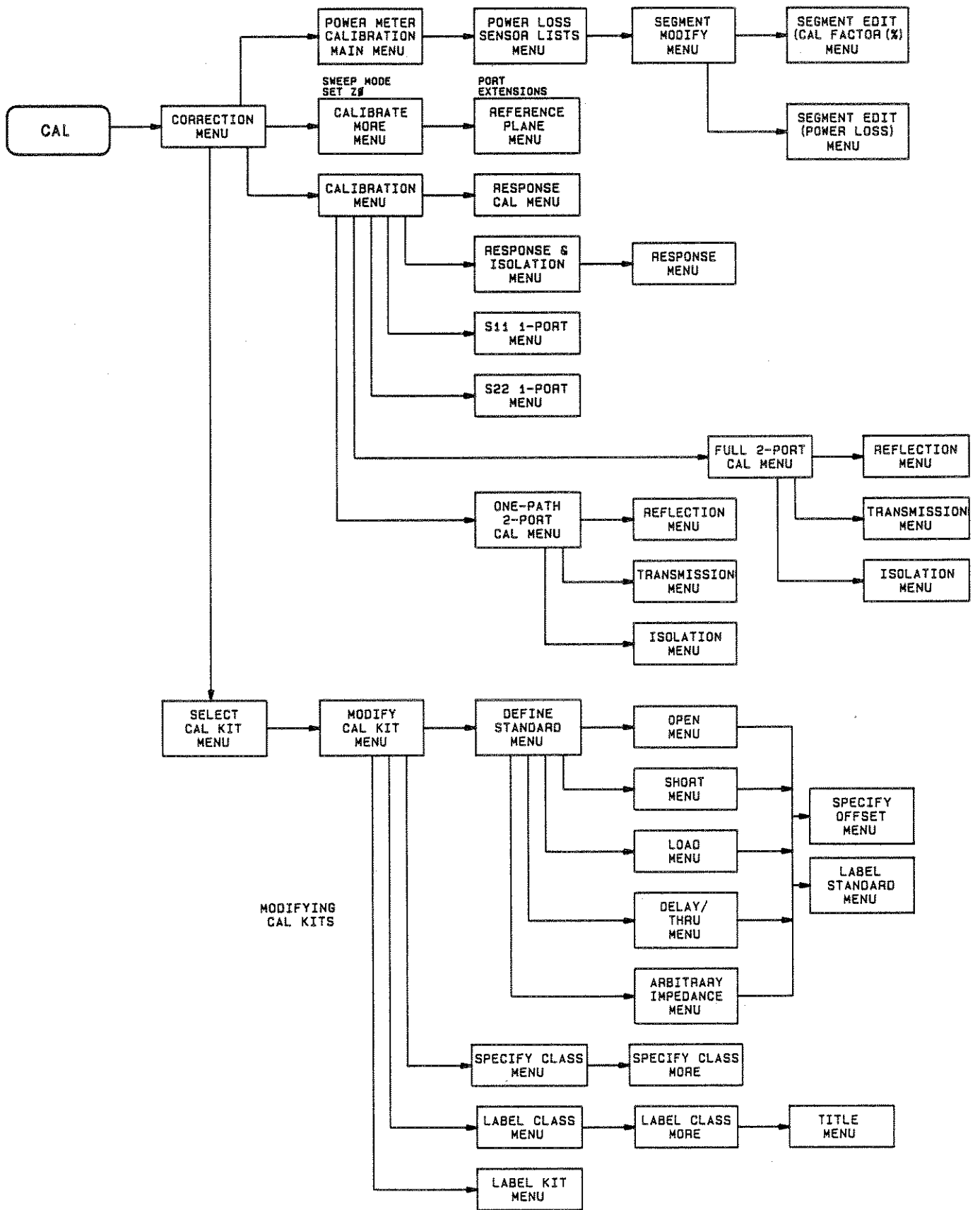

Figure A-1. Operating Softkey Menu Map (2 of 4)

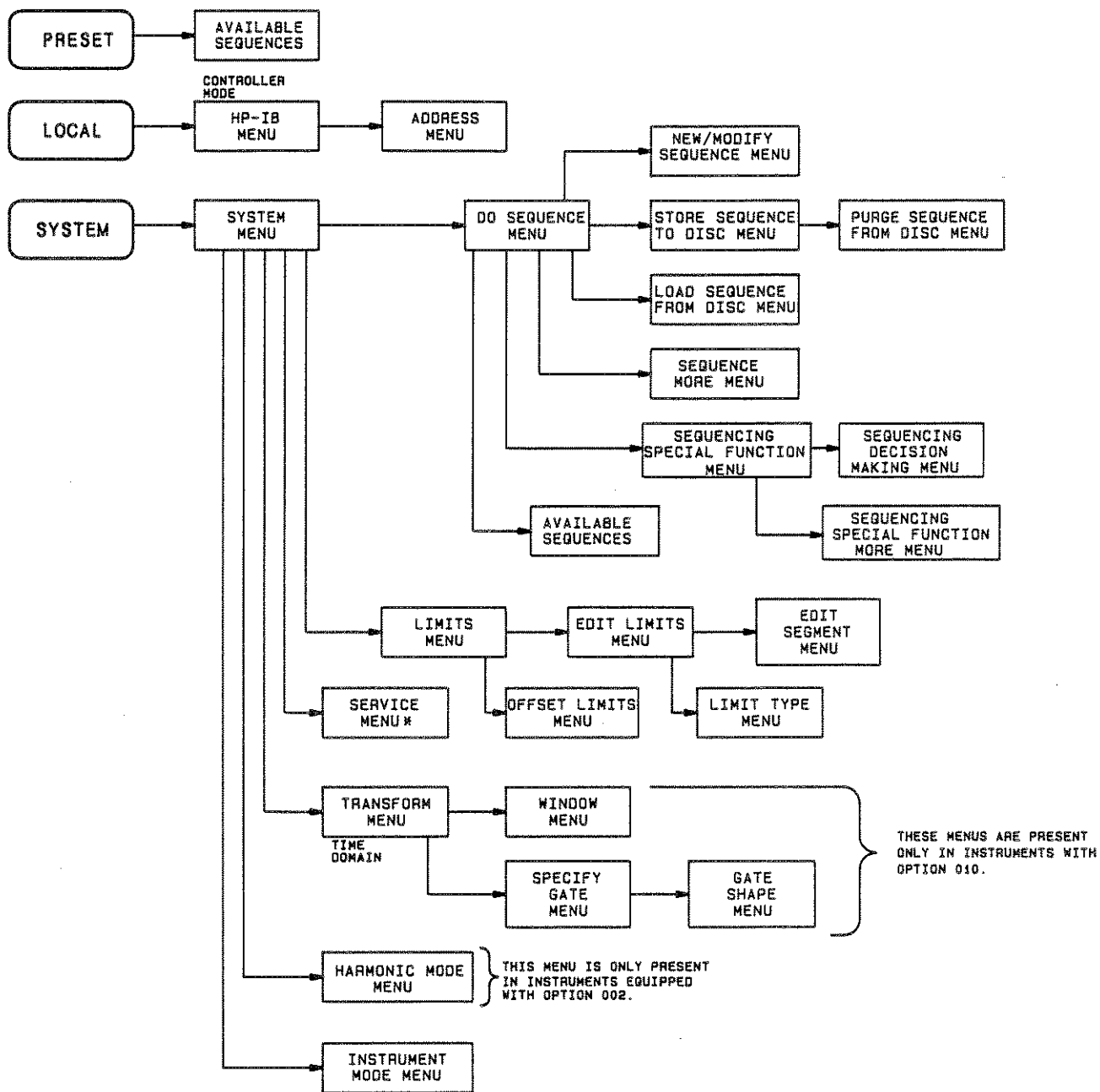
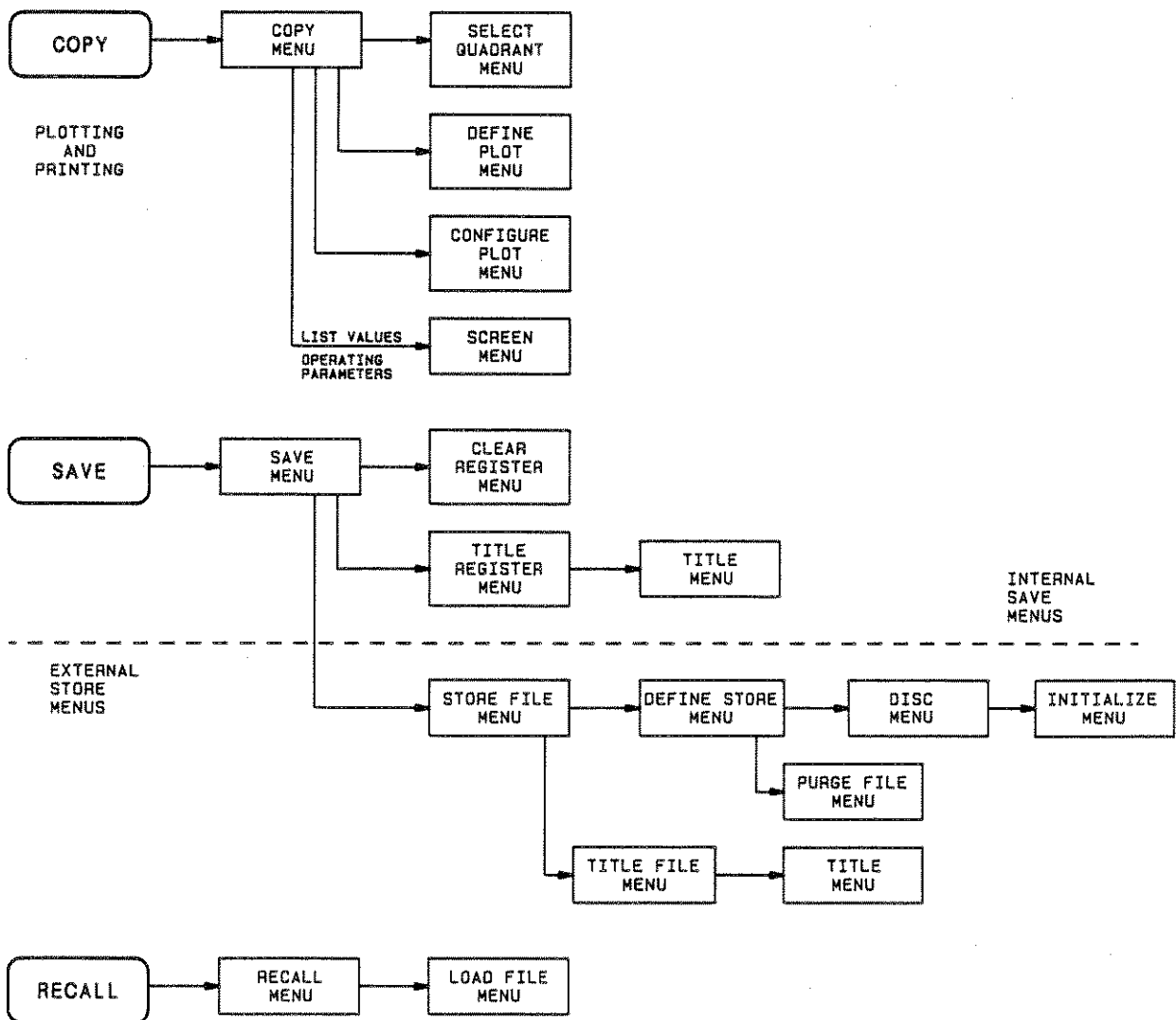

Figure A-1. Operating Sofitkey Menu Map (3 of 4)



\* THE SERVICE MENU SERIES IS ILLUSTRATED AND DESCRIBED IN THE ON-SITE SYSTEM SERVICE MANUAL.

Figure A-1. Operating Softkey Menu Map (4 of 4)





# HP 8753B System Operating and Programming Manual

## INDEX

|                                   |                      |                                 |                         |                                              |                          |
|-----------------------------------|----------------------|---------------------------------|-------------------------|----------------------------------------------|--------------------------|
| [ ] Brackets                      | OPR 2-1              | Attenuator Switch Protection    | OPR 3-2                 | Calibration Menu                             | OPR 5-18                 |
| [ ] Brackets                      | OPR 2-1              | [AUTO SCALE] Key                | OPR 4-16                | Calibration, Power Meter                     | OPR 5-28                 |
| ▽ Active Marker                   | OPR 6-4              | Autostarting Sequences          | OPR 13-16               | Calibration Procedures                       |                          |
| Δ Delta Marker                    | OPR 6-5              | Auto Sweep Time                 | OPR 3-5                 | Compared                                     | OPR 5-6, 5-20            |
| ↑ Fast Sweep Indicator            | OPR 2-7, 3-5         | Autotransformer                 | SI 9                    | Calibration Procedures, Definitions          | OPR 5-19                 |
| [↔] and [↔] Keys                  | OPR 2-10             | AUX INPUT Connector             | GIS 28, OPR 2-11        | Calibration Procedures,<br>Step-by-Step      | OPR 5-21 to 5-28         |
| [x1] Key                          | OPR 2-10             | Auxiliary Input Voltage         | OPR 4-6                 | Calibration Sets, Saving                     | OPR 10-2                 |
| "x2" Notation                     | OPR 2-7              | Auxiliary Marker Value          | OPR 6-7                 | Calibration Standard                         |                          |
| "x2?" Notation                    | OPR 2-7              | Average Menu                    | OPR 4-27                | Frequency Response                           | OPR 5-8                  |
| π Non-Printable Characters        | OPR 7-5              | Averaging                       | UG 16, OPR 4-24         | Calibration Temperature                      | OPR 10-5                 |
| * Notation                        | OPR 2-7, 3-10        | Averaging Factor                | OPR 4-27                | Canada, Fuse Value for                       | SI 9                     |
| * in Table of Measured Values     | OPR 9-4              | [AVERAGING RESTART] Softkey     | OPR 4-27                | Capacitance Model                            | OPR 5-46                 |
| Δ REF = Δ                         | OPR 6-6              | [AVG] Key                       | OPR 4-24                | Capacitance, Fringing                        | OPR 5-8, 5-46            |
| 1/S Inverse S-Parameter Values    | OPR 4-8              | "Avg" Notation                  | OPR 2-7, 4-27           | Capacitive Reactance                         | OPR 4-10                 |
| 3 to 6 GHz Performance            | GIS 49, 51, 53       | [BACK SPACE] Key                | OPR 2-10                | [CENTER] and [SPAN] Keys                     | OPR 3-3                  |
| 3.5 mm Calibration Kit            | GIS 12               | Band-Limited Standards          | OPR 5-47                | CISPR Publication 11                         | SI 2                     |
| 3.5 mm Typical Performance        | GIS 52, 53           | Bandpass Mode                   | OPR 8-3                 | [CH 1] and [CH 2] Keys                       | OPR 2-8                  |
| 6 GHz Operation                   | OPR 14-12            | Bandwidth, 3 dB                 | UG 19, OPR 6-13         | Change in Data as Function<br>of Temperature | OPR 10-5                 |
| 7 mm Calibration Kit              | GIS 11               | Bandwidth, IF                   | UG 16, OPR 4-26         | Changing a Sequence Title                    | OPR 13-3                 |
| 7 mm System Specifications        | GIS 48, 49           | Bandwidth Search                | OPR 6-13                | Changing Channels                            |                          |
| 7 mm Verification Kit             | GIS 12               | Bandwidth Values                | OPR 4-28                | During Calibration                           | OPR 5-12                 |
| 50 ohm Calibration Kit            | GIS 11               | Basic Sequencing Menus          | OPR 13-8                | Change Supplement, Manual                    | GIS 4                    |
| 50 ohm Type-N Typical Performance | GIS 50, 51           | Beepers                         | OPR 4-21                | Channel, Active                              | OPR 2-8                  |
| 75 ohm Calibration Kit            | GIS 12               | [BEEP FAIL] Softkey             | OPR 7-11                | Channel Coupling                             | OPR 3-7                  |
| 75 ohm Type-N Typical Performance | GIS 54               | Bench-Top Systems               | SI 5                    | Characteristic Impedance                     | OPR 5-16                 |
| Aborting a Print or Plot          | OPR 9-1              | Binary Format                   | OPR 10-14               | Characterizing the System                    | OPR 5-1                  |
| AC Line Voltage                   | SI 9                 | Block Diagram, Simplified       | OPR 1-2                 | Class, Number of Standards in                | OPR 5-49                 |
| AC Power Cables                   | SI 10, 11            | BNC Connectors                  | SI 16                   | Cleaning Solution                            | OC 5                     |
| Accessories Available             | GIS 11               | Brackets                        | OPR 2-1                 | Cleaning the CRT                             | OC 5                     |
| Accessories Manual Binder         | GIS 3                | Bus Mode                        | OPR 11-6                | Cleaning the Fan Filter                      | OC 5                     |
| Accuracy Enhancement              | OPR 5-2, 5-53        | Bus Structure                   | OPR 11-3                | Clear Register Menu                          | OPR 10-8                 |
| Accuracy, Improvements in         | OPR 5-6              | C?                              | OPR 2-7, 5-11           | Clearance for Air Circulation                | SI 1                     |
| Active Channel                    | UG 4, OPR 2-4, 2-8   | C2                              | OPR 2-7, 5-13, 5-26     | Clearing a Sequence from Memory              | OPR 13-4                 |
| Active Entry Area                 | OPR 2-7              | C2?                             | OPR 2-7, 5-13           | Code Naming Convention                       | OPR 11-7                 |
| Active Function                   | OPR 2-1              | Cabinet Dimensions              | GIS 29                  | Compatible Calibration<br>Kits               | GIS 11, OPR 5-11, 5-14   |
| Active Marker                     | OPR 6-4              | Cable Faults                    | OPR 8-10                | Computer Controllers                         | GIS 15                   |
| Adapter Kits                      | GIS 13               | Cables, Compatible              | GIS 13                  | Connection Techniques                        | OPR 5-11                 |
| Adapters, Phase-Matched           | OPR 5-11             | Cable Stability                 | GIS 48 to 54            | Connector Care                               | OC 5, ACC, OPR 5-11      |
| Address Menu                      | OPR 7-5, 7-6         | [CAL] Key                       | OPR 5-10                | Connector Characteristics                    | GIS 28,<br>OPR 2-5, 2-11 |
| Addresses, Setting                | SI 14, OPR 7-6       | Cal Kit Models                  | OPR 5-42                | Connector Interface, Non-Standard            | OPR 5-42                 |
| Admittance Measurements           | UG 34, OPR 4-11      | Cal Kits, Selecting Defaults    | OPR 5-14                | Connector Pin Recession                      | GIS 28                   |
| Air Filter                        | SI 2, OC 5, OPR 2-12 | Calibrated Power Level          | OPR 5-29                | Connector Repeatability                      | GIS 48 to 54             |
| ALC                               | OPR 1-2              | Calibration                     | UG 11, OPR 5-10 to 5-28 | Connector Sex                                | OPR 5-9, 5-18            |
| Aliasing                          | OPR 8-15             | 1-Port Reflection               | UG 12, OPR 5-24         | Continuous Sweep                             | OPR 3-10                 |
| Alternate Sweep                   | OPR 3-3, 3-7         | 2-Port Measurement              | UG 13, OPR 5-25         | Continuous Switching                         | OPR 3-5                  |
| Altitude                          | SI 2, 17             | Frequency Response              | OPR 5-21                | Control Lines                                | OPR 11-2                 |
| Analog Bus                        | OPR 4-6              | Isolation                       | OPR 5-22, 5-23          | Controller, Computer                         | GIS 15                   |
| Anti-Static Mat                   | SI 2                 | Calibration Agreement           | GIS 9                   | Controller Modes                             | OPR 7-3                  |
| Aperture, Group Delay             | UG 25, OPR 4-13      | Calibration Data, Saving        | OPR 5-12                |                                              |                          |
| Arbitrary Frequency List          | OPR 3-12, 3-14       | Calibration, Invalid            | OPR 5-11                |                                              |                          |
| Arbitrary Impedance               | OPR 5-46             | Calibration Kits                | OPR 5-11                |                                              |                          |
| Attenuator                        | OPR 3-9              | Calibration Kits,<br>Compatible | GIS 11, OPR 5-11, 5-14  |                                              |                          |

### Key

|     |                                        |
|-----|----------------------------------------|
| ACC | System Accessories Manual              |
| GIS | General Information and Specifications |
| OPR | Operating and Programming Reference    |
| OC  | Operator's Check                       |
| SI  | System Installation                    |
| UG  | User's Guide                           |

|                                     |                 |                                 |                     |                                      |                         |
|-------------------------------------|-----------------|---------------------------------|---------------------|--------------------------------------|-------------------------|
| Controller Table                    | GIS 15          | Demodulating Forward Transform  | OPR 8-21            | Error Model, System                  | GIS 37                  |
| Conversion Menu                     | OPR 4-7         | Description of HP 8753B         | GIS 5               | Error Terms                          | OPR 5-5, 5-61           |
| [COPY FROM REG TITLES] Softkey      | OPR 10-16       | Deviation from Linear Phase     | OPR 4-17            | Error Terms, Combining               | GIS 55                  |
| Copying from File Titles            | OPR 10-9        | Directivity Error               | OPR 5-3, 5-54       | Errors, Residual                     | GIS 31                  |
| [COPY] Key                          | UG 17, OPR 9-2  | Directivity Specification       | GIS 48, 19          | ESF Error Term                       | OPR 5-54, 5-61          |
| "Cor" Notation                      | OPR 2-7, 5-13   | Directory, Disc                 | OPR 10-14           | ETF Error Term                       | OPR 5-60, 5-61          |
| Correctable Errors                  | OPR 5-3         | Disc Accessories                | GIS 15              | Example Procedure, Specifying        |                         |
| Correcting for Measurement Errors   | OPR 5-5         | Disc Drives, Compatible         | GIS 14              | Cal Kit                              | OPR 5-52                |
| Correction Menu                     | OPR 5-13        | Disc File Format                | OPR 10-14           | Example Programs Disc                | GIS 2                   |
| Coupled Channels                    | OPR 3-7         | Disc Storage                    | OPR 10-5            | EXF Error Term                       | OPR 5-60, 5-61          |
| Coupled Markers                     | OPR 6-8         | Disc Unit Number                | OPR 7-5             | EXT AM Connector                     | GIS 28, OPR 2-11        |
| Coupling, Stimulus                  | OPR 3-7         | Disc Volume Number              | OPR 7-5             | "Ext" Notation                       | OPR 2-7, 3-10           |
| Creating a Sequence                 | OPR 13-2        | Discs, Initializing             | OPR 10-15           | Extension Cord                       | SI 10                   |
| Crosstalk Error                     | OPR 5-5, 5-61   | Dispersion Effects in Waveguide | OPR 5-47            | Extensions, Port                     | OPR 5-16                |
| Crosstalk, System                   | GIS 48 to 54    | Display Bezel                   | OC 5                | External Disc, Storing               |                         |
| CRT Blank                           | OC 4            | Display Focus                   | OPR 4-21            | Calibrations                         | OPR 5-12, 10-5          |
| CRT, Cleaning                       | OC 5            | Display Intensity               | OPR 4-21            | External Memory                      | OPR 10-1, 10-5          |
| CRT Display                         | OPR 2-6         | [DISPLAY] Key                   | OPR 4-18            | External Source Mode                 | OPR 14-4                |
| CRT Graphics                        | OPR 11-8, 13-20 | Display Layout                  | OPR 2-6             | External Source Mode Characteristics | GIS 21                  |
| CRT Information Labels              | OPR 2-6         | Display Markers                 | OPR 6-1             | External Source Mode Spurious        |                         |
| Custom-Racked System Configurations | SI 6            | Display, Overlay or Split       | OPR 4-18, 4-20      | Signal Frequencies                   | OPR 14-17               |
| Cutoff Frequency of Standards       | OPR 5-48        | Do Sequence Menu                | OPR 13-9            | External Voltage Measurement         | OPR 2-11                |
| CW Frequency                        | OPR 3-5         | Drift Errors                    | OPR 5-2             | EXT REF INPUT Connector              | GIS 28, OPR 2-11        |
| CW Time                             | OPR 3-12, 8-19  | Drift Error Sources             | GIS 36              | EXT TRIGGER Connector                | GIS 28, OPR 2-11        |
| Damage, Potential                   | SI 2, 17        | Drift, Temperature              | GIS 44              | [EXT. TRIG ON SWEEP] Softkey         | OPR 3-10                |
| Damaged Shipment                    | SI 3            | Drift, Tracking                 | GIS 48 to 54        | Fail Beeper                          | OPR 7-11                |
| Data Bus                            | OPR 11-3        | Dual Channel Display            | UG 23, OPR 4-20     | Fail Message                         | OC 4, OPR 12-1 to 12-12 |
| [DATA / MEM] Softkey                | OPR 4-20        | Dust Contamination              | SI 6, OPR 2-9, 2-12 | Fan Filter                           | SI 2, OPR 2-12          |
| [DATA - MEMORY] Softkey             | OPR 4-20        | Dynamic Accuracy, System        | GIS 40              | Fan Filter, Cleaning                 | OC 5                    |
| [DATA - MEMORY] Softkey             | OPR 4-21        | Dynamic Range Considerations    | OPR 5-12            | Fan Off                              | OC 4                    |
| [DATA - MEMORY] Softkey             | OPR 4-20        | Dynamic Range, Optimizing       | UG 14, OPR 4-26     | Fault Location Measurements          | OPR 8-9                 |
| Data Point Definition               | OPR 1-4         | Dynamic Range Specification     | GIS 19              | FCC Class B Standards                | SI 2                    |
| Data Processing                     | OPR 1-3         | EDF Error Term                  | OPR 5-54, 5-61      | Feet, System Rack                    | SI 17                   |
| Data Transfer, HP-IB                | GIS 27          | Edit List Menu                  | OPR 3-14            | File Names                           | OPR 10-11, 10-15        |
| Dead Instrument                     | OC 4            | Editing a Sequence              | OPR 13-3            | File Storage                         | OPR 10-5                |
| Debug Mode                          | OPR 7-5         | Electrical Delay                | UG 24, OPR 4-17     | Fixed Marker                         | OPR 6-6                 |
| Decision Making Example             |                 | Electrical Length               | UG 24, OPR 4-17     | Flange Kit                           | SI 6                    |
| Sequences                           | OPR 13-21       | Electrostatic Discharge         | SI 2                | Flowgraph Model                      | OPR 5-53, 5-62          |
| Decision Making Menu, Sequencing    | OPR 13-17       | ELF Error Term                  | OPR 5-60, 5-61      | Flowgraph, Signal                    | OPR 4-4                 |
| Default Addresses                   | SI 14, OPR 7-6  | EMi Susceptibility              | SI 2                | Focus, Display                       | OPR 4-21                |
| Default Cal Kits                    | OPR 5-14        | Entering Sequences Using HP-IB  | OPR 13-21           | Format, Display                      | UG 9, OPR 4-8           |
| Default Conditions                  | OPR A-1         | Entry Area, Active              | OPR 2-6             | Format, Logical Interchange          | OPR 10-15               |
| Default Plot Parameters             | OPR 9-3         | Entry Block                     | OPR 2-9             | Formatted Data Arrays                | OPR 1-6                 |
| Define Standard Menus               | OPR 5-44, 5-45  | [ENTRY OFF] Key                 | OPR 2-10            | Formatting Discs                     | OPR 10-15               |
| Define Store Menu                   | OPR 10-12       | Environmental Characteristics   | GIS 29              | Forward Transform                    | OPR 8-19                |
| Defining a Cal Kit,                 |                 | Environmental Requirements      | SI 2, 17            | Forward Transform Range              | OPR 8-22                |
| Example Procedure                   | OPR 5-52        | Equipment Available             | GIS 14              | Fourier Transform                    | OPR 8-1                 |
| "Del" Notation                      | OPR 2-7         | Equipment Required              | GIS 10              | Frequency Blanking                   | OPR 4-22                |
| Delay, Electrical                   | UG 24, OPR 4-17 | Equivalent Parallel Impedance,  |                     | Frequency List                       | OPR 3-12                |
| Delay Format                        | OPR 4-10        | Admittance                      | OPR 4-7             | Frequency List Calibration           | OPR 3-10, 3-13          |
| Delay, Group                        | UG 25, OPR 4-13 | Equivalent Series Impedance,    |                     | Frequency Offset Characteristics     | GIS 21                  |
| Delay Offset                        | OPR 5-47        | Admittance                      | OPR 4-7             | Frequency Offset Operation           | OPR 14-8                |
| Delay/Thru Standard                 | OPR 5-46        | ERF Error Term                  | OPR 5-57, 5-61      | Frequency Offset Spurious Signals    | OPR 14-17               |
| [DELTA LIMITS] Softkey              | OPR 7-14        | Error Correction                | OPR 5-2             | Frequency Reference Signal           | OPR 2-11                |
| Delta Marker Mode                   | OPR 6-5         | Error Correction, Interpolated  | OPR 5-11            | Frequency Response Error             | OPR 5-5, 5-55, 5-59     |
| [DEMOD] Softkey                     | OPR 8-21        | Error Message, Phase Lock       | OC 4                | Frequency Specifications             | GIS 17, 19              |
|                                     |                 | Error Messages                  | OPR 12-1 to 12-12   |                                      |                         |

**Key**

|     |                                        |
|-----|----------------------------------------|
| ACC | System Accessories Manual              |
| GIS | General Information and Specifications |
| OPR | Operating and Programming Reference    |
| OC  | Operator's Check                       |
| SI  | System Installation                    |
| UG  | User's Guide                           |

|                                    |                      |                                    |                       |                              |                  |
|------------------------------------|----------------------|------------------------------------|-----------------------|------------------------------|------------------|
| Frequency vs. Time                 | OPR 3-12, 8-1        | IEC Standard 625                   | OPR 11-1              | Limits Menu                  | OPR 7-10         |
| Fringing Capacitance in            |                      | IEEE Standard 488.1                | OPR 11-1              | Limits, Entering             | OPR 7-13, 7-14   |
| Open Circuit                       | OPR 5-8, 5-46        | IF Bandwidth Reduction             | UG 16, OPR 4-26, 4-28 | Line Stretchers              | OPR 4-17         |
| Front Panel Features               | OPR 2-4              | Imaginary Format                   | OPR 4-13              | Line Switch                  | OPR 2-4          |
| Front Panel Keys                   | OPR 2-1              | Impedance, Characteristic          | OPR 5-16              | Line Types                   | OPR 9-6          |
| Full 2-Port Calibration            | UG 13, OPR 5-5, 5-25 | Impedance Measurements             | UG 33, OPR 4-10       | Line Voltage                 | GIS 28, SI 9     |
| Function Blocks                    | OPR 2-2              | Impedance Mismatch                 | OPR 5-4               | Line Voltage Selector Switch | SI 9, OPR 2-12   |
| Function Codes, Interface          | GIS 27               | Impedance, Terminal, of Short      |                       | Linear Frequency             | OPR 3-11         |
| Furniture, System                  | GIS 15               | and Load                           | OPR 5-46              | Linear Magnitude Format      | OPR 4-12         |
| Fuse, Line Power                   | SI 9, OPR 2-12       | Improvements in Measurement        |                       | Linear Phase, Deviation from | OPR 4-13         |
| "Gat" Notation                     | OPR 2-7              | Accuracy                           | OPR 5-5               | [LIST FREQ] Softkey          | OPR 3-12         |
| Gate Shape Characteristics         | OPR 8-19             | Impulse and Step Modes             | OPR 8-1               | [LIST VALUES] Softkey        | OPR 9-4          |
| Gating                             | OPR 8-18             | In Case of Difficulty              | OC 3                  | List Frequency               | OPR 3-12         |
| General Measurement Sequence       | UG 6                 | Incomplete Shipment                | SI 3                  | List Frequency,              |                  |
| [G+] <b>JB MKR</b> ] Softkey       | OPR 6-10             | Inductive Reactance                | OPR 4-10              | Implementation               | OPR 3-14 to 3-16 |
| Glass Filter, Cleaning             | OC 5                 | Initial Inspection                 | SI 3                  | Listing Measured Data        | OPR 9-4          |
| [G/n] Key                          | OPR 2-10             | Initializing Discs                 | OPR 10-15             | Loading Cutoff Frequencies   | OPR 5-48         |
| Grounding                          | SI 9                 | Input Characteristics              | GIS 19 to 21          | Loading from Disc            | OPR 10-18        |
| Group Delay                        | UG 25, OPR 4-13      | Insertion Loss, Measuring          | UG 18                 | Load Match Error             | OPR 5-4, 5-60    |
| Group Delay Aperture               | OPR 4-14, 4-28       | Insertion Phase                    | UG 22, OPR 4-13       | Load Match Specification     | GIS 48, 49       |
| Group Delay Characteristics        | GIS 25, 26           | Installation                       | SI 3                  | Load Sequence from Disc Menu | OPR 13-12        |
| Group Delay Format                 | OPR 4-10             | Installation Checklist             | SI 18                 | Loading a Sequence from Disc | OPR 13-5         |
| Group Delay in Waveguide           | OPR 5-47             | Instrument Mode Menu               | OPR 14-3              | [LOCAL] Key                  | OPR 7-2          |
| "H=2" Notation                     | OPR 2-7              | Instrument Modes                   | OPR 14-2              | Local Lockout                | OPR 7-2          |
| "H=3" Notation                     | OPR 2-7              | Instrument Specifications          | GIS 17 to 26          | Locating a File on Disc      | OPR 10-18        |
| Handshake Lines                    | OPR 11-3             | Instrument State Keys              | OPR 7-1               | [LOG FREQ] Softkey           | OPR 3-11         |
| Harmonic Menu                      | OPR 14-16            | Instrument States                  | OPR 10-2              | Logical Interchange Format   | OPR 10-15        |
| Harmonic Operation                 | OPR 14-14            | Instruments Covered by Manual      | GIS 4                 | Log Magnitude Format         | OPR 4-9          |
| Harmonic Rejection                 | OPR 4-26             | Intensity, Display                 | OPR 4-21              | Loss Offset                  | OPR 5-47         |
| Harmonic Characteristics           | GIS 18, 20           | Interface, Remote Programming      | GIS 27                | Low Loss Device              | GIS 34           |
| Hewlett-Packard Interface Bus      | GIS 7                | Interleave Factor                  | OPR 10-15             | Low Pass Frequency, Setting  | OPR 5-19, 8-6    |
| "Hid" Notation                     | OPR 2-7, 3-10        | Internal Save                      | OPR 10-4              | Low Pass Mode                | OPR 8-6          |
| Hold Sweep                         | OPR 3-10             | Internal Voltage Nodes             | OPR 4-6               | [M/u] Key                    | OPR 2-10         |
| HP 85033C 3.5 mm Cal Kit,          |                      | Interpolated Error Correction      | OPR 5-11              | Magnitude Characteristics    | GIS 22, 23       |
| Specifying                         | OPR 5-52             | Interpolated Markers               | OPR 6-8               | "man" Notation               | OPR 2-7          |
| HP 85043B System Rack              | GIS 14, SI 1, 6      | Introduction to Manual             | GIS 2                 | Manual Change Supplement     | GIS 4            |
| HP 85043B System Rack Modification | SI 6                 | Introductory Programming Guide     | OPR 11-1              | Manual, Guide to             | GIS 2, OPR 1-1   |
| HP 8753B Description               | GIS 5                | Inverse S-Parameters               | OPR 4-8               | Manual Sweep Time            | OPR 3-5          |
| HP-GL Considerations               |                      | Inverted Smith Chart               | OPR 4-11              | Map of Menus                 | OPR A-3 to A-8   |
| and Sequencing                     | OPR 13-20            | Isolation Calibration, Omission of | OPR 5-12              | Marker Bandwidth Search      | OPR 6-13         |
| HP-IB Addresses                    | SI 14, OPR 7-5       | Isolation Error                    | OPR 5-5, 5-61         | [MARKER → CW] Softkey        | OPR 13-17        |
| HP-IB Bus Structure                | OPR 11-3             | Isolation Standards                | OPR 5-19              | [MARKER → DELAY] Softkey     | OPR 4-17, 6-12   |
| HP-IB Cables                       | GIS 14, SI 12, 13    | [k/m] Key                          | OPR 2-10              | Marker Function Menu         | OPR 6-11         |
| HP-IB Capabilities                 | OPR 11-5             | Keys, Representation of            | OPR 2-1               | Marker Menu                  | OPR 6-4          |
| HP-IB Connections                  | SI 13                | Knob                               | OPR 2-10              | [MARKER → REFERENCE]         |                  |
| HP-IB Connector                    | OPR 2-12             | Label Class Menus                  | OPR 5-51              | Softkey                      | OPR 4-17, 6-12   |
| HP-IB Data Transfer                | GIS 27               | Label Kit Menu                     | OPR 5-55              | Marker Search                | OPR 6-13, 6-15   |
| HP-IB Description                  | GIS 7                | Label Standard Menu                | OPR 5-48              | [MARKER →] Softkeys          | OPR 6-12         |
| HP-IB Diagnostics                  | OPR 7-5              | Leakage Errors                     | OPR 5-2               | Marker Statistics            | OPR 4-26, 6-12   |
| HP-IB Equivalent Commands          | OPR 2-3              | Learn String                       | OPR 10-2              | Marker Stats, Bandwidth      | OPR 2-7          |
| HP-IB Menu                         | OPR 7-3              | Leveling the System Rack           | SI 17                 | Marker Tracking              | OPR 6-14         |
| HP-IB Quick Reference Guide        | OPR 11-2             | LIF (Logical Interchange Format)   | OPR 10-15             | Marker Values                | OPR 2-7          |
| HP-IB Remote Programming           | OPR 11-1             | Limit Fail Indications             | OPR 7-11              | Markers                      | UG 17, OPR 6-1   |
| HP-IB Requirements                 | OPR 11-5             | Limit Lines and Limit Testing      | OPR 7-8               | Masking                      | OPR 8-12         |
| HP-IB Restrictions                 | SI 13                | Limit Offsets                      | OPR 7-16              | Mass Storage                 | GIS 14           |
| HP-IB Status Indicators            | OPR 7-4              | Limit Types                        | OPR 7-15              | Math Capabilities            | OPR 4-18, 4-20   |
| HP-IB Tutorials                    | OPR 11-1, 11-2       | Limit Values                       | OPR 7-13              | [MEAS] Key                   | OPR 4-3          |
| Humidity                           | SI 2, 17             |                                    |                       | [MEASURE RESTART] Softkey    | OPR 3-7          |

**Key**

|     |                                        |
|-----|----------------------------------------|
| ACC | System Accessories Manual              |
| GIS | General Information and Specifications |
| OPR | Operating and Programming Reference    |
| OC  | Operator's Check                       |
| SI  | System Installation                    |
| UG  | User's Guide                           |

|                                        |                  |                                         |                 |                                     |                  |
|----------------------------------------|------------------|-----------------------------------------|-----------------|-------------------------------------|------------------|
| Measured Inputs                        | OPR 2-6          | Open Circuit Measured as Arc            | OPR 5-8, 5-46   | Power Specifications                | GIS 17, 19       |
| Measurement Accuracy, Improvements in  | OPR 5-6          | Operating and Programming Manual        | GIS 2           | Power Line Interference             | SI 2             |
| Measurement Calibration                | OPR 5-1          | Operating Parameters Listing            | OPR 9-4         | Power Meter Calibration             | OPR 5-28 to 5-41 |
| Measurement Direction                  | OPR 4-4          | Operator's Check                        | OC 1            | Applications                        | OPR 5-28         |
| Measurement Port Characteristics       | GIS 48 to 54     | Option 002, Harmonic Operation          | OPR 14-14       | Calibrated Power Level              | OPR 5-29         |
| Measurement Ports                      | OPR 2-4          | Option 006, 6 GHz Operation             | OPR 14-12       | Calibration Data Table              | OPR 5-35         |
| Measurement Sequence                   | UG 6             | Option 010, Time Domain Transform       | GIS 8, OPR 8-1  | Compatible Sweep Types              | OPR 5-29         |
| Measurement Throughput                 | GIS 27           | Option 908 Flange Kit                   | SI 6, 7         | Continuous Correction Mode          | OPR 5-30, 5-34   |
| Measurement Uncertainty                | GIS 31, OPR 5-2  | Option 913 Flange Kit                   | SI 6, 8         | Edit Segment (Calibration Factor %) | OPR 5-40         |
| Measurement Uncertainty Specifications | GIS 48, 49       | Options Available                       | GIS 7           | Edit Segment (Power Loss)           | OPR 5-40         |
| Mechanical Switch, Protection of       | OPR 3-5, 5-25    | Oscilloscope-Like Mode                  | OPR 3-12        | Interpolation Feature               | OPR 5-29         |
| Memory Allocation                      | OPR 10-2         | Out-of-Limits Indications               | OPR 7-11        | Main Menu                           | OPR 5-37         |
| Memory Math                            | OPR 4-18, 4-20   | Output Power                            | OPR 3-8, 3-9    | Menus                               | OPR 5-36         |
| Memory Trace                           | OPR 4-18         | Output Power Specifications             | GIS 17, 19      | Modes of Operation                  | OPR 5-30         |
| [MENU] Key                             | OPR 3-4          | Overheating                             | SI 6            | Power Loss Correction               |                  |
| Menu Map                               | OPR A-3 to A-8   | Overlay Display                         | OPR 4-20        | Factors                             | OPR 5-32, 5-34   |
| Menus                                  | OPR 2-1          | "P!" Notation                           | OPR 2-7         | Power Loss/Sensor Lists Menu        | OPR 5-38         |
| Message Area                           | OPR 2-7          | "P?" Notation                           | OPR 2-7         | Power Sensor Cal Factors            | OPR 5-32         |
| Message Transfer                       | OPR 11-3         | Packaging                               | SI 17           | Sample and Sweep Mode               | OPR 5-31, 5-35   |
| Microfiche                             | GIS 4            | Parameter Conversions                   | OPR 4-7         | Segment Edit (Calibration Factor %) | OPR 5-40         |
| Mismatch Errors                        | OPR 5-2          | Parentheses                             | OPR 1-1, 2-3    | Segment Edit (Power Loss)           | OPR 5-40         |
| [MKR] Key                              | OPR 6-1          | Pass Control                            | OPR 7-3, 7-5    | Segment Modify Menu                 | OPR 5-39         |
| [MKR FCTN] Key                         | OPR 6-11         | Pass/Fail Testing                       | OPR 7-8         | Typical Speed and Accuracy          | OPR 5-32         |
| Modes, Instrument                      | OPR 14-2         | "PC?" Notation                          | OPR 2-7         | Use Above 3 GHz                     | OPR 5-30         |
| Modifying Cal Kit Procedure            | OPR 5-43, 5-52   | "PCo" Notation                          | OPR 2-7         | Using                               | OPR 5-34         |
| Modifying Calibration Kits             | OPR 5-41 to 5-52 | Pen Numbers                             | OPR 9-7         | When Data Is Lost                   | OPR 5-29         |
| Network Analyzer Description           | GIS 5            | Performance with User-Modified Cal Kits | OPR 5-57        | Power Requirements                  | SI 2             |
| Network Analyzer Mode                  | OPR 14-4         | Peripheral Control                      | OPR 7-4         | Power Splitter                      | OPR 1-3          |
| New Sequence/Modify Sequence Menu      | OPR 13-10        | Permittivity, Relative                  | OPR 4-17        | Power-On Condition                  | OPR A-3          |
| Noise Floor, System                    | GIS 48 to 54     | Phase Characteristics                   | GIS 23 to 25    | Predefined Cal Kit Models           | OPR 5-14         |
| Noise Floor, Time Domain               | OPR 8-17         | Phase Format                            | OPR 4-10        | [PRESET] Key                        | UG 6, OPR 2-5    |
| Noise Reduction Techniques             | UG 16, OPR 4-24  | Phase Lock                              | OPR 1-2         | Preset State                        | OPR A-1, A-2     |
| Non-Insertable Devices                 | OPR 5-11         | Phase Lock Error Message                | OC 4            | Printers, Compatible                | GIS 14           |
| Non-Repeatable Errors                  | OPR 5-2          | Phase Offset                            | OPR 4-17        | Printing                            | UG 17, OPR 9-3   |
| Non-Reversible Devices                 | OPR 5-11         | Phase Response Measurement              | UG 22           | Printing a Sequence                 | OPR 13-6         |
| Non-Volatile Memory                    | OPR 10-1         | Phase Shift Linearity                   | OPR 4-13        | Print/Plot Controller Modes         | OPR 9-1          |
| Normalization                          | OPR 4-18         | Plot Scale                              | OPR 9-6         | Probe Power                         | GIS 28, OPR 2-5  |
| Number of Groups                       | OPR 3-10         | Plot Speed                              | OPR 9-6         | Problems and Solutions              | OC 3             |
| Number of Points                       | OPR 3-6          | Plotters, Compatible                    | GIS 14          | Purchase Order                      | SI 2             |
| Numeric Keypad                         | OPR 2-9          | Plotting                                | UG 17, OPR 9-3  | Purge File Menu                     | OPR 10-13        |
| "OF?" Notation                         | OPR 2-7          | Plotting Parameters, Default            | OPR 9-3         | Purge Sequence from Disc Menu       | OPR 13-13        |
| "OFs" Notation                         | OPR 2-7          | Plotting on Preprinted Forms            | OPR 9-5, 9-6    | Purging a Sequence from Disc        | OPR 13-6         |
| Offset Delay                           | OPR 5-47         | Plotting on Transparencies              | OPR 9-6         | Purpose and Use of Cal Procedures   | OPR 5-20         |
| Offset Impedance                       | OPR 5-48         | Plugs, Power                            | SI 10           | Quick Operating Guide               | GIS 2            |
| Offset Limits Menu                     | OPR 7-16         | [P MTR/HPIB TO TITLE] Softkey           | 13-19           | Quick Reference Guide               | GIS 2, OPR 11-2  |
| Offset Loss                            | OPR 5-47         | Point Definition                        | OPR 1-4         | [R + jX MKR] Softkey                | OPR 6-10         |
| Offset Short Measured as Arc           | OPR 5-8, 5-46    | Polar Characteristics                   | GIS 25          | Rack Assembly                       | SI 4             |
| Offset Z0                              | OPR 5-48         | Polar Format                            | UG 32, OPR 4-11 | Rack-Mount Flange Kit               | SI 6             |
| Offsets, Definitions                   | OPR 5-47         | Polar Marker Menu                       | UG 32, OPR 6-9  | Rack-Mounted Systems                | SI 4             |
| Omitting Isolation Calibration         | OPR 5-12         | Port Extensions                         | OPR 5-16, 5-17  | Rack Storage                        | SI 17            |
| One-Port Device                        | GIS 32           | Power Cables                            | SI 10, 11       | Rack, System                        | GIS 14           |
| One-Port Error Model                   | OPR 5-53, 5-58   | Power Check                             | SI 10           | Random Errors                       | GIS 36, OPR 5-2  |
| On-Site Service                        | GIS 8            | Power Considerations                    | SI 9            | Range, Alias Free                   | OPR 8-15         |
| On-Site System Service Manual          | GIS 3            | Power Cord Receptacle                   | OPR 2-12        | Range Resolution                    | OPR 8-17         |
| Open Circuit Capacitance               | OPR 5-8, 5-46    | Power Level                             | OPR 3-5         | Raw Data Arrays                     | OPR 1-5          |
|                                        |                  |                                         |                 | [Re/Im MKR] Softkey                 | OPR 6-9, 6-10    |

| Key |                                        |
|-----|----------------------------------------|
| ACC | System Accessories Manual              |
| GIS | General Information and Specifications |
| OPR | Operating and Programming Reference    |
| OC  | Operator's Check                       |
| SI  | System Installation                    |
| UG  | User's Guide                           |

|                                      |                      |                                       |                       |
|--------------------------------------|----------------------|---------------------------------------|-----------------------|
| Reactance Values                     | OPR 4-10             | Signal Flowgraph                      | OPR 4-4               |
| <b>[READ FILE TITLES]</b> Softkey    | OPR 10-13, 10-18     | Signal Separation                     | UG 7, 8, OPR 1-2      |
| Reading Sequences Using HP-IB        | OPR 13-21            | Single Segment Calibration            | OPR 3-13              |
| Real Format                          | OPR 4-13             | Single Sweep                          | OPR 3-10              |
| Rear Panel Connector                 |                      | Site Preparation                      | SI 1                  |
| Characteristics                      | GIS 28, OPR 2-11     | Site Preparation Checklist            | SI 4                  |
| Rear Panel Features                  | OPR 2-11             | Skin Effect                           | OPR 5-47              |
| <b>[RECALL]</b> Key                  | OPR 10-5             | SMA Calibration Kit                   | GIS 12                |
| Recall Menu                          | OPR 10-17            | SMA Connectors                        | OPR 5-42              |
| Receiver                             | OPR 1-3              | Smith Chart Format                    | UG 33, 34, OPR 4-11   |
| Receiving Shipment                   | SI 2                 | Smith Marker Menu                     | UG 34, OPR 6-10       |
| Reference Level                      | OPR 2-8              | "Smo" Notation                        | OPR 2-7               |
| Reference Marker                     | OPR 6-5              | Smoothing                             | UG 16, OPR 4-25, 4-28 |
| Reference Plane, Test Port           | OPR 5-16, 5-17       | Smoothing Aperture                    | OPR 4-28              |
| Reference Position                   | OPR 4-17             | Softkey Labels                        | OPR 2-8               |
| Reference Value                      | OPR 4-17             | Softkey Menus                         | OPR 2-1               |
| Reflection Coefficient               | UG 28                | Softkeys, Representation of           | OPR 2-1               |
| Reflection Measurements              | UG 27                | Source                                | OPR 1-2               |
| Register Titles                      | OPR 10-9             | Source Characteristics                | GIS 17, 18            |
| Relative Permittivity                | OPR 4-17             | Source Match Error                    | OPR 5-3, 5-54, 5-60   |
| Relative Velocity                    | OPR 4-17, 5-16, 8-5  | Source Match Specification            | GIS 48, 49            |
| Remote Operation                     | OPR 11-1             | Sources of Measurement                |                       |
| Remote Programming Modes             | OPR 7-3, 7-4         | Errors                                | GIS 36, OPR 5-2       |
| Repair Agreement                     | GIS 9                | Space Requirements                    | SI 1                  |
| Repeatability, Connector             | GIS 48 to 54         | <b>[SPAN]</b> Key                     | OPR 3-3               |
| Repeatability, Switch                | GIS 37               | Special Functions,                    |                       |
| Repeatable Errors                    | OPR 5-2              | Sequencing                            | OPR 13-15 to 13-19    |
| Residual Systematic Errors           | GIS 31               | Specifications, Instrument            | GIS 17 to 26          |
| Resistance Values                    | OPR 4-10             | Specifications, System                | GIS 31, 48, 49        |
| Response Cal Procedures              | OPR 5-21, 5-22       | Specify Class Menus                   | OPR 5-49, 5-50        |
| Response Calibration Defined         | OPR 5-5              | Specify Offset Menu                   | OPR 5-46              |
| Response Function Block Keys         | UG 4, OPR 4-1        | Spectral Purity Characteristics       | GIS 18                |
| Response Resolution                  | OPR 8-16             | Split Display                         | UG 23, OPR 4-19, 4-21 |
| Response Value Scale                 | OPR 4-16             | Spurious Signal Frequencies           |                       |
| Response and Isolation               |                      | In Frequency Offset Operation         | OPR 14-17             |
| Calibration                          | OPR 5-5, 5-22, 5-23  | In External Source Mode               | OPR 14-17             |
| In Tuned Receiver Mode               |                      | In Tuned Receiver Mode                | OPR 14-17             |
| Restoring Files from                 |                      | Stability, Cable                      | GIS 48 to 54          |
| Option 001                           | OPR 10-5, 10-18      | Stabilizing the Rack                  | SI 6                  |
| <b>[RESUME CAL SEQUENCE]</b> Softkey | OPR 5-14             | Standard Class Assignments Table      | OPR 5-49              |
| Return Loss                          | UG 28                | Standard Class Definition             | OPR 5-42              |
| Return-to-HP Repair                  | GIS 9                | Standard Coefficient Definition       | OPR 5-42              |
| Returning Instrument to HP           | SI 17                | Standard Definition                   | OPR 5-42              |
| Reverse Error Terms                  | OPR 5-62             | Standard Definitions Table            | OPR 5-44              |
| RFI Susceptibility                   | SI 2                 | Standard Devices                      | OPR 5-1, 5-8, 5-11    |
| Routine Maintenance                  | OC 5                 | Standard Frequencies                  | OPR 5-47              |
| Running a Sequence                   | OPR 13-2             | Standard Type Definition              | OPR 5-42              |
| S-Parameter Measurement Update       | OPR 5-25             | Standards, Compatible                 | GIS 11, 12            |
| S-Parameter Menu                     | OPR 4-5              | Standards, Defining for User Kit      | OPR 5-44              |
| S-Parameters                         | UG 8, OPR 4-3        | Standing Wave Ratio                   | OPR 4-12              |
| S11, S22 1-Port                      |                      | Start and Stop Frequency Values       | OPR 3-3               |
| Calibration                          | UG 12, OPR 5-5, 5-24 | <b>[START]</b> and <b>[STOP]</b> Keys | UG 4, OPR 3-3         |
| S11, S21, S12, S22                   | OPR 4-4              | Statistics                            | OPR 6-12              |
| Safety Considerations                | GIS 16               | <b>[STATS on/OFF]</b> Softkey         | OPR 6-12              |
| Safety Warnings                      | OPR 2-12             | Status Notations                      | OPR 2-7               |
| <b>[SAVE USER KIT]</b> Softkey       | OPR 5-15             | Step Attenuator                       | OPR 1-3               |
| <b>[SAVE]</b> Key                    | OPR 10-5             | Step Keys                             | OPR 2-10              |
| Saving Calibration Data              | OPR 5-12, 10-2       |                                       |                       |
| Saving Instrument States             | OPR 10-1             |                                       |                       |
| Scale, Smith and Polar Formats       | OPR 4-16             |                                       |                       |
| Scale/Div                            | OPR 2-7              |                                       |                       |
| <b>[SCALE/DIV]</b> Softkey           | OPR 4-16             |                                       |                       |
| <b>[SCALE REF]</b> Key               | OPR 4-16             |                                       |                       |
| Scattering Parameters                | OPR 4-3              |                                       |                       |
| Segment Menu, Frequency List         | OPR 3-13             |                                       |                       |
| Select Cal Kit Menu                  | OPR 5-14             |                                       |                       |
| Sequence More Menu                   | OPR 13-14            |                                       |                       |
| Sequencing                           | OPR 13-1 to 13-23    |                                       |                       |
| Autostarting Sequences               | OPR 13-16            |                                       |                       |
| Basic Sequencing Menus               | OPR 13-8             |                                       |                       |
| Changing a Sequence Title            | OPR 13-3             |                                       |                       |
| Clearing a Sequence from Memory      | OPR 13-4             |                                       |                       |
| Concepts                             | OPR 13-15            |                                       |                       |
| Creating a Sequence                  | OPR 13-2             |                                       |                       |
| Decision Making Menu                 | OPR 13-17            |                                       |                       |
| Decision Making Example              |                      |                                       |                       |
| Sequences                            | OPR 13-21            |                                       |                       |
| Do Sequence Menu                     | OPR 13-9             |                                       |                       |
| Editing a Sequence                   | OPR 13-3             |                                       |                       |
| Entering Sequences Using HP-IB       | OPR 13-21            |                                       |                       |
| HP-GL Considerations                 | OPR 13-20            |                                       |                       |
| Load Sequence from Disc Menu         | OPR 13-12            |                                       |                       |
| Loading a Sequence from Disc         | OPR 13-5             |                                       |                       |
| New Sequence/Modify                  |                      |                                       |                       |
| Sequence Menu                        | OPR 13-10            |                                       |                       |
| Printing a Sequence                  | OPR 13-6             |                                       |                       |
| Purge Sequence from Disc Menu        | OPR 13-13            |                                       |                       |
| Purging a Sequence from Disc         | OPR 13-6             |                                       |                       |
| Reading Sequences Using HP-IB        | OPR 13-21            |                                       |                       |
| Running a Sequence                   | OPR 13-2             |                                       |                       |
| Sequence More Menu                   | OPR 13-14            |                                       |                       |
| Special Functions                    | OPR 13-15            |                                       |                       |
| Special Function Menu                | OPR 13-16            |                                       |                       |
| Special Function More Menu           | OPR 13-19            |                                       |                       |
| Stopping a Sequence                  | OPR 13-2             |                                       |                       |
| Store Sequence to Disc Menu          | OPR 13-11            |                                       |                       |
| Storing a Sequence to Disc           | OPR 13-4             |                                       |                       |
| What is Sequencing?                  | OPR 13-1             |                                       |                       |
| Serial Numbers                       | GIS 4                |                                       |                       |
| Service and Support Products         | GIS 8                |                                       |                       |
| Service Manual                       | GIS 3                |                                       |                       |
| <b>[SERVICE MENU]</b> Softkey        | OPR 7-7              |                                       |                       |
| Service Tags                         | SI 17                |                                       |                       |
| <b>[SET FREQ LOW PASS]</b> Softkey   | OPR 5-19, 8-6        |                                       |                       |
| <b>[SET Z0]</b> Softkey              | OPR 5-16             |                                       |                       |
| Setting Addresses                    | OPR 7-5              |                                       |                       |
| Setting Up the System                | SI 5                 |                                       |                       |
| Sexed Connectors                     | OPR 5-9, 5-18        |                                       |                       |
| Shipment                             | SI 17                |                                       |                       |
| Shipping Carrier                     | SI 3                 |                                       |                       |
| Shipping Containers                  | SI 17                |                                       |                       |
| Shipping Forms                       | SI 2                 |                                       |                       |
| Shock Hazard                         | SI 10                |                                       |                       |
| Short Circuit Measured as Arc        | OPR 5-8, 5-46        |                                       |                       |
| Sidelobes                            | OPR 8-13             |                                       |                       |

#### Key

|     |                                        |
|-----|----------------------------------------|
| ACC | System Accessories Manual              |
| GIS | General Information and Specifications |
| OPR | Operating and Programming Reference    |
| OC  | Operator's Check                       |
| SI  | System Installation                    |
| UG  | User's Guide                           |

|                                         |                       |                                  |                        |                                   |                            |
|-----------------------------------------|-----------------------|----------------------------------|------------------------|-----------------------------------|----------------------------|
| Step and Impulse Modes                  | OPR 8-1               | Test Equipment, Recommended      | GIS 15                 | Trigger Menu                      | OPR 3-9                    |
| Stimulus Coupling                       | OPR 3-3, 3-7          | Test Port Characteristics        | GIS 48 to 54           | Troubleshooting                   | GIS 3, OC 3                |
| Stimulus Function Block Keys            | UG 4, OPR 3-1         | Test Port Overload               | OPR 3-8                | "tsH" Notation                    | OPR 2-7, 3-5, 4-20         |
| Stimulus Menu                           | OPR 3-4               | Test Port Reference Plane        | OPR 5-17               | tsH Override                      | OPR 3-5, 5-25              |
| Stimulus Start/Stop Values              | OPR 2-6               | Test Port Return Cables          | GIS 13                 | Tuned Receiver Mode               | OPR 14-6                   |
| Stimulus State for Calibration          | OPR 5-11              | Test Set Hold                    | OPR 2-7, 3-5, 4-20     | Tuned Receiver Mode               |                            |
| Stopping a Sequence                     | OPR 13-2              | Test Sets and Accessories Manual | GIS 3                  | Spurious Signals                  | OPR 14-17                  |
| Storage and Shipment                    | SI 17                 | Time Domain Option 010           | GIS 8                  | Two-Port Device                   | GIS 33                     |
| Store File Menu                         | OPR 10-11             | Time Domain                      | UG 35, OPR 8-1 to 8-22 | Two-Port Error Model              | OPR 5-59, 5-62, 5-63       |
| Stored Calibration Data                 | OPR 10-5              | Bandpass Mode                    | OPR 8-3                | Type-N Calibration Kit            | GIS 12                     |
| Store Sequence to Disc                  | OPR 13-11             | Reflection Measurements          | OPR 8-3                | Type-N Connector Sex              | OPR 5-15                   |
| Storing Calibration to External Disc    | OPR 5-12              | Transmission Measurements        | OPR 8-5                | Typical System Performance        | GIS 50 to 54               |
| Storing a Sequence to Disc              | OPR 13-4              | Demodulation                     | OPR 8-21               | Uncertainty Equations             | GIS 38, 39                 |
| Subsweeps, Frequency List               | OPR 3-15              | Forward Transform                | OPR 8-1, 8-19          | Uncertainty, Measurement          | GIS 31, OPR 5-1            |
| Sweep Definition                        | OPR 1-4               | Gate Shape Characteristics       | OPR 8-19               | Uncertainty Worksheets            | GIS 56, 57                 |
| Sweep Hold                              | OPR 3-10              | Gating                           | OPR 8-18               | Uncorrected Performance           | GIS 48 to 54               |
| Sweep Rate                              | OPR 3-11              | Low Pass                         | OPR 8-6                | Units Terminator Keys             | OPR 2-9                    |
| Sweep Speed Indicator ↑                 | OPR 3-5               | Fault Location Measurements      | OPR 8-9                | Units and Terminators             | OPR 11-8                   |
| Sweep Time                              | OPR 3-5               | Frequency Range, Setting         | OPR 8-6                | Unused Standards, Elimination of  | OPR 5-42                   |
| Sweep-to-Sweep Averaging                | OPR 4-24              | Reflection Measurements          | OPR 8-7                | User Cal Kit                      | OPR 5-42                   |
| Sweep Trigger                           | OPR 3-9               | Transmission Measurements        | OPR 8-10               | User-Configured Rack              | SI 6                       |
| Sweep Type                              | OPR 3-10              | Low Pass Impulse                 | OPR 8-1                | User-Modified Cal Kits            | OPR 5-42                   |
| Switch Protection                       | OPR 3-5               | Low Pass Step                    | OPR 8-1, 8-10          | Example Procedure                 | OPR 5-52                   |
| Switch Repeatability                    | GIS 37                | Masking                          | OPR 8-12               | Performance with                  | OPR 5-51                   |
| Switching in 2-Port Cal                 | OPR 5-25              | Noise Floor                      | OPR 8-17               | Verifying                         | OPR 5-51                   |
| SWR Format                              | UG 30, OPR 4-12       | Range                            | OPR 8-15               | User's Guide                      | GIS 2                      |
| System Accessories Manual Binder        | GIS 3                 | Reflection Formats               | OPR 8-2                | Valid Characters                  | OPR 11-7                   |
| System Characteristic Impedance         | OPR 5-16              | Reflectometry                    | OPR 8-1                | VDE 0730                          | SI 2                       |
| System Components                       | SI 3                  | Resolution                       | OPR 8-16               | Vector Accuracy Enhancement       | OPR 5-1                    |
| System Controller                       | OPR 7-3, 7-4          | Transform Menus                  | OPR 8-3                | Vector Error Correction, Complete | OPR 5-25                   |
| System Description                      | OPR 1-2               | Windowing                        | OPR 8-13               | Velocity Factor                   | UG 36, OPR 4-17, 5-16, 8-5 |
| System Error Model                      | GIS 37                | Time/Frequency Transforms        | OPR 8-1                | Verification Kits                 | GIS 12                     |
| System Furniture                        | GIS 15                | Title                            | OPR 2-7                | Verification Procedures           | GIS 3, OC 1                |
| System Installation Checklist           | SI 18                 | Title File Menu                  | OPR 10-16              | Volatile Memory                   | OPR 10-1                   |
| [SYSTEM] Key                            | OPR 7-7               | Title Menu                       | OPR 4-23               | Voltage Input                     | OPR 4-6                    |
| System Operating and Programming Manual | GIS 2                 | Title Register Menu              | OPR 10-9               | Voltage Nodes, Internal           | OPR 4-6                    |
| System Performance                      | GIS 31, 47, 55        | [TITLE TO MEMORY] Softkey        | OPR 13-19              | Voltage Selector                  | SI 9                       |
| System Rack                             | GIS 14, SI 6          | [TITLE TO P MTR/HPIB] Softkey    | OPR 13-17              | Volume Number                     | OPR 7-5                    |
| System Specifications                   | GIS 31, 48, 49        | [TITLE TO PRINTER] Softkey       | OPR 13-17              | Warning Beeper                    | OPR 4-21                   |
| Systematic Errors                       | GIS 36, OPR 5-2, 5-53 | Tool Kit, HP 8753B               | GIS 9                  | Warranty and Support Issues, Rack | SI 6                       |
| Table for Controller                    | GIS 15                | Trace Math                       | OPR 4-18, 4-20         | Warranty, One-Year On-Site        | GIS 8                      |
| Talker/Listener                         | OPR 7-3, 7-4          | Trace Memory                     | OPR 4-18               | Waveguide Connectors              | OPR 5-42                   |
| Target Menu                             | OPR 6-14              | Tracking Drift                   | GIS 48 to 54           | Waveguide Standards               | OPR 5-48                   |
| TDR                                     | OPR 8-1               | Tracking Error                   | OPR 5-5, 5-55, 5-61    | What is Sequencing?               | OPR 13-1                   |
| Temperature, Change of Data with        | OPR 10-5              | Tracking, Marker                 | OPR 6-14               | [WIDTHS on OFF] Softkey           | OPR 6-13                   |
| Temperature Drift                       | GIS 44                | Tracking Specifications          | GIS 48, 49             | Windowing                         | OPR 8-13                   |
| Temperature Ranges, Allowable           | GIS 29                | Transfer Formats                 | GIS 27                 | Worksheets, Uncertainty           | GIS 56, 57                 |
| Temperature, Calibration at             | OPR 10-5              | Transfer Switch                  | OPR 1-3, 5-25          | Y-Parameter Conversion            | OPR 4-7                    |
| Temperature Considerations              | SI 2, 17              | Transit Time                     | OPR 4-14               | Z-Parameter Conversion            | OPR 4-7                    |
| Terminal Impedance of Short and Load    | OPR 5-46              | Transmission Frequency           |                        | Z0                                | OPR 5-16                   |
| Terminator Keys                         | OPR 2-10              | Response Error                   | OPR 5-60               | Z0 Offset                         | OPR 5-48                   |
|                                         |                       | Transmission Measurements        | UG 18                  |                                   |                            |

#### Key

|     |                                        |
|-----|----------------------------------------|
| ACC | System Accessories Manual              |
| GIS | General Information and Specifications |
| OPR | Operating and Programming Reference    |
| OC  | Operator's Check                       |
| SI  | System Installation                    |
| UG  | User's Guide                           |



