

Keysight E4991 B Impedance Analyzer

Installation
Guide

Notices

© Keysight Technologies, Inc. 2014

No part of this manual may be reproduced in any form or by any means (including electronic storage and retrieval or translation into a foreign language) without prior agreement and written consent from Keysight Technologies, Inc. as governed by United States and international copyright laws.

Manual Printing History

The manual's printing date and part number indicate its current edition. The printing date changes when a new edition is printed (minor corrections and updates that are incorporated at reprint do not cause the date to change). The manual part number changes when extensive technical changes are incorporated.

August 2014 First Edition

Manual Part Number

E4991-90001

Edition

First edition, August 2014

Printed by Keysight Technologies International Japan G.K., 1-3-3 Higashikawasaki-cho, Chuo-ku, Kobe-shi, Hyogo, Japan.

Warranty

The material contained in this document is provided “as is,” and is subject to being changed, without notice, in future editions. Further, to the maximum extent permitted by applicable law, Keysight disclaims all warranties, either express or implied, with regard to this manual and any information contained herein, including but not limited to the implied warranties of merchantability and fitness for a particular purpose. Keysight shall not be liable for errors or for incidental or consequential damages in connection with the furnishing, use, or performance of this document or of any information contained herein. Should Keysight and the user have a separate written agreement with warranty terms covering the material in this document that conflict with these terms, the warranty terms in the separate agreement shall control.

Technology Licenses

The hardware and/or software described in this document are furnished under a license and may be used or copied only in accordance with the terms of such license

Restricted Rights Legend

If software is for use in the performance of a U.S. Government prime contract or subcontract, Software is delivered and licensed as “Commercial computer software” as defined in DFAR 252.227-7014 (June 1995), or as a “commercial item” as defined in FAR 2.101(a) or as “Restricted computer software” as defined in FAR 52.227-19 (June 1987) or any equivalent agency regulation or contract clause. Use, duplication or disclosure of Software is subject to Keysight Technologies’ standard commercial license terms, and non-DOD Depart-

ments and Agencies of the U.S. Government will receive no greater than Restricted Rights as defined in FAR 52.227-19(c)(1-2) (June 1987). U.S. Government users will receive no greater than Limited Rights as defined in FAR 52.227-14 (June 1987) or DFAR 252.227-7015 (b)(2) (November 1995), as applicable in any technical data.

Safety Notices

CAUTION

A **CAUTION** notice denotes a hazard. It calls attention to an operating procedure, practice, or the like that, if not correctly performed or adhered to, could result in damage to the product or loss of important data. Do not proceed beyond a **CAUTION** notice until the indicated conditions are fully understood and met.

WARNING

A **WARNING** notice denotes a hazard. It calls attention to an operating procedure, practice, or the like that, if not correctly performed or adhered to, could result in personal injury or death. Do not proceed beyond a **WARNING** notice until the indicated conditions are fully understood and met.

NOTE

This Note sign denotes important information. It calls attention to a procedure, practice, or condition that is essential for the user to understand.

Caution



Do not exceed the operating input power, voltage, and current level and signal type appropriate for the instrument being used, refer to your instrument's Function Reference.



Electrostatic discharge (ESD) can damage the highly sensitive microcircuits in your instrument. ESD damage is most likely to occur as the test fixtures are being connected or disconnected. Protect them from ESD damage by wearing a grounding strap that provides a high resistance path to ground. Alternatively, ground yourself to discharge any static charge built-up by touching the outer shell of any grounded instrument chassis before touching the test port connectors.

Safety Summary

When you notice any of the unusual conditions listed below, immediately terminate operation and disconnect the power cable.

Contact your local Keysight Technologies sales representative or authorized service company for repair of the instrument. If you continue to operate without repairing the instrument, there is a potential fire or shock hazard to the operator.

- Instrument operates abnormally.
- Instrument emits abnormal noise, smell, smoke or a spark-like light during operation.
- Instrument generates high temperature or electrical shock during operation.
- Power cable, plug, or receptacle on instrument is damaged.
- Foreign substance or liquid has fallen into the instrument.

Manufacturer's Declaration

Herstellerbescheinigung

GERA- USCHEMISSION

LpA < 70 dB
am Arbeitsplatz
normaler Betrieb
nach DIN 45635 T. 19

Manufacturer's Declaration

ACOUSTIC NOISE EMISSION

LpA < 70 dB
operator position
normal operation
per ISO 7779

Regulatory Compliance Information

This product complies with the essential requirements of the following applicable European Directives, and carries the CE marking accordingly:

- The Low Voltage Directive 2006/95/EC
- The EMC Directive 2004/108/EEC

To obtain Declaration of Conformity, please contact your local Keysight Technologies sales office, agent or distributor.

Safety Notice Supplement

- This equipment complies with EN/IEC61010-1:2001.
- This equipment is of MEASUREMENT CATEGORY I (CAT I). Do not use for CAT II, III, or IV.
- This equipment is a POLLUTION DEGREE 2, INDOOR USE product.
- This equipment is tested in stand-alone condition and in combination with the accessories supplied by Keysight Technologies against the requirement of the standards described in the Declaration of Conformity. If it is used as a system component, compliance of related regulations and safety requirements are to be confirmed by the builder of the system.
- Do not connect the measuring terminals to mains.

General Safety Precautions

The following general safety precautions must be observed during all phases of operation, service, and repair of this instrument. Failure to comply with these precautions or with specific WARNINGS elsewhere in this manual may impair the protection provided by the equipment. Such noncompliance would also violate safety standards of design, manufacture, and intended use of the instrument. Keysight Technologies assumes no liability for the customer's failure to comply with these precautions.

NOTE

The E4991B complies with INSTALLATION CATEGORY II as well as POLLUTION DEGREE 2 in IEC61010-1. The E4991B is an INDOOR USE product.

NOTE

The LEDs in the E4991B are Class 1 in accordance with IEC60825-1, CLASS 1 LED PRODUCT.

- **Ground the Instrument**

To avoid electric shock, the instrument chassis and cabinet must be grounded with the supplied power cable's grounding prong.

- **DO NOT Operate in an Explosive Atmosphere**

Do not operate the instrument in the presence of inflammable gasses or fumes. Operation of any electrical instrument in such an environment clearly constitutes a safety hazard.

- **Keep Away from Live Circuits**

Operators must not remove instrument covers. Component replacement and internal adjustments must be made by qualified maintenance personnel. Do not replace components with the power cable connected. Under certain conditions, dangerous voltage levels may remain even after the power cable has been disconnected. To avoid injuries, always disconnect the power and discharge circuits before touching them.

- **DO NOT Service or Adjust the Instrument Alone**

Do not attempt internal service or adjustment unless another person, capable of rendering first aid and resuscitation, is present.

- **DO NOT Substitute Parts or Modify the Instrument**

To avoid the danger of introducing additional hazards, do not install substitute parts or perform unauthorized modifications to the instrument. Return the instrument to a Keysight Technologies Sales and Services Office for service and repair to ensure that safety features are maintained in operational condition.

- Dangerous Procedure Warnings

Warnings, such as the example below, precede potentially dangerous procedures throughout this manual. Instructions contained in the warnings must be followed.

WARNING

Dangerous voltage levels, capable of causing death, are present in this instrument. Use extreme caution when handling, testing, and adjusting this instrument.

Safety Symbols

General definitions of safety symbols used on the instrument or in manuals are listed below.



Instruction Manual symbol: the product is marked with this symbol when it is necessary for the user to refer to the instrument manual.



Alternating current.



Direct current.



On (Supply).



Off (Supply).



A chassis terminal; a connection to the instrument's chassis, which includes all exposed metal structure.



Standby.

Certification

Keysight Technologies certifies that this product met its published specifications at the time of shipment from the factory. Keysight Technologies further certifies that its calibration measurements are traceable to the United States National Institute of Standards and Technology, to the extent allowed by the Institution's calibration facility or by the calibration facilities of other International Standards Organization members.

Documentation Warranty

The material contained in this document is provided "as is," and is subject to being changed, without notice, in future editions. Further, to the maximum extent permitted by applicable law, Keysight disclaims all warranties, either express or implied with regard to this manual and any information contained herein, including but not limited to the implied warranties of merchantability and fitness for a particular purpose. Keysight shall not be liable for errors or for incidental or consequential damages in connection with the furnishing, use, or performance of this document or any information contained herein. Should Keysight and the user have a separate written agreement with warranty terms covering the material in this document that conflict with these terms, the warranty terms in the separate agreement will control.

Exclusive Remedies

The remedies provided herein are Buyer's sole and exclusive remedies. Keysight Technologies shall not be liable for any direct, indirect, special, incidental, or consequential damages, whether based on contract, tort, or any other legal theory.

Assistance

Product maintenance agreements and other customer assistance agreements are available for Keysight Technologies products.

For any assistance, contact your nearest Keysight Technologies Sales and Service Office. Addresses are provided at the back of this manual.

Manuals for E4991B

Keysight provides the following three manuals for E4991B. The latest version of all documentations can be downloaded from <http://www.keysight.com/find/E4991B-manual>.

Installation Guide

The installation guide (this manual) provides start up setup information when you use the E4991B for the first time and troubleshooting information when the Windows cannot be boot up. See this manual first when you use the E4991B for the first time.

Online Help

The online help provides the information about the quick start, measurement operation, programming, and I/O interface. This is pre-installed in the E4991B. Press [**Help**] hard key on the front panel to open. Quick Start helps in understanding the E4991B operation quickly.

The latest version of online help is available at:
<http://ena.support.keysight.com/e4991b/manuals/webhelp/eng>.

The online help has context sensitive help, which is a great feature of the E4991B help. It allows you to get information about the selected softkey by pressing the **Help** key in the E4991B or by pressing **F1** in a keyboard attached to the E4991B or by clicking the help button in a dialog box. With context sensitive help, users can receive information quickly about the area the user is working in the firmware of the E4991B. It provides information relevant to the task that needs to be accomplished and reduces the time to search relevant information required to complete a task.

Service Guide

The service manual provides information about the parts, troubleshooting, performance test, adjustment and service menu.

In This Guide...

The following shows the contents of this manual.

Chapter 1, "Installation"

This chapter provides information about how to set up the Keysight E4991B.

Chapter 2, "Troubleshooting"

This chapter describes the troubleshooting during start up and the procedure of the operating system (OS) recovery when the Windows OS has been damaged.

Contents

1 Installation

Checking the Shipment	14
Environmental Requirements	15
Operating Environments	15
Ventilation Requirement	15
Protection Against Electrostatic Discharge (ESD)	16
Ensuring Adequate Free Space around Analyzer for Immediate Disconnection of Power Cable in Case of Emergency	16
Installing Front Handles/Rack Mounting Flanges	17
Power Supply	19
Verification of the Power Supply	19
Verification and Connection of Power Cable	19
Blown Fuses	20
Connecting the Test Head	21
Starting the E4991B	23
Turning the Power ON and OFF	23
Disconnection from Supply Source	24
Initial Registration of E4991B	26

2 Troubleshooting

Troubleshooting during Startup	28
System Recovery	29
Notes on executing the factory recovery function	29
Procedure to execute the factory recovery	29

Index

1 Installation

Checking the Shipment	14
Environmental Requirements	15
Installing Front Handles/Rack Mounting Flanges	17
Power Supply	19
Blown Fuses	20
Connecting the Test Head	21
Starting the E4991B	23
Initial Registration of E4991B	26

This chapter provides information about how to set up the Keysight E4991B.

Checking the Shipment

After you receive the analyzer, carry out checks during unpacking according to the following procedure.

WARNING

When unpacking the analyzer, if the exterior of the analyzer (such as the cover, front/rear panel, LCD screen, power switch, and port connectors) appear to be damaged during transport, do not turn on the power switch. Otherwise, you may get an electric shock.

Step 1. Check that the packing box or shock-absorbing material used to package the analyzer has not been damaged.

NOTE

If the packing box or shock-absorbing material has been damaged, leave the packing box and shock-absorbing material as is until other inspection items are checked as follows.

Step 2. Check the packaged items supplied with the analyzer for any damage or defects.

Step 3. By referring to the furnished contents list, check that all packaged items supplied with the analyzer have been received as per the specified options.

Step 4. After checking, if one of the following applies, contact your nearest Keysight Technologies sales and service office.

- 1 The packing box or shock-absorbing material used to package the analyzer has been damaged or the shock-absorbing material has traces where extreme force has been applied.
- 2 A packaged item supplied with the analyzer has mechanical damage or defects.
- 3 A packaged item supplied with the analyzer is missing.
- 4 A fault has been detected in the subsequent operation check of the analyzer.

If an abnormality is detected in step 1, contact the company that transported the analyzer as well as your nearest Keysight Technologies sales and service office.

Environmental Requirements

Set up the E4991B where the following environmental requirements are met.

Operating Environments

Ensure that the operating environment meets the following requirements.

Temperature	5 °C to 40 °C
Temperature range at the error-correction	23 °C ± 5 °C (< 1 °C deviation from the temperature when performing the error-correction)
Humidity	20% to 80% at wet bulb temperature < +29 °C (non-condensation)
Altitude	0 to 2,000 m (0 to 6,561 feet)
Vibration	0.21 G maximum, 5 Hz to 500 Hz

NOTE

Above environmental requirements are NOT for the specifications and measurement accuracy of the analyzer, but for the operating environment of the analyzer.

Ventilation Requirement

To ensure safety requirements, the specifications and measurement accuracy of the analyzer, you must keep the environmental temperature within the specified range by providing appropriate cooling clearance around the analyzer or, for the rack mount type, by forcefully air-cooling inside the rack housing. For more information on environmental temperature to satisfy the specifications and measurement accuracy of the analyzer, see the specification in the *E4991B Datasheet*.

When the environmental temperature around the analyzer is kept within the temperature range of the operating environment specification (See Section “Operating Environments” on page 15), the analyzer conforms to the requirements of the safety standard. Furthermore, under that temperature requirement, the analyzer still conforms to the requirements of the safety standard even when placing the analyzer with cooling clearance as follows:

	Requirements
Back	≤ 180 mm
Sides	≤ 60mm (both right and left)

Protection Against Electrostatic Discharge (ESD)

Set up a static-safe work-station to protect the electronic components from the damage by the electrostatic discharge (ESD) as shown in **Figure 1**.

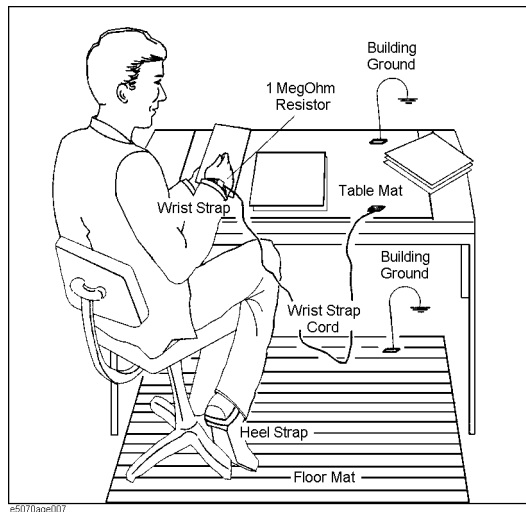

Figure 1 Example of the static-safe work station

Ensuring Adequate Free Space around Analyzer for Immediate Disconnection of Power Cable in Case of Emergency

As described in “Disconnection from Supply Source” on page 24, the power supply is disconnected by removing the power cable’s connector plug from either the AC outlet or the E4991B unit. When installing the E4991B, ensure that there is sufficient free space around the unit to permit quick disconnection of the plug (from AC outlet or E4991B unit) in case of emergency.

Installing Front Handles/Rack Mounting Flanges

The E4991B can be installed on a workbench or on a rack.

This section describes how to install the front handles (Option 1CN) used for moving or transporting the instrument, and how to install the analyzer in an equipment rack as part of a measurement system (Option 1CM: without the handles, Option 1CP: with the handles).

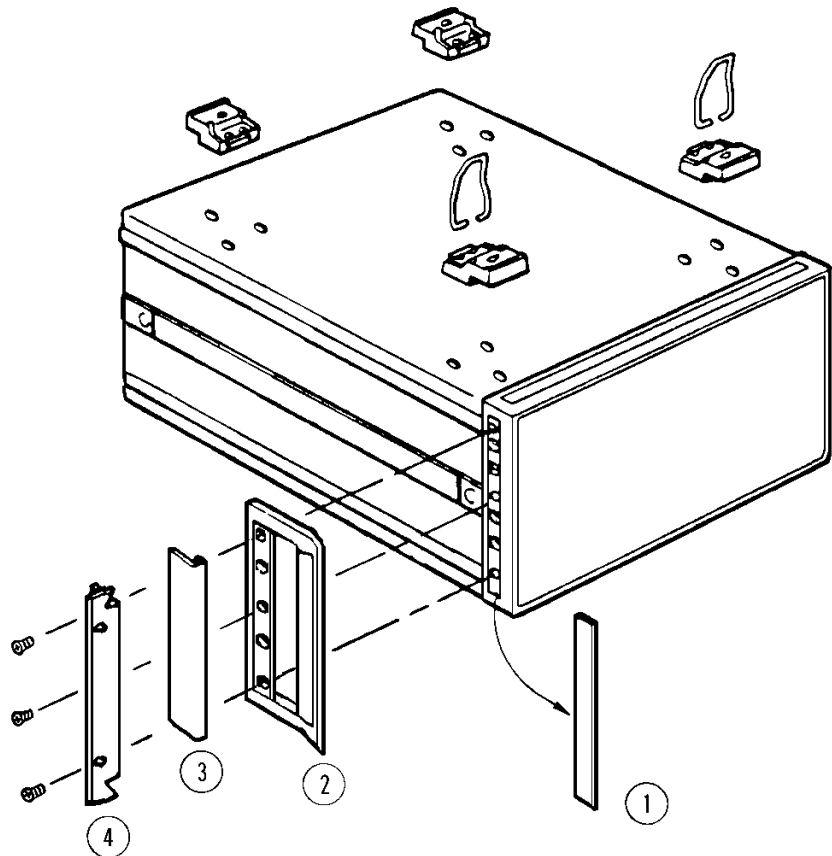

e5070aqj009

Figure 2 Installing front handle/rack-mount kits

The handle kit (Option 1CN) is used for transporting and relocating of the E4991B.

The rack-mount kit (Option 1CM) includes two flanges (locking side plates) for mounting the E4991B on a rack (482.6 mm/19 inches) conforming to the EIA Standard.

Option 1CP comes with both, the handle kit and rack-mount kit.

1 Installation

While referring to **Figure 2** install the handle kit/rack-mount kit by following these steps.

Step 1. Remove the adhesive-backed trim strip (1) from each side of the outer frame of the E4991B front panel.

Step 2. Use the provided screws to mount the

- front handles (2) - for Option 1CN
- rack-mounting flange (4) - for Option 1CM
- both - for Option 1CP

on each side of the E4991B front panel frame.

Step 3 (Option 1CN/Option 1CP). Attach the modified trim strip (3) provided to each front handle in order to cover the front panel locking screws.

Step 3 (Option 1CM/Option 1CP). Remove the four bottom feet of the E4991B (lift the bar marked TAB on the inner side of the foot and slide the foot towards the bar).

Step 4 (Option 1CM/Option 1CP). Mount the E4991B on the rack.

WARNING

If the installed front handle becomes damaged, replace it with a new one immediately. A damaged handle may break while moving or lifting the instrument and cause personal injury or damage to the instrument.

CAUTION

Use both a front handle and a rack-mounting flange in the same time certainly. Do not attempt to install flanges or handles separately with hardware provided. Serious electrical damage will occur to the instrument.

Power Supply

Before turning on the E4991B power, check the following.

Verification of the Power Supply

Confirm that the power supplied to the E4991B meets the following requirements:

	Requirements
Voltage	90 to 264 VAC
Frequency	47 to 63 Hz
Maximum power consumption	300 VA

Verification and Connection of Power Cable

The three-wire power cable attached to the E4991B has one wire serving as the ground. Using this power cable allows the E4991B to be grounded, thereby protecting you against any potential electrical shock from the power outlet.

Step 1. Confirm that the power cable is not damaged.

WARNING

NEVER use a power cable showing any sign of damage. Faulty cables can cause electrical shock.

Step 2. Use the supplied cable to connect between the power cable receptacle (Figure 5 on page 24) on the rear panel of the E4991B and a three-wire power outlet with the grounding prong firmly connected in the ground slot.

WARNING

Use the supplied power cable with grounding wire to securely ground the E4991B.

Power cord list, 16000-99101 shows the power cable options.

Blown Fuses

If the fuse appears to have blown during operation, this instrument may be subject to failure and must be repaired. For any assistance, contact Keysight Technologies Customer contact center listed at the end of this guide.

The E4991B uses the following fuse types:

UL/CSA Type, Slow-Blo, 10 A-250 Vac.

WARNING

DO NOT replace the fuse yourself as doing this may expose yourself to electrical shock.

Connecting the Test Head

When performing calibration with the 7-mm Calibration Kit or measuring DUTs with the test fixture and 7-mm terminal, you must first connect the test head to the E4991B. The procedure for making this connection is described below.

When connecting the test head:

- Do not remove the four feet on the bottom of the E4991B; doing this would make the connection more difficult.
- Turn the N-type connectors in the order given in the instructions below when tightening them. The N-type connector for the RF OUT terminal is mounted with a special design for **flexible movement** to provide easier connection or removal of the test head.

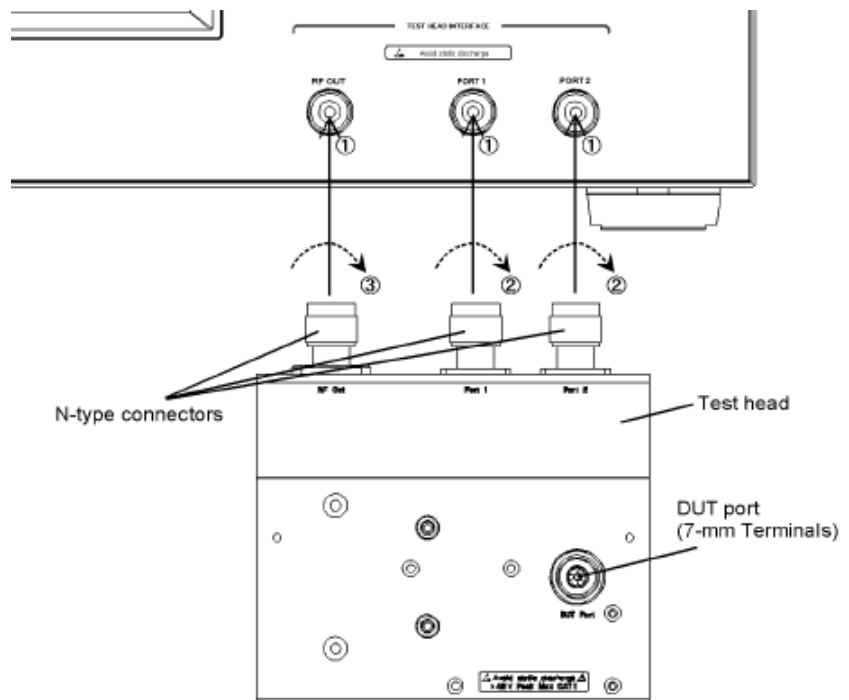

Figure 3 Connecting Test head to E4991B

- 1 Attach the N-type connectors (test head side) to their corresponding terminals (RF OUT, PORT 1 and PORT 2), which serve as the test head interface of the E4991B.
- 2 Turn the N-type connectors for PORT 1 and PORT 2 at the same time to tighten them.

1 Installation

- 3 Finally, turn the N-type connector for RF OUT to tighten it.

NOTE

When removing the test head, loosen and disconnect the N-type connector connected to the RF OUT terminal first.

The N-type connector for the RF OUT terminal is mounted with a special design for **flexible movement** to provide easier connection or removal of the test head.



Figure 4 Test head connected to E4991B

Starting the E4991B

This section describes how to turn ON/OFF the E4991B power and how to cut off the power supply in the case of emergency.

Turning the Power ON and OFF

The standby switch can turn ON/OFF the E4991B. The color on the button shows the status, as indicated below:

Indicator Color	Description
Green	Normal power on status
Orange	Standby status
Red	Illegal power on status

Perform the following steps to turn the power ON or OFF.

Turning the Power ON

Step 1. Confirm if the Line Switch on the rear panel is turned ON. The switch should always be turned ON.

Step 2. Press the standby switch once. It changes to green color.

This operation turns ON the power, and the E4991B starts the self-test.

Step 3. Confirm that the self-test indicates normal operation.

Normal operation is confirmed by the self-test if no error message appears.

Turning the Power OFF

Step 1. To turn OFF the power of the E4991B, first, press this standby switch or send a shutdown command from the external controller to activate the shutdown process (the process of software and hardware necessary to turn OFF the power supply). This puts the E4991B into the standby state and the button changes to orange color.

Step 2. Next, if necessary, turn OFF the power supply to the power cable receptacle (Line Switch) on the rear panel.

NOTE

Under normal use, **never directly interrupt the power supply to the power cable receptacle on the rear panel when the power supply is turned ON.** Always keep the Line Switch ON and never turn it.

If you directly interrupt the power supply to the power cable receptacle when the power supply is turned ON, or turn OFF the Line Switch, the shutdown process will not work. This could damage the software and hardware of the E4991B and lead to device failure.

Turning ON the power supply after a faulty shutdown may cause the system to start up in a condition called "safe mode." If this occurs, first shut down the system to set it to the standby state and then turn ON the power supply again to start up the system in normal mode.

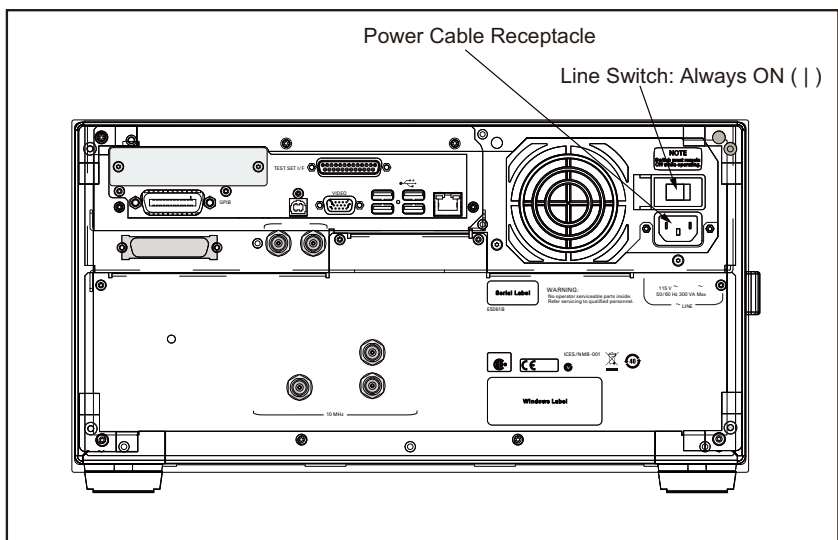

e5061b061

Figure 5 Line switch (Always ON) and power cable receptacle

Disconnection from Supply Source

The power supply of the E4991B is cut off by disconnecting the plug of the power cable (on either AC outlet side or E4991B side). When it is necessary to disconnect the power supply in order to avoid shock hazards, etc., pull out the power cable plug from either the AC outlet side or the E4991B side.

NOTE

To allow this operation to be performed smoothly, be sure to follow the guidelines in “Ensuring Adequate Free Space around Analyzer for Immediate Disconnection of Power Cable in Case of Emergency” on page 16.

When turning the power OFF under normal circumstances, always follow the methods described in “Turning the Power OFF” on page 23.

Initial Registration of E4991B

When you start up the E4991B for the first time, you need to perform the initial registration of the Windows operating system of the E4991B.

When the Windows agreement message box appears, click Agree. The rest of the procedure runs automatically.

NOTE

The Touch Screen does not require initial calibration to work for the very first time. However, users have the option of calibrating the touch screen whenever required. To do so, select System hardkey followed by Misc Setup > Display Setup > Adjust Touch Screen. Refer to Online Help for more details on how to adjust the touch screen.

2 Troubleshooting

Troubleshooting during Startup	28
System Recovery	29

This chapter describes the troubleshooting process during start up and the procedure of the operating system (OS) recovery when the Windows OS has been damaged.

Troubleshooting during Startup

When you encounter problems during start up, see [Table 1](#). System recovery saves most of problems.

Table 1 Troubleshooting during startup

Symptom	Solution
Turning ON (I) the standby switch does not start up the system.	Confirm that the power cable is properly plugged in. Confirm that the line switch at the rear panel is turned ON.
The system starts up, but it automatically shuts down immediately.	Execute the system recovery.
The system starts up, but it enters the service mode (The status bar at the lower right of the screen displays SVC in red).	
The measurement screen appears after start up, but the power-on test fails with Error Message 241 prompting on a red background in the instrument's message/warning area at the lower left of the screen.	

System Recovery

By executing system recovery, you can return the E4991B's system (the Windows operating system and the firmware) to the factory state (at the time of purchase^{*1}).

CAUTION

Strictly follow the steps described below. If you do any operation other than the following steps, the system may not be recovered.

Notes on executing the factory recovery function

Executing the factory recovery function causes the following conditions:

- In addition to the Windows operating system and the firmware, the following settings of the E4991B are returned to the factory state.
 - Network setting
 - GPIB setting
 - Printer setting
- The driver for the supported printer which is installed after purchase is deleted.
- You need to execute initial registration again.

Files that you have created using the save function (files in the D drive) are not affected. However, Keysight recommends backing them up before executing system recovery for precautionary purposes. For more information on backup, refer to “*Backing Up the Data*” as described in *E4991B Online Help*.

Procedure to execute the factory recovery

This section describes how to return the contents of the C drive to the factory state.

NOTE

You need a keyboard for this operation.

* 1. The default setting of the hard disk is recovered during the system recovery. For the hard disk that had failed earlier and had been replaced (after purchase), its default setting may not be the same as the factory state.

2 Troubleshooting

- Step 1. Shut down the E4991B.
- Step 2. Disconnect all of the USB device from the USB ports.
- Step 3. Connect the keyboard to the E4991B.
- Step 4. Press the standby switch of the E4991B to turn it ON.
- Step 5. When the screen as shown in the figure below appears, select **Instrument Image Recovery System** and press **[Enter]**.

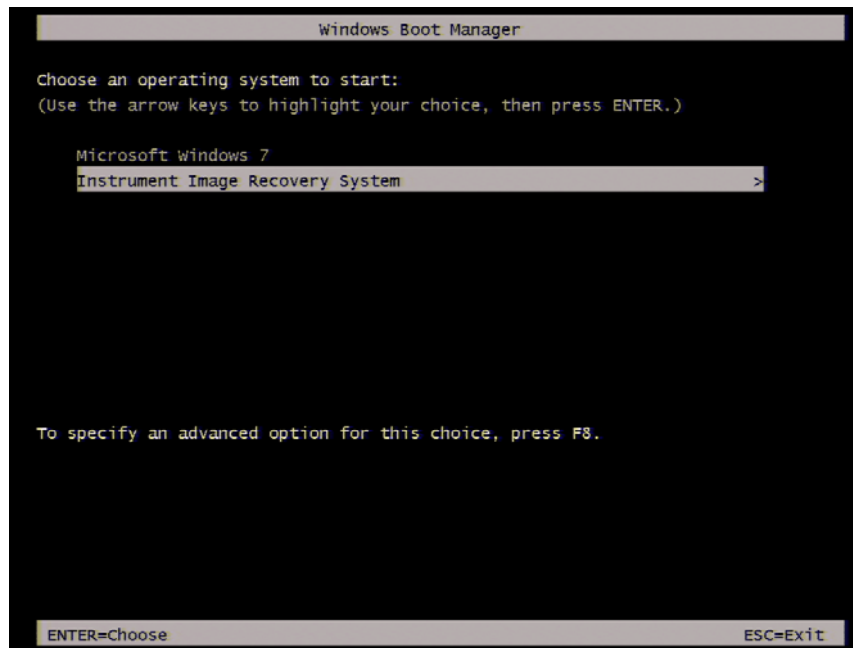

Figure 6 Instrument Image Recovery System selection screen

NOTE

After several seconds, the next screen appears automatically even if you do not press any key.

Step 6. Type **2** to select **Recover the original factory system image** option and press **[Enter]**.

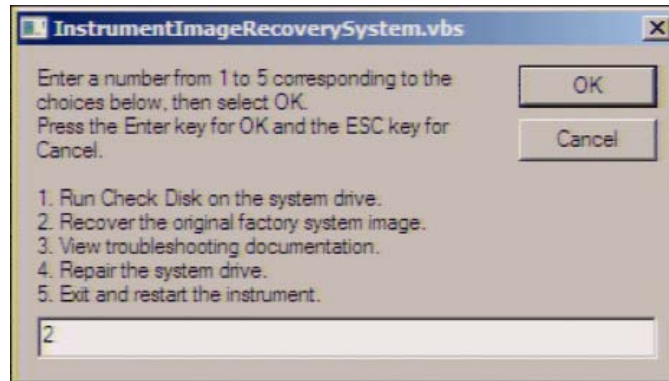

Figure 7 System recovery selection screen

Step 7. A confirmation message appears. Click **OK** to continue the process.

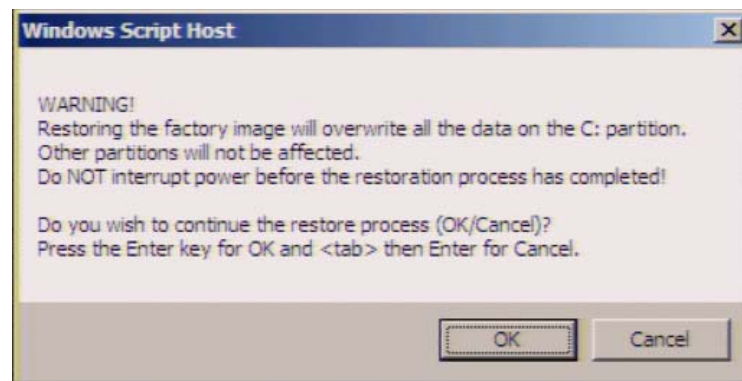

Figure 8 System recovery confirmation screen

Step 8. The progress of the system configuration is displayed on the screen. The recovery takes a few minutes depending on the amount of data.

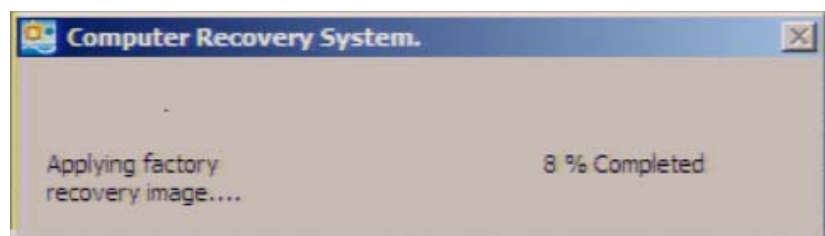
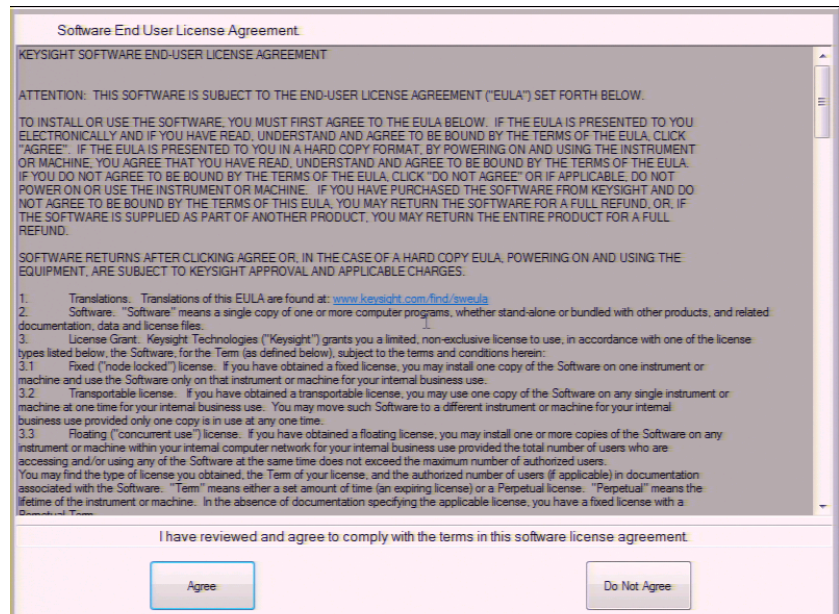

Figure 9 System configuration progress screen

Step 9. Once the recovery process is completed, completion message prompts. Click **OK**. The E4991B restarts automatically.

Step 10. **Software End User License Agreement** appears . Press **[Agree]**.



Step 11. After the restart, execute initial registration. For information on the execution procedure, refer to “Initial Registration of E4991B” on page 26.

CAUTION

Never turn OFF the power during the system recovery because doing so may cause serious damage to the E4991B.

Index

A

accessories
connecting accessories, 18
assistance, 7

C

connection
connecting accessories, 18

D

documentation warranty, 7

E

environmental requirements
operating environments, 15
ventilation requirement, 15
error-correction
temperature range, 15
exclusive remedies, 7

F

front handles
how to install front handles, 17
how to install the handle kit, 17

H

handle kit
how to install the handle kit, 17

I

inspection
checking the shipment, 14

M

manual
contents, 9

O

option
Option 1CM, 17
Option 1CN, 17

Option 1CP, 17

P

power
disconnection from supply
source, 24
power cable options, 19
verification and connection of power
cable, 19
verification of the power supply, 19

S

safety
symbols, 6
shutdown
turning the power OFF, 23
system
installing rack mounting flanges, 17
System Recovery
how to execute factory recovery, 29
how to execute user recovery
function, 30, 32
types of system recoveries, 29

www.keysight.com

© Keysight Technologies, Inc. 2014

Printed in Malaysia
First edition, August 2014



E4991-90000

