

Agilent E6618A Multiport Adapter

**For use with Agilent E6630A
Wireless Connectivity Test Set**

Getting Started & User's Guide



Agilent Technologies

Notices

© Agilent Technologies, Inc. 2013

No part of this manual may be reproduced in any form or by any means (including electronic storage and retrieval or translation into a foreign language) without prior agreement and written consent from Agilent Technologies, Inc. as governed by United States and international copyright laws.

Trademark Acknowledgements

Bluetooth[®] is a trademark owned by Bluetooth SIG, Inc., U.S.A, and licensed to Agilent Technologies.

cdma2000[®] is a US registered certification mark of the Telecommunications Industry Association.

WiMAX[®] is a US trademark of the WiMAX Forum.

Copyright 2013 Agilent Technologies Inc.

Licensed under the Apache License, Version 2.0 (the "License"); you may not use this file except in compliance with the License.

You may obtain a copy of the License at: <http://www.apache.org/licenses/LICENSE-2.0>

Unless required by applicable law or agreed to in writing, software distributed under the License is distributed on an "AS IS" BASIS WITHOUT WARRANTIES OR CONDITIONS OF ANY KIND, either express or implied.

See the License for the specific language governing permissions and limitations under the License.

Manual Part Number

E6618-90001

Print Date

December 2013

Printed in USA

Agilent Technologies, Inc.
1400 Fountaingrove Parkway
Santa Rosa, CA 95403

Warranty

The material contained in this document is provided "as is," and is subject to being changed, without notice, in future editions. Further, to the maximum extent permitted by applicable law, Agilent disclaims all warranties, either express or implied, with regard to this manual and any information contained herein, including but not limited to the implied warranties of merchantability and fitness for a particular purpose. Agilent shall not be liable for errors or for incidental or consequential damages in connection with the furnishing, use, or performance of this document or of any information contained herein. Should Agilent and the user have a separate written agreement with warranty terms covering the material in this document that conflict with these terms, the warranty terms in the separate agreement shall control.

Technology Licenses

The hardware and/or software described in this document are furnished under a license and may be used or copied only in accordance with the terms of such license.

Restricted Rights Legend

If software is for use in the performance of a U.S. Government prime contract or subcontract, Software is delivered and licensed as "Commercial computer soft-

ware" as defined in DFAR 252.227-7014 (June 1995), or as a "commercial item" as defined in FAR 2.101(a) or as "Restricted computer software" as defined in FAR 52.227-19 (June 1987) or any equivalent agency regulation or contract clause. Use, duplication or disclosure of Software is subject to Agilent Technologies' standard commercial license terms, and non-DOD Departments and Agencies of the U.S. Government will receive no greater than Restricted Rights as defined in FAR 52.227-19(c)(1-2) (June 1987). U.S. Government users will receive no greater than Limited Rights as defined in FAR 52.227-14 (June 1987) or DFAR 252.227-7015 (b)(2) (November 1995), as applicable in any technical data.

Safety Notices

CAUTION

A CAUTION notice denotes a hazard. It calls attention to an operating procedure, practice, or the like that, if not correctly performed or adhered to, could result in damage to the product or loss of important data. Do not proceed beyond a CAUTION notice until the indicated conditions are fully understood and met.

WARNING

A WARNING notice denotes a hazard. It calls attention to an operating procedure, practice, or the like that, if not correctly performed or adhered to, could result in personal injury or death. Do not proceed beyond a WARNING notice until the indicated conditions are fully understood and met.

In This Guide...

This guide contains the following information:

1 Quick-Start

This chapter explains how to install and initialize the multiport adapter.

2 Front and Rear Panel Features

Refer to this chapter for information on front-panel and rear-panel functions, connectors, and indicators.

3 Instrument Operation

This chapter explains how the multiport adapter is used in conjunction with the EX6630A test set.

4 Troubleshooting

This chapter details some basic steps that may solve any problems you are experiencing with the multiport adapter.

5 Verification

This chapter provides verification procedures which can be used to determine if the E6618A and the E6630A are operating properly as a system.

Warranty

This Agilent technologies instrument product is warranted against defects in material and workmanship for a period of three years from the date of shipment. During the warranty period, Agilent Technologies will, at its option, either repair or replace products that prove to be defective.

For warranty service or repair, this product must be returned to a service facility designated by Agilent Technologies. Buyer shall prepay shipping charges to Agilent Technologies and Agilent Technologies shall pay shipping charges to return the product to Buyer. However, Buyer shall pay all shipping charges, duties, and taxes for products returned to Agilent Technologies from another country.

Safety

This product has been designed and tested in accordance with accepted industry standards, and has been supplied in a safe condition. The documentation contains information and warnings that must be followed by the user to ensure safe operation and to maintain the product in a safe condition.

“WARNING” denotes a hazard. It calls attention to a procedure which, if not correctly performed or adhered to, could result in injury or loss of life. Do not proceed beyond a warning note until the indicated conditions are fully understood and met.

“CAUTION” denotes a hazard. It calls attention to a procedure that, if not correctly performed or adhered to, could result in damage to or destruction of the product. Do not proceed beyond a caution note until the indicated conditions are fully understood and met.

Where to Find the Latest Information

For the latest information about this instrument, including product information, application information, and instrument software upgrades for the E6630A Wireless Connectivity Test Set (which is used in combination with this product), contact your Agilent sales representative, or see the following URLs:

http://www.agilent.com/find/e6630a_software

To receive the latest updates by email, subscribe to Agilent Email Updates:

<http://www.agilent.com/find/emailupdates>

Information on preventing instrument damage can be found at:

<http://www.agilent.com/find/tips>

Contents

1 Quick-Start

About the Multiport Adapter	10
Initial Inspection	12
Verifying the Contents	12
Shipping Problems?	12
Instrument Location and Rack Mounting Requirements	13
Weight and Dimensions	13
Locating the instrument	13
Cooling and rack mounting	13
Power Disconnection	13
Instrument Information	14
Power requirements	14
Environmental Conditions (Operating)	15
Protecting Against Overpowering	16
Instrument Maintenance	17
Protecting against electrostatic discharge	18
Regulatory Compliance	19
Turning on the Instrument the First Time	20
Checking the E6630A Test Set	20
Connecting the Multiport Adapter to the E6630A and Other Devices	21
Initializing the Multiport Adapter	24
Verifying the FPGA Code Version in the Multiport Adapter	27

2 Front and Rear Panel Features

Rear-Panel Features	32
Test Set Display Indicators	33
Front and Rear Panel Symbols	34

3 Instrument Operation

Communication with the E6630A Test Set	38
E6630A Port Configuration	39
Test Set Input Port	39

Test Set Output Port	39
E6618A Port Configuration	40
Multiport Adapter	40
Multiport Adapter RFIO Input Port	41
Multiport Adapter GNSS Input	41
Multiport Adapter RFIO Output Ports	42
Multiport Adapter GNSS Output Ports	43
Multiport Adapter Duplex Mode	44
Corrections	46
Select Correction	47
Correction On/Off	48
Properties	49
Edit	63
Delete Correction	68
Apply Corrections	69
Delete All Corrections	70
Remote Correction Data Set Commands	71
Recall Amplitude Correction	73
E6618A FPGA Version	74

4 Troubleshooting

Check the Basics	76
Checking the E6618A	76
Checking the E6630A Test Set	76
Verifying the Multiport Adapter is Recognized by the E6630A	78

5 Verification

About the Verification Procedures	84
Purpose	84
E6630A Requirements	84

System Requirements	84
Verify E6630A Source Output	85
Verify E6618A RFIO 0 and RFIO 1 Ports	87
Verify Other E6618A Port Configurations	89
Verify GNSS Ports	90
System Verification Complete	91
Returning an Instrument for Service	92
Calling Agilent Technologies	92
Read the Warranty	92
Service Options	92
Locations for Agilent Technologies	92
Packaging the Instrument	94

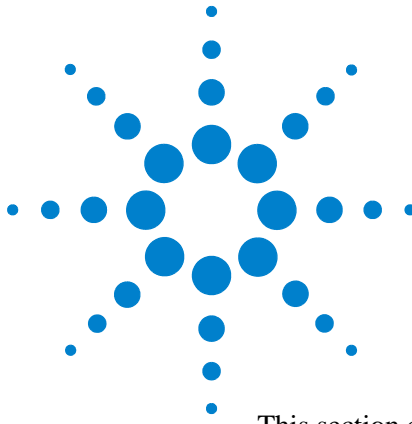

1 Quick-Start

This section explains how to initialize the multiport adapter.

The following topics can be found in this section:

[“About the Multiport Adapter”](#) on page 10

[“Instrument Location and Rack Mounting Requirements”](#) on page 13

[“Turning on the Instrument the First Time”](#) on page 20

[“Instrument Information”](#) on page 14

About the Multiport Adapter

The E6618A Multiport Adapter is designed to be used in conjunction with the E6630A Wireless Connectivity Test Set. (As the multiport adapter can only connect to one test set output and one test set input, a second multiport adapter is needed if the test set includes both the left and right instruments.)

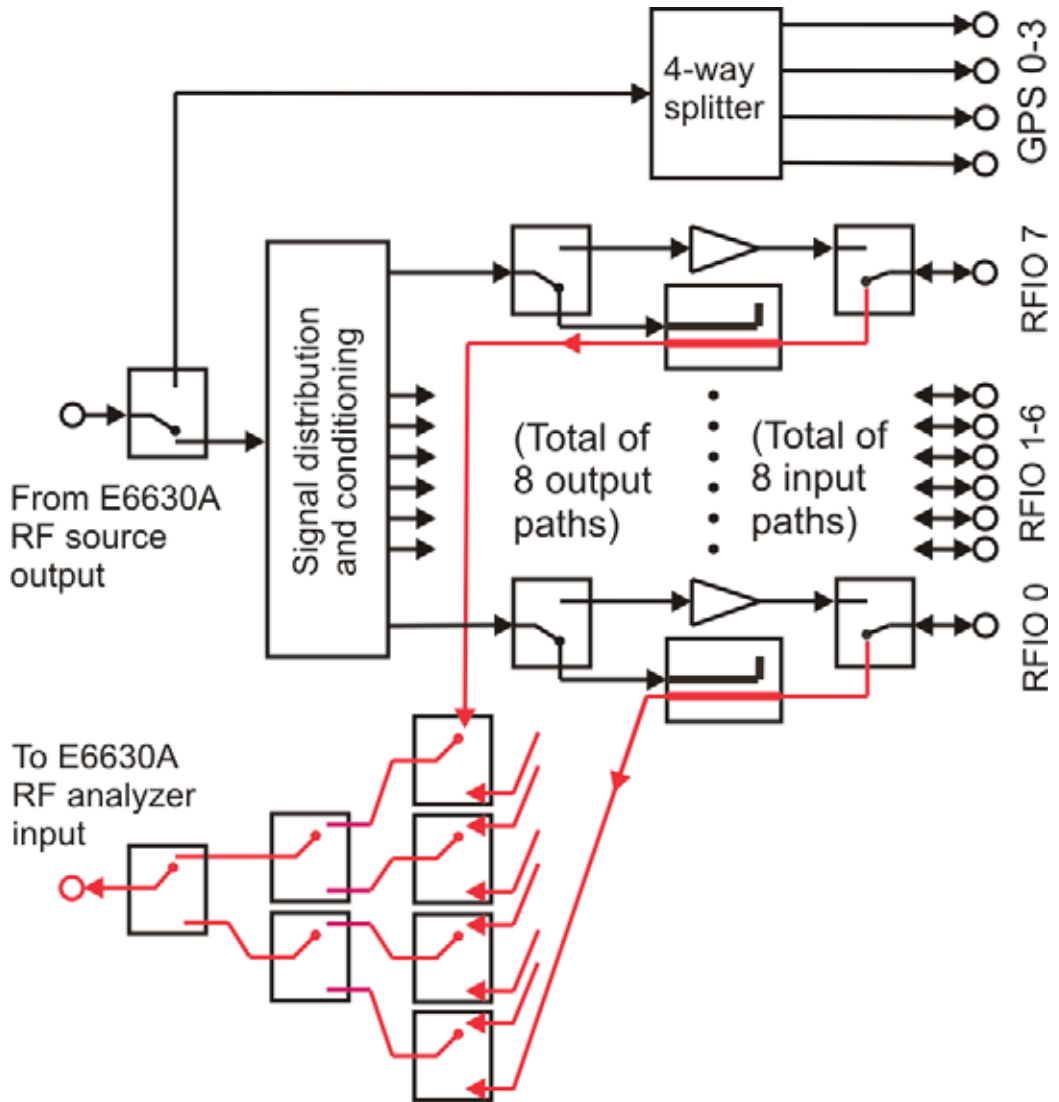

The multiport adapter splits the downlink RF signal from the test set’s source into 8 RF output paths. All eight output paths can be active at once, or the user can activate a subset of them in any desired combination. Each path interfaces to an RFIO port through a coupler, so that the RFIO port can also return an uplink signal to the analyzer in the test set. (Usually an RFIO port is either an input or an output at any given time, but in LTE-FDD applications it can serve as both at once.) The coupler in the RF output path

can be bypassed by a high-power output-only path (this output-only path cannot be selected directly by the user; it is activated automatically, as needed, during LTE-TDD measurements).

Alternatively, the downlink RF signal from the test set's source can be sent through a 4-way splitter to the four GNSS outputs of the multiport adapter. (This path *can* be selected directly by the user.)

Each of the 8 RF Uplink RF signals from the DUT is directed back to the test set through one of the 8 selectable RF input paths. Each path leads through a coupler to a set of RF switches, and is returned to the test set's analyzer.

NOTE

Downlink and uplink signals are handled slightly differently by the multiport adapter. Downlink signals from the test set's source are split so as to provide a stimulus output to as many as 8 ports at the same time. Uplink signals to the test set's analyzer, however, are switched rather than split, and at a given time the analyzer receives an input from only one of the 8 RFIO ports of the multiport adapter.

Initial Inspection

Inspect the shipping container and the cushioning material for signs of stress. Retain the shipping materials for future use, as you may wish to ship the instrument to another location or to Agilent Technologies for service.

Verifying the Contents

Item	Deliverable	Description
Getting Started Guide		Provides first-time power on instructions, licensing information, operating system information, and general hardware information.
Quick Start Poster		Unpacking and setup illustration.
RF Cables, SMA to Type N (2)		For connection between RF ports of E6630A Test Set and E6618A Multiport Adapter.
BNC Cables (4)		For connection between Trigger ports of E6630A Test Set and E6618A Multiport Adapter.
USB Cable		For USB interface connection between E6630A Test Set and E6618A Multiport Adapter.
Power cable		Connection for instrument power.

Shipping Problems?

If the shipping materials are damaged or the contents of the container are incomplete:

- Contact the nearest Agilent Technologies office.
- Keep the shipping materials for the carrier's inspection.
- If you must return an instrument to Agilent Technologies, use the original (or comparable) shipping materials. See ["Returning an Instrument for Service"](#) on page 92.

Instrument Location and Rack Mounting Requirements

Weight and Dimensions

- Weight: 12 lbs 7 oz (5.64 kg)
- Height: 1.75 inches (44 mm)
- Width: 14.5 inches (368 mm)
- Depth: 16.25 inches (413 mm)

Locating the instrument

The multiport adapter is used with the E6630A test set, and typically is placed directly below the test set.

Cooling and rack mounting

Make sure that the air inlets on the top of the instrument and the fan exhaust vents on the back of the instrument are not obstructed. The minimal required clearance is 2 inches (51 mm) in the back, and 0.17 inches (4.4 mm) on the top. In benchtop use, the plastic feet of the E6618A provide adequate clearance above the E6630A test set; if the two instruments are rack-mounted, make sure that at least 4.4 mm of clearance is provided. Airflow restrictions cause additional airflow noise and interfere with cooling.

CAUTION

When installing the product in a cabinet, the convection into and out of the product must not be restricted. The ambient temperature (outside the cabinet) must be less than the maximum operating temperature of the product by 4° C for every 100 watts dissipated in the cabinet. If the total power dissipated in the cabinet is greater than 800 watts, then forced convection must be used.

Power Disconnection

Install the instrument so that the detachable power cord is readily identifiable and is easily reached by the operator. The detachable power cord is the instrument disconnecting device. It disconnects the mains circuits from the mains supply before other parts of the instrument. The front panel switch is only a standby switch and is not a LINE switch. Alternatively, an externally installed switch or circuit breaker (which is readily identifiable and is easily reached by the operator) may be used as a disconnecting device.

Instrument Information

WARNING

No operator serviceable parts inside. Refer servicing to qualified personnel. To prevent electrical shock do not remove covers.

Power requirements

The only physical installation of your Agilent multiport adapter is a connection to a power source. Line voltage does not need to be selected. Supply requirements are as follows:

- Voltage: 100/120/220/240 VAC
- Frequency: 50/60 Hz
- Power: 100 W

This instrument does *not* contain customer serviceable fuses.

WARNING

This is a Safety Class 1 Product (provided with a protective earthing ground incorporated in the power cord). The mains plug shall only be inserted in a socket outlet provided with a protective earth contact. Any interruption of the protective conductor inside or outside of the product is likely to make the product dangerous. Intentional interruption is prohibited. (IEC 348 clauses 17.3.3c & 17.3.4)

Failure to ground the instrument properly can result in personal injury. Before turning on the instrument, you must connect its protective earth terminals to the protective conductor of the main power cable. Insert the main power cable plug into a socket outlet that has a protective earth contact only. DO NOT defeat the earth-grounding protection by using an extension cable, power cable, or autotransformer without a protective ground conductor.

CAUTION

This instrument has autoranging line voltage input. Be sure the supply voltage is within the specified range, that voltage fluctuations do not exceed 10 percent of the nominal supply voltage, and that the supply voltage line has a service breaker of the correct rating.

The Mains wiring and connectors shall be compatible with the connector used in the premise electrical system. Failure, to ensure adequate earth grounding by not using the correct components may cause product damage, and serious injury.

AC power cord

The instrument is equipped with a three-wire power cord, in accordance with international safety standards. This cable grounds the instrument cabinet when connected to an appropriate power line outlet. The cable appropriate to the original shipping location is included with the instrument. See:

<http://www.agilent.com/find/powercords>

CAUTION

Always use the three-prong AC power cord supplied with this product. Failure to ensure adequate earth grounding by not using this cord can cause product damage.

WARNING

If this product is not used as specified, the protection provided by the equipment could be impaired. This product must be used in a normal condition (in which all means for protection are intact) only. Install the instrument so that the detachable power cord is readily identifiable and easily reached by the operator. The detachable power cord is the instrument disconnecting device. It disconnects the mains circuits from the mains supply before other parts of the instrument. The front panel switch is only a standby switch and is not a LINE switch. Alternatively, an externally installed switch or circuit breaker (which is readily identifiable and is easily reached by the operator) may be used as a disconnecting device.

Environmental Conditions (Operating)

This product is designed for use in the following conditions:

- For indoor use only
- Altitude up to 2000 meters
- Temperature up to 50 degrees C
- Maximum relative humidity 80% for temperatures up to 31 degrees C, decreasing linearly to 50% relative humidity at 40 degrees C.

CAUTION

This product is designed for use in Installation Category II and Pollution Degree 2 per IEC 61010 Third Edition.

Protecting Against Overpowering

The input circuitry of the instrument can be damaged by applying signals that exceed the maximum safe input level. Repairing damage to the input circuitry can be expensive.

For the RF In and RF Out ports, the maximum safe input level is 0.25 W (+24 dBm), ± 15 Vdc.

For the eight RF I/O ports, the maximum safe input level is 2 W (+33 dBm), ± 15 Vdc.

When the multiport adapter is used with the E6630A test set, the E6630A automatically adjusts its output level to avoid overpowering the multiport adapter; this does not require any intervention by the user.

Instrument Maintenance

Cleaning the instrument

WARNING To prevent electrical shock, disconnect the E6618A from mains before cleaning. Use a dry cloth or one slightly dampened with water to clean the external case parts. Do not attempt to clean internally.

Cleaning Connectors

Cleaning connectors with alcohol shall only be done with the instrument power cord removed, and in a well-ventilated area. Allow all residual alcohol moisture to evaporate, and the fumes to dissipate prior to energizing the instrument.

WARNING Keep isopropyl alcohol away from heat, sparks, and flame. Store in a tightly closed container. It is extremely flammable. In case of fire, use alcohol foam, dry chemical, or carbon dioxide; water may be ineffective.

Use isopropyl alcohol with adequate ventilation and avoid contact with eyes, skin, and clothing. It causes skin irritation, may cause eye damage, and is harmful if swallowed or inhaled. It may be harmful if absorbed through the skin. Wash thoroughly after handling.

In case of spill, soak up with sand or earth. Flush spill area with water.

Dispose of isopropyl alcohol in accordance with all applicable federal, state, and local environmental regulations.

Protecting against electrostatic discharge

Electrostatic discharge (ESD) can damage or destroy electronic components (the possibility of unseen damage caused by ESD is present whenever components are transported, stored, or used).

Test equipment and ESD

To help reduce ESD damage that can occur while using test equipment:

WARNING Do not use these first three techniques when working on circuitry with a voltage potential greater than 500 volts.

- Before connecting any coaxial cable to an instrument connector for the first time each day, momentarily short the center and outer conductors of the cable together.
- Personnel should be grounded with a 1 M Ω resistor-isolated wrist-strap before touching the center pin of any connector and before removing any assembly from the instrument.
- Be sure that all instruments are properly earth-grounded to prevent build-up of static charge.
- Perform work on all components or assemblies at a static-safe workstation.
- Keep static-generating materials at least one meter away from all components.
- Store or transport components in static-shielding containers.
- Always handle printed circuit board assemblies by the edges. This reduces the possibility of ESD damage to components and prevent contamination of exposed plating.

Additional information about ESD

For more information about ESD and how to prevent ESD damage, contact the Electrostatic Discharge Association (<http://www.esda.org>). The ESD standards developed by this agency are sanctioned by the American National Standards Institute (ANSI).

Regulatory Compliance

This instrument is in compliance with the following standards:

- CAN/CSA 22.2 No. 61010-1-12
- UL Std. 61010-1 (3rd Edition)
- IEC 61010-1:2010/EN61010-1:2010 (3rd Edition)

EMC Compliance

Complies with the European EMC Directive 2004/108/EC

- IEC/EN 61326-1:2005
- CISPR Pub 11 Group 1, Class A
- AS/NZS CISPR11:2004
- ICES/NMB-001:2006

Compliance with German Noise Requirements

This is to declare that this instrument is in conformance with the German Regulation on Noise Declaration for Machines (Laermangabe nach der Maschinenlaermrerordnung -3.GSGV Deutschland).

Acoustic Noise Emission/Geraeuschemission

LpA <70 dB Operator position Normal position per ISO 7779	LpA <70 dB am Arbeitsplatz normaler Betrieb nach DIN 45635 t.19
--	--

Compliance with Canadian EMC Requirements

This ISM device complies with Canadian ICES-001.
Cet appareil ISM est conforme à la norme NMB-001 Canada.

Turning on the Instrument the First Time

The procedures given below (“Checking the E6630A Test Set” on page 20, “Connecting the Multiport Adapter to the E6630A and Other Devices” on page 21, “Initializing the Multiport Adapter” on page 24, and “Verifying the FPGA Code Version in the Multiport Adapter” on page 27) perform the following tasks.

- Verify E6630A functionality.
- Update the E6630A instrument software to a version compatible with the E6618A.
- Connect the E6618A to the E6630A as a system, and verify basic functionality of the system.
- Perform the E6618A FPGA synchronization.

It is important to follow all steps in the order they are given below, so that the Multiport Adapter (E6618A) communicates properly with the E6630A Wireless Communication Test Set.

Checking the E6630A Test Set

The E6618A is designed for use with the E6630A Wireless Connectivity Test Set. If the E6630A PXI rack is fully loaded, it can actually include two source/analyzer test sets (they share a reference module, but are otherwise independent). The two test sets are referred to as the left and right sub-instruments. When the E6630A is used in combination with the E6618A Multiport Adapter, each of the sub-instruments is connected to its own E6618A.

The E6630A and its Sub-instruments

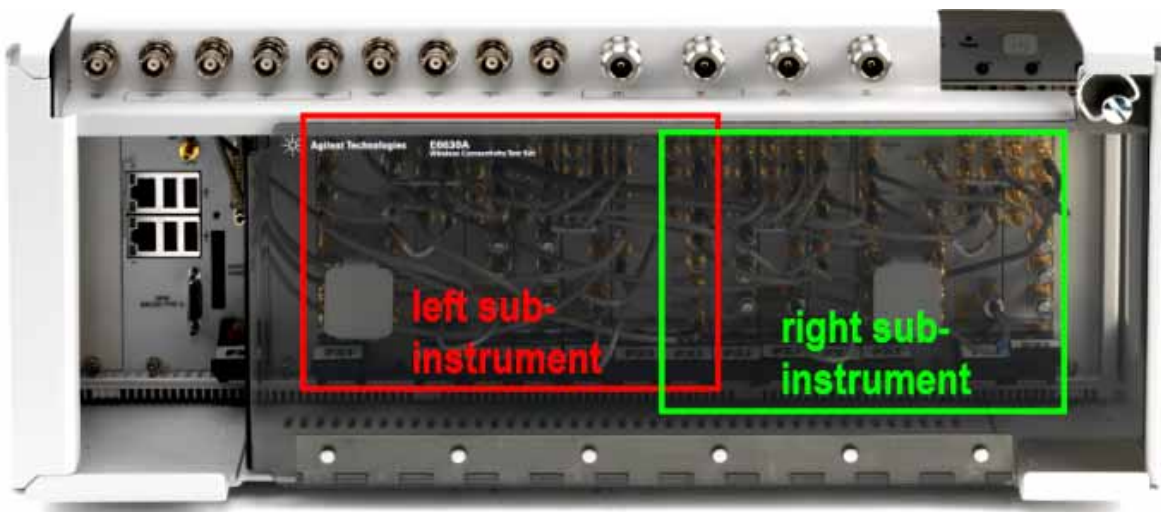

Steps	Actions	Notes
1 Make sure the E6630A is powered on and fully booted.	<p>a The E6630A includes no display screen, and its user interface must be viewed using an external monitor.</p> <p>b To access menu control keys, right-click in the XSA application window, and on the menu which appears, highlight Utility and select Virtual Front Panel.</p>	<ul style="list-style-type: none"> Documentation for the E6630A is available for download at this site: http://www.agilent.com/find/e6630a
2 Check for error messages on the E6630A.	<p>a See the MSG field at the bottom of the E6630A virtual front panel display.</p> <p>b Verify that no error messages are shown.</p>	<ul style="list-style-type: none"> The E6630A source output must be functioning properly. The E6630A receiver inputs must be functioning properly.

Connecting the Multiport Adapter to the E6630A and Other Devices

Connections to and from the Multiport Adapter are listed in the table below and illustrated in the front-panel view which follows it.

CAUTION

Use proper care when connecting the RF cables. **Do not** finger-tighten the Type-N connector on the E6630A and then rotate the cable to align the SMA connector on the E6618A. Instead, pre-align the Type-N connector on the cable by holding it directly in front of the connector on the E6630A. At the same time, pre-align the SMA connector on the cable by holding it directly in front of the connector on the E6618A. Slowly finger-tighten the Type-N connector on the E6630A first; then slowly finger-tighten the SMA connector on the E6618A. Torque the Type-N connector to 12 in-lbs, and the SMA connector to 8 in-lbs.

Steps	Actions	Notes
1 Connect the RF input of the Multiport Adapter.	<ul style="list-style-type: none"> With power OFF to the E6630A Test Set and the E6618A Multiport Adapter, connect the RF OUT port on top of the impact cover of the E6630A to the RF IN port on the front panel of the Multiport Adapter. 	<p>Use the supplied RF cable.</p> <p>The E6630A has separate RF OUT ports for the left and right subinstruments; see “Connecting E6618A & E6630A (Left Sub-Instrument)” on page 23 and “Connecting E6618A & E6630A (Right Sub-Instrument)” on page 23.</p>

1 Quick-Start

Steps	Actions	Notes	
2	Connect the RF output of the Multiport Adapter.	<ul style="list-style-type: none"> Connect the RF IN port on top of the impact cover of the E6630A to the RF OUT port on the front of the E6618A. 	<p>Use the supplied RF cable.</p> <p>The E6630A has separate RF OUT ports for the left and right subinstruments; see “Connecting E6618A & E6630A (Left Sub-Instrument)” on page 23 and “Connecting E6618A & E6630A (Right Sub-Instrument)” on page 23.</p>
3	Connect the USB interface of the Multiport Adapter.	<ul style="list-style-type: none"> Connect one of the USB ports on the front of the Controller module on the left side of the E6630A to the USB port on the front of the Multiport Adapter. 	<p>Use the supplied USB cable.</p>
4	Connect the Trigger ports of the Multiport Adapter.	<ul style="list-style-type: none"> Connect the TRIG 3 port on the top of the impact cover of the E6630A to the TRIG 3 port on the front of the panel of the E6618A. 	<p>Use the supplied BNC cable. (The other trigger connectors on the front panel of the E6618A are not currently used.)</p> <p>The E6630A has separate TRIG 3 ports for the left and right subinstruments; see “Connecting E6618A & E6630A (Left Sub-Instrument)” on page 23 and “Connecting E6618A & E6630A (Right Sub-Instrument)” on page 23.</p>
NOTE:	No cables should be connected to any of the eight RFIO ports on the front panel of the Multiport Adapter at this time.		
5	Power on the E6630A.	<ul style="list-style-type: none"> Wait for a full boot-up in IQ Analyzer Mode. 	<p>After boot-up, the display as shown in “E6630A Boot-up in IQ Analyzer Mode” on page 22.</p>

E6630A Boot-up in IQ Analyzer Mode

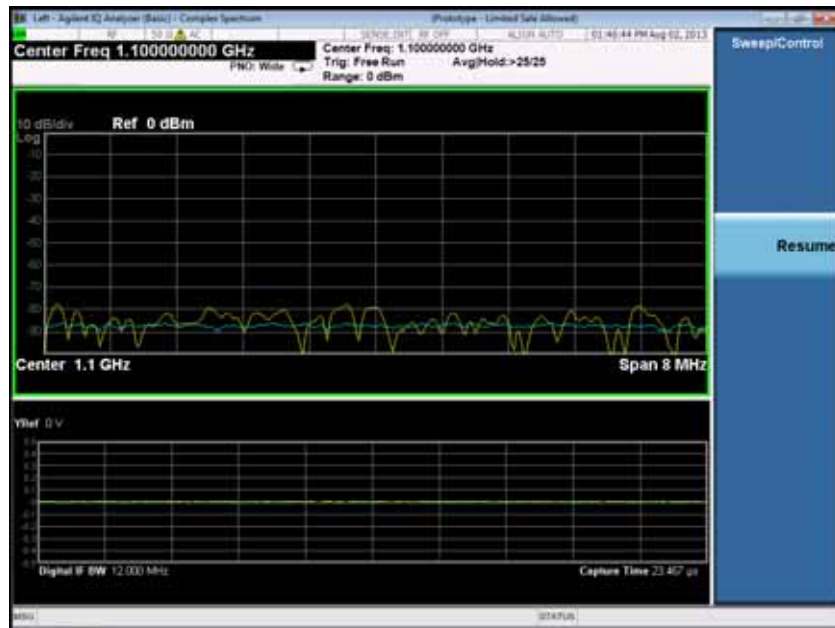

Figure 2-1 Connecting E6618A & E6630A (Left Sub-Instrument)

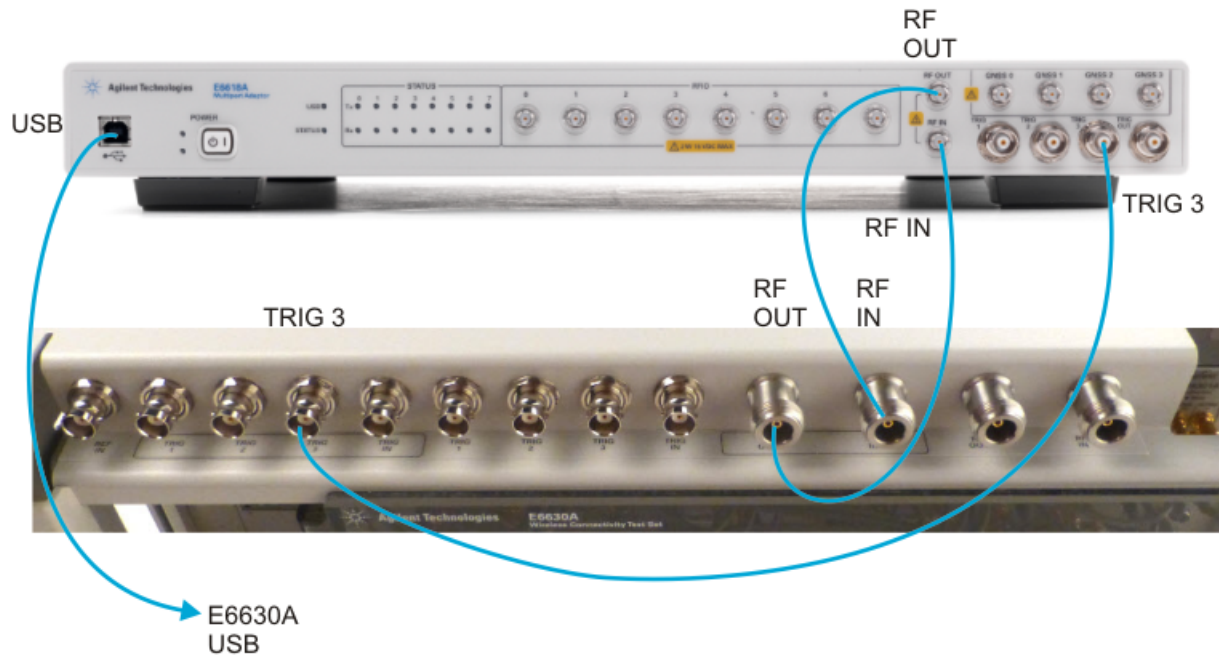
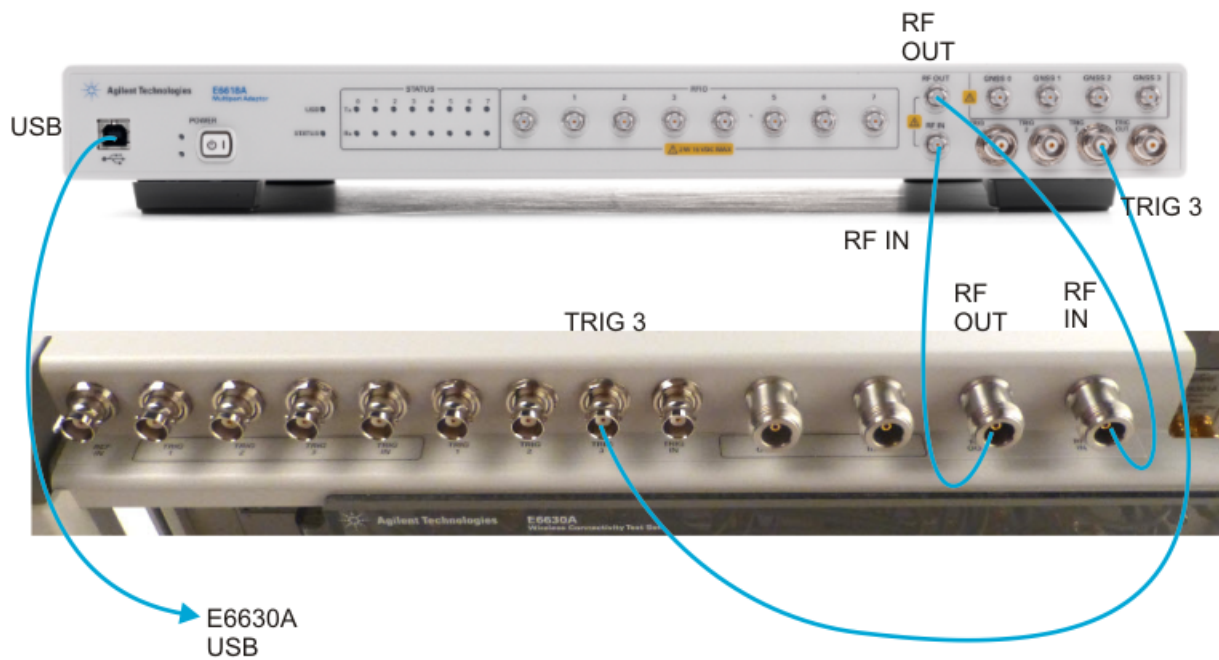

Figure 2-2 Connecting E6618A & E6630A (Right Sub-Instrument)



Initializing the Multiport Adapter

Steps	Actions	Notes
1 Power on the Multiport Adapter	<p>a Position the E6618A Multiport Adapter so that you have easy access to the power cord, and plug it in.</p> <p>b Press the power button on the front panel of the E6618A to turn the instrument on.</p>	When you plug in power to the instrument, the yellow “standby” indicator should be lit. After you have pressed the power switch, the green “power on” indicator should be lit.
2 Wait for the Multiport Adapter to complete its initialization process	<ul style="list-style-type: none"> • There is a brief (<1 minute) initialization interval for the Multiport Adapter. 	<ul style="list-style-type: none"> • During this interval, while data is being downloaded to the E6630A, all of the Status LEDs on the Multiport Adapter are lit, and “Hardware Configuration Updating” is displayed on the E6630A virtual front panel. • After the initialization interval, when the “USB ” indicator is lit (and the “FAULT” indicator is not lit), the Multiport Adapter is communicating properly with the E6630A, and is ready for use.
3 If there is more than one sub-instrument in the E6630A Test Set, and more than one E6618A, you must pair one sub-instrument with one E6618A. On the Start menu of the E6630A operating system, select E6618A MPA Assignment Tool .	<p>a In the right pane of the Assignment Tool window, click the Model/Serial number button for the Left sub-instrument, and select the serial number of the E6618A from the selector dialog</p> <p>b Repeat for the Right sub-instrument, selecting a different E6618A.</p> <p>c Click Save Configuration and close the window.</p>	<ul style="list-style-type: none"> • If there is only a single sub-instrument installed in the PXIe rack of the E6630A, the default assignment (that is, with the left sub-instrument set to “Any” and the right sub-instrument set to “None”) is sufficient. • E6618A multiport adapters are identified by serial number in this interface; check the serial number sticker on the rear panel of the E6618A if you are uncertain of the instrument identification.

Steps	Actions	Notes
-------	---------	-------

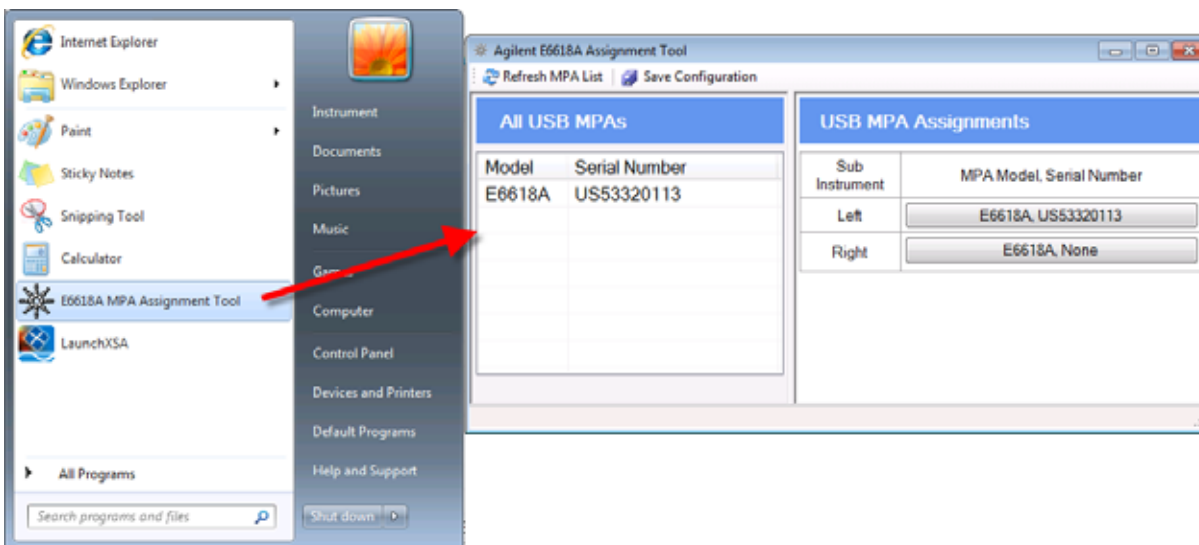

- | | | |
|--|---|--|
| 4 Restart the E6630A measurement application | <p>a On the Virtual Front Panel of the E6630A, close down the test set's measurement application by selecting File, Exit.</p> <p>b Launch the E6630A measurement application by selecting Launch XSA from the desktop.</p> | <ul style="list-style-type: none"> The measurement application on the E6630A must be restarted after making E6618A assignments, because these assignments are checked only upon startup of the application; a new assignment does not take effect until then. |
| 5 Confirm that the E6630A is recognizing the Multiport Adapter hardware. | <p>a Press System, Show, Hardware on the E6630A front panel (see the illustration below).</p> <p>b Verify that "Multi-Port Adapter" is listed in the Assembly Name column; this designates the Multiport Adapter hardware.</p> | <p>The Part #, Serial #, Mat'l Rev, Rev, OF Rev and HW Id columns for the Multiport Adapter hardware should also be populated.</p> <p>Note: if the Multiport Adapter is not listed, a possible reason for the problem is that the E6630A is running an older revision of instrument software; see "Checking the E6630A Test Set" on page 20. For additional information on troubleshooting a hardware-recognition problem, see "Checking the E6630A Test Set" on page 76.</p> |

1 Quick-Start

Steps	Actions	Notes
-------	---------	-------

Hardware Information

Agilent E6630A Wireless Connectivity Test Set
Product Number: E6630A
Serial Number: US000000001
Instrument SW Revision: A.13.80_P0062

Assembly Name	Part #	Serial #	Matl Rev	Rev	OF Rev	Hw Id
Multi-Port Adaptor	E661863001	79131604451	003	0	A	98

6

Verifying the FPGA Code Version in the Multiport Adapter

There is FPGA (Field Programmable Gate Array) program code on the RFIO board that resides within the E6618A; this code must be compatible with the instrument software version of the E6630A to which the E6618A is connected. If the FPGA code is not compatible, it must be updated.

Once the E6618A RFIO board FPGA code is up to date, that particular E6618A can be used with any E6630A that has the most current instrument software version.

If the E6618A is connected to the E6630A via USB when an E6630A instrument software update is performed, the RFIO board FPGA will be automatically updated through the instrument software update process.

CAUTION

Once you start the FPGA programming process you MUST NOT interrupt the process (for example, by turning either of the instruments off, or by unplugging the power cords to either of the instruments), for any reason. Doing so will cause either or both of the instruments to become inoperative, requiring replacement of the affected assemblies.

Steps	Actions	Notes
1 Check the error queue.	Press System, Show, Errors using the E6630A virtual front panel keys.	
2 Determine if the FPGA code needs updating.	<p>a Look for the error “-240 Hardware Error, Unmatched multiport adapter FPGA version...”.</p> <p>b If this error is present in the queue, and the time/date stamp matches the approximate time when the Multiport Adapter was last powered on, the FPGA code needs to be updated.</p>	If the FPGA code does not need to be updated, skip the remainder of this procedure.
3 Close the E6630A application software.	Press File, Exit, OK using the E6630A virtual front panel keys.	
4 Connect a mouse and keyboard to the E6630A.	Connect a USB mouse and keyboard to one of the front panel USB ports of the E6630A.	
5 Log off.	Using the mouse, click Start, Shut Down, Log Off .	
6 Log in.	Select “administrator”. Click OK .	The default password is “agilent4u”.

1 Quick-Start

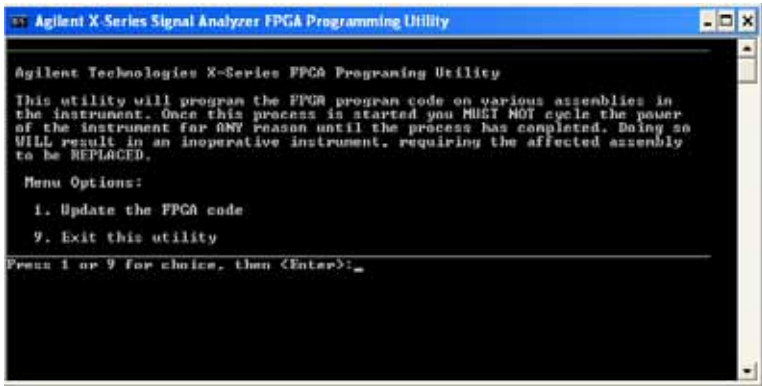
Steps	Actions	Notes
7	Go to the Physics folder. From the Start menu, select Computer and navigate to the Physics folder.	The path is: C:\Program Files\Agilent\ SignalAnalysis\Physics
8	Execute the batch file. In the Physics folder, find and execute the FPGA batch file.	The file name is: FPGA_Prog.bat
9	Wait for the window to appear. The FPGA Programming Utility starts, and a window is displayed:	
10	Program the FPGA code. Type 1 and press Enter .	
11	Begin FPGA program utility. Type 1 and press Enter .	(It is necessary to make this second confirmation in order to make the utility run.)
12	Wait for the FPGA programming to complete. The programming of the FPGA code could take a few minutes to complete. Once it has finished, the instrument will reboot itself to use the new code.	

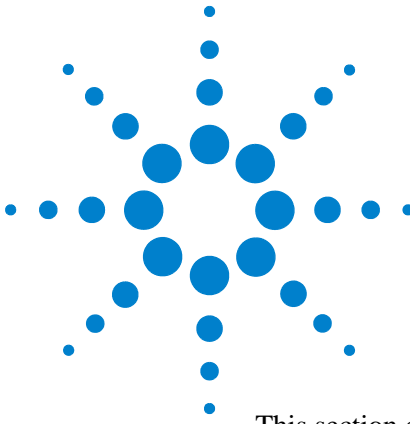

2 Front and Rear Panel Features

This section describes the following features:

“Front-Panel Features” on page 30

“Rear-Panel Features” on page 32

“Test Set Display Indicators” on page 33

“Front and Rear Panel Symbols” on page 34

Front-Panel Features

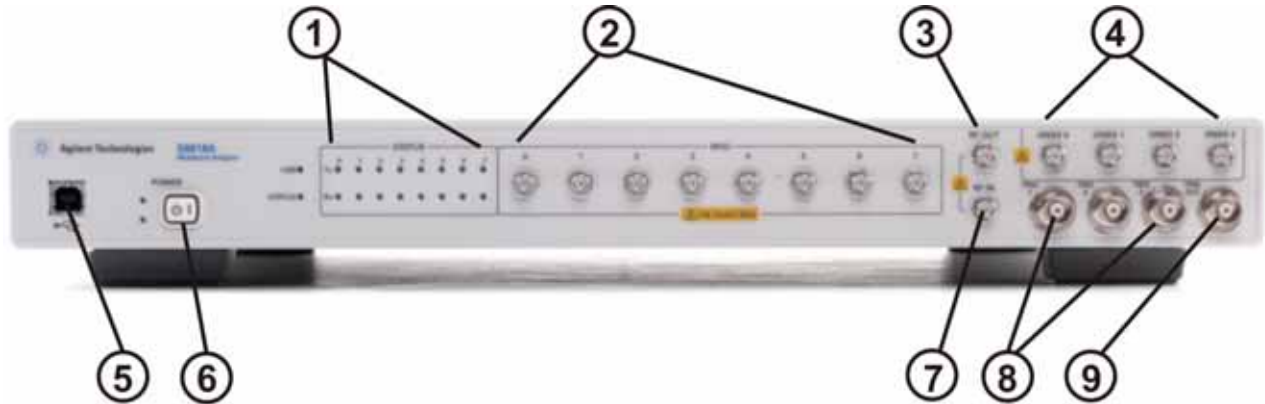

Item		Description
#	Name	
1	Status Indicators	<p>Lights indicating the status of the instrument</p> <ul style="list-style-type: none"> • USB CONNECT. This green LED lights to indicate that a USB connection has been established to the E6630A test set. (This requires that either the left or right sub-instrument of the E6630A has been assigned to the E6618A, using the E6618A Assignment Tool.) • STATUS. This yellow LED lights to indicate a problem in communication with the E6630A (for example, FPGA incompatibility between the two instruments); query the E6630A error queue to find out the nature of the problem. • Tx 0 - 7 (these light to indicate that the relevant RFIO ports are being used to transmit RF outputs to the connected DUTs). • Rx 0 - 7 (these light to indicate that the relevant RFIO ports are being used to receive RF inputs from the connected DUTs). <p>NOTE There are no indicators for the GNSS ports, because the ports cannot be switched on or off. Whatever RF input is provided to the GNSS splitter by way of the RF IN port is always split and delivered to the GNSS 0 - 3 ports.</p>
2	RFIO, Ports 0 - 7	Eight SMA connectors which provide RF input and output connections to DUTs. The maximum safe input level at any of these ports is 2 W (+33 dBm), ± 15 Vdc.
3	RF OUT	SMA connector which provides an RF output to the E6630A test set. The maximum safe reverse input level at this port is 0.25 W (+24 dBm), 0Vdc.
4	GNSS, Ports 0 - 3	Three SMA connectors which provide RF input and output connections to DUTs. The maximum safe input level at any of these ports is 0.25 W (+24 dBm), 0Vdc. Because GNSS Ports 0 - 3 are the outputs of a four-way splitter, the maximum output power levels from these ports are lower than for RFIO Ports 0 - 7; see the E6618A data sheet for specifics.
5	USB Connector	USB 2.0 port, Type B. USB TMC (test and measurement class); connects to the E6630A test set.

Item		Description
#	Name	
6	POWER Standby/ On	<p>Turns the instrument on. A green light indicates power on. A yellow light indicates standby mode.</p> <p>NOTE The front-panel switch is a standby switch, <i>not</i> a LINE switch (disconnecting device). The instrument continues to draw power even when the line switch is in standby.</p> <p>The main power cord can be used as the system disconnecting device. It disconnects the mains circuits from the mains supply.</p>
7	RF IN	SMA connector which accepts an RF input from the E6630A test set. The maximum safe input level at this port is 0.25 W (+24 dBm), 0 Vdc.
8	TRIG 1, TRIG 2, TRIG 3	<p>The TRIG 1 and TRIG 2 BNC connectors are reserved for future use.</p> <p>The TRIG 3 BNC connector receives a TTL trigger input from the TRIG 3 BNC connector on top of the impact cover on the E6630A. (Under the impact cover, this is routed to the Trig 2 connector of the M9310A Source Output module of the relevant sub-instrument in the E6630A.) This connection is needed when the Multiport Adapter Duplex Mode is set to “TDD Triggered”.</p>
9	TRIG OUT	This BNC connector is reserved for future use.

Rear-Panel Features



Item		Description
#	Name	
1	Line power input	The AC power connection. See the product specifications for more details.
2	Fans	Cooling fan exhaust. To avoid overheating of the instrument, make sure that airflow from the fans is not obstructed.

Test Set Display Indicators

The front panel display of the E6630A Test Set includes, in the measurement bar, a field (outlined in the illustration below) which indicates the state of the internal source. When the test set is used with the Multiport Adapter, this display is modified to indicate which output ports of the Multiport Adapter (if any) are supplying RF output power.



The table below illustrates the content of this field under different circumstances.

Multiport Adapter Usage	RF On	RF Off
Any or all of the 8 “RFIO” ports are in use.	RF ON MPA	RF OFF MPA
The 4 “GNSS” ports are in use.	RF ON MPA-G	RF OFF MPA-G
Multiport Adapter is not in use.	RF ON	RF OFF

Front and Rear Panel Symbols



This symbol is used to indicate power ON (green LED).



This symbol is used to indicate power STANDBY mode (yellow LED).



This symbol indicates the input power required is AC.



The instruction documentation symbol. The product is marked with this symbol when it is necessary for the user to refer to instructions in the documentation.



The CE mark is a registered trademark of the European Community.



The C-Tick mark is a registered trademark of the Australian Spectrum Management Agency.

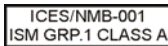

This is a marking of a product in compliance with the Canadian Interference-Causing Equipment Standard (ICES-001).

This is also a symbol of an Industrial Scientific and Medical Group 1 Class A product (CISPR 11, Clause 4).



The CSA mark is a registered trademark of the Canadian Standards Association International.



South Korean Class A EMC Declaration
A 급 기기 (업무용 방송통신기자재)

이 기기는 업무용 (A 급) 전자파적합기기로서 판매자 또는 사용자는 이 점을 주의하시기 바라 며, 가정외의 지역에서 사용하는 것을 목적으로 합니다.

This equipment is Class A suitable for professional use and is for use in electromagnetic environments outside of the home.



This symbol indicates separate collection for electrical and electronic equipment mandated under EU law as of August 13, 2005. All electric and electronic equipment are required to be separated from normal waste for disposal (Reference WEEE Directive 2002/96/EC).



The EPUP (Environmental Protection Use Period) indicates the time period (in years) during which no hazardous or toxic substance elements are expected to leak or deteriorate during normal use. Forty years is the expected useful life of the product.



This symbol designates a USB 2.0 port.



This symbol indicates compliance with China RoHS regulations for paper/fiberboard packaging.

To return unwanted products, contact your local Agilent office, or see <http://www.agilent.com/environment/product/> for more information.

2 Front and Rear Panel Features

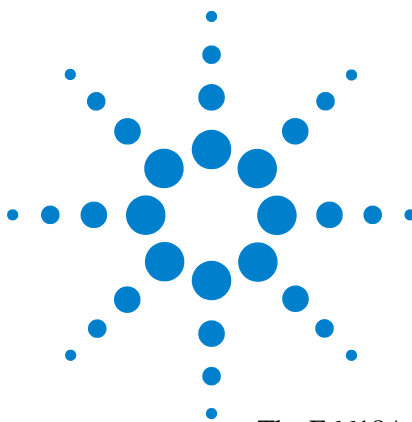

3 Instrument Operation

The E6618A Multiport Adapter has no user interface of its own. The E6618A is operated by way of the E6630A test set which is connected to it and which controls it.

This chapter includes the following sections:

- "[Communication with the E6630A Test Set](#)" on page 38
- "[E6630A Port Configuration](#)" on page 39
- "[E6618A Port Configuration](#)" on page 40
- "[Corrections](#)" on page 46
- "[E6618A FPGA Version](#)" on page 74



Communication with the E6630A Test Set

To use the E6618A, you must first connect it to the E6630A Wireless Communication Test Set, as described in ["Turning on the Instrument the First Time"](#) on page 20. The E6618A is controlled and configured by controlling and configuring the test set, either by issuing remote commands or by using menu keys.

The test set communicates with the E6618A over a USB interface. Once the USB connection is established, certain keys on the test set's menus which relate to the E6618A become visible in the E6630A's virtual front panel interface.

RF ports of the E6618A are configured by means of settings made within the **Input/Output** menu of the E6630A. See ["E6630A Port Configuration"](#) on page 39 and ["E6618A Port Configuration"](#) on page 40 for more information.

The E6630A can apply Amplitude Corrections that are specific to the E6618A. See ["Corrections"](#) on page 46.

E6630A Port Configuration

Test Set Input Port

Other test sets have multiple ports which could potentially be selected as the RF Input port, so the **Input/Output** menu includes an **RF Input** selection (the equivalent command is `[SENSE]:FEED:RF`). However, in the E6630A test set, there is only one RF Input port and only one configuration for it (apart from the impedance setting), and it is always selected.

Test Set Output Port

The RF output port of the test set can be configured in either of two ways, depending on how the Multiport Adapter is being used:

- To use any or all of the eight "RFIO" ports on the Multiport Adapter, select **RF Output** under **Input/Output, More, RF Output & Test Set Config, RF Output**. The equivalent command is:
`[SENSE]:FEED:RF:PORT:OUTPut RFOut`
- To use the "GNSS" ports on the Multiport Adapter, select **GNSS Output** under **Input/Output, More, RF Output & Test Set Config, RF Output**. The equivalent command is:
`[SENSE]:FEED:RF:PORT:OUTPut GNSSout`

NOTE

Whenever **Input/Output, More, RF Output & Test Set Config, RF Output** is set to **GNSS Output**, all of the "GNSS" ports of the Multiport Adapter are active. It is not possible to switch individual GNSS ports on or off.

E6618A Port Configuration

To configure the E6618A, go to the **Input/Output, More, RF Output & Test Set Config, Multiport Adapter** to open the relevant menu.

The menu choices allow you to make the E6618A active (by setting **Multiport Adapter** to On), select an **Input Port**, and set up the **Output Port**. These settings are described in detail below.

Multiport Adapter

Even when the E6618A Multiport Adapter is connected to the test set, it is not available for use unless **Multiport Adapter** is set to the ON state. Press **Input/Output, More, RF Output & Test Set Config, Multiport Adapter**, and toggle the **Multiport Adapter** key to select On or Off. When Off is selected, the E6618A is not active, and other menu keys pertaining to the E6618A have no effect.

Key Path	Input/Output, More, RF Output & Test Set Config, Multiport Adapter
Remote Command	[:SENSE] :MPADapter [:STATe] ON OFF 1 0 [:SENSe] :MPADapter [:STATe] ?
Example Command	:MPAD ON
Dependencies	If the E6618A Multiport Adapter is not connected to the test set by means of a USB interface, this menu selection is not displayed and is set to the OFF state.
Preset	Not affected by a Preset. Set to OFF by pressing System > Restore Defaults > Input/Output Settings or System > Restore Defaults > All .

Multiport Adapter RFIO Input Port

Press **Input/Output, More, RF Output & Test Set Config, Multiport Adapter, Input Port**. From the submenu which appears, select one of the eight "RFIO" ports on the E6618A (designated RFIO 0 through RFIO 7) as the input port on which measurements will be made. When (for example) RFIO 2 is selected as the input port, the Rx 2 status indicator on the front panel of the Multiport Adapter is lit to indicate that this port is now ready to receive an input. Only one port at a time can be set as the input port.

Key Path	Input/Output, More, RF Output & Test Set Config, Multiport Adapter
Remote Command	[:SENSe] :MPADapter:PORT:INPut OFF RFIO0 RFIO1 RFIO2 RFIO3 RFIO4 RFIO5 RFIO6 RFIO7 [:SENSe] :MPADapter:PORT:INPut?
Example Command	:MPAD:PORT:INP RFIO0
Dependencies	This menu selection does not have any effect unless Input/Output, More, RF Output & Test Set Config, Multiport Adapter is set to the On state.
Preset	Not affected by a Mode Preset. Set to "RFIO 0" by pressing System > Restore Defaults > Input/Output Settings or System > Restore Defaults > All .

Multiport Adapter GNSS Input

The GNSS ports of the E6618A are used for stimulus-only testing, in which the GNSS ports provide a test signal to the DUT but do not receive a return signal to be measured. It is not necessary to set an input port for GNSS testing.

Multiport Adapter RFIO Output Ports

Press **Input/Output, More, RF Output & Test Set Config, Multiport Adapter, Output Port**. On the submenu which appears, select any combination of the eight "RFIO" ports on the E6618A (designated **RFIO 0** through **RFIO 7**) as the output ports to which the output of the test set's RF source will be supplied. Toggle any of the eight selections to select On or Off. There is no restriction on how many of the eight ports can be selected at once.

NOTE

The selected RFIO output ports of the E6618A will not be activated (and their Tx status indicators will not be lit) until the E6630A's internal source is activated by pressing **Source, RF Output, On**.

Key Path	Input/Output, More, RF Output & Test Set Config, Multiport Adapter
Remote Command	[:SENSe] :MPADapter:PORT:OUTPut:BITMap <integer> [:SENSe] :MPADapter:PORT:OUTPut:BITMap?
Example Command	:MPAD:PORT:OUTP:BITM 1
Notes	<p>The BITMap integer is the decimal value of an 8-bit binary number representing the On/Off status of the eight RF I/O ports ("1" for On). The bit assignments are as follows:</p> <p>Bit 0 = RFIO 0 Bit 1 = RFIO 1 Bit 2 = RFIO 2 Bit 3 = RFIO 3 Bit 4 = RFIO 4 Bit 5 = RFIO 5 Bit 6 = RFIO 6 Bit 7 = RFIO 7</p> <p>For example, to set RFIO 0 and RFIO 7 to "On" (Bits 0 + 7, or 10000001), set the BITMap integer value to 129 (1 + 128).</p>
Dependencies	<p>This menu selection does not have any effect unless Input/Output, More, RF Output & Test Set Config, Multiport Adapter, Multiport Adapter is set to the On state and Input/Output, RF Output & Test Set Config, RF Output is set to RF Output.</p> <p>When Input/Output, More, RF Output & Test Set Config, Multiport Adapter, Multiport Adapter is set to the On state, and Input/Output, RF Output is set to RFIO 1 or RFIO 2, then GNSS ports 0 through 3 become the output ports of the Multiport Adapter.</p>
Preset	Not affected by a Mode Preset. Set to "1" by pressing System > Restore Defaults > Input/Output Settings or System > Restore Defaults > All .

Multiport Adapter GNSS Output Ports

It is not necessary to select an individual output port, when the "GNSS" ports of the Multiport Adapter are used. In that case, the RF output of the Multiport Adapter is always split evenly across the four output ports (GNSS 0 through GNSS 3), and it is not possible to switch individual ports on or off.

Because GNSS Ports 0 - 3 are the outputs of a four-way splitter, it is not possible to obtain as much power from these ports as from RFIO Ports 0 - 7. When the RF Output of the E6630A test set is set to GNSS (see "[Test Set Output Port](#)" on page 39), setting the source output power level to (for example) -50 dBm will automatically adjust the E6630A source output to a much higher level than -50 dBm, in order to compensate for the insertion loss of the GNSS splitter, and produce a -50 dBm output level at the GNSS output ports of the Multiport Adapter. The maximum power level available from the GNSS output ports is limited by the insertion loss of the splitter; see the E6618A data sheet for specifics.

To use the "GNSS" ports on the Multiport Adapter, select **GNSS Output** under **Input/Output, More, RF Output & Test Set Config, RF Output**. The equivalent command is:

```
[SENSe] :FEED:RF:PORT:OUTPut GNSSout
```

Multiport Adapter Duplex Mode

The E6618A Multiport Adapter has FDD and TDD duplex modes for its RFIO ports. FDD mode is the full duplex mode, while TDD mode is the half duplex mode, in which the multiport adapter RFIO ports use time-division multiplexing.

Duplex Mode

Specifies FDD or TDD duplex mode for multiport adapter RFIO ports.

Key Path	Input/Output, More, RF Output & Test Set Config, Multiport Adapter
Remote Command	[:SENSe] :MPADapter:DUPLex:MODE FDD TDD [:SENSe] :MPADapter:DUPLex:MODE?
Example Command	:MPAD:DUPL:MODE TDD
Dependencies	This menu selection does not have any effect unless Input/Output, More, RF Output & Test Set Config, Multiport Adapter, Multiport Adapter is set to the On state.
Preset	Not affected by a Mode Preset. Set to "TDD" by pressing System > Restore Defaults > Input/Output Settings or System > Restore Defaults > All .

Duplex Mode TDD Type

Specifies the type of TDD half-duplex mode for multiport adapter RFIO ports.

Key Path	Input/Output, More, RF Output & Test Set Config, Multiport Adapter, Duplex Mode, TDD
Remote Command	[:SENSe] :MPADapter:DUPLex:TDD:TYPE TRIGgered DLINK ULINK [:SENSe] :MPADapter:DUPLex:TDD:TYPE?
Example Command	:MPAD:DUPL:TDD:TYPE TRIG

Notes	<ul style="list-style-type: none"> • TDD Triggered (TRIGgered) specifies the multiport adapter TDD half-duplex working mode is controlled by ARB marker 2 bit polarity. If marker2 is positive (bit = 1), then the RFIO port is set to TDD Uplink direction (for receiver). If marker2 is negative (bit = 0), then the RFIO port is set to TDD Downlink direction (for transmitter). To make “TDD Triggered” effective, a trigger signal must be fed into the E6618A TRIG 3 input trigger port. (A typical connection is from TRIG 2 out on the E6630A to the E6618A TRIG 3 port.) • TDD Downlink (DLINK) Specifies that the multiport adapter RFIO ports have a fixed setting of TDD half-duplex downlink direction (for transmitter). • TDD Uplink (ULINK) Specifies multiport adapter RFIO ports have a fixed setting of TDD half-duplex uplink direction (for receiver).
Dependencies	This menu selection does not have any effect unless Input/Output, More, RF Output & Test Set Config, Multiport Adapter, Multiport Adapter is set to the On state.
Preset	Not affected by a Mode Preset. Set to "TRIGgered" by pressing System > Restore Defaults > Input/Output Settings or System > Restore Defaults > All .

Corrections

Amplitude Corrections arrays for the Multiport Adapter can be entered manually, sent over SCPI, or loaded from a file. The Multiport Adapter correction supports 16 separate Corrections arrays, each of which can contain up to 2000 points. They can be turned on and off individually, and any or all can be on at the same time. Different corrections can be applied to the various Input/Output RF ports of the Multiport Adapter. The correction data is applied to incoming signals as well as transmitted signals, and is in the form of a list of spot frequencies and amplitude correction levels.

Key Path	Input/Output, More, RF Output & Test Set Config, Multiport Adapter
Dependencies	<p>This menu selection does not have any effect unless Input/Output, More, RF Output & Test Set Config, Multiport Adapter, Multiport Adapter is set to the On state.</p> <p>This menu selection is hidden if the currently active measurement or mode does not support amplitude correction.</p>
State Saved	Saved in Instrument State.
Preset	Not affected by a Preset. Corrections arrays are reset (deleted) by pressing System > Restore Defaults > Input/Output Settings or System > Restore Defaults > All ; however, they survive shutting down and restarting the test set application, and they survive a power cycle.

Select Correction

Specifies the selected correction. The term "selected correction" is used throughout this document to specify which correction is affected by a function.

Key Path	Input/Output, More, RF Output & Test Set Config, Multiport Adapter, Corrections
Dependencies	<p>This menu selection does not have any effect unless Input/Output, More, RF Output & Test Set Config, Multiport Adapter, Multiport Adapter is set to the On state.</p> <p>This menu selection is hidden if the currently active measurement or mode does not support amplitude correction.</p>
State Saved	Saved in Instrument State.
Note	The selected correction is remembered even when not in the Corrections menu.
Preset	Set to Correction 1 by pressing System > Restore Defaults > Input/Output Settings or System > Restore Defaults > All .

Correction On/Off

Turning the Selected Correction on allows the values in it to be applied to the data. This also automatically activates "Apply Corrections" (sets it to ON), otherwise the correction would not take effect.

A new sweep is initiated if an amplitude correction is switched on or off. Note that changing, sending or loading corrections data does *not* directly initiate a sweep, however in general these operations turn corrections on, which *does* initiate a sweep.

Key Path	Input/Output, More, RF Output & Test Set Config, Multiport Adapter, Corrections
Remote Command	[:SENSe]:MPADapter:CORRection:CSET [1] 2 3 4 5 6 7 8 9 10 11 12 13 14 15 16 [:STATe] ON OFF 1 0 [:SENSe]:MPADapter:CORRection:CSET [1] 2 3 4 5 6 7 8 9 10 11 12 13 14 15 16 [:STATe] ?
Example Command	:MPAD:CORR:CSET ON
Dependencies	<p>This menu selection does not have any effect unless Input/Output, More, RF Output & Test Set Config, Multiport Adapter, Multiport Adapter is set to the On state.</p> <p>This menu selection is hidden if the currently active measurement or mode does not support amplitude correction.</p> <p>Turning this on automatically turns on "Apply Corrections"</p> <p>Only the first correction array (Correction 1) supports antenna units. When this array is turned on, and it contains an Antenna Unit other than "None", the Y Axis Unit of the analyzer is forced to that Antenna Unit. All other Y Axis Unit choices are grayed out.</p> <p>Note that this means that a correction file with an Antenna Unit can only be loaded into the Corrections 1 register. Consequently, only for Correction 1 does the dropdown in the Recall dialog include .ant. If an attempt is made to load a correction file that contains an antenna unit into any other Correction register, a Mass Storage error is generated.</p>
Preset	Not affected by a Preset. Set to OFF by pressing System > Restore Defaults > Input/Output Settings or System > Restore Defaults > All .

Properties

Accesses a menu that lets you set the properties of the selected correction.

Key Path	Input/Output, More, RF Output & Test Set Config, Multiport Adapter, Corrections
Dependencies	<p>This menu selection does not have any effect unless Input/Output, More, RF Output & Test Set Config, Multiport Adapter, Multiport Adapter is set to the On state.</p> <p>This menu selection is hidden if the currently active measurement or mode does not support amplitude correction.</p>

Select Correction

Specifies the selected correction for purposes of the Properties menu. The term "selected correction" is used throughout this document to specify which correction is affected by a function.

Key Path	Input/Output, More, RF Output & Test Set Config, Multiport Adapter, Corrections, Properties
Dependencies	<p>This menu selection does not have any effect unless Input/Output, More, RF Output & Test Set Config, Multiport Adapter, Multiport Adapter is set to the On state.</p> <p>This menu selection is hidden if the currently active measurement or mode does not support amplitude correction.</p>
Note	The selected correction is remembered even when not in the correction properties menu.
State Saved	Saved in Instrument State.
Preset	Set to Correction 1 by pressing System > Restore Defaults > Input/Output Settings or System > Restore Defaults > All .

Antenna Unit

For devices (such as antennae) which make measurements of field strength or flux density, the correction array should contain within its values the appropriate conversion factors such that, when the data on the analyzer is presented in dBuV, the display is calibrated in the appropriate units. The "Antenna Unit" used for the conversion is contained within the corrections array database. It may be specified by the user or loaded in from an external file or SCPI.

When an array with an Antenna Unit other than "None" is turned on, the Y Axis Unit of the analyzer is forced to that antenna unit. When this array is turned on, and it contains an Antenna Unit other than "None", the Y Axis Unit of the analyzer is forced to that Antenna Unit, and all other Y Axis Unit choices are grayed out.

Antenna Unit does not appear in all Modes that support Corrections.

Key Path	Input/Output, More, RF Output & Test Set Config, Multiport Adapter, Corrections, Properties
Remote Command	<pre>[:SENSe] :MPADapter:CORRection:CSET [1] 2 3 4 5 6 7 8 9 10 11 12 13 14 15 16 :ANTenna [:UNIT] GAUSs PTESla UVM UAM NOConversion [:SENSe] :MPADapter:CORRection:CSET [1] 2 3 4 5 6 7 8 9 10 11 12 13 14 15 16 :ANTenna [:UNIT] ?</pre>
Example Command	:MPAD:CORR:CSET:ANT GAUS
Notes	<p>The command parameter values are equivalent to the units listed below:</p> <p>GAUSs = dBG PTESla = dBpT UVM = dBμV/m UAM = dBμA/m NOConversion = None</p>

Dependencies	<p>Only the first correction array (Correction 1) supports antenna units.</p> <p>Note that this means that a correction file with an Antenna Unit can only be loaded into the Corrections 1 register. Consequently, only for Correction 1 does the dropdown in the Recall dialog include .ant, and if an attempt is made to load a correction file containing an antenna unit into any other Correction register, a Mass Storage error is generated.</p> <p>This menu selection does not have any effect unless Input/Output, More, RF Output & Test Set Config, Multiport Adapter, Multiport Adapter is set to the On state.</p> <p>This menu selection is hidden if the currently active measurement or mode does not support amplitude correction.</p>
State Saved	Saved in Instrument State.
Preset	Unaffected by a preset. Set to NOConversion by pressing System > Restore Defaults > Input/Output Settings or System > Restore Defaults > All .

Frequency Interpolation

This setting controls how the correction values per correction point are calculated. We interpolate between frequencies in either the logarithmic or linear scale.

This setting is handled and stored individually per correction set.

Key Path	Input/Output, More, RF Output & Test Set Config, Multiport Adapter, Corrections, Properties
Remote Command	<pre>[:SENSe] :MPADapter:CORRection:CSET [1] 2 3 4 5 6 7 8 9 10 11 12 13 14 15 16 :X:SPACing LINear LOGarithmic</pre> <pre>[:SENSe] :MPADapter:CORRection:CSET [1] 2 3 4 5 6 7 8 9 10 11 12 13 14 15 16 :X:SPACing?</pre>
Example Command	:MPAD:CORR:CSET8:X:SPAC LIN
Dependencies	<p>This menu selection does not have any effect unless Input/Output, More, RF Output & Test Set Config, Multiport Adapter, Multiport Adapter is set to the On state.</p> <p>This menu selection is hidden if the currently active measurement or mode does not support amplitude correction.</p>
State Saved	Saved in Instrument State.

Preset	Not affected by a Preset. Set to Linear by pressing System > Restore Defaults > Input/Output Settings or System > Restore Defaults > All
---------------	--

Interpolation Methods For each correction point processed by the application, all of the correction factors at the frequency of interest (center frequency of each correction point) are summed and added to the amplitude. All trace operations and post processing treat this post-summation value as the true signal to use.

To effect this correction the goal, for any particular start and stop frequency, is to build a correction trace, whose number of points matches the current Sweep Points setting of the test set, which are used to apply corrections on a correction-point by correction-point basis to the data traces.

For amplitudes that lie between two user specified frequency points, we interpolate to determine the amplitude value. You may select either linear or logarithmic interpolation between the frequencies.

3 Instrument Operation

If we interpolate on a log scale, we assume that the line between the two points is a straight line on the log scale. For example, let's say the two points are (2,4) and (20,1). A straight line between them on a log scale looks like:

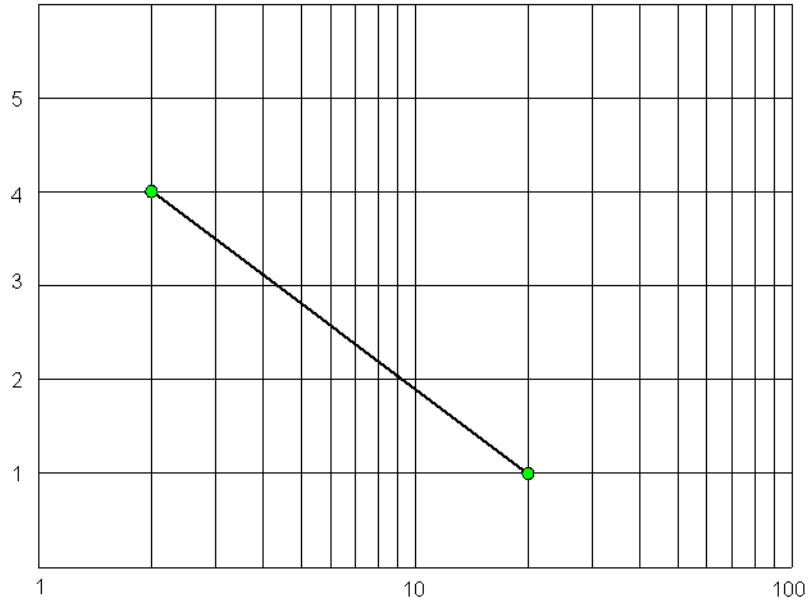

On a linear scale, this translates to:

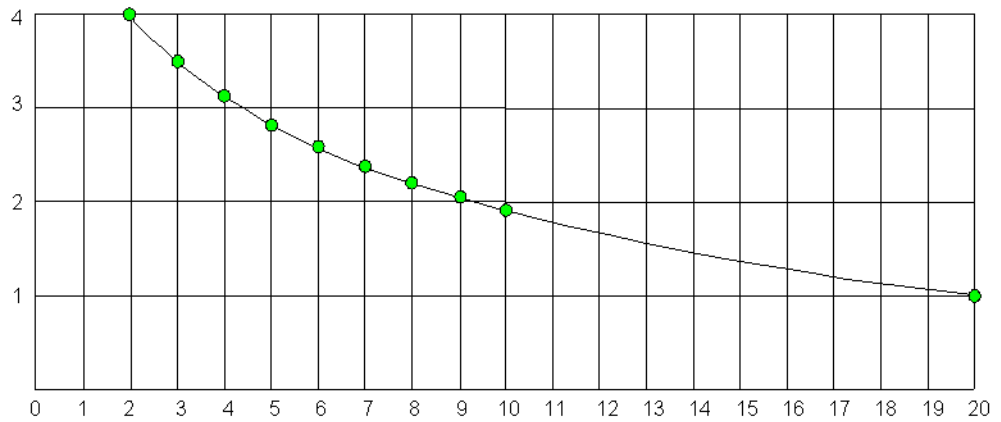

On the other hand, if we interpolate on a linear scale, we assume that the two points are connected by a straight line on the linear scale, as below:

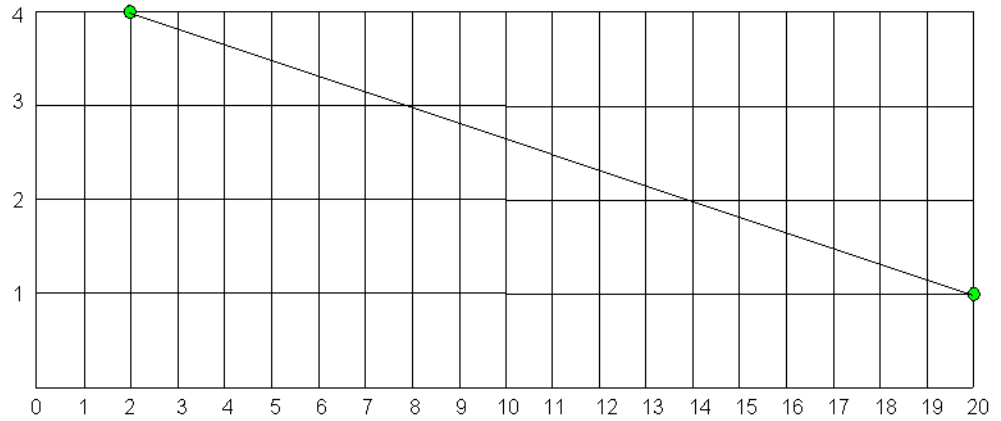

The correction to be used for each correction point is taken from the interpolated correction curve at the center of the correction point.

Description

Sets an ASCII description field which is stored in an exported file. Can be displayed in the active function area by selecting as the active function, if desired to be in a screen dump.

Key Path	Input/Output, More, RF Output & Test Set Config, Multiport Adapter, Corrections, Properties
Remote Command	[:SENSe]:MPADapter:CORRection:CSET[1] 2 3 4 5 6 7 8 9 10 11 12 13 14 15 16:DESCRiption "text" [:SENSe]:MPADapter:CORRection:CSET[1] 2 3 4 5 6 7 8 9 10 11 12 13 14 15 16:DESCRiption?
Example Command	:MPAD:CORR:CSET5:DESC "11941A Antenna correction"
Dependencies	This menu selection does not have any effect unless Input/Output, More, RF Output & Test Set Config, Multiport Adapter, Multiport Adapter is set to the On state. This menu selection is hidden if the currently active measurement or mode does not support amplitude correction.
Note	The maximum number of characters is 45. The description may not fit on the display if maximum characters are used.
State Saved	Saved in Instrument State.
Preset	Not affected by a Preset. Set to empty by pressing System > Restore Defaults > Input/Output Settings or System > Restore Defaults > All .

Comment

Sets an ASCII comment field which are stored in an exported file. Can be displayed in the active function area by selecting as the active function, if desired to be in a screen dump.

Key Path	Input/Output, More, RF Output & Test Set Config, Multiport Adapter, Corrections, Properties
Remote Command	[:SENSe]:MPADapter:CORRection:CSET[1] 2 3 4 5 6 7 8 9 10 11 12 13 14 15 16:COMMeNT "text" [:SENSe]:MPADapter:CORRection:CSET[1] 2 3 4 5 6 7 8 9 10 11 12 13 14 15 16:COMMeNT?
Example Command	:MPAD:CORR:CSET3:COMM "this is a comment"
Dependencies	This menu selection does not have any effect unless Input/Output, More, RF Output & Test Set Config, Multiport Adapter, Multiport Adapter is set to the On state. This menu selection is hidden if the currently active measurement or mode does not support amplitude correction.
Note	The maximum number of characters is 45. The comment may not fit on the display if maximum characters are used.
State Saved	Saved in Instrument State.
Preset	Not affected by a Preset. Set to empty by pressing System > Restore Defaults > Input/Output Settings or System > Restore Defaults > All .

Multiport Adptr RF Port

Maps one of the sets of corrections to one of the I/O ports.

Key Path	Input/Output, More, RF Output & Test Set Config, Multiport Adapter, Corrections, Properties
Remote Command	<pre>[:SENSe] :MPADapter:CORRection:CSET [1] 2 3 4 5 6 7 8 9 10 11 12 13 14 15 16 :RF:PORT RFIO0 RFIO1 RFIO2 RFIO3 RFIO4 RFIO5 RFIO6 RFIO7 [:SENSe] :MPADapter:CORRection:CSET [1] 2 3 4 5 6 7 8 9 10 11 12 13 14 15 16 :RF:PORT?</pre>
Example Command	MPAD:CORR:CSET13:RF:PORT RFIO0
Dependencies	<p>This menu selection does not have any effect unless Input/Output, More, RF Output & Test Set Config, Multiport Adapter, Multiport Adapter is set to the On state.</p> <p>This menu selection is hidden if the currently active measurement or mode does not support amplitude correction.</p>
State Saved	Saved in Instrument State.
Preset	Not affected by a Preset. Set to RFIO 0 by pressing System > Restore Defaults > Input/Output Settings or System > Restore Defaults > All .

RFIO *n* Press **RFIO 0** to select RFIO 0 as the port that the current corrections are to be applied to; pressing this key again allows the user access to the menu for specifying which internal device the corrections for RFIO 0 are applied to (Correct Source, Correct Analyzer, or Correct Source and Analyzer).

Additional keys and submenus are provided for RFIO 1 through RFIO 7; these function exactly as described below, except that the "RFIO0" element of the remote commands is replaced by "RFIO1" through "RFIO7".

Key Path	Input/Output, More, RF Output & Test Set Config, Multiport Adapter, Corrections, Properties, RF Port
Remote Command	<pre>[:SENSe] :MPADapter:CORRection:CSET [1] 2 3 4 5 6 7 8 9 10 11 12 13 14 15 16 :RF:PORT:RFIO0 SOURce ANALyzer BOTH [:SENSe] :MPADapter:CORRection:CSET [1] 2 3 4 5 6 7 8 9 10 11 12 13 14 15 16 :RF:PORT:RFIO?</pre>
Example Command	:MPAD:CORR:CSET6:RF:PORT:RFIO0 BOTH
Note	"RFIO0" in the above commands applies to RFIO port 0 of the Multiport Adapter. Substitute "RFIO1" through "RFIO7" for the other ports.
Dependencies	<p>This menu selection does not have any effect unless Input/Output, More, RF Output & Test Set Config, Multiport Adapter, Multiport Adapter is set to the On state.</p> <p>This menu selection is hidden if the currently active measurement or mode does not support amplitude correction.</p>
State Saved	Saved in Instrument State.
Preset	Set to BOTH by a Preset or by pressing System > Restore Defaults > Input/Output Settings or System > Restore Defaults > All .

3 Instrument Operation

Correct Source Sets the corrections for the RFIO 0 port to be applied to the source. Additional keys and submenus are provided for RFIO 1 through RFIO 7; these function exactly as described below, except that the "RFIO0" element of the remote commands is replaced by "RFIO1" through "RFIO7".

Key Path	Input/Output, More, RF Output & Test Set Config, Multiport Adapter, Corrections, Properties, RF Port, RFIO 0
Remote Command	[:SENSe]:MPADapter:CORRection:CSET[1] 2 3 4 5 6 7 8 9 10 11 12 13 14 15 16:RF:PORT:RFIO0 SOURce [:SENSe]:MPADapter:CORRection:CSET[1] 2 3 4 5 6 7 8 9 10 11 12 13 14 15 16:RF:PORT:RFIO?
Example Command	:MPAD:CORR:CSET9:RF:PORT:RFIO0 SOUR
Note	"RFIO0" in the above commands applies to RFIO port 0 of the Multiport Adapter. Substitute "RFIO1" through "RFIO7" for the other ports.
Dependencies	This menu selection does not have any effect unless Input/Output, More, RF Output & Test Set Config, Multiport Adapter, Multiport Adapter is set to the On state. This menu selection is hidden if the currently active measurement or mode does not support amplitude correction.
State Saved	Saved in Instrument State.

Correct Analyzer Sets the corrections for the RFIO 0 port to be applied to the test set. Additional keys and submenus are provided for RFIO 1 through RFIO 7; these function exactly as described below, except that the "RFIO0" element of the remote commands is replaced by "RFIO1" through "RFIO7".

Key Path	Input/Output, More, RF Output & Test Set Config, Multiport Adapter, Corrections, Properties, RF Port, Ext RFIO 0
Remote Command	[:SENSe] :MPADapter:CORRection:CSET [1] 2 3 4 5 6 7 8 9 10 11 12 13 14 15 16 :RF:PORT:RFIO0 ANALyzer [:SENSe] :MPADapter:CORRection:CSET [1] 2 3 4 5 6 7 8 9 10 11 12 13 14 15 16 :RF:PORT:RFIO?
Example Command	:MPAD:CORR:CSET5:RF:PORT:RFIO0 ANAL
Note	"RFIO0" in the above commands applies to RFIO port 0 of the Multiport Adapter. Substitute "RFIO1" through "RFIO7" for the other ports.
Dependencies	This menu selection does not have any effect unless Input/Output, More, RF Output & Test Set Config, Multiport Adapter, Multiport Adapter is set to the On state. This menu selection is hidden if the currently active measurement or mode does not support amplitude correction.
State Saved	Saved in Instrument State.

3 Instrument Operation

Correct Source and Analyzer Sets the corrections for the RFIO 0 port to be applied to both the source and the analyzer. Additional keys and submenus are provided for RFIO 1 through RFIO 7; these function exactly as described below, except that the "RFIO0" element of the remote commands is replaced by "RFIO1" through "RFIO7".

Key Path	Input/Output, More, RF Output & Test Set Config, Multiport Adapter, Corrections, Properties, RF Port, RFIO 0
Remote Command	<code>[:SENSe] :MPADapter:CORRection:CSET [1] 2 3 4 5 6 7 8 9 10 11 12 13 14 15 16 :RF:PORT:RFIO0 BOTH</code> <code>[:SENSe] :MPADapter:CORRection:CSET [1] 2 3 4 5 6 7 8 9 10 11 12 13 14 15 16 :RF:PORT:RFIO?</code>
Example Command	<code>:MPAD:CORR:CSET15:RF:PORT:RFIO0 BOTH</code>
Note	"RFIO0" in the above commands applies to RFIO port 0 of the Multiport Adapter. Substitute "RFIO1" through "RFIO7" for the other ports.
Dependencies	This menu selection does not have any effect unless Input/Output, More, RF Output & Test Set Config, Multiport Adapter, Multiport Adapter is set to the On state. This menu selection is hidden if the currently active measurement or mode does not support amplitude correction.
State Saved	Saved in Instrument State.

Edit

Invokes the integrated editing facility for this correction set.

When entering the menu, the editor window turns on, the selected correction is turned **On**, **Apply Corrections** is set to **On**, the amplitude scale is set to **Log**, and the Amplitude Correction ("Ampcor") trace is displayed. The actual, interpolated correction trace is shown in green for the selected correction. Note that since the actual interpolated correction is shown, the correction trace may have some curvature to it. This trace represents only the correction currently being edited, rather than the total, accumulated amplitude correction for all amplitude corrections which are currently on, although the total, accumulated correction for all corrections which are turned on is still applied to the data traces.

Because corrections data is always in dB, but the Y-axis of the analyzer is in absolute units, it is necessary to establish a reference line for display of the Corrections data. The reference line is halfway up the display and represents 0 dB of correction. It is labeled "0 dB CORREC". It is drawn in blue. (0,0,255) and is three pixels high. The green correction trace is drawn after all other traces and this reference blue line, so it sits "on top" of them.

Corrections data is always in dB. Whatever dB value appears in the correction table represents the correction to be applied to that trace at that frequency. So if a table entry shows 30 dB that means we ADD 30 dB to each trace to correct it before displaying it. By definition all points are connected. If a gap is desired for corrections data, enter 0 dB.

Note that a well-designed Corrections array should start at 0 dB and end at 0 dB. This is because whatever the high end point is extended to the top frequency of the test set, and whatever the low end point is extended down to 0 Hz. So for a Corrections array to have no effect outside its range, you should start and end the array at 0 dB.

NOTE

The table editor only operates properly if the test set is sweeping, because its updates are tied to the sweep system. Thus, you should not try to use the editor in single sweep, and it will be slow during computer-intensive operations like narrow-span FFT sweeps.

When exiting the edit menu (by using the **Return** key or by pressing an test set front-panel key), the editor window turns off and the Ampcor trace is no longer displayed; however, **Apply Corrections** remains **On**, any correction that was on while in the editor remains on, and the amplitude scale returns to its previous setting.

3 Instrument Operation

Corrections arrays are not affected by a Preset, because they are in the Input/Output system. They also survive shutdown and restarting of the test set application, which means they survive a power cycle.

When editing a correction, the editor remembers which correction and which element in the correction array you were editing, and returns you to that correction and that element when you return to the editor after leaving it.

Key Path	Input/Output, More, RF Output & Test Set Config, Multiport Adapter, Corrections
Dependencies	<p>This menu selection does not have any effect unless Input/Output, More, RF Output & Test Set Config, Multiport Adapter, Multiport Adapter is set to the On state.</p> <p>This menu selection is hidden if the currently active measurement or mode does not support amplitude correction.</p>
Preset	Not affected by a Preset.

Navigate

Lets you move through the table to edit the desired point.

Key Path	Input/Output, More, RF Output & Test Set Config, Multiport Adapter, Corrections, Edit
Dependencies	<p>This menu selection does not have any effect unless Input/Output, More, RF Output & Test Set Config, Multiport Adapter, Multiport Adapter is set to the On state.</p> <p>This menu selection is hidden if the currently active measurement or mode does not support amplitude correction.</p>

Frequency

Lets you edit the frequency of the current row.

Key Path	Input/Output, More, RF Output & Test Set Config, Multiport Adapter, Corrections, Edit
Dependencies	<p>This menu selection does not have any effect unless Input/Output, More, RF Output & Test Set Config, Multiport Adapter, Multiport Adapter is set to the On state.</p> <p>This menu selection is hidden if the currently active measurement or mode does not support amplitude correction.</p>

Amplitude

Lets you edit the Amplitude of the current row.

Key Path	Input/Output, More, RF Output & Test Set Config, Multiport Adapter, Corrections, Edit
Dependencies	<p>This menu selection does not have any effect unless Input/Output, More, RF Output & Test Set Config, Multiport Adapter, Multiport Adapter is set to the On state.</p> <p>This menu selection is hidden if the currently active measurement or mode does not support amplitude correction.</p>

Insert Point Below

Inserts a point below the current point. The new point is a copy of the current point and becomes the current point. The new point is not yet entered into the underlying table, and the data in the row is displayed in light gray.

Key Path	Input/Output, More, RF Output & Test Set Config, Multiport Adapter, Corrections, Edit
Dependencies	This menu selection does not have any effect unless Input/Output, More, RF Output & Test Set Config, Multiport Adapter, Multiport Adapter is set to the On state. This menu selection is hidden if the currently active measurement or mode does not support amplitude correction.

Delete Point

Deletes the currently-selected point, whether or not that point is being edited, and selects the Navigate functionality. The point following the currently-selected point (or the point preceding if there is none) is selected.

Key Path	Input/Output, More, RF Output & Test Set Config, Multiport Adapter, Corrections, Edit
Dependencies	This menu selection does not have any effect unless Input/Output, More, Multiport Adapter, Multiport Adapter is set to the On state. This menu selection is hidden if the currently active measurement or mode does not support amplitude correction.

Scale X-axis

Matches the X-axis to the selected Correction as well as possible. Sets the Start and Stop Frequency to contain the minimum and maximum Frequency of the selected Correction. The range between Start Frequency and Stop Frequency is 12.5% above the range between the minimum and maximum Frequency, so that span exceeds this range by one graticule division on either side. If in zero-span, or there is no data in the Ampcor table, or the frequency range represented by the table is zero, no action is taken. Standard clipping rules apply if the value in the table is outside the allowable range for the X axis.

Key Path	Input/Output, More, RF Output & Test Set Config, Multiport Adapter, Corrections, Edit
Dependencies	<p>This menu selection does not have any effect unless Input/Output, More, RF Output & Test Set Config, Multiport Adapter, Multiport Adapter is set to the On state.</p> <p>This menu selection is hidden if the currently active measurement or mode does not support amplitude correction.</p>
Note	<p>If either the first or last point in the array is outside the frequency range of the current input, an error message is generated:</p> <p>"-221. Settings conflict; Start or Stop Freq out of range for current input settings".</p>

Delete Correction

Deletes the correction values for this set. When this key is pressed a prompt is placed on the screen that says "Please press Enter or OK key to delete correction. Press ESC or Cancel to close this dialog." The deletion is only performed if you press OK or Enter; if so, after the deletion, the informational message "Correction deleted" appears in the MSG line.

Key Path	Input/Output, More, RF Output & Test Set Config, Multiport Adapter, Corrections
Remote Command	[:SENSe] :MPADapter:CORRection:CSET [1 2 3 4 5 6 7 8 9 10 11 12 13 14 15 16 :DELete
Example Command	MPAD:CORR:CSET8:DEL
Dependencies	This menu selection is hidden if the currently active measurement or mode does not support amplitude correction.

Apply Corrections

Applies amplitude corrections which are marked as ON to the measured data. If this is set to OFF, then no amplitude correction sets are used, regardless of their individual on/off settings. If set to ON, the corrections that are marked as ON (see "[Correction On/Off](#)" on page 48) are used.

Key Path	Input/Output, More, RF Output & Test Set Config, Multiport Adapter, Correction, More
Remote Command	[:SENSe]:MPADapter:CORRection:CSET:ALL[:STATe] ON OFF 1 0 [:SENSe]:MPADapter:CORRection:CSET:ALL[:STATe]?
Example Command	SENS:MPAD:CORR:CSET:ALL OFF (This command ensures that no Multiport Adapter amplitude corrections are applied, regardless of their individual on/off settings.)
Dependencies	This menu selection does not have any effect unless Input/Output, More, RF Output & Test Set Config, Multiport Adapter, Multiport Adapter is set to the On state. This menu selection is hidden if the currently active measurement or mode does not support amplitude correction.
State Saved	Saved in Instrument State.
Preset	Not affected by a Preset. Set to OFF by pressing System > Restore Defaults > Input/Output Settings or System > Restore Defaults > All .

Delete All Corrections

Erases all correction values for all 16 Amplitude Correction sets.

When this key is pressed a prompt is placed on the screen that says "Please press Enter or OK key to delete all corrections. Press ESC or Cancel to close this dialog." The deletion is only performed if you press OK or Enter.

Key Path	Input/Output, More, RF Output & Test Set Config, Multiport Adapter, Corrections
Remote Command	<code>[:SENSe] :MPADapter:CORRection:CSET:ALL:DELeTe</code>
Example Command	<code>MPAD:CORR:CSET:ALL:DEL</code>
Dependencies	This menu selection is hidden if the currently active measurement or mode does not support amplitude correction.

Remote Correction Data Set Commands

Set (Replace) Data

The command takes an ASCII series of alternating frequency and amplitude points, each value separated by commas.

The values sent in the command totally replace all existing correction points in the specified set.

An Amplitude Correction array can contain 2000 points maximum.

Key Path	None (remote command only)
Remote Command	<pre>[:SENSe] :MPADapter:CORRection:CSET [1] 2 3 4 5 6 7 8 9 10 11 12 13 14 15 16 :DATA <freq>, <amp> . . .</pre> <pre>[:SENSe] :MPADapter:CORRection:CSET [1] 2 3 4 5 6 7 8 9 10 11 12 13 14 15 16 :DATA?</pre>
Example Command	<pre>MPAD:CORR:CSET4:DATA 10000000, -1.0, 20000000, 1.0</pre> <p>This command defines two correction points at (10 MHz, -1.0 dB) and (20 MHz, 1.0 dB) for correction set 4.</p>
Note	A query command returns the entire list of frequency/amplitude pairs in the correction set.
Dependencies	<p>This menu selection does not have any effect unless Input/Output, More, RF Output & Test Set Config, Multiport Adapter, Multiport Adapter is set to the On state.</p> <p>This menu selection is hidden if the currently active measurement or mode does not support amplitude correction.</p>
State Saved	Saved in Instrument State.
Preset	Not affected by a Preset. Set to empty by pressing System > Restore Defaults > Input/Output Settings or System > Restore Defaults > All . Survives a shutdown or restart of analyzer application (including a power cycle).

Merge Correction Data (Remote Command Only)

The command takes an ASCII series of alternating frequency and amplitude points, each value separated by commas. The difference between this command and Set Data is that this merges new correction points into an existing set.

Any new point with the same frequency as an existing correction point replaces the existing point’s amplitude with that of the new point.

An Amplitude Correction array can contain 2000 total points, maximum.

Key Path	None (remote command only)
Remote Command	[:SENSe]:MPADapter:CORRection:CSET[1] 2 3 4 5 6 7 8 9 10 11 12 13 14 15 16:DATA:MERGe <freq>, <ampl>, ... [:SENSe]:MPADapter:CORRection:CSET[1] 2 3 4 5 6 7 8 9 10 11 12 13 14 15 16:DATA:MERGe?
Example Command	MPAD:CORR:CSET3:DATA:MERG 15000000,-5.0,25000000,5.0 This command adds two correction points at (15 MHz, -5.0 dB) and (25 MHz, 5.0 dB) to whatever values already exist in correction set 3.
Note	A query command returns the entire list of frequency/amplitude pairs in the correction set.
Dependencies	This menu selection does not have any effect unless Input/Output, More, RF Output & Test Set Config, Multiport Adapter, Multiport Adapter is set to the On state. This menu selection is hidden if the currently active measurement or mode does not support amplitude correction.
State Saved	Saved in Instrument State.
Preset	Not affected by a Preset. Set to empty by pressing System > Restore Defaults > Input/Output Settings or System > Restore Defaults > All . Survives a shutdown or restart of analyzer application (including a power cycle).

Recall Amplitude Correction

Multiport Adapter Amplitude Correction

This key selects the Multiport Adapter Amplitude Correction as the data type to be imported. When pressed a second time, it brings up the Select Menu, which lets you select the Correction into which the data will be imported.

A set of preloaded Corrections files can be found in the directory:
/My Documents/ EMC Limits and Ampcor

Under this directory, the directory called Ampcor (Legacy Naming) contains a set of legacy corrections files, generally the same files that were supplied with older Agilent EMI analyzers, that use the legacy suffixes .ant, .oth, .usr, and .cbl, and the old 8-character file names. The directory called Ampcor contains the same files, with the same suffixes, but with longer, more descriptive filenames.

When the Amplitude Correction is an Antenna correction and the Antenna Unit in the file is not None, the Y Axis Unit setting will change to match the Antenna Unit in the file.

Key Path	Recall, Data
Remote Command	:MMEMory:LOAD:MPADapter:CORRection 1 2 3 4 5 6 7 8 9 10 11 12 13 14 15 16, <filename>
Example Command	:MMEM:LOAD:MPAD:CORR 2 "myAmpcor.csv" Recalls the Multiport Adapter Amplitude Correction data from the file myAmpcor.csv in the current directory to the 2nd Multiport Adapter Amplitude Correction table, and turns on MPA Correction 2. The default path is: My Documents\amplitudeCorrections

Dependencies	<p>Only the first correction array (Correction 1) supports antenna units. This means that a correction file with an Antenna Unit can only be loaded into the Corrections 1 register. Consequently only for Correction 1 does the dropdown in the Recall dialog include .ant, and if an attempt is made to load a correction file into any other Correction register which DOES contain an antenna unit, a Mass Storage error is generated.</p> <p>Corrections are not supported by all Measurements. If in a Mode in which some Measurements support it, this key will be grayed out in measurements that do not. The key will not show at all if no measurements in the Mode support it.</p> <p>Errors are reported if the file is empty or missing, or if the file type does not match, or if there is a mismatch between the file type and the destination data type. If any of these occur during manual operation, the analyzer returns to the Import Data menu and the File Open dialog goes away.</p> <p>If the file is empty, message -250.3005 is reported. If the file does not exist message -256 is reported. If there is a mismatch between the file and the destination data type, message -250.3003 is reported. See error list in the X-series Messaging PD document for the exact error text.</p>
Couplings	<p>When a correction file is loaded from mass storage, it is automatically turned on (Correction ON) and Apply Corrections is set to On. This allows the user to see its effect, thus confirming the load.</p>
Annotation	<p>After recall is complete, an advisory is displayed in the message bar confirming which file was recalled.</p>
Backwards Compatibility SCPI	<p>For backwards compatibility, the following parameters syntax is supported:</p> <pre>:MMEMory:LOAD:MPADapter:CORRection ANTenna CABLe OTHer USER, <filename></pre> <p>ANTenna maps to 1, CABLe maps to 2, OTHer maps to 3 and USER maps to 4.</p>

E6618A FPGA Version

This query-only SCPI command:
SYST:MPAD:SOFTWARE:VERSION?
returns the FPGA version of the E6618A associated with the sub-instrument.

Example:
SYST:MPAD:SOFT:VERS?
returns "1.0.7".

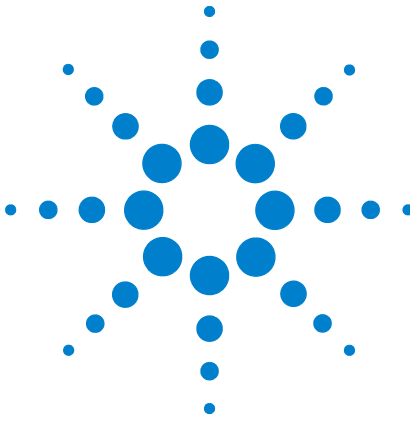

4 Troubleshooting

“Check the Basics” on page 76

WARNING

No operator serviceable parts inside. Refer servicing to qualified personnel. To prevent electrical shock do not remove covers.

Check the Basics

Checking the E6618A

The E6618A is always used as an extension of the E6630A test set, and it lacks an independent user interface. However, there are some potential problems which can be detected on the E6618A itself:

- Is there power at the receptacle?
- Is the instrument turned on? Check to see if the green LED beside the power switch is on. Also, listen for internal fan noise to determine if the instrument cooling fans are running.
- Is the front-panel FAULT indicator illuminated?
- Is the front-panel USB CONNECT indicator illuminated?
- Are the front-panel RF IN and RF OUT ports properly connected to the E6630A test set?
- Are the front-panel RFIO ports properly connected to the test devices?
- Is the front-panel USB port connected correctly to the E6630A test set?
- Is the TRIG 2 port on the front of the E6630A connected to TRIG 3 port on the front of the panel of the E6618A?
- Are the front-panel STATUS indicators for the various RFIO ports illuminated as you would expect, based on port selections you have made by way of the E6630A test set?

Checking the E6630A Test Set

Because the E6618A is used as an extension of the E6630A test set, it is necessary to determine if the problem is related to the test set rather than the E6618A:

- Is there power at the receptacle of the test set?
- Is the test set turned on? Check to see if the blue LED beside the power switch is on. Also, listen for internal fan noise to determine if the instrument cooling fans are running.
- Cable connections between the test set and the E6618A were checked earlier in the procedure.
- Is the Measurement Application running? If not, there is a software launch shortcut/icon (called LaunchXSA) on the desktop.
- Does the measurement application have the focus? (That is, is the blue window banner highlighted?) If not, move focus to the application with Alt-Tab, or by mouse-clicking in the application window.

- Review the measurement procedures being performed when the problem first appeared. Are all of the settings correct?
- If the measurement application is not functioning as expected, return the test set to a known state by pressing Mode Preset.
- Is the E6630A recognizing the E6618A hardware? (See “[Verifying the Multiport Adapter is Recognized by the E6630A](#)” on page 78.)
- Check the E6630A instrument software revision (see Step 2 of “[Checking the E6630A Test Set](#)” on page 20).

NOTE

Some settings are not affected by a Preset. If you wish to reset the test set settings, press **System, Power On, Restore Power On Defaults**.

-
- Is the measurement being performed, and the results that are expected, within the capabilities of the E6618A Multiport Adapter as specified in the product data sheet?
 - If the test set is not communicating via the LAN connection, check for the presence of blinking yellow LEDs on the rear panel LAN connector. If the ACT LED is not blinking, check the LAN cable and LAN integrity.
 - Perform an Alignment. Press **System, Alignments, Align Now, All**.
 - If the previously performed alignments did not resolve the problem, press **System, Alignments, Restore Align Defaults**. Then press **System, Alignments, Align Now, All**.
 - Is the test set displaying an error message? Error messages are listed in the Instrument Messages Guide for the E6630A, which is available at: http://www.agilent.com/find/E6630A_manuals
 - If you are using a Windows program, other than the measurement application, you may notice it running slow. Place the measurement application in single sweep/measurement.
 - For a more detailed check of the E6630A / Multiport Adapter combination, see the verification procedure in [Chapter 5](#).

Tip

You can get automatic electronic notification of new firmware releases and other product updates/information by subscribing to the *Agilent Technologies Test & Measurement E-Mail Notification Service* for your test set at <http://agilent.com/find/notifyme>

Verifying the Multiport Adapter is Recognized by the E6630A

Steps	Actions	Notes
1 Check the “Show Hardware” window.	<p>a Press System, Show, Hardware on the E6630A front panel (see the illustration below).</p> <p>b Verify that “Multi-Port Adapter” is listed in the Assembly Name column; this designates the Multiport Adapter hardware.</p>	<p>The Part #, Serial #, Mat'l Rev, Rev, OF Rev and HW Id columns for the Multiport Adapter hardware should also be populated.</p> <p>Note: if the Multiport Adapter is not listed, a possible reason for the problem is that the E6630A is running an older revision of instrument software; see “Checking the E6630A Test Set” on page 20.</p>

•

Hardware Information
 Agilent E6630A Wireless Connectivity Test Set
 Product Number: E6630A
 Serial Number: US00000001
 Instrument SW Revision: A.13.80_P0062

Assembly Name	Part #	Serial #	Mat Rev	Rev	OF Re
Multi-Port Adaptor	E661863001	79131604451	003	0	A

2 Open “Properties”	<p>a Log in as Administrator and launch the XSA application.</p> <p>b On the E6630A, go to the Start menu.</p> <p>c Select Start.</p> <p>d Hover the mouse over “Computer”, and right-click to select “Properties”.</p> <p>e Select Device Manager.</p>	See the image below.
---------------------	--	----------------------

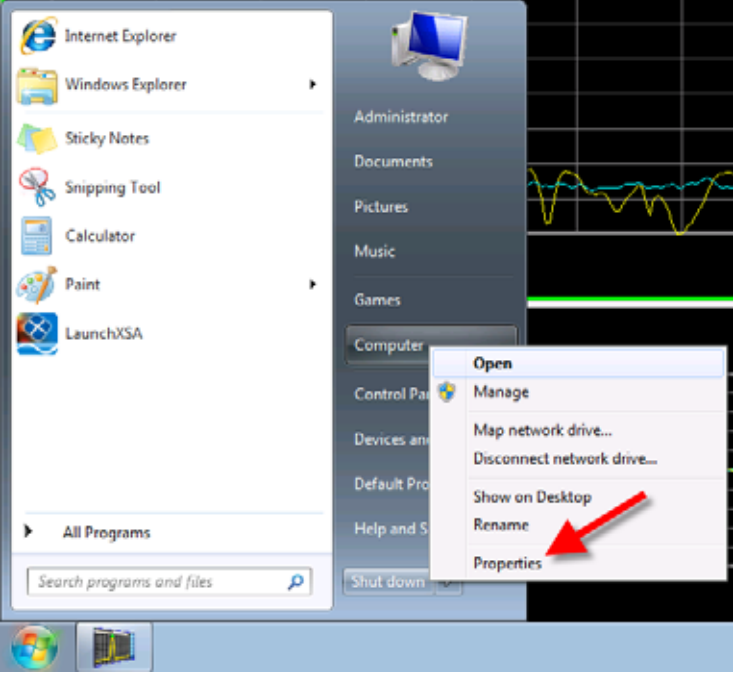
Steps	Actions	Notes
•	 <p>The image shows a Windows Start menu with a context menu open over the 'Computer' icon. The context menu includes options like 'Open', 'Manage', 'Map network drive...', 'Disconnect network drive...', 'Show on Desktop', 'Rename', and 'Properties'. A red arrow points to the 'Properties' option.</p>	
3	Open the Device Manager	See the image below.

4 Troubleshooting

Steps

Actions

Notes

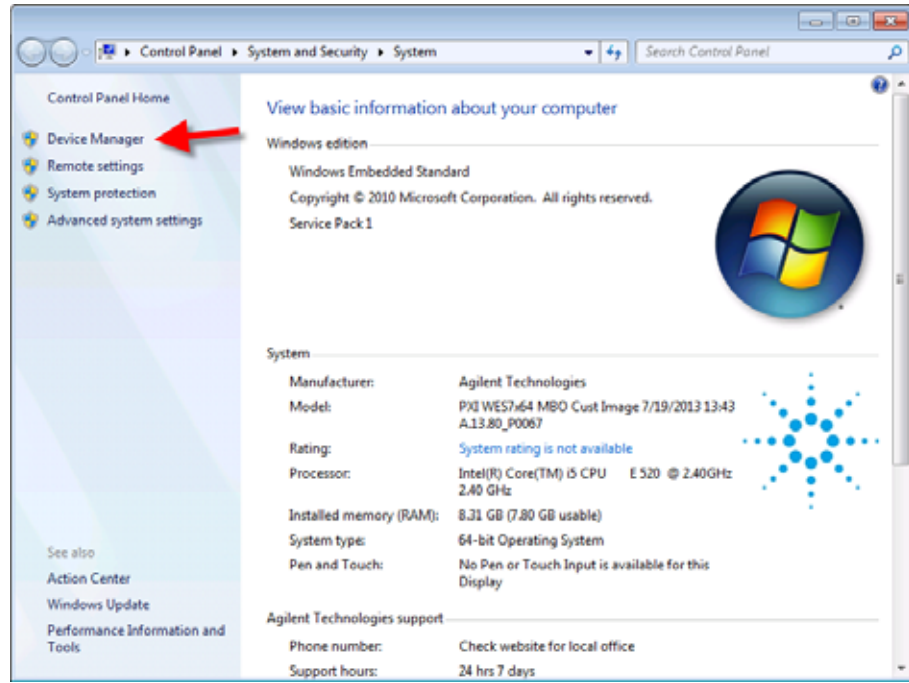

Steps	Actions	Notes
-------	---------	-------

•

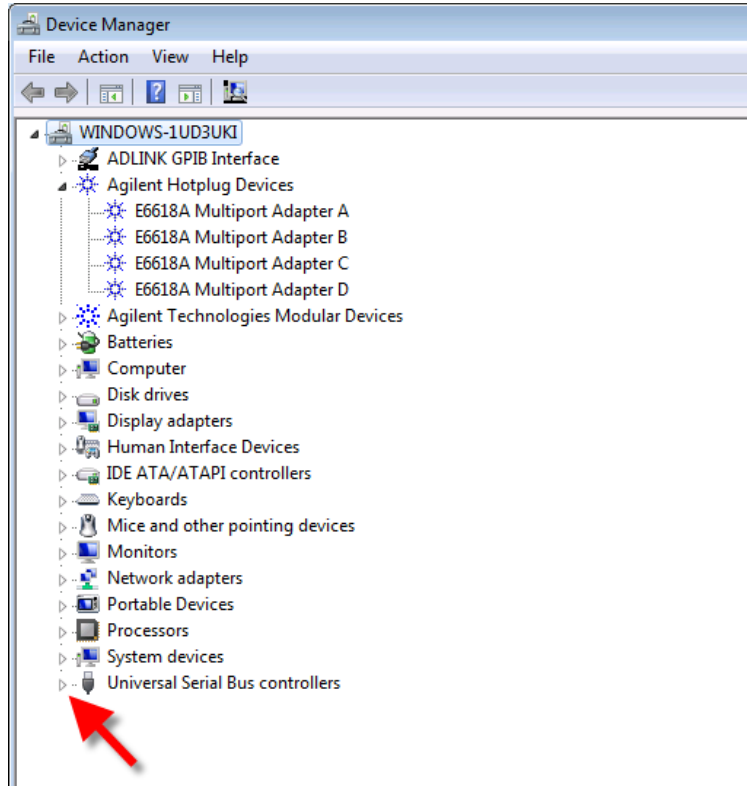

4 Expand the Universal Serial Bus controllers.	a Click the right-pointing triangle symbol.	
5 Check the entries.	a There should be several USB controller entries in the list, including 4 entries for the E6618A Multiport Adapter (A through D).	See the image below.

4 Troubleshooting

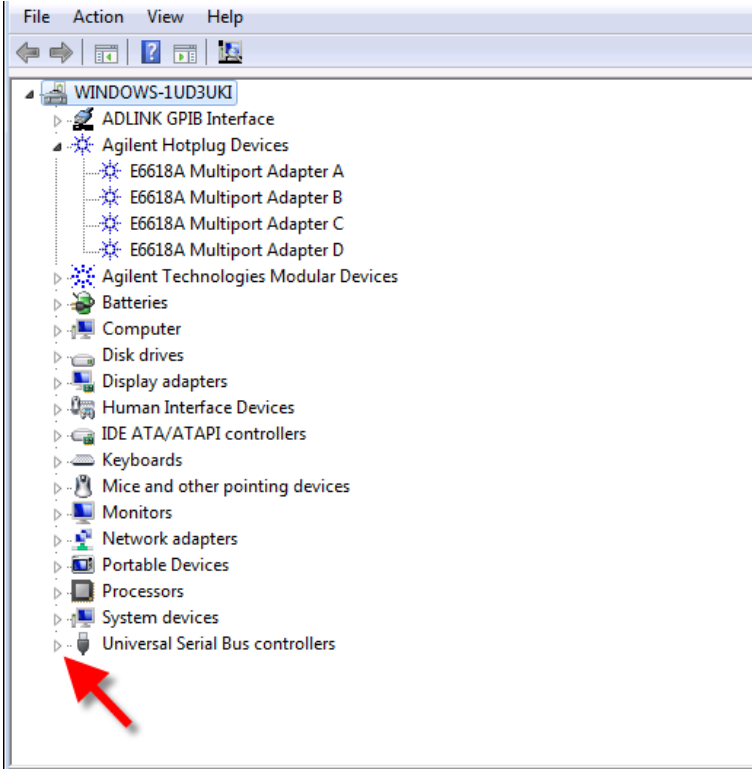
Steps	Actions	Notes
	•	 A screenshot of the Windows Device Manager window. The window title is 'WINDOWS-1UD3UK1'. The 'Device Manager' tree is expanded to show 'Universal Serial Bus controllers', which is highlighted with a red arrow. Other categories visible include 'Agilent Hotplug Devices' (expanded to show four E6618A Multiport Adapters), 'Agilent Technologies Modular Devices', 'Batteries', 'Computer', 'Disk drives', 'Display adapters', 'Human Interface Devices', 'IDE ATA/ATAPI controllers', 'Keyboards', 'Mice and other pointing devices', 'Monitors', 'Network adapters', 'Portable Devices', 'Processors', 'System devices', and 'Universal Serial Bus controllers'.
6 If the expected entries are not listed...	<p>a Power down the E6630A and E6618A.</p> <p>b Power on the E6618A and the E6630A and re-test.</p>	The E6630A must recognize the E6618A as a USB device, if the two instruments are to be used together.

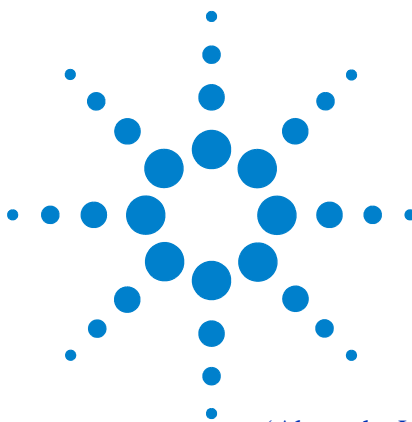

5 Verification

- ‘About the Verification Procedures’ on page 84
- ‘Verify E6630A Source Output’ on page 85
- ‘Verify E6618A RFIO 0 and RFIO 1 Ports’ on page 87
- ‘Verify Other E6618A Port Configurations’ on page 89
- ‘Verify GNSS Ports’ on page 90
- ‘System Verification Complete’ on page 91
- ‘Returning an Instrument for Service’ on page 92



About the Verification Procedures

Purpose

The verification procedures included here are used to determine if the E6618A and the E6630A are operating properly as a system. If the operation of either the E6618A or the E6630A is suspect, the verification procedures will help isolate which instrument is causing the issue. It is recommended that the procedures be followed in the order they are presented.

E6630A Requirements

Before attempting to use the E6630A and the E6618A as a system, the following requirements must be met.

1. Verify the E6630A completes a full boot-up without any errors displayed in the “MSG” field at the bottom of the screen. A reported error may cause the E6618A not to operate correctly with the E6630A. The cause of the error should be addressed before proceeding.

System Requirements

In order to use an E6618A with a E6630A, the following requirements must be met:

1. The E6630A and the E6618A are connected as described in [‘Connecting the Multiport Adapter to the E6630A and Other Devices’](#) on page 21.
2. The E6630A and the E6618A are powered on as per [‘Initializing the Multiport Adapter’](#) on page 24.
3. Verify the “USB” LED on the E6618A front panel is lit.
4. Press **System, Show, Hardware** on the E6630A and verify “Multi-Port Adaptor” is listed in the Assembly Name column. Entries should also be in the Part #, Serial #, Mat’l Rev, Rev, OF Rev and HW Id columns as well.

Verify E6630A Source Output

1. On the E6630A, press **Mode**, **IQ Analyzer (Basic)**, **Mode Preset**, **Input/Output**, **More**, **RF Output & Test Set Config**.
2. Verify the **RF Output** softkey states “RF Output”.
3. If not, press the **RF Output** softkey and select **RF Output**.
4. Press **Multiport Adapter** and verify that **Multiport Adapter** is Off.
5. Verify that the **Duplex Mode** is FDD (if not, change it to FDD.)
6. Press **Source**, **RF Output On/Off** to On.
7. Press **Amplitude** and enter **-20 dBm** to set the RF Power.
8. Press **Source** and verify the **Modulation On/Off** softkey is Off.
9. Verify the **Frequency** softkey states 2.45 GHz (if not, change it to 2.45 GHz).
10. Connect a functioning spectrum analyzer or power meter to the E6630A RF Out connector.
11. Verify the 2.45 GHz E6630A RF Output signal level is $-20 \text{ dBm} \pm 2 \text{ dB}$, as illustrated in ‘Verifying the Source Output’:

Verifying the Source Output

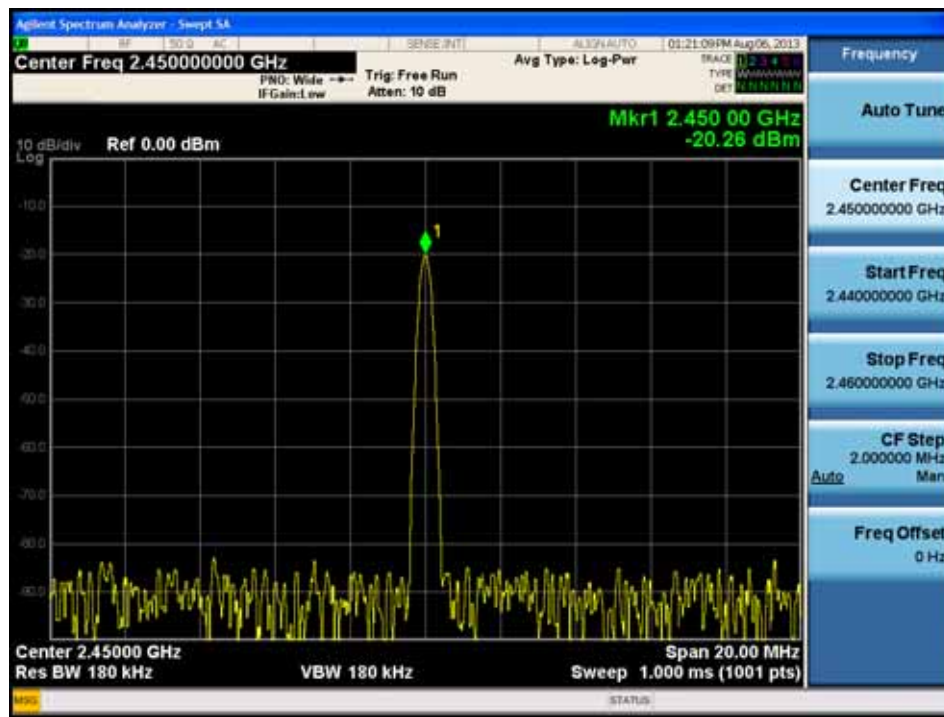

5 Verification

12. Change the source output from -20 dBm to -55 dBm by pressing the **Amplitude** softkey and entering **-55 dBm** to set the E6630A RF Output Power.
13. Verify that the E6630A source output is operating correctly by measuring -55 dBm ± 2 dB on the functioning spectrum analyzer or power meter.
14. Reset the RF Power back to -20 dBm by pressing **Source, Amplitude, -20 dBm**.

Verify E6618A RFIO 0 and RFIO 1 Ports

1. On the E6630A, press **Input/Output, RF Output & Test Set Config**.
2. Verify the **RF Output** softkey states “RF Output”. If not, press the softkey and set the output to RF Output.
3. Press **Multiport Adapter, Multiport Adapter On**.
4. Reconnect the E6630A RF Output to the E6618A RF In.
5. Verify the E6618A RF Out is connected to the E6630A RF Input.
6. Press **Output Port, RFIO 0 On/Off** to On.
7. Verify RFIO 1-7 on the E6630A softkeys are set to off.
8. Verify the Tx 0 yellow LED on the E6618A is on.
9. Verify that Tx 1-7 LED’s on the E6618A are off.
10. Connect a cable from RFIO port 0 on the E6618A to a functioning spectrum analyzer or power meter.
11. Verify the RFIO 0 output is at 2.45 GHz and -20 dBm, ± 2 dB, as measured by the spectrum analyzer or power meter.

NOTE

When the Multiport Adapter and source RF output are both set to on, the amplitude level will be calibrated at the RFIO port on the E6618A.

12. Press **Input/Output, More, RF Output & Test Set Config, Multiport Adapter, Input Port, RFIO 4**.
13. Verify the Tx 0 and Rx 4 LED’s on the E6618A are lit.
14. Disconnect the functioning spectrum analyzer or power meter from RFIO port 0.
15. Connect a cable from RFIO 0 (output) to RFIO 4 (input) on the E6618A.
16. Press **Freq, Center Freq, 2.45 GHz, Peak Search** on the E6630A and verify the E6630A now measures the 2.45 GHz signal at -20 dBm ± 2 dB as per ‘[Verifying RFIO 1 and RFIO 2](#)’ on page 88.

5 Verification

Verifying RFIO 1 and RFIO 2

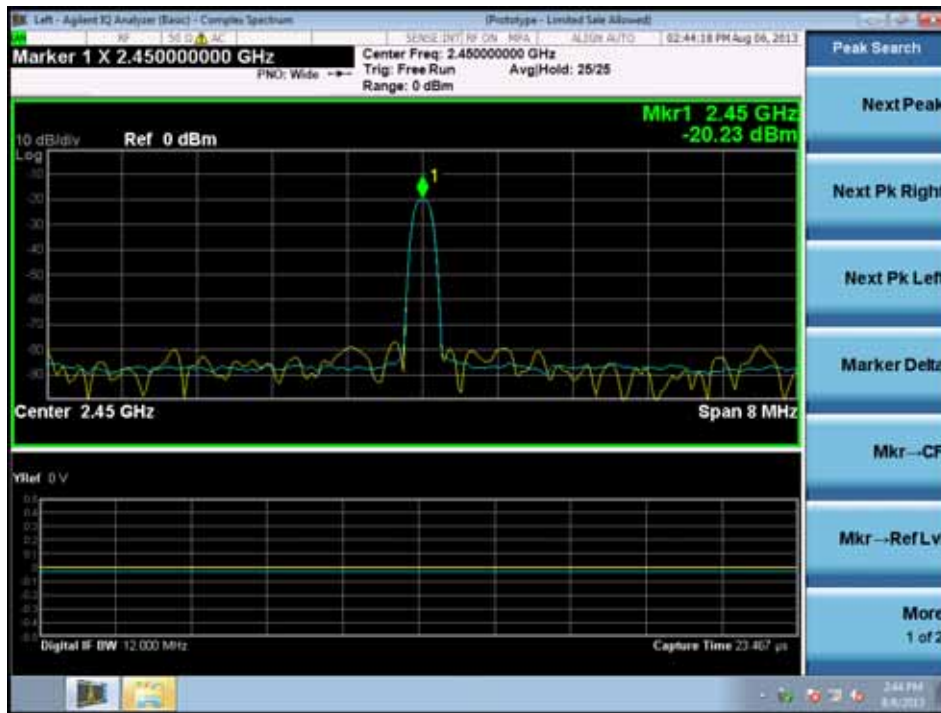

Verify Other E6618A Port Configurations

1. Using [Table 2-1](#) as example configurations, set the input and output ports via the Multiport Adapter menu (**Input/Output, More, RF Output & Test Set Config, Multiport Adapter**).
2. Adjust the E6630A source at each configuration to -20 dBm and -55 dBm by pressing **Source, Amplitude** and setting the appropriate output power level.

Measurements at -20 and -55 dBm are performed to verify that the switching of the E6618A internal attenuator is operating correctly.

Table 2-1

Input Port Setting (Rx)	Output Port Setting (Tx)	E6618A Front Panel Connection	E6630A Reading at -20 dBm Source Setting (+/- 2 dB)	E6630A Reading at -55 dBm Source Setting (+/- 2 dB)
Rx 0	Tx 4	RFIO 0 to RFIO 4		
Rx 1	Tx 5	RFIO 1 to RFIO 5		
Rx 2	Tx 6	RFIO 2 to RFIO 6		
Rx 3	Tx 7	RFIO 3 to RFIO 7		

NOTE A user can configure the Input Port number (Rx) and Output Port number (Tx) to be the same. In this configuration, the port is bi-directional; an external cable is not needed and should not be connected.

Verify GNSS Ports

1. Press **Mode Preset**.
2. Verify the connections from the E6630A to the E6618A as in [Figure 2-1](#) on page 23.
3. Press **Input/Output, More 1 of 2, RF Output & Test Set Config, RF Output, GNSS Output**.
4. Press **Multiport Adapter** and verify that the Multiport Adapter is on.
5. Verify that **Duplex Mode** is set to FDD.
6. Press **Source, Amplitude -20 dBm, Return, RF Output On/Off to On**.
7. Change **Frequency** to 1.1 GHz.
8. Connect a functioning spectrum analyzer to GNSS port 0. The 1.1 GHz signal should measure -20 dBm \pm 2 dBm. GNSS ports 1 - 3 should also measure -20 dBm \pm 2 dBm.

System Verification Complete

The E6630A and the E6618A have been configured to measure a 2.45 GHz CW signal at -20 dBm from the E6630A source output. That signal was routed through the E6618A; one port was configured for downlink (Tx) and another port configured for uplink (Rx). That signal was then routed from the E6618A RF Out to the E6630A RF Input and viewed on screen. This simple loopback test provides high confidence that the E6630A and the E6618A are fully functional.

Returning an Instrument for Service

Calling Agilent Technologies

Before returning an instrument for a service, please review the troubleshooting procedure in [Chapter 4](#) and the verification procedure in [Chapter 5](#).

Agilent Technologies has offices around the world to provide you with complete support for your instrument. To obtain servicing information or to order replacement parts, contact the nearest Agilent Technologies office (see '[Locations for Agilent Technologies](#)' on page 92). In any correspondence or telephone conversations, refer to your instrument by its product number, full serial number, and software revision.

Press **System**, **Show**, **System**, and the product number, serial number, and software revision information will be displayed on your instrument screen. A serial number label is also attached to the rear panel of the instrument.

Read the Warranty

The warranty for your instrument is in the front of your Specifications Guide. Please read it and become familiar with its terms.

If your instrument is covered by a separate maintenance agreement, please be familiar with its terms.

Service Options

Agilent Technologies offers several optional maintenance plans to service your instrument after the warranty has expired. Call your Agilent Technologies office for full details.

If you want to service the instrument yourself after the warranty expires, you can purchase the service documentation that provides all necessary test and maintenance information.

You can order the service documentation, *Option OBW* (assembly level troubleshooting information) through your Agilent Technologies office.

Locations for Agilent Technologies

Online assistance: <http://www.agilent.com/find/assist>

Americas

Canada
1 877 894 4414

Latin America
(305) 269 7500

United States
1 800 829 4444

Asia Pacific

Australia
1 800 629 485

India
1 800 112 929

Malaysia
1 800 888 848

Thailand
1 800226 008

Europe & Middle East

Austria
43 (0) 1 360 277 1571

Finland
358 (0) 10 855 2100

Ireland
1890 924 204

Netherlands
31 (0) 20 547 2111

Switzerland
0800 80 53 53

China
800 810 0189

Japan
0 120 (421) 345

Singapore
1 800 375 8100

Belgium
32 (0) 2 404 93 40

France
0825 010 700*
*0.125 Euros/minute

Israel
972-3-9288-504/544

Spain
34 (91) 631 3300

United Kingdom
44 (0) 118 9276201

Hong Kong
800 938 693

Korea
080 769 0800

Taiwan
0800 047 866

Denmark
45 70 13 15 15

Germany
49 (0) 7031 464 6333

Italy
39 02 92 60 8484

Sweden
0200-88 22 55

Packaging the Instrument

Use original packaging or comparable. It is best to pack the unit in the original factory packaging materials if they are available.

CAUTION

Instrument damage can result from using packaging materials other than those specified. Never use styrene pellets in any shape as packaging materials. They do not adequately cushion the equipment or prevent it from shifting in the carton. They cause equipment damage by generating static electricity and by lodging in the instrument louvers, blocking airflow.

You can repackage the instrument with commercially available materials, as follows:

Step	Notes
1	Wrap the instrument in antistatic plastic to reduce the possibility of damage caused by electrostatic discharge.
2	Use a strong shipping container. The carton must be both large enough and strong enough to accommodate the instrument. A double-walled, corrugated cardboard carton with 159 kg (350 lb) bursting strength is adequate. Allow at least 3 to 4 inches on all sides of the instrument for packing material.
3	Surround the equipment with three to four inches of packing material and prevent the equipment from moving in the carton. If packing foam is not available, the best alternative is plastic bubble-pak. This material looks like a plastic sheet filled with 1-1/4 inch air bubbles. Use the pink-colored bubble which reduces static electricity. Wrapping the equipment several times in this material should both protect the equipment and prevent it from moving in the carton.
4	Seal the shipping container securely with strong nylon adhesive tape.
5	Mark the shipping container “ FRAGILE, HANDLE WITH CARE ” to assure careful handling.
6	Retain copies of all shipping papers.

A

Agilent Technologies
 calling, 92
 locations, 92
amplitude corrections, 46
antenna unit, 51

B

basic check, 76
bitmap, 42

C

check the basics, 76
checking the E6618A, 76
checking the E6630A test set, 76
cleaning, 17
compliance with regulations, 19
configuring ports, 39
connecting to E6630A, 21
connectors, front panel, 30
contents of shipment, 12
cooling the instrument, 13
corrections, 46
 amplitude, 65
 analyzer, 61
 antenna unit, 51
 apply, 69
 comment, 57
 delete, 68
 delete all, 70
 delete point, 66
 description, 56
 edit, 63
 frequency, 65
 frequency interpolation, 52
 insert point below, 66
 navigate, 64
 on/off, 48
 properties, 49
 recall, 73
 remote commands, 71
 RF port, 58
 RFIO, 59
 scale X-axis, 67
 select, 47, 50
 source, 60
 source and analyzer, 62

D

device recognition, 78
dimensions, 13
disconnecting power, 13, 27
display, 33
display indicators, 33

E

- E6618A, 76
- E6630A
 - checking, 20
 - communication with, 38
 - connecting to multiport adapter, 21
- E6630A display, 33
- E6630A test set, 76
- electrostatic discharge (ESD)
 - protecting against, 18
- environmental conditions, 15

F

- FPGA code version, 27
- front panel
 - connections, 23
 - connectors and keys, 30
 - symbols, 34
- front panel features, 29
- fuses, 14

G

- GNSS input port, 41
- GNSS output port, 43
- GNSS port verification, 90

I

- initializing, 24
- input port
 - multiport adapter GNSS, 41
 - multiport adapter RFIO, 41
 - test set, 39
- inspection, 12
- instrument location, 13
- instrument maintenance, 17
- instrument operation, 37
- instrument turn-on, 20
- instrument ventilation, 13
- interpolation, 52

K

- keys, 30

L

- line voltage, 14
- locating the instrument, 13

M

- maintenance, 17

- multiport adapter
 - activating/deactivating, 40
 - output mode, 73
- multiport adapter GNSS input port, 41

O

- operation, 37
- output mode, 73
- output port, 42, 43, 44
 - test set, 39
- overpowering, 16

P

- packaging, 94
- port
 - input, 41
 - multiport adapter GNSPS output, 43
 - multiport adapter RFIO output, 42, 44
- port configuration, 39, 40
- power cords, 15
- power disconnection, 13, 27
- power protection, 16
- power requirements, 14
- power source, 14
- problems with shipment, 12

Q

- quick-start, 9

R

- rack mounting, 13
- rear panel
 - connections, 32
 - features, 32
 - symbols, 34
- rear panel features, 29
- recall amplitude correction, 73
- regulatory compliance, 19
- requirements
 - E6630A, 84
 - system, 84
- returning an instrument, 92
- RFIO input port, 41
- RFIO output port, 42, 44
- RFIO port verification, 87

S

- select corrections, 47
- service, 92
- service options, 92
- shipment contents, 12
- shipping problems, 12
- source output verification, 85

symbols, on front and rear panels, [34](#)
system requirements, [84](#)

T

test set
 communication with, [38](#)
test set display, [33](#)
test set input port, [39](#)
test set output port, [39](#)
troubleshooting, [75](#)
turn-on, [20](#)

U

URL
 sales and service, [92](#)
USB device recognition, [78](#)

V

verification, [83](#)
 GNSS ports, [90](#)
 other E6618A port configurations, [89](#)
 RFIO ports, [87](#)
 source output, [85](#)
verifying contents, [12](#)
verifying FPGA code version, [27](#)

W

warranty, [92](#)
weight, [13](#)