

Keysight Technologies

N5397A FPGA Dynamic Probe for Xilinx Compatible with Infiniium MSO90000 X-Series, MSO9000 Series, and MSO S-Series Oscilloscopes

Data Sheet

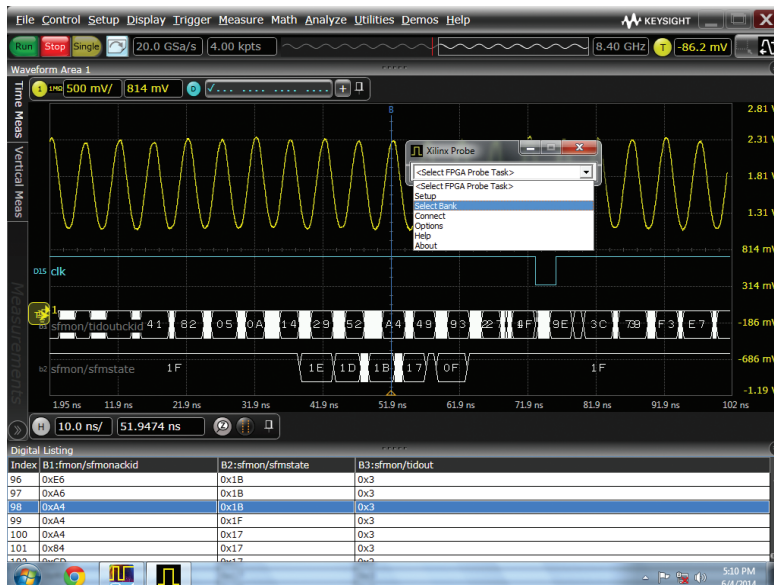

The Challenge

You rely on the insight a MSO (mixed-signal oscilloscope) provides to understand the behavior of your FPGA in the context of the surrounding system. Design engineers typically take advantage of the programmability of the FPGA to route internal nodes to a small number of physical pins for debugging. While this approach is very useful, it has significant limitations.

- Since pins on the FPGA are typically an expensive resource, there are a relatively small number available for debug. This limits internal visibility (i.e. one pin is required for each internal signal to be probed).
- When you need to access different internal signals, you must change your design to route these signals to the available pins. This can be time consuming and can affect the timing of your FPGA design.
- Finally, the process required to map the signal names from your FPGA design to the MSO digital channel labels is manual and tedious.

When new signals are routed out, you need to manually update these signal names on the MSO, which takes additional time and is a potential source of confusing errors.

Debug your FPGAs faster and more effectively with a MSO

A Better Way – Collaborative development between Keysight Technologies, Inc. and Xilinx have produced a faster and more effective way to use your logic analyzer to debug FPGAs and the surrounding system. The Keysight FPGA dynamic probe, used in conjunction with a Keysight MSO, provides the most effective solution for simple through complex debugging.

View internal activity – With the digital channels on your MSO, you are normally limited to measuring signals at the periphery of the FPGA. With the FPGA dynamic probe, you can now access signals internal to the FPGA. You can measure up to 64 internal signals for each external pin dedicated to debug, unlocking visibility into your design that you never had before.

Make multiple measurements in seconds – Moving probe points internal to an FPGA used to be time consuming. Now, in less than a second, you can easily measure different sets of internal signals without design changes. FPGA timing stays constant when you select new sets of internal signals for probing.

Leverage the work you did in your design environment – The FPGA dynamic probe maps internal signal names from your FPGA design tool to your Keysight MSO. Eliminate unintentional mistakes and save hours of time with this automatic setup of signal and bus names on your MSO.

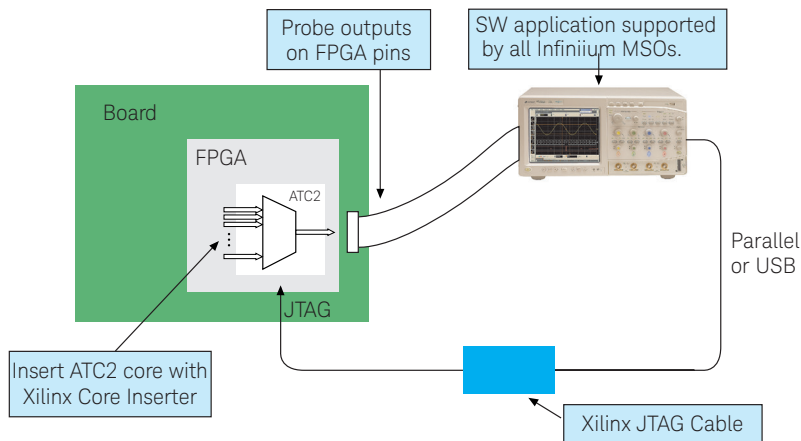

Figure 1. Create a timesaving FPGA measurement system. Insert an ATC2 (Keysight Trace Core) core into your FPGA design. With the application running on your MSO you control which group of internal signals to measure via JTAG.

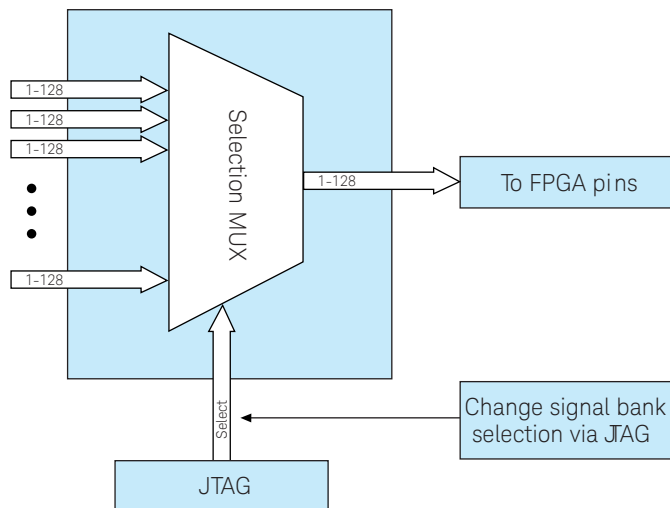
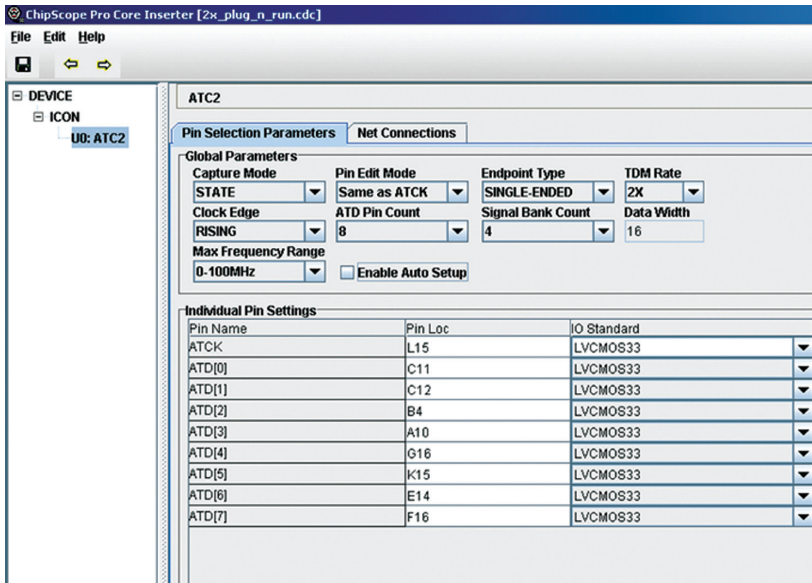

Figure 2. Access up to 64 internal signals for each debug pin. Signal banks all have identical width (1 to 128 signals wide) determined by the number of device pins you devote for debug. Each pin provides sequential access to one signal from every input bank.

A quick tour of the application

Design step 1: Create the ATC2 core

Use Xilinx Core Inserter or EDK to select your ATC2 parameters and to create a debug core that best matches your development needs. Parameters include number of pins, number of signal banks, the type of measurement (state or timing), and other ATC2 attributes.



Design step 2: Select groups of signals to probe

Specify banks of internal signals that are potential candidates for MSO measurements (using Xilinx Core Inserter or EDK).

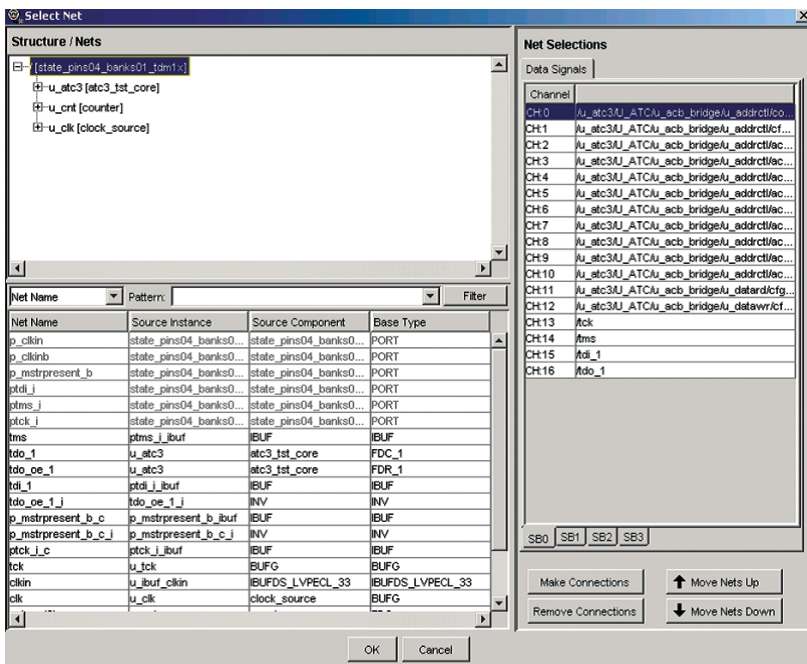

A quick tour of the application (continued)

Activate FPGA dynamic probe for Xilinx

The FPGA dynamic probe application allows you to control the ATC2 core and set up the MSO for desired measurements.

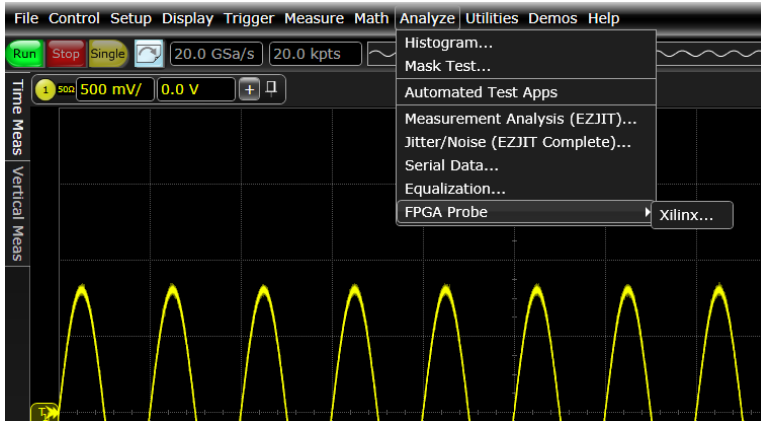

Measurement setup step 1: Establish a connection between the MSO and the ATC2 core

The FPGA dynamic probe application establishes a connection between the MSO and a Xilinx cable. It also determines what devices are on the JTAG scan chain and lets you pick which one you wish to communicate with. Core and device names are user definable.

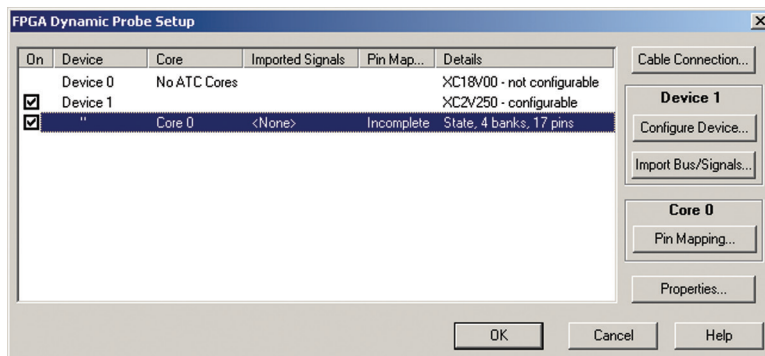

A quick tour of the application (continued)

Measurement setup step 2: Map PGA pins

Quickly specify how the FPGA pins (the signal outputs of ATC2) are connected to your MSO. Select your probe type and rapidly provide the information needed for the MSO to automatically track names of signals routed through the ATC2 core.

For ATC2 cores with auto setup enabled, each pin of the ATC2 core, one at a time, produces a unique stimulus pattern. The instrument looks for this unique pattern on any of its acquisition channels. When the instrument finds the pattern, it associates that instrument channel with the ATC2 output pin producing it. It then repeats the process for each of the remaining output pins eliminating the need to manually enter probe layout information.

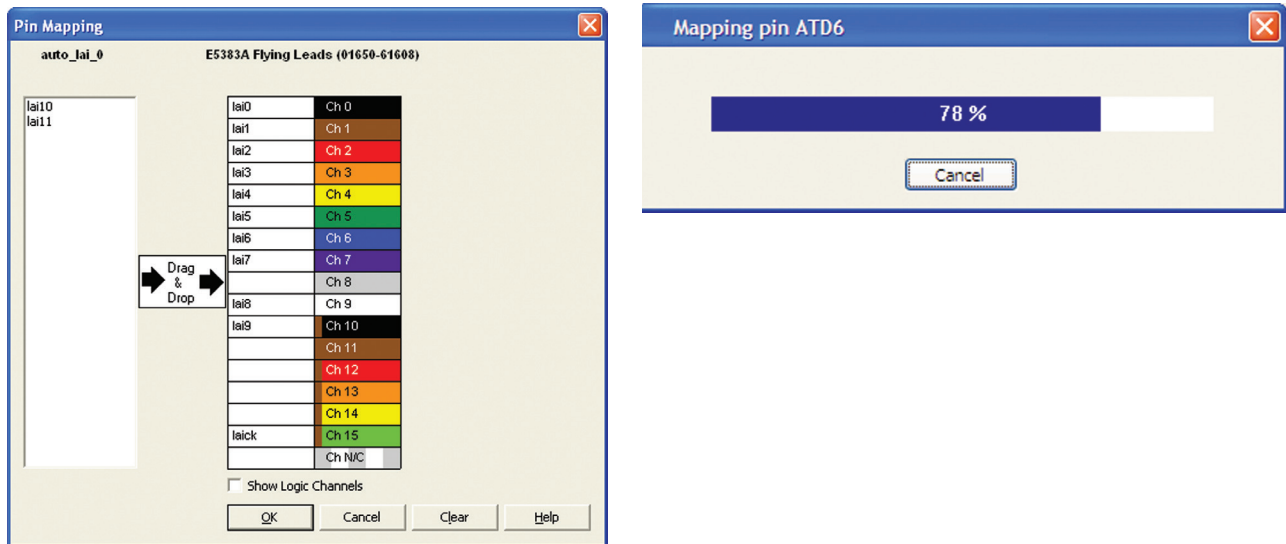

Measurement setup step 3: Import signal names

Tired of manually entering bus and signal names on your MSO? The FPGA dynamic probe application reads a .cdc file produced by Xilinx Core Inserter. The names of signals you measure will now automatically show on your MSO digital channel labels.

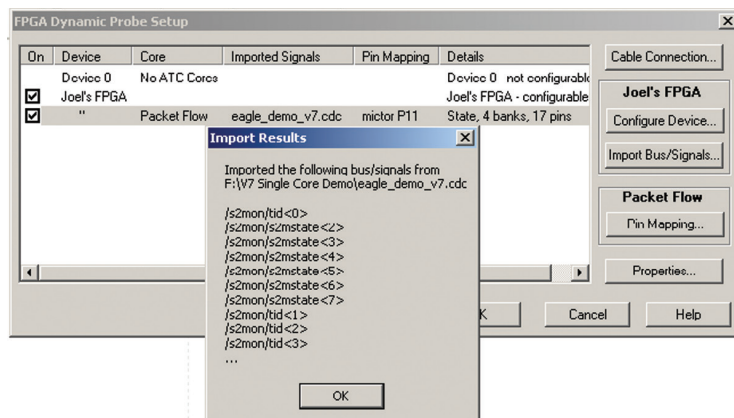

A quick tour of the application (continued)

Setup complete: Make measurements

Quickly change which signal bank is routed to the MSO. A single mouse click tells the ATC2 core to switch to the newly specified signal bank without any impact to the timing of your design. To make measurements throughout your FPGA, change signal banks as often as needed. User-definable signal bank names make it straight forward to select a part of your design to measure.

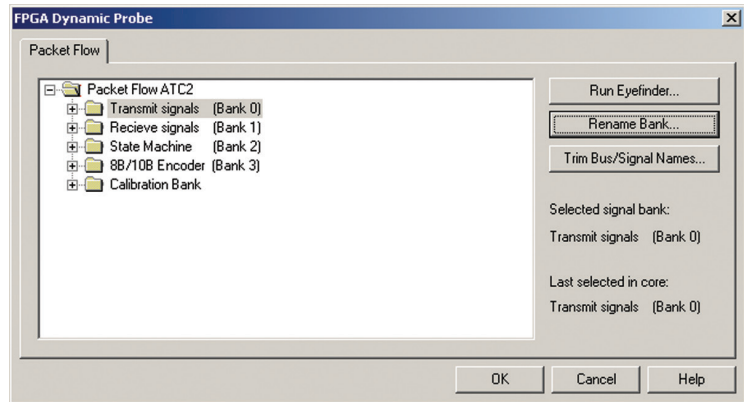

Make state measurements with your MSO

MSOs incorporate some logic analysis state capabilities useful for making FPGA measurements. Using pattern trigger, setup a state trigger on ATC2 clock output edge and desired digital pattern. After acquiring the data, use the post-processing "State clock" feature to transform the timing waveforms into state waveforms. Valid states are shown and invalid states are filtered. Any of the 16 digital channels or any of the analog channels can be set as the state clock. Using an analog channel state clock allows you to retain all 16 digital channels for bus measurement.

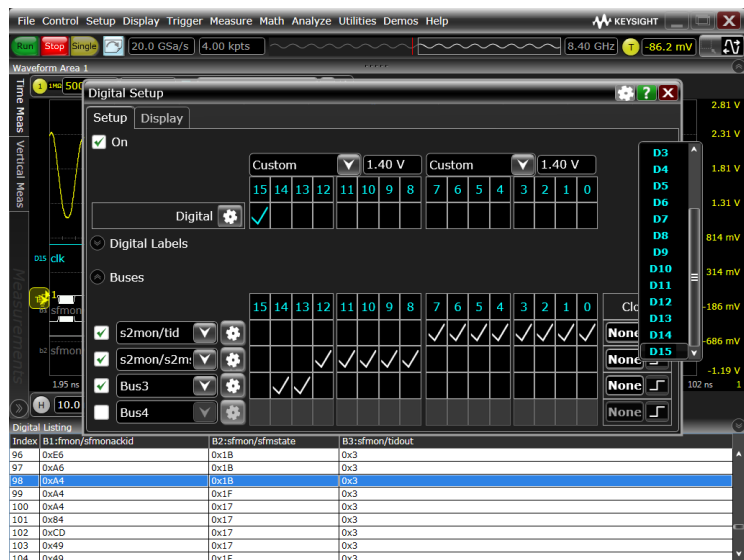

Correlate internal FPGA activity with external measurements

View internal FPGA activity and time-correlate internal FPGA measurements with external analog and digital events in the surrounding system. FPGA Dynamic Probe unlocks the power of the MSO for system-level debug with FPGAs.

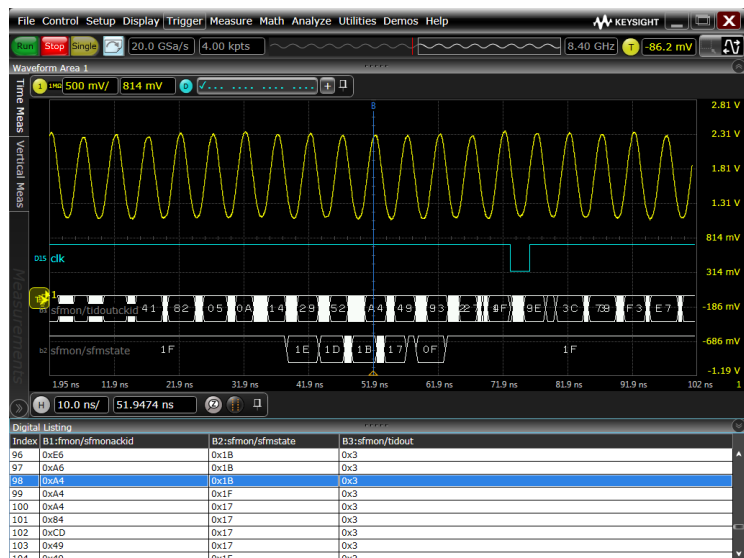

Keysight N5397A specifications and characteristics

Supported logic analyzers

Standalone oscilloscopes	All Infiniium S-Series, 9000A, 90000 X-, and 9000 H-Series MSOs
MSO Digital Channels	16
Bus groupings	Up to 4, each with 16 character labels
Triggering capabilities	Determined by MSO, all have state triggering
Supported Xilinx FPGA families	Zynq-7000/7000Q, Artix-7/7Q, Kintex-7/7Q, Virtex-7/7Q, Virtex-6/6Q, Virtex-5/5Q/5QV, Virtex-4/4Q/4QV, Spartan-6/6Q, Spartan-3A, 3AN, and 3E
Supported Xilinx cables (required)	Platform cable USB, platform cable USB II
Supported probing mechanisms	Soft touch (34-channel and 17-channel), Mictor, Samtec, flying lead, Infiniium MSOs MSOs come standard with a 40 pin probe cable and flying leads. Probing for Mictor, soft touch, or Samtec probing must be purchased separately.

Keysight trace core characteristics

Number of output signals	User definable: Clock line plus 4 to 128 signals in 1 signal increments
Signal banks	User definable: 1, 2, 4, 8, 16, 32, or 64
Modes	State (synchronous) or timing (asynchronous) mode
FPGA Resource consumption	Approximately 1 slice required per input signal to ATC2 Core Consumes no BUFPGs, DCM or Block RAM resources.
Features with application	Mouse-click bank select, graphical pin mapping, cdc signal name import, auto-pin mapping, and ATC2 "always on" option

Compatible design tools

ISE ChipScope Pro version	Keysight FPGA dynamic probe SW version
14.3 or greater	2.7 or greater
Vivado	Designs using Vivado not currently supported
Synthesis	Core Inserter produces ATC2 cores post-synthesis (pre-place and route) making the cores synthesis independent. ATC2 cores produced by Core. Generator are compatible with: <ul style="list-style-type: none"> - Exemplar Leonardo Spectrum - Synopsys Design Compiler - Synopsys Design Compiler II - Synopsys FPGA Express - Synplicity Synplify - Xilinx XST

Additional information available via the Internet: www.keysight.com/find/FPGA

Ordering information

Ordering options for the Keysight N5397A FPGA dynamic probe for Xilinx

Option 001 Entitlement certificate for perpetual node-locked license locked to oscilloscope.

Related literature

Publication title	Publication type	Publication number
<i>Frequently Asked Questions for Keysight MSO FPGA Dynamic Probe for Xilinx</i>	Data Sheet	5989-5976EN
<i>Infiniium S-Series Oscilloscopes</i>	Data Sheet	5991-3904EN
<i>Infiniium 9000 Series Oscilloscopes</i>	Data Sheet	5990-3746EN
<i>Infiniium 9000 H-Series Oscilloscopes</i>	Data Sheet	5991-1520EN
<i>Infiniium 90000 X-Series Oscilloscopes</i>	Data Sheet	5990-5271EN

Product web site

For the most up-to-date and complete application and product information, please visit our product Web site at: www.keysight.com/find/scopes

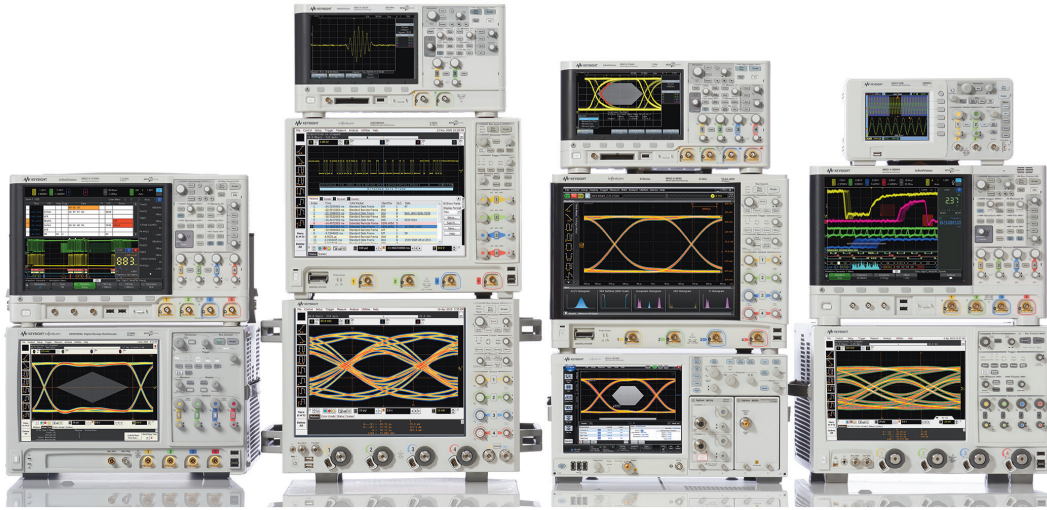

Keysight Technologies Oscilloscopes

Multiple form factors from 20 MHz to > 90 GHz | Industry leading specs | Powerful applications

myKeysight

myKeysight

www.keysight.com/find/mykeysight

A personalized view into the information most relevant to you.



www.lxistandard.org

LAN eXtensions for Instruments puts the power of Ethernet and the Web inside your test systems. Keysight is a founding member of the LXI consortium.



Three-Year Warranty

www.keysight.com/find/ThreeYearWarranty

Keysight's commitment to superior product quality and lower total cost of ownership. The only test and measurement company with three-year warranty standard on all instruments, worldwide.



Keysight Assurance Plans

www.keysight.com/find/AssurancePlans

Up to five years of protection and no budgetary surprises to ensure your instruments are operating to specification so you can rely on accurate measurements.



www.keysight.com/quality

Keysight Technologies, Inc.
DEKRA Certified ISO 9001:2008
Quality Management System

Keysight Channel Partners

www.keysight.com/find/channelpartners

Get the best of both worlds: Keysight's measurement expertise and product breadth, combined with channel partner convenience.

www.keysight.com/find/fpga

For more information on Keysight Technologies' products, applications or services, please contact your local Keysight office. The complete list is available at: www.keysight.com/find/contactus

Americas

Canada	(877) 894 4414
Brazil	55 11 3351 7010
Mexico	001 800 254 2440
United States	(800) 829 4444

Asia Pacific

Australia	1 800 629 485
China	800 810 0189
Hong Kong	800 938 693
India	1 800 112 929
Japan	0120 (421) 345
Korea	080 769 0800
Malaysia	1 800 888 848
Singapore	1 800 375 8100
Taiwan	0800 047 866
Other AP Countries	(65) 6375 8100

Europe & Middle East

Austria	0800 001122
Belgium	0800 58580
Finland	0800 523252
France	0805 980333
Germany	0800 6270999
Ireland	1800 832700
Israel	1 809 343051
Italy	800 599100
Luxembourg	+32 800 58580
Netherlands	0800 0233200
Russia	8800 5009286
Spain	0800 000154
Sweden	0200 882255
Switzerland	0800 805353
	Opt. 1 (DE)
	Opt. 2 (FR)
	Opt. 3 (IT)
United Kingdom	0800 0260637

For other unlisted countries:
www.keysight.com/find/contactus
(BP-07-10-14)

