

# N5413B and N5413C DDR2 and LPDDR2 Compliance Test Application

For Infiniium 9000 and 90000 Series Oscilloscope

Data Sheet

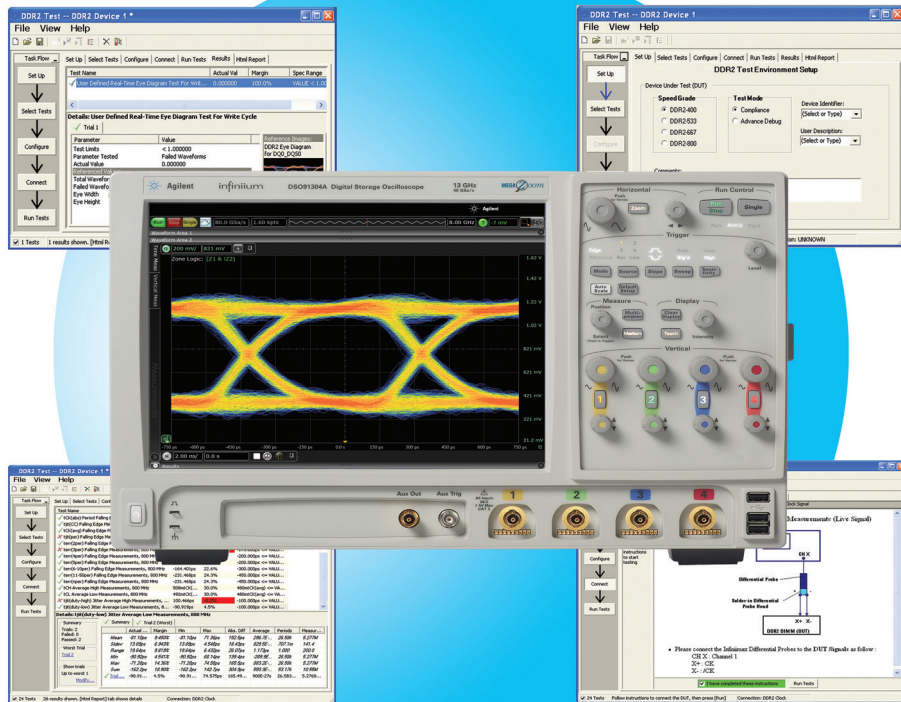

## Test, debug and characterize your DDR2 and LPDDR2 designs quickly and easily

The Agilent Technologies DDR2 and LPDDR2 compliance test application provides a fast and easy way to test, debug and characterize your DDR2 and LPDDR2 designs. The tests performed by the DDR2 compliance test software are based on the JEDEC<sup>1</sup> JESD79-2E DDR2 SDRAM Specification JESD208 Speciality DDR2-1066 SDRAM

Specification and Intel<sup>®</sup> DDR2 667/800 JEDEC Specification Addendum Rev. 1.1. The tests performed by the LPDDR2 compliance test software are based on the JEDEC(1) JESD209-2 LPDDR2 Specification. In addition, both the DDR2 and LPDDR2 test application features Custom mode, which covers crucial measurements

such as eye-diagram, mask testing, ringing and other tests that are not covered in the specifications but are critical for characterizing DDR2 and LPDDR2 devices. The test application offers a user-friendly setup wizard and a comprehensive report that includes margin analysis.

1. The JEDEC (Joint Electronic Device Engineering Council) Solid State Technology Association is a semiconductor engineering standardization body of the Electronic Industries Alliance (EIA), a trade association that represents all areas of the electronic industry.



DDR2 represents an evolutionary upgrade to DDR for memory systems. DDR2 promises higher bandwidth, smaller chip footprints, less power consumption, and less heat generation. DDR2 achieves this with a number of innovations including the use of modern fine ball-grid array (FBGA) packaging, lower supply power and on-die termination for improved control of signal integrity.

LPDDR2 also presents similar technology improvement as DDR2 with significant reduced power by scaling down the voltage of DDR2 from 1.8V to 1.2V

Signal integrity is crucial for memory system interoperability. Reference clock jitter measurements help you ensure that jitter is well within the specifications, which is the key to reliable and interoperable modular memory systems. At the same time, electrical and timing characteristics of signals are critical as well, to ensure the memory system functions correctly and stays error free.

The addition of the DDR2 and LPDDR2 debug tool helps memory designers perform pre- and post-compliance testing with saved oscilloscope waveform traces. The tool allows for navigation capability with measurement markers to help navigate to problem areas for further testing.

The DDR2 and LPDDR2 compliance test application is compatible with Agilent 9000 and 90000 Series Infiniium oscilloscopes.

## Features

The N5413B DDR2 and LPDDR2 compliance test application offers several features to simplify the validation of your DDR2 and LPDDR2 designs:

- Setup wizard for quick setup, configuration and test
- Execution speed and proven test algorithm for clock test, which minimizes your compliance test time
- User-selected tests and configurations based on JEDEC JESD79-2E and JESD208 DDR2 SDRAM with an option to turn on JESD209-2 LPDDR2 data rate and user-defined speed for embedded designs
- Unique technique to provide read-write burst signal separation on the same bus in real-time mode, allowing powerful debug and analysis
- Ability to analyze the loading effect of adjacent RANK of the same memory channel
- Test framework provides powerful characterization through multiple trials that show a full array of statistics for each measurement and returns the worst measurement value
- Automatically perform derating table calculations for setup and hold time measurements based on slew rate
- DDR debug tool allows for navigation to areas of interest in a saved set of waveforms with JEDEC measurement for pre- and post-compliance testing.

## Comprehensive Test Coverage

With the DDR2 and LPDDR2 compliance test application, you can use the same oscilloscope you use for everyday debugging to perform automated testing and margin analysis based on the JEDEC electrical and timing specifications. The application automatically configures the oscilloscope for each test and provides informative results. It includes margin analysis indicating how close your device comes to passing or failing the test for each specification.

Some of the difficulties in performing the compliance tests are connecting to the target device, configuring the oscilloscope, performing the tests and analyzing the measured results. The DDR2 and LPDDR2 compliance test application does most of this work for you. If you discover a problem with your device, the Custom mode feature in the test application and debug tools in the oscilloscope are available to aid in root-cause analysis.

# Easy Test Definition

The test application enhances the usability of Agilent Infiniium oscilloscopes for testing DDR2 and LPDDR2 devices. The Agilent automated test framework guides you quickly through the steps required to define the setup, perform the tests and view the test results. On the environmental setup page, you can select the type of DDR2 or LPDDR2 devices, and the framework automatically filters the tests based on your selection. You can then select a category of tests or specify individual tests. The user interface is designed to minimize unnecessary reconnections, which saves time and minimizes potential operator error. You can save the tests and configurations as project files and recall them later for quick testing and review of previous results. Clear menus let you perform tests with minimum mouse clicks.

DDR debug tool is a license tool that enables JEDEC measurement on saved waveform traces with navigation capability and markers to identify problem areas for debug and margin testing.

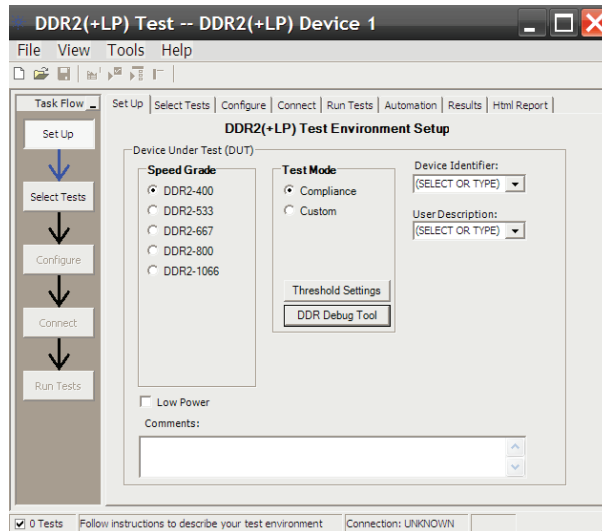

Figure 1. The new test setup screen. Select Compliance or Replace with Custom test mode and the speed grade of your device.

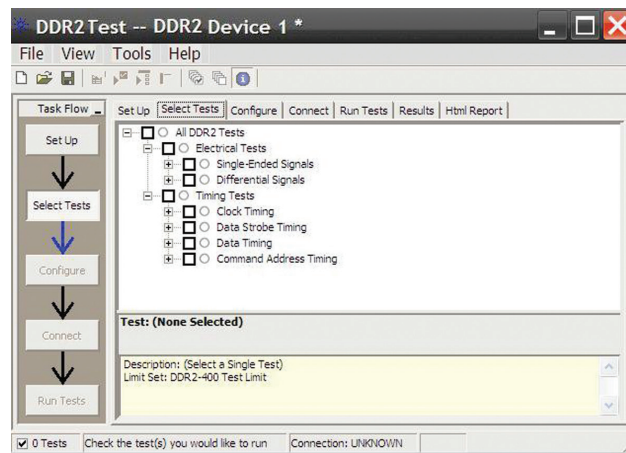

Figure 2. The Agilent automated test engine filters the test selection based on your test setup. You can easily select individual tests or groups of tests with a mouse-click.

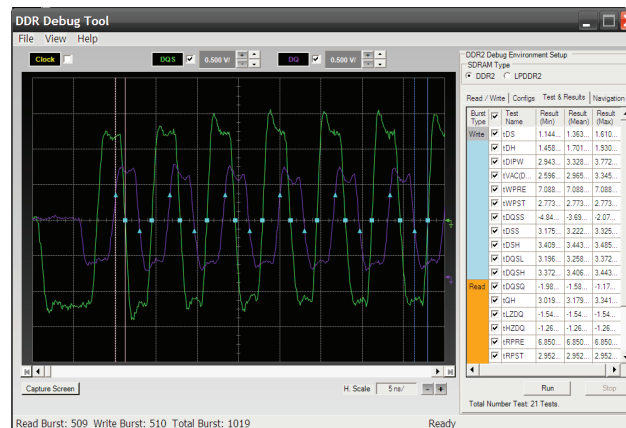

Figure 3. DDR debug tool enables markers to help navigate to bursts of interests with JEDEC measurements and statistical results.

# Configurability and Guided Connection

The DDR2 and LPDDR2 compliance test application provides flexibility in your test setup. The DDR2 and LPDDR2 compliance test application provides you with user-defined controls for critical test parameters such as voltage threshold values, number of waveforms used for analysis and customizable violation settings. Once you have configured the tests, the connection page will display the connection diagram for the test you have selected.

With the multiple test trial capability, you can extensively characterize the performance of your DDR2 devices. You can run the selected tests until the stop condition is met. The application will then save the worst-case conditions and help you track down the anomalies in your signals.

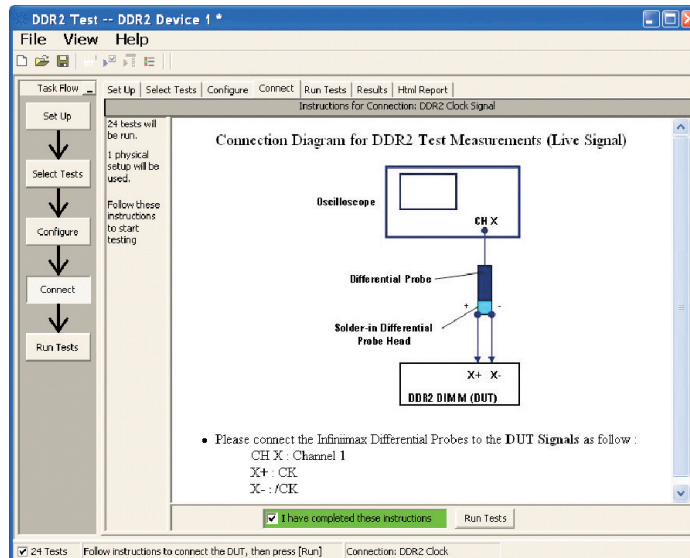

Figure 4. The software prompts you with the connection diagrams for the tests you have selected.

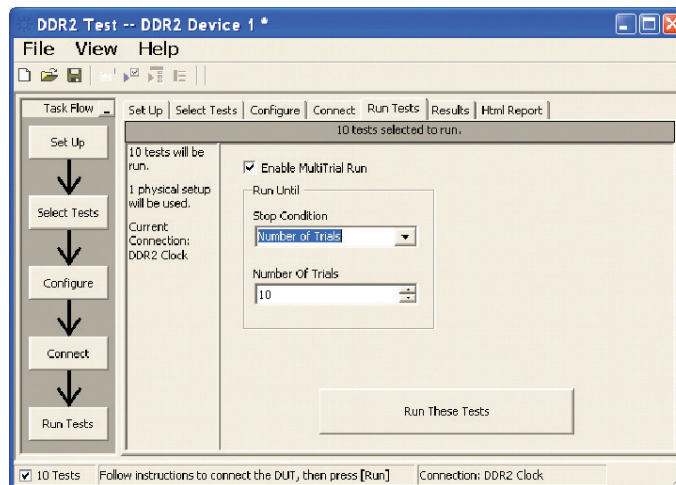

Figure 5. The new Repetitive Run feature allows you to run the selected tests until the stop condition is met. It allows you to extensively test the performance of your device.

In addition to providing you with measurement results, the DDR2 and LPDDR2 compliance test application reports how close you are to the specified limit. You can specify the level at which warnings are to be issued. You are provided with a full array of statistics for each measurement, and you can save worst-case conditions to extensively test the performance of your device.

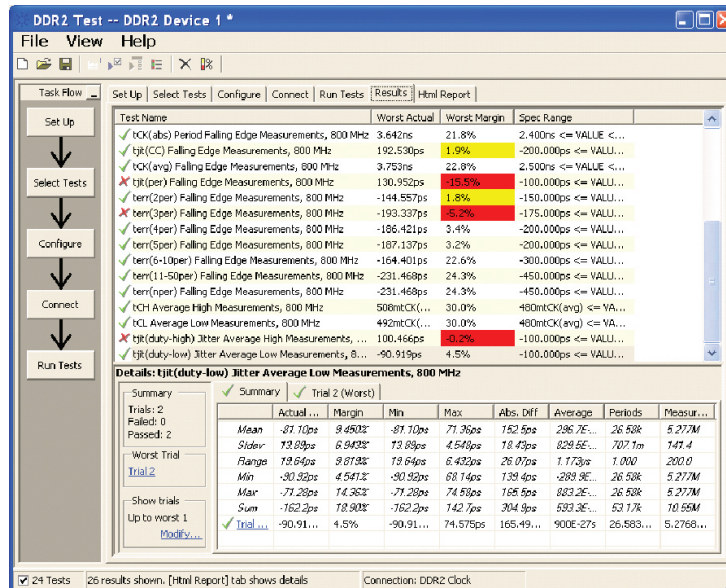

Figure 6. The DDR2 test application documents your test parameters, pass or fail status, test specification range, measured values and the pass/fail margin.

# Thorough Performance Reporting

The DDR2 and LPDDR2 compliance test application generates thorough HTML reports that capture the performance, status and margins of your device. It also captures screen shots of critical measurements for your reference and documentation. This report is suitable for printing and sharing with your vendors, customers or colleagues.

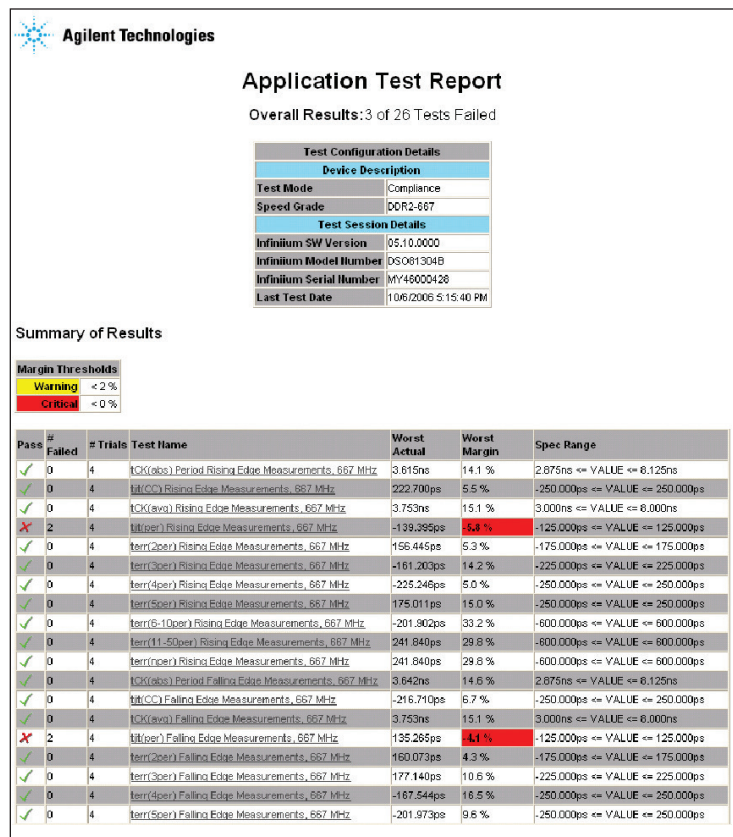

Figure 7. The test application generates a summary report where you can see your device's test results quickly and clearly. Details are available for each test including the test limits, test description and test results, including saved waveforms. In addition, the pass/fail margin is indicated to give you further insight.

# Extensibility

You may add additional custom tests or steps to your application using the User Defined Application (UDA) development tool ([www.agilent.com/find/uda](http://www.agilent.com/find/uda)). Use UDA to develop functional “Add-Ins” that you can plug into your application.

Add-ins may be designed as:

- Complete custom tests (with configuration variables and connection prompts)
- Any custom steps such as pre/post processing scripts, external instrument control and your own device control

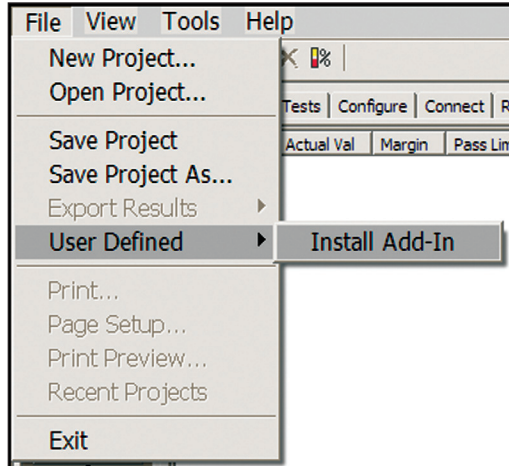

Figure 8. Importing a UDA Add-In into a compliance application.

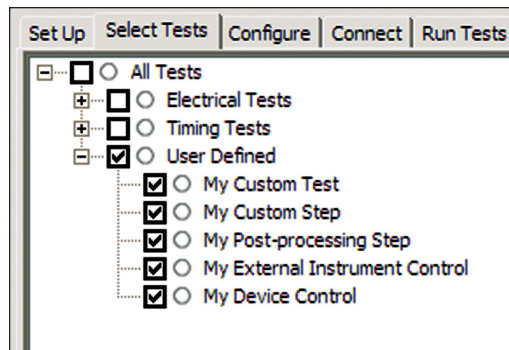

Figure 9. UDA Add-In tests and utilities in your test application.

# Automation

You can completely automate execution of your application's tests and Add-Ins from a separate PC using the included N5452A Remote Interface feature (download free toolkit from [www.agilent.com/find/scope-apps](http://www.agilent.com/find/scope-apps)). You can even create and execute automation scripts right inside the application using a convenient built-in client:

The commands required for each task may be created using a command wizard or from "remote hints" accessible throughout the user interface. Using automation, you can accelerate complex testing scenarios and even automate manual tasks such as:

- Opening projects, executing tests and saving results
- Executing tests repeatedly while changing configurations
- Sending commands to external instruments
- Executing tests out of order

Combine the power of built-in automation and extensibility to transform your application into a complete test suite executive:

- Interact with your device controller to place it into desired states or test modes before test execution
- Configure additional instruments used in your test suite such as a pattern generator and probe switch matrix
- Export data generated by your tests and post-process it using your favorite environment, such as MATLAB, Python, LabVIEW, C, C++, Visual Basic etc.
- Sequence or repeat the tests and "Add-In" custom steps execution in any order for complete test coverage of the test plan.

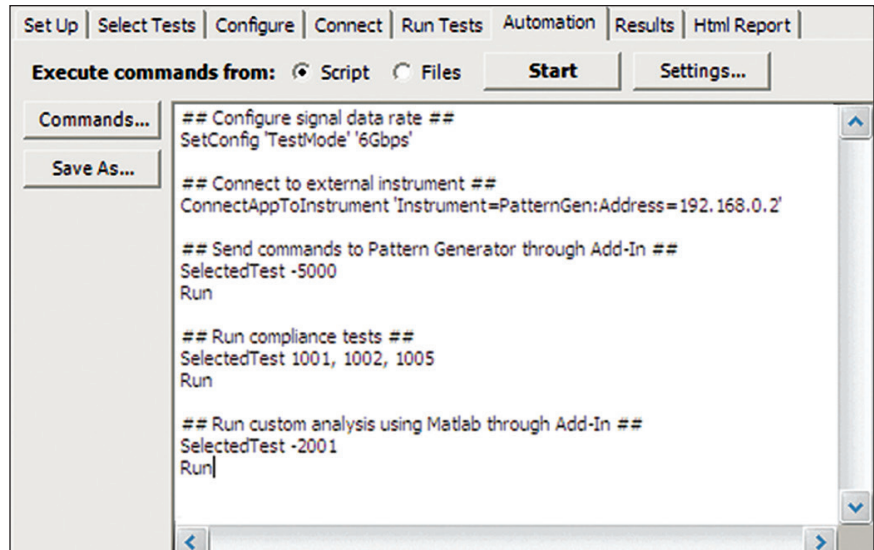

Figure 10. Remote Programming script in the Automation tab.

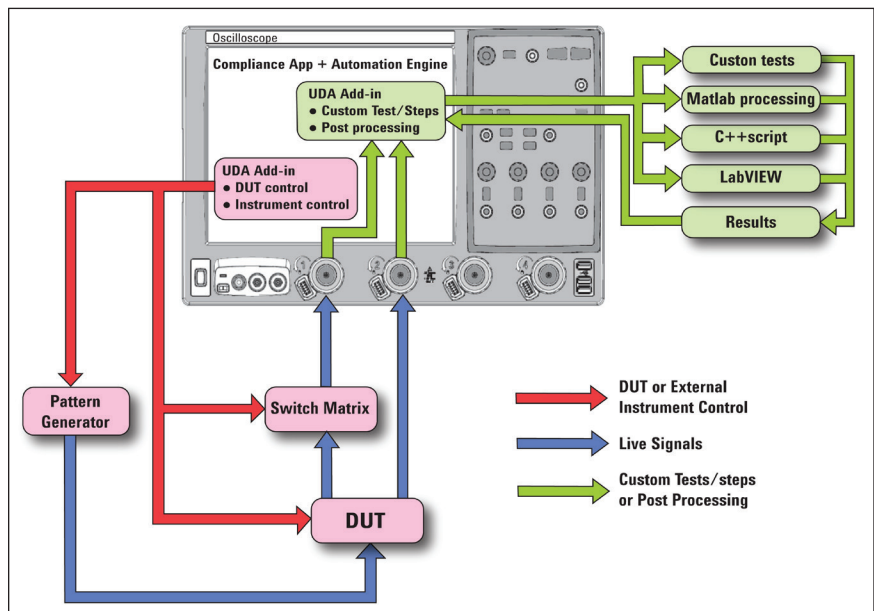

Figure 11. Combine the power of built-in automation and extensibility to transform your application into a complete test suite executive.



## System Device Requirements

In order to speed your test time, you must use the appropriate RAM test reliability software with the memory system to generate random activity on the memory bus. Memtest, is commonly used RAM reliability test software that can run on DOS, Windows and Linux systems.

## Test Performed

The Agilent DDR2 and LPDDR2 compliance test application covers clock, electrical and timing parameters of the JEDEC specifications. The application helps you test all DDR2 and LPDDR2 devices for compliance, using an Agilent 9000 or 90000 Series Infiniium oscilloscope.

In addition, the test application's Custom mode feature provides popular test methodologies that are not covered in any specification. These tests help users who want to perform extensive validation beyond the test specification. It also sets up the scope to isolate the read and write signals so you can immediately jump in to debug the signals.

Table 1. Custom mode feature covered by the N5413B test application

Measurement items	Speed supported
All JEDEC tests from compliance mode	User configurable
Read/write eye-diagram tests	User configurable

The JEDEC JESD70 2E, JESD208 and JESD209-2 specifications do not specify the rise time and fall time for DDR2 and LPDDR2 signals. The required oscilloscope bandwidth is also not mentioned. It is advisable for you to determine oscilloscope bandwidth requirement based on the fastest rise time and fall time of the DDR2 and LPDDR2 signals. Please refer to Table 2.

For 9000 and 90000 Series oscilloscope, you can choose the oscilloscope bandwidth using the calculation below.

Maximum signal frequency content =  $0.4 / \text{fastest rise or fall time (20 - 80\%)}$

Scope bandwidth required =  $1.4 \times \text{maximum signal frequency for 3\% accuracy measurement}$

Scope bandwidth required =  $1.2 \times \text{maximum signal frequency for 5\% accuracy measurement}$

Scope bandwidth required =  $1.0 \times \text{maximum signal frequency for 10\% accuracy measurement}$

Table 2. Infiniium 90000A Series oscilloscope rise/fall time specifications

Rise time/fall time	90254A	90404A	90604A	90804A	91204A	91304A
10 - 90%	140 ps	105 ps	70 ps	54 ps	35 ps	32 ps
20 - 80%	105 ps	79 ps	53 ps	38 ps	26 ps	24 ps

# Recommended oscilloscopes

The DDR2 and LPDDR2 compliance software is compatible with Agilent Infiniium Series oscilloscopes with operating software revision 4.20 or higher. For oscilloscopes with earlier revisions, free upgrade software is available here: [www.agilent.com/find/scope-apps-sw](http://www.agilent.com/find/scope-apps-sw).

Data rate	Minimum bandwidth	Minimum channels	Compatible oscilloscopes
Up to 1067 MT/s	4 GHz	3	Infiniium 9000, 90000, S-Series and Z-Series

## Ordering information

### Software options

Application	License type		Infiniium Z-Series	Infiniium S-Series	Infiniium 90000 Series	Infiniium 9000 Series
DDR2 and LPDDR2 compliance	Fixed	Factory-installed	N5413B-1FP	N5413C-1FP	Option 033	Option 032
		User-installed	N5413B-1FP	N5413C-1FP	N5413B-1NL	N5413C-1NL
	Floating	Transportable	N5413B-1TP	N5413C-1TP	N5413B-1TP <sup>1,2</sup>	N5413C-1TP <sup>1,2</sup>
		Server-based			N5435A-037	
DDR2 upgrade to LPDDR2	Fixed	Factory-installed	–	–	–	–
		User-installed	N5413B-2FP	N5413C-2FP	N5413B-2NL	N5413C-2NL
	Floating	Transportable	–	–	–	–
		Server-based			–	
DDR2 and LPDDR2 debug tool	Fixed	Factory-installed	N5413B-3FP	N5413C-3FP	–	–
		User-installed	N5413B-3FP	N5413C-3FP	N5413B-3NL	N5413C-3NL
	Floating	Transportable	N5413B-3TP	N5413C-3TP	N5413B-3TP <sup>1,2</sup>	N5413C-3TP <sup>1,2</sup>
		Server-based			–	
DDR compliance software bundle	Fixed	Factory-installed	N5459B-1FP	N5459C-1FP	–	–
		User-installed	N5459B-1FP	N5459C-1FP	N5459B-1NL	N5459C-1NL
	Floating	Transportable	–	–	–	–
		Server-based			–	
Serial data analysis software (included in DSA model)	Fixed	Factory-installed	E2688A-1FP	N5384A-1FP	Option 003	Option 003
		User-installed	E2688A-1FP	N5384A-1FP	E2688A-1NL	N5384A-1NL
	Floating	Transportable	E2688A-1TP	N5384A-1TP	E2688A-1TP <sup>1,2</sup>	N5384A-1TP <sup>1,2</sup>
		Server-based			N5435A-003	
InfiniiSim Advanced (optional)	Fixed	Factory-installed	N5465A-1FP	N5465B-1FP	Option 014	Option 014
		User-installed	N5465A-1FP	N5465B-1FP	N5465A-1NL	N5465B-1NL
	Floating	Transportable	N5465A-1TP	N5465B-1TP	N5465A-1TP <sup>1,2</sup>	N5465B-1TP <sup>1,2</sup>
		Server-based			N5435A-027	
InfiniiScan+ (optional)	Fixed	Factory-installed	N5414B-1FP	N5415B-1FP	Option 009	Option 009
		User-installed	N5414B-1FP	N5415B-1FP	N5414B-1FP	N5415B-1NL
	Floating	Transportable	N5414B-1TP	N5415B-1TP	N5414B-1TP <sup>1,2</sup>	N5415B-1TP <sup>1,2</sup>
		Server-based			N5435A-004	

1. Requires software 5.00 and above.

2. Software 4.30 or above requires Windows 7. N2753A Infiniium Windows XP to 7 OS upgrade kit (oscilloscope already has M890 motherboard). N2754A Infiniium Windows XP to 7 OS and M890 motherboard upgrade kit (oscilloscope without M890 motherboard). Verify the M890 motherboard using the procedure found in the Windows 7 upgrade kit data sheet, publication number 5990-8569EN.

# Probe accessories

## InfiniiMax probe amplifiers

Model number	Description
1169A	12-GHz differential probe amplifier
1168A	10-GHz differential probe amplifier
1134A	7-GHz differential probe amplifier
1132A	5-GHz differential probe amplifier
1131A	3.5-GHz differential probe amplifier
1130A	1.5-GHz differential probe amplifier
N2831A	8-GHz InfiniiMax III+ probe amplifier
N2832A	12-GHz InfiniiMax III+ probe amplifier

## InfiniiMax probe heads

Model number	Description
N5381A	InfiniiMax II 12-GHz differential solder-in probe head and accessories
N5382A	InfiniiMax II 12-GHz differential browser
E2677A	InfiniiMax 12-GHz differential solder-in probe head and accessories
E2675A	InfiniiMax 6-GHz differential browser probe head and accessories
N5425A	InfiniiMax 12-GHz ZIF Probe Head
N5426A	ZIF Tips (x10)
N5451A	Long Wire ZIF Tips (x10)
E2678A	InfiniiMax 12-GHz differential socket probe head and accessories
N2848A	InfiniiMax III QuickTip head
N2849A	InfiniiMax III QuickTip tips (4 per kit)

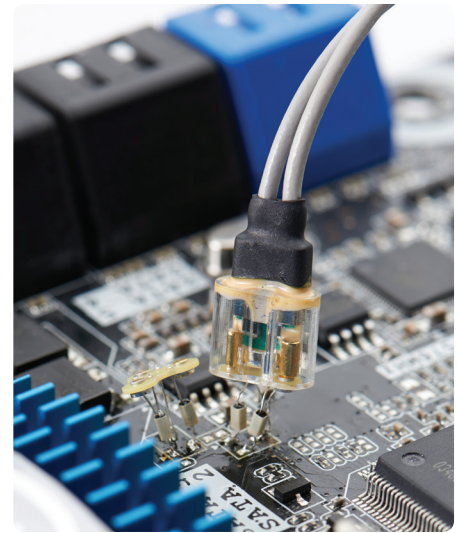

Figure 7. Use InfiniiMax III+ probe amplifier with QuickTip head for quick and secure magnetic connection.

# DDR2 BGA Probe

Model number	Description
W2631B	DDR2 x16 BGA command and data probe
W2632A	DDR2 x16 BGA data probe
W2633B	DDR2 x8 BGA command and data probe
W2634A	DDR2 x8 BGA data probe
W2639A	Scope adapter board for DDR2 BGA probe - Kit of 2 (Note: For use with E2678A differential socket probe head and accessories)

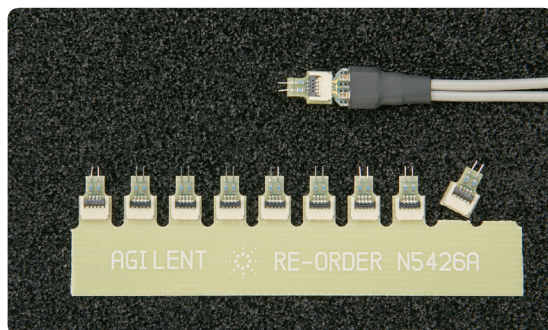

Figure 8. New InfiniiMax ZIF probe head (N5425A) and ZIF tips (N5426A) for your DDR2 probing solution.

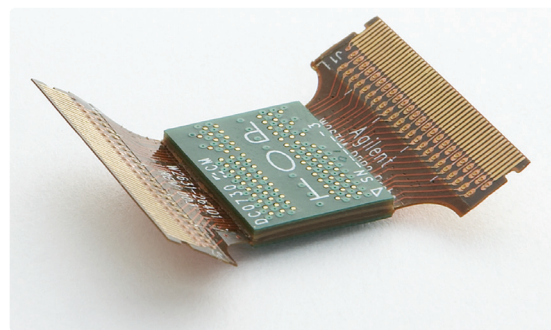
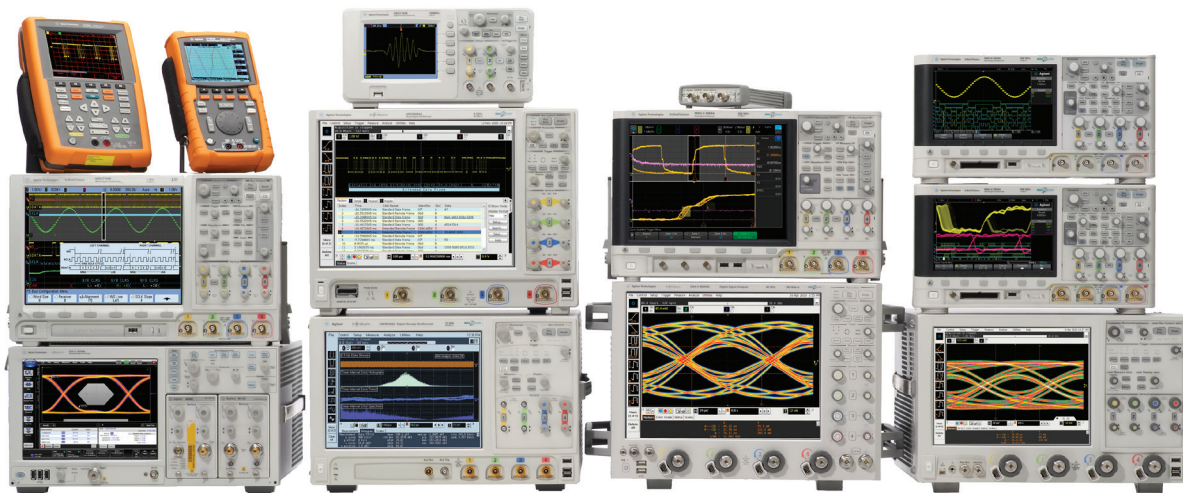

Figure 9. DDR2 BGA probe adapter for oscilloscopes and logic analyzers

## Related Literature

Publication title	Publication type	Publication number
<i>Agilent Infiniium DSO/DSA 90000A Series Oscilloscopes and InfiniiMax Series Probes</i>	Data Sheet	5989-7819EN
<i>Agilent InfiniiScan Event Identification Software for Infiniium Series Oscilloscopes (N5414A and 5415A)</i>	Data Sheet	5989-4605EN
<i>Agilent Technologies E2688A, N5384A High-Speed Serial Data Analysis and Clock Recovery Software for Infiniium Series Oscilloscopes</i>	Data Sheet	5989-0108EN
<i>Agilent Technologies EZJIT and EZJIT Plus Jitter Analysis Software for Infiniium Series Oscilloscope</i>	Data Sheet	5989-0109EN
<i>W2630 Series DDR2 BGA Probe for Logic Analyzers and Oscilloscopes</i>	Data Sheet	5989-5964EN
<i>W2637A, W2638A and W2639A LPDDR BGA Probes for Logic Analyzers and Oscilloscopes</i>	Data Sheet	5990-3894EN
<i>A Time-Saving Method for Analyzing Signal Integrity in DDR Memory Buses</i>	Application Note	5989-6664EN

To download copies of these publications, go to [www.agilent.com/find/N5413B](http://www.agilent.com/find/N5413B)



### Agilent Technologies Oscilloscopes

Multiple form factors from 20 MHz to > 90 GHz | Industry leading specs | Powerful applications



### myAgilent

[www.agilent.com/find/myagilent](http://www.agilent.com/find/myagilent)

A personalized view into the information most relevant to you.



### [www.lxistandard.org](http://www.lxistandard.org)

LAN eXtensions for Instruments puts the power of Ethernet and the Web inside your test systems. Agilent is a founding member of the LXI consortium.



### Three-Year Warranty

[www.agilent.com/find/ThreeYearWarranty](http://www.agilent.com/find/ThreeYearWarranty)

Agilent's combination of product reliability and three-year warranty coverage is another way we help you achieve your business goals: increased confidence in uptime, reduced cost of ownership and greater convenience.



### Agilent Advantage Services

[www.agilent.com/find/AdvantageServices](http://www.agilent.com/find/AdvantageServices)

Accurate measurements throughout the life of your instruments.



### [www.agilent.com/quality](http://www.agilent.com/quality)

Agilent Electronic Measurement Group  
DEKRA Certified ISO 9001:2008  
Quality Management System

### Agilent Channel Partners

[www.agilent.com/find/channelpartners](http://www.agilent.com/find/channelpartners)

Get the best of both worlds: Agilent's measurement expertise and product breadth, combined with channel partner convenience.

[www.agilent.com](http://www.agilent.com)  
[www.agilent.com/find/n5413b](http://www.agilent.com/find/n5413b)

For more information on Agilent Technologies' products, applications or services, please contact your local Agilent office. The complete list is available at: [www.agilent.com/find/contactus](http://www.agilent.com/find/contactus)

### Americas

Canada	(877) 894 4414
Brazil	(11) 4197 3600
Mexico	01800 5064 800
United States	(800) 829 4444

### Asia Pacific

Australia	1 800 629 485
China	800 810 0189
Hong Kong	800 938 693
India	1 800 112 929
Japan	0120 (421) 345
Korea	080 769 0800
Malaysia	1 800 888 848
Singapore	1 800 375 8100
Taiwan	0800 047 866
Other AP Countries	(65) 375 8100

### Europe & Middle East

Belgium	32 (0) 2 404 93 40
Denmark	45 45 80 12 15
Finland	358 (0) 10 855 2100
France	0825 010 700*
	*0.125 €/minute
Germany	49 (0) 7031 464 6333
Ireland	1890 924 204
Israel	972-3-9288-504/544
Italy	39 02 92 60 8484
Netherlands	31 (0) 20 547 2111
Spain	34 (91) 631 3300
Sweden	0200-88 22 55
United Kingdom	44 (0) 118 927 6201

For other unlisted countries:

[www.agilent.com/find/contactus](http://www.agilent.com/find/contactus)

(BP-09-27-13)

Product specifications and descriptions in this document subject to change without notice.

© Agilent Technologies, Inc. 2011, 2014  
Published in USA, May 12, 2014  
5989-3195EN

Intel® is a U.S. registered trademark of Intel Corporation.



**Agilent Technologies**