

OPERATING AND SERVICE MANUAL

HP 11664E DETECTOR

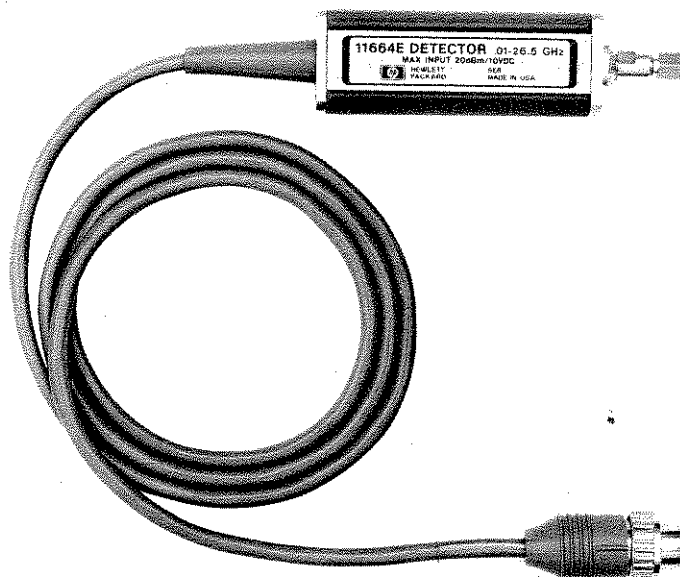

**HEWLETT
PACKARD**

HP 11664E DETECTOR

This manual applies directly to the HP 11664E
Detector with serial numbers 00101 and above.

For additional information concerning serial numbers,
see INSTRUMENTS COVERED BY MANUAL; refer
to the Table of Contents.

© Copyright HEWLETT-PACKARD COMPANY 1984
1400 FOUNTAINGROVE PARKWAY, SANTA ROSA, CA 95401 U.S.A.

Manual Part Number 11664-90056
Microfiche Part Number 11664-90057

Printed: SEPTEMBER 1984
Printed in U.S.A.



**HEWLETT
PACKARD**

CONTENTS

	Page		Page
GENERAL INFORMATION	1	Equipment Required	13
Introduction	1	Test Record Card	13
Description	1	Return Loss	14
Specifications	1	Specifications	14
Accessories	1	Description	14
Equipment Required But Not Supplied	3	Equipment	14
Recommended Test Equipment	3	Procedure	15
Initial Inspection	3	Flatness	18
Preparation for Use	3	Specifications	18
Power Requirements	3	Description	18
Mating Connectors	3	Equipment	19
Connector Lead Identification	4	Procedure	19
Connecting the HP 11664E	4	Meeting Specifications	22
Operating Environment	4	SERVICE	25
Temperature	4	Introduction	25
Humidity	4	Adjustments	25
Altitude	4	Safety Considerations	25
Storage and Shipment	4	List of Serviceable Parts	25
Environment	4	Equipment Needed for Repair	26
Packaging	4	Ordering the Parts	26
Returning for Service	7	Repair	26
OPERATION	9	Replacing the Input Connector	29
Introduction	9	Replacing the Cable Assembly	29
Features	9	MANUAL CHANGES	31
Operating Instructions	9	Instruments Covered by Manual	31
Operating Precautions	9	Ordering Manuals/Microfiche	31
Operator's Check	10	APPENDIX A MECHANICAL INSPECTION	33
Typical Measurement Configuration	11	APPENDIX B AUTOMATED FLATNESS PROGRAM LISTING	37
PERFORMANCE TESTS	13		
Introduction	13		

ILLUSTRATIONS

Figure 1.	HP 11664E Detector and Accessories Supplied	ii
Figure 2.	HP 11664E Features	10
Figure 3.	Typical Measurement Setup	11
Figure 4.	Return Loss Test Setup	15
Figure 5.	Trace Before Adjustment	16
Figure 6.	Properly Adjusted Trace	16
Figure 7.	M-Mem Display	17
Figure 8.	DUT Return Loss .04 to 26.5 GHz	17
Figure 9.	Absolute Error Curve	18
Figure 10.	Flatness Test Setup	19
Figure 11.	Absolute Error Curve	21
Figure 12.	Major Assemblies	25
Figure 13.	Input Connector Exploded View	28
Figure 14.	Cable Connections	30
Figure A1.	Precision 3.5mm Connector Gages	34
Figure A2.	Zeroing Precision 3.5mm Connector Gages	35
Figure A3.	Measuring Precision 3.5mm Male Connectors	36
Figure B1.	Typical Program Output	39

TABLES

Table 1.	Specifications	2
Table 2.	Supplemental Performance Characteristics	2
Table 3.	Recommended Test Equipment	7
Table 4.	Return Loss Measurement Uncertainty	14
Table 5.	Performance Test Record	23
Table 6.	Replaceable Parts	27

HP 11664E DETECTOR



CABLE MARKER KIT

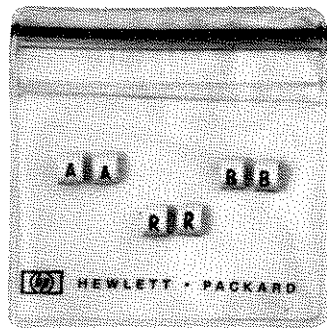

Figure 1. HP 11664E Detector and Accessories Supplied

GENERAL INFORMATION

INTRODUCTION

This manual contains information required to operate, test, and service the Hewlett-Packard HP 11664E detector. The instrument and the supplied Cable Marker Kit are shown in Figure 1.

Operating information is found under major heading **OPERATION** which includes figures and instructions for making typical measurements. **PERFORMANCE TESTS** contains instructions for testing the HP 11664E to the published specifications. Included is a Test Performance Record Card for recording results. Repair information is found under the **SERVICE** heading. For further information on section topics and sub-topics, refer to the **TABLE OF CONTENTS**.

There are two appendices in the back of this manual. Appendix A contains information on Mechanical Inspection of Precision 3.5mm connectors and the use of Pin Depth Gages.

Appendix B is a program listing of an automated Flatness measurement. It has brief notes on how to use it and what equipment is necessary to make the automated measurement.

DESCRIPTION

The HP 11664E detector consists of a single Schottky diode housed in a metal frame with an APC 3.5 connector. RF signal levels (dependent upon scalar network analyzer used) from -60 to $+16$ dBm in the frequency range of 10 MHz to 26.5 GHz can be detected. The HP 11664E detector requires the use of either an HP 8755C/8756A/8757A scalar network analyzer (recommended equipment). The use of three HP 11664E detectors, or two detectors and a bridge, enables simultaneous (amplitude only) transmission and reflection measurements via the analyzer CRT. The supplied cable markers are used for identification when more than one detector is used in a test setup.

The HP 11664E detector and the input stages of the HP 8755C/8756A/8757A comprise an AC coupled system. This detection scheme requires a 27.8 kHz squarewave amplitude modulation of the RF input signal. Additional information is provided in the paragraph titled, **EQUIPMENT REQUIRED BUT NOT SUPPLIED**.

Specifications. Listed in Table 1 are the performance specifications for the HP 11664E detector. These are the performance standards or limits against which the instrument may be tested. Table 2 lists supplemental characteristics. These are not specifications, but are typical characteristics included as additional information for the user.

Accessories. The following accessories for the HP 11664E are available:

- Model 11679A, 7.5 metre (25 foot) extension cable and
- Model 11679B, 60 metre (200 foot) extension cable.

If you wish to order these accessories, please refer to the paragraph titled **ORDERING THE PARTS** under major heading **SERVICE**.

Table 1. Specifications

FREQUENCY	FLATNESS
<p>Frequency Range: 10 MHz to 26.5 GHz</p>	<p>Measured at -10 dBm</p> <p>10 MHz to 18 GHz: ± 0.5 dB</p> <p>18 GHz to 26.5 GHz: ± 1 dB</p>
<p>Return Loss (15-35°C)</p> <p>10 MHz to 40 MHz: > 10 dB (≤ 1.92 SWR) $\leq +10$ dBm</p> <p>.04 GHz to 6 GHz: > 20 dB (≤ 1.22 SWR) $\leq +10$ dBm</p> <p>6 GHz to 20 GHz: > 16 dB (≤ 1.38 SWR) $\leq +10$ dBm</p> <p>20 GHz to 26.5 GHz: > 12 dB (≤ 1.67 SWR) ≤ -10 dBm</p>	<p style="text-align: center;">REFLECTION</p>
<p>Dynamic Range: Dependent upon scalar network analyzer: +16 to -60 dBm with HP 8757A +10 to -50 dBm with HP 8755C/8756A</p> <p>Temperature Range: Operation: 0° to 55°C (32° to 131°F) Storage: -40° to 75°C (-40° to 167°F)</p>	<p style="text-align: center;">GENERAL</p> <p>Input Impedance: 50 ohms nominal</p> <p>Connectors: Standard: Precision 3.5mm male</p> <p>Dimensions: Cable length is 1.2 metres (4 feet)</p> <p>Weight: Net 0.17 kg (6 oz.)</p>

Table 2. Supplemental Characteristics

<p style="text-align: center;">Typical Return Loss at 0dBm Input Power</p>	<p style="text-align: center;">Typical Flatness at -10dBm Input Power</p>
<p style="text-align: center;">GENERAL</p> <p>Input Damage Level: +20 dBm (100 mW) RF power 10 Vdc</p>	<p style="text-align: center;">Typical Variation due to Temperature</p>

EQUIPMENT REQUIRED BUT NOT SUPPLIED

Reflection and transmission measurements require one or more HP 11664E detectors and either an HP 8755C/8756A/8757A scalar network analyzer. Swept frequency measurements will require a sweep oscillator. In addition, the RF source signal must be amplitude modulated by a 27.8 kHz squarewave signal.

To make these measurements with the detector up you will need the following equipment:

1. one or more detectors
2. a sweep oscillator with 27.8 kHz squarewave amplitude modulation
3. a scalar network analyzer
4. dual direction coupler (or two single directional couplers) or bridge

RECOMMENDED TEST EQUIPMENT

Equipment required for testing the HP 11664E is listed in Table 3. Other equipment may be substituted if it meets or exceeds the critical specifications indicated in the table. You may also use this list as a reference for the equipment necessary to make reflection and transmission measurements.

INITIAL INSPECTION

If the shipping container or cushioning material is damaged, it should be kept until the contents of the shipment have been checked for completeness, and the instrument has been checked both mechanically and electrically.

First, check for completeness. Figure 1 depicts all items you should receive per HP 11664E.

Second, check connectors, cable, and body for mechanical damage.

Third, test the detector electrically by either making measurements or testing to the specifications. Refer to **OPERATION** or **PERFORMANCE TESTS** in this manual.

Notify your nearest Hewlett-Packard office, if any of the following conditions exist:

- a. The instrument does not pass electrical tests.
- b. Shipping contents are incomplete.
- c. There is mechanical damage or defect.

Also, notify the carrier if the shipping container is damaged or the cushioning material shows signs of stress. Keep all shipping materials for the carrier's inspection. Hewlett-Packard will arrange for repair or replacement without waiting for a claim settlement.

PREPARATION FOR USE

CAUTION

SUSCEPTIBLE TO DAMAGE FROM STATIC DISCHARGE.

Power Requirements. Power for the HP 11664E is supplied by either the HP 8755C/8756A/8757A scalar network analyzer. Each detector requires 0.35 watts. The analyzer normally powers up to three detectors requiring a maximum total of 1.05 watts.

Mating Connectors. Read and observe the caution on connecting Precision 3.5mm to SMA connectors. For best measurement results inspect the connectors periodically, refer to Appendix A.

CAUTION

Do not apply more than 8 in/lb (9.2 cm/kg) of torque when tightening the connectors. Greater torque may deform the mating surfaces.

Connector Lead Identification. Coded cable clips (Cable Marker Kit) are furnished for lead identification when two or more detectors are used. Place matching clips on either end of the same detector cable.

Connecting the HP 11664E. Connect the HP 11664E to the HP 8755C/8756A/8757A as follows:

1. Insert the DC connector of the HP 11664E into the HP 8755C/8756A/8757A mating connector. The HP 11664E connector is keyed; the plug should be inserted with the key downward.
2. Secure the DC connector in the analyzer by turning the OUTER shell clockwise.
3. Connect the RF input by turning the male connector OUTER shell clockwise. Refer to **SERVICE** for instructions on replacing 3.5mm connectors. Refer to Appendix A for instructions on mechanical inspection.

OPERATING ENVIRONMENT

Temperature: 0° to +55°C.

NOTE

See Table 2 for detector response with variations in temperature.

Humidity: Up to 95%. Protection should be provided from temperature extremes. Condensation may occur within the instrument if exposed to temperature extremes or higher humidity levels.

Altitude: Up to 7,620 metres (25,000 feet).

STORAGE AND SHIPMENT

Environment. The instrument may be stored or shipped in environments within the following limits:

Temperature: -25°C to +75°C.

Humidity: Up to 95%.

Altitude: Up to 7,620 metres (25,000 feet).

Protection should be provided from temperature extremes, which can cause condensation within the instrument.

Packaging. Containers and materials identical to those used in factory packaging are available through Hewlett-Packard offices. If, however, you choose to package the instrument with commercially available materials, follow these instructions:

1. Wrap the instrument in heavy paper or plastic.
2. Use a strong shipping container. A double-wall carton made of 350-pound test material is adequate.
3. Use shock-absorbing material (3 to 4-inch layer) around all sides of the instrument to provide a firm cushion and prevent movement inside the container.
4. Seal the shipping container securely.
5. Mark the shipping container **FRAGILE**.

CAUTION: SMA CONNECTORS

SMA connectors will mate with precision 3.5mm connectors. But caution is necessary to prevent accidental damage due to worn or out-of-specification SMA connectors. Such connectors can destroy a precision 3.5mm connector *even on the very first connection*. Hewlett-Packard recommends that you keep two points clearly in mind when you mate SMA and precision 3.5mm connectors.

(1) SMA connectors are not precision mechanical devices. They are not designed for repeated connections and disconnections; they are very susceptible to mechanical wear, and they are very often found, upon assembly, to be out of specification – even before they have been used. This makes them potentially destructive to any precision 3.5mm connectors with which they might be mated.

Before mating an SMA connector (even a brand new one) with a precision 3.5mm connector – or any other device, for that matter – inspect the SMA connector carefully both visually and mechanically, using a precision connector gage designed to measure SMA connectors. A male SMA connector pin that is too long may smash or break the delicate fingers on the precision 3.5mm female connector, damaging it beyond repair. Gaging SMA connectors is the single most important step you can take to prevent damaging your equipment, and it takes very little time.

Also take care with alignment: push the two connectors straight together, with the male contact pin precisely concentric with the female. Do not overtighten or rotate either center conductor. Turn only the outer nut of the male connector and use a torque wrench (5 lb-in, 60 N-cm) for the final connection. Note that this torque is less than is used when mating precision 3.5mm connectors with each other. A torque wrench suitable for SMA connectors, preset to 5 lb-in (60 N-cm), is available as HP part number 8710-1582.

PRECISION 3.5mm CONNECTOR

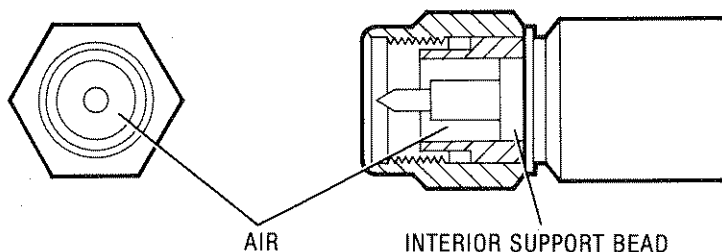

SMA CONNECTOR

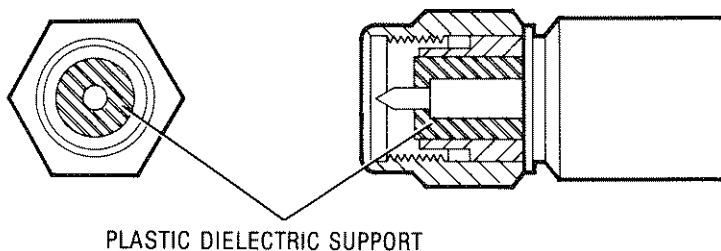

SMA and Precision 3.5mm Connectors

Another good idea, especially if many connections and disconnections will be made, is to install an adapter on the test set you will be using. Then, if accidental damage does occur, the adapter is all that has to be replaced. It is much easier, and much cheaper, to replace a damaged adapter than it is to replace an entire test set connector.

If these precautions are followed, SMA connectors can be mated with precision 3.5mm connectors without difficulty or fear of expensive and time-consuming repairs required by accidental damage to the connectors.

(2) Important structural and dimensional differences also exist between these two types of connectors. Precision 3.5mm connectors, also known as APC-3.5 connectors, are air-dielectric devices. Only air exists between the center and outer conductors. The male or female center conductor is supported by a plastic "bead" deep within the connector body. In SMA connectors a plastic dielectric supports the entire length of the center conductor. In addition, the diameters of both the center and the outer conductors differ between SMA and precision 3.5mm connectors.

Thus when an SMA connector is mated with a precision 3.5mm connector the connection itself will exhibit a discontinuity mismatch (SWR), typically about 1.10 at 20 GHz. This mismatch is less than is obtained when two SMA connectors are mated. But it is still much higher than occurs when precision 3.5mm connectors alone are used. Keep this fact in mind when making measurements on SMA and precision 3.5mm coupled junctions.

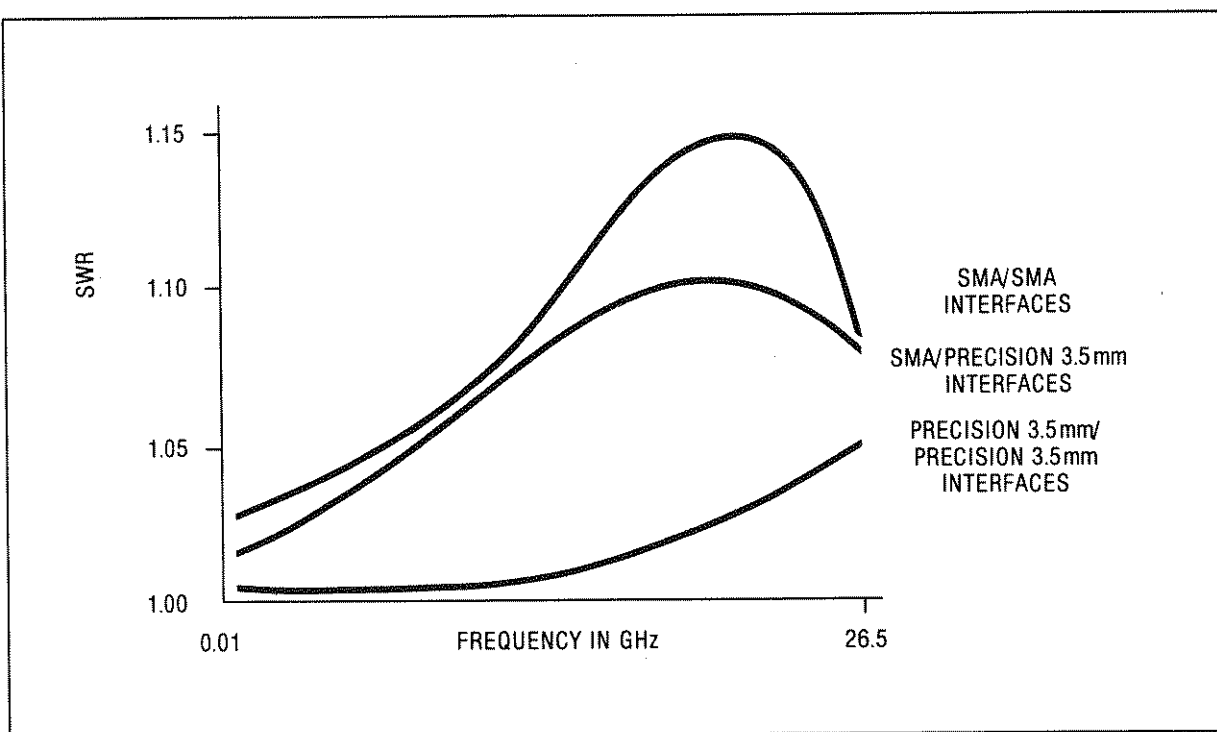

Typical SWR of SMA and Precision 3.5mm Connectors

Returning for Service. If you are shipping the instrument to a Hewlett-Packard office or Service Center please include the following information:

1. Company name and address.
2. Technical contact person and their complete phone number.
3. Complete model and serial number of the instrument.
4. Type of service required (Calibration vs. Repair).
5. Any other type of information that might expedite service.

Whenever making any inquiries, either by correspondence or by telephone, please refer to the instrument by model number and full serial number.

Table 3. Recommended Test Equipment

Instrument Type	Critical Specifications	Suggested Model
Sweep Oscillator	Frequency: 10 MHz–26.5 GHz Capable of being modulated	HP 8350B mainframe with HP 83595A RF plug-in or HP 8340A
Scalar Network Analyzer	Processes/displays detected signals	HP 8756A/HP 8757A
Directional Bridge	Frequency: 10 MHz–26.5 GHz	HP 85021B (Precision 3.5mm)
Calibrated OPEN/SHORT	Precision 3.5mm connector	HP 85037–60001
Attenuators	Precision 3.5mm connector Provide either 12 or 13 dB attenuation Frequency: DC–26.5 GHz	HP 8493C 2 ea. OPT 006–6 dB or 1 ea. OPT 003–3 dB and OPT 010–10 dB
Calibrated Power Sensor	Frequency: 10 MHz–26.5 GHz Precision 3.5mm connector	HP 8485A*
Power Meter		HP 436A or HP 438A
Adapter	3.5mm(F) to 3.5mm(F)	HP Part Number 1250-1865
Inspection Gage and Calibration Block	Precision 3.5mm	Maury Microwave Gage A 034B-M Maury Microwave Calibration Block 027-3

* The HP 8485A is not specified for frequencies below 50 MHz. However, it should provide sufficient accuracy for reliable measurements between 10 MHz and 50 MHz. An HP 8482A with an adapter (HP P/N 1250-1750) may be used to characterize the source below 50 MHz.

OPERATION

CAUTION

SUSCEPTIBLE TO DAMAGE FROM STATIC DISCHARGE.

Repeated electrostatic discharge (ESD) as low as 250 volts can destroy microwave diodes.

If static discharge is noticed by the operator, it indicates a voltage of 20,000 volts or more.

Materials conducive to static build-up include carpeting, nylon, dry air, paper, adhesive tape, styrofoam and vinyl.

The best method of preventing ESD is for the operator to wear a grounding strap connected to a conductive bench mat that provides a path to ground of between 1 and 2.5 Megohms.

Alternatively, the operator can ground (him/her)self by touching any grounded instrument before touching the HP 11664E connector.

NEVER touch the connector center contacts.

INTRODUCTION

This section contains information concerning the operation of the HP 11664E detector.

FEATURES

The features of the HP 11664E are detailed in Figure 2.

OPERATING INSTRUCTIONS

Operating Precautions

Read and observe all **CAUTIONS**.

Tighten the HP 11664E connectors with fingers only.

DO NOT use a wrench unless it is a torque wrench set at 8 in/lb.

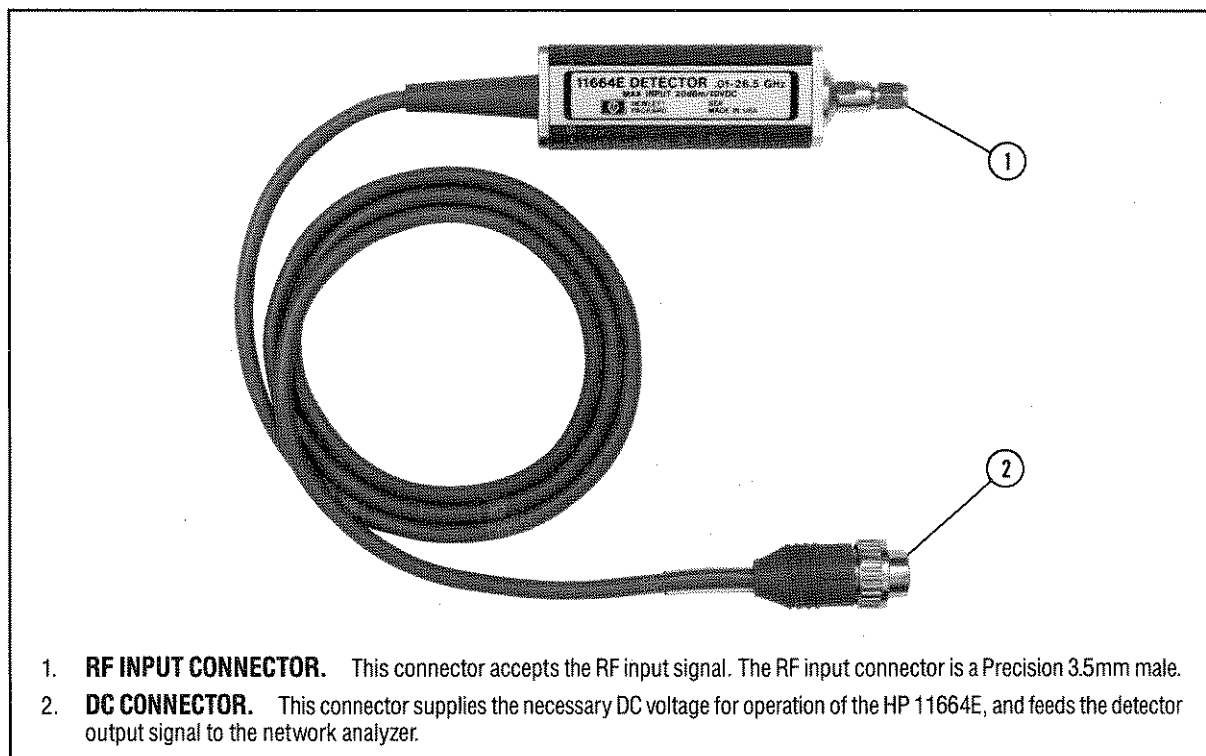

Figure 2. HP 11664E Features

CAUTION

Do not apply more than 8 in/lb (9.2 cm/kg) of torque when tightening the connectors. Greater surface torque may deform the mating surfaces.

Do NOT apply more than +20 dBm RF CW power or more than ± 10 volts DC to the HP 11664E or electrical damage may occur.

Before connecting a cable to the HP 11664E RF connector, always discharge the cable's center conductor static electricity to instrument ground.

Do NOT drop the HP 11664E, or subject it to mechanical shock. The diode is easily damaged.

Operator's Check. A procedure for checking detectors is included in the Operator's Check of the HP 8755C/8756A/8757A Operating and Service Manuals. The procedure is written for either an HP 11664A or HP 11664B, but it is applicable for checking the HP 11664E.

Typical Measurement Configuration. Amplitude measurements with the HP 11664E, HP 8755C or HP 8756A analyzer system require a modulation envelope. This envelope is provided through a 27.8 kHz squarewave amplitude modulation of the RF test signal. Test set connections will vary depending on the analyzer and source oscillator selected.

Figure 3 illustrates a typical setup with the HP 8350B sweep oscillator/RF plug-in using internal modulation.

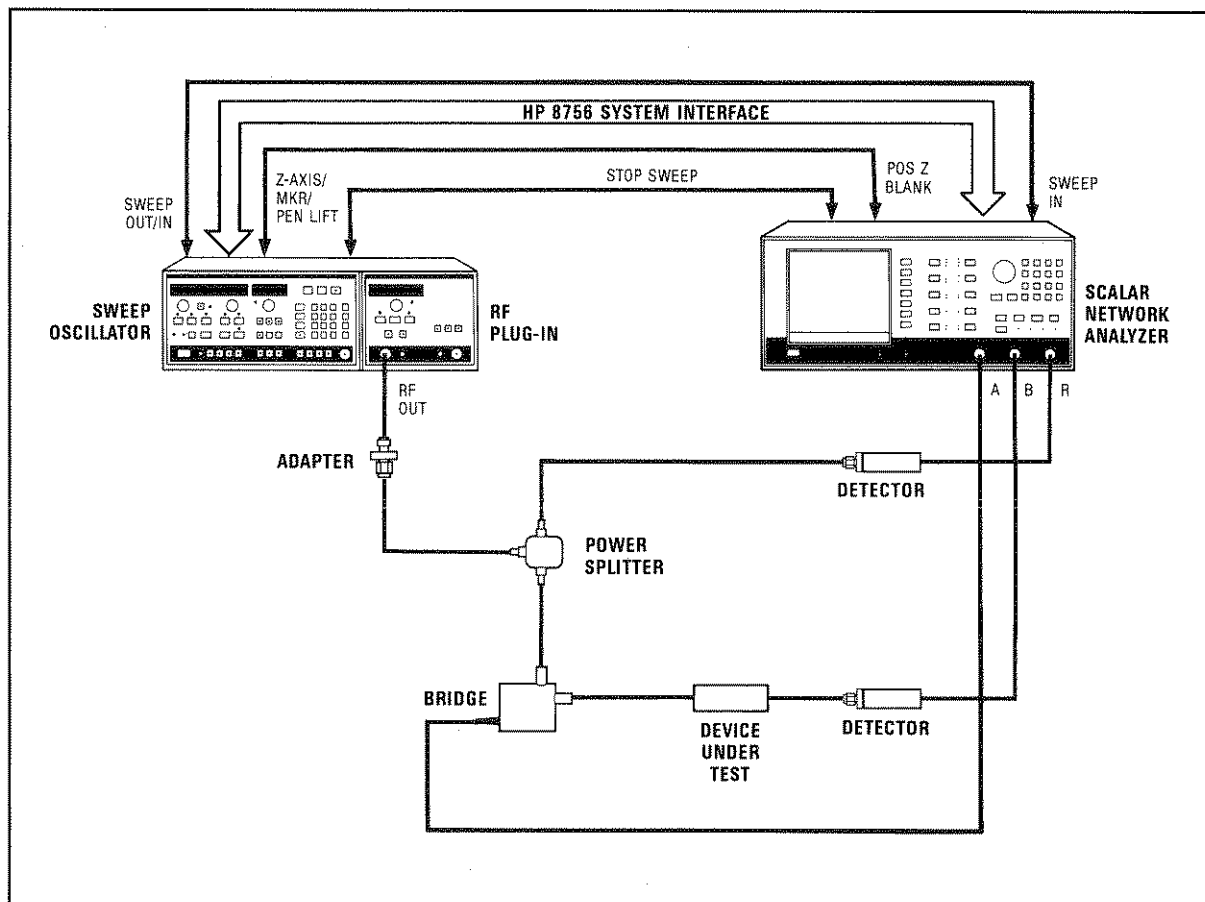
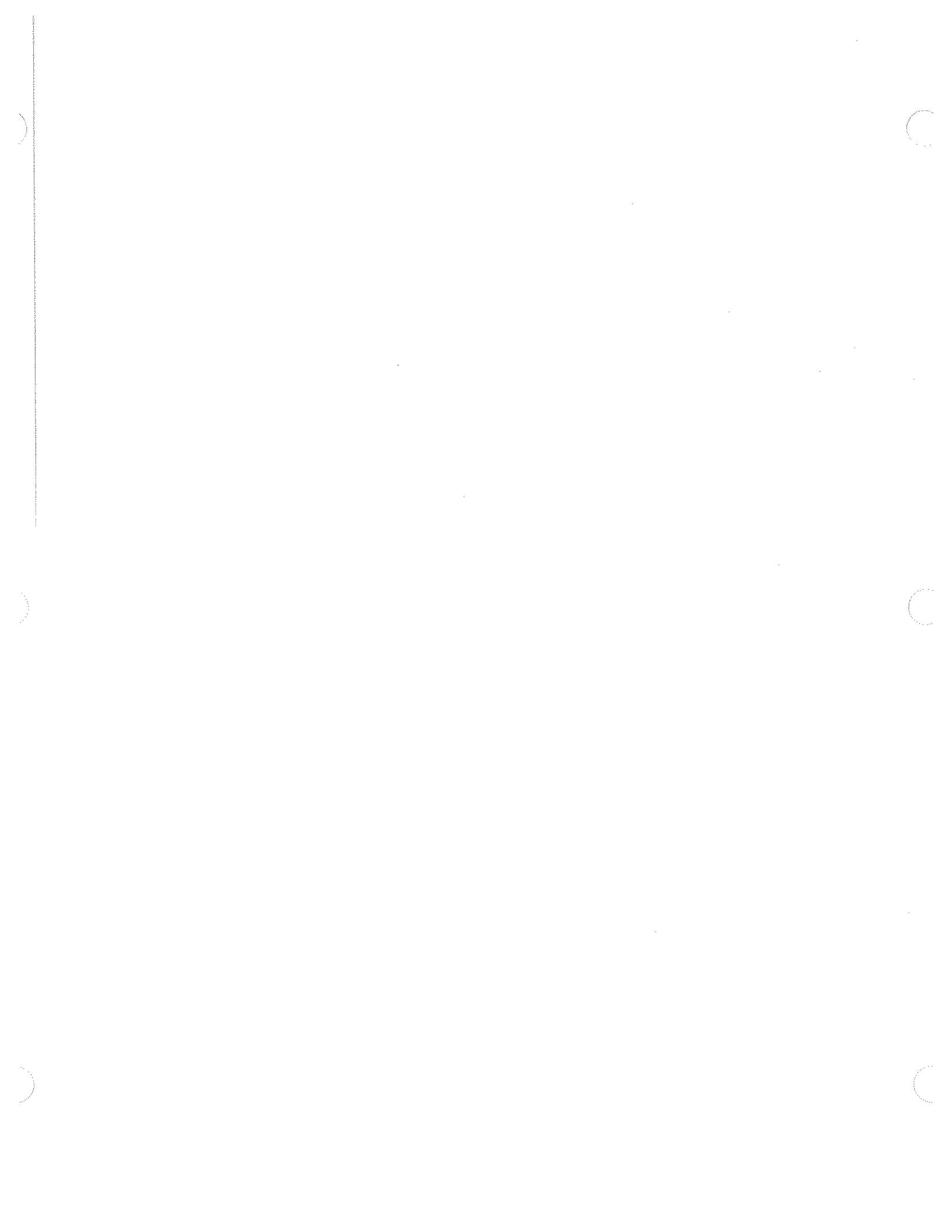

Figure 3. HP 11664E/8756A Typical Measurement Setup.



PERFORMANCE TESTS

INTRODUCTION

The procedures in this section test the instrument's electrical performance to the specifications in Table 1. None of the tests in this section require access to the interior of the instrument.

In the instructions, the words "press" and "select" will be used to mean, "press key named . . .". The only difference is, "press" references an actual key, while "select" is used to reference softkeys.

Under the paragraph, MEETING SPECIFICATIONS, you will find information on what to do if your instrument fails specs.

Appendix B contains an example program listing of an automated Flatness measurement. This program contains only the bare essentials to enable an automated measurement. Appendix B is intended to provide a starting point for making automated measurements and does not contain full error detection or additional features.

EQUIPMENT REQUIRED

Table 3 lists the recommended test equipment for performance testing this instrument. Any equipment that satisfies the critical specifications given in Table 3 may be substituted for the recommended model.

TEST RECORD CARD

A Test Performance Record is provided at the end of this section so that you may record and perform the calculations necessary to interpret the results of the performance tests.

RETURN LOSS

SPECIFICATIONS

Range	Input Conditions
0.01 GHz to 0.04 GHz: >10 dB (<1.92 SWR) 0.04 GHz to 6.0 GHz: >20 dB (<1.22 SWR) 6 GHz to 20 GHz: >16 dB (<1.38 SWR)	at +10 dBm or below
20 GHz to 26.5 GHz: >12 dB (<1.67 SWR)	at -10 dBm or below

DESCRIPTION

An HP 11664E detector and a directional bridge comprise a reflectometer test setup. The test setup is calibrated using an open/short to minimize frequency response and phasing errors. Then, the detector (device under test, DUT) is connected to the **TEST PORT** of the bridge; its return loss is measured on the HP 8756A.

The return loss should be equal to or greater than the limits listed above. Table 4 lists measurement uncertainty due to bridge directivity. If the return loss is within the measurement uncertainty range, a vector impedance measurement with error correction should be made. At Hewlett-Packard, this is accomplished by using an HP 8510A automatic network analyzer. Further information is available in the HP 8510A Operating and Programming Manual (HP Part Number 08510-90005).

Table 4. Return Loss Measurement Uncertainty

Frequency (GHz)	Specification (dB)	Measurement Uncertainty Range (dB) HP 85021B
0.01 to 0.04	10	9.5 to 10.5
0.04 to 6.0	20	19.1 to 21.0
6.0 to 20	16	15.2 to 16.8
20 to 26.5	12	10.9 to 13.3

EQUIPMENT

Sweep Oscillator	HP 8350B
RF Plug-In	HP 83595A
Directional Bridge	HP 85021B
Scalar Network Analyzer	HP 8756A
Calibrated Open/Short	HP P/N 85037-60001

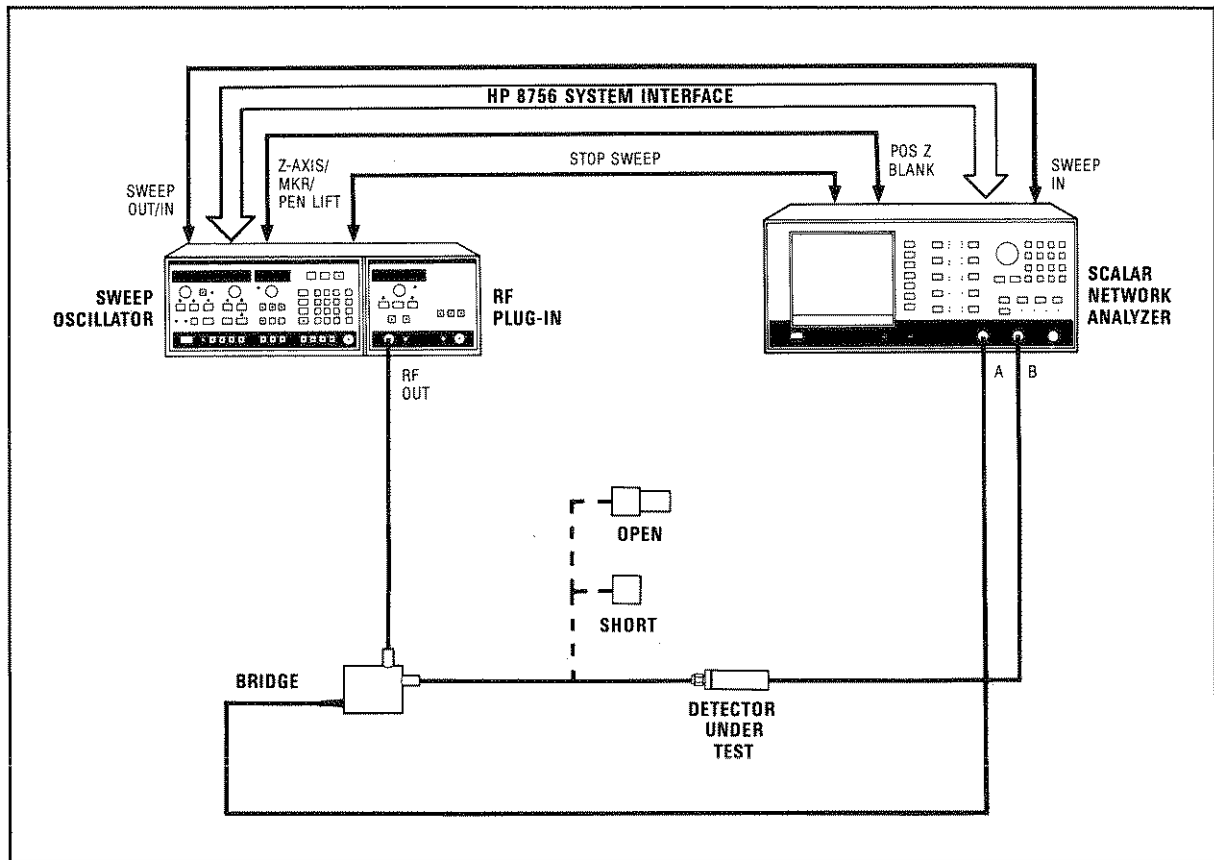

Figure 4. Return Loss Test Setup

PROCEDURE

Return Loss 10 to 40 MHz

1. Set up the equipment as shown in Figure 4, with nothing connected to the bridge **TEST PORT**.
 Press **[PRESET]** on the HP 8756A; both the HP 8756A and the HP 8350B will reset. On the HP 8350B **[MOD]** will be activated, sweep time will be set to 200 ms.
 Allow 30 minutes for warm-up.
2. On the source:
 Press **[START] [-] [1] [0] [MHz]**.
 Press **[STOP] [4] [0] [MHz]**.
3. On the RF plug-in:
 Press **[POWER LEVEL]** and adjust with the RPG for a -3 dBm power level indication.
4. On the scalar network analyzer:
 Turn Channel 2 off by pressing **[SHIFT] Channel 2 [MEAS RATIO]**.
 Channel 1 **MEAS PWR A** LED should be on. If not press **[MEAS PWR]** until the **A** LED lights.
 Press **[REF]** until the **POSN** LED is on, then use step keys or knob to move **REF POS** one line down from the top of the CRT graticule.
 Press **[SHIFT] [SCALE]**.

Notice a response dip similar to Figure 5. This dip is formed because the sweeper is a heterodyned source (in Band 0) sweeping through low frequencies where it is incapable of generating output power. The middle of this response dip is the "ZERO FREQUENCY" point.

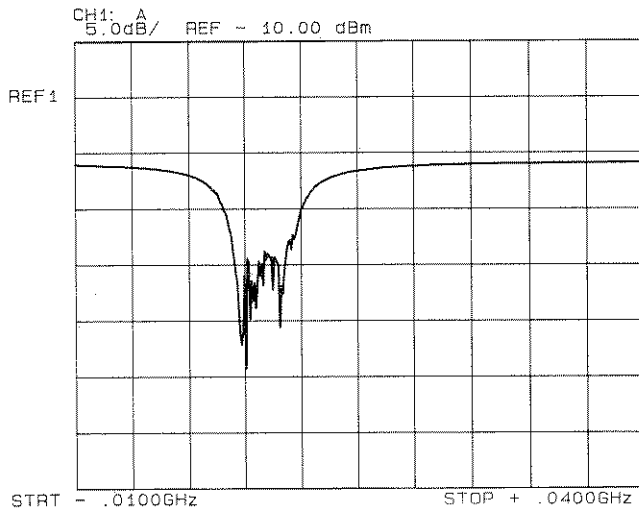

Figure 5. Trace Before Adjustment

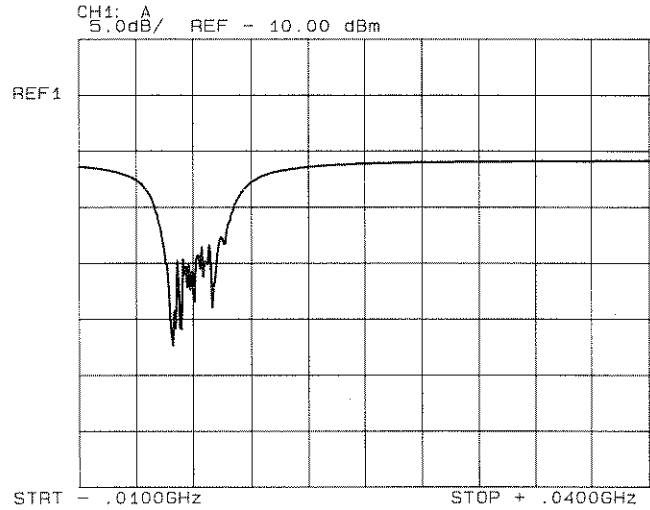

Figure 6. Properly Adjusted Trace

5. On the RF plug-in front panel:

Use the **FREQ CAL** potentiometer to center the "ZERO FREQUENCY" point over the second graticule line from the left. Refer to Figure 6.

6. On the scalar network analyzer:

Select **[MAIN MENU]**.

Select **[CAL]** function.

Select **[SHORT/OPEN]** then **[CHAN1]**.

Follow the directions (prompts) appearing on the CRT display:

First, connect the **SHORT** to the **TEST PORT** of the bridge, then select **[STORE/SHORT]**.
Remove the **SHORT**.

Second, connect the **OPEN** to the **TEST PORT** of the bridge, then select **[STORE/OPEN]**.
Remove the **OPEN**.

The CRT will display **OPEN/SHORT CAL SAVED IN CH1 MEM.**

Press **[DISPLAY]** until the **M-MEM** LED is on.

The CRT display should be similar to Figure 7.

7. Connect the detector to be tested (DUT) to the **TEST PORT** of the bridge.

Select **[CURSOR]** and rotate the **RPG** to read the highest trace value (worst case Return Loss) at or above 10 MHz.

Record the worst case value on the **TEST PERFORMANCE RECORD** in the space provided.

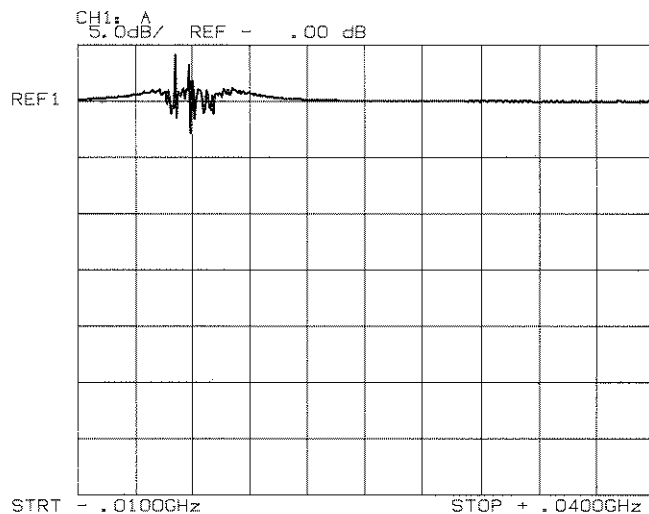

Figure 7. M-MEM Display

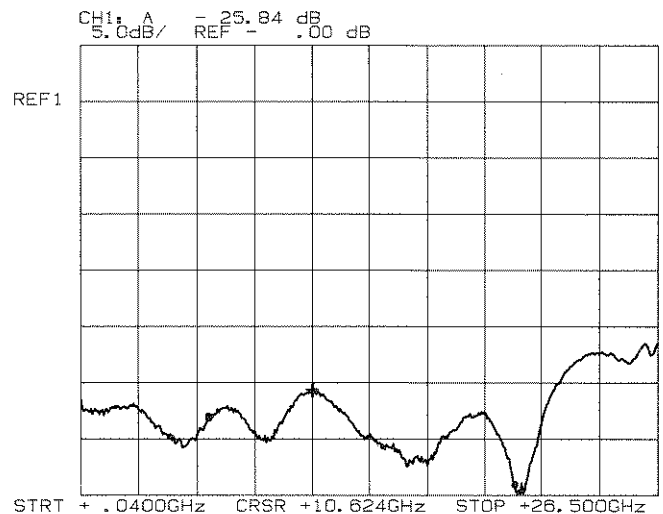

Figure 8. DUT Return Loss .04 to 26.5 GHz

Return Loss 40 MHz to 26.5 GHz

8. On the source:

Press **[START] [4] [0] [MHz]**

Press **[STOP] [2] [6] [.] [5] [GHz]**

Press **[M1] [6] [GHz]**

Press **[M2] [2] [0] [GHz]**

The scalar network analyzer will now display a response with the specification break points identified by the markers.

9. On the scalar network analyzer, ensure that the **MEAS PWR A** LED is on.

Remove the DUT.

10. It will be necessary to recalibrate the scalar network analyzer, since a new window of frequencies has been selected for measurement.

Repeat the procedure in Step 4 above.

Ensure that the Channel 1 DISPLAY **M-MEM** LED is on.

11. Connect the DUT to the **TEST PORT** of the bridge.

On the scalar network analyzer, press **[SCALE] [5] [dB]**. The display should be similar to Figure 8.

12. On the scalar network analyzer:

Select **[MAIN MENU]**, then **[CURSOR]**.

Use the **RPG** to set the cursor to the highest trace value (lowest Return Loss value) between 40 MHz and **M1**. Record this value on the TEST RECORD.

Repeat the measurement between **M1** and **M2**. Note and record value.

Repeat the measurement between **M2** and **26.5 GHz**. Note and record the value.

This completes the procedure for measuring Return Loss. If your instrument fails to meet specifications, refer to the paragraph titled MEETING SPECIFICATIONS.

FLATNESS

SPECIFICATIONS

± 0.5 dB: 10 MHz to 18 GHz

± 1.0 dB: 18 GHz to 26.5 GHz

Measured at -10 dBm.

DESCRIPTION

Flatness, as specified for this detector, is a comparative measurement. The use of a calibrated power meter and power sensor is essential to this test. First, the source will be characterized for frequency response using the power meter/sensor combination. Second, the DUT will be characterized. Finally, a point-by-point difference will be computed, plotted and compared to the specification window.

Measurement uncertainties due to mismatch error and harmonic content of the source are present. A root-sum of the squares (RSS) calculation approximates these uncertainties to be:

± 0.3 dB below 18 GHz

± 0.4 dB above 18 GHz

The final normalized error curve should fall within the window specified by the limits listed above, with consideration given to the measurement uncertainty. If the error curve falls within the gray area (refer to Figure 9), the detector probably still meets specifications.

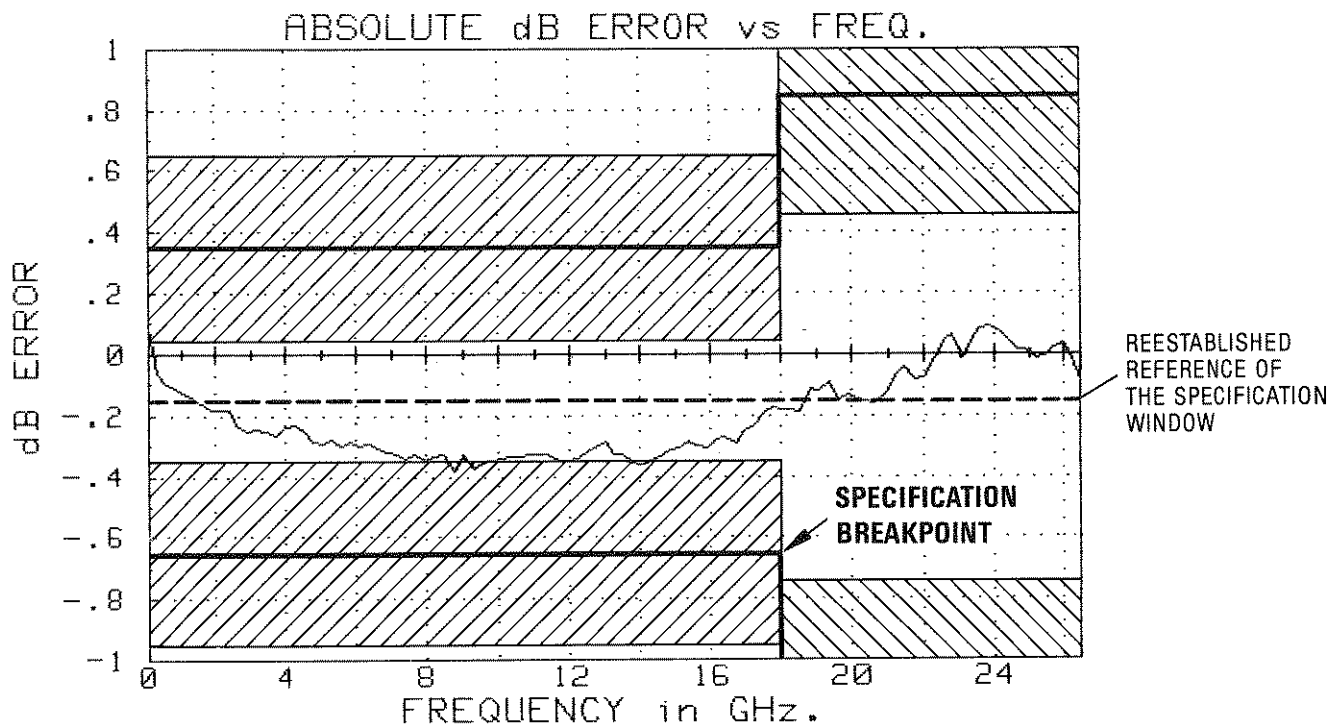

NOTE

The lower half of the specification window for the frequency range 18 to 26.5 GHz is not shown. The specification window does not need to be centered around the 0 dB reference line.

Figure 9. Absolute Error Curve

EQUIPMENT

Sweep Oscillator	HP 8350B
RF Plug-In	HP 83595A
Power Meter	HP 436A
Power Sensor	HP 8485A
Attenuators (2)	HP 8493C
Adapter	HP P/N 1250-1865

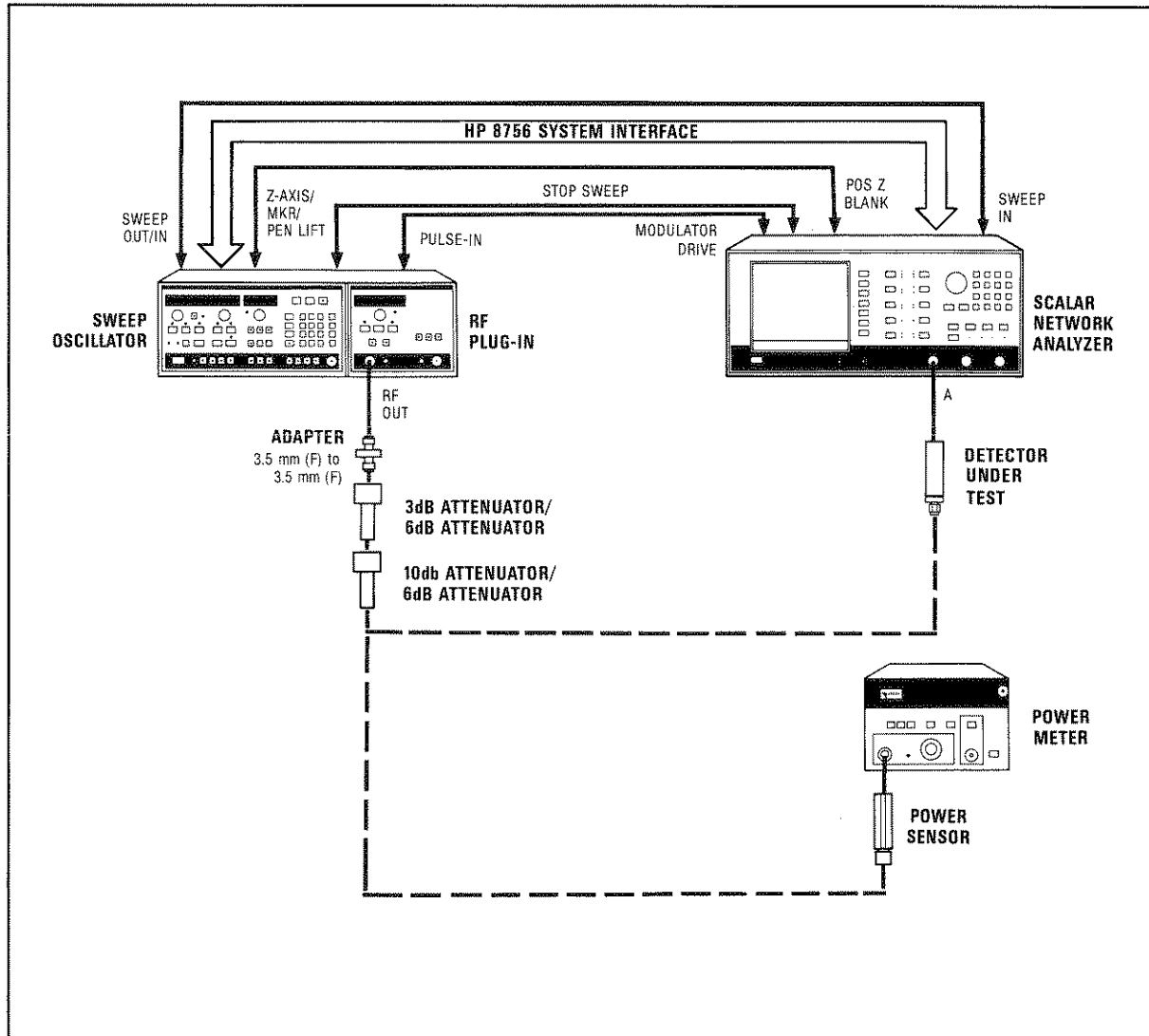

Figure 10. Flatness Test Setup

PROCEDURE

Initial

1. Set up the equipment as shown in Figure 10, with nothing connected to the attenuated output of the source.
 Turn on all equipment.
 Allow 30 minutes for warm-up.

2. On the power meter:
Press **[dBm]** mode.
Zero and calibrate the power meter. If you are unsure of how to do this, refer to the power meter Operating and Service Manual (00436-90012).
[RANGE HOLD] and **[POWER REF]** should remain out.
3. On the scalar network analyzer:
Press **[PRESET]**.
Select **[MORE]**.
Select **[MOD ON/OFF]** to turn the square wave modulation off.
4. On the source/RF plug-in:
Press **[] MOD** to turn square wave modulation off.
Press **[POWER LEVEL] [3] [dBm]** if using 13 dB attenuation or **[2] [dBm]** if using 12 dB attenuation.

Characterizing the Source

5. Connect the power meter/sensor to the attenuated output of the source.
On the source:
Press **[SHIFT] [CW]** and enter the desired Test Frequency (example: **[SHIFT] [CW] [5] [0] [MHz]**).
6. Using the CAL FACTOR CHART on the power sensor:
Set the **CAL FACTOR %** dial on the power meter to the value indicated for the test frequency, as needed. (Use the nearest frequency value.)
Note the reading on the power meter.
Record this value and the test frequency in the space provided on the TEST RECORD.
7. Repeat STEPS 5 and 6 until the source is characterized to your satisfaction. Hewlett-Packard recommends using the test frequencies noted on the TEST RECORD.

Characterizing the Detector

8. Disconnect the power meter/sensor.
Connect the detector between the attenuated output of the source and Input A of the scalar network analyzer.
9. On the scalar network analyzer:
Press **[SHIFT] Channel 2 [MEAS RATIO]** to turn Channel 2 off.
Select **[MORE]** then **[MOD ON/OFF]** to turn the square wave Modulation on.
Check for or connect a BNC to BNC cable from MODULATOR DRIVE (HP 8756A rear panel) to PULSE-IN (HP 83595A rear panel).
Select **[MAIN MENU]** then **[CURSOR]** to turn Cursor on.

10. On the source:

Press **[SHIFT] [CW]** and the desired Test Frequency. Remember to use only the test frequencies used in Steps 5 through 7.

Note and record the value indicated by the HP 8756A Cursor display.

Repeat this step until all of the same frequency points have been characterized.

Computing the Absolute Error

11. Using the values recorded in Steps 6 and 10, subtract the value in Step 6 from the value in Step 10 for each of the Test Frequencies. An example follows.

Test Frequency		Source	Detector	Difference
Recommended	Actual	Step 6	Step 10	Step 10-Step 6
.01 GHz	.01GHz	-15.1dB	-15.0dB	+0.1dB
2 GHz	2GHz	-15.4dB	-15.6dB	-0.2dB

Record the difference in the space provided on the TEST RECORD.

Plotting the Absolute Error Curve

12. Now use the graph provided on the TEST RECORD to plot the values derived in Step 11. This is the Absolute Error Curve. The peak-to-peak variations are what determine the Flatness of the detector. An example follows.

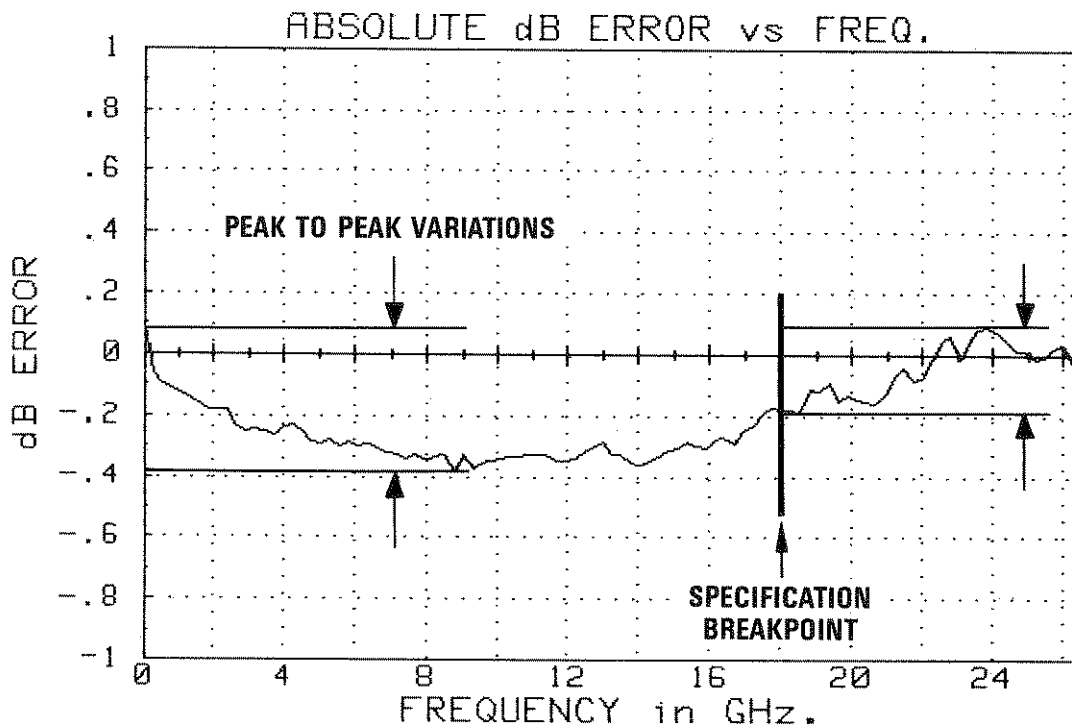

Figure 11. Absolute Error Curve

This completes the procedure for measuring Flatness. If your detector fails to meet specifications, refer to the paragraph titled MEETING SPECIFICATIONS.

MEETING SPECIFICATIONS

Failures are divided into two categories:

1. Just fails the specifications.
2. Major failures of the specifications.

Category one describes instruments that are meeting specifications in some areas, while failing others. If this is the case do the following:

Inspect the connectors; see Appendix A for mechanical inspection details.

Replace the connector(s) as necessary.

Be sure all connections are providing good electrical contact.

Inspect the detector cable for breaks and loose pins at the DC connector.

Test again.

If your instrument is still failing at the SAME points, your instrument is probably defective and you should return it for repair. If, however, your instrument fails at DIFFERENT points, there is probably a loose connection or a mechanical failure somewhere in the setup.

Category-two failures are total specification failures. If your instrument fails either of the tests completely, do the following:

Check the TEST SETUP for correct configuration of the instruments and connections.

Inspect the connectors.

Inspect the cables.

Repeat the failed test(s).

If your instrument is still failing, the instrument is probably defective and needs repair.

Remember, it is possible that one of the other instruments in the test setup is defective. For the best accuracy in measurement use only calibrated instruments.

Table 5. Performance Test Record (1 of 2)

HP 11664E DETECTOR		Tested by _____		
Serial No. _____		Date _____		
Humidity* _____ (* optional)		Temperature* _____		
RETURN LOSS				
Frequency Range	Minimum	Actual		
10 to 40 MHz	10 dB	_____ dB		
.04 to 6 GHz	20 dB	_____ dB		
6 to 20 GHz	16 dB	_____ dB		
20 to 26.5 GHz	12 dB	_____ dB		
FLATNESS TEST				
Test Frequency		Source Step 6	Detector Step 10	Difference Step 10 – Step 6
Recommended	Actual			
.01 GHz	_____	_____	_____	_____
2 GHz	_____	_____	_____	_____
4 GHz	_____	_____	_____	_____
6 GHz	_____	_____	_____	_____
8 GHz	_____	_____	_____	_____
10 GHz	_____	_____	_____	_____
12 GHz	_____	_____	_____	_____
14 GHz	_____	_____	_____	_____
16 GHz	_____	_____	_____	_____

Table 5. Performance Test Record (2 of 2)

FLATNESS TEST (Cont'd)				
Test Frequency		Source Step 6	Detector Step 10	Difference Step 10 - Step 6
Recommended	Actual			
18 GHz	_____	_____	_____	_____
20 GHz	_____	_____	_____	_____
21 GHz	_____	_____	_____	_____
22 GHz	_____	_____	_____	_____
23 GHz	_____	_____	_____	_____
24 GHz	_____	_____	_____	_____
25 GHz	_____	_____	_____	_____
26 GHz	_____	_____	_____	_____
26.5 GHz	_____	_____	_____	_____

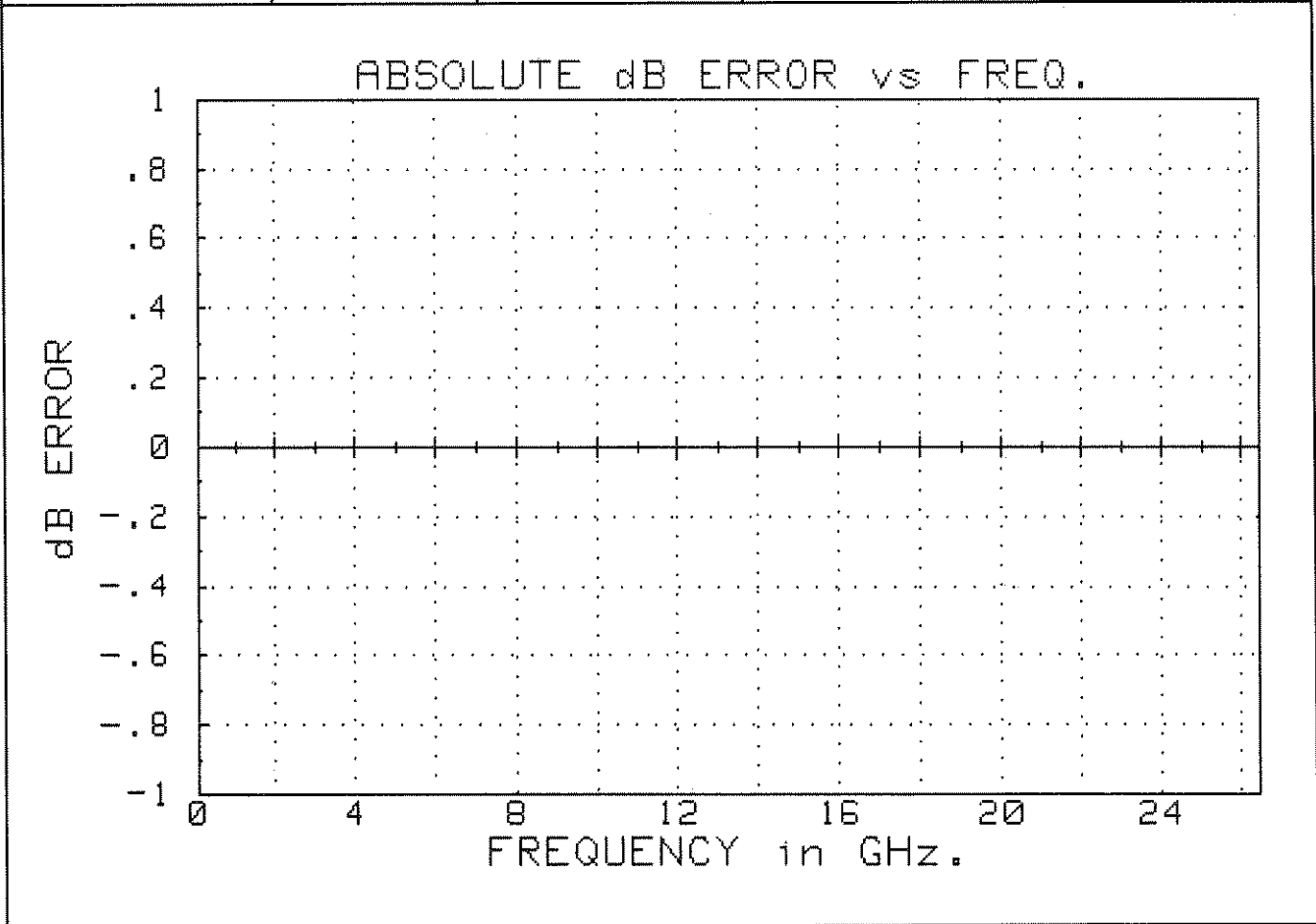

SERVICE

INTRODUCTION

This section provides procedures for replacing the Precision 3.5mm connector and the cable assembly of the HP 11664E. All parts that are replaceable are listed and information on ordering parts is given.

Adjustments. The HP 11664E contains NO ADJUSTMENTS that can be performed in the field. You will notice that there are potentiometers on the electrical assembly of the HP 11664E. These adjustments are for FACTORY ADJUSTMENT ONLY. Consequently, no adjustment procedure is given.

SAFETY CONSIDERATIONS

The voltages present in the HP 11664E are not in the range to warrant more than normal caution.

LIST OF SERVICEABLE PARTS

Only two parts are replaceable in the HP 11664E:

The RF input connector (Precision 3.5mm).

The cable assembly.

Refer to Figure 12. Major Assemblies

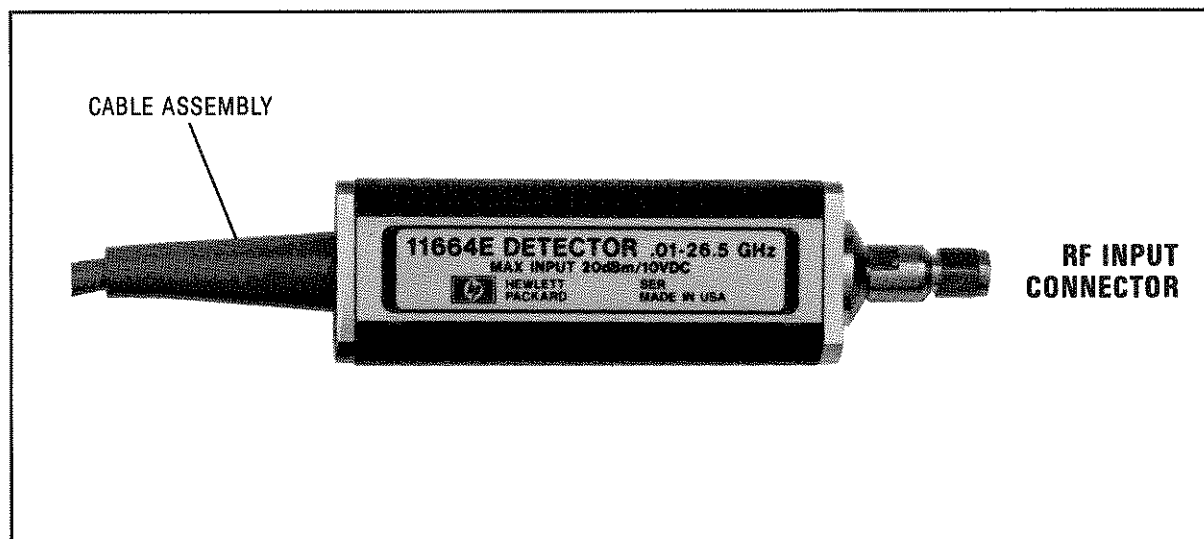

Figure 12. Major Assemblies

EQUIPMENT NEEDED FOR REPAIR

You will need the following tools to replace the RF input connector:

Torque wrench set to 20 in. lbs. (23 cm/kg) with 5/16 in. open end tip.

HP P/N 1250-1863

Precision 3.5mm Connector Gage and Calibration Block.

Maury Microwave Gage A 034B-M

Maury Microwave Cal Block 027-3

One pair of Tweezers.

ORDERING THE PARTS

Table 6 is the list of replaceable parts. The information given for each part consists of the following:

- a. The Hewlett-Packard part number.
- b. The part number check digit (CD).
- c. The total quantity (Qty) in the instrument.
- d. Description of the part.
- e. A typical manufacturer of the part in a five-digit code.
- f. The manufacturer's number for the part.

To order a part listed in the replaceable parts table, quote the Hewlett-Packard part number (with check digit), indicate the quantity required, and address the order to the nearest Hewlett-Packard office. The check digit will ensure accurate and timely processing of your order.

To request information on a part that is not listed in the replaceable parts table, include the instrument model number, instrument serial number, and the description and function of the part. Address the inquiry to the nearest Hewlett-Packard office.

REPAIR

CAUTION

SUSCEPTIBLE TO DAMAGE FROM STATIC DISCHARGE.

The best method of preventing ESD is for the technician to wear a grounding strap connected to a conductive bench mat that provides a path to ground of between 1 and 2.5 Megohms.

SMALL DELICATE PARTS

Table 6. Replaceable Parts

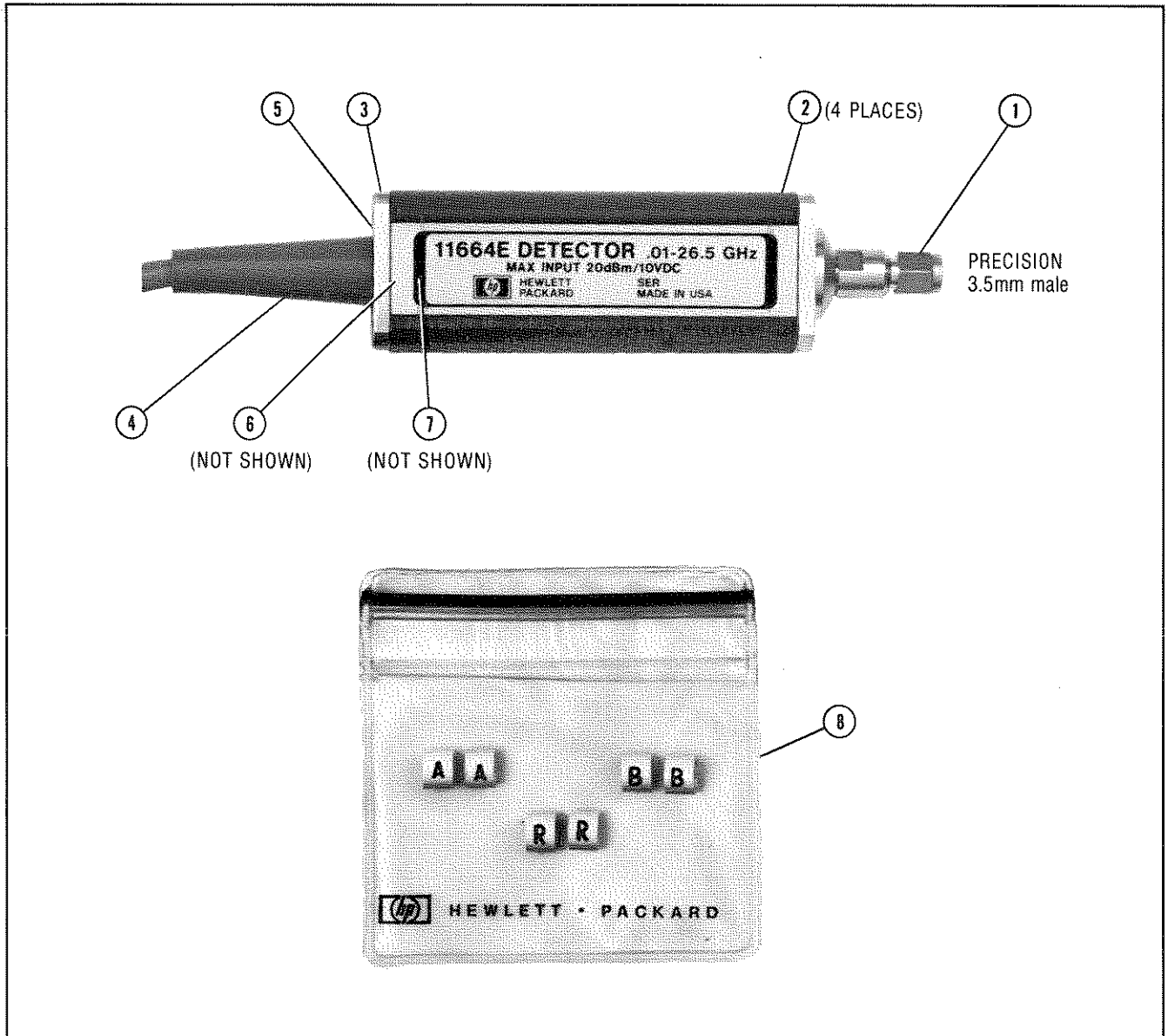

Item	HP Part Number	CD	Qty.	Description	Mfr. Code	Mfr. Part Number
1	11664-60028	3	1	Input Connector Kit Precision 3.5mm male includes: 1 preassembled Connector 1 extra spring 1 extra elastimer 1 shim	28480	11664-60028
2	2200-0167	8	4	Screw-Machine 4-40 .188-IN-LG 82 Degree	28480	2200-0167
3	11664-20004	7	1	End Plate	28480	11664-20004
4	8120-3804	7	1	Cable Assembly (W1)	28480	8120-3804
5				Washer, P/O W1		
6	2190-0016	3	1	Washer-Lock Internal Tooth 3/8 in .377-IN-ID (Not Shown)	28480	2190-0016
7	2950-0001	8	1	Nut-Hex-Double Chamfer (Not Shown)	28480	2950-0001
8	5061-1044	9	1	Cable Marker Kit	28480	5061-1044

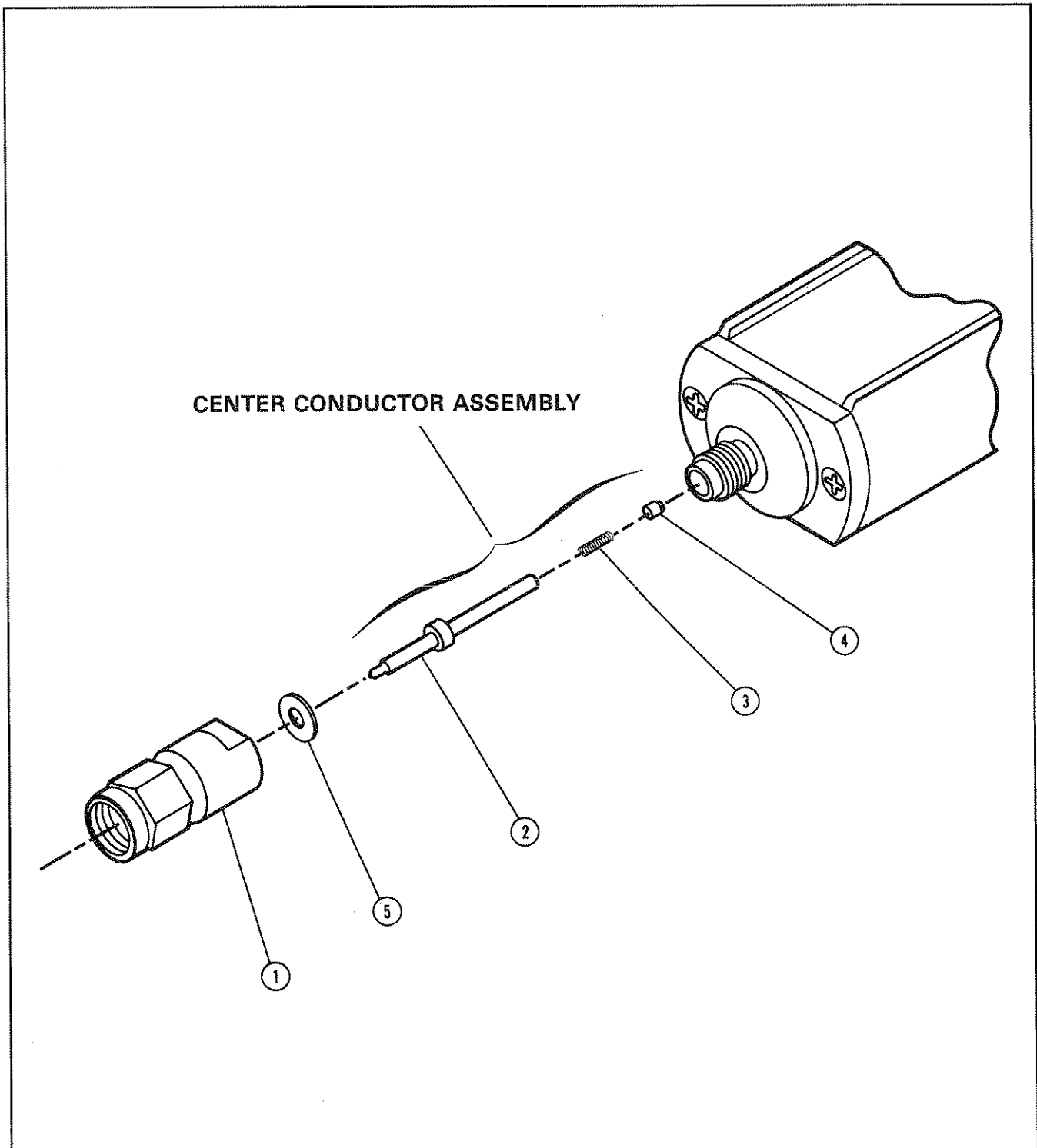

Item	Description
1	3.5mm Connector Nut
2	Center Conductor
3	Spring
4	Elastimer
5	Shim

Figure 13. Input Connector Exploded View

Replacing the Input Connector. Order the replacement connector kit (J1 in Table 6). When it arrives do the following:

1. Remove the defective connector. Be sure the elastimer and spring are still attached to the center conductor assembly. If they are not, gently shake the detector until both parts have been removed from the main body.
2. Install the center conductor assembly into the 3.5mm connector nut.

NOTE: The center conductor should already be installed.

If the center conductor assembly does not have the elastimer in place you will need to reassemble it.

- a. Insert the spring into the hole at the end of the center conductor.
 - b. Place the elastimer in the hole on top of the spring with the rounded end up.
 - c. Using the flat end of the tweezers, push down gently on the elastimer.
3. Screw connector nut assembly onto the main body of the detector.
 4. Using a pre-calibrated Pin Depth Measurement Gage measure the connector pin depth. (Refer to Appendix A, Mechanical Inspection, in this manual for details.) The correct reading is between 0 and +3 mils (0 and +0.003). If the reading is negative:
 - a. Remove the nut assembly from the main body.
 - b. Remove the center conductor assembly and add the SHIM over the male pin of the center conductor assembly.
 - c. Reassemble as in Steps 2 and 3. Measure the connector pin depth.
 - d. If the gage indicates that the pin depth is still out of tolerance, you may have received a defective part. Contact your nearest Hewlett-Packard office for further instructions.

NOTE: The SHIM is normally not needed.

CAUTION

Pin depth is extremely important. An out-of-tolerance pin depth may cause damage to both female and male connector mating surfaces.

5. Tighten the nut using the torque wrench set at 20 in./lbs.
6. Perform both Performance Tests to verify that the instrument still meets specifications.

Replacing the Cable Assembly. Order the cable assembly (W1 in Table 6). When it arrives do the following:

1. Remove the two pozi-drive screws on the cable end plate.
2. Slide the printed circuit assembly out of the housing by pulling on the cable.
3. Carefully remove all cable wires from the board.

4. Remove the lock washer and hex nut that hold the cable to the end plate, and remove the old cable.
5. Place new cable through the end plate and secure with lock washer and hex nut.
6. Install wires of the replacement cable in the printed circuit board (refer to Figure 14 for proper placement).
7. Ensure that all cable wires are securely connected to the board.
8. Slide the board into the runners on the inside of the housing.
9. Reinstall and tighten the two pozi-drive screws.

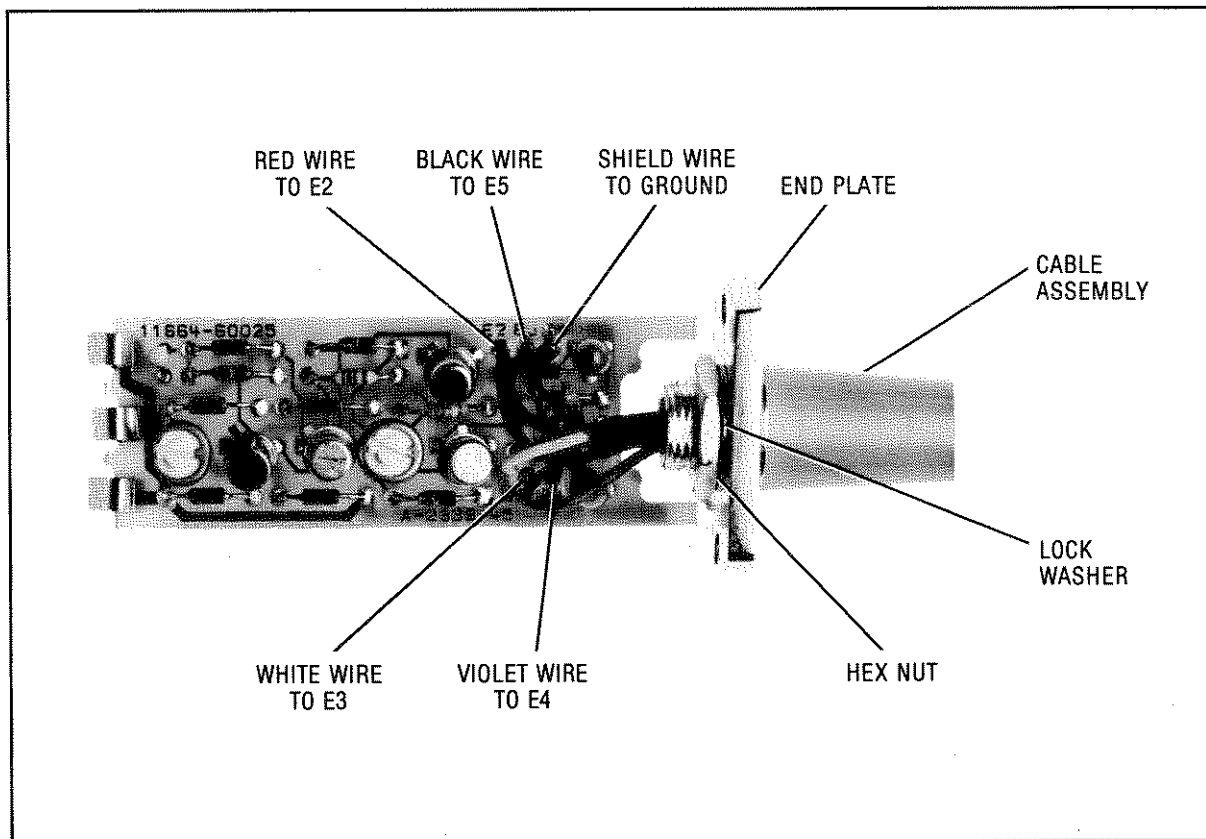

Figure 14. Cable Connections

MANUAL CHANGES

INSTRUMENTS COVERED BY MANUAL

Each HP 11664E has a unique serial number. The contents of this manual apply directly to instruments with serial number 00101 and above.

An HP 11664E manufactured after the printing of this manual may require a yellow Manual Changes Supplement to document instrument "change information." The supplement will be included with the instrument manual. In addition to change information, the supplement contains information for correcting manual errors. To keep this manual as current as possible, Hewlett-Packard recommends that you periodically request the latest Manual Changes Supplement. The supplement for this manual is keyed to its print date and part number, which appear on the title page. Complimentary copies of the supplement are available from your local Hewlett-Packard office listed at the back of this manual. This manual was written for and applies directly to instruments with serial number 00101 and above.

Ordering Manuals/Microfiche. On the title page is a manual part number, as well as, a microfiche part number that can be used to order extra copies of the manual. Microfiche are microfilm transparencies (10 cm × 15 cm, 4 in × 6 in). Each microfiche contains reduced photocopies of the manual pages. Also included in the microfiche package are the latest Manual Changes Supplement and pertinent Service Notes. For information on how to order refer to the paragraph titled ORDERING THE PARTS.

APPENDIX A MECHANICAL INSPECTION

MECHANICAL INSPECTION: GAGING THE PRECISION CONNECTOR

Mechanical inspection of the connector is extremely important and should be done periodically. This consists of using a male precision 3.5mm connector gage to check the mechanical dimensions of the connector. The purpose of doing this is to make sure that a perfect mating will occur between the connector surfaces. Perfect mating assures a good electrical match, and it is very important mechanically, to avoid damaging the connectors themselves.

The critical dimension you will be measuring is the recession of the center conductor. The maximum allowable recession of the center conductor is 0.003 in. (0.08mm).

If any contact **protrudes beyond** the outer conductor mating plane it is out of tolerance and must be replaced. The out-of-tolerance connector will permanently damage any connector attached to it. Destructive electrical interference will also result, due to buckling of the female contact fingers. This is often noticeable as a power hole of several dB occurring at about 22 GHz.

If any contact is **recessed too far behind** the outer conductor mating plane (> 0.003 in.) poor electrical contact will result, causing high electrical reflections. Careful gaging of all connectors will help prevent this condition.

Before using the connector gage to measure the connector, don't forget to inspect the end of the gage itself and the calibration block visually. Dirty or damaged gage facings can cause dirty or damaged connectors!

Figures A1 and A2 show how to use a connector gage. First zero the gage itself using the calibration block, following the procedure outlined in Figure A1.

Figure A3 shows how to measure precision 3.5mm connectors. Note that a plus (+) reading on the gage indicates recession of the center conductor; a minus (-) reading indicates a protrusion. Since no protrusion is allowable, readings for connectors that are within the allowable tolerance range will always be on the plus (+) scale of the gage.

MALE

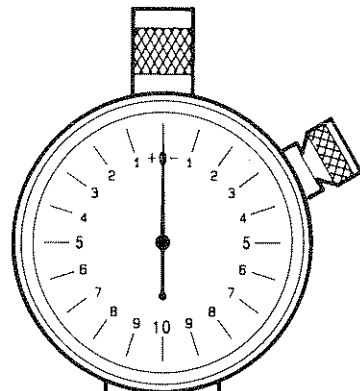

GRASP THE GAGE HERE FOR MAXIMUM STABILITY.

GAGE FOR MALE CONNECTORS HAS CIRCULAR BUSHING AROUND GAGE PLUNGER.

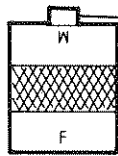

USE PROTRUDING END OF GAGE CALIBRATION BLOCK TO ZERO MALE CONNECTOR GAGE.

SCALE DIVISIONS
0.00025 IN.

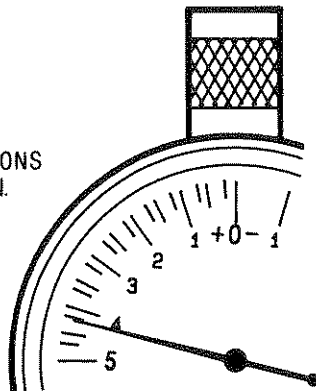

EXAMPLE

READING IS + 0.00425
THIS INDICATES RECESSION
OF THE CENTER CONDUCTOR
OF 0.00425

Figure A1. Precision 3.5mm Connector Gages

ZEROING GAGES

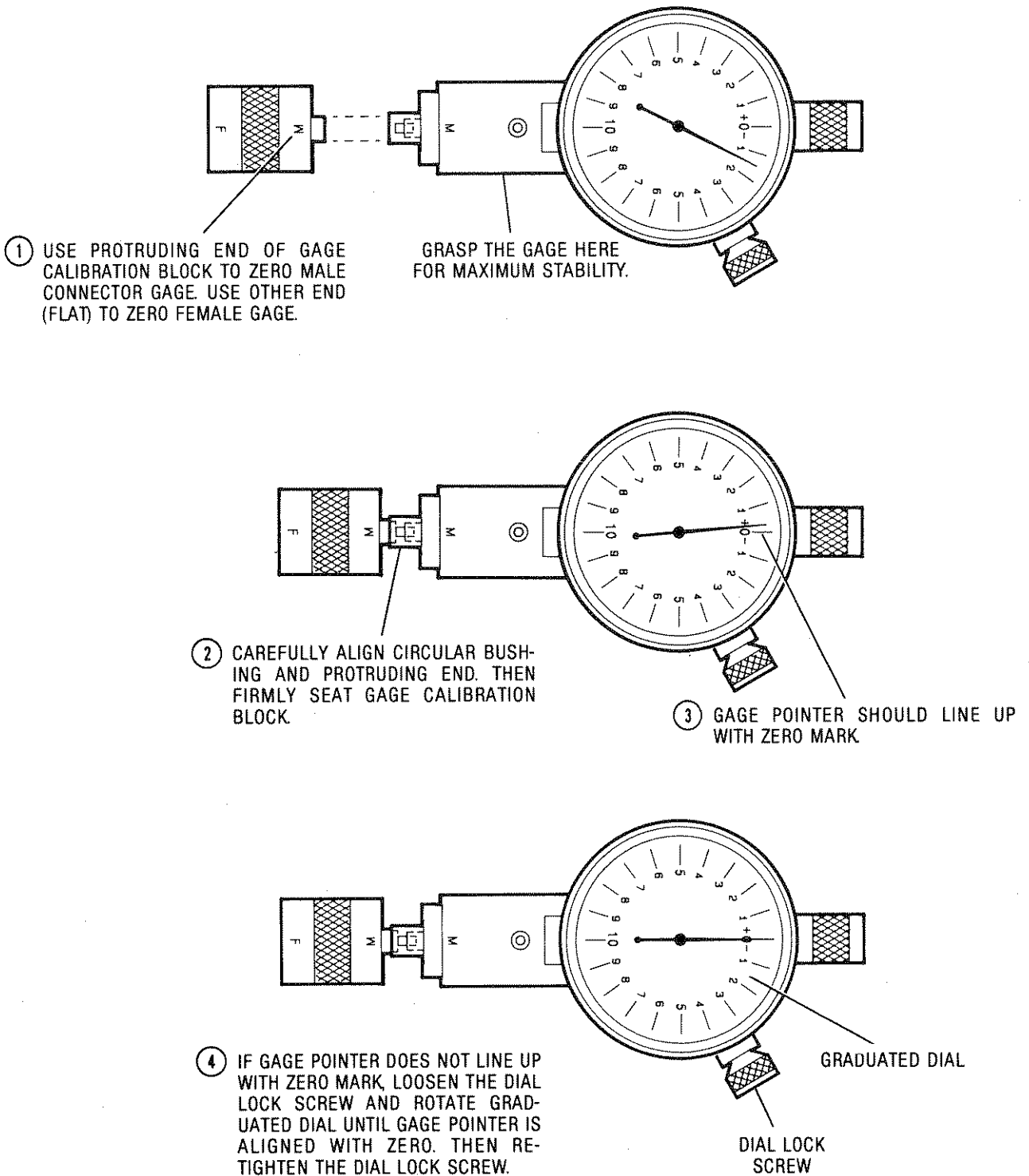

Figure A2. Zeroing Precision 3.5mm Connector Gages

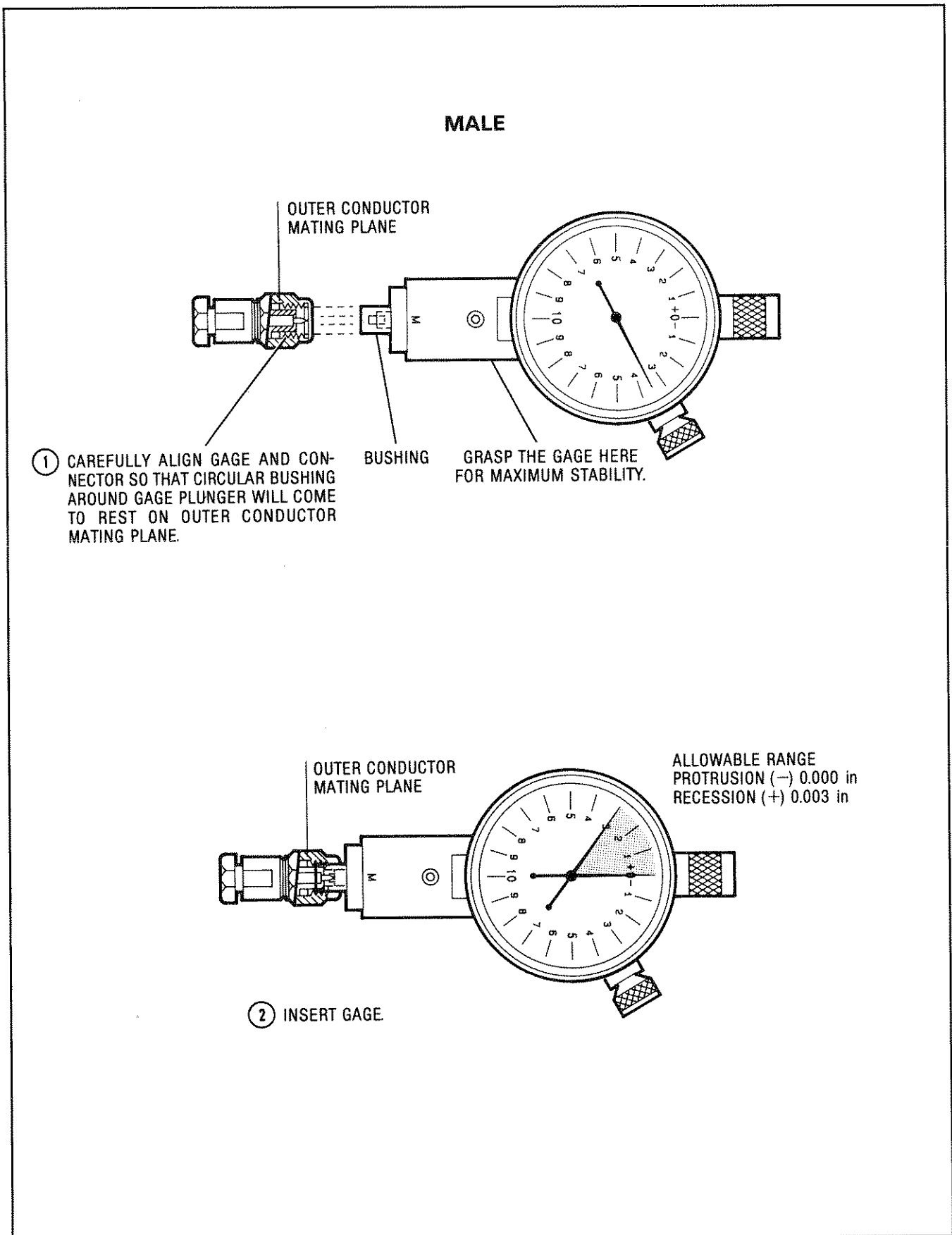

Figure A3. Measuring Precision 3.5mm Male Connectors

APPENDIX B

AUTOMATED FLATNESS PROGRAM LISTING

AUTOMATING THE FLATNESS TEST

The program listings on the following pages will allow the operator to automate the flatness test of the detector. This test will determine the flatness at up to 401 points in just a few minutes. The program will first measure the flatness of the source (taking into account the flatness of the power sensor), then measure the flatness of the detector, and finally plot the difference between the two on the computer's CRT. This is identical to the manual version of the test and therefore the results should also be identical.

The following equipment is recommended to run the program:

An HP Series 200 Computer with BASIC 2.0 or 3.0

Sufficient memory to load the operating language plus 10K bytes
(the program itself requires less than 10K bytes of memory)

A signal source: HP 8350B with HP 83595A plug-in* OR an HP 8340A

HP 8756A or HP 8757A Scalar Network Analyzer

HP 436A Power Meter with an HP 8485A Power Sensor

Two Precision 3.5mm attenuators; total of 12 or 13 dB: HP 8493C

3 HP-IB cables: HP 10833A/B/C/D (4 required if a printer is used)

Printer: (optional) for hard copies; capable of a graphics dump

There are actually two separate program listings. The first program allows the operator to input the calibration factors listed on the power sensor. These cal factors are then stored on a disc for future use under a file name that contains the power sensor serial number. This allows the storage of cal factors for more than one power sensor. At the beginning of the flatness program the operator will be asked to input the serial number of the power sensor and only data for that power sensor will be loaded into memory. Up to 50 cal factors can be stored in each file although only 35 are shown on the HP 8485A power sensor. A two-dimensional array is created containing up to 50 combinations of a frequency and its associated cal factor. This program need only be run once in order to store the file on disc.

The second program performs the actual measurement of flatness using the cal factors stored on the disc. Any number of frequency points, up to 401, may be chosen although 101 points is more than sufficient and takes much less time. The cal factor used will be interpolated between the two closest frequency points. The cal factor used for frequencies measured below the lowest entered frequency point of the array will default to the cal factor of the lowest entered frequency point. A similar method is used at the high end.

In order to reduce the amount of time required to copy these programs, the code listings represent a minimum configuration that will perform the measurement. There is almost no error checking or convenience features. Use care when entering data and when following the instructions displayed.

* The HP 83595A used should have a serial prefix of 2411A or greater. While earlier versions will work in this configuration, some additional inaccuracies may be introduced.

NOTES ON THE TWO PROGRAMS

Cal Factor Entry Program

When requested, enter only the last few significant digits of the power sensor serial number (no more than 5 digits).

Always enter the frequency in GHz, NOT MHz!

Always enter BOTH the frequency and the cal factor. For example, if the first cal factor is 99% at 50 MHz then enter **.05,99** then press **[ENTER]**.

Each entered frequency **MUST** be greater than the preceding frequency.

Fractional percentages **ARE** allowed (e.g.: 98.5).

If a mistake has been made, it is possible to back up by entering a negative frequency. Each negative input will back up one entry and each entry will have to be input again.

When all the cal factors have been input then enter **0,0** to exit.

The program will re-display all of the entered points when done. Verify the accuracy of each. Pressing **[CONTINUE]** will attempt to store the file on the disc; make sure the disc is **NOT** write-protected.

Detector Flatness Program

When requested, enter only the last few significant digits of the power sensor serial number (no more than 5 digits).

When requested, enter the number of frequency points to be taken (no more than 401). The data points will be evenly spaced across the frequency range.

When requested, connect the calibrated power sensor to the attenuated output of the source. The program will automatically zero the meter.

When requested, remove the power sensor and connect the detector under test to the attenuated output of the source. Connect the input cable of the detector to the "A" input of the scalar network analyzer.

A typical displayed output of the program is shown in Figure B1.

If the displayed frequency response exceeds the limits of the graph, it may be necessary to increase value of the "Scale" variable in line 210.

Once one detector has been measured, more may be measured by pressing the **[CONTINUE]** key. To re-calibrate the source again, press **[RUN]**.

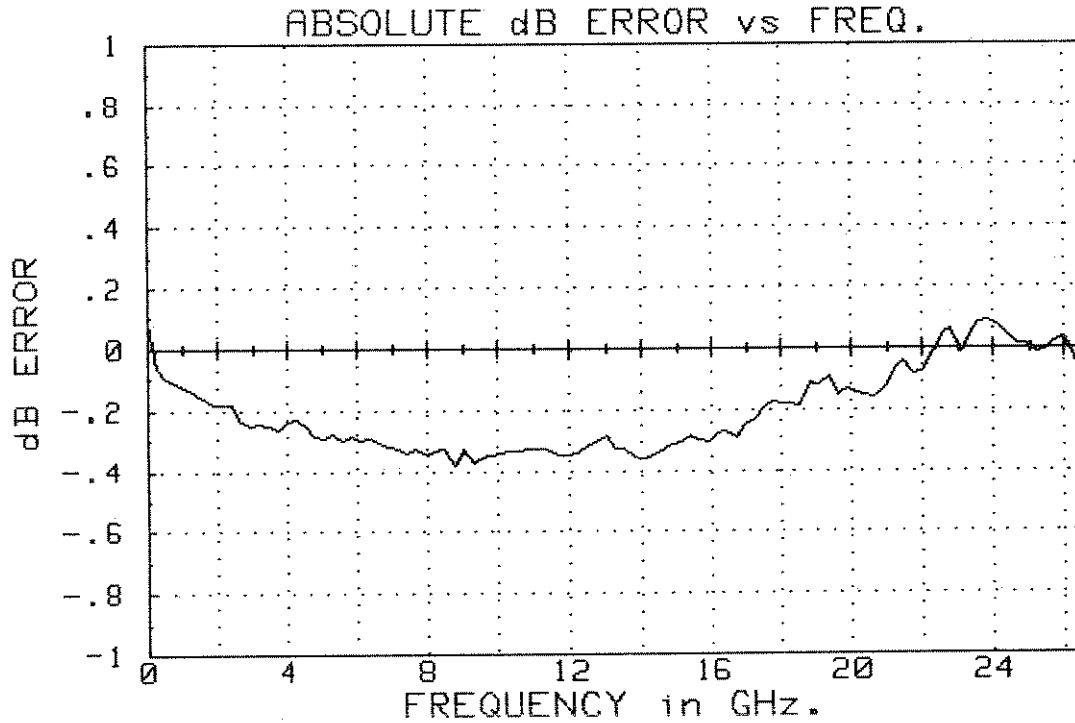

Figure B1. Typical Program Output

MEASUREMENT SETUP

Connect the equipment in the same manner as the manual flatness test described in Figure 10. Connect HP-IB cables from the computer to the HP-IB inputs of both the power meter and the scalar network analyzer. If using the HP 8340A (or an HP 8341A with pulse option), connect the modulator drive from the analyzer to the pulse input. DO NOT use the AM input on the source.

The HP-IB addresses are as follows:

Analyzer-716

Source-19*

Power Meter-713

* The Source is connected to the Analyzer's System Interface Bus NOT the Computer's HP-IB.

A printer may be connected to the HP-IB at address 701 if hard copy results are required. The printer must be capable of a graphics dump.

POWER METER CAL FACTOR ENTRY PROGRAM (1 of 2)

```

10  ! POWER METER CAL FACTOR ENTRY PROGRAM
20  ! Creates 2 dim array of freq (in MHz) vs cal factor (in percent)
30  ! Assigns a file name of "PM_xxxxx" (xxxxx is the pmr sensor serial #)
40  !
50  OPTION BASE 0
60  DIM Cal(1:50,1:2)
70  INTEGER I,Pm_points
80  !
90  GRAPHICS OFF
100 PRINTER IS 1
110 OFF KEY
120 OUTPUT 1;CHR$(12)
130 BEEP 300,.1
140 INPUT "ENTER THE POWER SENSOR SERIAL # (LAST 5 DIGITS)",Serial
150 !
160 PRINT USING "3/,K,/";"ENTER BOTH FREQ AND CAL SEPARATED BY A COMMA."
170 PRINT "ENTERING A NEG FREQ WILL BACK UP."
180 PRINT USING "3/,K,/";" #      FREQ      CAL%"
190 !
200 FOR I=1 TO 50 ! 50 POINTS MAX
210 Entry: !
220     BEEP 200,.02
230     DISP I;". Enter FREQ (in GHz) and CAL (in %). ""0 EXITS""";
240     INPUT "",Freq,Pct
250     IF Freq=0 OR Pct=0 THEN GOTO Done
260     Freq=Freq*1000
270     IF Freq<0 THEN
280         I=I-1
290         BEEP 1000,.02
300         GOTO Entry
310     END IF
320     IF I>1 THEN
330         IF Freq<=Cal(I-1,1) THEN
340             DISP "FREQ MUST BE GREATER THAN LAST ENTRY... TRY AGAIN!"
350             BEEP 2000,.5
360             WAIT 2
370             GOTO Entry
380         END IF
390     END IF
400     Cal(I,1)=Freq
410     Cal(I,2)=Pct
420     PRINT USING "DD,3X,6D.D,5X,3D.D";I,Freq,Pct
430 NEXT I
440 !
450 Done: ! DISPLAY ENTERED VALUES
460     Pm_points=I-1
470     OUTPUT 1;CHR$(12)
480     PRINT USING "K,/K,/";"      ENTERED VALUES"," #      FREQ      CAL%"
490     FOR I=1 TO Pm_points
500         PRINT USING "DD,3X,6D.D,5X,3D.D";I,Cal(I,1),Cal(I,2)
510     NEXT I
520     PRINT "Power Sensor serial number =";Serial

```

POWER METER CAL FACTOR ENTRY PROGRAM (2 of 2)

```
530 BEEP 400,.1
540 DISP "PRESS CONTINUE TO STORE DATA ON DISC."
550 PAUSE
560 !
570 DISP
580 ON ERROR GOSUB Error
590 ASSIGN @File TO "PM_"&VAL$(Serial)
600 OFF ERROR
610 OUTPUT @File;Pm_points,Cal(*)
620 ASSIGN @File TO *
630 BEEP 500,.02
640 DISP "CAL FACTORS HAVE BEEN STORED ON DISC."
650 CAT
660 STOP
670 !
680 ! *****
690 Error: ! ERROR ON ASSIGNMENT.
700 !
710 IF ERRN=56 THEN ! NO EXISTING FILE
720     CREATE BDAT "PM_"&VAL$(Serial),4 ! CREATE FILE
730     RETURN
740 END IF
750 DISP "ERROR # ";ERRN;" FIX, THEN PRESS CONTINUE"
760 BEEP 2000,.3
770 PAUSE
780 DISP
790 RETURN
800 END
```

DETECTOR FLATNESS PROGRAM (1 of 4)

```

10  ! DETECTOR FLATNESS PROGRAM
20  ! Plots detector measurements vs power meter measurements.
30  !
40  OPTION BASE 0
50  COM INTEGER Cal_data_flg
60  COM /Cal_f/ Cal(1:50,1:2),INTEGER Pm_points
70  COM /Measure/ Meas(1:401,1:3),Set_power,Start,Stop,Scale,INTEGER Points
80  COM /Hplib/ @Sna,@Source,@Pwr_mtr
90  !
100 GINIT
110 CALL Clear_screen
120 OFF KEY
130 ASSIGN @Sna TO 716      ! Scalar Network Analyzer address
140 ASSIGN @Source TO 717  ! Passthrough address to Source
150 ASSIGN @Pwr_mtr TO 713 ! Power Meter address
160 !
170 Max_points=401
180 Start=10      ! Start frequency in MHz
190 Stop=26510   ! Stop frequency in MHz
200 Set_power=2  ! Power level set point of source in dBm
210 Scale=1     ! dB (+/- graph limits)
220 !
230 IF NOT Cal_data_flg THEN ! get cal data on power sensor
240   DISP "ENTER THE POWER SENSOR SERIAL # (LAST 5 DIGITS)";
250   BEEP 700,.1
260   INPUT Serial
270   DISP "LOADING CAL FACTORS"
280   ASSIGN @File TO "PM_&VAL$(Serial)
290   ENTER @File;Pm_points,Cal(*) ! Load cal factors
300   ASSIGN @File TO *
310   Cal_data_flg=1
320   DISP
330 END IF
340 BEEP 500,.1
350 DISP "ENTER NUMBER OF POINTS TO BE MEASURED (";Max_points;"MAX)";
360 INPUT Points
370 Step_size=(Stop-Start)/(Points-1)
380 FOR I=1 TO Points
390   Meas(I,1)=Start+Step_size*(I-1)
400 NEXT I
410 REMOTE 7
420 OUTPUT @Sna;"IP PT19" ! preset system
430 CALL Set
440 LOOP
450   CALL Verify
460   BEEP 300,.1
470   DISP "          To repeat...press CONTINUE;  to re-cal...RUN "
480   PAUSE
490   !
500 END LOOP
510 END
520 !

```

DETECTOR FLATNESS PROGRAM (2 of 4)

```

530  ! ***** SUB PROGRAMS *****
540  !
550  SUB Corr_pwr(Freq,Power) ! uses cal factor to find actual power read
560    COM /Cal_f/ Cal(*),INTEGER Pm_points
570    IF Freq<Cal(1,1) THEN ! freq too low, use first value
580      Cal_factor=Cal(1,2)
590      GOTO Act_pwr
600    END IF
610    X=0
620    REPEAT
630      X=X+1
640      IF X>Pm_points THEN ! freq too high, use last value
650        Cal_factor=Cal(Pm_points,2)
660        GOTO Act_pwr
670      END IF
680    UNTIL Freq<Cal(X,1)
690    Frac=(Freq-Cal(X-1,1))/(Cal(X,1)-Cal(X-1,1))
700    Cal_factor=Frac*(Cal(X,2)-Cal(X-1,2))+Cal(X-1,2) ! cal factor in %
710  Act_pwr:Power=Power-(10*LGT(Cal_factor/100)) ! actual power read
720  SUBEND
730  !
740  SUB Set ! finds freq response of source using pwr mtr as ref.
750    COM /Cal_f/ Cal(*),INTEGER Pm_points
760    COM /Measure/ Meas(*),Set_power,Start,Stop,Scale,INTEGER Points
770    COM /HpiB/ @Sna,@Source,@Pwr_mtr
780    Clear_screen
790    OUTPUT @Sna;"MD0"
800    OUTPUT @Source;"MD0 CW PL-60DB RF0" ! works for 8350 or 8340/41
810    BEEP 400,.1
820    DISP "CONNECT POWER SENSOR TO ATTENUATORS"
830    PAUSE
840    !
850    CALL Zero_mtr
860    OUTPUT @Source;"PL";Set_power;"DB RF1 MD0 SV1 AM0 PM1" ! for 8350/40/41
870    FOR I=1 TO Points
880      OUTPUT @Source;"CW";Meas(I,1);"MZ"
890      IF I=1 THEN WAIT 5
900      Read_pwr(Meas(I,2))
910      Corr_pwr(Meas(I,1),Meas(I,2))
920      DISP USING 930;"Freq =";Meas(I,1);"MHz      Power =";Meas(I,2);"dBm"
930      IMAGE K,6D.D,K,3D.2D,K
940    NEXT I
950    DISP
960    Set_flg=1
970  SUBEND
980  !
990  SUB Clear_screen ! clears alpha and graphics screen
1000    GRAPHICS OFF
1010    OUTPUT 1;CHR$(12)
1020    DISP
1030  SUBEND
1040  !

```

DETECTOR FLATNESS PROGRAM (3 of 4)

```

1050 SUB Read_pwr(Power) ! reads power from 436A power meter @ 100%
1060   COM /HpiB/ @Sna,@Source,@Pwr_mtr
1070   REPEAT
1080     WAIT .3
1090     OUTPUT @Pwr_mtr;"9D+T"
1100     ENTER @Pwr_mtr USING "B,B,X,K";Sts,Range,Power
1110   UNTIL Sts=80
1120 SUBEND
1130 !
1140 SUB Zero_mtr
1150   COM /HpiB/ @Sna,@Source,@Pwr_mtr
1160   DISP "STAND-BY... zeroing power meter"
1170   OUTPUT @Pwr_mtr;"A1+R"
1180   WAIT 7
1190   OUTPUT @Pwr_mtr;"Z1+R"
1200   OUTPUT @Pwr_mtr;"9D+V"
1210   WAIT 7
1220   DISP
1230 SUBEND
1240 !
1250 SUB Verify ! measures detector response
1260   COM /Cal_f/ Cal(*),INTEGER Pm_points
1270   COM /Measure/ Meas(*),Set_power,Start,Stop,Scale,INTEGER Points
1280   COM /HpiB/ @Sna,@Source,@Pwr_mtr
1290   INTEGER I
1300   Clear_screen
1310   OUTPUT @Sna;"C2 C0 C1 IA ME FD0 MD1 SW0 RF1"
1320   BEEP 400,.01
1330   DISP "CONNECT DETECTOR TO ATTEN AND TO INPUT ""A"" "
1340   PAUSE
1350   !
1360   ALPHA OFF
1370   Graticule
1380   GRAPHICS ON
1390   PEN 1
1400   OUTPUT @Source;"PL";Set_power;"DB RF1"
1410   FOR I=1 TO Points
1420     OUTPUT @Source;"CW";Meas(I,1);"MZ"
1430     WAIT .3
1440     OUTPUT @Sna;"OV"
1450     ENTER @Sna;Meas(I,3)
1460     Db_err=Meas(I,3)-Meas(I,2)
1470     IF I=1 THEN MOVE Meas(I,1),Db_err
1480     PLOT Meas(I,1),Db_err
1490   NEXT I
1500 SUBEND
1510 !
1520 SUB Graticule ! generates graphics graticule
1530   COM /Measure/ Meas(*),Set_power,Start,Stop,Scale,INTEGER Points
1540   GCLEAR
1550   DEG
1560   LDIR 0

```

DETECTOR FLATNESS PROGRAM (4 of 4)

```
1570      !
1580      ! ** GRATICULE **
1590      X=Stop-Start
1600      Xmin=-.15*X
1610      Xmax=1.02*X
1620      Ymax=1.2*Scale
1630      Ymin=-1.5*Scale
1640      WINDOW Xmin,Xmax,Ymin,Ymax
1650      CLIP 0,X,-Scale,Scale
1660      FRAME
1670      LINE TYPE 3
1680      GRID 2000,Scale/5,0,0
1690      LINE TYPE 1
1700      AXES 1000,Scale/10,0,0,2,2
1710      CLIP OFF
1720      !
1730      ! ** X-AXIS LABEL **
1740      CSIZE 4.3
1750      FOR I=INT(Start/1000) TO Stop STEP 4000
1760          LOG 6
1770          MOVE I,-Scale
1780          LABEL I/1000
1790      NEXT I
1800      !
1810      ! ** Y-AXIS LABEL **
1820      FOR I=-Scale TO Scale STEP Scale/5
1830          LOG 8
1840          MOVE 0,I
1850          LABEL(INT(I*100+.5))/100
1860      NEXT I
1870      !
1880      ! ** LABELS **
1890      CSIZE 5
1900      LOG 4
1910      MOVE (Stop-Start)/2,Scale
1920      LABEL "ABSOLUTE dB ERROR vs FREQ."
1930      LOG 6
1940      MOVE (Stop-Start)/2,-Scale*1.10
1950      LABEL "FREQUENCY in GHz."
1960      LDIR 90
1970      MOVE Xmin,0
1980      LABEL "dB ERROR"
1990      SUBEND
```