

Operation and Service Manual

HP 11947A Transient Limiter



**HEWLETT
PACKARD**

HP Part No. 11947-90006
Printed in USA January 1991

©Copyright Hewlett-Packard Company 1991

All Rights Reserved. Reproduction, adaptation, or translation without prior written permission is prohibited, except as allowed under the copyright laws.

1212 Valley House Drive, Rohnert Park, CA 94928-4999, USA

Safety Symbols

The following safety symbols are used throughout this manual. Familiarize yourself with each of the symbols and its meaning before operating this instrument.

Caution



The *caution* sign denotes a hazard. It calls attention to a procedure which, if not correctly performed or adhered to, could result in damage to or destruction of the instrument. Do not proceed beyond a *caution* sign until the indicated conditions are fully understood and met.

Warning



The *warning* sign denotes a hazard. It calls attention to a procedure which, if not correctly performed or adhered to, could result in injury or loss of life. Do not proceed beyond a *warning* sign until the indicated conditions are fully understood and met.

General Safety Considerations

Warning



Before this instrument is switched on, make sure it has been properly grounded through the protective conductor of the ac power cable to a socket outlet provided with protective earth contact.

Any interruption of the protective (grounding) conductor, inside or outside the instrument, or disconnection of the protective earth terminal can result in personal injury.

Warning



There are many points in the instrument which can, if contacted, cause personal injury. Be extremely careful.

Any adjustments or service procedures that require operation of the instrument with protective covers removed should be performed only by trained service personnel.

Caution



Before this instrument is switched on, make sure its primary power circuitry has been adapted to the voltage of the ac power source.

Failure to set the ac power input to the correct voltage could cause damage to the instrument when the ac power cable is plugged in.

Certification

Hewlett-Packard Company certifies that this product met its published specifications at the time of shipment from the factory. Hewlett-Packard further certifies that its calibration measurements are traceable to the United States National Institute of Standards and Technology, to the extent allowed by the Institute's calibration facility, and to the calibration facilities of other International Standards Organization members.

Warranty

This Hewlett-Packard instrument product is warranted against defects in material and workmanship for a period of one year from date of shipment. During the warranty period, Hewlett-Packard Company will, at its option, either repair or replace products which prove to be defective.

For warranty service or repair, this product must be returned to a service facility designated by Hewlett-Packard. Buyer shall prepay shipping charges to Hewlett-Packard and Hewlett-Packard shall pay shipping charges to return the product to Buyer. However, Buyer shall pay all shipping charges, duties, and taxes for products returned to Hewlett-Packard from another country.

Hewlett-Packard warrants that its software and firmware designated by Hewlett-Packard for use with an instrument will execute its programming instructions when properly installed on that instrument. Hewlett-Packard does not warrant that the operation of the instrument, or software, or firmware will be uninterrupted or error-free.

LIMITATION OF WARRANTY

The foregoing warranty shall not apply to defects resulting from improper or inadequate maintenance by Buyer, Buyer-supplied software or interfacing, unauthorized modification or misuse, operation outside of the environmental specifications for the product, or improper site preparation or maintenance.

NO OTHER WARRANTY IS EXPRESSED OR IMPLIED. HEWLETT-PACKARD SPECIFICALLY DISCLAIMS THE IMPLIED WARRANTIES OF MERCHANTABILITY AND FITNESS FOR A PARTICULAR PURPOSE.

EXCLUSIVE REMEDIES

THE REMEDIES PROVIDED HEREIN ARE BUYER'S SOLE AND EXCLUSIVE REMEDIES. HEWLETT-PACKARD SHALL NOT BE LIABLE FOR ANY DIRECT, INDIRECT, SPECIAL, INCIDENTAL, OR CONSEQUENTIAL DAMAGES, WHETHER BASED ON CONTRACT, TORT, OR ANY OTHER LEGAL THEORY.

Assistance

Product maintenance agreements and other customer assistance agreements are available for Hewlett-Packard products.

For any assistance, contact your nearest Hewlett-Packard Sales and Service Office.

Contents

1. General Information	
Introduction	1
Specifications	1
Description	2
Initial Inspection	3
2. Operation	
Description	5
Mating Connectors	5
Operating Environment	5
Storage and Shipment	5
3. Operation Verification	
Insertion Loss and Frequency Response	6
Description	6
Equipment	6
Procedure	6
Limiting	8
Description	8
Equipment	8
Procedure	8
4. Service	
Disassembly	9
Replacement Parts	9

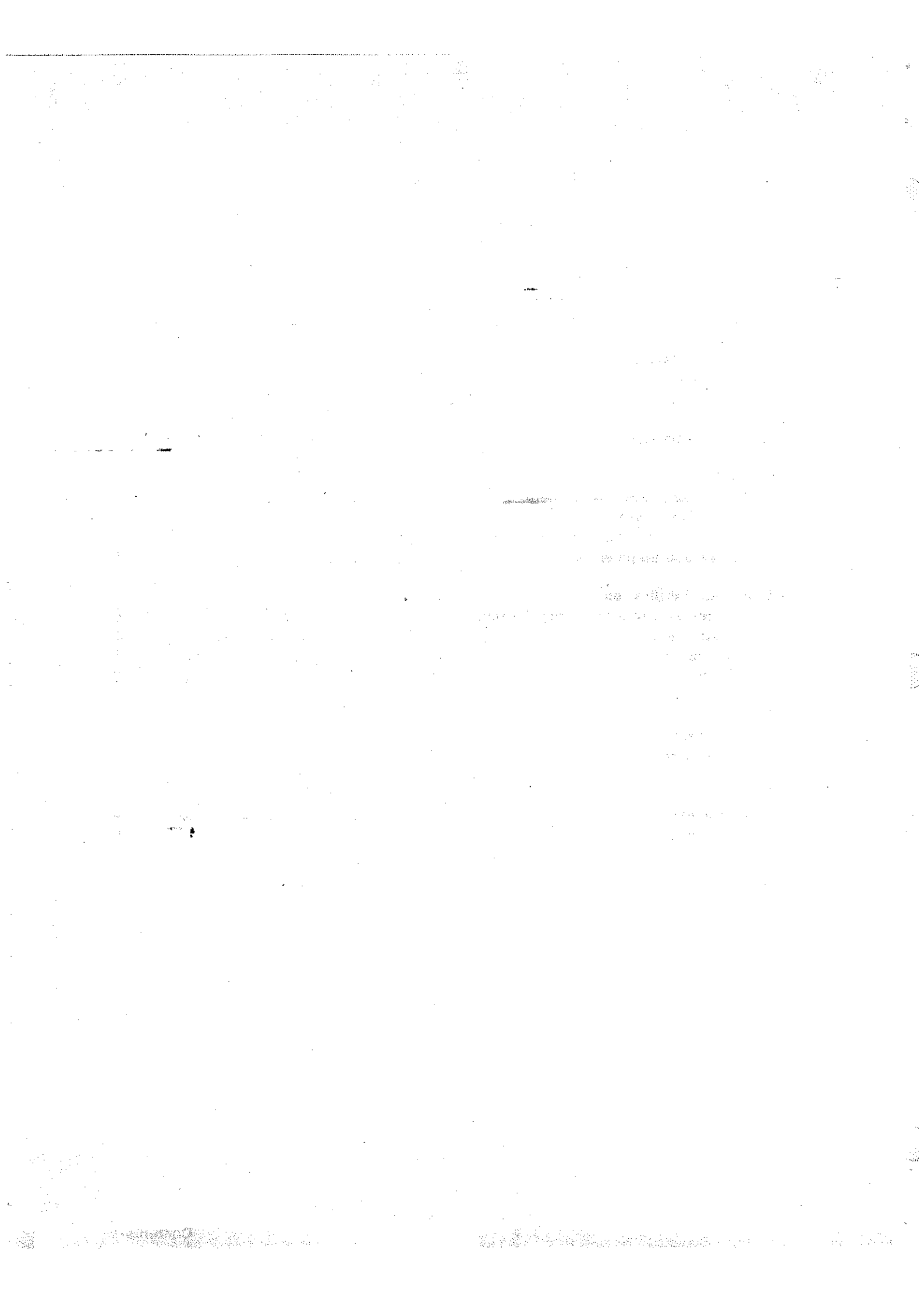

HP 11947A Operation and Service Manual

1. General Information

Introduction

The Hewlett-Packard Model 11947A Transient Limiter is an instrument accessory that protects input circuitry from transients and accidental overloads. This operation and service manual explains how to use the limiter, briefly describes tests that can be used to verify its specifications, and suggests the actions to take should the limiter need repair.

Specifications

Specifications and characteristics are listed in Table 1-1. These are performance standards or limits against which the instrument may be tested.

Table 1-1. Specifications and Characteristics

SPECIFICATIONS:	
Frequency Range	9 kHz to 200 MHz
Insertion Loss	
> 30 dB	below 2 KHz
10 dB \pm 0.5 dB	9 kHz to 50 MHz
10 dB +2.2 dB—0.5 dB	50 MHz to 200 MHz
Calibration Accuracy	\pm 0.2 dB at 25 °C
Maximum Input Level	
Continuous	2.5 W average (+34 dBm)
Pulse	10 kW for 10 μ s
DC Voltage	\pm 12 V
Connectors	
Input	BNC (female)
Output	Type N (male)

Table 1-1. Specifications and Characteristics (continued)

CHARACTERISTICS:	
Insertion Loss	13 dB
Impedance	50Ω
Reflection Coefficient	
Input	
<0.13 (1.3 SWR)	9 kHz to 50 MHz
<0.26 (1.7 SWR)	50 MHz to 200 MHz
Output	
<0.09 (1.2 SWR)	9 kHz to 50 MHz
<0.29(1.8 SWR)	50 MHz to 200 MHz
Limiting Threshold	50 mW (+17 dBm)
Overall Length	138 mm (5.4 inches)

Description

The HP 11947A Transient Limiter is a unidirectional, solid-state, passive device for use from 9 kHz to 200 MHz. It consists of a diode limiter, a 10 dB attenuator, and a high-pass filter integrated into a 50Ω transmission line. The transient limiter has no adjustments.

The SWR characteristics in Table 1-1 apply below the limiting threshold. SWR above the threshold is unpredictable, since the HP 11947A effects its limiting by reflecting some of the input power.

Limiting is nonlinear and depends on input power and ambient temperature. The typical limiting curves shown in Figure 1-1 apply at an ambient temperature of 25°C.

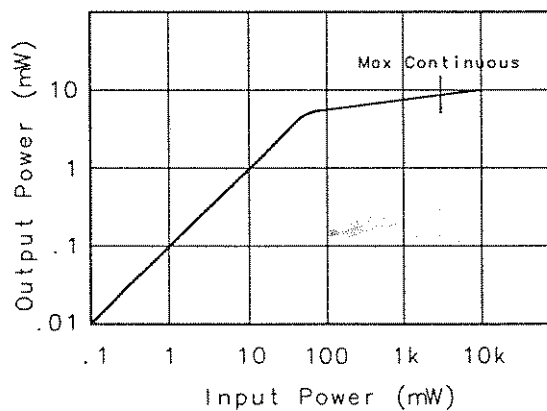

IH31-3L

Figure 1-1. Typical Limiting Characteristics

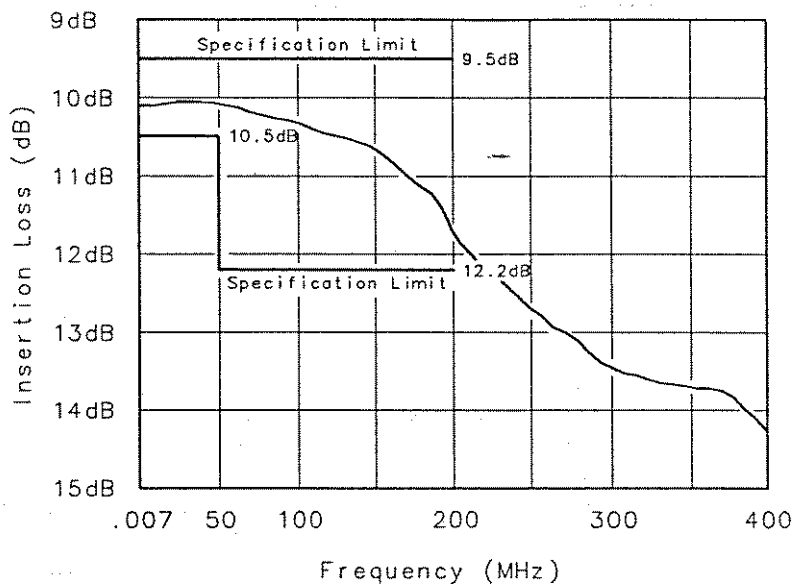

IH31-2L

Figure 1-2. Typical Insertion Loss Versus Frequency

Initial Inspection

Inspect the shipping container for damage. If the container or cushioning material is damaged, it should be kept until the contents of the shipment have been checked for completeness, and the HP 11947A has been checked mechanically and electrically. Procedures for checking electrical performance are given in Chapter 3, "Operation Verification."

If the contents are incomplete, if there is mechanical damage or defect, or if the instrument does not pass operation verification tests, notify the nearest Hewlett-Packard office (listed in Table 1-2). If the shipping container is damaged, or the cushioning material shows signs of stress, notify the carrier as well as the HP office. Keep the shipping materials for inspection by the carrier. The HP office will arrange for the repair or replacement of the instrument without waiting for claim settlement.

Table 1-2. Hewlett-Packard Sales and Service Offices

US FIELD OPERATIONS HEADQUARTERS	EUROPEAN OPERATION HEADQUARTERS	INTERCON OPERATIONS HEADQUARTERS
Hewlett-Packard Company 19320 Pruneridge Avenue Cupertino, CA 95014, USA (408) 973-1919	Hewlett-Packard S.A. 150, Route du Nant-d'Avril 1217 Meyrin 2/Geneva Switzerland (41 22) 780.8111	Hewlett-Packard Company 3495 Deer Creek Rd. Palo Alto, California 94304-1316 (415) 857-5027
California Hewlett-Packard Co. 1421 South Manhattan Ave. Fullerton, CA 92631 (714) 999-6700	France Hewlett-Packard France 1 Avenue Du Canada Zone D'Activite De Courtaboeuf F-91947 Les Ulis Cedex France (33 1) 69 82 60 60	Australia Hewlett-Packard Australia Ltd. 31-41 Joseph Street Blackburn, Victoria 3130 (61 3) 895-2895
Hewlett-Packard Co. 301 E. Evelyn Mountain View, CA 94041 (415) 694-2000	Germany Hewlett-Packard GmbH Berner Strasse 117 6000 Frankfurt 56 West Germany (49 69) 500006-0	Canada Hewlett-Packard (Canada) Ltd. 17500 South Service Road Trans-Canada Highway Kirkland, Quebec H9J 2X8 Canada (514) 697-4232
Colorado Hewlett-Packard Co. 24 Inverness Place, East Englewood, CO 80112 (303) 649-5000	Great Britain Hewlett-Packard Ltd. Eskdale Road, Winnersh Triangle Wokingham, Berkshire RG11 5DZ England (44 734) 696622	Japan Yokogawa-Hewlett-Packard Ltd. 1-27-15 Yabe, Sagamihara Kanagawa 229, Japan (81 427) 59-1311
Georgia Hewlett-Packard Co. 2000 South Park Place Atlanta, GA 30339 (404) 955-1500		People's Republic of China China Hewlett-Packard, Ltd. 38 Bei San Huan X1 Road Shuang Yu Shu Hai Dian District Beijing, China (86 1) 256-6888
Illinois Hewlett-Packard Co. 5201 Tollview Drive Rolling Meadows, IL 60008 (708) 255-9800		Singapore Hewlett-Packard Singapore Pte. Ltd. 1150 Depot Road Singapore 0410 (65) 273 7388
New Jersey Hewlett-Packard Co. 120 W. Century Road Paramus, NJ 07653 (201) 599-5000		Taiwan Hewlett-Packard Taiwan 8th Floor, H-P Building 337 Fu Hsing North Road Taipei, Taiwan (886 2) 712-0404
Texas Hewlett-Packard Co. 930 E. Campbell Rd. Richardson, TX 75081 (214) 231-6101		

2. Operation

Description

For reliable operation over its full frequency and power range, the limiter must be used as a unidirectional device. Incident power must be applied as shown on the label of the limiter. The limiter protects the input mixer and attenuator of a spectrum analyzer subjected to transients from Line Impedance Stabilization Networks during conducted EMI measurements.

Although harmonic distortion is generated by the HP 11947A while it is limiting, the limiter still will prevent transients from damaging the device it is protecting.

Caution



Do not apply more than 2.5 W average power or 10 kW pulse power to the limiter. Apply $<\pm 12$ Vdc. Exceeding these levels could result in permanent damage to the limiter.

Mating Connectors

Mating connectors used with the limiter should be Type N female at the output and BNC male at the input.

Caution



Do not reverse the polarity of the limiter. Doing so can destroy the limiter.

Operating Environment

The HP 11947A should be operated only within the following temperature range: 0°C to 55°C

Storage and Shipment

The HP 11947A may be stored or shipped in environments within the following temperature range: -40°C to +75°C

Containers and materials identical to those used in factory packaging are available through Hewlett-Packard offices. If the instrument is being returned to Hewlett-Packard for servicing, attach a tag indicating the type of service required, the model number and full serial number of the instrument, and your complete return address. Also, mark the container FRAGILE, to assure careful handling. In any correspondence, refer to the instrument by model number and full serial number.

3. Operation Verification

Insertion Loss and Frequency Response

Description

The following procedure will check insertion loss at the frequencies where calibration factors have been provided. A comprehensive test makes a swept measurement using, for example, an HP 3577A.

Equipment

Spectrum Analyzer	HP 8566A/B, HP 8558A/B
Synthesized Sweeper	HP 8340A
Frequency Synthesizer	HP 3335A
Adapter, Type N (m) to BNC (f)	1250-1250

Procedure

1. Connect the HP 3335A 50 Ω output to the spectrum analyzer input, using a BNC cable and the Type N-to-BNC adapter.
2. Cycle power on the HP 3335A; this resets the instrument.
3. On the HP 3335A, press **AMPLITUDE** 20 **-dBm**.
4. Set the spectrum analyzer controls as follows:

INSTR PRESET
START FREQ 5 **kHz**
STOP FREQ 110 **kHz**
VIDEO BW 1 **kHz**

5. Set the HP 3335A frequency:
FREQUENCY 9 **kHz**
6. On the spectrum analyzer, press **SINGLE** sweep and after completion of sweep, **PEAK SEARCH**. Record marker amplitude in column 2 of Table 3-1.
7. Repeat steps 5 and 6 for HP 3335A frequencies of 10 kHz, 30 kHz, and 100 kHz.
8. Set the spectrum analyzer controls as follows:
START FREQ 500 **kHz**
STOP FREQ 31 **MHz**
9. Repeat steps 5 and 6 for HP 3335A frequencies of 1 MHz, 10 MHz, and 30 MHz.
10. Replace the adapter on the spectrum analyzer input with the HP 11947A Transient Limiter.
11. Repeat steps 4 through 9, recording the marker amplitude in column 3 of Table 3-1.
12. Remove the HP 11947A Transient Limiter.
13. Connect a cable from the HP 8340A RF output to the spectrum analyzer input using the Type N-to-BNC adapter and other adapters as required.

14. Set the spectrum analyzer controls as follows:

START FREQ 50 MHz
STOP FREQ 210 MHz

15. Set the HP 8340A controls as follows:

INSTR PRESET
POWER LEVEL -10 dBm

16. Set the HP 8340A frequency:

CW 100 MHz

17. On the spectrum analyzer, press SINGLE sweep and after completion of sweep, PEAK SEARCH. Record marker amplitude in column 2 of Table 3-1.

18. Repeat steps 16 and 17 for HP 8340A CW frequencies of 150 MHz and 200 MHz.

19. Replace the adapter on the spectrum analyzer input with the HP 11947A Transient Limiter.

20. Repeat steps 16, 17 and 18 and record the marker amplitude in column 3 of Table 3-1.

21. Subtract the readings in column 3 from those in column 2, and record the difference in column 4 of Table 3-1.

22. Compare the results in column 4 with the limits in column 5 of Table 3-1.

Table 3-1. Insertion Loss/Frequency Response

Column 1 Frequency	Column 2 Input Level (dBm)	Column 3 Output Level (dBm)	Column 4 Insertion Loss (dB)	Column 5 Limits (dB)
9 kHz	_____	_____	_____	9.5 to 10.5
10 kHz	_____	_____	_____	9.5 to 10.5
30 kHz	_____	_____	_____	9.5 to 10.5
100 kHz	_____	_____	_____	9.5 to 10.5
1 MHz	_____	_____	_____	9.5 to 10.5
10 MHz	_____	_____	_____	9.5 to 10.5
30 MHz	_____	_____	_____	9.5 to 10.5
100 MHz	_____	_____	_____	9.5 to 12.2
150 MHz	_____	_____	_____	9.5 to 12.2
200 MHz	_____	_____	_____	9.5 to 12.2

Limiting

Description

To check the typical limiting threshold requires a high power source (greater than +17 dBm). However, the limiting action can be verified by testing the HP 11947A Transient Limiter in reverse, bypassing the input attenuation.

Equipment

Synthesizer/Function Generator HP 3325A
Digital Voltmeter HP 3456A

Procedure

1. Cycle power on the HP 3325A to reset it.
2. Connect the HP 11947A Transient Limiter output to the HP 3325A output using the Type N-to-BNC adapter.
3. Connect the HP 11947A transient Limiter input to the HP 3456A volts input using a BNC cable and a BNC-to-banana plug adapter.
4. Set the HP 3325A controls as follows:

<input type="text" value="FREQ"/>	10	<input type="text" value="kHz"/>	<input type="text" value="~"/>
<input type="text" value="AMPTD"/>	10	<input type="text" value="VOLT"/>	
5. Press on the HP 3456A and select .
6. If the HP 3456A reads less than 0.52 V, the limiting action is working. If the HP 3456A reads more than 0.60 V, at least one limiting diode is open and the limiting action is impaired.
7. If the HP 3456A reads between 0.52 V and 0.60 V, additional testing is required to determine if the limiting action is working. Complete steps 8 through 16.
8. Remove the HP 11947A plastic housing. Carefully pry the halves of the housing apart by inserting a flat-blade screwdriver between the Type N connector and the housing.
9. Remove the two screws holding the shielding can, and remove the shielding can. The circuit board now is exposed.
10. Connect the HP 3325A to the end of R6 closest to CR2. (See Figure 4-1.)
11. Set the HP 3325A controls as follows:

<input type="text" value="FREQ"/>	10	<input type="text" value="kHz"/>	<input type="text" value="~"/>
<input type="text" value="AMPTD"/>	10	<input type="text" value="VOLT"/>	
12. Select on the HP 3456A, and connect it to the same end of R6. The voltage should be less than 1.1 V ac if CR1 or CR2 are not open.
13. Connect the HP 3456A to the wire to J2 (output connector). Subtract the voltage at J2 from the reading in step 12. The difference should be less than 0.3 V ac if CR3 or CR4 are not shorted.
14. Connect the HP 3325A and HP3456A to J2. The voltage at J2 should be less than 1.2 V ac or if CR3 or CR4 are not open.

15. Connect the HP 3456A to the end of R6 closest to CR2. Subtract the voltage at R6 from the reading in step 14. The difference should be less than 0.4 V ac if CR1 and CR2 are not shorted.
16. If the conditions in steps 12 through 15 are met, the limiting action is working.

4. Service

A component locations diagram (Figure 4-1), a schematic (Figure 4-2), and a list of replaceable parts (Table 4-1) are provided in this section.

It is recommended that defective HP 11947A Transient Limiters be returned to Hewlett-Packard for repair, so comprehensive testing can be performed. Follow the procedures listed in Storage and shipment in Chapter 2.

Disassembly

The plastic housing halves can be carefully pried apart, using a small flat-blade screwdriver between the Type N connector and the housing. The screws securing the shielding can are then visible and can be removed. After removal of the can, the HP 11947A Transient Limiter circuit board is accessible for repair.

Replacement Parts

To order a part listed in Table 4-1, specify the Hewlett-Packard part number and check digit, indicate the quantity desired, and address the order to the nearest Hewlett-Packard office. The check digit expedites processing of the order. A list of Hewlett-Packard Sales and Service Offices is provided at the end of Chapter 1 of this manual.

Table 4-1. 11947A Replaceable Parts

Reference Designation	HP Part Number	CD	QTY	Description
	11947-80001	2	1	LABEL, 11947A (4 PARTS)
MP1	11947-60001	0	1	BOARD ASSY, LIMITER
MP2	85025-40001	8	2	HALF BODY
MP3	0515-0221	0	4	CAP, M2.0 × 6.0 HEX
MP4	85025-20007	2	1	CAN, RECT, 21 × 32 MM
MP5	11947-20004	9	1	FRAME
MP6	11947-20002	7	1	NUT, ADAPTER (J2)
MP7	3050-1266	2	1	WASHER, FL 0.385 ID (J2)
MP8	11947-20003	8	1	SPACER, BNC (J1)
MP11	0515-1773	9	2	SCREW, 2.5 MM
J1	1250-0083	9	1	RF CONNECTOR, BNC (FEMALE)
J2	1250-2183	6	1	RF CONNECTOR, TYPE N (MALE)
C1	0160-5444	6	2	CAPACITOR, CER 0.47 μ 200V
C2	0160-5444	6		CAPACITOR, CER 0.47 μ 200V
CR1	5082-1001	2	2	DIODE, HIGH G
CR2	5082-1001	2		DIODE, HIGH G
CR3	1901-0050	3	2	DIODE, SW 80V 0.2A
CR4	1901-0050	3		DIODE, SW 80V 0.2A
L1	11947-80002	3	1	INDUCTOR, 1 mH 25%
R1	0698-3607	8	1	RESISTOR, 18 OHM 5% 2W
R2	0757-1092	7	2	RESISTOR, 287 OHM 1% 0.5W
R3	0757-1092	7		RESISTOR, 287 OHM, 1% 0.5W
R4	0757-1001	8	2	RESISTOR, 56.2 OHM 1% 0.5W
R5	0757-1060	9	1	RESISTOR, 196 OHM 1% 0.5W
R6	0757-1001	8		RESISTOR, 56.2 OHM 1% 0.5W
R7	0757-0379	1	1	RESISTOR, 12.1 OHM 1% 0.12W
R8	0757-0403	2	1	RESISTOR, 121 OHM 1% 0.12W
R9	0698-3447	4	1	RESISTOR, 422 OHM 1% 0.12W
V1	1970-0073	5	1	SURGE PROTECTOR 90V

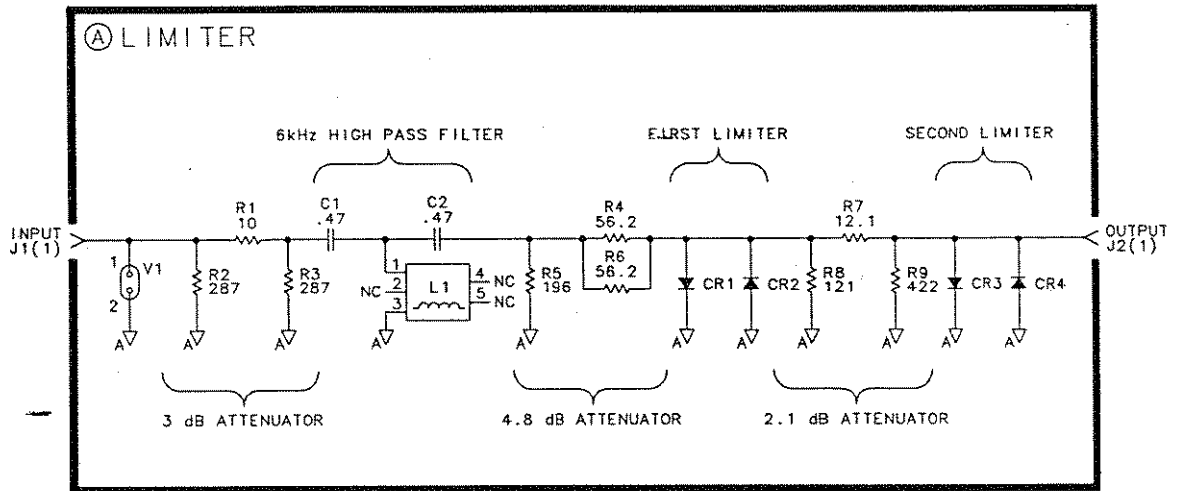

IH34_2S

Figure 4-1 HP 11947A Transient Limiter Board Assembly Schematic Diagram

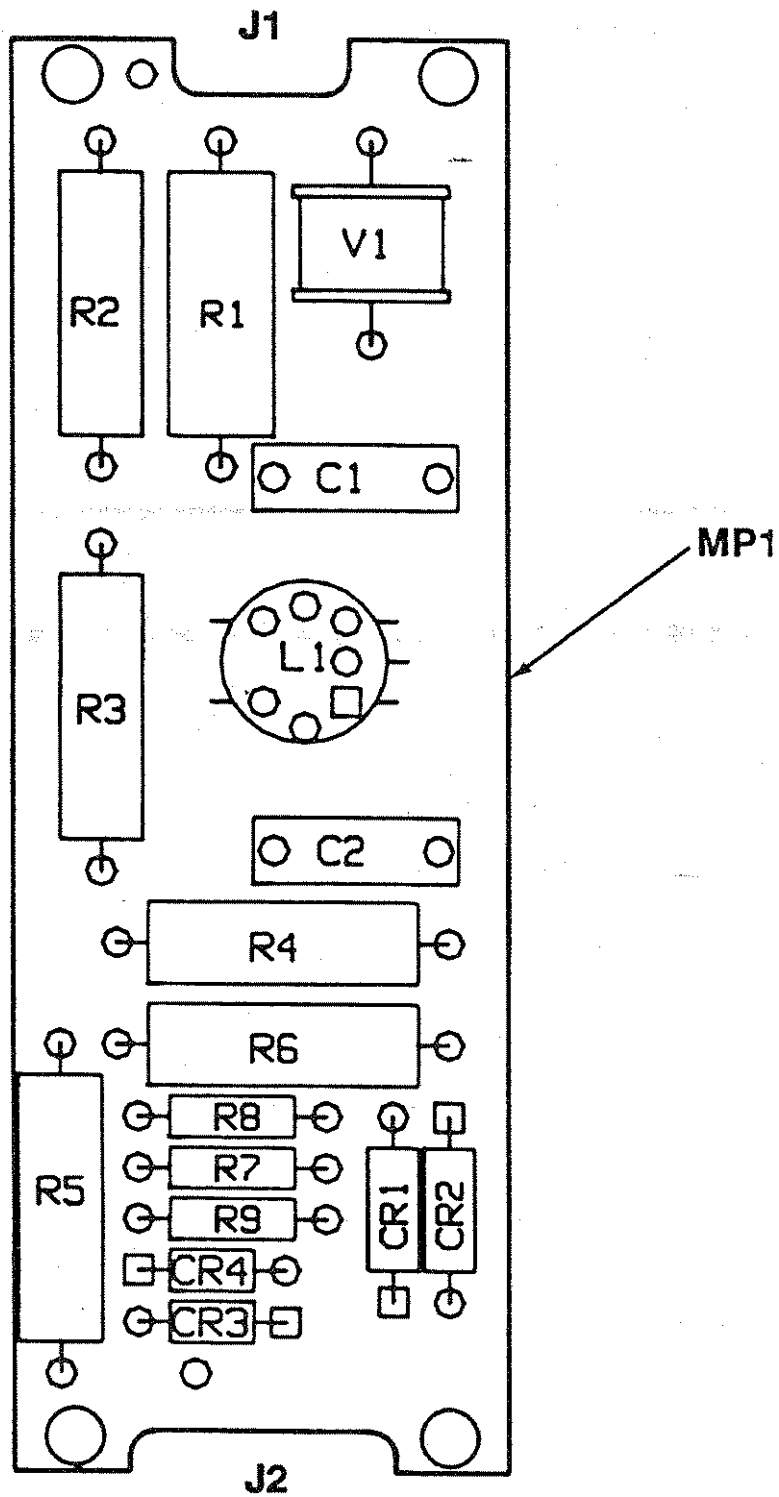
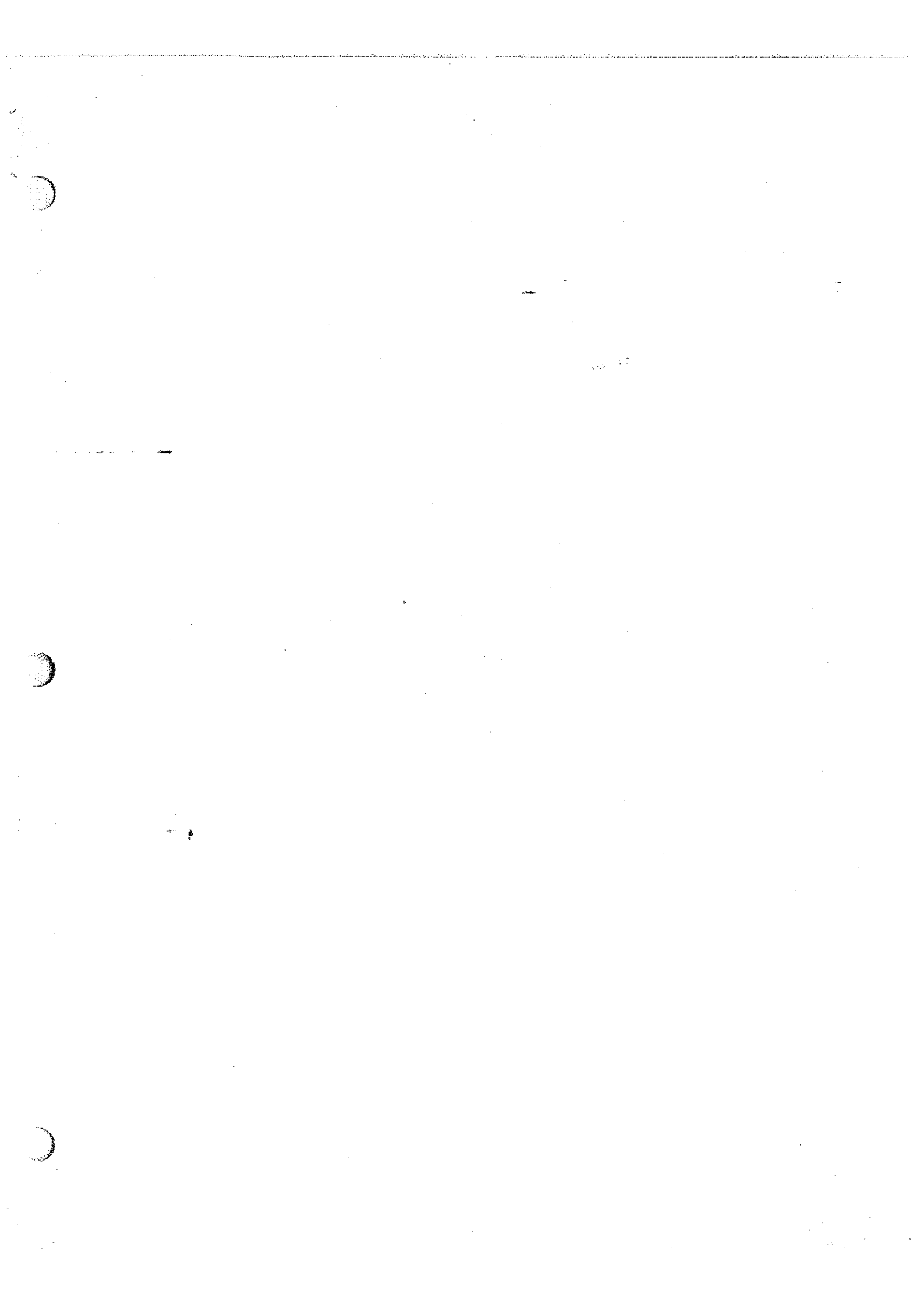

Figure 4-2. HP 11947A Transient Limiter Components Locations





**HEWLETT
PACKARD**

**HP Part No. 11947-90006
Printed in USA**

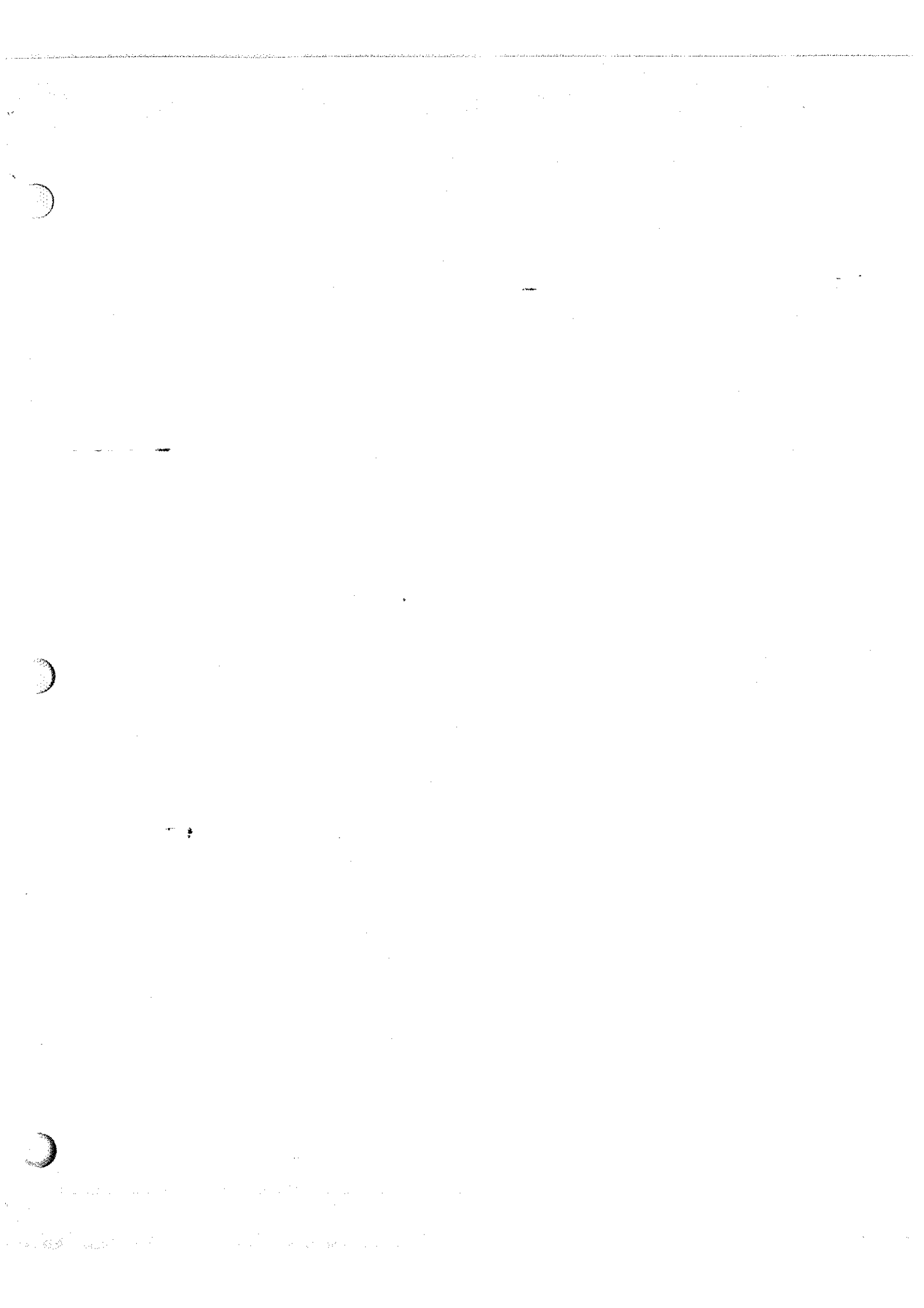

** For HP Internal Reference Only **

Customer Order Number

Manufacturing Part Number

11947-90006



Printed in USA