



OPERATING AND SERVICE MANUAL

MODEL 1340A X-Y DISPLAY

(Including Options 001, 002, 004, 039, 110, 216,
300, 301, 302, 303, 304, 315, 316, 317, 324, 330,
331, 561, 604, 607, 631, and 639.)

SERIAL NUMBERS

This manual applies directly to instruments with serial numbers prefixed 1748A.

For additional important information about serial numbers, see INSTRUMENTS COVERED BY MANUAL in SECTION I.

©COPYRIGHT HEWLETT-PACKARD COMPANY/COLORADO SPRINGS DIVISION 1977
1900 GARDEN OF THE GODS ROAD, COLORADO SPRINGS, COLORADO, U.S.A.

ALL RIGHTS RESERVED

Manual Part Number 01340-90901
Microfiche Part Number 01340-90801
Operating Note Part No. 01340-90902

PRINTED: DECEMBER 1977

SAFETY

This product has been designed and tested according to International Safety Requirements. To ensure safe operation and to keep the product safe, the information, cautions, and warnings in this manual must be heeded. Refer to Section I and the Safety Summary for general safety considerations applicable to this product.

CERTIFICATION

Hewlett-Packard Company certifies that this product met its published specifications at the time of shipment from the factory. Hewlett-Packard further certifies that its calibration measurements are traceable to the United States National Bureau of Standards, to the extent allowed by the Bureau's calibration facility, and to the calibration facilities of other International Standards Organization members.

WARRANTY

This Hewlett-Packard product is warranted against defects in material and workmanship for a period of one year from date of shipment. During the warranty period, Hewlett-Packard Company will, at its option, either repair or replace products which prove to be defective.

The cathode-ray tube (CRT) in the instrument and any replacement CRT purchased from HP are also warranted against electrical failure for a period of one year from the date of shipment from Colorado Springs. **BROKEN TUBES AND TUBES WITH PHOSPHOR OR MESH BURNS, HOWEVER, ARE NOT INCLUDED UNDER THIS WARRANTY.**

For warranty service or repair, this product must be returned to a service facility designated by HP. However, warranty service for products installed by HP and certain other products designated by HP will be performed at Buyer's facility at no charge within the HP service travel area. Outside HP service travel areas, warranty service will be performed at Buyer's facility only upon HP's prior agreement and Buyer shall pay HP's round trip travel expenses.

For products returned to HP for warranty service, Buyer shall prepay shipping charges to HP and HP shall pay shipping charges to return the product to Buyer. However, Buyer shall pay all shipping charges, duties, and taxes for products returned to HP from another country.

LIMITATION OF WARRANTY

The foregoing warranty shall not apply to defects resulting from improper or inadequate maintenance by Buyer, Buyer-supplied software or interfacing, unauthorized modification or misuse, operation outside of the environmental specifications for the product, or improper site preparation or maintenance.

NO OTHER WARRANTY IS EXPRESSED OR IMPLIED. HP SPECIFICALLY DISCLAIMS THE IMPLIED WARRANTIES OF MERCHANTABILITY AND FITNESS FOR A PARTICULAR PURPOSE.

EXCLUSIVE REMEDIES

THE REMEDIES PROVIDED HEREIN ARE BUYER'S SOLE AND EXCLUSIVE REMEDIES. HP SHALL NOT BE LIABLE FOR ANY DIRECT, INDIRECT, SPECIAL, INCIDENTAL, OR CONSEQUENTIAL DAMAGES, WHETHER BASED ON CONTRACT, TORT, OR ANY OTHER LEGAL THEORY.

ASSISTANCE

Product maintenance agreements and other customer assistance agreements are available for Hewlett-Packard products.

For any assistance, contact your nearest Hewlett-Packard Sales and Service Office. Addresses are provided at the back of this manual.

SAFETY SUMMARY

The following general safety precautions must be observed during all phases of operation, service, and repair of this instrument. Failure to comply with these precautions or with specific warnings elsewhere in this manual violates safety standards of design, manufacture, and intended use of the instrument. Hewlett-Packard Company assumes no liability for the customer's failure to comply with these requirements.

GROUND THE INSTRUMENT.

To minimize shock hazard, the instrument chassis and cabinet must be connected to an electrical ground. The instrument is equipped with a three-conductor ac power cable. The power cable must either be plugged into an approved three-contact electrical outlet or used with a three-contact to two-contact adapter with the grounding wire (green) firmly connected to an electrical ground (safety ground) at the power outlet. The power jack and mating plug of the power cable meet International Electrotechnical Commission (IEC) safety standards.

DO NOT OPERATE IN AN EXPLOSIVE ATMOSPHERE.

Do not operate the instrument in the presence of flammable gases or fumes. Operation of any electrical instrument in such an environment constitutes a definite safety hazard.

KEEP AWAY FROM LIVE CIRCUITS.

Operating personnel must not remove instrument covers. Component replacement and internal adjustments must be made by qualified maintenance personnel. Do not replace components with power cable connected. Under certain conditions, dangerous voltages may exist even with the power cable removed. To avoid injuries, always disconnect power and discharge circuits before touching them.

DO NOT SERVICE OR ADJUST ALONE.

Do not attempt internal service or adjustment unless another person, capable of rendering first aid and resuscitation, is present.

USE CAUTION WHEN EXPOSING OR HANDLING THE CRT.

Breakage of the Cathode-ray Tube (CRT) causes a high-velocity scattering of glass fragments (implosion). To prevent CRT implosion, avoid rough handling or jarring of the instrument. Handling of the CRT shall be done only by qualified maintenance personnel using approved safety mask and gloves.

DO NOT SUBSTITUTE PARTS OR MODIFY INSTRUMENT.

Because of the danger of introducing additional hazards, do not install substitute parts or perform any unauthorized modification of the instrument. Return the instrument to a Hewlett-Packard Sales and Service Office for service and repair to ensure that safety features are maintained.

DANGEROUS PROCEDURE WARNINGS.

Warnings, such as the example below, precede potentially dangerous procedures throughout this manual. Instructions contained in the warnings must be followed.

WARNING

**Dangerous voltages, capable of causing death, are present in this instrument.
Use extreme caution when handling, testing, and adjusting.**

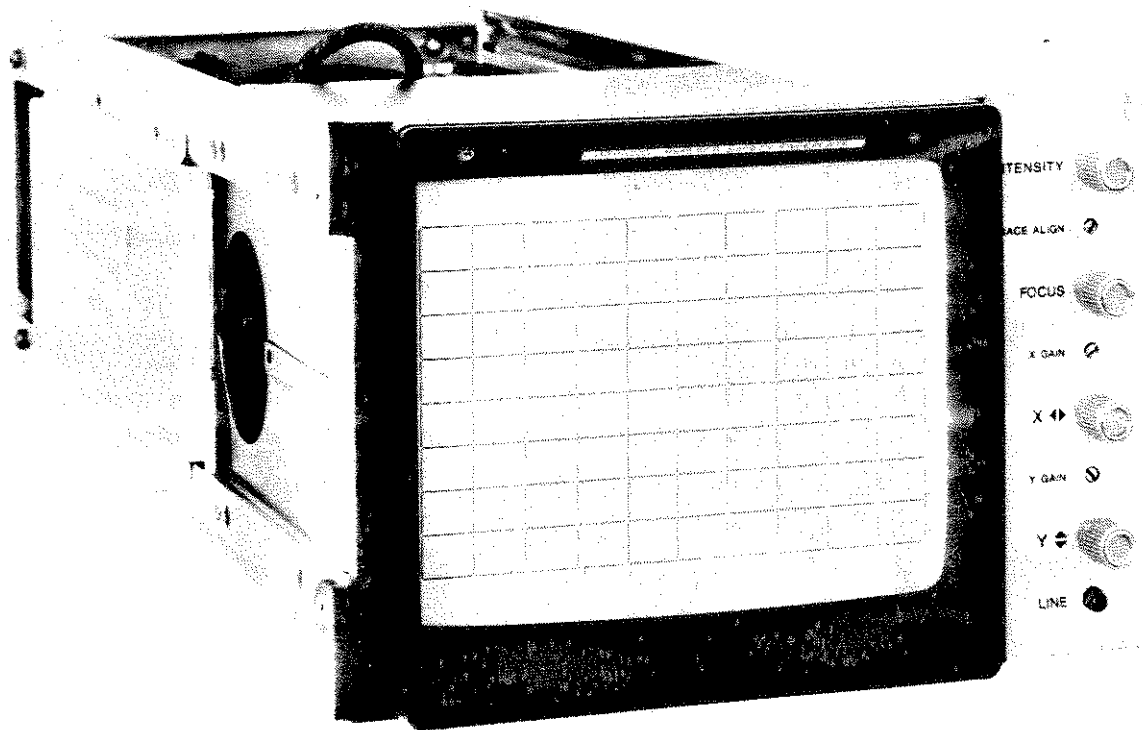

Figure 1-1. Model 1340A X-Y Display

SECTION I

GENERAL INFORMATION

1-1. INTRODUCTION.

1-1. This manual contains information required to install, operate, test, adjust, and service the Hewlett-Packard Model 1340A.

1-3. Supplied with this manual is an Operating Note that should be kept with the instrument for use by the operator. The part number is listed on the title page.

1-4. Also listed on the title page of this manual is a Microfiche part number. This number can be used to order 4- x 6-inch microfilm transparencies of the manual. Each microfiche contains up to 96 photo-duplicates of the manual pages. The microfiche package also includes the latest Manual Changes supplement.

1-5. SPECIFICATIONS.

1-6. Instrument specifications are listed in table 1-1. These specifications are the performance standards or limits against which the instrument is tested. Table 1-2 lists supplemental characteristics. Supplemental characteristics are *not* specifications but are typical characteristics included as additional information for the user.

1-7. DESCRIPTION.

1-8. The Hewlett-Packard Model 1340A is an X-Y display recommended for OEM system use in electronic test equipment, chemical or physical analytical systems, medical electronic equipment or any application where a high-quality image is required. The display uses a post-accelerator CRT with 6.6 kV accelerating potential and aluminized P31 phosphor.

1-9. OPTIONS.

1-10. Standard options are modifications installed on HP instruments and are available on request. Table 1-3 lists available options for the 1340A.

1-11. ACCESSORIES SUPPLIED.

1-12. The following accessories are supplied with the 1340A:

- One blue contrast filter
- One ac line cord

Table 1-1. Specifications

VERTICAL AND HORIZONTAL AMPLIFIERS RESPONSE

Rise Time: ≤ 120 ns (10% to 90% points) for full-screen deflection or less.

Phase Shift: $< 3^\circ$ to 1 MHz for full-screen input signals.

DEFLECTION CHARACTERISTICS: front panel adjustable from 800 mV to 2 volts for 4.7 in. deflection of X or Y amplifiers.

LINEAR WRITING SPEED: ≥ 25 cm/ μ s (9.8 in./ μ s).

SETTLING TIME: signal settles to within one spot diameter of final value in ≤ 300 ns for any on-screen final location. Off-screen deflection (if any) must not exceed specified dynamic range.

REPEATABILITY: ≤ 0.4 mm (0.015 in.) error (full-screen) for re-addressing a point from any on- or off-screen location within specific dynamic range.

LINEARITY: 5% of full scale along major axes.

MAXIMUM INPUT: ± 40 V (dc + peak ac) for high impedance input termination; ± 3.5 V (dc + peak ac) for 50 Ω input termination.

DYNAMIC RANGE: beam may be deflected offscreen up to 1/2 screen diameter in any direction provided

that the zero input position is onscreen without degradation of specifications.

CROSSTALK: < 0.25 mm (0.01 in.) with one input terminated in 50 Ω and the other axis excited by a 1-V, 500 kHz signal; < 0.5 mm (0.02 in.) at 3 MHz when driven from a terminated 50 Ω source.

Z-AXIS AMPLIFIER

RISE TIME: < 70 ns.

ANALOG BLANKING RANGE: a 1 V change in Z-input voltage causes a full scale change in brightness.

MAXIMUM INPUT: ± 40 V (dc + peak ac) for high impedance input termination; ± 3.5 V (dc + peak ac) for 50 Ω input termination.

CATHODE-RAY TUBE

VIEWING AREA: 114 cm² (17.73 in.²); 9.6 cm (3.78 in.) vertically by 11.9 cm (4.69 in.) horizontally.

SPOT SIZE: < 0.46 mm (0.018 in.) at center of screen at normal viewing brightness; measured using shrinking raster method.

Table 1-1. Specifications (Cont'd)

SAFETY PROTECTION

When ordered with Option 315 the instrument is listed by Underwriters Laboratories for use in Electronic Data Processing Equipment (UL 478). When ordered with Option 330, Model 1340A is listed by UL as a component for use in Medical and Dental Electronic Equipment (UL 544).

WARNING

These displays are designed and manufactured primarily for OEM system applications. Therefore, without Option 315 or Option 330, the top and bottom protective covers are not provided and internal wiring connections of **HAZARDOUS VOLTAGES ARE EXPOSED**. Operator protection must be provided by the purchaser

and/or user of the instrument. If in doubt, order either Option 315 or Option 330 which provides the covers.

GENERAL**OPERATING ENVIRONMENT**

Temperature: 0°C to +55°C; nonoperating, -40°C to +70°C.

Humidity: to 95% relative humidity at +40°C.

Altitude: to 4600 m (15 000 ft); nonoperating, 15 300 m (50 000 ft).

Vibration: vibrated in three planes for 15 minutes each with 0.38 mm (0.015 in.) excursion, 5 Hz to 55 Hz. 1 minute per octave, 10 minutes each resonance.

Shock: 30 g level shock, 11 ms duration and 1/2 sine wave shape.

Table 1-2. General Information

VERTICAL AND HORIZONTAL AMPLIFIERS

INPUTS: BNC connectors with shield grounded.

Input RC: approx 1 M Ω shunted by ≤ 50 pF. 50 Ω (nominal) input termination selectable internally.

Bandwidth: dc to > 3 MHz (3 dB down) for 5 cm or less deflection.

Input Deflection: Independently switch-selectable 5:1 attenuators extend range from approximately 4 V to 10 V for full-screen deflection of X or Y amplifiers.

Polarity: a positive input signal moves beam up or to the right. Negative polarity selectable by internal switches.

POSITION: front-panel controls allow undeflected spot to be set off screen from any where within the viewing area. Spot position, with both inputs grounded and position controls electrically centered, is approximately at the geometric center of the viewing area.

DRIFT

Position: typically < 0.5 mm/hr (0.02 in./hr) and typically < 1 mm (0.04 in.) in 24 hours (with covers installed and after a 15-minute warmup period).

Gain: typically < 1% under all conditions of specified line voltage with covers installed, with a temperature range between +20°C and +55°C (+68°F and +131°F), and after a 15-minute warmup period.

Z-AXIS AMPLIFIER

ANALOG BLANKING: cutoff level can be set from +0.2 Vdc to -1 Vdc with intensity control. Brightness is limited to a safe level for any Z-axis input voltage with intensity control set fully counterclockwise.

BLANKING POLARITY: positive going input signal, applied to the Z-axis input, increases brightness. Negative polarity is selectable internally.

INPUT: BNC connector with shield grounded.

Input RC: approx 1 M Ω shunted by ≤ 40 pF. 50 Ω (nominal) input termination selectable internally.

GAIN: internally adjustable over 2:1 attenuation range.

CATHODE-RAY TUBE

TYPE: post deflection accelerator, approximately 6.6 kV accelerating potential. Aluminized P31 phosphor, electrostatic focus and deflection.

GRATICULE: internal graticule, 8 x 10 divisions, 1 div = ≈ 1.2 cm (Refer to table 1-3 for CRT's without graticules).

RESOLUTION: Line resolution at center screen is approximately 25 lines/cm at the specified line brightness.

SAFETY PROTECTION

X-RAY EMISSION: < 0.5 mr/hr measured with Victoreen Model 440 RF/C.

GENERAL**FRONT PANEL CONTROLS**

Knob Adjustments: Intensity, Focus, Position \blacktriangleleft (X), Position \blacktriangleright (Y).

Screw-driver Adjustments: Trace Align, X Gain, Y Gain.

LINE POWER: Selectable 100, 120, 220, or 240 Vac, +5% to -10%, 48 Hz to 66 Hz (see note); average power dissipation at 60 Hz and 120 Vac is approximately 35 watts.

NOTE

Unit meets all electrical specifications from 48 - 440 Hz, but does not meet line leakage requirements for medical and dental listings at line frequencies above 66 Hz.

DIMENSIONS: see outline drawing.

Table 1-2. General Information (Cont'd)

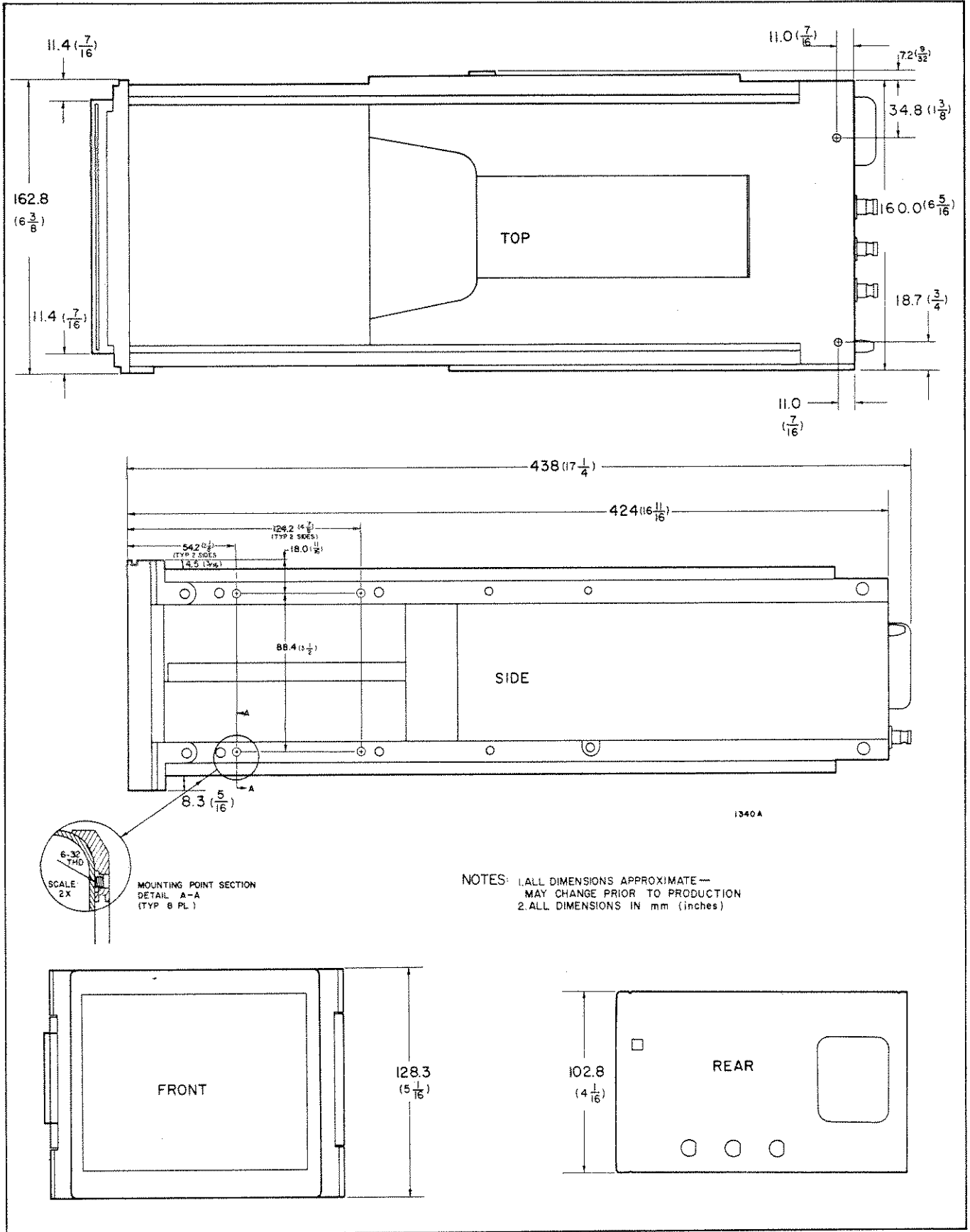

Table 1-3. Available Options

Options	Description	Kit Part Number
MODULES		
001	Basic module without control panel.	See Table 6-2, Section VI
002	Basic module with dc supply voltages.	
CABINET CONFIGURATIONS		
315	Basic module with System II 5-1/4 in. high, half rack width cabinet, 15-in. long struts with control panel. (Model 1340A is supplied without cabinet and with control panel.)	
316	Basic module with all necessary hardware assembled for mounting in 10380A or 10386A with 18-inch side struts. Front casting, two 18-inch struts, no covers, rear cover panel.	
317	Basic module with System II 5.25-in. high, full-rack width cabinet with 15-in. long struts (17-1/8 in. overall length). Painted blank front panel and filter panel included.	
X AND Y AMPLIFIERS		
110	4-10 V/div deflection factor.	
Z AMPLIFIER		
216	TTL blanking level added to Z-axis amplifier. High state (+2.5 V to +5 V) blanks any analog Z-input signal. Low state (0.0 V to +0.8 V) returns blanking to analog Z-axis input. Input through rear-panel BNC connector.	
CRT		
004	Standard CRT replaced with CRT having P4 aluminized phosphor, 8- by 10-div internal graticule.	
039	Standard CRT replaced with CRT having P39 aluminized phosphor, 8- by 10-div internal graticule.	
604	Standard CRT replaced with CRT having P4 aluminized phosphor, no internal graticule.	
607	Standard CRT replaced with CRT having P7 aluminized phosphor, no internal graticule.	
631	Standard CRT replaced with CRT having P31 aluminized phosphor, no internal graticule.	
639	Standard CRT replaced with CRT having P39 aluminized phosphor, no internal graticule.	

Table 1-3. Available Options (Cont'd)

Options	Description	Kit Part Number
561	<p style="text-align: center;">CONTRAST FILTER</p> <p>Standard blue contrast filter replaced by clear CRT impact-protection shield.</p>	See Table 6-2, Section VI
324	<p style="text-align: center;">SIGNAL INPUTS</p> <p>Remote program connector added to rear panel. X-, Y-, and Z-signal inputs wired in parallel with BNC inputs. (NOTE: input capacitance increases to approximately 120 pF.)</p>	
	<p style="text-align: center;">POWER CORDS</p>	
300	Power cord for use in Great Britain and Singapore. 2.3 m (7.5 ft), removable, 240 V max, 3 conductor 90° IEC.	
301	Power cord for use in Australia and New Zealand. 2.3 m (7.5 ft), removable, 240 V max, 3 conductor IEC.	
302	Power cord for use in East and West Europe. 2.3 m (7.5 ft), removable, 240 V max, 3 conductor 90° IEC.	
303	Power cord for use in USA, Canada, Japan, and Mexico. 2.3 m (7.5 ft), removable, 240 V max, 3 conductor IEC to NEMA 5-15P.	
304	Power cord used in USA, Canada, Japan, and Mexico. 77.2 cm (30 in.) coiled, extends to 1.8 m (6 ft), removable, 120 V max, 3 conductor IEC to NEMA 5-15P. (NOTE: not available with Option 315 or 330.)	
	<p style="text-align: center;">SAFETY</p>	
330	Listed by Underwriter Laboratories for medical and dental electronic equipment (UL 544). Includes special hospital-grade AC line cord, special AC line transformer, special marking on top cover and rear panel, and clear CRT impact-protection shield in lieu of standard blue contrast filter.	
331	<p>Underwriter Laboratories recognized components for use in medical and dental equipment (UL 544) display module without cabinet).</p> <p>Includes special hospital-grade AC line cord, special AC line transformer, and clear CRT implosion shield in lieu of standard blue contrast filter.</p>	

1-13. RECOMMENDED TEST EQUIPMENT.

1-14. Equipment required to maintain the 1340A is listed in table 1-4. Other equipment may be substituted if it meets or exceeds the critical specifications listed in the table.

1-15. INSTRUMENTS COVERED BY MANUAL.

1-16. Attached to the instrument is a serial number plate. The serial number is in the form: 0000A00000. It is in two parts; the first four digits and the letter are the serial prefix and the last five digits are the suffix. The prefix is the same for all identical instruments; it changes only when a change is made to the instrument. The suffix however, is assigned sequentially and is different for each instrument. The contents of this manual apply to instruments with the serial number prefix(es) listed under SERIAL NUMBERS on the title page.

1-17. An instrument manufactured after the printing of this manual may have a serial number prefix that is

not listed on the title page. This unlisted serial number prefix indicates the instrument is different from those described in this manual. The manual for this newer instrument is accompanied by a yellow Manual Changes supplement. This supplement contains "change information" that explains how to adapt the manual to the newer instrument.

1-18. In addition to change information, the supplement may contain information for correcting errors in the manual. To keep this manual as current and accurate as possible, Hewlett-Packard recommends that you periodically request the latest Manual Changes supplement. The supplement for this manual is identified with the manual print date and part number, both of which appear on the manual title page. Complimentary copies of the supplement are available from Hewlett-Packard.

1-19. For information concerning a serial number prefix that is not listed on the title page or in the Manual Changes supplement, contact your nearest Hewlett-Packard office.

Table 1-4. Recommended Test Equipment

Instrument	Critical Specification	Recommended Model	Use
Function Generator	Output 1: Sine, Square Wave Amplitude: 0±10 Volts into High Z load Amplitude: 0±2 Volt into 50Ω load Offset: ±1 Volt Frequency: 10 MHz Output Z: 50 Ω Output 2: Sine Amplitude: 1 V into 50 Ω Frequency: 10 kHz	HP 3312A	P,A,T
Pulse Generator (2 Required)	 Period: 0.1 μs to 1 ms Width: square wave Amplitude: 1 Volt Transition Time: < 5 ns Output Z: 50 Ω	HP 8013B	P,A,T
Digital Multimeter	Volts: ±300 VDC Inputs Z: 10 MΩ	HP 3476A	A,T
High Voltage Probe	40 kV for use with above DMM	HP 34111A	A,T
Oscilloscope	Bandwidth: 100 MHz Input Z: 50Ω and 1 M Ω ≈ 20 pF Vertical Sensitivity: 5 mV	HP 1740A	A,T
Oscilloscope Probe (2 each)	Division Ratio: 10:1 Impedance: 10 MΩ, ≈10 pF	HP 10004D	A,T
P = Performance Checks A = Adjustments T = Troubleshooting			

SECTION II INSTALLATION

2-1. INTRODUCTION.

2-2. This section provides installation instructions for the Model 1340A. This section also includes information about initial inspection, damage claims, and packaging instructions.

2-3. INITIAL INSPECTION.

2-4. Inspect the shipping container for damage. If the shipping container or cushioning material is damaged, it should be kept until the contents of the shipment have been checked mechanically and electrically.

2-5. PREPARATION FOR USE.

WARNING

This instrument is designed and manufactured primarily for OEM systems. Without Option 315 or Option 317, protective covers are not provided and internal, hazardous voltages are exposed when ac power is connected. Operator protection from these hazardous voltages must be provided by the system in which the instrument is used.

2-6. **POWER REQUIREMENTS.** The 1340A operates from any power source supplying 100, 120, 220, or 240 Vac (+5% -10%), single phase, 48 Hz to 66 Hz that can deliver at least 35 watts. (See LINE POWER note in table 1-2.)

2-7. **LINE VOLTAGE SELECTION.** The instrument is normally shipped from the factory set to operate at 120 Vac. To operate from any of the other sources, proceed as follows:

WARNING

Component replacement, (including ac fuse) and all adjustments should be performed only by service trained personnel who are aware of the hazards involved (for example, fire and electrical shock).

- a. Remove power cable (if attached).
- b. Remove top cover of 1340A (if installed).
- c. Install line select jumper connector (E1 or E2) as indicated on LVPS schematic at rear of this manual.

NOTE

AC input requirement selected by E1 or E2 jumper connector will be displayed as a color code through rear-panel openings indicating selection of either 100, 120, 220, or 240 volts.

d. Replace internal input line fuse with 300 mA T fuse (HP Part No. 2110-0044) for 220/240 Vac operation.

e. Replace top cover of 1340A (if required).

f. Connect input ac power cable.

2-8. **POWER CABLES.** This instrument is equipped with a three-wire power cable. When connected to an appropriate ac power receptacle, this cable grounds the instrument cabinet. The type of power cable plug shipped with each instrument depends on the country of destination. See figure 2-1 for part numbers of the power cables with plug configurations available.







HP POWER CABLE PART NUMBERS		
8120-1692	8120-0698	8120-0696
		
OPTION 302	OPTION 303	OPTION 301
8120-1703	8120-2296	8120-2061
		
OPTION 300	OPTION 306	OPTION 304
INPUT POWER RECEPTACLE TYPES		

Figure 2-1. Power Receptacles

2-9. REPACKING FOR SHIPMENT.

2-10. If the instrument is to be shipped to a Hewlett-Packard Sales/Service Office for service or repair, attach a tag showing owner (with address), complete instrument serial number, and a description of the service required.

2-11. Use the original shipping carton and packing material. If the original packing material is not available, the Hewlett-Packard Sales/Service Office will provide information and recommendations on materials to be used.

SECTION III

OPERATION

3-1. INTRODUCTION.

3-2. This section contains operating instructions, applications and interfacing considerations for the HP Model 1340A.

WARNING

Without Option 315 or Option 317, protective covers are not provided and internal, hazardous voltages are exposed when ac power is connected. Operator protection from these hazardous voltages must be provided by the system in which the instrument is used.

3-3. PANEL FEATURES.

3-4. The Model 1340A is an X, Y, Z display with analog voltage inputs for X-, Y-, and Z-axis controls. All signals must be externally supplied through rear-panel connectors. The instrument is intended for use as a general-purpose graphic display. Intensity, trace align, focus, position ◀▶ (X), position ⬆ (Y), X-gain, and Y-gain controls are accessible on the front panel. Trace align, X-gain, and Y-gain controls are screwdriver adjustments. Controls and connectors are illustrated and briefly described in figure 3-7.

WARNING

Component replacement (including ac fuse) and internal adjustments must be made by qualified maintenance personnel.

3-5. PREOPERATIONAL PROCEDURE.

CAUTION

The INTENSITY control will adjust display brightness from completely off (ccw) to maximum brightness (cw). To avoid damage to CRT phosphor, increase intensity slowly until display brightness is at a comfortable viewing level.

3-6. **GENERAL.** Prepare the 1340A for operation as follows (instruments with options may require modification of input levels):

NOTE

The instrument is normally shipped with the input attenuator switches set for the 1-volt full scale, high-input impedance configurations. For other input configurations refer to table 3-1 and figure 3-1.

- a. Set INTENSITY fully counterclockwise.
- b. Set horizontal and vertical POSITION controls to midrange.
- c. Set line switch (rear panel) to ON. LINE indicator lamp (front panel) should light.

CAUTION

A high-intensity display over an extended period will burn the CRT phosphor.

- d. Adjust INTENSITY control. Display spot brightness should vary from completely extinguished (full ccw position) to acceptable viewing brightness as control is turned cw. Adjust for comfortable viewing brightness of display spot.
- e. Adjust position ⬆ (Y) through its full range. Display spot will move vertically on CRT, disappearing from viewing area at either extreme of control.
- f. Adjust position ▶◀ (X) through its full range. Display spot will move horizontally on CRT, disappearing from viewing area at either extreme of control.
- g. Set ▶◀ and ⬆ position controls to center display spot on CRT.
- h. Set FOCUS control for smallest, sharpest display spot.
- i. Apply 1-kHz, 1-volt p-p sine-wave signal to X amplifier input connector on rear panel of instrument.
- j. Adjust TRACE ALIGN to align trace horizontally.
- k. Set X GAIN for trace length of 119 mm (4.7 in.), or as required by application.
- l. Connect 1-kHz, 1-volt p-p sine-wave signal to Y amplifier input connector on rear panel of instrument.
- m. Adjust Y GAIN for trace length of 95.2 mm (3.75 in.), or as required by application.

Table 3-1. X, Y, and Z Input Switch Coding

ATTEN	IMPEDANCE	A1 ASSEMBLY SWITCH AND SECTION						
		X INPUT			Y INPUT			Z INPUT
		S1-1	S1-2	S1-5	S2-4	S2-7	S2-8	S2-1
1:1	50 Ω	CLOSED	CLOSED	OPEN	CLOSED	CLOSED	OPEN	CLOSED
1:1	HIGH	OPEN	CLOSED	OPEN	OPEN	CLOSED	OPEN	OPEN
5:1	HIGH	OPEN	OPEN	CLOSED	OPEN	OPEN	CLOSED	NA

3-7. BANDWIDTH REDUCTION. In certain cases, the full 3-MHz bandwidth of the deflection amplifiers is not required. In fact, in some applications it may be desirable to reduce the bandwidth to eliminate system noise problems. The X- and Y-amplifier bandwidth can be limited by engaging the following input attenuation and bandwidth selection switches (see figure 3-1 for switch location):

Amplifier	Engage Switch
X	A1S3-8
Y	A1S3-7

Engaging the bandwidth limit switches reduces the bandwidth of the amplifiers to approximately 165 kHz.

3-8. INPUT POLARITY SELECTION. The X-, Y-, and Z-amplifiers can be conditioned by the input attenuation and bandwidth selection switches for input signals with different polarities. To condition the equipment for different polarity signals, set applicable switches as indicated in table 3-2. (See figure 3-1 for switch location.)

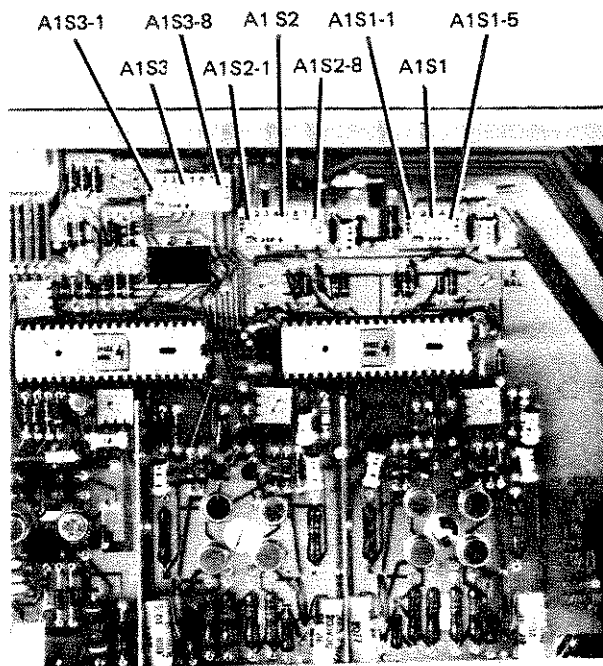

Figure 3-1. Input Attenuation and Bandwidth Selection Switches

Table 3-2. Input Signal Polarity Selection

INPUT POLARITY	X AMPLIFIER INPUT		Y AMPLIFIER INPUT		Z AMPLIFIER INPUT	
	Switch A1, S3-5	Switch A1, S3-6	Switch S3-3	Switch S3-4	Switch S3-1	Switch S3-2
Positive	CLOSED	OPEN	CLOSED	OPEN	CLOSED	OPEN
Negative	OPEN	CLOSED	OPEN	CLOSED	OPEN	CLOSED

3-9. APPLICATION CONSIDERATIONS.

3-10. GENERAL. This section contains interfacing considerations, display adjustments, definitions for specification terminology, and optional features.

3-11. INTERFACING CONSIDERATIONS.

3-12. GENERAL. Front-panel gain controls allow adjustment from 800 mV to 2 V to give full-screen deflection in both the X and Y axes of display. One graticule division is equal to ≈ 1.2 cm (0.47 in.). Switch-selectable attenuation is available to provide full-screen deflection within the range of 4 V to 10 V. This attenuation range plus the gain adjustments allow the 1340A to interface with most systems.

3-13. Crosstalk and Ringing. The importance of 50-ohm input terminations as related to display quality and reduction of crosstalk cannot be overemphasized. The undesirable effects of crosstalk and ringing will increase as input cable length or system bandwidth are increased. However, the use of the 50 Ω terminations will usually reduce crosstalk and reflections to a negligible level.

NOTE

Crosstalk can also be produced by input driving circuits and ground loops.

3-14. Ringing is one possible undesirable side effect of improperly terminated inputs. For instance, an abrupt transition from blanked to unblanked in an improperly terminated Z-axis input line may cause ringing which would appear as intensity fluctuations in the display. For minimum induced crosstalk and ringing, displays connected in parallel should be connected in a "daisy-chain" configuration with only the last display in the chain terminated in 50 ohms (figure 3-2).

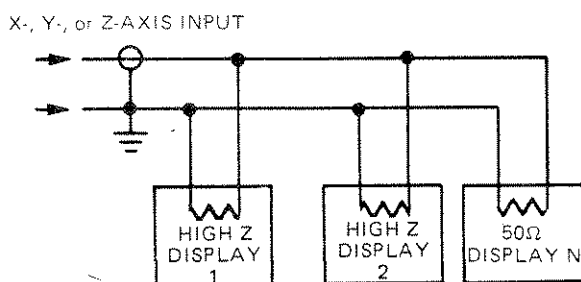

Figure 3-2. Input Termination Impedance of Displays Connected in Parallel

3-15. Setting the intensity control fully ccw prevents the beam from being turned full-on, regardless of the voltage applied to the Z-axis input. This condition is provided to protect the CRT from damage when a system failure causes loss of control over the Z-axis input voltage or loss of deflection voltages. Therefore, the system operator only has to turn the intensity control fully ccw in the event of a system failure.

3-16. DISPLAY ADJUSTMENTS. In order to obtain best performance and flexibility of the 1340A, it is essential that front-panel controls be set properly.

3-17. FOCUS. To focus a display, position the beam approximately 2/3 the diagonal distance from center screen towards any corner of the screen and adjust the focus control for optimum spot size. Position the beam to the remaining three quadrants and check for optimum focus at each location. Often, one quadrant of the screen will not focus as precisely as the other three and this quadrant should be adjusted for the best focus.

3-18. Astigmatism Adjustment. This control (internal adjustment A3R24) is used to match voltage on the forward-most element of the focus lens to voltage on the deflection plates to prevent the deflection plates from acting as part of the focus lens. Without this balanced voltage condition, the focal length of the electron gun is changed at the sides of the beam with respect to the top and bottom of the beam, or vice versa, which distorts the beam shape.

3-19. To check the astigmatism adjustment, rotate the focus control back and forth through the point of optimum focus. If the dots elongate vertically and then horizontally, it indicates improper astigmatism adjustment.

NOTE

Astigmatism is properly adjusted if the dots in the corners slant approximately 45° from upper left to lower right and vice versa as the focus control passes through the point of optimum focus.

3-20. PERFORMANCE SPECIFICATIONS. Major performance specifications, what they mean, how they are determined, and how they affect system performance are explained in the following paragraphs.

3-21. Spot Size and Resolution. If you scan a CRT spot with a microscope photometer and plot brightness versus distance (spot width), the result approximates a Gaussian curve (figure 3-3). The spot size is the width of the Gaussian curve at its 50% point (see section I, table 1-2).

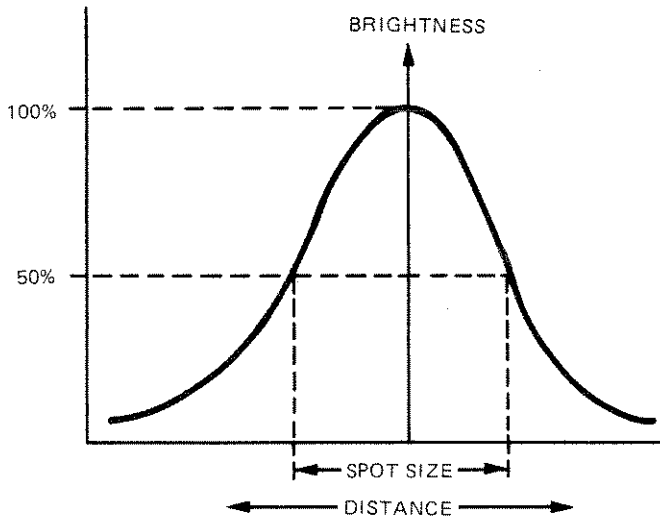

Figure 3-3. Brightness vs Cross Section of Typical CRT Spot

3-22. In practice, the 50% point can be determined by using the shrinking raster measurement method. The shrinking raster measurement is obtained by displaying a raster of lines (or dots) on the CRT and then adjusting the vertical and horizontal gain until the individual lines (or dots) are no longer individually identifiable. The size of the raster is then divided by the number of lines in the raster to determine the spot size. The point where the raster (or dots) merge is approximately the theoretical 50% point on the Gaussian curve.

3-23. The shrinking raster method should be used if a scanning microscope photometer is not available, because observing an individual line (or dot) with an optical comparator can be very misleading. On a single dot, the eye can see to about the 3% point on the Gaussian curve. Here the dot appears to be approximately twice the width it is across the 50% points.

3-24. **Settling Time.** Settling time is defined as the elapsed time between an input step command and the time for the beam to settle within a specified tolerance to its final position (see figure 3-4). Settling time must be taken into account when moving the beam from one location to another. Otherwise, there may be tails on dots, or line distortions at the starting point of vectors.

3-25. **Linearity.** Linearity can be defined as either a scaling error in locating a point on the CRT with given input voltages relative to known full scale input voltages or an error in locating a point within any calibrated increment on the CRT other than full-screen. In other words, if known X and Y input voltages correspond to a certain CRT screen position and other known voltages correspond to another position, then any intermediate voltages between these two sets of voltages correspond to points located proportionately

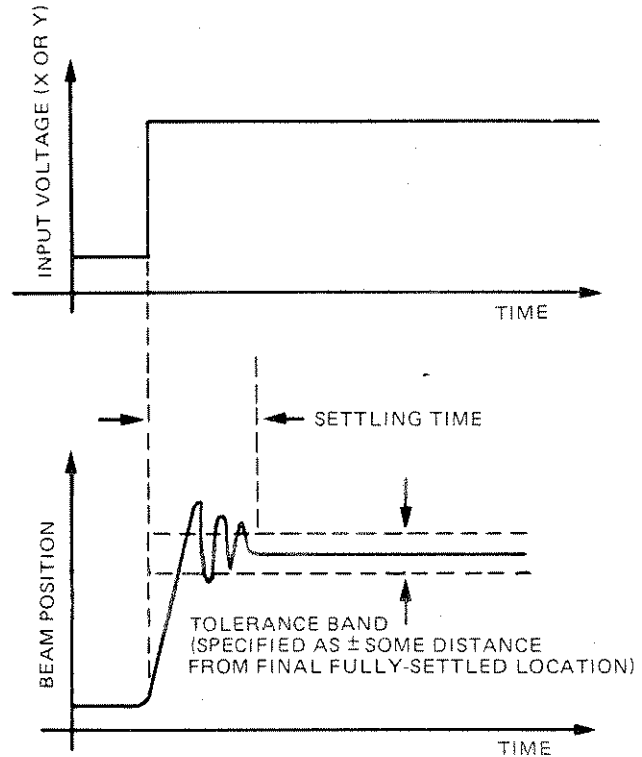

Figure 3-4. Settling Time

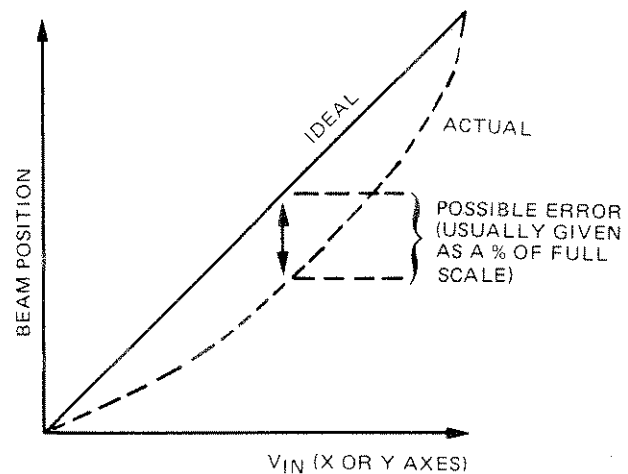

Figure 3-5. Linearity of Beam Position Showing Ideal Positioning and Possible Error

between the two predetermined points with a possible error of $\pm 3\%$ of the distance between the two known points. The increment of position shown in figure 3-5 may be either full screen or any portion of the screen.

3-26. Linearity is specified only along the major CRT screen axes. For CRT line distortion other than along the major axes, refer to the CRT geometry specifications listed in table 1-1 and see figure 3-6.

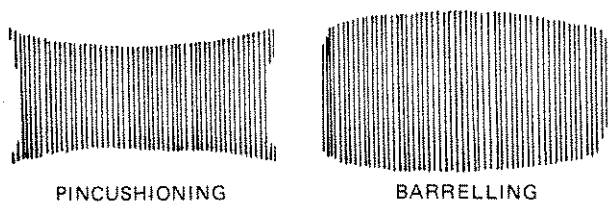
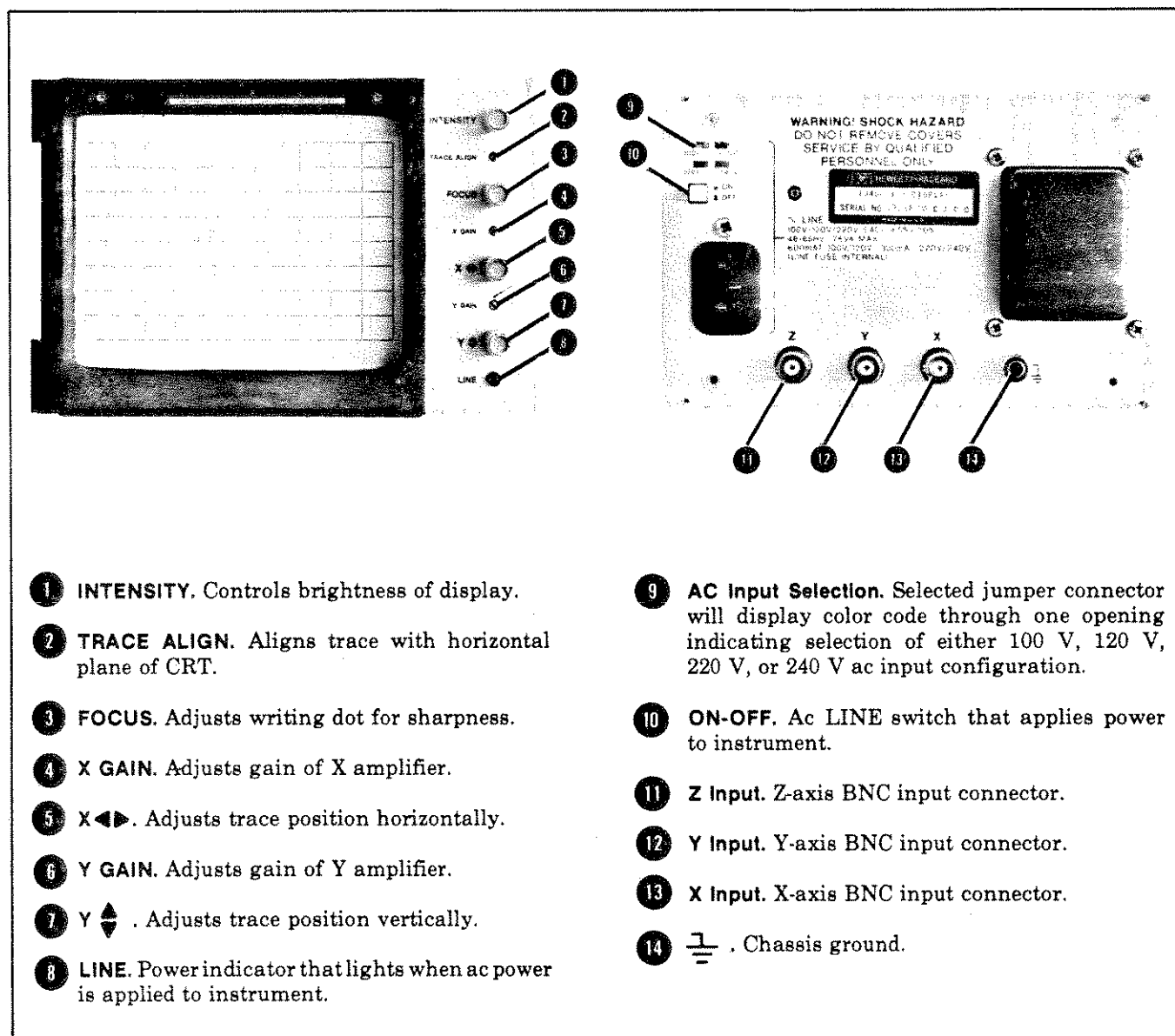

Figure 3-6. Geometric Distortion Caused by CRT (exaggerated)

3-27. From the specifications, it is difficult to relate the actual position of a point on the CRT to the input voltages applied to the X and Y axes, except on the major axes. This is because a CRT is an open-loop device (unlike an X-Y plotter) with no method of applying feedback to the amplifier circuits to make corrections to beam positioning. Therefore, a point along a line from the CRT screen center to a point in the CRT corner is subject to a location error caused by nonlinearity along the major axes and an additional geometric distortion error component which increases in significance as the beam moves out from the CRT center.



- 1 INTENSITY. Controls brightness of display.
- 2 TRACE ALIGN. Aligns trace with horizontal plane of CRT.
- 3 FOCUS. Adjusts writing dot for sharpness.
- 4 X GAIN. Adjusts gain of X amplifier.
- 5 X $\leftarrow \rightarrow$. Adjusts trace position horizontally.
- 6 Y GAIN. Adjusts gain of Y amplifier.
- 7 Y \updownarrow . Adjusts trace position vertically.
- 8 LINE. Power indicator that lights when ac power is applied to instrument.

- 9 AC Input Selection. Selected jumper connector will display color code through one opening indicating selection of either 100 V, 120 V, 220 V, or 240 V ac input configuration.
- 10 ON-OFF. Ac LINE switch that applies power to instrument.
- 11 Z Input. Z-axis BNC input connector.
- 12 Y Input. Y-axis BNC input connector.
- 13 X Input. X-axis BNC input connector.
- 14 \perp . Chassis ground.

Figure 3-7. Controls and Connectors

SECTION IV

PERFORMANCE TESTS

4-1. INTRODUCTION.

4-2. The procedures in this section test the instrument's electrical performance using the specifications of table 1-1 as the performance standards. All tests can be performed without access to the interior of the instrument.

4-3. EQUIPMENT REQUIRED.

4-4. Equipment required for the performance tests is listed in Section I, table 1-4. Any equipment that satisfies the critical specifications given in the table may be substituted for the recommended models.

4-5. TEST RECORD.

4-6. Results of the performance tests may be tabulated on the Test Record at the end of this section. The Test Record lists the tested specifications and their acceptable limits. The results recorded at incoming inspection can be used for comparison in periodic maintenance and troubleshooting and after repairs or adjustments.

4-7. CALIBRATION CYCLE.

4-8. Periodic calibration is not normally required for this instrument. Performance tests, however, should be

made after service work has been performed or if improper operation is suspected.

4-9. Further performance checks are included in the adjustments section that require access to the inside of the instrument. These checks are not considered normal requirements for a standard performance test.

WARNING

The instrument is designed and manufactured primarily for OEM systems. Without Option 315 or Option 317, protective covers are not provided and internal, hazardous voltages are exposed when ac power is connected. Component replacement, including ac fuse, and internal adjustments must be made by qualified maintenance personnel.

4-10. The X (horizontal) and Y (vertical) amplifiers are identical, therefore, only one test has been written and should be applied to both amplifiers before proceeding to the next test.

4-11. PERFORMANCE TEST PROCEDURES.

4-12. DYNAMIC RANGE TEST (X AND Y AMPLIFIERS).

SPECIFICATIONS:

The dynamic range shall extend offscreen to at least 1/2 screen diameter in any direction provided the zero input position is on screen.

DESCRIPTION:

A square-wave signal and a ramp signal are used in an oscilloscope-type presentation. Amplitude of the waveforms is 1.5 times the screen diameter and the display is then checked for distortion.

NOTE

Care must be taken to correctly identify changes in output of the pulse generator. Otherwise, these changes can be misinterpreted as dynamic range irregularities.

PERFORMANCE TESTS

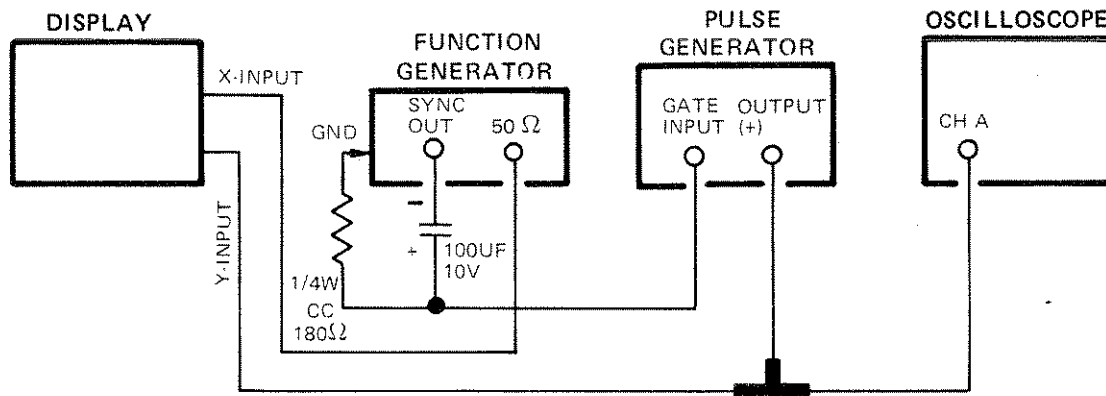

Figure 4-1. Dynamic Range Test Setup

EQUIPMENT:

Function Generator	HP 3312A
Oscilloscope	HP 1740A
Pulse Generator	HP 8013A

PROCEDURE:

- a. Connect equipment as shown in figure 4-1.

NOTE

Sync output from the recommended function generator (table 1-4) must be shifted to gate the pulse generator. The R-C network shown in figure 4-1 shift the output level from the function generator to assure stable gating of the pulse generator.

- b. Set pulse generator as follows:

PULSE PERIOD	10 μ s
PULSE WIDTH	Square Wave
AMPLITUDE (V)	(see Note below)

NOTE

The output amplitude of the pulse generator is set for a full screen display of 96 mm when driving the Y (vertical) amplifier and 119 mm when driving the X (horizontal) amplifier.

- c. Set function generator as follows:

FREQUENCY	20 kHz
FUNCTION	(Sawtooth)
OFFSET	OFF
AMPLITUDE	full-screen deflection

- d. On oscilloscope, note amplitude of pulse generator output required to produce 96 mm (119 mm) display on 1340A CRT.
- e. Increase output amplitude from pulse generator by 1.5 times that noted in step d.
- f. Displayed waveform on 1340A should extend offscreen in one direction (depending on which axis is driven by pulse generator).

NOTE

If trouble is experienced while performing this procedure, check the power supplies, their decoupling networks, and the X-, Y-amplifier outputs, particularly the plate average of +85 volts.

PERFORMANCE TESTS

4-13. X-, Y-AMPLIFIER BANDWIDTH AND RISE TIME.

SPECIFICATION:

Rise time is ≤ 120 ns (10% to 90% points) for full-screen deflection (or less). Bandwidth is dc to greater than 3 MHz (3 dB down) for 5 cm or less deflection.

DESCRIPTION:

This test measures bandwidth of the amplifiers; bandwidth is then used to compute rise time.

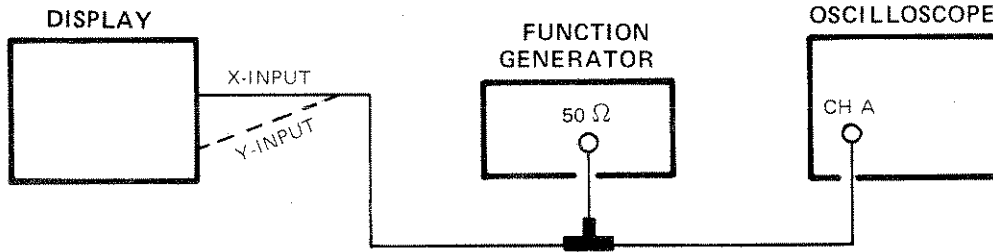

Figure 4-2. Bandwidth and Rise Time Test Setup

EQUIPMENT:

- Function Generator HP 3812A
- Oscilloscope HP 1740A

PROCEDURE:

- a. Connect equipment as shown in figure 4-2.
- b. Set function generator as follows:
 - FREQUENCY 10 kHz
 - FUNCTION (Sine Wave)
- c. Connect output of function generator to one input on 1340A.
- d. Adjust function generator output for 5 cm trace deflection on 1340A CRT.
- e. Using oscilloscope, note p-p amplitude from function generator.
- f. Maintaining same amplitude noted in step e, increase function generator frequency until trace deflection on 1340A CRT decreases to 3.5 cm.
- g. Final frequency setting of function generator is 3 dB bandwidth of amplifier under test.
- h. Using the following formula, compute rise time:

$$rt_{(ns)} = \frac{350}{BW (MHz)}$$

- i. Repeat above procedure for other amplifier and complete following:
 - X AMPL BANDWIDTH MHz
 - X AMPL RISE TIME ns
 - Y AMPL BANDWIDTH MHz
 - Y AMPL RISE TIME ns

PERFORMANCE TESTS

4-14. PHASE SHIFT.

SPECIFICATION:

3° to 1 MHz for input signals causing full-screen deflection.

DESCRIPTION:

This test verifies the phase shift difference between the X and Y amplifiers. Phase shift must remain the same (within 3°) to at least 1 MHz.

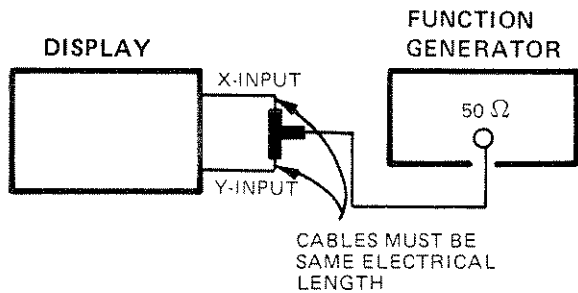

Figure 4-3. Phase-shift Test Setup

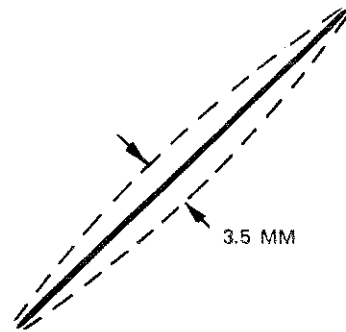

Figure 4-4. Phase-shift Measurement

Equipment:

Function Generator HP 3312A

PROCEDURE:

NOTE

This test cannot be performed properly if the internal input attenuators are not set for the same range.

- a. Connect equipment as shown in figure 4-3.
- b. Set function generator as follows:

FREQUENCY..... 50 kHz
 FUNCTION..... ~ (Sine Wave)

- c. Adjust output amplitude of function generator for full-screen, diagonal trace on 1340A CRT. (Front-panel gain control may need readjusting for corner-to-corner presentation.)
- d. While watching diagonal trace on 1340A CRT, increase frequency until trace separation is 3.5 mm (see figure 4-4).

Frequency causing 3.5 mm trace separation is: _____

PERFORMANCE TESTS

4-15. DIAGONAL SETTling TIME.

SPECIFICATION:

Signal settles to within one spot diameter of final value in ≤ 300 ns for any on-screen movement. Off-screen deflection must not exceed specified dynamic range.

DESCRIPTION:

The intensity (Z-axis) is turned on a short time after the X- or Y-axis transition. Blanking time must be ≤ 300 ns before a significant tail (1 spot diameter) is seen on the spot indicating the beam position is just reaching its settling point.

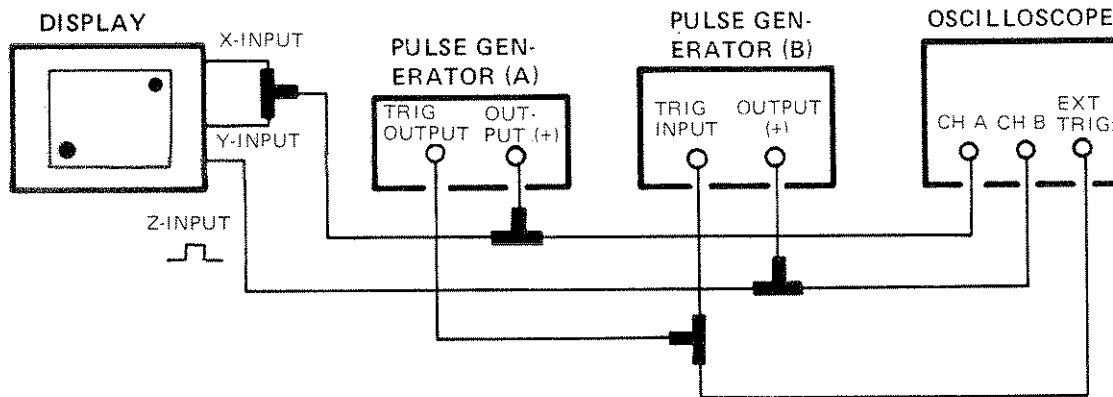

Figure 4-5. Diagonal Settling Time Test Setup

EQUIPMENT:

- Pulse Generators (2) HP 8013B
- Oscilloscope HP 1740A

PROCEDURE:

- a. Connect equipment as shown in figure 4-5.
- b. Set pulse generator (A) as follows:
 - PULSE PERIOD 10 μ s
 - PULSE DELAY minimum
 - PULSE WIDTH Square Wave
- c. Adjust pulse generator (A) AMPLITUDE to position two spots on diagonal corners of 1340A CRT. Position and Gain controls of 1340A may require adjustments for proper positioning of the spots.
- d. Set pulse generator (B) as follows:
 - PULSE PERIOD (+) EXT
 - PULSE DELAY 400 ns
 - PULSE WIDTH 1 μ s
 - AMPLITUDE 1V
- e. Reduce pulse generator (B) PULSE DELAY time until tail of one spot diameter in length is visible at one or both diagonal spots.
- f. Measure delay time on oscilloscope. Test limit is 300 ns maximum. Diagonal Settling Time is: _____ ns.

PERFORMANCE TESTS

4-16. REPEATABILITY.

SPECIFICATION:

0.4 mm error (full-screen) for re-addressing a point from any on- or off-screen location within the specified dynamic range.

DESCRIPTION:

This test verifies the amplifier performance stability with a varying input signal.

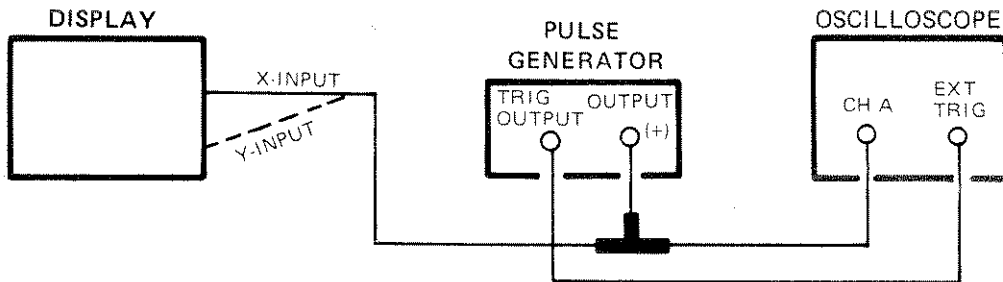

Figure 4-6. Repeatability Test Setup

EQUIPMENT:

Pulse Generator	HP 8013B
Oscilloscope	HP 1740A

NOTE

This test requires a pulse generator with a very stable baseline during changes in pulse period, pulse width, and amplitude. If a pulse generator other than that recommended is used, the baseline shift should be carefully measured. The baseline shift should not exceed 0.05% of the amplitude change.

PROCEDURE:

- a. Connect equipment as shown in figure 4-6.
- b. Set pulse generator as follows:

PULSE PERIOD	0.1 ms
PULSE WIDTH	50 μ s

- c. Using 1340A controls, position baseline spot at center of CRT.

NOTE

Use oscilloscope as a monitor when accomplishing step d. Do not exceed specified dynamic range of the 1340A.

- d. Vary pulse generator amplitude, pulse period, and pulse width verniers and notice any position change in spot. Spot movement should be 0.4 mm or less.

PERFORMANCE TESTS

4-17. TTL BLANKING (OPTION 216 ONLY).

SPECIFICATION:

Option 216 - high state (+2.5 V to +5.0 V) blanks any analog Z-axis input signal. Low state (0 V to +0.8 V) returns blanking function to Z-axis input.

DESCRIPTION:

This test verifies the upper and lower TTL blanking and unblanking limits.

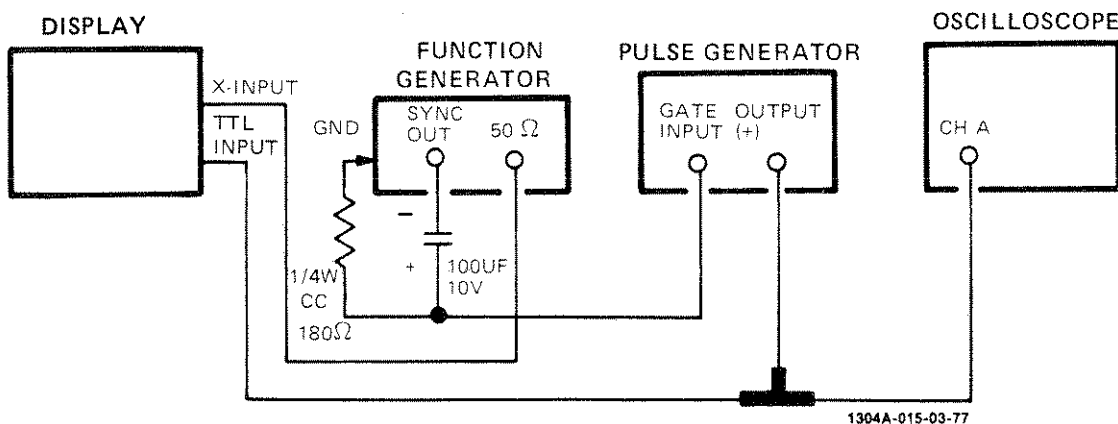

Figure 4-7. Option 216 Test Setup

EQUIPMENT:

Function Generator	HP 3312A
Pulse Generator	HP 8013B
Oscilloscope	HP 1740A

PROCEDURE:

- a. Connect equipment as shown in figure 4-7.

NOTE

Sync output from the recommended function generator (table 1-4) must be shifted to gate the pulse generator. The R-C network shown in figure 4-7 shifts the output level from the function generator so that stable gating of the pulse generator is assured.

- b. Set function generator as follows:

FREQUENCY	10 kHz
FUNCTION	(Sawtooth)
AMPLITUDE	full screen deflection

- c. Set pulse generator as follows:

PULSE PERIOD	10 μSEC
PULSE WIDTH	Square Wave
AMPLITUDE/OFFSET	+2.5 V +0.8 V

- d. Increase 1340A INTENSITY control until segmented line is displayed on CRT indicating blanking and unblanking is occurring.
- e. Disconnect pulse generator from 1340A Z-axis input connector.

PERFORMANCE TEST RECORD

HEWLETT-PACKARD MODEL 1340A X-Y DISPLAY Serial No. _____				
			Tested By _____ Date _____	
Paragraph Number	Test	Min	Results Actual	Max
4-11	Dynamic Range Test Y-amplifier X-amplifier	off-screen off-screen		
4-12	X-, Y-amplifier Bandwidth and Rise Time X-amplifier Bandwidth X-amplifier Rise Time Y-amplifier Bandwidth Y-amplifier Rise Time	3 MHz 3 MHz		130 ns 130 ns
4-13	Phase Shift	1 MHz		
4-14	Diagonal Settling Time			300 ns
4-15	Repeatability			0.4 mm
4-16	TTL Blanking (Opt 216 only)	+0.8 V (unblank) +2.5 V (blank)		

SECTION V ADJUSTMENTS

5-1. INTRODUCTION.

5-2. This section describes adjustments and checks required to return the instrument to peak operating capabilities when repairs have been made. Included in this section are equipment setups and adjustment procedures.

5-3. SAFETY REQUIREMENTS.

5-4. Although this instrument has been designed in accordance with international safety standards, general safety precautions must be observed during all phases of operation, service, and repair of the instrument. Failure to comply with the precautions listed in the Safety Summary at the front of this manual or with specific warnings given throughout the manual could result in serious injury or death. Service and adjustments should be performed only by qualified service personnel.

5-5. EQUIPMENT REQUIRED.

5-6. A complete list of required test equipment is given in Section I, table 1-4. Test equipment equivalent to that recommended may be substituted, provided it meets the required characteristics. For best results, use recently calibrated test equipment.

5-7. ADJUSTMENTS.

5-8. The adjustments given in this section are not interrelated. Refer to table 5-1 for a list of adjustable components and their functions.

5-9. After repair, the applicable adjustments should be made, but a complete readjustment of the instrument is unnecessary. Prior to any adjustments, however, the power supply outputs should be checked for proper voltage levels.

5-10. For best results, allow the instrument to warm up for 15 minutes before making adjustments. Adjustment locations are shown on Service Sheet 6 at the back of this manual.

5-11. ADJUSTMENT PROCEDURES.

WARNING

Adjustment procedures described are performed with power supplied to the instrument and should be performed only by trained service personnel who are aware of the hazards involved (for example, fire and electrical shock).

Table 5-1. Adjustable Components

Reference Designator	Adjustment Name	Adjustment Paragraph	Service Sheet	Description
A2R15	+165 V Adj	5-12	4	+165 V LVPS Adjustment.
A3R2	HV Adj	5-13	3	Adjust for proper CRT filament voltage.
A3R22 A3R24	Focus Adj AST	5-14	3	Centers FOCUS control and adjusts astigmatism of CRT.
A1R74	INT LIMIT	5-15	3	Sets maximum intensity limit for CRT.
A3R25	PATTERN	5-16	3	Adjusts CRT deflection for minimum distortion.
A1R7 A1R19	X BAL Y BAL	5-17	2	Balance X and Y amplifiers for minimum spot movement while GAIN controls are varied.

ADJUSTMENTS

Table 5-1. Adjustable Components (Cont'd)

Reference Designator	Adjustment Name	Adjustment Paragraph	Service Sheet	Description
A1R13 A1R25	Y GAIN SET X GAIN SET	5-18	2	Establishes range of front-panel X and Y GAIN controls.
A1R67	Z BAL	5-19	2	Balances the Z-axis amplifier.
A1R70 A1R75 A1C31	Z GAIN HF Adj No. 1 HF Adj No. 2	5-20	2	Z-axis amplifier response adjustment.
A1C1 A1C10	X-Input Comp Y-Input Comp	5-21	2	AC compensation for 5:1/Hi impedance range.

5-12. LOW-VOLTAGE POWER SUPPLY ADJUSTMENT.

REFERENCE:

Service Sheet 4.

DESCRIPTION:

The +165 Vdc Power Supply is adjusted for an output of +165 V ±1 V. The low-voltage supplies are then checked for proper output.

EQUIPMENT:

DMM (Digital Multimeter)..... HP 3476A

PROCEDURE:

Adjust +165 V low-voltage power supply as follows:

- a. Connect DMM between pin 10 (+165 V) and pin 3 (ground) of ribbon cable A2W1.
- b. Adjust +165 V Adj A2R15 for +165 V ±1 V indication on DMM.
- c. Check other dc voltages as indicated in table 5-2.

Table 5-2. LVPS Tolerances

Power Supply	Test Point (A2W1 Pin No.)	Tolerance	Range
+15 V	Pin 5	±5%	+14.25 to +15.75 V
-15 V	Pin 1	±5%	-14.25 to -15.75 V
-7.5 V	Pin 4	±10%	-6.75 to -8.25 V
+3.5 V	Pin 2	±10%	+3.15 to +3.85 V

ADJUSTMENTS

5-13. HIGH-VOLTAGE POWER SUPPLY ADJUSTMENT.

REFERENCE:

Service Sheet 3.

DESCRIPTION:

The HVPS is adjusted to the voltage specified on the high-voltage transformer ($\pm 3\%$) to assure proper filament voltage for the CRT.

EQUIPMENT:

DMM (Digital Multimeter)	HP 3476A
High-voltage Probe (1000:1)	HP 34111A

NOTE

Digital Multimeter must have a 10-megohm input termination and a 10-V range to be compatible with the 1000:1 probe.

PROCEDURE:

- a. Set 1340A front-panel INTENSITY control fully ccw.
- b. Set rear-panel LINE switch to OFF position.

WARNING

Voltages capable of causing injury or death are present in the high-voltage power supply. Use an insulated adjustment tool and proceed carefully.

- c. Note voltage marked on high-voltage transformer.
- d. Set rear-panel LINE switch to ON.
- e. Connect DMM to +165 V (pin 5 of ribbon connector A3W1) and note voltage indication.
- f. Connect DMM to +165 V through high-voltage probe (1000:1) and note voltage indication.
- g. Compute percentage of error introduced by high-voltage probe (difference between indications noted in step e and step f).
- h. Set LINE switch to OFF.
- i. Connect DMM through high-voltage probe to cathode output at assembly A3 (square pin to which (4) wire is connected).
- j. Set LINE switch to ON.
- k. While monitoring voltage at cathode output, adjust A3R2, HV ADJ, on assembly A3 for DMM indication equal to that listed on high-voltage transformer (step c).

NOTE

Final indication on DMM should include percentage of error noted in step g.

- l. Set LINE switch to OFF.
- m. Disconnect high-voltage probe from cathode output square pin.

ADJUSTMENTS

5-14. FOCUS LIMIT ADJUSTMENT.

REFERENCE:

Service Sheet 3.

DESCRIPTION:

Focus Adj A3R22 centers the range of the front-panel FOCUS control.

EQUIPMENT:

None

PROCEDURE:

- a. Set INTENSITY and vertical/horizontal POSITION controls for spot of normal intensity at center of CRT.
 - b. Set front-panel FOCUS control to midrange.
 - c. Adjust Focus Adj A3R22 and AST control A1R24 for sharpest focus of round spot.
-

5-15. INTENSITY LIMIT ADJUSTMENT.

REFERENCE:

Service Sheet 3.

DESCRIPTION:

Intensity limit adjustment A1R74 sets maximum intensity of the CRT by limiting the grid-to-cathode voltage to 40 volts above cutoff.

EQUIPMENT:

DMM (Digital Multimeter)..... HP 3476A

PROCEDURE:

- a. Connect DMM to pin 1 of ribbon cable A3W1 at A1 assembly.
- b. Slowly adjust front-panel INTENSITY control until CRT displayed spot just extinguishes. Note DMM indication.

CAUTION

The INTENSITY control will adjust display brightness from completely off (ccw) to maximum brightness (cw). To avoid damage to the CRT be certain to accomplish step c before proceeding with this adjustment.

- c. Using Y POSITION control move spot from CRT viewing area.
 - d. Set front-panel INTENSITY control fully clockwise (maximum brightness).
 - e. With DMM connected as directed in step a, adjust INT LIMIT A1R74 for 40 V indication on DMM above that voltage noted in step b.
 - f. Set front-panel INTENSITY control fully counterclockwise.
 - g. Disconnect DMM.
-

ADJUSTMENTS

5-16. PATTERN ADJUSTMENT.

REFERENCE:
Service Sheet 3.

DESCRIPTION:
The function generator outputs provide a raster display which is adjusted for the squarest shape.

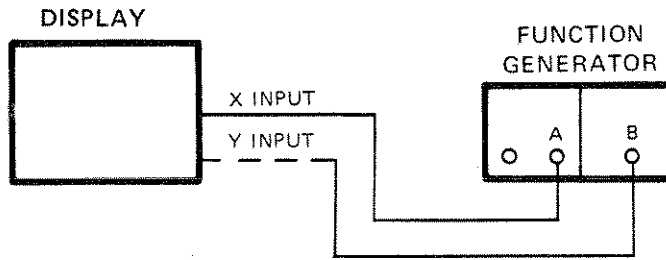

Figure 5-1. Pattern Adjustment Test Setup

EQUIPMENT:
Function Generator HP 3312A

- PROCEDURE:**
- a. Connect equipment as shown in figure 5-1.
 - b. Set function generator outputs as follows:

FREQUENCY A	15 kHz
FREQUENCY B	10 kHz
FUNCTION A and B	~ Sine Wave
AMPLITUDE A and B	Near full screen deflection square pattern
 - c. Adjust pattern control A3R25 for squarest pattern, i.e., straight sides, no barreling or pincushioning.

5-17. X- AND Y-AMPLIFIER BALANCE ADJUSTMENTS.

REFERENCE:
Service Sheet 2.

DESCRIPTION:
X- and Y-amplifier balances are adjusted so that there is minimum spot movement as the front-panel GAIN controls are rotated through their range.

EQUIPMENT:
None

- PROCEDURE:**
- a. Using vertical and horizontal POSITION controls, center spot on CRT.
 - b. While rotating front-panel X GAIN control through its range, adjust A1R7 for minimum spot shift.
 - c. While rotating front-panel Y GAIN control through its range, adjust A1R19 for minimum spot shift.

ADJUSTMENTS

5-18. X- AND Y-AMPLIFIER GAIN SET.

REFERENCE:

Service Sheet 2.

DESCRIPTION:

X- and Y-amplifier gains are adjusted so that front-panel gain controls have a range of 0.8 V to 2 V.

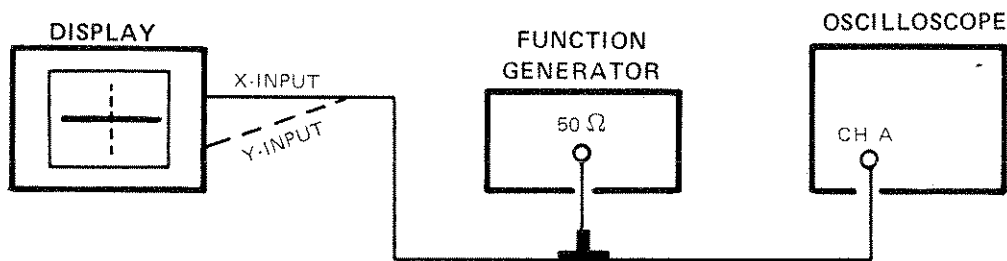

Figure 5-2. Gain Set Adjustment Test Setup

EQUIPMENT:

Function Generator	HP 3312A
Oscilloscope	HP 1740A

PROCEDURE:

- a. Connect equipment as shown in figure 5-2.
- b. Set X- and Y-input attenuators for 50 Ω range (see Service Sheet 2).
- c. Set front-panel X- and Y-GAIN controls fully clockwise.
- d. Set function generator output as follows:

FREQUENCY	1 kHz
FUNCTION	Square Wave
AMPLITUDE	0.4 V p-p
- e. Adjust appropriate X- or Y-amplifier GAIN SET control (A1R25 or A1R13) for 5 div (60 mm).
- f. Increase output of function generator to 2 V p-p.
- g. Verify that front-panel X- or Y-GAIN control can decrease spot separation to less than 5 div (60 mm).

5-19. Z-AMPLIFIER BALANCE ADJUSTMENT.

REFERENCE:

Service Sheet 3.

DESCRIPTION:

Z-amplifier balance control is adjusted so that there is minimum change in intensity as the Z GAIN control is rotated through its range.

EQUIPMENT:

None

PROCEDURE:

- a. Using vertical and horizontal POSITION controls, center spot on CRT.
 - b. While rotating Z-GAIN control, A1R70, through its range, adjust A1R67 for minimum change in intensity.
-

ADJUSTMENTS

5-20. Z-AMPLIFIER GAIN AND HIGH FREQUENCY ADJUSTMENTS.

REFERENCE:

Service Sheet 3.

DESCRIPTION:

Z-axis GAIN control A1R70 is normally operated at full gain (fully clockwise). Amplifier response is adjusted for the fastest transition consistent with minimum overshoot.

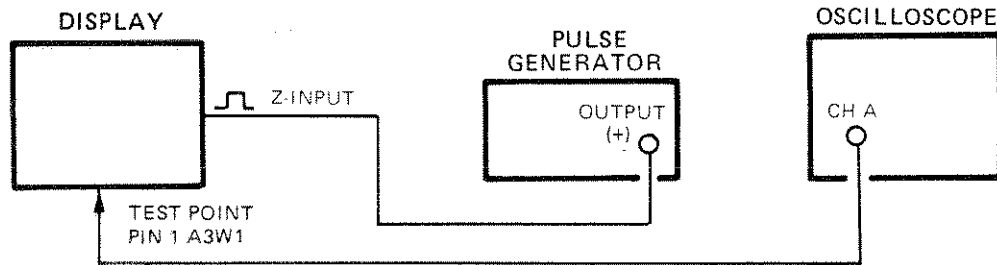

Figure 5-3. Z-amplifier Gain and High Frequency Adjustment Test Setup

EQUIPMENT:

Pulse Generator	HP 8013B
Oscilloscope	HP 1740A
10:1 Divider Probe	HP 10004D

PROCEDURE:

- a. Using front-panel FOCUS control, defocus spot on CRT.
- b. Set Z-amplifier input attenuator for 50Ω range.
- c. Set Z-axis gain control A1R70 fully clockwise.
- d. Connect equipment as shown in figure 5-3.
- e. Using 10:1 divider probe, connect oscilloscope to pin 1 of A3W1 at A1 assembly.
- f. Set pulse generator as follows:

PULSE PERIOD	0.1 ms
PULSE WIDTH	Square Wave
AMPLITUDE	0.5 V p-p
- g. Adjust front-panel INTENSITY control so waveform observed at pin 1 of A3W1 does not limit at top or bottom.
- h. Adjust HF ADJ No. 1 (A1R75) and HF ADJ No. 2 (A1C31) to achieve fast-rise response as observed on oscilloscope (< 70 ns) consistent with sharp corners and minimum overshoot.

ADJUSTMENTS

5-21. INPUT ATTENUATOR COMPENSATION.

REFERENCE:

Service Sheet 2.

DESCRIPTION:

This procedure adjusts input attenuators for the X- and Y-axis amplifiers. No adjustments are required for the 1:1/50 and the 1:1/Hi impedance ranges. The 5:1/Hi impedance range requires ac compensation. Service Sheet 2 shows switch settings for the 5:1/Hi impedance input.

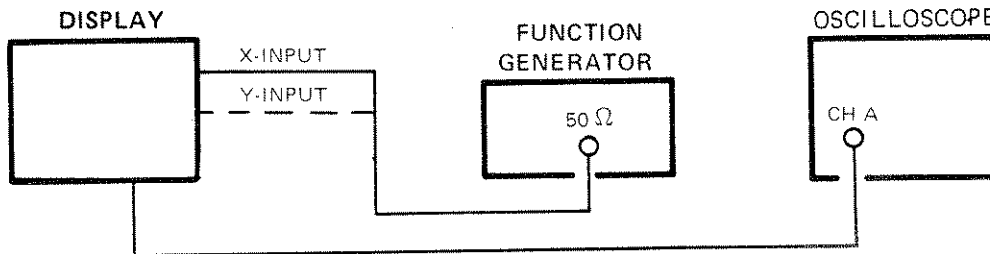

Figure 5-4. Input Attenuator Adjustment Test Setup

EQUIPMENT:

Function Generator	HP 3312A
Oscilloscope	HP 1740A
10:1 Divider Probe	HP 10004D

PROCEDURE:

NOTE

Connect the function generator output to only one input at a time. Using 10:1 divider probe, connect oscilloscope to appropriate amplifier output.

- a. Set both X- and Y-input attenuator switches for 5:1/Hi impedance input (see Service Sheet 2).
- b. Connect equipment as shown in figure 5-4.
- c. Set function generator output as follows:

FREQUENCY	10 kHz
FUNCTION	Square Wave
AMPLITUDE	5 V p-p

- d. Adjust appropriate attenuator compensation capacitor (A1C1 for X INPUT; A1C10 for Y INPUT) for sharp square-wave response on oscilloscope.

SECTION VI

REPLACEABLE PARTS

6-1. INTRODUCTION.

6-2. This section contains information for ordering parts. Table 6-1 lists abbreviations used in the parts list, table 6-2 lists all replaceable parts in reference designator order, and table 6-3 contains the names and addresses that correspond to the manufacturers' code numbers.

6-3. ABBREVIATIONS.

6-4. Table 6-1 lists abbreviations used in the parts list, the schematics, and throughout the manual. In some cases, two forms of the abbreviation are used, one all in capital letters, and one partial or no capitals. This occurs because the abbreviations in the parts list are always all capitals. However, in other parts of the manual other abbreviation forms are used with both lower and uppercase letters.

6-5. REPLACEABLE PARTS LIST.

6-6. Table 6-2 is the list of replaceable parts and is organized as follows:

- a. Electrical assemblies in alphanumerical order by reference designation.
- b. Chassis-mounted parts in alphanumerical order by reference designation.
- c. Electrical assemblies and their components in alphanumerical order by reference designation.

The information given for each part consists of the following:

- a. Complete reference designation.
- b. Hewlett-Packard part number.
- c. Total quantity (Qty) in instrument.
- d. Description of part.
- e. Typical manufacturer of part in identifying five-digit code.
- f. Manufacturer's number for part.

The total quantity for each part is given only once—at the first appearance of the part number in the list.

6-7. ORDERING INFORMATION.

6-8. To order a part listed in the replaceable parts table, quote the Hewlett-Packard part number, indicate the quantity required, and address the order to the nearest Hewlett-Packard office.

6-9. To order a part that is not listed in the replaceable parts table, include the instrument model number, instrument serial number, the description and function of the part, and the number of parts required. Address the order to the nearest Hewlett-Packard office.

6-10. DIRECT MAIL ORDER SYSTEM.

6-11. Within the USA, Hewlett-Packard can supply parts through a direct mail order system. Advantages of using the system are as follows:

- a. Direct ordering and shipment from HP Parts Center in Mountain View, California.
- b. No maximum or minimum on any mail order (there is minimum order amount for parts ordered through local HP offices when orders require billing and invoicing).
- c. Prepaid transportation (there is small handling charge for each order).
- d. No invoices—to provide these advantages, check or money order must accompany each order.

6-12. Mail order forms and specific ordering information is available through your local HP office.

Table 6-1. Reference Designators and Abbreviations

REFERENCE DESIGNATORS					
A	= assembly	F	= fuse	MP	= mechanical part
B	= motor	FL	= filter	P	= plug
BT	= battery	IC	= integrated circuit	Q	= transistor
C	= capacitor	J	= jack	R	= resistor
CP	= coupler	K	= relay	RT	= thermistor
CR	= diode	L	= inductor	S	= switch
DL	= delay line	LS	= loud speaker	T	= transformer
DS	= device signaling (lamp)	M	= meter	TB	= terminal board
E	= misc electronic part	MK	= microphone	TP	= test point
U	= integrated circuit			V	= vacuum, tube, neon bulb, photocell, etc
				VR	= voltage regulator
				W	= cable
				X	= socket
				Y	= crystal
				Z	= tuned cavity network
ABBREVIATIONS					
A	= amperes	H	= henries	N/O	= normally open
AFC	= automatic frequency control	HDW	= hardware	NOM	= nominal
AMPL	= amplifier	HEX	= hexagonal	NPO	= negative positive zero (zero temperature coefficient)
BFO	= beat frequency oscillator	HG	= mercury	NPN	= negative-positive-negative
BE CU	= beryllium copper	HR	= hours	NRFR	= not recommended for field replacement
BH	= binder head	HZ	= hertz	NSR	= not separately replaceable
BP	= bandpass	IF	= intermediate freq	OBD	= order by description
BRS	= brass	IMPG	= impregnated	OH	= oval head
BWO	= backward wave oscillator	INCD	= incandescent	OX	= oxide
CCW	= counter-clockwise	INCL	= include(s)	P	= peak
CER	= ceramic	INS	= insulation(ied)	PC	= printed circuit
CMO	= cabinet mount only	INT	= internal	PF	= picofarads= 10 ⁻¹² farads
COEF	= coefficient	K	= kilo=1000	PH BRZ	= phosphor bronze
COM	= common	LH	= left hand	PHL	= phillips
COMP	= composition	LIN	= linear taper	PIV	= peak inverse voltage
COMPL	= complete	LK WASH	= lock washer	PNP	= positive-negative-positive
CONN	= connector	LOG	= logarithmic taper	P/O	= part of
CP	= cadmium plate	LPF	= low pass filter	POLY	= polystyrene
CRT	= cathode-ray tube	M	= milli=10 ⁻³	PORC	= porcelain
CW	= clockwise	MEG	= meg=10 ⁶	POS	= position(s)
DEPC	= deposited carbon	MET FLM	= metal film	POT	= potentiometer
DR	= drive	MET OX	= metallic oxide	PP	= peak-to-peak
ELECT	= electrolytic	MFR	= manufacturer	PT	= point
ENCAP	= encapsulated	MHZ	= mega hertz	PWV	= peak working voltage
EXT	= external	MINAT	= miniature	RECT	= rectifier
F	= farads	MOM	= momentary	RF	= radio frequency
FH	= flat head	MOS	= metal oxide substrate	RH	= round head or right hand
FIL H	= fillister head	MTG	= mounting		
FXD	= fixed	MY	= "mylar"		
G	= giga (10 ⁹)	N	= nano (10 ⁻⁹)		
GE	= germanium	N/C	= normally closed		
GL	= glass	NE	= neon		
GRD	= grounded	NI PL	= nickel plate		
				RMO	= rack mount only
				RMS	= root-mean square
				RWV	= reverse working voltage
				S-B	= slow-blow
				SCR	= screw
				SE	= selenium
				SECT	= section(s)
				SEMICON	= semiconductor
				SI	= silicon
				SIL	= silver
				SL	= slide
				SPG	= spring
				SPL	= special
				SST	= stainless steel
				SR	= split ring
				STL	= steel
				TA	= tantalum
				TD	= time delay
				TGL	= toggle
				THD	= thread
				TI	= titanium
				TOL	= tolerance
				TRIM	= trimmer
				TWT	= traveling wave tube
				U	= micro=10 ⁻⁶
				VAR	= variable
				VDCW	= dc working volts
				W/	= with
				W	= watts
				WIV	= working inverse voltage
				WW	= wirewound
				W/O	= without

Table 6-2. Replaceable Parts

Reference Designation	HP Part Number	Qty	Description	Mfr Code	Mfr Part Number
A1	01340-66501	1	BOARD ASSEMBLY -- X Y Z AMPLIFIER	28480	01340-66501
A2	01340-66502	1	BOARD ASSEMBLY -- LOW-VOLTAGE POWER SUPPLY	28480	01340-66502
A3	01340-66503	1	BOARD ASSEMBLY -- HIGH-VOLTAGE POWER SUPPLY	28480	01340-66503
A4	01340-66504	1	BOARD ASSEMBLY -- CONTROL	28480	01340-66504
A5	01340-66506	1	BOARD ASSEMBLY -- DC POWER (OPTION 002 ONLY)	28480	01340-66506
E1	01340-67601	1	LINE SELECT ASSY : 100V-120V (NOT SUPPLIED WITH OPTION 002)	28480	01340-67601
E2	01340-67602	1	LINE SELECT ASSY: 220V-240V (NOT SUPPLIED WITH OPTION 002)	28480	01340-67602
E3	1510-0038	1	POST-BINDING	28480	1510-0038
E4	0340-0564	3	INSULATOR-TSTR	28480	0340-0564
E5	0340-0565	1	INSULATOR-TSTR	28480	0340-0565
H1	0340-0857	4	INSULATOR-BUSHING	28480	0340-0857
H2	0360-1632	3	LUG-SOLDER	79963	761-3/8
H3	0400-0002	1	GROMMET-RUBBER	82099	3002
H4	0400-0009	1	GROMMET-VINYL	01538	G250
H5	0520-0144	2	SCREW-RETAINING, FILTER 2-56 .25 IN. LG	28480	0520-0144
H6	0624-0289	3	SCREW-TAPPING 2-28 .312-IN-LG PAN HD	28480	0624-0289
H7	1200-0081	9	INSULATOR-BUSHING, NYLON	28480	1200-0081
H8	1400-0017	1	CLAMP-CABLE .312-DIA .375 WD NYL	05683	374-6
H9	2190-0008	1	WASHER-LK EXT T NO. 6 .141-IN-ID	04604	1341
H10	2190-0027	1	WASHER-LK INTL T 1/4 IN .256-IN-ID	78189	1934-00
H11	2190-0030	4	WASHER-LK HLCL NO. 4 .115-IN-ID	28480	2190-0030
H12	2190-0045	3	WASHER-LK HLCL NO. 2 .088-IN-ID	76854	1501-009
H13	2190-0112	3	WASHER-LK HLCL NO. 2 .088-IN-ID	78189	1920-02
H14	2200-0107	1	SCREW-MTL 0.375 LG	28480	2200-0107
H15	2200-0129	3	SCREW-MTL 2.00 LG	28480	2200-0129
H16	2200-0143	4	SCREW-MTL 0.375 LG	28480	2200-0143
H17	2200-0179	1	SCREW-MTL 0.125 LG	28480	2200-0179
H18	2200-0180	1	SCREW-MTL 1.375 LG	28480	2200-0180
H19	2200-0528	1	SCREW-MTL 1.875 LG	28480	2200-0528
H20	2260-0001	3	NUT-HEX-DBL-CHAM 4-40 THD .094-IN-THK	28480	2260-0001
H21	2260-0003	1	NUT-HEX-PLST CLKG 4-40 THD .141-IN-THK	72962	97NM40
H22	2360-0111	4	SCREW-MTL 0.188 LG 6-32	28480	2360-0111
H23	2360-0115	7	SCREW-MTL 0.312 LG 6-32	28480	2360-0115
H24	2360-0181	4	SCREW-MTL 0.250 LG 6-32	28480	2360-0181
H25	2360-0192	6	SCREW-MTL 0.250 LG 6-32	28480	2360-0192
H26	2420-0001	1	NUT-HEX W/LKWR 6-32 .109-IN-THK	28480	2420-0001
H27	2260-0009	1	NUT, HEX-DBL-CHAM 4-40 THD .093-IN-THK	28480	2260-0009
J1	1250-0083	4	CONNECTOR-BNC FEMALE	02660	31-222-1021
J2	1250-0083		CONNECTOR-BNC FEMALE	02660	31-222-1021
J3	1250-0083		CONNECTOR-BNC FEMALE	02660	31-222-1021
J4	1250-0083		CONNECTOR-BNC FEMALE	02660	31-222-1021
L1	01340-66001	1	COIL-TRACE ALIGN	28480	01340-66001
MP1	0370-0603	1	PUSHBUTTON-MINT GRAY SQ	28480	0370-0603
MP2	0370-2512	4	KNOB-RND	28480	0370-2512
MP3	7100-0389	1	COVER-XFMR	28480	7100-0389
MP4	01340-00201	1	PANEL REAR (STANDARD MODEL)	28480	01340-00201
MP5	01340-00601	1	SHIELD-HV, OUTER	28480	01340-00601
MP6	01340-00602	1	SHIELD-HV, INNER	28480	01340-00602
MP7	01340-02702	1	FILTER-BLUE	28480	01340-02702
MP7	01340-02701	1	FILTER-CLEAR (OPTION 561 ONLY)	28480	01340-02701
MP7	01340-02703	1	FILTER-AMBER (OPTION 007 ONLY)	28480	01340-02703
MP8	01340-04101	1	RETAINER-FILTER	28480	01340-04101
MP9	01340-60602	1	SUBASSY-SHIELD SUPPORT	28480	01340-60602
MP10	01340-04103	1	PLATE COVER, REAR	28480	01340-04103
MP11	4040-1311	1	COVER, LOW VOLTAGE	28480	4040-1311
MP12	5040-7648	1	PLATE, COVER-CRT	28480	5040-7648
MP13	5040-8381	1	PANEL, FRONT	28480	5040-8381
MP14	5060-9977	1	COVER-TOP (OPTION 315 ONLY)	28480	5060-9977
MP15	01332-00204	1	PANEL-REAR (OPTION 316 ONLY)	28480	01332-00204
MP16	01340-00207	1	PANEL-FRONT, BLANK (OPTION 317 ONLY)	28480	01340-00207
MP17	01340-00208	1	PANEL-COVER, REAR, BLANK (OPTION 317 ONLY)	28480	01340-00208
MP18	01340-00209	1	PANEL-SUB, FRONT (OPTION 317 ONLY)	28480	01340-00209
MP19	01340-01201	1	BRACKET-MOUNTING (OPTION 316 ONLY)	28480	01340-01201
MP20	1460-1345	1	STAND, TILT (OPTIONS 315 AND 317 ONLY)	28480	1460-1345
MP21	5060-9834	1	COVER-TOP (OPTION 317 ONLY)	28480	5060-9834
MP22	5060-9846	1	COVER-BOTTOM (OPTION 317 ONLY)	28480	5060-9846
MP23	5060-9973	1	COVER-BOTTOM (OPTION 315 ONLY)	28480	5060-9973
MP24	5001-0439	2	TRIM-FRONT SIDE (OPTIONS 315 AND 317 ONLY)	28480	5001-0439
MP25	5020-8803	1	CASTING-FRONT (OPTION 317 ONLY)	28480	5020-8803
MP26	5020-8804	1	CASTING-REAR (OPTION 317 ONLY)	28480	5020-8804
MP27	5020-8815	1	CASTING-FRONT FRAME (OPTIONS 315 AND 317 ONLY)	28480	5020-8815
MP28	5020-8816	1	CASTING-REAR FRAME (OPTIONS 315 AND 316 ONLY)	28480	5020-8816

See introduction to this section for ordering information

Table 6-2. Replaceable Parts (Cont'd)

Reference Designation	HP Part Number	Qty	Description	Mfr Code	Mfr Part Number
MP29	5020-8836	4	STRUT-CORNER (OPTIONS 315 AND 317 ONLY)	28480	5020-8836
MP30	5020-8837	1	CASTING-CORNER (OPTION 316 ONLY)	28480	5020-8837
MP31	5040-7201	4	FOOT (OPTIONS 315 AND 317 ONLY)	28480	5040-7201
MP32	5040-7202	1	TRIM-STRIP, TOP (OPTION 317 ONLY)	28480	5040-7202
MP33	5040-7203	1	TRIM-TOP FRONT (OPTION 315 ONLY)	28480	5040-7203
MP34	5040-8382	1	FRONT PNL INSERT-RIGHT (OPTIONS 315 AND 316 ONLY)	28480	5040-8382
MP35	5040-8383	1	FRONT PNL INSERT-LEFT (OPTIONS 315, 316, AND 317 ONLY)	28480	5040-8383
MP36	5060-9911	1	SIDE-PERF (OPTION 317 ONLY)	28480	5060-9911
Q1	1854-0433	3	TRANSISTOR NPN SI PD=90W FT=2 MHZ	28480	1854-0433
Q2	1854-0330	1	TRANSISTOR NPN SI PD=21W FT=10 MHZ (NOT SUPPLIED WITH OPTION 002)	28480	1854-0330
Q3	1854-0433	1	TRANSISTOR NPN SI PD=90W FT=2 MHZ (OPTION 002 ONLY)	28480	1854-0433
Q4	1854-0433	1	TRANSISTOR NPN SI PD=90W FT=2 MHZ (OPTION 002 ONLY)	28480	1854-0433
T1	01340-66002	1	TRANSFORMER-INPUT PWR (NOT SUPPLIED WITH OPTION 002)	28480	01340-66002
U1	1826-0106	2	IC 7815 V RGLTR (NOT SUPPLIED WITH OPTION 002)	28480	1826-0106
U2	1826-0214	1	IC V RGLTR (NOT SUPPLIED WITH OPTION 002)	28480	1826-0214
U3	1826-0106	1	IC 7815 V RGLTR (OPTION 002 ONLY)	28480	1826-0106
V1	5083-5251	1	CRT-P31 AL NG	28480	5083-5251
V1	5083-5252	1	CRT-P31 AL IG (OPTION 031 ONLY)	28480	5083-5252
V1	5083-5261	1	CRT-P4 AL NG (OPTION 004 ONLY)	28480	5083-5261
V1	5083-5270	1	CRT-P39 AL IG (OPTION 039 ONLY)	28480	5083-5270
V1	5083-5271	1	CRT-P39 AL NG (OPTION 639 ONLY)	28480	5083-5271
W1	8120-1521	1	CABLE UNSHLD 3-COND 18AWG	28480	8120-1521
W1	8120-1703	1	CABLE, 3-COND (OPTION 300 ONLY)	28480	8120-1703
W1	8120-0696	1	CABLE, 3-COND (OPTION 301 ONLY)	28480	8120-0696
W1	8120-1692	1	CABLE, 3-COND (OPTION 302 ONLY)	28480	8120-1692
W1	8120-0698	1	CABLE, 3-COND (OPTION 303 ONLY)	28480	8120-0698
W1	8120-2061	1	CABLE, 3-COND (OPTION 304 ONLY)	28480	8120-2061
W1	8120-2296	1	CABLE, 3-COND (OPTION 306 ONLY)	28480	8120-2296
XV1	5040-7649	1	SOCKET-CRT BASE	28480	5040-7649
A1	01340-66501	1	BOARD ASSEMBLY-X Y Z AMPLIFIER (LESS A1A1 AND A1A2)	28480	01340-66501
A1A1	1KA2-5006	2	IC: X-Y PREAMPLIFIER (NOT SUPPLIED WITH A1-ORDER SEPARATELY)	28480	1KA2-5006
A1A2	1KA2-5006	1	IC: Z PREAMPLIFIER (NOT SUPPLIED WITH A1-ORDER SEPARATELY)	28480	1KA2-5006
A1C1	0121-0506	3	CAPACITOR-V TRMR 1-5 PF 250V	28480	0121-0506
A1C2	0160-2257	2	CAPACITOR-FXD 10 PF +-5% 500VDC CER 0+-60	28480	0160-2257
A1C3	0160-2055	4	CAPACITOR-FXD .01 UF +80-20% 100VDC CER	28480	0160-2055
A1C4	0160-3447	2	CAPACITOR-FXD 470 PF +-10% 1KVDC CER	56289	C0168102F221KS25-CDH
A1C5	0160-2265	2	CAPACITOR-FXD 22 PF +-5% 500VDC CER 0+-30	28480	0160-2265
A1C6	0160-3447	4	CAPACITOR-FXD 470 PF +-10% 1KVDC CER	56289	C0168102F221KS25-CDH
A1C7	0160-3443	4	CAPACITOR-FXD .1 UF +80-20% 50WVDC CER	28480	0160-3443
A1C8	0160-3443	4	CAPACITOR-FXD .1 UF +80-20% 50WVDC CER	28480	0160-3443
A1C9	0160-3443	4	CAPACITOR-FXD .1 UF +80-20% 50WVDC CER	28480	0160-3443
A1C10	0121-0506	3	CAPACITOR-V TRMR 1-5 PF 250V	28480	0121-0506
A1C11	0160-2257	2	CAPACITOR-FXD 10 PF +-5% 500VDC CER 0+-60	28480	0160-2257
A1C12	0160-2055	4	CAPACITOR-FXD .01 UF +80-20% 100VDC CER	28480	0160-2055
A1C13	0160-2265	2	CAPACITOR-FXD 22 PF +-5% 500VDC CER 0+-30	28480	0160-2265
A1C14	0160-3443	4	CAPACITOR-FXD .1 UF +80-20% 50WVDC CER	28480	0160-3443
A1C15	0140-0192	2	CAPACITOR-FXD 68 PF +-5% 300VDC	72136	DM15E560J0300WV1CR
A1C16	0160-3665	7	CAPACITOR-FXD .01 UF +80-20% 500VDC CER	28480	0160-3665
A1C17	0160-2236	4	CAPACITOR-FXD 1 PF +-1 PF 500VDC	28480	0160-2236
A1C18	0160-2236	4	CAPACITOR-FXD 1 PF +-1 PF 500VDC	28480	0160-2236
A1C19	0160-3665	5	CAPACITOR-FXD .01 UF +80-20% 500VDC CER	28480	0160-3665
A1C20	0160-0166	5	CAPACITOR-FXD .068 UF +-10% 200VDC	06001	AE22C683KT
A1C21	0160-0166	5	CAPACITOR-FXD .068 UF +-10% 200VDC	06001	AE22C683KT
A1C22	0140-0192	5	CAPACITOR-FXD 68 PF +-5% 300VDC	72136	DM15E560J0300WV1CR
A1C23	0160-3665	5	CAPACITOR-FXD .01 UF +80-20% 500VDC CER	28480	0160-3665
A1C24	0160-2236	4	CAPACITOR-FXD 1 PF +-1 PF 500VDC	28480	0160-2236
A1C25	0160-2236	4	CAPACITOR-FXD 1 PF +-1 PF 500VDC	28480	0160-2236
A1C26	0160-3665	5	CAPACITOR-FXD .01 UF +80-20% 500VDC CER	28480	0160-3665
A1C27	0160-0166	5	CAPACITOR-FXD .068 UF +-10% 200VDC	06001	AE22C683KT
A1C28	0160-0166	5	CAPACITOR-FXD .068 UF +-10% 200VDC	06001	AE22C683KT

See introduction to this section for ordering information

Table 6-2. Replaceable Parts (Cont'd)

Reference Designation	HP Part Number	Qty	Description	Mfr Code	Mfr Part Number
A1C29	0160-2055	1	CAPACITOR-FXD .01 UF +80-20% 100VDC CER	28480	0160-2055
A1C30	0150-0116		CAPACITOR-FXD 47 PF +-10% 500VDC	28480	0150-0116
A1C31	0121-0506		CAPACITOR-V TRMR 1.5 PF 250V	28480	0121-0506
A1C32	0160-2055		CAPACITOR-FXD .01 UF +80-20% 100VDC CER	28480	0160-2055
A1C33	0160-3638		CAPACITOR-FXD .22 UF +80-20% 200VAC	16546	C240B224Z
A1C34	0160-0166	1	CAPACITOR-FXD .068 UF +-10% 200VDC	06001	AE22C683KT
A1CR1	1901-0028	10	DIODE-PWR RECT 400V 750MA D0-29	28480	1901-0028
A1CR2	1901-0028		DIODE-PWR RECT 400V 750MA D0-29	28480	1901-0028
A1CR3	1901-0096		DIODE-SWITCHING 120V 50MA 100NS	28480	1901-0096
A1CR4	1901-0040		DIODE-SWITCHING 30V 50MA 2NS D0-35	28480	1901-0040
A1J1	1200-0474	1	SOCKET IC 14 PIN DIP	28480	1200-0474
A1MP1	1600-0441	2	SHIELD, AMPLIFIER	28480	1600-0441
A1Q1	1853-0036	4	TRANSISTOR PNP SI PD=310MW FT=250MHZ	28480	1853-0036
A1Q2	1853-0036		TRANSISTOR PNP SI PD=310MW FT=250MHZ	28480	1853-0036
A1Q3	1853-0038	5	TRANSISTOR PNP SI TO-39 PD=1W FT=100MHZ	28480	1853-0038
A1Q4	1854-0523		TRANSISTOR NPN SI TO-39 PD=1W FT=150MHZ	28480	1854-0523
A1Q5	1854-0523	4	TRANSISTOR NPN SI TO-39 PD=1W FT=150MHZ	28480	1854-0523
A1Q6	1853-0038		TRANSISTOR PNP SI TO-39 PD=1W FT=100MHZ	28480	1853-0038
A1Q7	1853-0036	4	TRANSISTOR PNP SI PD=310MW FT=250MHZ	28480	1853-0036
A1Q8	1853-0036		TRANSISTOR PNP SI PD=310MW FT=250MHZ	28480	1853-0036
A1Q9	1853-0038	4	TRANSISTOR PNP SI TO-39 PD=1W FT=100MHZ	28480	1853-0038
A1Q10	1854-0523		TRANSISTOR NPN SI TO-39 PD=1W FT=150MHZ	28480	1854-0523
A1Q11	1854-0523	1	TRANSISTOR NPN SI TO-39 PD=1W FT=150MHZ	28480	1854-0523
A1Q12	1853-0038		TRANSISTOR PNP SI TO-39 PD=1W FT=100MHZ	28480	1853-0038
A1Q13	1854-0019	1	TRANSITION NPN SI TO-18 PD=360MW	07933	RT 2849
A1Q14	1853-0038		TRANSISTOR PNP SI TO-39 PD=1W FT=100MHZ	28480	1853-0038
A1Q15	1854-0419	1	TRANSISTOR NPN SI TO-39 PD=1W FT=200MHZ	28480	1854-0419
A1Q16	1854-0215		TRANSISTOR NPN SI PD=350MW FT=300MHZ	28480	1854-0215
A1R1	0684-3331	6	RESISTOR 33K 10% .25W FC TC=-400/+800	28480	0684-3331
A1R2	0684-3331		RESISTOR 33K 10% .25W FC TC=-400/+800	28480	0684-3331
A1R3	0757-0706	3	RESISTOR 51.1 1% .25W F TC=0+-100	28480	0757-0706
A1R4	0757-0487		RESISTOR 825K 1% .125W F TUBULAR	28480	0757-0487
A1R5	0757-0472	2	RESISTOR 200K 1% .125W F TC=0+-100	28480	0757-0472
A1R6	0684-2211		RESISTOR 220 10% .25W FC TC=-400/+800	01121	C82211
A1R7	2100-0554	3	RESISTOR-TRMR 500 10% C TOP ADJ 1-TRN	32997	3386P-Y46-501
A1R8	0683-1825		RESISTOR 1.8K 5% .25W FC TC=-400/+700	28480	0683-1825
A1R9	0684-2241	3	RESISTOR 220K 10% .25W FC TC=-800/+900	28480	0684-2241
A1R10	0757-0420		RESISTOR 750 1% .125W F TC=0+-100	16701	C4-1/8-T0-751-F
A1R11	0684-8211	3	RESISTOR 820 10% .25W FC TC=-400/+600	01121	C88211
A1R12	0757-0465		RESISTOR 100K 1% .125W F TC=0+-100	16701	C4-1/8-T0-1003-F
A1R13	2100-3211	5	RESISTOR-TRMR 1K 10% C TOP ADJ 1-TRN	32997	3386P-Y46-102
A1R14	0684-3331		RESISTOR 33K 10% .25W FC TC=-100/+800	28480	0684-3331
A1R15	0684-3331	4	RESISTOR 33K 10% .25W FC TC=-100/+800	28480	0684-3331
A1R16	0757-0706		RESISTOR 51.1 1% .25W F TC=0+-100	28480	0757-0706
A1R17	0757-0487	3	RESISTOR 825K 1% .125W F TUBULAR	28480	0757-0487
A1R18	0684-2211		RESISTOR 220 10% .25W FC TC=-400/+800	01121	C82211
A1R19	2100-0554	3	RESISTOR-TRMR 500 10% C TOP ADJ 1-TRN	32997	3386P-Y46-501
A1R20	0683-1825		RESISTOR 1.8K 5% .25W FC TC=-400/+700	28480	0683-1825
A1R21	0757-0472	2	RESISTOR 200K 1% .125W F TC=0+-100	28480	0757-0472
A1R22	0684-2241		RESISTOR 220K 10% .25W FC TC=-800/+900	28480	0684-2241
A1R23	0757-0420	1	RESISTOR 750 1% .125W F TC=0+-100	16701	C4-1/8-T0-751-F
A1R24	0684-8211		RESISTOR 820 10% .25W FC TC=-400/+600	01121	C88211
A1R25	2100-3211	1	RESISTOR-TRMR 1K 10% C TOP ADJ 1-TRN	32997	3386P-Y46-102
A1R26	0757-0465		RESISTOR 100K 1% .125W F TC=0+-100	16701	C4-1/8-T0-1003-F
A1R27	0684-1831	2	RESISTOR 18K 10% .25W FC TC=-400/+800	28480	0684-1831
A1R28	0698-0085		RESISTOR 2.61K 1% .125W F TC=0+-100	28480	0698-0085
A1R29	0757-0406	1	RESISTOR 182 1% .125W F TC=0+-100	16701	C4-1/8-T0-182R-F
A1R30	0698-0085		RESISTOR 2.61K 1% .125W F TC=0+-100	28480	0698-0085
A1R31	0684-1831	2	RESISTOR 18K 10% .25W FC TC=-400/+800	28480	0684-1831
A1R32	0698-3438		RESISTOR 147 1% .125W F TC=0+-100	28480	0698-3438
A1R33	0684-5631	4	RESISTOR 56K 10% .25W FC TC=-400/+800	01121	C85631
A1R34	0684-5631		RESISTOR 56K 10% .25W FC TC=-400/+800	01121	C85631
A1R35	0684-6811	8	RESISTOR 680 10% .25W FC TC=-400/+800	28480	0684-6811
A1R36	0684-6811		RESISTOR 680 10% .25W FC TC=-400/+800	28480	0684-6811
A1R37	0698-3175	4	RESISTOR 147K 1% .5W F TC=0+-100	28480	0698-3175
A1R38	0757-0847		RESISTOR 27.4K 1% .5W F TC=0+-100	28480	0757-0847
A1R39	0757-0847	9	RESISTOR 27.4K 1% .5W F TC=0+-100	28480	0757-0847
A1R40	0698-3175		RESISTOR 147K 1% .5W F TC=0+-100	28480	0698-3175
A1R41	0757-0290	4	RESISTOR 6.19K 1% .125W F TC=0+-100	16701	C4-1/8-T0-6191-F
A1R42	0757-0338		RESISTOR 1K 1% .25W F TC=0+-100	16701	C4-1/8-T0-1001-F
A1R43	0757-0847	5	RESISTOR 27.4K 1% .5W F TC=0+-100	28480	0757-0847
A1R44	0757-0290		RESISTOR 6.19K 1% .125W F TC=0+-100	16701	C4-1/8-T0-6191-F
A1R45	0757-0338	RESISTOR 1K 1% .25W F TC=0+-100	16701	C4-1/8-T0-1001-F	

See introduction to this section for ordering information

Table 6-2. Replaceable Parts (Cont'd)

Reference Designation	HP Part Number	Qty	Description	Mfr Code	Mfr Part Number
A1R46	0757-0847		RESISTOR 27.4K 1% .5W F TC=0+-100	28480	0757-0847
A1R47	0698-3438		RESISTOR 147 1% .125W F TC=0+-100	28480	0698-3438
A1R48	0684-5631		RESISTOR 56K 10% .25W FC TC=-400/+800	01121	CB5631
A1R49	0684-5631		RESISTOR 56K 10% .25W FC TC=-400/+800	01121	CB5631
A1R50	0684-6811		RESISTOR 680 10% .25W FC TC=-400/+800	28480	0684-6811
A1R51	0684-6811		RESISTOR 680 10% .25W FC TC=-400/+800	28480	0684-6811
A1R52	0698-3175		RESISTOR 147K 1% .5W F TC=0+-100	28480	0698-3175
A1R53	0757-0847		RESISTOR 27.4K 1% .5W F TC=0+-100	28480	0757-0847
A1R54	0757-0847		RESISTOR 27.4K 1% .5W F TC=0+-100	28480	0757-0847
A1R55	0698-3175		RESISTOR 147K 1% .5W F TC=0+-100	28480	0698-3175
A1R56	0757-0290		RESISTOR 6.19K 1% .125W F TC=0+-100	16701	C4-1/8-T0-6191-F
A1R57	0757-0338		RESISTOR 1K 1% .25W F TC=0+-100	16701	C4-1/8-T0-1001-F
A1R58	0757-0847		RESISTOR 27.4K 1% .5W F TC=0+-100	28480	0757-0847
A1R59	0757-0290		RESISTOR 6.19K 1% .125W F TC=0+-100	16701	C4-1/8-T0-6191-F
A1R60	0757-0338		RESISTOR 1K 1% .25W F TC=0+-100	16701	C4-1/8-T0-1001-F
A1R61	0757-0847		RESISTOR 1K 1% .25W F TC=0+-100	28480	0757-0847
A1R62	0684-1231		RESISTOR 12K 10% .25W FC TC=-400/+800	28480	0684-1231
A1R63	0757-0706		RESISTOR 51.5 1% .25W F TC=0+-100	28480	0757-0706
A1R64	0684-2241		RESISTOR 220K 10% .25W FC TC=-800/+900	28480	0684-2241
A1R65	0684-2211	1	RESISTOR 220 10% .25W FC TC=-400/+800	01121	CB2211
A1R66	0684-1051	1	RESISTOR 1M 10% .25W FC TC=-800/+900	01121	CB1051
A1R67	2100-0554		RESISTOR-TRMR 500 10% C TOP ADJ 1-TRN	32997	3386P-Y46-501
A1R68	0683-1825		RESISTOR 1.8K 5% .25W FC TC=-400/+700	28480	0683-1825
A1R69	0684-3331		RESISTOR 33K 10% .25W FC TC=-400/+800	28480	0684-3331
A1R70	2100-3211		RESISTOR-TRMR 1K 10% C TOP ADJ 1-TRN	32997	3386P-Y46-102
A1R71	0684-3331		RESISTOR 33K 10% .25W FC TC=-400/+800	28480	0684-3331
A1R72	0757-0419	2	RESISTOR 681 1% .125W F TC=0+-100	16701	C4-1/8-T0-681R-F
A1R73	0757-0419		RESISTOR 681 1% .125W F TC=0+-100	16701	C4-1/8-T0-681R-F
A1R74	2100-3211		RESISTOR-TRMR 1K 10% C TOP ADJ 1-TRN	32997	3386P-Y46-102
A1R75	2100-3211		RESISTOR-TRMR 1K 10% C TOP ADJ 1-TRN	32997	3386P-Y46-102
A1R76	0684-1011	1	RESISTOR 100 10% .25W FC TC=-400/+800	01121	CB1011
A1R77	0684-3311	4	RESISTOR 330 10% .25W FC TC=-400/+800	01121	CB3311
A1R78	0757-0190	2	RESISTOR 20K 1% .5W F TC=0+-100	28480	0757-0190
A1R79	0757-0761	1	RESISTOR 22.1K 1% .25W F TC=0+-100	16701	C5-1/4-T0-2212-F
A1R80	0757-0847		RESISTOR 27.4K 1% .5W F TC=0+-100	28480	0757-0847
A1R81	0761-0070	1	RESISTOR 8.2 K 5% 1W MO TC=0+-200	28480	0761-0070
A1R82	0757-0190		RESISTOR 20K 1% .5W F TC=0+-100	28480	0757-0190
A1R83	0757-0433	2	RESISTOR 3.32K 1% .125W F TC=0+-100	24546	C4-1/8-T0-3321-F
A1R84	0684-3311		RESISTOR 330 10% .25W FC TC=-400/+800	01121	CB3311
A1R85	0757-0420		RESISTOR 750 1% .125W F TC=0+-100	16701	C4-1/8-T0-751-F
A1R86	0684-3331		RESISTOR 33K 1% .125W F TC=0+-100	24546	C4-1/8-T0-3302-F
A1S1	3101-2159	1	SWITCH ASSY-5 SPST	28480	3101-2159
A1S2	3101-2268	2	SWITCH ASSY-8 POS	28480	3101-2268
A1S3	3101-2268		SWITCH ASSY-8 POS	28480	3101-2268
A1VR1	1902-0025	1	DIODE-ZNR 10V 5% D0-7 PD=.4W TC=+.06%	04713	SZ10939-182
A1VR2	1902-3139	3	DIODE-ZNR 8.25V 5% D0-7 PD=.04W TC=+.053%	04713	SZ10939-156
THRU					
A1VR4					
A1VR5	1902-0074	1	DIODE-ZNR 7.15V 5% D0-7 PD=.04W TC=+.047%	04713	SZ10939-140
A1XA1	1200-0624	2	IC SOCKET 40-PIN DIP	28480	1200-0624
A1XA2	1200-0624		IC SOCKET 40-PIN DIP	28480	1200-0624
A2	01340-66502		BOARD ASSEMBLY-LOW-VOLTAGE POWER SUPPLY (NOT SUPPLIED WITH OPTION 002)	28480	01340-66502
A2C1	0180-2843	1	CAPACITOR-FXD 70 UF 300VDC	28480	0180-2843
A2C2	0160-0168	1	CAPACITOR-FXD .1 UF +-10% 200VDC POLYE	06001	AE22C104KT
A2C3	0180-2351	2	CAPACITOR-FXD 2000 UF +75-10% 50VDC AL	56289	39D243-DSB
A2C4	0180-0291	1	CAPACITOR-FXD 1 UF +-10% 35VDC TA	28480	0180-0291
A2C5	0180-2351		CAPACITOR-FXD 2000 UF +75-20% 50VDC AL	56289	39D243-DSB
A2C6	0140-0196	1	CAPACITOR-FXD 150 PF +-5% 300VDC MICA 0+70	28480	0140-0196
A2C7	0180-0195	2	CAPACITOR-FXD .33 UF +-20% 35VDC TA	28480	0180-0195
A2C8	0180-0195		CAPACITOR-FXD .33 UF +-20% 35VDC TA	28480	0180-0195
A2CR1	1906-0006	3	DIODE-FW BRDG 400V 1A	28480	1906-0006
A2CR2	1901-0028		DIODE-PWR RECT 400V 750MA D0-29	0271C	MP493
A2CR3	1901-0028		DIODE-PWR RECT 400V 750MA D0-29	0271C	MP493
A2CR4	1906-0006		DIODE-FW BRDG 400V 1A	28480	1906-0006
A2CR5	1906-0006		DIODE-FW BRDG 400V 1A	28480	1906-0006
A2CR6	1901-0028		DIODE-PWR RECT 400V 750MA D0-29	0271C	MP493
A2CR7	1901-0028		DIODE-PWR RECT 400V 700MA D0-29	0271C	MP493
A2CR8	1901-0040	1	DIODE-SWITCHING 30V 500MA 2NS D0-35	28480	1901-0040
A2F1	2110-0016	2	FUSE .6A 250V SLO-BLO 1.25 X .25 UL	6F364	MDL 6/10
A2F1	2110-0044	1	FUSE .3A 250V SLO-BLO (220V/240V OPERATION ONLY)	6F364	MDL 3/10
A2F2	2110-0016		FUSE .6A 250V SLO-BLO 1.25 X .25UL	6F364	MDL 6/10

See introduction to this section for ordering information

Table 6-2. Replaceable Parts (Cont'd)

Reference Designation	HP Part Number	Qty	Description	Mfr Code	Mfr Part Number
A2F3	2110-0011	1	FUSE .062A 250V NORM-BLO 1.25 X .25 UL	6F364	AGC 1/16
A2J1	1200-0690	3	SOCKET-TSTR	28480	1200-0690
A2J2	1200-0690		SOCKET-TSTR	28480	1200-0690
A2J3	1200-0690		SOCKET-TSTR	28480	1200-0690
A2MP1	2110-0269	6	CLIP-FUSE	28480	2110-0269
A2MP2	5041-0565	1	CAP-ON/OFF SWITCH	28480	5041-0565
A2P1	1251-4743	1	CONNECTOR-AC POWER	28480	1251-4743
A2P2	1251-5099	2	CONNECTOR-8 PIN M	28480	1251-5099
A2P3	1251-5090	1	CONNECTOR-13 PIN M	28480	1251-5090
A2Q1	1854-0071	1	TRANSISTOR NPN SI PD=300MW FT=200MHZ	01295	SKA1124
A2Q2			NOT ASSIGNED		
A2Q3	1853-0336	1	TRANSISTOR PNP SI PD=625MW FT=50MHZ	28480	1853-0336
A2Q4	1854-0575	1	TRANSISTOR NPN SI PD=625MW FT=50MHZ	28480	1854-0575
A2Q5	1854-0053	2	TRANSISTOR NPN 2N2218 SI T0-5 PD=800MW	28480	1854-0053
A2Q6	1854-0053		TRANSISTOR NPN 2N2218 SI T0-5 PD=800MW	28480	1854-0053
A2R1	0690-1841	1	RESISTOR 180K 10% 1W CC TC=0+882	01121	GB1841
A2R2	0683-1005	1	RESISTOR 10 5% .25W FC TC=-400/+500	01121	CB1005
A2R3	0684-8211	1	RESISTOR 820 10% .25W FC TC=-400/+600	01121	CB8211
A2R4	0757-0777	1	RESISTOR 121K 1% .25W F TC=0+-100	16701	C5-1/4-T0-1213-F
A2R5	0757-0443	1	RESISTOR 11K 1% .125W F TC=0+-100	16701	C4-1/8-T0-1102-F
A2R6	0684-3941	1	RESISTOR 390K 10% .25W FC TC=-800/+900	01121	CB3941
A2R7	0683-8225	2	RESISTOR 8.2K 5% .25W FC TC=-400/+700	01121	CB8225
A2R8	0698-3618	1	RESISTOR 82 5% 2W MO TC=0+-200	28480	0698-3618
A2R9	0687-5611	2	RESISTOR 560 10% .5W CC TC=0+529	01121	EB5611
A2R10	0684-2701	1	RESISTOR 27 10% .25W FC TC=-400/+500	-1121	CB2701
A2R11	0683-8225	1	RESISTOR 8.2K 5% .25W FC TC=-400/+700	01121	CB8225
A2R12	0687-5611	1	RESISTOR 560 10% .5W CC TC=0+529	01121	EB5611
A2R13	0764-0013	1	RESISTOR 56 5% 2W MO TC=0+-200	28480	0764-0013
A2R14	0687-1021	1	RESISTOR 1K 10% .5W CC TC=0+647	01121	FB1021
A2R15	2100-3273	1	RESISTOR-TRMR 2K 10% C SIDE ADJ 1-TRN	92507	3386X-Y46-202
A2R16	0757-0801	1	RESISTOR 150 1% .5W F TC=0+-100	28480	0757-0801
A1R17	0757-1001	1	RESISTOR 56.2 1% .5W F TC=0+-100	28480	0757-1001
A2R18	0683-0275	1	RESISTOR 2.7 5% .25W FC TC=-400/+500	01121	CB27G5
A2S1	3101-2252	1	SWITCH-PB	28480	3101-2252
A2VR1	1902-0188	1	DIODE-ZNR 4.12V 5% D0-7 PD=.4W TC=-.041%	04713	SZ10939-71
A2VR2	1902-0041	1	DIODE-ZNR 5.11V 5% D0-7 PD=.4W TC=-.009%	04713	SZ10939-98
A2VR3	1902-0048	1	DIODE-ZNR 6.81V 5% D0-7 PD=.4W TC=+.043%	04713	SZ10939-134
A2VR4	1902-0668	2	DIODE-ZNR 200V 5% D0-15 PD=1W TC=+.088%	04713	SZ11213-449
A2W1	8120-2602	2	CABLE-FLEXIBLE	28480	8120-2602
A3	01340-66503	1	BOARD ASSEMBLY-HIGH-VOLTAGE POWER SUPPLY	28480	01340-66503
A3A1	01340-61101	1	TRANSFORMER-HIGH VOLTAGE	28480	01340-61101
A3A1C1	0160-2264	1	CAPACITOR-FXD 20 PF +-5% 500VDC CER 0+-30	28480	0160-2264
A3A1CR1	1901-0683	1	DIODE-HV RECT 10KV 5MA 250NA	28480	1901-0683
A3A2	0960-0490	1	MULTIPLIER-HIGH VOLTAGE	28480	0960-0490
A3C1	0160-0162	1	CAPACITOR-FXD .022 UF +-10% 200VDC POLYE	06001	AE17C223KT
A3C2	0160-3558	1	CAPACITOR-FXD .1 UF +-20% 50VDC CER	28480	0160-3558
A3C3	0160-4051	4	CAPACITOR-FXD .01 UF +-20% 4KVDC	56289	430P103040
A3C4	0160-4051		CAPACITOR-FXD .01 UF +-20% 4KVDC	56289	430P103040
A3C5	0160-3453	1	CAPACITOR-FXD .05 UF +80-20% 100VDC CER	56289	C023B101H203MS25-CDH
A3C6	0160-0684	2	CAPACITOR-FXD 1000 PF +-20% 4KVDC	56289	430P102040
A3C7	0160-0684		CAPACITOR-FXD 1000 PF +-20% 4KVDC	56289	430P102040
A3C8	0160-4051		CAPACITOR-FXD .01 UF +-20% 4KVDC	56289	430P103040
A3C9	0160-3665		CAPACITOR-FXD .01 UF +80-20% 500VDC CER	28480	0160-3665
A3C10	0180-0269	1	CAPACITOR-FXD .1 UF +75-10% 150VDC AL	56289	30D105G1508AZ-DSM
A3C11	0160-4051		CAPACITOR-FXD .01 UF +-20% 4KVDC	56289	430P103040
A3C12	0160-3665		CAPACITOR-FXD .01 UF +80-20% 500VDC CER	28480	0160-3665
A3C13	0160-3665		CAPACITOR-FXD .01 UF +80-20% 500VDC CER	28480	0160-3665
A3C14	0180-0141	1	CAPACITOR-FXD 50 UF +75-10% 50VDC AL	56289	30D506G050DD2-DSM
A3CR1	1901-0028		DIODE-PWR RECT 400V 750MA D0-29	28480	1901-0028
A3CR2	1901-0028		DIODE-PWR RECT 400V 750MA D0-29	28480	1901-0028
A3CR3	1901-0040	2	DIODE-SWITCHING 30V 50MA 2NS D0-35	28480	1901-0040
A3CR4	1901-0040		DIODE-SWITCHING 30V 50MA 2NS D0-35	28480	1901-0040
A3CR5			DELETED		
A3CR6	1901-0028		DIODE-PWR RECT 400V 750MA D0-29	28480	1901-0028
A3CR7	1901-0028		DIODE-PWR RECT 400V 750MA D0-29	28480	1901-0028
A3CR8	1901-0028		DIODE-PWR RECT 400V 750MA D0-29	28480	1901-0028
A3CR9	1901-0028		DIODE-PWR RECT 400V 750MA D0-29	28480	1901-0028
A3DS1	2140-0018	2	LAMP-GLOW A9A-C 90/58 VDC 700UA T-2 BULB	74276	C7A (NE-2D)
A3DS2	2140-0018		LAMP-GLOW A9A-C 90/58 VDC 700UA T-2 BULB	74276	C7A (NE-2D)
A3J1	1251-5112	1	CONNECTOR-3 PIN F	28480	1251-5112
A3L1	9140-0115	1	COIL-MLD 22 UH 10% Q=60 .215 DX .56 LG	99800	1537-36
A3L2	9140-0129	1	COIL-MLD 220 UH 5% Q=65 .155 DX .375 LG	99800	1537-92

See introduction to this section for ordering information

Table 6-2. Replaceable Parts (Cont'd)

Reference Designation	HP Part Number	Qty	Description	Mfr Code	Mfr Part Number
A3P1	1251-4316	1	CONNECTOR-7 CONT M	28480	1251-4316
A3R1	0757-0194	1	RESISTOR 1.33M 1% .5W F TC=0+-100	28480	0757-0194
A3R2	2100-3357	3	RESISTOR-TRMR 500K 10% C SIDE ADJ 1-TRN	32997	3386X-Y46-504
A3R3	0757-0465	1	RESISTOR 100K 1% .125W F TC=0+-100	16701	C4-1/8-T0-1003-F
A3R4	0683-2265	1	RESISTOR 22M 5% .25W FC TC=-900/+1200	01121	CB2265
A3R5	0684-1011	1	RESISTOR 100 10% .25W FC TC=-400/+500	01121	CB1011
A3R6	0687-3911	1	RESISTOR 390 10% .25W CC TC=0+529	01121	CB3911
A3R7	0757-0465	1	RESISTOR 100K 1% .125W F TC=0+-100	16701	C4-1/8-T0-1003-F
A3R8	0684-4731	1	RESISTOR 47K 10% .25W FC TC=-400/+800	01121	CB4731
A3R9	0684-2221	1	RESISTOR 2.2K 10% .25W FC TC=-400/+700	01121	CB2221
A3R10	0684-5621	1	RESISTOR 5.6K 10% .25W FC TC=-400/+700	01121	CB5621
A3R11	0687-3941	1	RESISTOR 390K 10% .5W CC TC=0+882	01121	EB3941
A3R12	0684-1001	1	RESISTOR 10 10% .25W FC TC=-400/+500	01121	CB1001
A3R13	0698-8689	1	RESISTOR 20M 5% 1W CF TC=0-3500	03888	PVC 70
A3R14	0684-6811	1	RESISTOR 680 10% .25W FC TC=-400/+800	28480	0684-6811
A3R15	0684-1061	1	RESISTOR 10M 10% .25W FC TC=-900/+1100	01121	CB1061
A3R16	0684-6811	1	RESISTOR 680 10% .25W FC TC=-400/+800	28480	0684-6811
A3R17	0684-6811	1	RESISTOR 680 10% .25W FC TC=-400/+800	28480	0684-6811
A3R18	0684-6811	1	RESISTOR 680 10% .25W FC TC=-400/+800	28480	0684-6811
A3R19	0757-0452	1	RESISTOR 27.4K 1% .125W F TC=0+-100	16701	C4-1/8-T0-2742-F
A3R20	0757-0446	1	RESISTOR 15K 1% .125W F TC=0+-100	16701	C4-1/8-T0-1502-F
A3R21	0698-8770	1	RESISTOR 3M 5% 1W CF TC=0-2000	03888	PVC 70
A3R22	2100-3358	1	RESISTOR-TRMR 1M 20% C SIDE ADJ 1-TRN	73138	72-154-0
A3R23	0698-6441	1	RESISTOR 6.5M 5% 1W CF TC=0-2000	03888	PVC 70
A3R24	2100-3357	1	RESISTOR-TRMR 500K 10% C SIDE ADJ 1-TRN	32997	3386X-Y46-504
A3R25	2100-3357	1	RESISTOR-TRMR 500K 10% C SIDE ADJ 1-TRN	32997	3386X-Y46-504
A3R26	0684-1021	1	RESISTOR 1K 10% .25W FC TC=-400/+800	01121	CB1021
A3U1	1826-0167	1	IC OP AMP	28480	1826-0167
A3VR1	1902-0175	1	DIODE-ZNR 100V 5% D0-15 PD=1W TC=+.083%	04713	SZ11213-403
A3VR2	1902-0668	1	DIODE-ZNR 200V 5% D0-15 PD=1W TC=+.088%	04713	SZ11213-449
A3VR3	1902-3402	1	DIODE-ZNR 80.6V 2% D0-7 PD=.4W TC=+.081%	04713	SZ10939-444
A3W1	8120-2602	1	CABLE-FLEXIBLE	28480	8120-2602
A4	01340-66504	1	BOARD ASSEMBLY-CONTROL (NOT SUPPLIED WITH OPTION 001)	28480	01340-66504
A4DS1	1990-0521	1	DIODE, LIGHT-EMITTING-GRN	28480	1990-0521
A4R1	2100-3692	3	RESISTOR-VAR 5K (INTENSITY)	28480	2100-3692
A4R2	2100-3690	1	RESISTOR-VAR 5K (TRACE ALIGN)	28480	2100-3690
A4R3	2100-3691	1	RESISTOR-VAR 1M (FOCUS)	28480	2100-3691
A4R4	2100-3689	2	RESISTOR-VAR 1K (X GAIN)	28480	2100-3689
A4R5	2100-3692	1	RESISTOR-VAR 5K (X POSITION)	28480	2100-3692
A4R6	2100-3689	1	RESISTOR-VAR 1K (Y GAIN)	28480	2100-3689
A4R7	2100-3692	1	RESISTOR-VAR 5K (Y POSITION)	28480	2100-3692
A4R8	0757-0338	1	RESISTOR 1K 1% .25W F TC=0+-100	16701	C5-1/4-T0-1001-F
A4R9	0684-2711	1	RESISTOR 270 10% .25W FC TC=-400/+800	01121	CB2711
A4R10	0684-2711	1	RESISTOR 270 10% .25W FC TC=-400/+800	01121	CB2711
A4W1	8120-0622	1	CABLE ASSY-RIBBON	28480	8120-0622
A5	01340-66506	1	BOARD ASSEMBLY-DC POWER (OPTION 002 ONLY)	28480	01340-66506
A5C1	0160-3443	1	CAPACITOR-FXD .1UF +80-20% 50WVDC CER	28480	0160-3443
A5C2	0160-0207	1	CAPACITOR-FXD .01UF +-5% 200VDC POLYE	06001	AE13C103JT
A5C3	0160-3448	1	CAPACITOR-FXD 1000PF +-10% 1KVDC CER	56289	C0168102F471L25-CDH
A5C4	0180-1819	1	CAPACITOR-FXD 100UF +75-10% 50VDC AL	56289	300107G050DH2-DSM
A5C5	0180-2843	1	CAPACITOR-FXD 70UF 300VDC	28480	0180-2843
A5C6	0180-0195	1	CAPACITOR-FXD .33UF +-20% 35VDC TA	28480	0180-0195
A5C7	0180-0291	2	CAPACITOR-FXD 1UF +-10% 35VDC TA	28480	0180-0291
A5C8	0180-0291	1	CAPACITOR-FXD 1UF +-10% 35VDC TA	28480	0180-0291
A5CR1	1901-0669	2	DIODE-PWR RECT 400V 1A 150NS	28480	1901-0669
A5CR2	1901-0669	1	DIODE-PWR RECT 400V 1A 150NS	28480	1901-0669
A5CR3	1901-0028	1	DIODE-PWR RECT 400V 750MA D0-29	28480	1901-0028
A5CR4	1901-0040	1	DIODE-SWITCHING 30V 50MA 2NS D0-35	01295	PG512
A5F1	2110-0080	1	FUSE .75AT 250V SLO-BLO 1.25 X .25 UL IEC	6F364	MDL 3/4
A5F2	2110-0020	1	FUSE .8AT 250V SLO-BLO 1.25 X .25 UL	6F364	MDL 8/10
A5F3	2110-0004	1	FUSE .25A 250V FAST-BLO 1.25 X .25 UL	6F364	AGC-1/4
A5J1	1251-5112	2	SOCKET-TSTR	27264	09-52-3001
A5J2	1251-5112	1	SOCKET-TSTR	27264	09-52-3001
A5J3	1200-0690	1	SOCKET-TSTR	28480	1200-0690
A5L1	9100-3139	1	COIL 75UH 15% .5D X .875 LG	28480	9100-3139
A5L2	9140-0137	1	COIL MLD 1MH 5% Q=60	28480	9140-0137
A5P1	1251-3195	1	CONNECTOR-4 PIN M POST TYPE	27264	09-60-1041
A5Q1	1854-0433	2	TRANSISTOR NPN SI SPEC	28480	1854-0433
A5Q2	1854-0433	1	TRANSISTOR NPN SI SPEC	28480	1854-0433
A5Q3	1854-0053	2	TRANSISTOR NPN 2N2218 SI T0-5 PD=800MW	28480	1854-0053
A5Q4	1854-0053	1	TRANSISTOR NPN 2N2218 SI T0-5 PD=800MW	28480	1854-0053
A5R1	0757-0780	1	RESISTOR 182K 1% .25W F TC=0+-100	28480	0757-0780
A5R2	2100-3351	1	RESISTOR-TRMR 500 10% C SIDE ADJ 1-TRN	28480	2100-3351
A5R3	0757-0431	1	RESISTOR 2.43K 1% .125W F TC=0+-100	28480	0757-0431

See introduction to this section for ordering information

Table 6-2. Replaceable Parts (Cont'd)

Reference Designation	HP Part Number	Qty	Description	Mfr Code	Mfr Part Number
A5R4	0757-0438	2	RESISTOR 5.11K 1% .125W F TC=0+-100	24546	C4-1/8-T0-5111-F
A5R5	0757-0438		RESISTOR 5.11K 1% .125W F TC=0+-100	24546	C4-1/8-T0-5111-F
A5R6	0698-3151	1	RESISTOR 2.87K 1% .125W F TC=0+-100	24546	C4-1/8-T0-2871-F
A5R7	0760-0014	1	RESISTOR 1K 2% 1W MO TC=0+-200	28480	0760-0014
A5R8	0757-0449	1	RESISTOR 20K 1% .125W F TC=0+-100	24546	C4-1/8-T0-2002-F
A5R9	0757-0280	2	RESISTOR 1K 1% .125W F TC=0+-100	24546	C4-1/8-T0-1001-F
A5R10	0757-0280		RESISTOR 1K 1% .125W F TC=0+-100	24546	C4-1/8-T0-1001-F
A5R11	0687-5611	2	RESISTOR 560 10% .5W CC TC=0+-100	01121	EB5611
A5R12	0698-3618	1	RESISTOR 82 5% 2W MO TC=0+-200	28480	0698-3618
A5R13	0757-0801	1	RESISTOR 150 1% .5W F TC=0+-100	28480	0757-0801
A5R14	0684-2701	1	RESISTOR 27 10% .25W FC TC=-400/+500	28480	0684-2701
A5R15	0687-5611		RESISTOR 560 10% .5W CC TC=0+-100	01121	EB5611
A5R16	0764-0013	1	RESISTOR 56 5% 2W MO TC=0+-200	28480	0764-0013
A5R17	0757-1001	1	RESISTOR 56.2 1% .5W F TC=0+-100	28480	0757-1001
A5T1	9100-XXXX		TRANSFORMER, AC	28480	9100-XXXX
A5J1	1826-0428	1	IC GENERIC	28480	1826-0428
A5J2	1826-0106	1	IC VOLT-REGULATOR	28480	1826-0106
A5VR1	1902-0188	1	DIODE-ZNR 4.12V 5% D0-7 PD=.4W TC=.041%	28480	1902-0188
A5VR2	1902-0041	1	DIODE-ZNR 5.11V 5% D0-7 PD=.4W TC=.009%	28480	1902-0041
A5VR3	1902-0048	1	DIODE-ZNR 6.81V 5% D0-7 PD=.4W TC=.043%	28480	1902-0048
A5W1	8120-2602	1	CABLE, RIBBON	15912	FSN22A-10

Table 6-3. List of Manufacturers' Codes

Mfr Code	Manufacturer Name	Address	Zip Code
01121	ALLEN BRADLEY CO	MILWAUKEE WI	53204
01538	SMALL PARTS INC	COSTA MESA CA	92626
02660	BUNKER RAMO CORP AMPHENOL CONNECTOR DIV	BROAD VIEW IL	60153
03888	PYROFILM CORP	WHIPPANY NJ	07981
04604	EAGLE CHEMICAL CO INC	CHICAGO IL	60612
04713	MOTOROLA INC SEMICONDUCTOR PRODUCT DIV	PHOENIX AZ	85008
05683	MEG PRODUCT DIV OF MANDREL INDUSTRIES INC	SEATTLE WA	98266
06001	GENERAL ELECTRIC CO CAPACITOR AND BATTERY PRODUCTS DEPT	IRMO SC	29063
07933	RAYTHEON CO SEMICONDUCTOR DIV HQ	MOUNTAIN VIEW CA	94040
16546	US CAPACITOR CORP	BURBANK CA	91504
16701	RAPITAG NEEDLE CO	LAKE WORTH FL	33460
28480	HEWLETT-PACKARD CO CORPORATE HQ	PALO ALTO CA	94304
32997	BOURNS INC TRIMPOT PROD DIV	RIVERSIDE CA	92507
56289	SPRAGUE ELECTRIC CO	NORTH ADAMS MA	01247
6F364	BUSSMAN MFG DIV OF MCGRAW-EDISON CO	ST LOUIS MO	63017
72136	ELECTRO MOTIVE MFG CO INC	WILLIMANTIC CT	06226
72962	ELASTIC STOP NUT DIVISION OF AMERACE ESNA CORP	UNION NJ	07083
73138	BECKMAN INSTRUMENTS INC HELIPOT DIV	FULLERTON CA	92634
74276	SIGNALITE INC	NEPTUNE NJ	07753
76854	OAK MFG CO DIV OF OAK ELECTRO/NETICS CORP	CRYSTAL LAKE IL	60014
78189	ILLINOIS TOOL WORKS INC SHAKEPROOF DIV	ELGIN IL	60126
79963	ZIERICK MFG CO	MT KISCO NY	10549
82099	GOODYEAR SUNDRIES AND MECHANICAL CO INC	NEW YORK NY	10013
99800	AMERICAN PRECISION INDUSTRIES INC DELEVAN DIV	EAST AURORA NY	14052

See introduction to this section for ordering information