User's Reference

Publication Number 16534-97014

March 2002

For Safety Information, Warranties, and Regulatory Information, see the pages behind the Index

© Copyright Agilent Technologies 1991 – 2002
All Rights Reserved

Agilent Technologies 16533A 1-GSa/s and 16534A 2-GSa/s Digitizing Oscilloscope (16500-series only)

The Agilent Technologies 16533/34A Digitizing Oscilloscope

The Agilent Technologies 16533/34A is a digitizing oscilloscope module for the Agilent Technologies 16500B/C logic analysis system. With a bandwidth of up to 500 MHz and a sampling rate up to 2 GSa/s, you can make accurate measurements on high speed digital circuits with rise times as fast as 1.5 ns.

When configured with other measurement modules in the 16500B/C logic analysis system, cross-domain measurements are time-correlated and displayed together on the same screen.

Memory depth of 32 KBytes per channel allows the 16533/34A to capture a sufficiently long analog record prior to trigger. A long record allows adequate time resolution to identify errors confidently.

Configuration

Either model can be used as a single-card module or in a multi-card module configuration. For each card configured into a multi-card module, you gain two signal inputs up to a maximum of eight channels (four-card module).

Compatibility

If you are upgrading from the Agilent Technologies 16532A, the following compatibility issues should be noted:

- If an 16532A file is loaded into an 16533/34A, the 16533/34A will set up identically. However, the 16532A data will not be read or displayed.
- The 16532A cannot load files that were stored from an 16533/34A.
- You cannot mix 16532A and 16533/34A cards in a multi-card module.

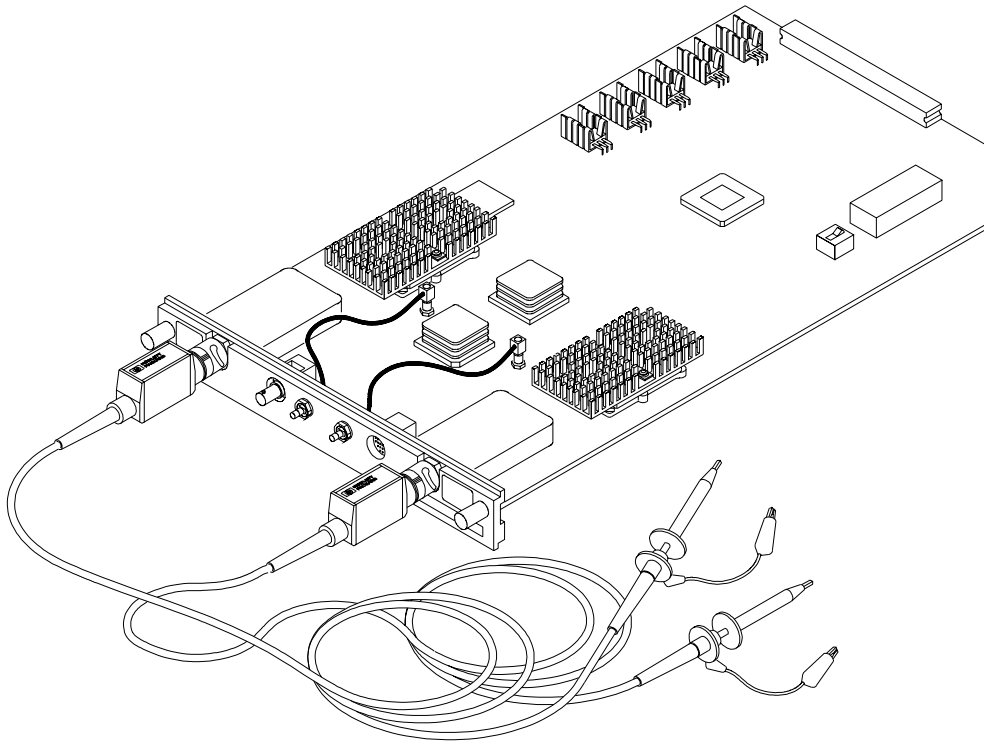

16534e03

The 16533/34A Oscilloscope

In This Book

This book provides a detailed description of the features of the 16533/34A digitizing oscilloscope modules used in a 16500-series logic analysis mainframe. (For information on using a 16533/34A oscilloscope in a 16700-series logic analysis mainframe, refer to the 16700-series logic analysis online help.) This book identifies the different menus available on the oscilloscope, and shows what options are available in the menus. It then explains what each of these options mean and what they do. The book is divided into the following chapters:

Chapter 1 describes the options for running and stopping the oscilloscope and explains single and repetitive modes of operation.

Chapter 2 describes the Autoscale function—what it does, what trigger it selects to trigger on, and what fields and menus are affected by the algorithm.

Chapter 3 describes the Channel menu options—input identification, vertical sensitivity and position, probe attenuation factor, coupling field selection, and preset values.

Chapter 4 describes time base functions—sweep speed, horizontal position, pan and zoom, and sample period display.

Chapter 5 describes time marker functions—both manual and automatic. It describes the capabilities of both manual and automatic time markers and the fields available in each, then describes the function of each of these fields. It also describes voltage markers, the fields available to them, and the function of each of these fields.

Chapter 6 describes trigger options available—immediate, pattern, and edge. It describes their use, configurations available, and the fields controlling each option.

Chapter 7 describes the display options—normal, average, and accumulate. It then explains when each is used, and what the results are when each is used.

Chapter 8 describes the Auto-Measure feature and explains the algorithm for each of the nine automatic measurements taken. The measurements taken using this feature are: frequency, period, peak-to-peak voltage, positive pulse width, negative pulse width, rise time, fall time, preshoot, and overshoot.

Chapter 9 describes the Waveform Selection menu. This menu lets you select the following modes of operation: single channel, overlay, Chan + Chan, or Chan-Chan. It also allows you to insert, replace, or delete channels from the display.

Chapter 10 gives you the specifications and characteristics for the oscilloscope.

Chapter 11 describes the module installation and bench service procedures.

The Index is an alphanumeric listing of the subject matter contained in this book.

The Glossary defines some of the common terms you will find throughout this book.

1	Run/Stop Options	
2	Autoscale	
3	The Channel Menu	
4	Time Base Functions	
5	The Marker Menu	
6	The Trigger Menu	
7	The Display Menu	
8	The Auto-Measure Menu	
9	The Waveform Selection Menu	
10	Specifications and Characteristics	
11	Installation and Operator's Service	
	Index	
	Glossary	

Contents

1 Run/Stop Options

Run/Stop Options 1-2
Autoscale Run 1-3
Run Field 1-3
Stop Field 1-4

2 Autoscale

Autoscale Field Options 2-3
Autoscale Algorithm 2-4
Menus and Fields Changed by the Autoscale Algorithm 2-6

3 The Channel Menu

Input Field 3-4
V/Div Field 3-5
Offset Field 3-6
Probe Field 3-7
Coupling Field 3-7
Preset Field 3-8

4 Time Base Functions

s/Div Field 4-3
Delay Field 4-5
Sample Period Field 4-8

5 The Marker Menu

Manual Time Markers Options 5-5
Tx to To Field 5-6
Trig to X Field 5-7
Trig to O Field 5-8
Channel Label Field 5-8
T Marker Value Display 5-9

Contents

Automatic Time Marker Options 5-10

Done Field 5-11

Set on Field 5-11

Type Field 5-11

at Level Field 5-12

Slope Field 5-13

Occur Field 5-13

Statistics Field 5-14

Run Until Time X-O Field 5-15

Manual/Automatic Time Markers Option 5-17

Setting the Manual/Automatic Time Markers Option 5-17

Voltage Markers Options 5-18

Va On Field 5-19

Va Volts Field 5-19

Vb On Field 5-20

Vb Volts Field 5-20

Va to Vb Field 5-21

Center Screen Field 5-21

V Marker Value Display 5-22

6 The Trigger Menu

Trigger Marker 6-4

Edge Trigger Mode 6-5

Source Field 6-6

Level Field 6-7

Slope Field 6-9

Count Field 6-9

Auto-Trig Field 6-10

Pattern Trigger Mode 6-11

Channel/Pattern Field 6-12

When Field 6-13
Count Field 6-16
Auto-Trig Field 6-17

Immediate Trigger Mode 6-18

Intermodule Measurements 6-19

7 The Display Menu

Mode Field 7-4
Connect Dots Field 7-6
Grid Field 7-7
Acquisition Time Field 7-8
Display Options Field 7-8

8 The Auto-Measure Menu

Automatic-Measurement Fields 8-4

Input Field 8-4

Automatic Measurements Display 8-4

Automatic Measurement Prerequisites 8-5

Measurement Setup Requirements 8-5

Criteria Used for Making Automatic Measurements 8-6

Automatic Measurement Algorithms 8-7

Top and Base Voltages 8-7

Measurement Algorithms 8-8

9 The Waveform Selection Menu

Module Field 9-4

Channel Mode Field 9-5

Action Field 9-9

Delete All Field 9-10

Delete Field 9-10
Labels Field 9-10
Waveform Size Field 9-11
Done Field 9-11



10 Specifications and Characteristics

Operating System 10-3
Specifications 10-3
Characteristics 10-4
Supplemental Characteristics 10-6

11 Installation and Operator's Service

To inspect the module 11-3
To prepare the mainframe 11-3

To install the module 11-5
To configure the 16533/34A module 11-6
To reconfigure a multi-card module into single-card modules 11-8
To turn on the system 11-8
To test the module 11-8
To clean the module 11-8

Calibrating and Adjusting 11-9
Calibration frequency 11-9
Multi-card oscilloscope calibration 11-9

To calibrate the oscilloscope 11-10
Set up the equipment 11-10
Self Cal menu calibrations 11-12
Protect the operational accuracy calibration factors 11-15



Run/Stop Options

Run/Stop Options

When you first turn on the Logic Analysis System, all of the modules installed in the mainframe are inactive (that is, not running). Making the module inactive at system start-up prevents any unwanted interaction between the modules.

This chapter describes how to manually start the oscilloscope running. You can cause the oscilloscope to run automatically in an intermodule measurement setup. For information on intermodule measurements, refer to the "Intermodule Measurements" chapter in the *Agilent Technologies 16500B/16501A Logic Analysis System User's Reference* or the "Correlating Measurements" chapter in the *Agilent Technologies 16500C/16501A Logic Analysis System User's Reference*.

Manually running or stopping the oscilloscope is controlled by the Run/Stop field. All of the run and stop options are explained in this chapter. The Run/Stop field is in the upper-right corner of all oscilloscope menus.

Remember, when the Run/Stop field displays Run, the oscilloscope is stopped. You touch the Run field to start the oscilloscope running. Likewise, when the Run/Stop field displays Stop, the oscilloscope is running. You touch the Stop field to stop the oscilloscope. In short, the Run/Stop field displays your next option—not the action taking place.



Autoscale Run

You can use the autoscale feature to cause the oscilloscope to run. You may want to use this method when you have changed one or more of the signal input parameters and want to get back to a basic screen presentation of your waveform. Touch the Autoscale field on the screen, then select Continue from the pop-up menu. When autoscaling is complete, the oscilloscope automatically starts running. It will run in the mode (single or repetitive) that was last selected using the Run field menu options. If no run mode is selected prior to selecting autoscale, the run mode defaults to single mode.

Run Field

When the green Run field is displayed, the oscilloscope is stopped. Touching the Run field, then removing your finger from the screen, starts the oscilloscope running. The oscilloscope runs using the parameters that are currently set. Additionally, it runs in the mode (single or repetitive) that was last selected. If no run mode is selected prior to selecting a run, the run mode defaults to single mode.

When you touch and hold your finger on the Run field, a pop-up menu appears. The pop-up contains the selections Single, Repetitive, and Cancel. To select one of the options, slide your finger down the screen until it is over the option you want to select, then remove your finger from the screen. These options are described in the following paragraphs.

Single Mode Option

When the system is turned on, the oscilloscope defaults to the Single mode. Single-mode acquisition fills acquisition memory once with 32768 samples of the input waveform, automatically stops running, then displays the contents of acquisition memory. Each 32768-sample waveform record is acquired in a single acquisition.

Stop Field

To start the oscilloscope running in the single-mode after it has been running in repetitive mode, touch the green Run field. Slide your finger down to the Single field in the pop-up until the Single field turns white, then remove your finger from the screen. This starts the oscilloscope running in the Single mode. When single-shot acquisition is in process, the Run/Stop field will display Stop. When the acquisition is complete, the field display changes to Run. In Single mode, the oscilloscope makes a single acquisition and displays the results. The oscilloscope then waits until the Run field is touched again before making another acquisition.

Repetitive Mode Option

Repetitive mode acquisition fills acquisition memory with 32768 samples of the input waveform on continuing acquisitions. The display is updated each time a new acquisition is made. Repetitive mode continues acquiring data in this manner until you touch the Stop field. As in single mode, each 32768-sample waveform record is acquired in a single acquisition.

To start the oscilloscope running in the repetitive mode after it has been running in single mode, touch the green Run field. Slide your finger down to the Repetitive field in the pop-up until the Repetitive field turns white, then remove your finger from the screen. This starts the oscilloscope running in the Repetitive mode. While the real-time repetitive acquisitions are being made, the Run/Stop field will display Stop. When you want to stop making repetitive acquisitions, touch the Stop field. To resume making repetitive acquisitions, touch the Run field again.

Cancel Option

If you select the Cancel field in the pop-up, the oscilloscope returns to the state it was in before the Run field was touched. That is, it is stopped in either single or repetitive mode, whichever mode was selected last.

Stop Field

When the red Stop field is displayed, the oscilloscope is running. Touch the Stop field to cause the oscilloscope to stop running.



Autoscale

Autoscale

Autoscale is an algorithm built into the oscilloscope that automatically optimizes the display of one or more waveforms. When you touch the Autoscale field and select Continue, the autoscale algorithm starts, and the screen displays the advisory message "Autoscale is in progress."

This chapter discusses how the autoscale algorithm works. It also discusses what fields are affected by the autoscale algorithm.

Autoscale Field Options

The Autoscale field is displayed in the top row of menu fields on every oscilloscope menu.

When you touch the Autoscale field, a pop-up appears that allows you to cancel or continue the autoscale.

Cancel

If you accidentally touch the Autoscale field, you can touch the Cancel field in the pop-up menu to cancel the autoscale process. The cancel feature keeps you from inadvertently changing your oscilloscope setup.

Continue

When you touch the Continue field, the autoscale algorithm starts, and the screen displays the advisory message "Autoscale is in progress." Once the autoscale operation begins, it cannot be canceled.

Autoscale Algorithm

This section describes what the autoscale algorithm does when a signal, or signals, is present at the oscilloscope inputs. It also describes what occurs when signals are not present at the oscilloscope inputs.

What the Autoscale Algorithm Does When a Signal is Found

The autoscale algorithm first checks all input channels to determine whether or not there are any signals present. The vertical scaling is then set as required for each channel. Next the time base is scaled for a single input channel. Finally, the trigger channel is selected and the waveforms are displayed.

Finding the Vertical Settings The autoscale algorithm first checks all input channels to determine whether or not there are any signals present. Starting at the lowest numbered channel in the oscilloscope module, the autoscale algorithm checks for activity on that channel. It then sets the vertical scaling (V/Div and offset) appropriate to that input signal. This process is repeated for each input channel. If no activity is found on an input channel, the original (pre-autoscale) vertical settings are restored.

When all input signals have been vertically scaled, the time base settings (s/Div and delay) are scaled. The time base settings are determined based on the input signal for a single channel.

Finding the Time Base Settings The time base settings (s/Div and delay) are determined based on the input signal of the lowest numbered input channel that has been determined to have a signal present.

For example, if signals are present on both channel 1 and channel 2 inputs, the autoscale algorithm selects the signal on channel 1 input as the time base scaling source. Similarly, if a signal is present only on the channel 4 input, then the channel 4 input is selected as the time base scaling source.

The time base is scaled so that between two and five complete cycles of the source input signal can be seen on the screen. If signals of significantly different frequencies are probed by the oscilloscope, and the time base scaling is based on a slow signal, you should be aware of the possibility that the faster signals may be under-sampled and incorrectly displayed on the screen.

Displaying the Waveform When the autoscale algorithm is complete, the oscilloscope automatically starts running, and displays waveforms for the inputs that have been selected. The run mode (single or repetitive) that was selected prior to running autoscale is the run mode executed when autoscale is completed. If a run mode has not been selected prior to running autoscale, the single mode run is executed.

The channel and time base fields are updated (if necessary) to reflect any changes made by the autoscale algorithm. The trigger settings are also changed by the autoscale algorithm and an edge mode trigger with channel 1 or channel 2 is selected. The trigger source is set to channel 1 or channel 2. Even if the scaling is based on a higher-numbered channel, it will not be used as the trigger source. Instead, the trigger source will default to channel 1.

The trigger point on the waveform is determined by the trigger level set by the autoscale algorithm. The trigger point is displayed as a dotted vertical red line at the center of the screen when Delay is set to 0 s.

What the Autoscale Algorithm Does When a Signal Cannot be Found

When a signal cannot be found on any of the vertical inputs, the oscilloscope displays the advisory messages "No signal found" and "Original setup restored." The autoscale algorithm toggles the Auto-Trig field to On, which places the oscilloscope in the automatic trigger mode. The oscilloscope then displays the message "Auto triggered." The automatic trigger mode allows the oscilloscope to sweep automatically and to display a baseline anytime a trigger signal is not present.

Menus and Fields Changed by the Autoscale Algorithm

The following table shows the menus and their fields that are changed by the autoscale algorithm.

Settings Changed by Autoscale

Menu	Field	Autoscale Action
Channel	V/Div Offset	Scaled - depending on amplitude of input signal. Scaled - depending on offset of input signal.
Trigger	Mode Source Level Slope Count Auto-Trig	Defaults to Edge. Either channel 1 or channel 2. If no input signal exists for channel 1 or channel 2, it defaults to channel 1. Scaled - depending on amplitude of lowest numbered input with signal present. Defaults to Positive. Defaults to 1. Defaults to On.
All Applicable	s/Div Delay	Scaled - depending on frequency of lowest numbered input with signal present. Defaults to 0 s.



The Channel Menu

The Channel Menu

The Channel menu lets you select the channel input for the module. It lets you select values that control the vertical sensitivity, offset, probe attenuation factor, input impedance, and coupling of the input channel shown in the Input field. The Channel menu also gives you preset vertical sensitivity, offset, and trigger level values for ECL and TTL logic levels.

Channel Menu Map

The menu map on the next page illustrates all fields and the available options for the Channel menu. The menu map will help you get an overview as well as provide you with a quick reference of what the Channel menu contains.

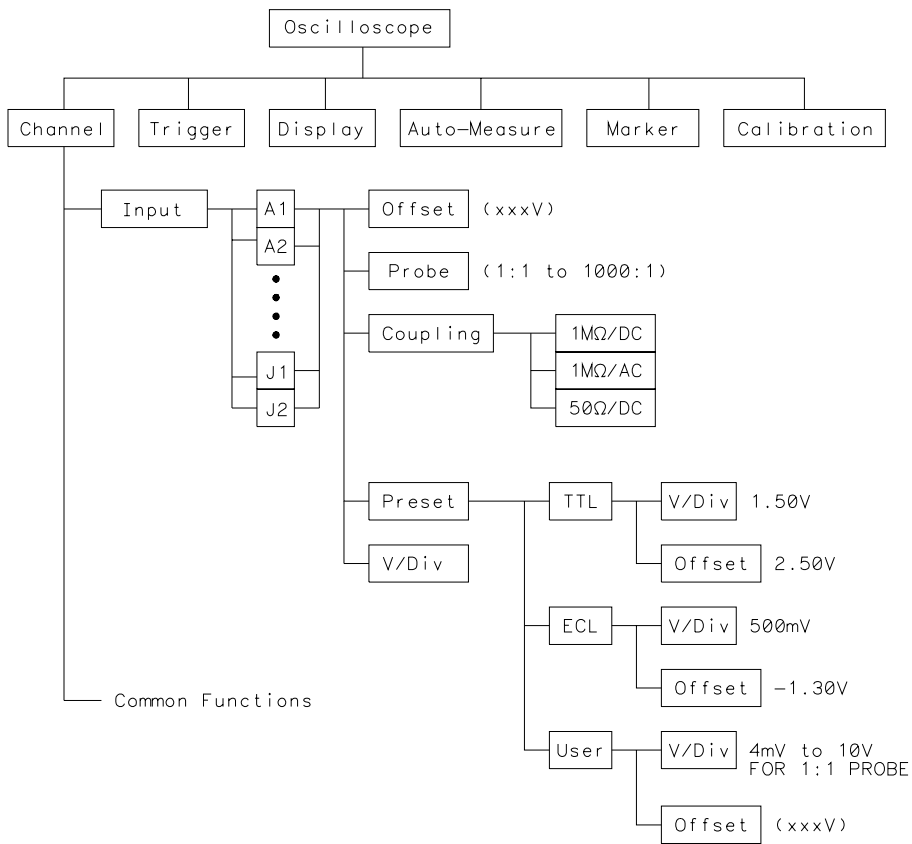

Channel Field Menu Map

Input Field

You use the Input field to select the input source for the channel parameters displayed on the Channel menu. Each channel may be set independent of all other channels.

Input Identification

When you touch the Input field, a pop-up menu appears that shows the input channels for the module. The input channels are shown as a letter/number combination: A1, for example. The letter A identifies the slot number in the mainframe which contains the card. The number 1 identifies the input connector on the rear of the card. For a two-card oscilloscope module, A1 identifies the card location as slot A and the input location as channel 1. Likewise, A2 identifies the card location as slot A and the input location as channel 2.

For oscilloscope modules installed in an Agilent Technologies 16500B/C Logic Analysis System mainframe, two inputs are available for each card.

At system turn on, the Input field defaults to the lowest lettered and numbered input for the module selected. For example, if a module is installed in slot A, the Input field will display A1.

V/Div Field

You use the V/Div field to set the vertical sensitivity for the waveform on the screen. It is set for the channel displayed in the Input field. Vertical sensitivity determines the vertical size of a waveform displayed on the screen and it is measured in volts per division. Each waveform display area is divided into four vertical divisions. The divisions are marked by small tan-colored tick marks at the left and right sides of the waveform display area.

When you select the V/Div field, you can change the vertical sensitivity by turning the knob. Turning the knob clockwise causes the waveform to expand vertically in both directions from the center of the display. Turning the knob counterclockwise causes the waveform to compress vertically in both directions toward the center of the display. As you turn the knob, the vertical sensitivity changes in a 1-2-4 sequence from 4 mV/Div to 10 V/Div (1:1 probe).

Vertical sensitivity can also be entered from the pop-up keypad. The keypad appears when you touch the V/Div field when the field is light blue. Any valid value from 4 mV/Div to 10 V/Div (1:1 probe) can be entered from the keypad. The vertical sensitivity value is set to the two most significant digits of the value entered. For example, if you enter a value of 154 mV, the value is rounded to 150 mV.

If acquisitions have been stopped (either by touching the Stop field or by a completed measurement), vertical sensitivity changes will not be reflected on the waveform until Run is touched and the next acquisition is displayed. Changes to V/Div during a repetitive run will be seen on the next displayed acquisition because the hardware is reprogrammed between acquisitions. The default value for the V/Div field is 1.5 V (TTL preset value).

Offset Field

You use the Offset field to set the vertical position of the waveform on the screen. It is set for the channel currently displayed in the Input field. Vertical position determines the vertical placement of the waveform. Offset is measured in volts. Each waveform display area is divided into four vertical divisions. The divisions are marked by small tan-colored tick marks at the left and right sides of the waveform display area.

Offset is the voltage represented at the center vertical tick mark in the waveform display. It is a dc voltage that is added to or subtracted from the input signal so that the waveform can be centered on the waveform display. Offset range and resolution are dependent on vertical sensitivity (V/Div) as shown in the table below. The table values are based on a 1:1 probe setting.

Offset Range and Resolution

V/Div Setting	Offset Range	Offset Resolution
4 mV - 100 mV/Div	± 2 V	1 mV
>100 mV - 500mV/Div	± 10 V	1 mV
>500mV - 2.5 V/Div	± 50 V	1 mV
>2.5 V - 10 V/Div	± 250 V	2 mV

When you select the Offset field, the offset value of the channel currently displayed in the Input field can be changed by turning the knob. As you turn the knob, the value in the Offset field changes, and the position of the waveform moves up or down on the waveform display. Offset works similar to the vertical position control of an analog oscilloscope, but offset is calibrated.

Any valid offset value can also be entered from the keypad. The keypad will appear when you touch the Offset field when the field is light blue. The default value for the Offset field is 2.5 V (TTL preset value).

If acquisitions have been stopped (either by touching the Stop field or by a completed measurement), offset changes will not be reflected on the waveform until Run is touched and the next acquisition is displayed. Changes to Offset during a repetitive run will be seen on the next displayed acquisition because the hardware is reprogrammed between acquisitions.

Probe Field

You use the Probe field to set the probe attenuation factor for the input channel currently displayed in the Input field.

Probe Attenuation Factor

The probe attenuation factor can be set from 1:1 to 1000:1 in increments of one. When you select the Probe field, the probe attenuation factor can be changed by turning the knob or by entering a value from the pop-up keypad. When you select a probe attenuation factor, the actual sensitivity at the input does not change. The voltage values shown on the display (V/div, offset, trigger level) are automatically adjusted to reflect the attenuation factor. The marker and automatic measurement voltage values change when Run is touched and the next acquisition is displayed. The default value for the Probe field is 10:1 for 10:1 divider probes.

Coupling Field

You use the Coupling field to set the input impedance for the channel currently displayed in the Input field.

Coupling Field Selections

When you touch the Coupling field, a pop-up appears that shows the input impedance values available for selection. The selectable values are as follows:

- 1M Ω / DC
- 1M Ω / AC
- 50 Ω / DC.

The default value for the Coupling field is 1M Ω / DC.

CAUTION

The maximum input voltage for the 50 Ω / DC Coupling field selection is 5 Vrms.

Preset Field

When you touch the Preset field, a pop-up menu appears. TTL, ECL, and User are the options available. The Preset field automatically sets offset, V/div, and trigger level values to properly display TTL and ECL logic levels. Trigger level is in the Trigger menu and can be changed only when edge trigger is the selected trigger mode.

Preset Field Values

When you select TTL or ECL, the parameters are preset to the values shown in the following table:

Preset Values

Parameter	ECL	TTL
V/Div	500 mV	1.5 V
Offset	-1.300 V	2.5 V
Trigger Level	-1.300 V	1.620 V

When any of the ECL or TTL preset values are changed from the preset values listed above, the Preset field will change to User and the new values become the new User values. The User values remain the same until you manually change the User values or you change the ECL or TTL preset values while in ECL or TTL Preset.

The default value for the Preset field is TTL.



Time Base Functions

Time Base Functions

The s/Div and Delay time base fields control the horizontal display on the oscilloscope. There are three rows of fields displayed on the oscilloscope. The s/Div and Delay fields are located in the bottom row of fields. These two fields are displayed on all of the oscilloscope menus, except for the Calibration menu.

When the s/Div is changed in a multi-card module, all channels are sampled according to the new timebase setting. When the Delay field is changed in a multi-card module, all channels are delayed according to the new delay setting.

s/Div Field

The s/Div field allows you to set the sweep speed (time scale) on the horizontal axis of the display. Sweep speed is measured in seconds per division.

Selecting Sweep Speed

The waveform display is divided into 10 horizontal divisions. The divisions are marked by small tan-colored tick marks at the top and bottom of the waveform display area.

If you have a multi-card oscilloscope configuration, the s/Div field is set on the master card. All other cards in the multi-card module will use the same s/Div setting as the master card.

When you select the s/Div field, you can change the sweep speed for the next acquisition by turning the knob. Turning the knob clockwise a small amount expands the displayed waveform horizontally in both directions from the center of the display. Turning the knob counter-clockwise a small amount compresses the displayed waveform horizontally in both directions toward the center of the display. As you turn the knob, the sweep speed changes in a 1-2-5 sequence (10.0 ns, 20.0 ns, 50.0 ns, etc.) from 1 ns/div to 5 s/div (16533A) and 500 ps/div to 5 s/div (16534A).

Sweep speed can also be entered from the pop-up keypad. The keypad appears when you touch the light-blue s/Div field. Any value from 500 ps/div to 5 s/div (16534) and 1ns to 5s/div (16533) can be entered from the keypad. Sweep speed values are rounded and then truncated to the three most significant digits. For example, if you enter a value of 15.45 ns, the value is rounded and then truncated to 15.5 ns.

At sweep speeds of 100 ms/div and slower, the time to acquire the 32768 sample points for acquisition memory is greater than 1 second. At these sweep speeds the screen displays the message "Waiting for Prestore" when acquiring the sample points prior to the trigger. It displays the message "Waiting for Poststore" when acquiring the sample points after the trigger. These messages advise you that the oscilloscope is still actively acquiring data. Acquisition time and sample rate, as they compare to sweep time, are shown in the table at the end of this chapter.

The default value for the s/Div field is 500 ns.

Zooming (Acquisition Stopped)

When acquisitions are stopped, the oscilloscope displays the sample points stored in acquisition memory on the screen. When you change the sweep speed, the new screen display is a different presentation of the data retained in acquisition memory when acquisitions were stopped. Presenting the same data in a different form (zooming) is normally used on a waveform acquired in Single mode.

Zooming while in repetitive mode will change the sample rate and the display because the hardware is reprogrammed between acquisitions in response to the new timebase settings. Zooming is done by adjusting the value in the s/Div field. It causes the waveform to either expand horizontally (decrease sweep time value) or compress horizontally (increase sweep time value).

When used in conjunction with panning (see "Delay Field"), zooming is very useful in displaying waveforms.

Delay Field

The Delay field allows you to set the horizontal position of the displayed waveform in relation to the trigger. Delay time is measured in seconds.

Setting Horizontal Position

Delay time zero is always at the trigger point of the waveform. A delay time value is the time difference measured from before or after the trigger point on the waveform (delay time zero), to the center point of the screen. In other words, delay time is always measured from the trigger point on the waveform to the center of the screen. The vertical dotted red line on the screen is the trigger point. When delay time is zero, the trigger point will be at the center of the screen.

If you have a multi-card oscilloscope configuration, the Delay field is set on the master card. All other cards in the multi-card module will use the same Delay setting as the master card.

When you select the Delay field, delay time can be changed by turning the knob. Remember that the trigger point is always delay time zero and is marked by the vertical dotted red line. When you set the delay such that the trigger point is on the right side of the screen, delay time is negative. What you will see at the center of the screen will be the result of samples taken before the trigger point. They have occurred in what is referred to as negative time.



Delay Field

When you set the delay such that the trigger point is on the left side of the screen, delay time is positive. What you will see at the center of the screen will be the result of samples taken after the trigger point. They have occurred in what is referred to as positive time.

Delay time resolution is equal to 2% of the sweep speed setting when using the knob. When using the pop-up keypad, resolution is 10 ps at sweep speeds of 99.99 ns/div and faster, and can be set to 5-digit resolution at sweep speeds of 100 ns/div and slower.

When run mode is set to Repetitive, the valid Delay range is:

Pre-trigger delay range = $16384 \times \text{sample period}$

Post-trigger delay range is equal to the following:

<u>Time/Div Setting</u>	<u>Available Delay</u>
100 ms to 5 s/div	2.5 ks
1 μ s 50 ms/div	$33,500 \times (s/div)$
1 ns to 500 ns/div	32.7 ms (16533A)
500 ps to 200 μ s/div	16.3 ms (16534A)

Pre- and post-trigger delay time ranges, as they compare with sweep speeds, are shown in the table at the end of this chapter.

The default value for the Delay field is 0 s.

Panning (Acquisition Stopped)

When acquisitions are stopped, the Delay field can be used to control what portion of acquisition memory will be displayed on screen. Acquisition memory is comprised of the following sections:

Pre-trigger delay range = delay time setting – (16384 × sample period)

Post-trigger delay range = delay time setting + (16384 × sample period)

This shows that one-half of the data stored in acquisition memory was stored before the delay time setting and one-half of the data in memory was stored after the delay time setting. Panning allows you to view the entire waveform record by adjusting the Delay field. Normally, using the delay function to view all of the acquired waveform (panning) is done on a waveform acquired in Single (single-shot) mode.

Using the Center Screen field that appears in the Marker Menu (refer to chapter 5) is another way to shift/pan the display to center it on specific time markers.

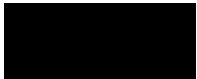

Sample Period Field

Any time the Time and Voltage Markers field are both Off, the sample period of the acquired waveform is displayed in the bottom row of the menu fields.

Sample period is the time period between acquired sample points and is the inverse of sample rate (digitizing rate). Sample period is a function of sweep speed and can only be changed by changing the s/Div field. Sample period and sample rates, as they compare with sweep speed, are shown in the Sample Period tables on page 4-10 and 4-12.

There are two fields to the right of the Sample Period field which pertain to the sample rate. These fields are the Data acquired at field and the Next acquisition field.

Data acquired at Field

When acquisitions are stopped, the Data acquired at field shows the sample rate at which the last acquisition was taken. When the s/Div field is light-blue, you can turn the knob to change the time base setting.

During a repetitive run, the Data acquired at field and the Next acquisition field will display the same value on the first acquisition following a s/Div setting change. This happens because the hardware is reprogrammed between acquisitions in response to the new time base setting.

Next acquisition Field

When you change the time base setting (see above paragraph), the value in the Next acquisition field changes to reflect the sample rate at which the next acquisition will be taken if the Run field is touched.

During a repetitive run, the Data acquired at field and the Next acquisition field will display the same value on the first acquisition following a s/Div setting change. This happens because the hardware is reprogrammed between acquisitions in response to the new time base setting.

Sample Period Value Display

Any time the markers (either voltage and/or time) are turned on, the current marker settings may be displayed on the channel, trigger, display and auto-measure menus by using the Display Options field located to the right of the time base Delay field. The Display Options field is also used to access the channel labeling field. Refer to the Display Menu chapter for channel labeling details. Refer to the Marker Menu chapter for further details about the Marker Value display.

On the marker menu, if time markers are turned off, the Sample Period display will appear on the marker menu. If time markers are selected as either On or Auto, the Sample Period display is not visible on the Marker menu.

The Display Options field never appears on the Marker menu.



Time Base Functions
Sample Period Field

16534A Sample Period Table

s/Div	Sample Rate	Sample Period	Trace Length	Percent on Screen
5 s	100 Sa/s	10 ms	327.68 s	15%
2 s	250 Sa/s	4 ms	131.07 s	15%
1 s	500 Sa/s	2 ms	65.536 s	15%
500 ms	1 KSa/s	1 ms	32.768 s	15%
200 ms	2.5 KSa/s	400 μs	13.107 s	15%
100 ms	5 KSa/s	200 μs	6.553 s	15%
50 ms	10 KSa/s	100 μs	3.276 s	15%
20 ms	25 KSa/s	40 μs	1.310 s	15%
10 ms	50 KSa/s	20 μs	655.36 ms	15%
5 ms	100 KSa/s	10 μs	327.68 ms	15%
2 ms	250 KSa/s	4 μs	131.07 ms	15%
1 ms	500 KSa/s	2 μs	65.536 ms	15%
500 μs	1 MSa/s	1 μs	32.768 ms	15%
200 μs	2.5 MSa/s	400 ns	13.107 ms	15%
100 μs	5 MSa/s	200 ns	6.553 ms	15%
50 μs	10 MSa/s	100 ns	3.276 ms	15%
20 μs	25 MSa/s	40 ns	1.310 ms	15%
10 μs	50 MSa/s	20 ns	655.36 μs	15%
5 μs	100 MSa/s	10 ns	327.68 μs	15%
2 μs	250 MSa/s	4 ns	131.07 μs	15%
1 μs	500 MSa/s	2 ns	65.536 μs	15%
500 ns	1 GSa/s	1 ns	32.768 μs	15%
200 ns	2 GSa/s	500 ps	16.384 μs	12%
100 ns	2 GSa/s	500 ps	16.384 μs	6%
50 ns	2 GSa/s	500 ps	16.384 μs	3%
20 ns	2 GSa/s	500 ps	16.384 μs	1%
10 ns	2 GSa/s	500 ps	16.384 μs	1%
5 ns	2 GSa/s	500 ps	16.384 μs	1%
2 ns	2 GSa/s	500 ps	16.384 μs	1%
1 ns	2 GSa/s	500 ps	16.384 μs	1%
500 ps	2 GSa/s	500 ps	16.384 μs	1%

Notes:

Sa/s = Samples per second.

Trace length = 32768 x sample rate.

Percent on screen = The percentage of the total acquired samples that are seen on screen when the acquired data is displayed. It is defined as (10 x s/div)/trace length.

16534A Delay Table

s/Div	Sample Period	*Max. Negative Delay at Acquisition	**Max. Positive Delay at Acquisition	Max. Negative Delay	Max. Positive Delay
5 s	10 ms	-163 s	2.5 Ks	-2.5 Ks	2.5 Ks
2 s	4 ms	-65.5 s	2.5 Ks	-2.5 Ks	2.5 Ks
1 s	2 ms	-32.7 s	2.5 Ks	-2.5 Ks	2.5 Ks
500 ms	1 ms	-16.3 s	2.5 Ks	-2.5 Ks	2.5 Ks
200 ms	400 μs	-6.55 s	2.5 Ks	-2.5 Ks	2.5 Ks
100 ms	200 μs	-3.27 s	2.5 Ks	-2.5 Ks	2.5 Ks
50 ms	100 μs	-1.63 s	1675 s	-2.5 Ks	2.5 Ks
20 ms	40 μs	-655 ms	670 s	-2.5 Ks	2.5 Ks
10 ms	20 μs	-327 ms	335 s	-2.5 Ks	2.5 Ks
5 ms	10 μs	-163 ms	167 s	-2.5 Ks	2.5 Ks
2 ms	4 μs	-65.5 ms	67.0 s	-2.5 Ks	2.5 Ks
1 ms	2 μs	-32.7 ms	33.5 s	-2.5 Ks	2.5 Ks
500 μs	1 μs	-16.3 ms	16.7 s	-2.5 Ks	2.5 Ks
200 μs	400 ns	-6.55 ms	6.70 s	-2.5 Ks	2.5 Ks
100 μs	200 ns	-3.27 ms	3.35 s	-2.5 Ks	2.5 Ks
50 μs	100 ns	-1.63 ms	1.67 s	-2.5 Ks	2.5 Ks
20 μs	40 ns	-655 μs	670 ms	-2.5 Ks	2.5 Ks
10 μs	20 ns	-327 μs	335 ms	-2.5 Ks	2.5 Ks
5 μs	10 ns	-163 μs	167 ms	-2.5 Ks	2.5 Ks
2 μs	4 ns	-65.5 μs	67.0 ms	-2.5 Ks	2.5 Ks
1 μs	2 ns	-32.7 μs	33.5 ms	-2.5 Ks	2.5 Ks
500 ns	1 ns	-16.3 μs	16.7 ms	-2.5 Ks	2.5 Ks
200 ns	500 ps	-8.19 μs	8.35 ms	-2.5 Ks	2.5 Ks
100 ns	500 ps	-8.19 μs	8.35 ms	-2.5 Ks	2.5 Ks
50 ns	500 ps	-8.19 μs	8.35 ms	-2.5 Ks	2.5 Ks
20 ns	500 ps	-8.19 μs	8.35 ms	-2.5 Ks	2.5 Ks
10 ns	500 ps	-8.19 μs	8.35 ms	-2.5 Ks	2.5 Ks
5 ns	500 ps	-8.19 μs	8.35 ms	-2.5 Ks	2.5 Ks
2 ns	500 ps	-8.19 μs	8.35 ms	-2.5 Ks	2.5 Ks
1 ns	500 ps	-8.19 μs	8.35 ms	-2.5 Ks	2.5 Ks
500 ps	500 ps	-8.19 μs	8.35 ms	-2.5 Ks	2.5 Ks

Notes: "at Acquisition" = the maximum delay (positive or negative) allowed when you select RUN.
 *Maximum negative delay at acquisition = $-(16384 \times \text{sample period})$.
 **Maximum positive delay at acquisition = $(2^{24} \times \text{sample period})$ with a maximum of 2.5 Ks.

Time Base Functions
Sample Period Field

16533A Sample Period Table

s/Div	Sample Rate	Sample Period	Trace Length	Percent on Screen
5 s	100 Sa/s	10 ms	327.68 s	15%
2 s	250 Sa/s	4 ms	131.07 s	15%
1 s	500 Sa/s	2 ms	65.536 s	15%
500 ms	1 KSa/s	1 ms	32.768 s	15%
200 ms	2.5 KSa/s	400 μs	13.107 s	15%
100 ms	5 KSa/s	200 μs	6.553 s	15%
50 ms	10 KSa/s	100 μs	3.276 s	15%
20 ms	25 KSa/s	40 μs	1.310 s	15%
10 ms	50 KSa/s	20 μs	655.36 ms	15%
5 ms	100 KSa/s	10 μs	327.68 ms	15%
2 ms	250 KSa/s	4 μs	131.07 ms	15%
1 ms	500 KSa/s	2 μs	65.536 ms	15%
500 μs	1 MSa/s	1 μs	32.768 ms	15%
200 μs	2.5 MSa/s	400 ns	13.107 ms	15%
100 μs	5 MSa/s	200 ns	6.553 ms	15%
50 μs	10 MSa/s	100 ns	3.276 ms	15%
20 μs	25 MSa/s	40 ns	1.310 ms	15%
10 μs	50 MSa/s	20 ns	655.36 μs	15%
5 μs	100 MSa/s	10 ns	327.68 μs	15%
2 μs	250 MSa/s	4 ns	131.07 μs	15%
1 μs	500 MSa/s	2 ns	65.536 μs	15%
500 ns	1 GSa/s	1 ns	32.768 μs	15%
200 ns	1 GSa/s	1 ns	32.768 μs	6%
100 ns	1 GSa/s	1 ns	32.768 μs	3%
50 ns	1 GSa/s	1 ns	32.768 μs	1%
20 ns	1 GSa/s	1 ns	32.768 μs	<1%
10 ns	1 GSa/s	1 ns	32.768 μs	<1%
5 ns	1 GSa/s	1 ns	32.768 μs	<1%
2 ns	1 GSa/s	1 ns	32.768 μs	<1%
1 ns	1 GSa/s	1 ns	32.768 μs	<1%

Notes:

Sa/s = Samples per second.

Trace length = 32768 x sample rate.

Percent on screen = The percentage of the total acquired samples that are seen on screen when the acquired data is displayed.

16533A Delay Table

s/Div	Sample Period	*Max. Negative Delay at Acquisition	**Max. Positive Delay at Acquisition	Max. Negative Delay	Max. Positive Delay
5 s	10 ms	-163 s	2.5 Ks	-2.5 Ks	2.5 Ks
2 s	4 ms	-65.5 s	2.5 Ks	-2.5 Ks	2.5 Ks
1 s	2 ms	-32.7 s	2.5 Ks	-2.5 Ks	2.5 Ks
500 ms	1 ms	-16.3 s	2.5 Ks	-2.5 Ks	2.5 Ks
200 ms	400 μs	-6.55 s	2.5 Ks	-2.5 Ks	2.5 Ks
100 ms	200 μs	-3.27 s	2.5 Ks	-2.5 Ks	2.5 Ks
50 ms	100 μs	-1.63 s	1675 s	-2.5 Ks	2.5 Ks
20 ms	40 μs	-655 ms	670 s	-2.5 Ks	2.5 Ks
10 ms	20 μs	-327 ms	335 s	-2.5 Ks	2.5 Ks
5 ms	10 μs	-163 ms	167 s	-2.5 Ks	2.5 Ks
2 ms	4 μs	-65.5 ms	67.0 s	-2.5 Ks	2.5 Ks
1 ms	2 μs	-32.7 ms	33.5 s	-2.5 Ks	2.5 Ks
500 μs	1 μs	-16.3 ms	16.7 s	-2.5 Ks	2.5 Ks
200 μs	400 ns	-6.55 ms	6.70 s	-2.5 Ks	2.5 Ks
100 μs	200 ns	-3.27 ms	3.35 s	-2.5 Ks	2.5 Ks
50 μs	100 ns	-1.63 ms	1.67 s	-2.5 Ks	2.5 Ks
20 μs	40 ns	-655 μs	670 ms	-2.5 Ks	2.5 Ks
10 μs	20 ns	-327 μs	335 ms	-2.5 Ks	2.5 Ks
5 μs	10 ns	-163 μs	167 ms	-2.5 Ks	2.5 Ks
2 μs	4 ns	-65.5 μs	67.0 ms	-2.5 Ks	2.5 Ks
1 μs	2 ns	-32.7 μs	33.5 ms	-2.5 Ks	2.5 Ks
500 ns	1 ns	-16.3 μs	16.7 ms	-2.5 Ks	2.5 Ks
200 ns	1 ns	-16.3 μs	16.7 ms	-2.5 Ks	2.5 Ks
100 ns	1 ns	-16.3 μs	16.7 ms	-2.5 Ks	2.5 Ks
50 ns	1 ns	-16.3 μs	16.7 ms	-2.5 Ks	2.5 Ks
20 ns	1 ns	-16.3 μs	16.7 ms	-2.5 Ks	2.5 Ks
10 ns	1 ns	-16.3 μs	16.7 ms	-2.5 Ks	2.5 Ks
5 ns	1 ns	-16.3 μs	16.7 ms	-2.5 Ks	2.5 Ks
2 ns	1 ns	-16.3 μs	16.7 ms	-2.5 Ks	2.5 Ks
1 ns	1 ns	-16.3 μs	16.7 ms	-2.5 Ks	2.5 Ks

Notes: "at Acquisition" = the maximum delay (positive or negative) allowed when you select RUN.
 *Maximum negative delay at acquisition = $-(16384 \times \text{sample period})$.
 **Maximum positive delay at acquisition = $(2^{24} \times \text{sample period})$ with a maximum of 2.5 Ks.



The Marker Menu

The Marker Menu

The oscilloscope has two sets of markers that allow you to make time and voltage measurements. These measurements can be made either manually (voltage and time markers) or automatically (time markers only). The markers are accessed when you touch the Markers choice on the oscilloscope menu pop-up.

The default selection for both the time and voltage Marker fields is Off.

Markers Menu Map

The menu map on the next page illustrates all fields and the available options in the Markers menu. The menu map will help you get an overview as well as provide you with a quick reference of what the Marker menu contains.

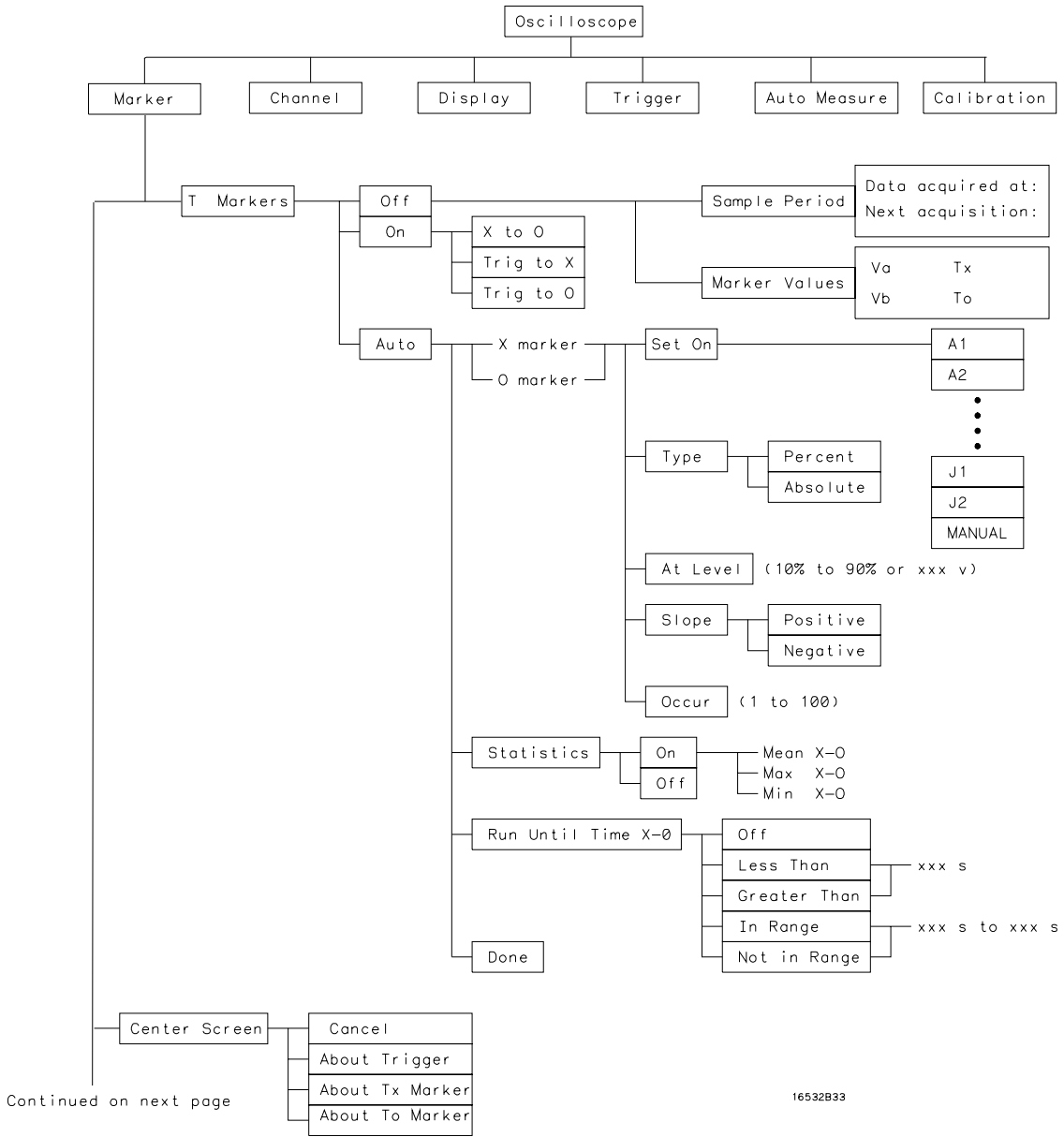

Markers Field Menu Map

The Marker Menu

Continued from previous page

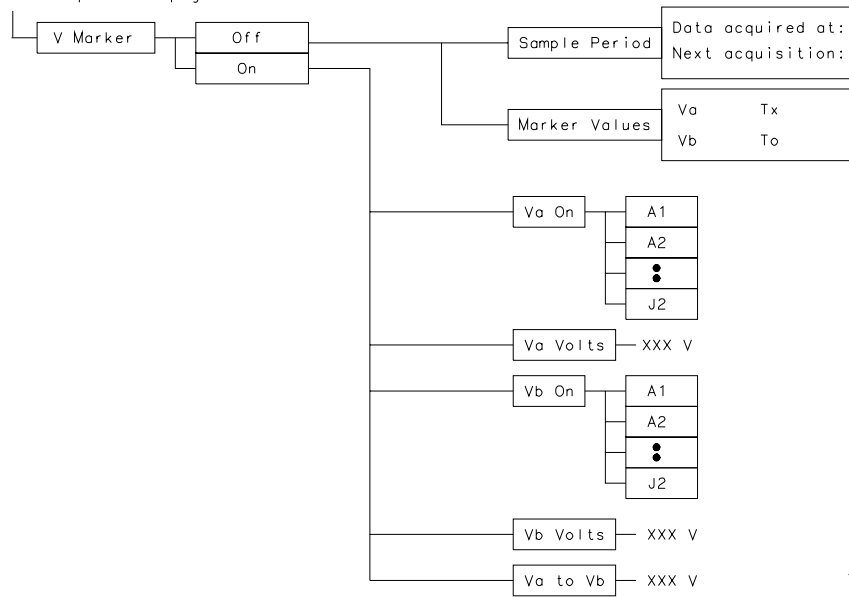

16532834

Markers Field Menu Map (Continued)

Manual Time Markers Options

When you touch the T Markers field on the display, a pop-up menu appears. When you touch the On field in the pop-up to turn T Markers On, you can manually move the Tx and To markers to make time measurements.

When you touch the On field in the T Markers menu, three new fields appear to the right of the T Markers field: Tx to To, Trig to X, and Trig to O fields. These fields allow you to position the Tx marker and the To marker by entering time values for these markers. When time markers are turned on and voltage markers are turned off, the channel label field displays voltage values for the Tx and To markers except for waveforms where Overlay mode has been selected in the Waveform Selection menu.



Tx to To Field

The Tx to To field displays the time difference (delta time) between the Tx marker and the To marker. When you select the Tx to To field, turning the knob moves both the Tx and To markers across the display without changing the value in the Tx to To field. However, the values in the Trig to X and Trig to O fields will change to reflect the movement of the Tx and To markers.

You can change the value in the Tx to To field by changing the Trig to X or Trig to O values, or by changing the Tx to To value from the pop-up keypad. The keypad appears when you touch the Tx to To field when the field is light blue.

When you change the time value of Tx to To by using the keypad, the difference between the new value and old value is divided in half. Each half is then either added to or subtracted from the Tx marker while the other half is either added to or subtracted from the To marker, depending on one of four possibilities.

- If the Tx marker is to the left of the To marker and you are increasing the time between markers, subtract one half from the Tx marker value and add the other half to the To marker value.
- If the Tx marker is to the left of the To marker and you are decreasing the time between markers, add one half to the Tx marker value and subtract the other half from the To marker value.
- If the To marker is to the left of the Tx marker and you are increasing the time between markers, subtract one half from the To marker value and add the other half to the Tx marker value.
- If the To marker is to the left of the Tx marker and you are decreasing the time between markers, add one half to the To marker value and subtract the other half from the To marker value.

Example

The Tx marker is to the left of the To marker

The Tx to To marker is originally set to 352 μ s

The Trig to X field is originally 8 μ s

The Trig to O field is originally 360 μ s

Then, using the keypad, decrease the value of Tx to To to 200 μ s. The difference between the original value (352) and the new value (200) is 152. Half that value is 76. Adding 76 to the old Trig to X value ($76 + 8$) = 84. Subtracting 76 from the old Trig to O value ($360 - 76$) = 284.

Trig to X Field

The Tx marker is shown on the waveform display as a vertical dashed green line. The border around the Trig to X field is also green so that you can correlate the value in that field to the green Tx marker. The time displayed in the Trig to X field is measured from the trigger point to the Tx marker. The trigger point is shown as a vertical dotted red line at the center of the waveform display when Delay equals zero. The trigger point is always time 0. When you select the Trig to X field, you can change the time value by turning the knob or by entering a time value from the pop-up keypad. The keypad appears when you touch the Trig to X field when the field is light blue. Resolution for Trig to X time values is 2% of the sweep speed setting. The default value for the Trig to X field is 0 s.

Trig to O Field

The To marker is shown on the waveform display as a vertical dashed yellow line. The border around the Trig to O field is also yellow so that you can correlate the value in that field to the yellow To marker. The time displayed in the Trig to O field is measured from the trigger point to the To marker.

When you select the Trig to O field, you can change the time value by turning the knob or by entering a time value from the pop-up keypad. The keypad appears when you touch the Trig to O field when the field is light blue.

Resolution for Trig to O time values is 2% of the sweep speed setting. The default value for the Trig to O field is 0 s.

Channel Label Field

The channel label field is the dark blue field to the left of the waveform display. When you turn time markers on with voltage markers off, the voltage values where the Tx and To markers intersect each waveform are displayed under each channel label.

When you touch the Trig to X field and turn the knob, the Tx marker (green) will move across the display. As you move the marker, the time value in the Trig to X field changes. A negative time value indicates the marker is placed before the trigger point, and a positive time value indicates the marker is placed after the trigger point.

As you turn the knob when either the Trig to X or Trig to O field is selected, the time value in the Tx to To field also changes, showing the time difference between the Tx and To markers. If the time displayed in the Tx to To field is negative, the To marker is to the left of the Tx marker.

As you move the Tx marker from a low portion on the waveform to a high portion, the X voltage value under the input label in the channel label field also changes.

When you touch the Trig to O field and turn the knob, the To marker (yellow) will move, and the time and voltage values will change just as they did for the Tx marker.

When you touch the Tx to To field and turn the knob, the Tx and To markers will move in unison and maintain the preset Tx to To time value.

You can also change the Tx to To, Trig to X, and Trig to O fields with the pop-up keypad. Refer to the earlier paragraph entitled "Tx to To Field" for a description and results of keypad entries in the Tx to To field.



T Marker Value Display

Any time the markers (either voltage and/or time) are turned on, the current marker settings may be displayed on the channel, trigger, display and auto-measure menus by using the Display Options field located to the right of the time base Delay field. The Display Options field provides a pop-up menu that allows you to either select to set channel labels or to view the Sample Period display or the Marker Value display.

The Marker Value display consists of two blocks. One contains settings for the voltage markers, the second contains settings for the time markers. If only one set of markers is turned on, only one of the two blocks will appear on the screen.

On the Marker menu, if time markers are turned off, the Sample Period display will appear on the marker menu. If time markers are selected as either On or Auto, the Sample Period display is not visible on the Marker menu.

The Display Options field never appears on the Marker menu.

Automatic Time Marker Options

When you touch the T Markers field a pop-up menu appears. When you touch the Auto field in the pop-up, a pop-up menu for automatic time marker measurements is displayed.

The automatic time marker measurements are made by setting the time markers to levels that are either a percentage of the top-to-base voltage value of a waveform or that specify voltage levels. The top-to-base voltage value of a waveform is typically not the same as the peak-to-peak voltage value. The oscilloscope determines the top and base voltages by finding the flattest portions of the top and bottom of the waveform. The top and base values do not typically include preshoot or overshoot of the waveform. The peak-to-peak voltage is the difference between the minimum and maximum voltages found on the waveform.

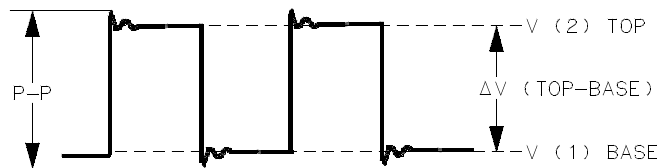

54111W01

If the signal is clipped, the time markers will not be automatically placed.

When searching for the marker patterns, the search will occur only on that part of the waveform that is displayed, not the entire stored waveform.

The default Auto markers pop-up menu options are discussed in the following paragraphs.

Done Field

You touch the Done field when you are done entering data in the auto-markers pop-up and want to return to the waveform display.

Set on Field

The Set on field assigns an input waveform to the Tx or To marker, or allows the marker to be set manually (with the MANUAL selection in the pop-up). When you touch the Set on field, a pop-up appears showing all waveform sources available.

What is displayed on the pop-up depends on how many oscilloscope boards are installed in the mainframe and in which slots they are installed.

The default selection for the Set on field is the lowest letter and number combination. For example, if oscilloscope boards are installed in mainframe slots C and D, the Set on field will default to C1 for both the Tx and To markers.

Type Field

The Type field selects the units in which an automatic time marker level will be specified. The automatic time marker can have a level expressed as either a percentage of the waveform top-base voltage (Percent) or as an absolute voltage level (Absolute).

The default selection is Percent.

at Level Field

When the marker Type is Percent, the at Level field sets the Tx or To marker to a percentage level (from 10% to 90%) of the top-base voltage on the waveform selected by the Set on field. When you select the at Level field, you can change the percentage by turning the knob or by entering a value from the pop-up keypad. The keypad appears when you touch the at Level field when the field is light blue. You can enter any percentage from 10% to 90% in increments of 1%.

The default value for the at Level field is 50%.

When the marker Type is Absolute, the at Level field sets the Tx or To marker to the specific voltage level. The allowable voltage range that can be selected is the vertical range for the selected channel (that is: offset \pm 2 times V/div). You can change the voltage level by either turning the knob or by entering a value from the pop-up keypad. The keypad appears when you touch the at Level field when the field is light blue. You can enter any voltage from -12V to 4V in increments of 30mV.

The power up default value for at Level field is the selected channel offset value. If the vertical range parameters (for example: v/div, offset, probe factor) of a channel are changed such that the current at Level voltage is no longer valid, the at Level voltage will track the limit of the vertical range.

Slope Field

The Slope field sets the Tx or To marker on either the positive or negative edge of the selected occurrence of a waveform. When you touch the Slope field, the slope toggles between Positive and Negative.

The default selection for the Slope field is Positive.

Occur Field

The Occur field sets the Tx or To marker on a specific occurrence of a displayed edge on the waveform. You can define the edge to be displayed all the way from the 1st edge up to the 100th edge. The count of edge occurrences is made starting with the first edge displayed on the screen.

Auto-marker measurements are made with data that is displayed on the screen. Make sure the data of interest is fully displayed on the screen.

When the Occur field is selected, you can change the occurrence by turning the knob or by entering a new value from the pop-up keypad. The keypad appears when you touch the Occur field when the field is light blue. Any number from 1 to 100 in increments of 1 can be entered.

The default value for the Occur field is 1.

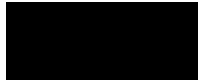

Statistics Field

The Statistics field allows you to make minimum, maximum, and mean time interval measurements from marker Tx to marker To. When you touch the Statistics field, it toggles between On and Off. The default selection for the Statistics field is On.

On

When Statistics is set to On, Min X-O, Max X-O, and Mean X-O appear together in a tan-colored field to the right of the T Markers field on the marker menu.

When Statistics is set to On, the minimum, maximum, and mean (average) Tx to To marker time interval data is accumulated and displayed until one of the following happens:

- Auto is deselected as the T Marker option.
- Auto-marker parameters are changed.
- Statistics is set to Off.
- Run Repetitive mode is stopped.

Off

When Statistics is set to Off, the Tx to To, Trig to X, and Trig to O fields appear next to the Markers field on the Marker menu.

The marker statistics (minimum, maximum, and mean) are reset to zero only when you touch the Done field on the auto-markers pop-up after making a change to one of the auto-marker placement specification fields (Set On, Type, Level, Slope, or Occur).

Other oscilloscope menu changes do not reset marker statistics, but may have an impact on the values computed for the marker statistics.

Run Until Time X-O Field

This field allows you to set up a stop condition for the time interval between the Tx marker and To marker. When the stop condition is met, the oscilloscope stops making acquisitions and displays the message "Stop condition satisfied." You define the stop conditions with selections you make after you touch the Run Until Time X-O field. The default selection for this field is Off.

The Run Until Time X-O feature is only valid if the Run field is set to Repetitive.

Less Than Field

When you select this field from the pop-up, a time value field appears next to the Run Until Time X-O Less Than field. The time value field default value is 0 s.

When you select the time value field, you can enter the time by turning the knob or by entering a value from the pop-up keypad. The keypad appears when you touch the time value field when the field is light blue. For keypad entries, resolution is 10 ps at times up to ± 99.99 ns and can be set to 5-digit resolution for other times up to ± 100 Ms. Positive times are used when the Tx marker is displayed before the To marker, and negative times are used when the To marker is displayed before the Tx marker.

When you select Less Than, the oscilloscope runs until the Tx-To time interval is less than the value entered for the Less Than time field. When the condition is met, the oscilloscope stops making acquisitions and displays the message "Stop condition satisfied."

Greater Than Field

When you select this field from the pop-up, a time value field appears next to the Run Until Time X-O Greater Than field. The time value field default value is 0 s. When you select the time value field, you can enter the time in the same manner as for the Less Than field.

When you select Greater Than, the oscilloscope runs until the Tx-To time interval is greater than the value entered for the Greater Than time field. When the condition is met, the oscilloscope stops making acquisitions and displays the message "Stop condition satisfied."

In Range Field

When you select this field from the pop-up, two time value fields appear next to the Run Until Time X-O In Range field. You need to enter the time range values for the stop condition in these two time fields. Select each time value field, in turn, and enter the time value in the same manner as for the Less Than field.

When you select In Range, the oscilloscope runs until the Tx-To time interval is in the range of the time values entered for the In Range time fields. When the condition is met, the oscilloscope stops making acquisitions and displays the message "Stop condition satisfied."

Not In Range Field

When you select this field from the pop-up, two time value fields appear next to the Run Until Time X-O Not In Range field. You need to enter the time range values for the stop condition in these two time fields. Select each time value field, in turn, and enter the time values in the same manner as for the Less Than field.

When Not In Range is selected, the oscilloscope runs until the Tx-To time interval is not in the range of the time values entered for the Not In Range time fields. When the condition is met, the oscilloscope stops acquisitions and displays the message "Stop condition satisfied."

Manual/Automatic Time Markers Option

The manual/automatic combination allows you to have one marker set to automatic mode and one marker set to be controlled manually with the knob.

Setting the Manual/Automatic Time Markers Option



To set the manual/automatic option you touch the T Markers field and select the Auto field from the pop-up. You then touch the Set on field for either the Tx or To marker, and then select MANUAL from the pop-up menu.

When you touch Done in the auto-markers pop-up menu, you return to the waveform display. Now when you touch the T Markers field again and select On from the pop-up menu, the marker you selected with the MANUAL field is set to the manual mode and the other marker is set to fall on the parameters you set while in the automatic mode.

Example

While in Auto markers mode set the conditions to:

Tx>: X1, positive slope, occur 1
To>: MANUAL

Now set the T Marker Mode to On and Run Repetitively. You can now control the To marker with the knob, but the Tx marker is controlled by the setup you made in Auto Markers (that is, it will fall on the leading edge of the first displayed positive pulse).

If you move the Tx marker, it will default to MANUAL mode and will no longer be set automatically.

Voltage Markers Options

When you touch the V Markers field on the display, a pop-up menu appears. When you touch the On field in the pop-up to turn Voltage Markers On, you can manually move the Va and Vb markers to make voltage measurements.

When you touch the On field in the V Markers menu, five new fields appear to the right of the V Markers field: Va On, Va Volts, Vb On, Vb Volts, and Va to Vb fields. These fields allow you to position the Va marker and the Vb marker by entering channel numbers and voltage levels for these markers.

If you turn the voltage markers on while the time markers are also turned on, the voltage levels that correspond to the time marker waveform crossings will be deleted from the channel label field. If you turn the voltage markers off while the time markers are turned on, the voltage levels that correspond to the time marker waveform crossings will appear in the channel label field.

When the oscilloscope is in Overlay mode, the Voltage Markers options are not available.

Va On Field

The Va marker is shown on the waveform display as a horizontal dashed green line. The border around the Va On field is also green so you can more easily correlate the value in this field to the green Va marker.

When you select the Va On field, you are able to assign the Va marker to one of the oscilloscope acquisition channels. A pop-up menu appears that lists all possible channels for assignment of the Va marker. The default channel is the lowest numbered channel in the oscilloscope.

The channel selected for assignment to the Va marker does not have to be displayed in the waveform area. If the selected waveform is not in the waveform area of the screen, the Va marker will not be displayed. If there are multiple occurrences of the selected waveform in the waveform area of the screen, only the uppermost occurrence of the waveform will display the Va marker.

Overlay and waveform math traces cannot be selected for voltage marker placement.

Va Volts Field

The Va marker is shown on the waveform display as a horizontal dashed green line. The border around the Va Volts field is also green so you can more easily correlate the value in this field to the green Va marker.

The voltage displayed in the Va Volts field is measured relative to the zero-volt reference for this channel.

When you select the Va Volts field, you can change the voltage value by turning the knob or by entering a voltage value from the pop-up keypad. The keypad appears when you touch the Va Volts field when the field is light blue.

The range of voltage levels for the Va Volts field is ± 2 times maximum range for the selected channel. The maximum range value is affected by the probe factor and v/div settings.

Vb On Field

The Vb marker is shown on the waveform display as a horizontal dashed yellow line. The border around the Vb On field is also yellow so you can more easily correlate the value in this field to the yellow Vb marker.

When you select the Vb On field, you are able to assign the Vb marker to one of the oscilloscope acquisition channels. A pop-up menu appears that lists all possible channels for assignment of the Vb marker. The default channel is the lowest numbered channel in the oscilloscope.

The channel selected for assignment to the Vb marker does not have to be displayed in the waveform area. If the selected waveform is not in the waveform area of the screen, the Vb marker will not be displayed. If there are multiple occurrences of the selected waveform in the waveform area of the screen, only the uppermost occurrence of the waveform will display the Vb marker.

Overlay and waveform math traces cannot be selected for voltage marker placement.

Vb Volts Field

The Vb marker is shown on the waveform display as a horizontal dashed yellow line. The border around the Vb Volts field is also yellow so you can more easily correlate the value in this field to the yellow Vb marker.

The voltage displayed in the Vb Volts field is measured relative to the 0V reference for this channel.

When you select the Vb Volts field, you can change the voltage value by turning the knob or by entering a voltage value from the pop-up keypad. The keypad appears when you touch the Vb Volts field when the field is light blue.

The range of voltage levels for the Vb Volts field is ± 2 times maximum range for the selected channel. The maximum range value is affected by the probe factor and V/div settings.

Va to Vb Field

This field displays the difference between the Va and Vb markers. This value is dependent on channel selections and represents Vb minus Va.

Center Screen Field

The Center Screen field appears on the right side of the Marker menu. The Center Screen field is used to modify the horizontal (time base) position of the waveform display.

When you select the Center Screen field, a pop-up menu appears that lets you choose a time marker for use as the center point of the display. You also have the option of canceling the center screen function.

If time markers are turned off, the only marker choice available on the Center screen pop-up will be the trigger marker. If time markers are turned on, the Tx and To markers will also appear in the Center Screen pop-up menu. If the auto time markers are enabled, only the trigger marker appears in the Center Screen pop-up menu.

Selecting one of the possible time markers for centering the waveform data will cause the time base delay value to be changed such that the selected marker is positioned at the center of the screen. All acquisition channels are shifted when the trace data is centered. The time base delay field value will be updated when the centering operation is performed.



V Marker Value Display

Any time the markers (either voltage and/or time) are turned on, the current marker settings may be displayed on the channel, trigger, display and auto-measure menus by using the Display Options field located to the right of the time base Delay field. The Display Options field provides a pop-up menu that allows you to select to set channel labels or to view the Sample Period display or the Marker Value display.

The Marker Value display consists of two blocks. One contains settings for the voltage markers, the second contains settings for the time markers. If only one set of markers is turned on, only one of the two blocks will appear on the screen.

On the marker menu, if time markers are turned off, the Sample Period display will appear on the Marker menu. If time markers are selected as either On or Auto, the Sample Period display is not visible on the Marker menu.

The Display Options field never appears on the Marker menu.



The Trigger Menu

The Trigger Menu

When you are set up in a multi-card configuration, only the master card input channels are recognized as the trigger source. The oscilloscope will not trigger on inputs from the other cards in a multi-card setup.

This chapter discusses how triggering works in a single card configuration or in the master card in a multi-card configuration.

You access the trigger options through the Mode field which is located at the leftmost position of the middle row of fields in the Trigger menu. The Mode field allows you to select the method you want to use to trigger the oscilloscope for a particular application. When you touch the Mode field, a pop-up menu appears, showing the three modes that are available:

- Edge
- Pattern
- Immediate

This chapter explains what the trigger marker is, how to access the different trigger modes, and what each trigger mode does.

The default selection for the Trigger field is Edge.

Trigger Menu Map

The menu map on the next page illustrates all fields and the available options in the Trigger menu. The menu map will help you get an overview as well as provide you with a quick reference of what the Trigger menu contains.

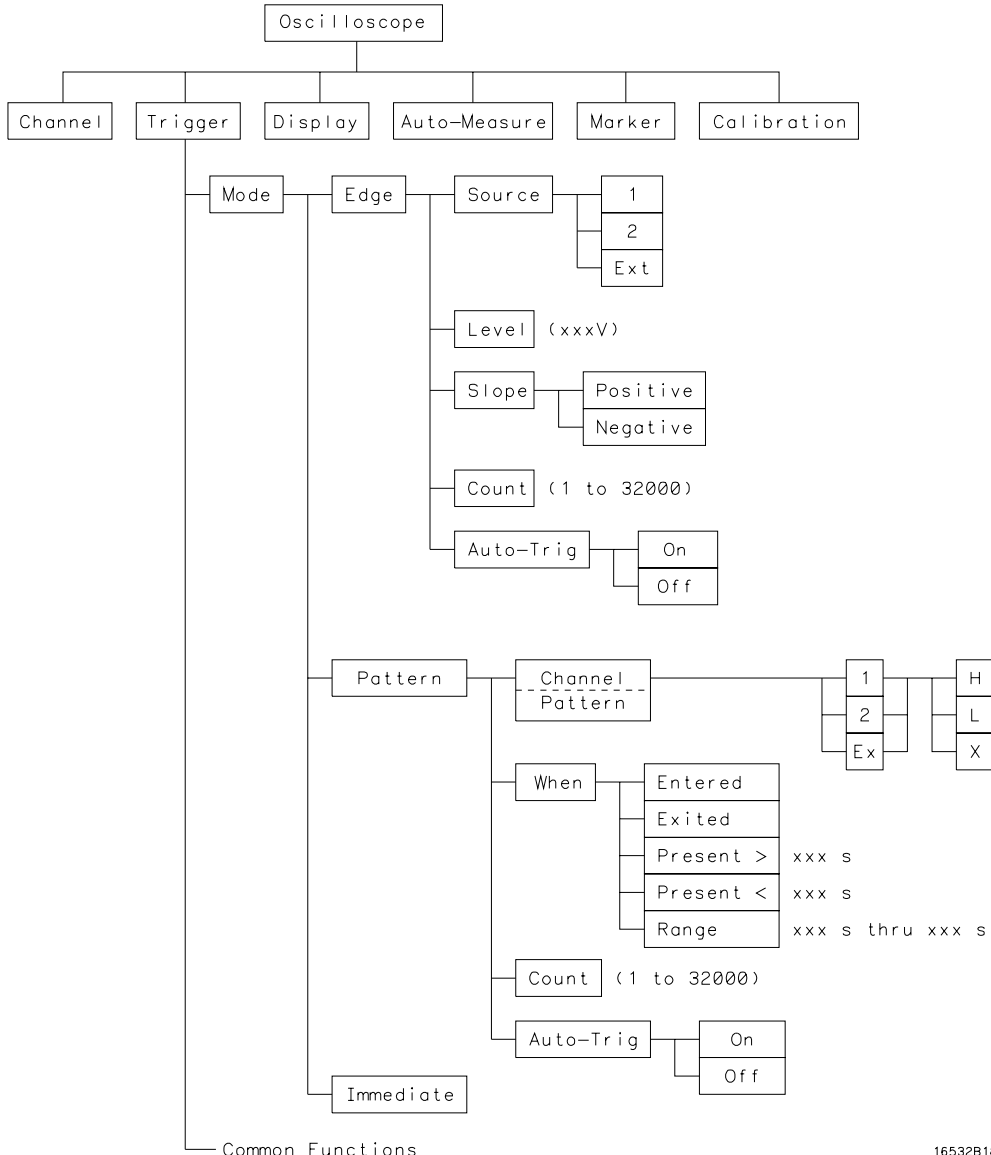

Trigger Field Menu Map

Trigger Marker

The trigger marker is the dotted vertical red line at the center of the waveform display. The point where the waveform from the trigger source crosses the trigger marker is called the trigger point. The trigger point always represents a delay time of zero seconds.

If you set delay time to greater than ± 5 times the sweep speed, the trigger marker will move off the screen.

Edge Trigger Mode

When you are set up in a multi-card configuration, only the master card input channels are recognized as the trigger source. The master card is the card at the top of the module. The oscilloscope will not edge trigger on inputs from the other cards in a multi-card setup.

This section discusses how edge triggering works in a single-card module or in the master card in a multi-card configuration.

Edge triggering is the type of triggering found in all oscilloscopes. In the edge trigger mode, the oscilloscope triggers at a specified voltage level on a rising or falling edge of one of the input channels or the external trigger input. In this mode you can specify which input is the trigger source, set a trigger level voltage (except for Ext, which is set to -1.3 V), and specify which edge to trigger on.

When you touch the Mode field, Edge can be selected from the pop-up menu. Menu selections for the edge trigger mode are discussed in the following paragraphs.

Source Field

When you touch the Source field, a pop-up menu appears showing the inputs available as the trigger source. You can set the trigger source to be any one of the input signals of the master card. The source can be input X1, X2, or Ext, where X equals the oscilloscope slot letter and Ext equals an ECL-level external trigger.

When you have two or more 16533/34A modules connected together, you can only specify the channels on the master 16533/34A module as the trigger source.

At power-up, the default channel input selection for the Source field is channel 1.

Level Field

The Level field shows the trigger level voltage value. When the voltage value on the trigger source equals the trigger level, the oscilloscope triggers. The point at which the oscilloscope triggers is called the trigger point (see the illustration below). The trigger point is shown on the screen as a vertical dotted red line, called the trigger marker. At zero delay time, the trigger marker is located at the horizontal center of the screen. At delay time T_d , the trigger point is offset left (positive delay) or right (negative delay) from the horizontal center of the screen by time T_d .

When you change the trigger level voltage value, the waveform moves horizontally on the display to maintain the trigger point. (That is, the point where the waveform voltage value equals the trigger point voltage value.) This is illustrated below.

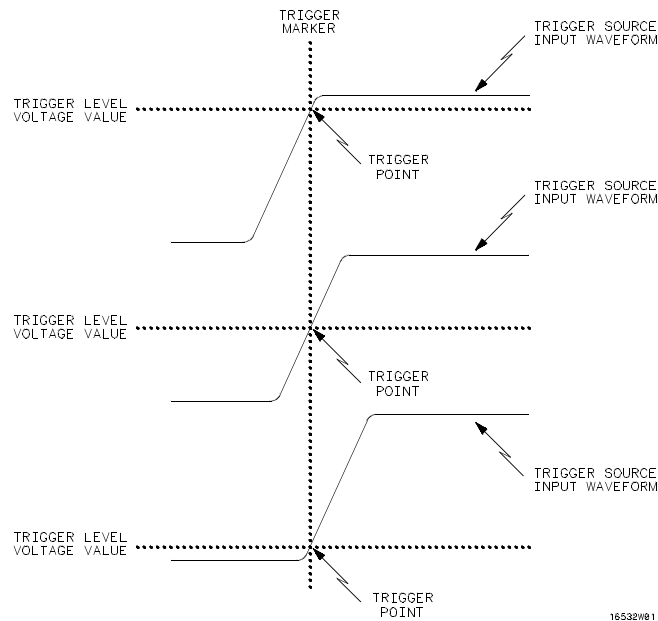

The Trigger Menu

Level Field

If the trigger point voltage level is set above or below the waveform amplitude, the trigger point cannot be found. If Auto-Trig is set to On, this causes the waveform display to become unsynchronized and to "float" on the display. If Auto-Trig is set to Off, the message "Waiting for trigger" is displayed.

The trigger point voltage can be set, either by the autoscale function, or by a voltage value set into the Level field. When you touch the Level field and turn it light blue, you can change the value of the trigger level voltage by turning the knob.

The trigger level can be set to any voltage value contained within the waveform display window, in increments of 0.05% of full scale vertical voltage range ($V/Div \times 4$ divisions = full scale). For example, if full scale voltage range were 400 mV, trigger level would be set in increments of 2 mV ($V/Div = 100 \text{ mV} \times 4 \times 0.005 = 2 \text{ mV}$).

Trigger level values can also be entered with the pop-up keypad. The keypad appears when you select the Level field when the field is white (already selected once). You can enter any value, in 0.05% increments of full scale vertical voltage range. Values entered that are not in this range will be rounded to the nearest 0.05% increment.

Since the trigger level range is limited by the voltage values displayed in the waveform window, the voltage window limits can be easily determined. Turn the knob in both directions until the Level field reads minimum and maximum voltage. These voltage values are the limits of the waveform window. However, if the level is set at the edge of a window and offset for that channel is changed, the trigger level will track that change, thereby changing the window limits.

If the trigger source channel (except EXT) is displayed in the waveform area of the screen, the trigger level marker will appear on the screen as a horizontal dashed red line. The trigger level marker will move up and down on the screen as the trigger level voltage is changed.

If the trigger source channel is not in the waveform area of the screen, the trigger level marker will not be displayed.

If there are multiple occurrences of the trigger source waveform in the waveform area of the screen, only the uppermost occurrence of the trigger source waveform will display the trigger source marker.

The trigger level marker will only appear when the trigger menu is selected.

The default value for the Level field is 1.620 V (TTL preset value).

Slope Field

You can set the trigger slope to trigger on either the positive or negative edge of the trigger source waveform. When you touch the Slope field, the field toggles between Positive and Negative.

The default selection for the Slope field is Positive.

Count Field

In edge trigger mode, you can define a positive or negative edge and the trigger level as a trigger qualifier. When the oscilloscope detects the trigger qualifier, it will trigger at a user-specified number of edges (Count field) on the waveform.

The Count field defines the number of trigger events that must occur after the first trigger qualifier before the oscilloscope will trigger and acquire a waveform.

Count can be set to any integer from 1 to 32,000. When the Count field is selected, the trigger events count can be changed by turning the knob or by entering a value from the pop-up keypad.

This type of triggering is commonly referred to as "events triggering" or "delay-by-events triggering". It is very useful when trying to trigger on a specific pulse in a burst of pulses, with a long time delay, before the next burst occurs.

The default value for the Count field is 1.

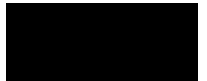

Auto-Trig Field

The Auto-Trig field allows you to specify whether or not the acquisitions should wait for the specified trigger condition to occur. When you touch the Auto-Trig field, the field toggles between On and Off. The On and Off fields are discussed below.

The default selection for the Auto-Trig field is On.

On

When you set auto-trigger to On, the oscilloscope waits approximately 50 ms (20-Hz rate) for a trigger to occur. If a trigger does not occur within that time, the current contents of acquisition memory are displayed. The message "Auto triggered" is displayed if one of the following conditions occurs:

- No signal is on the input. In this case, the oscilloscope will display a baseline.
- There is a signal but the specified trigger condition has not been met. In this case, the waveform display will not be synchronized to a trigger point.

Off

When you set auto-trigger to Off, the oscilloscope waits until a trigger is received before the waveform display is updated. If a trigger does not occur, the screen is not updated and the message "Waiting for Trigger" is displayed. Use this mode when:

- The trigger source signal has less than a 20-Hz repetition rate.
- The trigger events counter (refer to Count field, below) is set so that the number of trigger events would not occur before approximately 50 ms.
- When you want to trigger on a specific event only.

Pattern Trigger Mode

When you are set up in a multi-card configuration, only the master card input channels are recognized as the trigger source. The oscilloscope will not pattern trigger on inputs from the other cards in a multi-card setup.

This chapter discusses how pattern triggering works in a single-card module or in the master card in a multi-card module.

Pattern trigger mode allows you to trigger the oscilloscope upon entering or exiting a specified pattern of the trigger channels and the external trigger input or by specifying a pattern duration or range.

When you have two or more 16533/34A modules connected together, you can only specify the channels on the master 16533/34A module as the trigger source.

When you touch the Mode field, Pattern can be selected from the pop-up menu.

Channel/Pattern Field

The Channel/Pattern field is located next to the Mode field. It allows you to enter a pattern for the combination of the input channels and the ECL external trigger.

Channel

The Channel row lists the inputs available on the oscilloscope module being used. Channels are numbered 1, 2, and Ex. Ex is for the ECL external trigger.

Pattern

Each entry in the pattern shown in the Pattern row shows the trigger condition of the input above it in the Channel row.

You must set the trigger level for each input you want to use in the pattern. You set the trigger levels using the knob or keypad to set the value in the Level field in the Edge trigger mode. Setting these levels sets the threshold of each input for high and low levels in the pattern. The trigger level marker does not appear when Pattern mode triggering is selected.

The pattern for each input may be specified as high (H), low (L), or "don't care" (X). H, L, and X conditions are as follows:

- H – the voltage value of this input channel must be greater than the edge trigger level of this input.
- L – the voltage level of this input channel must be less than the edge trigger level of this input.
- X – is a "don't care" condition. The "don't care" means the associated input channel will not be used in the pattern for the trigger qualifier. It does not equate to "trigger on anything."

The default condition for all patterns is X, "don't care." To change the pattern, touch the Channel/Pattern field. A pop-up keypad will appear which allows you to assign the pattern conditions.

To enter a pattern, touch either X, L, or H on the pop-up keypad. The entries you make appear at the top of the pop-up keypad as they are entered. If you make a mistake, turn the knob to move the highlight to the entry to be corrected and select the correct entry, or touch CLEAR to change all entries back to X and enter the correct values. If the pattern is correct, touch DONE.

A pattern of XXX says to use NO channels to find the trigger. It does not equate to Immediate Mode when Auto-Trig is set to Off. This event will never occur in the hardware. Do not confuse XXX with "don't care, trigger on anything."

When Field

When you touch this field, a pop-up menu appears that lets you specify the trigger When condition.

Pattern Trigger When Condition Pop-up Menu

The Pattern When pop-up menu is used to specify the trigger when condition for pattern triggering. Once a selection has been made, you touch the Done field to exit the pop-up menu and return to the trigger menu. The trigger condition selected will now appear in the When field.

The default selection for the When field is When Entered.

When Entered When this field is active, the oscilloscope triggers on the first transition that makes the pattern specification true for every input used in the pattern trigger specification. If the count set in the Count field is more than 1, the pattern must be true for the number of times set in the count field.

When Exited When this field is active, the oscilloscope triggers on the first transition that causes the pattern specification to be false for every input used in the pattern trigger specification. If the count set in the Count field is more than 1, the pattern must be true for the number of times set in the count field before turning false.

The Trigger Menu

When Field

Present > When this field is active, the scope triggers on the first transition that causes the pattern specification to be false for every input used in the pattern trigger specification if the specified pattern has been true for the time duration specified. If the pattern specification becomes false before the specified duration time has elapsed, the search for a trigger condition starts again. If the pattern specification remains true longer than the specified duration time, the trigger point will be the point at which the pattern specification becomes false.

The pattern duration time can be any value between 20 ns and 160 ms in 10 ns steps.

If the count set in the Count field is one, the trigger event will be the first pattern event that meets both the pattern specification and the duration specification. If the count is greater than one, only the first pattern event must meet the duration specification. Once the pattern duration specification has been met, subsequent pattern events that meet the pattern specification can be of any duration and each such pattern event will contribute to meeting the count specification.

Example

With a pattern specification of HXX, a duration specification of >100 ns, and a count of 3; a pulse string with pulse widths 80 ns, 150 ns, 50 ns, 75 ns, 20 ns, 200 ns would trigger on the trailing edge of the 75 ns pulse. In this example, the 150 ns pulse meets the duration specification and is count 1, the 50 ns pulse is count 2, and the 75 ns pulse is count 3.

Present < When this field is active, the scope triggers on the first transition that causes the pattern specification to be false for every input used in the pattern trigger specification if the specified pattern has been true for less than the time duration specified. If the pattern specification remains true after the specified duration time has elapsed, the search for a trigger condition starts again the next time the pattern specification becomes true. If the pattern specification becomes false before the specified duration time, the trigger point will be the point at which the pattern specification becomes false.

The pattern duration time can be any value between 20 ns and 160 ms in 10 ns steps.

If the count set in the Count field is one, the trigger event will be the first pattern event that meets both the pattern specification and the duration specification. If the count is greater than one, only the first pattern event must meet the duration specification. Once the pattern duration specification has been met, subsequent pattern events that meet the pattern specification can be of any duration and each such pattern event will contribute to meeting the count specification.

Example

With a pattern specification of HXX, a duration specification of <100 ns, and a count of 3; a pulse string with pulse widths 200 ns, 80 ns, 150 ns, 50 ns, 75 ns, 20 ns would trigger on the trailing edge of the 50 ns pulse. In this example, the 80 ns pulse meets the duration specification and is count 1, the 150 ns pulse is count 2, and the 50 ns pulse is count 3.

Range When this field is active, the scope triggers on the first transition that causes the pattern specification to be false for every input used in the pattern trigger specification if the specified pattern has been true for greater than the first time value and less than the second time value that make up the pattern duration range.

If the pattern specification remains true for longer than the maximum duration range limit or becomes false before the minimum duration range limit, the search for a trigger condition starts again the next time the pattern specification becomes true. If the pattern specification becomes false within the specified duration time range, the trigger point will be the point at which the pattern specification becomes false.

The minimum pattern duration time can be any value between 20 ns and 160 ms in 10 ns steps. The maximum pattern duration time must be at least 10 ns greater than the minimum time value.

If the count set in the Count field is one, the trigger event will be the first pattern event that meets both the pattern specification and the duration specification. If the count is greater than one, only the first pattern event must meet the duration specification. Once the pattern duration specification has been met, subsequent pattern events that meet the pattern specification can be of any duration and each such pattern event will contribute to meeting the count specification.

Example

With a pattern specification of HXX, a duration specification of >60 ns and <100 ns, and a count of 3; a pulse string with pulse widths 200 ns, 80 ns, 150 ns, 50 ns, 75 ns, 20 ns would trigger on the trailing edge of the 50 ns pulse. In this example, the 80 ns pulse meets the duration specification and is count 1, the 150 ns pulse is count 2, and the 50 ns pulse is count 3.

Count Field

In pattern trigger mode, you can define a pattern as a trigger qualifier. When the oscilloscope detects the trigger qualifier, it will trigger when a user-specified number of patterns have occurred (Count field) on all inputs.

The Count field defines the number of events that must occur after the first trigger qualifier before the oscilloscope will trigger and acquire a waveform.

Count can be set to any integer from 1 to 32,000. When the Count field is selected, the events count can be changed by turning the knob or by entering a value from the pop-up keypad.

The default value for the Count field is 1.

Auto-Trig Field

The Auto-Trig field allows you to specify whether or not the acquisitions should wait for the specified pattern condition to occur. When you touch the Auto-Trig field, the field toggles between On and Off.

On

When you set auto-trigger to On, the oscilloscope waits for approximately 50 ms (20 Hz rate) for a trigger to occur. If a trigger does not occur within that time, the current contents of acquisition memory are displayed. The message "Auto triggered" is displayed if one of the following conditions occurs:

- If no signal is on the input. In this case, the oscilloscope will display a baseline.
- If there is a signal but the specified pattern condition has not been met. In this case, the waveform display is not synchronized to a trigger point.

Off

When you set auto-trigger to Off, the oscilloscope waits until a trigger is received before the waveform display is updated. If a trigger does not occur, the screen is not updated and the message "Waiting for Trigger" is displayed. Use this mode when:

- The trigger source signal has less than a 20-Hz repetition rate.
- The trigger events counter (refer to Count field, below) is set so that the number of trigger pattern events would not occur before approximately 50 ms.
- When you want to trigger on a specific event only.
- When using pattern duration triggering and the events that meet the duration specification occur infrequently.

The default selection for the Auto-Trig field is On.

Immediate Trigger Mode

When you are set up in a multi-card configuration, only the master card input channels are recognized as the trigger source. The oscilloscope will not trigger on inputs from the other cards in a multi-card module.

This section discusses how immediate triggering works in a single-card module or in the master card in a multi-card module.

Immediate trigger mode causes the oscilloscope to trigger by itself. When you touch the Mode field, Immediate can be selected from the pop-up menu.

Immediate trigger mode can be used for dual timebase (intermodule) applications where, for instance, one oscilloscope module arms another oscilloscope module, or another module (such as a logic analyzer) arms the oscilloscope.

This mode is very similar to Auto-Trig On, but immediate mode does not wait for a specified event to occur.

Intermodule Measurements

If you set the oscilloscope module to Group Run in the Intermodule module menu, the oscilloscope waits until it is armed by the input port or by another module before it begins to search for its own trigger condition. By using the Group Run option you can time-correlate the measurements from various modules (for example, the oscilloscope and a timing analyzer) and display data from several modules on one display.

If you set the oscilloscope module to Independent in the Intermodule Menu, the oscilloscope will be in the free-run mode and the waveform display will not be synchronized with the other measurement modules in your system.

Pattern duration trigger cannot be used when the oscilloscope is armed by another module or by BNC PORT IN as set up on the IMB menu.

More information about intermodule applications can be found in the *Agilent Technologies 16500/16501A Logic Analysis System User's Reference* and the *Agilent Technologies 16500/16501A User's Guide*.



The Display Menu

The Display Menu

The Display options control how the oscilloscope acquires and displays waveforms. You can cause the oscilloscope to acquire and display the waveforms in one of the following modes:

- Normal
- Average
- Accumulate

The Display options also control the connect-the-dots display and grid display features.

Display Menu Map

The menu map on the next page illustrates all fields and the available options in the Display menu. The menu map will help you get an overview as well as provide you with a quick reference of what the Display menu contains.

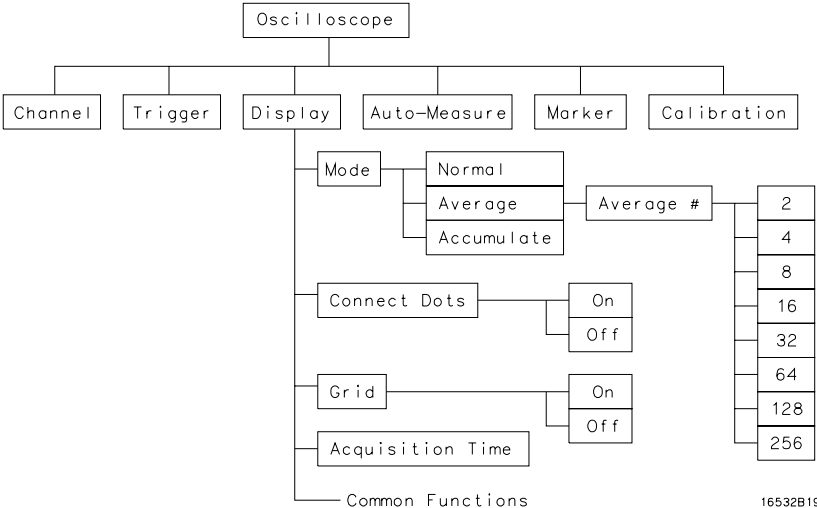

Display Field Menu Map

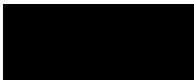

Mode Field

The Mode field determines how waveform information is acquired and displayed. When you touch the Mode field, a pop-up menu appears. You can select Normal, Average, or Accumulate from the pop-up. The default selection for the Mode field is Normal.

Normal Mode

In Normal mode, the oscilloscope acquires waveform data and displays the waveform acquired from that data. When the oscilloscope makes a new acquisition, it erases the previously acquired waveform from the display, and displays the newly acquired waveform. This is an on-going process for as long as the oscilloscope is running repetitively, or whenever you make a single mode run. That is; acquire data, erase display, display new data, acquire data, erase display, display new data, etc.

Average Mode

In Average mode, the oscilloscope averages the most recently acquired data points on a waveform with previously acquired data. Averaging helps eliminate random noise from your displayed waveforms.

When you select Average mode, a new field appears next to the Mode field which allows you to select the number of waveform acquisitions to average. When you touch the Average # field, the field will turn a light-blue color. When the field is light blue, you can change the number in the field by turning the knob. The number of averages can be set to 2, 4, 8, 16, 32, 64, 128, or 256. The default value for the Average # field is 8.

You can also change the value in the Average # field with the pop-up keypad. The keypad appears when you touch the Average # field when that field is light blue. The numbers you can enter are the same as with the knob (any power of two from 2 to 256). Any value entered from the keypad that is not a power of two will be rounded to the nearest power of two (from the choices available).

As an example of average mode usage, assume the Average # field is set to 16 and the Run mode is set to Repetitive. When you touch the Run field, the oscilloscope starts acquiring waveform data and averaging it. After the initial 16 waveforms are acquired, the oscilloscope momentarily displays the advisory message "Number of averages has been met." Once the initial 16 waveforms are acquired, all new data is weighed at 1/N and is averaged with the previous data. All data is retained.

If you set the Run mode to Single, acquisitions are not made until you touch the Run field. If Average # is set to 16, as in the previous example, the "Number of averages has been met" message will not be displayed until you have touched the Run field 16 times.

If you bring a waveform that is being averaged in the oscilloscope into the waveform display of another time correlated module, such as another oscilloscope or a timing analyzer, the waveform will not continue to average. Only the most recent acquisition, not the average trace data, will appear on the screen. To view an averaged mode trace with other time correlated waveforms, bring those other waveforms into the display of the oscilloscope that is setup for average mode (only oscilloscope signals acquired by that oscilloscope will be averaged on the display).

Panning or zooming an averaged waveform causes the waveform to redraw with only the most recent acquisition on the display.

Accumulate Mode

In Accumulate mode, the oscilloscope accumulates all waveform acquisitions and displays them on the screen without erasing the previously acquired waveforms. This is similar to infinite persistence on an analog storage oscilloscope. These acquisitions will stay on the display until Mode is changed, or until the waveform is adjusted by a control that causes the display to change, such as s/Div, Delay, or Connect Dots from On to Off.

When in Accumulate mode, the operation of the display grid follows special rules when turned on or off (refer to the Grid Field paragraph later in this chapter).

The waveforms that are generated in Accumulate mode cannot be stored to file or printed directly; only the latest waveform will be saved or printed. If your Agilent Technologies 16500 system has LAN capability, the accumulated waveforms can be accessed by FTPing to the /system/graphics directory. The accumulated data is in all of the three graphics files.

Connect Dots Field

The oscilloscope display can optionally be enhanced to show a better picture of a waveform. This is done by using the Connect Dots On or Connect Dots Off feature of the display. The default setting for the Connect Dots field is Off.

If an edge is fast enough (relative to the sample rate), the signal may begin to look like dots scattered around the display. This is because each sample is displayed as a single dot.

To give you a better idea of what the waveform looks like, the oscilloscope has a feature that connects the sample dots together. Touching the Connect Dots field will toggle the field between On and Off.

On

With Connect Dots On, each displayed sample is connected to the adjacent sample. The waveform displayed with Connect Dots set to On is better defined and easier to see.

Off

With Connect Dots Off, each sample is displayed separately; that is, it is not connected to the adjacent sample. The waveform displayed with Connect Dots set to Off is the default mode of operation.

Grid Field

The oscilloscope display can optionally be divided into horizontal and vertical grids by using the Grid On or Grid Off feature of the display. Touching the Grid field will toggle the field between On and Off. The default setting for the Grid field is Off.

On

Touching the Grid field when it reads Off will toggle the field to On, and will cause the screen to display a horizontal and vertical grid pattern.

In either Normal or Average modes, the grid can be turned On when the oscilloscope is not currently running and the grid will appear on screen immediately. If the oscilloscope is currently acquiring data, the grid will be drawn when the acquisition is completed. In Accumulate mode, the grid can be turned on at any time, but it will not be drawn until the next acquisition is completed or some change is made to the display screen that would cause the display to be erased and redrawn (that is: s/div, etc).

Off

Touching the Grid field when it reads On will toggle the field to Off, and will remove the grid pattern from the screen.

In either Normal or Average modes, the grid can be turned Off when the oscilloscope is not currently running and the grid will be erased from the screen immediately. If the scope is currently acquiring data, the grid will be erased when the current acquisition is completed. In Accumulate mode, the grid can be turned off at any time, but it will not be erased from the screen until some change is made to the display screen that would cause the display to be erased and redrawn (that is: s/div, etc).

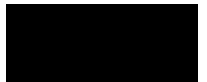

Acquisition Time Field

The Acquisition Time field time stamps each data acquisition. It is controlled by the real time system clock which is set up in the System Utility Menu. The real time clock cannot be modified from the Display menu. Refer to the *Agilent Technologies 16500 User's Reference* for details for setting the real time clock.

The Acquisition Time field will be blank at system power-up. It will show the date and time of any acquisition when you touch the Run field and make the first data acquisition. The Acquisition Time field is displayed to the right of the Grid field once data has been acquired.

Display Options Field

The Display Options field allows you to display either sample period information or marker value information on the oscilloscope menus. It is also the means by which you access the scope channel labeling menu.

The Display Options field appears on the Channel, Trigger, Display and Auto-Measure menus. The number of selections that appear when you touch the Display Options field will vary depending on whether or not any of the markers are enabled. If no markers are enabled, the oscilloscope menus will always display sample period information and touching the Display Options field will yield a single possible selection, Set Channel Labels. If either voltage or time markers are enabled, touching the Display Options field will reveal three possible selections, Set Channel Labels, Display Sample Period, and Display Marker Values.

Set Channel Labels

Selecting Set Channel Labels from the Display Options pop-up will take you to the Scope Channel Labels menu. This menu allows you to assign labels to each of the oscilloscope channels. These labels will subsequently appear in the channel label area to the left of the waveform display area. The oscilloscope channel labels appear on single trace waveforms only. The default scope labels are used for overlay and waveform math displays.

To specify a Scope Channel Label, touch the field corresponding to the oscilloscope input you wish to label. The default Scope Channel Labels are the cardslot and input number you see elsewhere on the oscilloscope menus. When you touch one of the channel label fields, an alpha-numeric keypad will appear on screen. If you need to change a character in the Scope Channel Label, you can use the knob to move the cursor to the desired position. Scope Channel Labels are limited to five characters in length. The Clear field will erase the entire label. When you are finished specifying the label, touch Done to exit the keypad.

When all channels have been labeled, touch the Done field to return to the oscilloscope menu. Any oscilloscope channels you don't label will retain their default label (cardslot and input number). To erase all scope channel labels for the oscilloscope, and return to the default oscilloscope channel labels, simply touch the Default field on the Scope Channel Labels menu.

Display Sample Period

Selecting the Display Sample Period option will cause the sample period information (see Sample Period Display in the Time Base Functions chapter) to be displayed on the scope menus. Sample period information is the default display option and is always displayed when markers are turned off.

Display Marker Values

Selecting the Display Marker Values option will cause the marker value information (see Marker Value Display in the Marker Options chapter) to be displayed on the oscilloscope menus. Marker values can only be selected when at least one of the markers have been enabled.

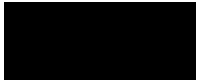

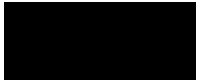

The Auto-Measure Menu

The Auto-Measure Menu

One of the primary features of the oscilloscope is its ability to make parametric measurements on displayed waveforms. This chapter provides details on how automatic measurements are performed and gives some tips on how to improve automatic measurement results.

You access the Auto-Measure menu by touching the menu field (top row, second from the left), then by selecting Auto-Measure from the pop-up menu that appears.

There are nine automatic measurements available in the automatic measurement menu:

- Period
- Risetime
- Falltime
- Frequency
- +Width
- -Width
- Vp_p
- Preshoot
- Overshoot

Auto-Measure Menu Map

The menu map on the next page illustrates all fields and the available options in the Auto-Measure menu. The menu map will help you get an overview as well as provide you with a quick reference of what the Auto-Measure menu contains.

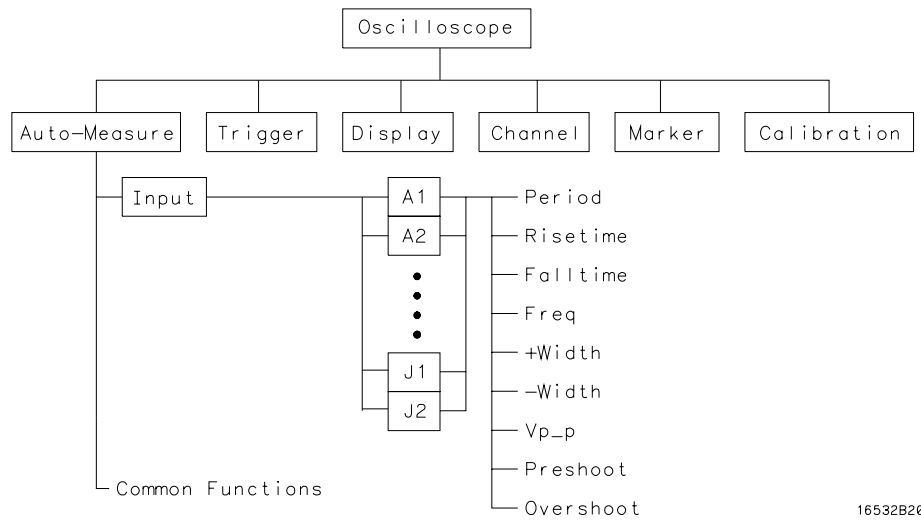

16532B20

Auto-Measure Menu Map

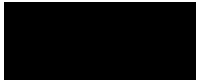

Automatic-Measurement Fields

There are two Automatic-Measurement fields. They are the Input field and the actual automatic measurement display. These fields are discussed in the following paragraphs.

Input Field

The Input field allows you to select the source of the waveform to be measured. When you touch this field, a pop-up menu appears showing the input sources. Be sure the proper source is selected for the input used. The options displayed in the Input pop-up menu are dependent upon how many cards are part of the oscilloscope module and in which slots they are installed. The default selection for the Input field is the lowest lettered and numbered input channel of the module.

Automatic Measurements Display

The tan-colored field in the middle row of the menu is called the automatic measurements display. This display shows the nine automatic measurements that you can make. The measurements that this display shows are:

Period	+Width
Risetime	-Width
Falltime	Vp_p
Freq	Preshoot
	Overshoot

See Also

"Automatic Measurement Algorithms" at the end of this chapter for an explanation of each of these fields.

Automatic Measurement Prerequisites

This section gives you some helpful pointers to help you make automatic measurements easier.

Measurement Setup Requirements

Measurements typically should be made at the fastest possible sweep speed in order to obtain the most accurate measurement possible. You can only make automatic measurements with data that is currently being displayed in the waveform display area. Keep the following in mind when making measurements:

- At least one full cycle of the waveform, with at least two like edges, must be displayed for Period and Freq measurements.
- A complete positive pulse must be displayed to make a +Width measurement.
- A complete negative pulse must be displayed to make a –Width measurement.
- The leading (rising) edge of the waveform must be displayed for Risetime, and rising edge Preshoot and Overshoot measurements.
- The trailing (falling) edge of the waveform must be displayed for Falltime, and falling edge Preshoot and Overshoot measurements.
- Risetime, Falltime, Preshoot, and Overshoot measurements will be more accurate if you expand the edge of the waveform by selecting a faster sweep speed.
- If the signal is clipped, the automatic measurements cannot be made.

Criteria Used for Making Automatic Measurements

If more than one waveform, edge, or pulse is displayed, the measurements are made on the first (leftmost) portion of the displayed waveform that can be used. When any of the defined measurements are requested, the oscilloscope first determines the top (100%) and base (0%) voltages of the waveform. From this information, it can determine the other important voltage values (10% voltage, 90% voltage, and 50% voltage) required to make the measurements. The 10% and 90% voltage values are used in the rise time and fall time measurements. The 50% voltage value is used for measuring frequency, period, and pulse width.

Automatic Measurement Algorithms

This section explains top and base voltages, then defines the measurement algorithms.

Top and Base Voltages

All measurements except V_{p-p} are calculated using the V_{top} (100% voltage) and V_{base} (0% voltage) levels of the displayed waveform. The V_{top} and V_{base} levels are determined from an occurrence density histogram of the data points displayed on the screen.

The digitizing oscilloscope displays 8-bit vertical voltage resolution. That is, the vertical axis of the display is divided into 2^8 voltage levels. Each of these 256 levels is called a quantization level. Each waveform has 500 data points displayed on the horizontal axis of the screen. Each of these 500 data points has one quantization level assigned to it. The histogram is calculated by adding the number of occurrences of each quantization level of the 500 displayed points on the displayed waveform.

The quantization level with the greatest number of occurrences in the top half of the waveform corresponds to the V_{top} level. The quantization level with the greatest number of occurrences in the bottom half of the waveform corresponds to the V_{base} level.

If V_{top} and V_{base} do not contain at least 5% of the 500 data points displayed on screen, V_{top} defaults to the maximum voltage ($V_{maximum}$) and V_{base} defaults to the minimum voltage ($V_{minimum}$) found on the display. An example of this case would be measurements made on sine or triangle waves.

From this information, the instrument can determine the 10%, 50%, and 90% points, which are used in most automatic measurements. The V_{top} or V_{base} of the waveform is not necessarily the maximum or minimum voltage present on the waveform. If a pulse has a slight amount of overshoot, it would be wrong to select the highest peak of the waveform as the top because the waveform proper rests below the perturbation.

Measurement Algorithms

Frequency (Freq)

The frequency of the first complete cycle displayed is measured using the 50% levels.

If the first edge on the display is rising, then

$$\mathbf{Freq} = \frac{1}{t_{\text{rising edge 2}} - t_{\text{rising edge 1}}}.$$

If the first edge on the display is falling, then

$$\mathbf{Freq} = \frac{1}{t_{\text{falling edge 2}} - t_{\text{falling edge 1}}}.$$

Period

The period is measured at the 50% voltage level of the waveform.

If the first edge on the display is rising, then

$$\mathbf{Period} = t_{\text{rising edge 2}} - t_{\text{rising edge 1}}.$$

If the first edge on the display is falling, then

$$\mathbf{Period} = t_{\text{falling edge 2}} - t_{\text{falling edge 1}}.$$

Peak-to-Peak Voltage (Vp_p)

The maximum and minimum voltages for the selected source are measured:

$$\mathbf{Vp_p} = V_{\text{maximum}} - V_{\text{minimum}}$$

where V_{maximum} and V_{minimum} are the maximum and minimum voltages present on the selected source.

Positive Pulse Width (+Width)

Pulse width is measured at the 50% voltage level.

If the first edge on the display is rising, then

$$+\text{Width} = t_{\text{falling edge 1}} - t_{\text{rising edge 1}}.$$

If the first edge on the display is falling, then

$$+\text{Width} = t_{\text{falling edge 2}} - t_{\text{rising edge 1}}.$$

Negative Pulse Width (-Width)

Negative pulse width is the width of the first negative pulse on screen using the 50% levels.

If the first edge on the display is rising, then

$$-\text{Width} = t_{\text{rising edge 2}} - t_{\text{falling edge 1}}.$$

If the first edge on the display is falling, then

$$-\text{Width} = t_{\text{rising edge 1}} - t_{\text{falling edge 1}}.$$

Rise time

The rise time of the first displayed rising edge is measured. To obtain the best possible measurement accuracy, set the sweep speed as fast as possible while leaving the full leading edge of the waveform on the display. The rise time is determined by measuring time at the 10% and 90% voltage points on the rising edge:

$$\text{Rise time} = t_{90\%} - t_{10\%}$$

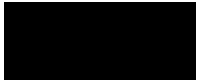

Fall time

Fall time is measured between the 10% and 90% points of the falling edge. To obtain the best possible measurement accuracy, set the sweep speed as fast as possible while leaving the falling edge of the waveform on the display:

$$\mathbf{Fall\ time} = t_{10\%} - t_{90\%}$$

Preshoot and Overshoot

Preshoot and Overshoot measure the perturbation on a waveform above or below the top and base voltages (see the "Top and Base Voltages" section earlier in this chapter). These measurements use all data displayed on the screen; therefore, it is very important that only the data of interest be displayed. If you want to measure preshoot and overshoot on one edge of a waveform, then only display that edge. If you want to measure the maximum preshoot and overshoot on a waveform, then display several cycles of the waveform.

Preshoot is a perturbation before a rising or a falling edge and is measured as a percentage of the top-base voltage.

Overshoot is a perturbation after a rising or a falling edge and it is measured as a percentage of the top-base voltage.

If the measured edge is rising, then

$$\mathbf{Preshoot} = \left[\frac{V_{base} - V_{minimum}}{V_{top} - V_{base}} \right] \times 100$$

and,

$$\mathbf{Overshoot} = \left[\frac{V_{maximum} - V_{top}}{V_{top} - V_{base}} \right] \times 100.$$

If the measured edge is falling, then

$$\mathbf{Preshoot} = \left[\frac{V_{maximum} - V_{top}}{V_{top} - V_{base}} \right] \times 100$$

and,

$$\mathbf{Overshoot} = \left[\frac{V_{base} - V_{minimum}}{V_{top} - V_{base}} \right] \times 100.$$



The Waveform Selection Menu

The Waveform Selection Menu

This chapter shows you how to insert, replace, and delete input channels on the waveform display, and how to perform waveform math and overlay functions. Any of these operations can be performed from any of the oscilloscope menus except calibration.

The dark-blue channel label field to the left of the waveform display area shows the input channels that are being displayed. To access the Waveform Selection pop-up menu, you touch the channel label field twice (once to turn it light-blue then once more to access the menu). The menu lets you insert, delete, or replace an input channel, and choose channel modes. It also lets you select to view a waveform from another module when you are making intermodule measurements.

The oscilloscope module has the capability to display 96 waveforms – eight at any one time. When you have made more than eight waveforms accessible for display, some of them will not be in the waveform display area. To display them you touch the dark-blue channel label field once to turn it light blue then use the knob to scroll through all of the waveforms and select the ones you want displayed.

Waveform Selection Menu Map

The menu map on the next page illustrates all fields and the available options in the Waveform Selection menu. The menu map will help you get an overview as well as provide you with a quick reference of what the Waveform Selection menu contains.

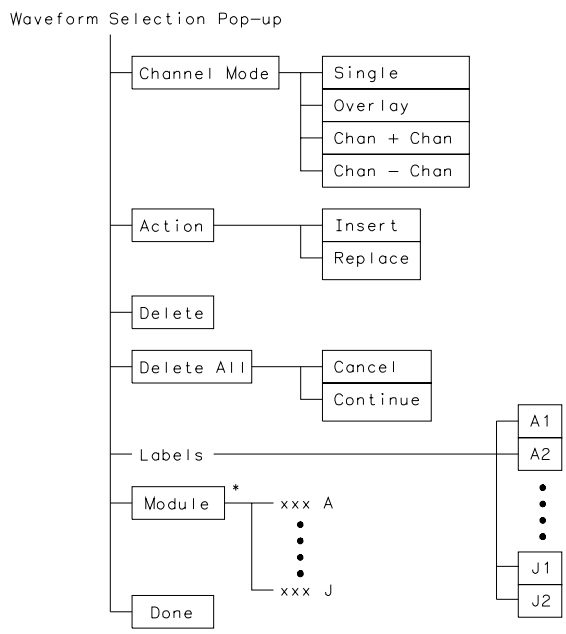

*Intermodule Group Run only

16532B22



Waveform Selection Menu Map

Module Field

The Module field in the waveform selection menu lets you select waveforms from more than one module when you are making intermodule measurements.

Selecting a Module in the Module Field

If you are running your modules in the mainframe independently, and you touch the Module field, the name of the module you are currently running will be displayed as the only option in the pop-up menu. When you touch that field, the message "Data correlatable only for modules under group run" is displayed. This will remind you that this field is only used in intermodule measurements.

If you are running intermodule measurements and you touch the Module field, the name of the modules you are running as part of the intermodule measurement will be displayed as options in the pop-up menu. The input labels for the module that you select from the pop-up menu will appear in the Labels field. Using the Action options (Replace and Insert) and the Delete option, you can select the input, or inputs, you wish to view, and where you wish to place them on the screen.

You can select up to 96 waveforms or combinations of waveforms for viewing on the display. You can view up to eight waveforms in the display area at any one time. To view selected waveforms that are off the screen, you touch the field to the left of the waveform display area to turn it light blue. Then use the knob to scroll through the waveforms to find the one you want displayed.

Channel Mode Field

Touching the Channel Mode field in the Waveform Selection field causes a pop-up menu to appear. This pop-up shows the channel mode selections available. The Channel Mode field lets you select how the waveform will be displayed. The options are Single mode, Overlay mode, Chan+Chan mode, and Chan–Chan mode.

Single Mode

This mode displays a single input channel in each waveform display area for which it is selected. It is the default mode for the oscilloscope module. This mode is also the only one that displays voltage markers.

Overlay Mode

This is a waveform mode that lets you take the signal from one channel input and compare it to the signal from another (or several other) channel input. It lets you put multiple waveforms on the same waveform display area – or overlay the waveforms.

Waveforms from separate modules cannot be overlaid when making an intermodule measurement.



Example

To overlay the waveform on Input 1 with the waveform on Input 2:

Touch the Channel Mode field on the display, then when the pop-up appears, touch the Overlay field.

Turn the knob so that the bottom input in the channel label field is highlighted in white.

Then touch the Action field until Insert is displayed.

Next, touch the Input 1 label in the Labels field, then touch Input 2 in the Labels field.

Input 1 and Input 2 waveforms, shown as X1,X2 (where X is the slot letter of the module) are then displayed in the top channel label field.

After you have touched the Done key in the pop-up, you may need to touch the s/Div field and change the sweep speed in order to more easily see differences in the overlaid waveforms.

Input 1 will now be overlaid on Input 2 in the waveform display area.

No voltage values for the overlaid waveforms will appear in the channel label field to the left of the waveform display area.

Overlaid waveforms are scaled and offset (respectively), or in relationship to each other, but the value in the V/Div field does not necessarily correlate to the overlay waveform display tick marks.

Waveform Math (Chan+Chan Mode)

This is a waveform mode that lets you take the signal from one channel input and add it to the signal from another channel input.

Waveforms from separate modules cannot be added together when making an intermodule measurement.

Example

To add the waveform on Input 1 to the waveform on Input 2:

Touch the Channel Mode field on the display, then when the pop-up appears, touch the Chan+Chan field.

Turn the knob so that the bottom input in the channel label field is highlighted in white.

Then touch the Action field until Insert is displayed.

Touch the Input 1 label in the Labels field, then touch Input 2 in the Labels field.

Input 1 and Input 2 waveforms, shown as $X1+X2$ (where X is the slot letter of the module) are then displayed in the channel label field.

Now touch the Done key in the pop-up to display the waveform. The display now shows input 2 added to input 1. The resultant waveform is displayed in white in the waveform display.

If T Markers are turned on and V Markers are turned off, voltage values for this waveform will appear in the channel label field to the left of the waveform display area.



Waveform Math (Chan–Chan Mode)

This is a waveform math mode that lets you take the signal on one channel and subtract it from the signal on the other channel.

Waveforms from separate modules cannot be subtracted from each other when making an intermodule measurement.

Example

To subtract the waveform on Input 2 from the waveform on Input 1:

Touch the Channel Mode field on the display, then when the pop-up appears, touch the Chan–Chan field.

Turn the knob so that the bottom input in the channel label field is highlighted in white.

Then touch the Action field until Insert is displayed.

Next touch the Input 1 label in the Labels field, then touch Input 2 in the Labels field.

Input 1 and Input 2 waveforms, shown as X1–X2 (where X is the slot letter of the module) are then displayed in the channel label field.

Touch the Done key in the pop-up to display the waveform. The display now shows input 2 subtracted from input 1. The resultant waveform is displayed in white in the waveform display.

If T Markers are turned on and V Markers are turned off, voltage values for this waveform will appear in the channel label field to the left of the waveform display area.

Action Field

The Action field is a toggle field that toggles between Replace and Insert. These options let you choose to replace or to insert an input channel in the waveform display area.

In single-card modules the waveform display shows input 1 as yellow and input 2 as green. If two cards are connected as one module, the second card input 1 is shown as blue and input 2 is shown as green.

Replacing a Channel

Touching the Action field in the Waveform Selection pop-up causes the Action field to toggle between Insert and Replace. To replace a channel, you touch the Action field to toggle it to Replace.

Turning the knob slightly in each direction controls which input channel in the channel label field is highlighted in white. The channel highlighted in white is the channel that will be replaced. You replace the channel highlighted in white with the channel you touch in the Labels field.

Inserting a Channel

Inserting an input channel works similar to replacing a channel. Touching the Action field in the Waveform Selection pop-up causes the Action field to toggle between Insert and Replace. To insert a channel, you touch the Action field to toggle it to Insert.

Turning the knob slightly in each direction controls which input channel in the channel label field is highlighted in white. The channel you insert will be inserted below the channel highlighted in white. To insert a channel, you touch the channel in the Labels field that you want to insert below the channel highlighted in white.

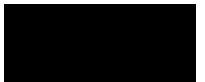

Delete All Field

The Delete All field in the Waveform Selection pop-up menu lets you delete all of the currently displayed channel inputs from the waveform display area. The pop-up selections for this field are Continue and Cancel

Cancel

Selecting Cancel from the Delete All pop-up menu allows you to change your mind about deleting all currently displayed inputs. Touching this field causes the pop-up to disappear. No changes are made to the display choices made prior to touching the Delete All field.

Continue

Selecting Continue from the Delete All pop-up menu causes all of the currently displayed inputs to be deleted. Touching this field also causes the pop-up to disappear.

Delete Field

The Delete field in the Waveform Selection pop-up menu lets you delete channel inputs from the waveform display area.

Deleting a Channel

You use the knob to highlight the input channel in the channel label field that you want to delete. You then touch the Delete field in the Waveform Selection pop-up to delete the highlighted channel input from the channel label field, and hence, from the waveform display area. The input channel highlighted in white will be deleted when you remove your finger from the Delete field. If you change your mind, slide your finger off the Delete field before lifting it.

Labels Field

The Labels field in the Waveform Selection pop-up menu lets you pick the channels you wish to display on the screen. You use this field in conjunction with the Action and Channel Mode fields to make your display choices when running your mainframe modules independently. For intermodule runs, you

also use the Module field to choose the module that contains the input channels you wish to display.

Waveform Size Field

The Waveform Size field accesses a selection menu which contains choices that scale the displayed waveforms to different sizes. Use this feature to increase the number of waveforms in the display or to make viewing better for just a few.

Best Fit

When Best Fit is used, the analyzer picks the largest font, either small, medium, or large, that allows all waveforms to be displayed.

Small

The small font will allow 24 waveforms to be displayed.

Medium

The medium font will allow 16 waveforms to be displayed.

Large

The large font will allow 8 waveforms to be displayed.

Done Field

When you are finished making all of your selections in the Waveform Selection pop-up menu, you touch the Done field to enter the selections and return to the waveform display. The choices you made while in the Waveform Selection pop-up will be implemented on the screen.



Specifications and Characteristics

Specifications and Characteristics

This chapter lists the specifications and characteristics. The specifications are the performance standard against which the product is tested.

The characteristics are not specifications, but are included as additional information.

For complete information on the test procedures used to verify product performance, refer to the optional Service Guide, available through your Agilent Technologies Sales Office.

Operating System

For the Agilent Technologies 16500B mainframe, both the 16533A and the 16534A require 16500B operating system V 3.03 or later to operate. For the Agilent Technologies 16500C mainframe, operating system V 1.00 or later is required.

Specifications

The specifications are the performance standards against which the 16533A/34A Oscilloscope is tested.

Bandwidth*:

16533A - dc to 250 MHz (realtime, dc coupled)

16534A - dc to 500 MHz (realtime, dc coupled)

Time Interval Measurement Accuracy **:** $\pm[(0.005\% \text{ of } \Delta t) + (2 \times 10^{-6} \times \text{delay setting}) + 100 \text{ ps}]$

DC Offset Accuracy*: $\pm(1.0\% \text{ of channel offset} + 2.0\% \text{ of full scale})$

Voltage Measurement Accuracy*: $\pm(1.25\% \text{ of full scale} + \text{offset accuracy} + 0.016 \text{ V/div})$

Trigger Sensitivity*:	10mV-10V/div	4mV/div
dc to 50 MHz:	0.25 div	0.63 div
50 MHz to 250 MHz (16533A):	0.50 div	1.25 div
50 MHz to 500 MHz (16534A):	0.50 div	1.25 div

Input R: 1 M Ω \pm 1%
 50 Ω \pm 1%

* = Specifications valid within \pm 10 °C of self-calibration temperature

** Specification applies at the maximum sample rate. At lower rates, specification should be $\pm(0.005\% \times \Delta t) + (2 \times 10^{-6} \times \text{delay setting}) + (0.15 \times \text{sample interval})$ for bandwidth limited signals ($t_r = 1.4 \times \text{sample interval}$).

Sample interval is defined as $\frac{1}{\text{samplerate}}$

Characteristics

The characteristics are not specifications, but are included as additional information.

VERTICAL (at BNC Input):

Vertical Sensitivity: 4 mV/div to 10 V/div Range (1:1 Probe) in 1:2:4 increments

DC Offset Range (1:1 Probe):	Vertical Sensitivity	Available Offset
	4mV - 100mV/div	+/- 2V
	100mV - 400mV/div	+/- 10V
	400mV - 2.5V/div	+/- 50V
	2.5V - 10V/div	+/- 250V

Probe Factors: Any integer ratio from 1:1 to 1000:1



Maximum Safe Input Voltage: 1 M Ω : +/-250V (dc+ac, 10KHz), CAT I
50 Ω : 5 V rms, CAT I

Channel-to-Channel Isolation: (With Channels at equal sensitivity)

dc to 50 MHz:	40 dB
50 MHz to 250 MHz (16533A):	30 dB
50 MHz to 500 MHz (16534A):	30 dB

Number of Channels: 2,4,6,8 simultaneous channels using the same trigger OR up to 10 with independent triggers for each pair of channels. Maximum of 20 channels with Agilent 16501A expansion frame.

Rise Time*: 1.4 ns (16533A) and 700 ps (16534A)

Vertical (dc) Gain Accuracy:** +/-1.25% of full scale

Input Coupling: 1 M Ω : ac, dc
50 Ω : dc only

Input C: Approximately 7 pF

Probes Included: Two Agilent Technologies 10441A probes:10:1, 10 M Ω , 9 pF, 2 meter

* Rise time is calculated from $t_r = \frac{0.35}{bandwidth}$

** Vertical gain accuracy decreases 0.08% per °C from software calibration temperature

HORIZONTAL:

Time Base Range: 0.5 ns/div to 5 s/div

Time base Resolution: 10 ps

Delay Pre-trigger Range: 81.8 sec, 5 divisions

Delay Post-trigger Range: 2.5×10^3 seconds

TRIGGERING:

Trigger Level Range: Within display window (vertical offset +/- 2 divisions)

Trigger Modes:

Immediate: Triggers immediately after arming condition is met.

Edge: Triggers on rising or falling edge from channel 1 or channel 2.

Pattern: Triggers on entering or exiting a specified pattern across two channels.

Auto Trigger: Self-triggers if no trigger condition is found within approximately 50 ms after arming.

Events Delay: The trigger can be set to occur on the nth edge or pattern, as specified by the user.

Intermodule: Arms another measurement module or triggers the rear panel BNC.

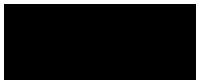

Supplemental Characteristics

Digitizer

A/D Resolution: 8 bits (1 part in 256) real time, 4 vertical divisions (+/- 0.4%).

Digitizing Rate

Up to 1 Gigasample per second (16533A).

Up to 2 Gigasample per second (16534A).

Digitizing Technique: Real-time digitizing; each 32,768 samples are acquired on a single acquisition.

Acquisition Memory Size: 32,768 samples per channel.

Waveform Record Length: 32,768 points.

Waveform Display

Displayed Waveforms Eight waveform windows maximum, with scrolling across 96 waveforms.

Display Formats Waveforms can be displayed in an overlapping and/or non-overlapping format. Display capability of A-B and A+B is also provided.

Display Resolution 500 points horizontal, 240 points vertical.

Display Modes

Normal (Single) New acquisition replaces old acquisition on screen.

Accumulate New acquisition is displayed in addition to previous acquisitions until screen is erased.

Average New acquisitions are averaged with old acquisitions, with the updated waveform displayed until erased. Maximum number of averages is 256.

Overlay Up to 8 acquired waveforms from separate channels can be overlaid in the same display area.

Connect-the-dots Provides a display of the sample points connected by straight lines.

Waveform Reconstruction When there is insufficient data to fill every horizontal location, a post acquisition reconstruction filter fills in missing data points for time base < 50 ns/div.

Waveform Math Display capability of A-B and A+B functions is provided.

Measurement and Display Functions

Time Markers Two vertical markers, X and O, are provided for measurements of time and voltage. Capabilities are: measure voltage at point where X and O markers cross each analog waveform; measure time from trigger to X, trigger to O, and X to O; automatic marker placement by specifying percentage of edge, edge number, and rising or falling edge type; run until X to O > than, < than, in range, and not in range provides selective event search; X to O statistics (mean, max, and min) provide analysis of time interval deviation.

Voltage Markers Two horizontal markers, A and B, are provided for voltage measurements. These markers can each be placed on any acquisition channel trace. A delta voltage display provides delta V between markers on the same channel or between channels.

Automatic Search Searches for a percentage voltage level at a positive or negative edge, count adjustable from 1 to 100.

Auto Search Statistics Mean, maximum, and minimum values for elapsed time from X to O markers for multiple runs. Number of valid runs and total number of runs available.



Automatic Measurements: The following pulse parameter measurements can be performed automatically.

- Frequency
- Rise time
- + pulse width
- Period
- Fall time
- -pulse width
- V_{p_p}
- Preshoot
- V* amplitude
- Overshoot

(*gives difference between top and base voltages; only available over bus)

Grid Graticules can be displayed in background of waveform.

Setup Aids

Autoscale: Autoscales the vertical and horizontal ranges, offset, and trigger level to display the input signals. Requires a frequency between 50 Hz and 250 MHz.

Presets Scales the vertical range, offset, and trigger level to predetermined values for displaying ECL or TTL waveforms.

Calibration Vertical, trigger, delay, and all defaults. Calibration factors stored in NV-RAM on the circuit board.

Probe Compensation Source External BNC supplies a square wave approximately 0.0 mV to -800 mV into the open circuit at approximately 1000 Hz.



Installation and Operator's Service

Preparing For Use

This section gives you instructions for preparing the oscilloscope module for use.

Power Requirements

All power supplies required for operating the oscilloscope are supplied through the backplane connector in the mainframe.

Operating Environment

The oscilloscope module's reliability is enhanced when operating the module within the following ranges:

- Temperature: +20 °C to +35 °C (+68 °F to +95 °F)
- Humidity: 20% to 80% noncondensing

Storage

Store or ship the oscilloscope in environments within the following limits:

- Temperature: -40 °C to + 75 °C
- Humidity: Up to 90% at 65 °C
- Altitude: Up to 15,300 meters (50,000 feet)

Protect the module from temperature extremes which cause condensation on the instrument.

To inspect the module

1 Inspect the shipping container for damage.

If the shipping container or cushioning material is damaged, keep them until you have checked the contents of the shipment and checked the instrument mechanically and electrically.

2 Check the supplied accessories.

3 Inspect the product for physical damage.

Check the module and the supplied accessories for obvious physical or mechanical defects. If you find any defects, contact your nearest Agilent Technologies Sales Office. Arrangements for repair or replacement are made, at Agilent Technologies' option, without waiting for a claim settlement.

To prepare the mainframe

CAUTION

Turn off the mainframe power before removing, replacing, or installing the module.

CAUTION

Electrostatic discharge can damage electronic components. Use grounded wrist straps and mats when performing any service to this module.

1 Turn off the mainframe power switch, then unplug the power cord. Disconnect any input or output connections.

2 Plan your module configuration.

If you are installing a one-card module, use any available slot in the mainframe, unless you also have an Agilent Technologies 16530/31 module in the mainframe. If there is an 16530/31 module in the mainframe, the 16534 module must be seated above the 16530/31 module.

If you are installing a multi-card module, use adjacent slots in the mainframe. See illustration on next page for multi-card combinations.

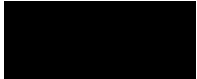

3 Loosen the thumb screws.

Cards or filler panels below the slots intended for installation do not have to be removed.

Starting from the top, loosen the thumb screws on filler panels and cards that need to be moved.

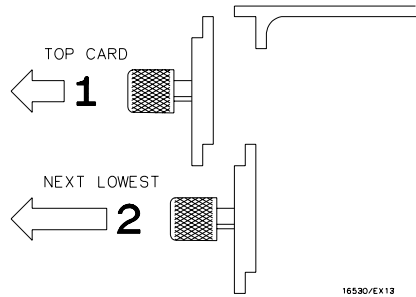

4 Starting from the top, pull the cards and filler panels that need to be moved halfway out.

CAUTION

All multi-card modules will be cabled together. Pull these cards out together to prevent damage to the cables and connectors.

5 Remove the cards and filler panels.

Remove the cards or filler panels that are in the slots intended for the module installation. Push all other cards into the card cage, but not completely in. This is to get them out of the way for installing the module.

Some modules for the Logic Analysis System require calibration if you move them to a different slot. For calibration information, refer to the Service Guides for the individual modules.

To install the module

The 16533/34A oscilloscope module functions as either a master or expander card. A single-card 16533/34A module provides 2 acquisition channels and a multi-card 16533/34A module can provide up to 8 acquisition channels that operate from a single trigger. The only requirements to configure a multi-card module are using more than one 16533/34A card, and interfacing the cards with master/expander trigger cables before applying power to the Agilent Technologies 16500B/C Logic Analysis System mainframe. Note that if an Agilent Technologies 16530 card is in the mainframe, the 16534 must be located above the 16530 for proper operation.

All cards in a multi-card module must be the same model. You cannot mix 16533A and 16534A cards in a single module.

To configure the 16533/34A module

- 1 Slide the cards above the slot for the 16533/34A module about halfway out of the mainframe.
- 2 Slide the 16533/34A module approximately halfway into the mainframe. If a multi-card module is being configured, all 16533/34A cards must be in adjacent slots.

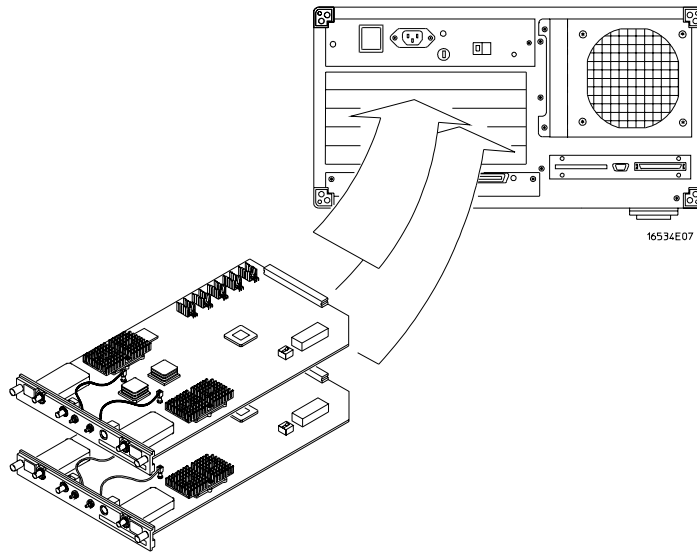

- 3 Position all cards and filler panels so that the endplates overlap.

4 Seat the cards and tighten the thumbscrews. DO NOT use a Torx screwdriver to tighten the thumbscrews.

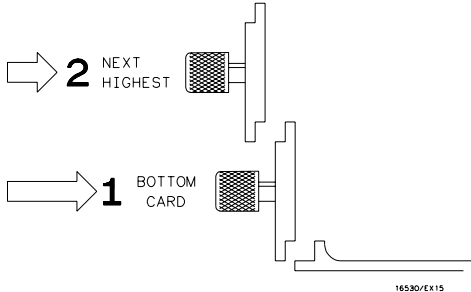

WARNING

For correct air circulation, filler panels must be installed in all unused card slots. Correct air circulation keeps the instrument from overheating. Keep any extra filler panels for future use.

5 To configure a multi-card module, use the master/expander trigger cable included with the accessory kit of each 16533/34A card. Starting with the top-most 16533/34A card, connect the ECL EXT TRIG OUT to the ECL EXT TRIG IN of the card immediately below. Repeat for all cards in the module.

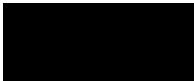
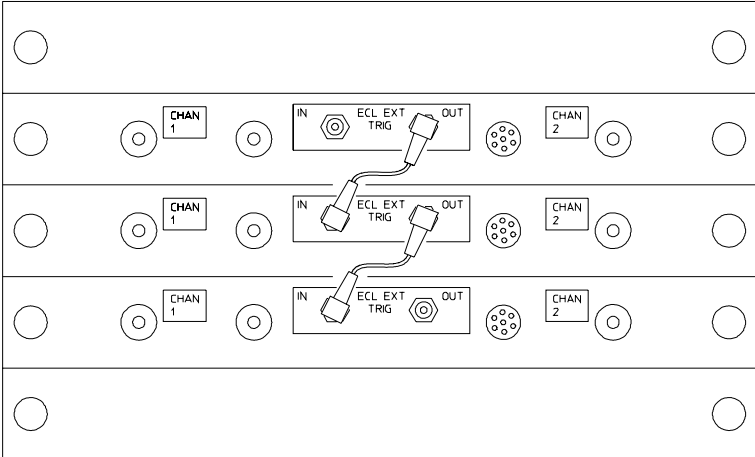

To reconfigure a multi-card module into single-card modules

To reconfigure a multi-card 16533/34A module into single-card modules, first remove power from the Agilent Technologies 16500 mainframe. Remove all master/expander trigger cables from the rear panel of each 16533/34A card in the module. Remove and reinstall each 16533/34A card as desired and reapply power to the mainframe.

Performing an operational accuracy calibration on each 16533/34A card is recommended.

To turn on the system

- 1 Connect the power cable to the mainframe.
- 2 Turn on the power switch.

To test the module

- If you need to deskew the channel-to-channel variations, go to "Calibrating and Adjusting", found later in this chapter.
- If you require a test to initially accept the operation, perform the self tests in chapter 3 of the optional Service Guide. The Service Guide can be ordered through your Agilent Technologies Sales Office.
- If you require a test to verify the specifications, start at the beginning of the "Testing Performance" chapter in the optional Service Guide.
- If the module does not operate correctly, go to the beginning of the "Troubleshooting" found in chapter 5 of the Service Guide.

To clean the module

With the instrument turned off and unplugged, use mild soap and water to clean the front of the module. Harsh soap might damage the water-based paint.

Calibrating and Adjusting

This section gives you instructions for calibrating and adjusting the oscilloscope. Adjustments to the oscilloscope include adjusting the CRT monitor assembly.

To periodically verify the performance of the analyzer, refer to the optional Service Guide.

Calibration frequency

The oscilloscope circuitry in the 16533/34A oscilloscope requires an operational accuracy calibration by the user or service department under any of the following conditions:

- at six months intervals or every 1,000 hours
- if the ambient temperature changes more than 10° C from the temperature at full calibration
- to optimize measurement accuracy

To test the oscilloscope circuitry against specifications, refer to "Testing Performance" in chapter 3 of the Service Guide.

Multi-card oscilloscope calibration

A complete operational accuracy calibration on a 16533/34A multi-card module requires the module to first be separated into single-card modules. The operational accuracy calibrations on the acquisition subsystem are done on the single-card modules. After reconfiguring the 16533/34A module into a multi-card module, the timebase operational accuracy calibrations are done.

To calibrate the oscilloscope

Equipment Required

Equipment	Critical Specification	Recommended Agilent Model/Part	Qty
Cable (2)	BNC, 9-inch (equal length)	8120-1838	2
Adapter	BNC (m)(m)	1250-1236	1
Adapter	BNC tee (m)(f)(f)	1250-0781	1
Adapter	BNC (f)/SMB (m)	1250-1236	1

Set up the equipment

CAUTION

The effects of ELECTROSTATIC DISCHARGE can damage components. Use grounded wrist straps and mats when you are performing any kind of service on this module.

The 16533/34A oscilloscope module contains a calibration PROTECT/UNPROTECT switch. This switch must be set to UNPROTECT before new calibration values from the operational accuracy calibration can be stored to nonvolatile RAM.

16533/34A multi-card modules must be separated into single card modules before performing the operational accuracy calibration on the acquisition circuitry.

- 1 Remove power from the Agilent Technologies 16500 mainframe. If a multi-card module is being calibrated, disconnect all Master/Expander Trigger Cables from the ECL EXT TRIG IN and OUT connectors on the rear panel of each 16533/34A card.
- 2 Pull out halfway all cards and filler panels located above the oscilloscope, then remove the filler panels and cards located above the oscilloscope.

- 3 Remove the 16533/34A module and set the PROTECT/UNPROTECT switch to the UNPROTECT position. On a multi-card module, the PROTECT/UNPROTECT switch on all cards must be set to UNPROTECT.

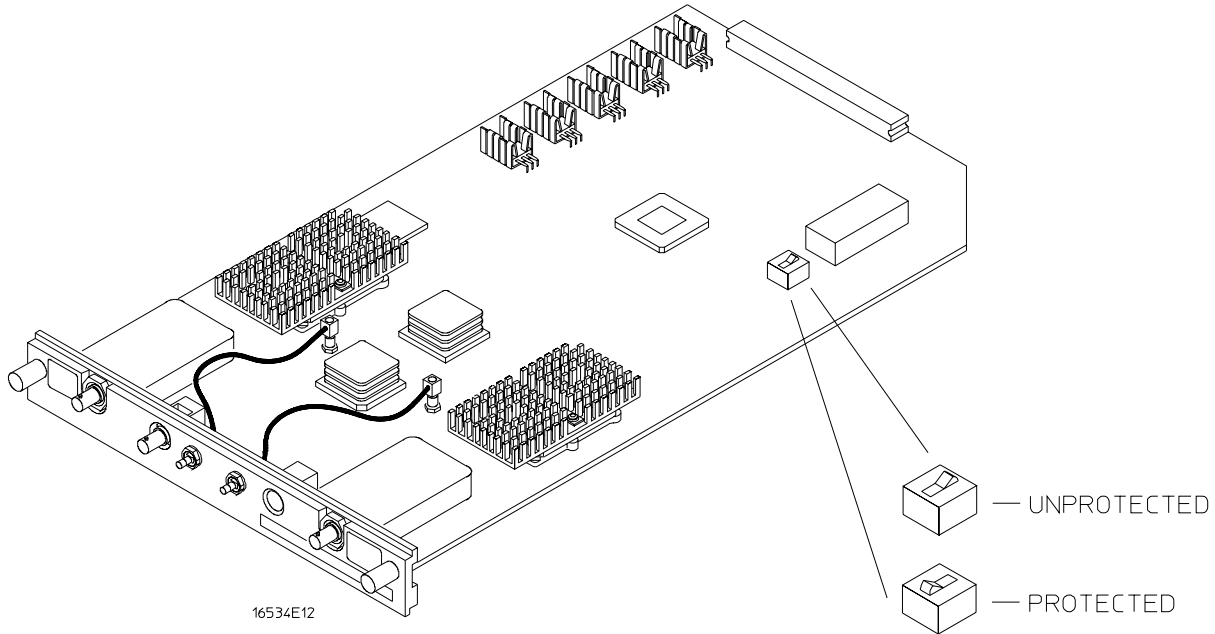

- 4 Reinstall the modules and filler panels.
- 5 Apply power to the Agilent Technologies 16500 mainframe. Allow the 16533/34A module to warm up approximately 30 minutes before doing the following steps in the self calibration.

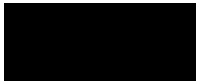

Self Cal menu calibrations

1 Load the default calibration factors.

Note that once the default calibration factors are loaded, all calibrations must be done. The calibration must be performed in the exact sequence listed below.

NOTE

The calibration PROTECT/UNPROTECT switch on the 16533/34A oscilloscope module must be set to UNPROTECT.

- a Touch the Module field, then at the pop-up menu touch the Scope card to be calibrated.
- b Touch the Menu field, then at the pop-up menu touch Calibration.
- c Touch the Mode field, then at the pop-up menu touch Service Cal.
- d Touch the Procedure field, then at the pop-up menu touch Default Values.
- e Touch the Start field, then follow the instructions on the display.

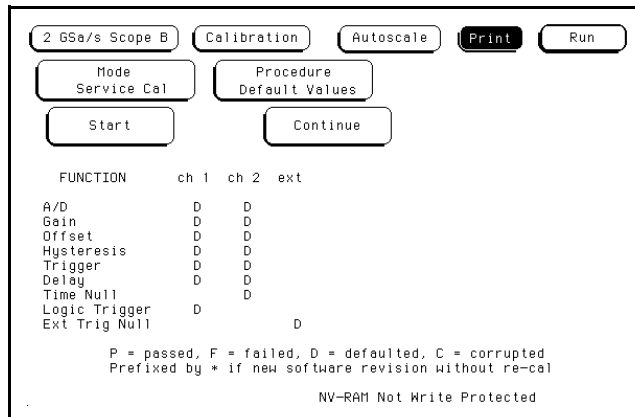

Messages will be displayed as each operational accuracy calibration routine is completed to indicate calibration has passed or failed. The resulting calibration factors are automatically stored to nonvolatile RAM at the conclusion of each calibration routine.

- 2** Calibrate Vert Cal of the Self Cal.
 - a** Connect two BNC 50- Ω , 9-inch cables to the BNC tee adapter. Once you touch Start, the instrument will prompt you to connect the cables to the appropriate locations on the rear panel of the instrument.
 - b** Touch the Mode field, then touch Self Cal from the pop-up menu.
 - c** Touch the Procedure field, then touch Vert Cal from the pop-up menu.
 - d** Touch the Channel field, then touch All from the pop-up menu.
 - e** Touch the Start field and follow the instructions on the display.
 - f** After completion of Vertical Calibration, remove the cables from the instrument.
- 3** Calibrate Delay of the Self Cal.
 - a** Obtain a BNC 50- Ω , 9-inch cable. Once you touch Start, the instrument will prompt you to connect the cable to the appropriate location on the rear panel of the instrument.
 - b** Touch the Procedure field, then touch Delay from the pop-up menu.
 - c** Touch the Channel field, then select channel 1.
 - d** Touch the Start field and follow the instructions on the display.
 - e** Repeat steps c and d for channel 2.
 - f** After completing all of the channel delay calibrations, remove the cable from the oscilloscope.
- 4** If a multi-card 16533/34A module is being calibrated, repeat steps 1 through 3 for the next 16533/34A card until all cards have been completed.
- 5** If a single-card 16533/34A module is being calibrated, proceed to step 6. If a multi-card 16533/34A module is being calibrated, perform the following steps before proceeding to step 6.
 - a** Remove power from the Agilent Technologies 16500 mainframe.

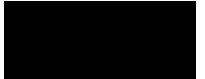

- b** Install the Master/Expander Trigger Cables on the ECL EXT TRIG IN and OUT connectors on the rear panel of each 16533/34A card. Starting with the top-most 16533/34A card, connect the ECL EXT TRIG OUT to the ECL TRIG IN of the card immediately below. Repeat for all cards in the module.

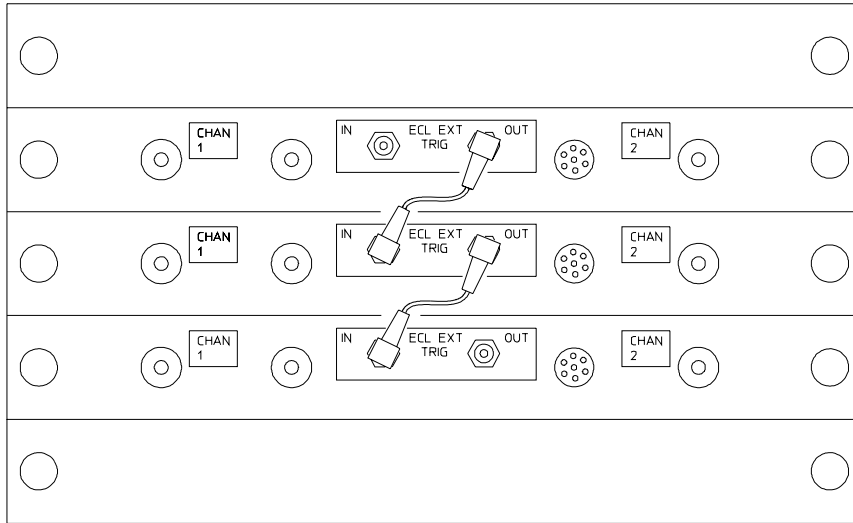

16534E04

- c** Reapply power to the Agilent Technologies 16500 mainframe.
 - d** When power-up is complete, Touch System, then touch Scope. Touch Channel, then touch Calibration.
- 6** Calibrate the Time Null of the Self Cal.
- a** Connect two BNC 50- Ω , 9-inch cables to the BNC tee adapter. Once you touch Start, the instrument will prompt you to connect the cables to the appropriate locations on the rear panel of the instrument.
 - b** Touch the Procedure field, then touch Time Null from the pop-up menu.
 - c** Touch the Start field and follow the instructions on the display.
 - d** After completion of the Time Null calibration, remove the cables from the instrument.

- 7** Calibrate the Logic Trigger of the Self Cal.
 - a** Obtain a BNC 50- Ω , 9-inch cable.
 - b** Touch the Procedure field, then touch Logic Trigger from the pop-up menu.
 - c** Touch the Start field and follow the instructions on the display.
 - d** After completion of the Logic Trigger calibration, remove the cable from the instrument.
 - 8** Calibrate Ext Trig Null of the Self Cal.
 - a** Connect a BNC 50- Ω , 9-inch cable to the BNC tee adapter. Connect the BNC 50 Ω (f)/SMB(m) adapter to one end of the BNC tee adapter using a BNC(m)(m) adapter. Once you touch Start, the instrument will prompt you to connect the cables to the appropriate locations on the rear panel of the instrument.
 - b** Touch the Procedure field, then touch Ext Trig Null from the pop-up menu.
 - c** Touch the Start field and follow the instructions on the display.
 - d** After completion of External Trigger Null Calibration, remove the cables from the instrument.
-

Protect the operational accuracy calibration factors

- 1** Remove power from the instrument. Pull out halfway all cards and filler panels located above the oscilloscope, then remove the filler panels and cards located above the oscilloscope.
- 2** Remove the 16533/34A module and set the PROTECT/UNPROTECT switch to the PROTECT position. On a multi-card module, the PROTECT/UNPROTECT switch on all cards must be set to PROTECT.
- 3** Reinstall the modules and filler panels.

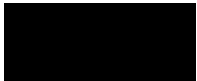

Glossary

acquisition Denotes one complete cycle of data gathering. One complete cycle gathers 32,768 samples of information and stores them in acquisition memory.

autoscale algorithm An algorithm that, based on the amplitude and period of the signals found, sets the vertical sensitivity in volts per division, offset, horizontal sweep speed in seconds per division, trigger level, and trigger slope for the trigger source input. Its purpose is to provide two to five cycles of a waveform that is displayed on the screen. The waveform is from the lowest numbered and lettered channel with a signal.

cancel autoscale The field that allows you to cancel doing an automatic scaling of the input signals. This is particularly important if you inadvertently touch the Autoscale field when you have your measurement configuration set. Automatically scaling your signals at this point could change your present configuration.

cancel run The field that allows you to cancel making an oscilloscope run for any reason once you have touched the Run field.

card A single 16533A or 16534A unit.

coupling field The field that sets the input impedance for the signal applied to channel 1 or channel 2 of the oscilloscope. Selectable values for each channel are $1M\Omega / DC$, $1M\Omega / AC$, and $50\Omega / DC$.

delay field The field that sets the horizontal position of the waveform on the screen. Delay time is measured from the trigger point. It is measured in seconds and is viewed in the Delay field. It can be set by using the knob or the keypad.

don't care Signifies that the state of the signal (high or low) is not pertinent to the measurement being performed.

edge mode The trigger mode that causes a trigger based on a single channel edge (either rising or falling).

high The positive-going portion of a logic signal. Used in pattern trigger measurements, it is represented by an H in the pattern selector.

horizontal sweep speed The time value that determines the horizontal scaling of the waveform to be displayed on the screen. It is measured in seconds per division and is viewed in the s/Div field. It is set by using the knob or the keypad.

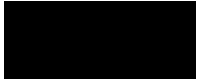

immediate mode The trigger mode that does not require a specific trigger condition (that is; an edge or a pattern).

input field The field that allows you to select a channel for vertical scaling.

intermodule menu The menu that lets you set up the instrument to make interactive measurements, either with other modules in the mainframe or with external modules.

low The negative-going portion of a logic signal. Used in pattern trigger measurements, it is represented by an L in the pattern selector.

manual markers mode The marker mode that lets you manually move the markers using the knob or the keypad.

menu field The field to the immediate right of the module field (see module field). It allows you to choose the menus related to the module shown in the module field.

module An oscilloscope unit. It may contain one card, or up to four cards connected with trigger cables.

module field The field in the upper-left corner of the screen. It

allows you to choose any of the modules in the mainframe as your working module. It also allows you to choose system options and inter-module options.

offset field The field that sets the vertical position of the waveform on the screen. Offset is the voltage represented at the center vertical tick mark in the waveform display. It is measured in volts and is viewed in the Offset field. It is set by the using knob or the keypad.

panning The action of moving the waveform along the timebase by varying the delay value in the Delay field. This action allows you to control the portion of acquisition memory that will be displayed on the screen. If you choose, you can view the entire waveform record in acquisition memory. This is normally done in single-shot mode.

pattern mode The trigger mode that allows you to set the oscilloscope to trigger on a specified combination of input signal levels.

probe field The field that sets the probe attenuation factor for the input signal applied to the oscilloscope. Selectable values from 1:1 to 1000:1 in increments of 1.

repetitive mode The field that causes the oscilloscope to start the next acquisition as soon as the previous acquisition has been completed and the data has been displayed (that is, to take single acquisitions repetitively).

run, repetitive mode *See* repetitive mode.

run, single mode *See* single mode

single mode The field that causes the oscilloscope to make a single data acquisition and display the results of that acquisition on the screen. In this mode, the Run field must be touched each time you want a new acquisition and, consequently, a new screen update.

source field The field that allows you to select a channel for edge triggering and trigger level setting.

toggle field A dark-blue field that has only two options. When the field is touched, the current option in that field will change (toggle) to its other option.

touchable field Any dark-blue field on the screen is a "touchable" field. When you touch a dark-blue field, the field toggles to another option, a pop-up menu appears, or the

field turns light-blue to activate the knob for that field.

trigger point The point at which the voltage on the signal source input waveform equals the trigger level voltage value set in the Level field of the trigger menu.

vertical sensitivity The voltage value that determines the amplitude of the waveform on the screen. It is measured in volts per division and is viewed in the V/Div field. It is set by using the knob or the keypad.

when field This field is part of the Pattern Mode menu. It is a toggle field that allows you to choose whether to trigger on the selected pattern when it is entered, exited or meets a duration specification.

zooming The action of expanding and contracting the waveform along the timebase by varying the value in the s/Div field. This action allows you to select specific portions of a particular waveform in acquisition memory that will be displayed on the screen. You can view any portion of the waveform record in acquisition memory. When used in conjunction with panning, zooming is very useful in displaying single-shot waveforms.

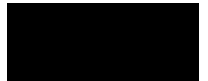

Index

-
- !
 - 32768 samples, 1-3 to 1-4
 - 8-bit vertical voltage resolution, 8-7
 - A**
 - Accumulate display Mode
 - See Display Mode, 7-5
 - acquisition memory
 - in repetitive run mode, 1-4
 - in single run mode, 1-3
 - acquisition memory sections, 4-7
 - Acquisition Time field, 7-8
 - acquisition time vs sweep time, 4-4
 - adding channels to the display, 9-9
 - at Level field, 5-12
 - at Level field percentage, 5-12
 - attenuation
 - See probe attenuation
 - auto markers pop-up menu options, default, 5-10
 - Auto-Measure menu, 8-2
 - Auto-Trig field, 6-10, 6-17
 - Auto-Trig Off field, when to use, 6-10
 - automatic markers
 - Run Until Time X-O field, 5-15 to 5-16
 - Slope field default, 5-13
 - at Level field, 5-12
 - at Level field default value, 5-12
 - Occur field, 5-13
 - Occur field, default value, 5-13
 - Run Until Time X- O field default, 5-15
 - Set on field, 5-11
 - Set on field default, 5-11
 - Slope field, 5-13
 - Statistics field, 5-14
 - type absolute, 5-12
 - type percent, 5-12
 - automatic measurements
 - +Width, 8-9
 - Width, 8-9
 - algorithms, 8-7
 - See also Auto-Measure
 - criteria used to make measurements, 8-6
 - display, 8-4
 - Falltime, 8-10
 - Frequency, 8-8
 - Input field, 8-4
 - measurement setup requirements, 8-5
 - measurements available, 8-2
 - Overshoot, 8-10
 - Period, 8-8
 - prerequisites, 8-5
 - Preshoot, 8-10
 - Risetime, 8-9
 - things to remember, 8-5
 - top and base voltages, 8-7
 - Vp_p, 8-8
 - automatic measurements display, 8-4
 - automatic time markers
 - percentage of top-to-base voltage value, 5-10
 - automatic/manual markers
 - setting, 5-17
 - autoscale, 2-2
 - algorithm, 2-4 to 2-5
 - cancel, 2-3
 - continue, 2-2 to 2-3
 - displaying the waveform, 2-5
 - finding the time base settings, 2-4
 - finding the vertical settings, 2-4
 - settings changed by, 2-6
 - trigger point location, 2-5
 - when a signal cannot be found, 2-5
 - autoscale field options, 2-3
 - autoscale run, 1-3
 - Average display mode
 - See Display Mode
 - B**
 - base and top voltages, 8-7
 - C**
 - Calibration, 11-9
 - cancel option of autoscale, 2-3
 - cancel option of run, 1-4
 - center screen field, 5-21
 - Channel
 - deleting, 9-10
 - Input field, 3-4
 - input identification, 3-4
 - inserting, 9-9
 - channel label field, 5-8
 - Channel menu map, 3-2
 - Channel/Pattern field, 6-12
 - cleaning, 11-8
 - Connect Dots field, 7-6
 - continue option of autoscale, 2-3
 - continue option of autoscale field, 2-2
 - Count Field, 6-16
 - Coupling field
 - default value, 3-7
 - selections, 3-7
 - setting input impedance, 3-7
 - D**
 - Data acquired at field, 4-8
 - data points displayed on the horizontal axis, 8-7
 - Delay field, 4-5 to 4-7
 - default value, 4-6
 - delay range, 4-6
 - delay time
 - definition, 4-5
 - from trigger point, 4-5
 - reference point, 4-5
 - resolution, 4-6
 - delay-by-events triggering, 6-9
 - deleting channels from the display, 9-10
 - deleting waveforms from the display, 9-10
 - Display
 - Connect Dots field, 7-6
 - overlying channels, 9-5
 - display divisions
 - horizontal, 4-3
 - vertical, 3-5 to 3-6
 - Display Mode
 - Accumulate, 7-5
 - Average, 7-4
 - Normal, 7-4
 - selections, 7-4
 - display options, 7-2
 - display, sample period value, 4-9
 - display, time marker value, 5-9
 - display, voltage marker value, 5-22
 - dotted vertical red line, 6-4
 - E**
 - ECL preset values, 3-8
 - Edge trigger, 3-8, 6-2, 6-5
 - Auto-Trig field, 6-10
 - Auto-Trig field default, 6-10
 - Count field default, 6-9
 - Count field range, 6-9
 - Level field, 6-7 to 6-8
 - Level field, default, 6-8
-

-
- Slope field, 6-9
 - Slope field default, 6-9
 - Source field, 6-6
 - events triggering, 6-9
- G**
- green line
 - Tx marker, 5-7
 - Group Run, Intermodule menu, 6-19
- H**
- histogram, 8-7
 - horizontal position, setting, 4-5
- I**
- Immediate trigger, 6-2
 - Immediate trigger mode, 6-18
 - Independent mode, Intermodule menu, 6-19
 - Input field, 3-4
 - automatic measurements, 8-4
 - input impedance
 - See Coupling field
 - inserting channels in the display, 9-9
 - inserting waveforms in the display, 9-9
 - Inspection, 11-3
 - Installation, 11-5
 - intermodule measurements, immediate trigger, 6-18
- K**
- keypad
 - changing markers Tx to To value, 5-6
 - changing s/Div, 4-3
 - changing V/Div, 3-5
 - knob
 - changing Trig to O time value, 5-9
 - changing Trig to O voltage value, 5-9
 - changing Tx to To time value, 5-8
 - changing x to o voltage value, 5-9
 - moving To marker, 5-9
- L**
- Level field, 6-7 to 6-8
- M**
- manual/automatic markers option setting, 5-17
 - markers
 - automatic, 5-10
 - automatic markers, 5-2
 - channel label field, 5-8
 - default selection, 5-2
 - manual options, 5-5
 - menu map, 5-2, 7-2, 8-2, 9-2
 - On field, 5-5
 - options, 5-2
 - Trig to O field, 5-5, 5-8 to 5-9
 - Trig to X field, 5-5, 5-7 to 5-8
 - Tx to To field, 5-5 to 5-6
 - voltage, 5-18
 - voltage, Va On field, 5-19
 - voltage, Va to Vb field, 5-21
 - voltage, Va Volts field, 5-19
 - voltage, Vb On field, 5-20
 - voltage, Vb Volts field, 5-20
 - markers, automatic
 - at Level field, 5-12
 - Done field, 5-11
 - Occur field, 5-13
 - Run Until Time X-O field, 5-15 to 5-16
 - set on field, 5-11
 - Slope field, 5-13
 - Statistics field, 5-14
 - Statistics field, default, 5-14
 - type absolute, 5-12
 - type field, 5-11
 - type percent, 5-12
 - maximum time interval measurements, 5-14
 - mean time interval measurements, 5-14
 - measurement algorithms, 8-8 to 8-10
 - menu maps
 - Channel, 3-2
 - markers, 5-2, 6-2, 7-2, 8-2, 9-2
 - message
 - Auto triggered, 6-10, 6-17
 - Autoscale is in progress, 2-2 to 2-3
 - No signal found, 2-5
 - Number of averages has been met, 7-5
 - Original setups restored, 2-5
 - Stop condition satisfied, 5-15 to 5-16
 - Waiting for Poststore, 4-4
 - Waiting for Prestore, 4-4
 - Waiting for Trigger, 6-10, 6-17
 - minimum time interval measurements, 5-14
 - Multicard module, 11-8
 - multimodule configuration
 - triggering, 6-2, 6-5, 6-11, 6-18
- N**
- negative time, 4-5
 - Next acquisition field, 4-8
 - Normal display Mode
 - See Display Mode, 7-4
- O**
- Occur field, 5-13
 - Occur field range, 5-13
 - Occur value, tips for using, 5-13
 - Offset field, 3-6
 - default value, 3-6
 - offset range and resolution, 3-6
 - Operating Environment, 11-2
 - overlying channels in the display, 9-5
 - overshoot, 8-10
- P**
- panning, 4-7
 - parameters changed by autoscale, 2-6
 - Pattern trigger, 6-2, 6-11
 - Auto-Trig field, 6-17
 - Channel/Pattern field, 6-12
 - Count field, 6-16
 - Count field default, 6-16
 - Count field range, 6-16
 - H, L, and X conditions, 6-12
 - When Entered field, 6-13
 - When Exited field, 6-13
 - When field default, 6-13
 - When Present field, 6-14
 - When Present field, 6-14
 - When Range field, 6-15
 - When Range values, 6-15
 - peak-to-peak voltage value, 5-10
 - positive time, 4-6
 - Preparation for use, 11-2
 - preset ECL values, 3-8
 - Preset field, 3-8
 - Preset field default setting, 3-8
-

-
- Preset field values, 3-8
 - preset TTL values, 3-8
 - preset values for ECL logic levels, 3-8
 - preset values for TTL logic levels, 3-8
 - preshoot, 8-10
 - probe attenuation factor, 3-7
 - probe attenuation factor range, 3-7
 - Probe field, 3-7
 - Probe field default value, 3-7
- R**
- red line at center of screen, 2-5
 - trigger point, 4-5
 - red line, dotted, vertical, 6-4
 - repetitive mode option, 1-4
 - repetitive run, 1-4
 - replacing a channel in the display, 9-9
 - resolution
 - delay time, 4-6
 - rounding of keypad entries, 4-3
 - run
 - autoscale, 1-3
 - mode, 1-3
 - run field, 1-3
 - run field pop-up, 1-3
 - run mode, 1-3
 - run parameters, 1-3
 - Run Until Time X-O, Less Than field resolution, 5-15
 - Run Until Time X-O field, 5-15 to 5-16
 - Run Until Time X-O, Greater Than field, 5-16
 - Run Until Time X-O, In Range field, 5-16
 - Run Until Time X-O, Less Than field, 5-15
 - Run Until Time X-O, Not In Range field, 5-16
 - Run/Stop options, 1-2
 - running the oscilloscope
 - using Autoscale, 1-3
- S**
- s/Div field, 4-3 to 4-4
 - s/Div field default value, 4-4
 - sample period, 4-8
 - sample period definition, 4-8
 - sample period field, 4-8 to 4-13
 - sample period value display, 4-9
 - sample period, changing, 4-8
 - sample rate, 4-8
 - scrolling, 4-7
 - Self cal, 11-12
 - Set on, MANUAL field, 5-17
 - Show field, 5-9, 5-22
 - single mode
 - panning, 4-7
 - zooming, 4-4
 - Single Run, 1-3 to 1-4
 - Slope field, 6-9
 - Source field, 6-6
 - Statistics field, 5-14
 - stop field, 1-4
 - Stop/Run options, 1-2
 - sweep speed, 4-3, 4-8
 - selecting, 4-3
 - sequence, 4-3
- T**
- Test, 11-8
 - time base functions, 4-2
 - time difference
 - See Tx to To time field
 - time marker value display, 5-9
 - To marker
 - dashed yellow line, 5-8
 - Trig to O field, 5-8
 - top and base voltages, 8-7
 - Trig to O field, 5-8 to 5-9
 - yellow border, 5-8
 - Trig to O time value resolution, 5-8
 - Trig to X default value, 5-7 to 5-8
 - Trig to X field, 5-7 to 5-8
 - green border, 5-7
 - Trig to X time value resolution, 5-7
 - trigger
 - default, 6-2
 - Edge, 6-2
 - See also Edge trigger
 - events counter, 6-10
 - Immediate, 6-2, 6-18
 - Immediate, use, 6-18
 - marker, 6-4
 - marker, at zero delay, 6-7
 - menu map, 6-2
 - modes, 6-2
 - multimodule configuration, 6-2, 6-5, 6-11, 6-18
 - Pattern, 6-2
 - Pattern trigger, 6-11
 - point, 6-4, 6-7
 - setting the trigger point, 6-7 to 6-8
 - source, 6-6
 - trigger level voltage value, 6-7
 - trigger point range, 6-8
 - trigger Mode field, 6-2
 - trigger point, 5-7 to 5-8
 - trigger point location, 2-5
 - trigger point, dotted red line, 4-5
 - trigger qualifier, 6-9
 - triggering, delay-by-events, 6-9
 - triggering, events, 6-9
 - truncation of keypad entries, 3-5
 - TTL preset values, 3-8
 - Tx marker, 5-7
 - Tx to To field, 5-6
- U**
- unsynchronized waveform, 6-8, 6-10
- V**
- V/Div field, 3-5
 - V/Div field default value, 3-5
 - Vbase, 8-7
 - vertical position
 - See Offset field
 - vertical sensitivity range, 3-5
 - vertical sensitivity sequence, 3-5
 - vertical voltage resolution, 8-bit, 8-7
 - Vmaximum, 8-7
 - Vminimum, 8-7
 - voltage marker value display, 5-22
 - voltage markers, 5-18
 - voltage values at Tx and To markers
 - channel label field, 5-8
 - Vp_p, 8-7
 - Vtop, 8-7
- W**
- waveform
 - deleting, 9-10
 - inserting, 9-9
 - unsynchronized, 6-8, 6-10
 - viewing the entire record, 4-7
 - waveform math
-

adding channels, 9-7
subtracting channels, 9-8
waveform size field, 9-11
When field, 6-13 to 6-15

X

X marker
Trig to X field, 5-7

Y

yellow line
To marker, 5-8

Z

zooming, 4-4

© Copyright Agilent Technologies 1992 - 2002
All Rights Reserved.

MS-DOS[®] is a US registered trademark of Microsoft Corporation.

Reproduction, adaptation, or translation without prior written permission is prohibited, except as allowed under the copyright laws.

Document Warranty

The information contained in this document is subject to change without notice.

Agilent Technologies makes no warranty of any kind with regard to this material, including, but not limited to, the implied warranties or merchantability and fitness for a particular purpose.

Agilent Technologies shall not be liable for errors contained herein or for incidental or consequential damages in connection with the furnishing, performance, or use of this material.

Safety

This apparatus has been designed and tested in accordance with IEC Publication 348, Safety Requirements for Measuring Apparatus, and has been supplied in a safe condition. This is a Safety Class I instrument (provided with terminal for protective earthing). Before applying power, verify that the correct safety precautions are taken (see the following warnings). In addition, note the external markings on the instrument that are described under "Safety Symbols."

Warning

- Before turning on the instrument, you must connect the protective earth terminal of the instrument to the protective conductor of the (mains) power cord. The mains plug shall only be inserted in a socket outlet provided with a protective earth contact. You must not negate the protective action by using an extension cord (power cable) without a protective conductor (grounding). Grounding one conductor of a two-conductor outlet is not sufficient protection.
- Only fuses with the required rated current, voltage, and specified type (normal blow, time delay, etc.) should be used. Do not use repaired fuses or short-circuited fuseholders. To do so could cause a shock of fire hazard.

- Service instructions are for trained service personnel. To avoid dangerous electric shock, do not perform any service unless qualified to do so. Do not attempt internal service or adjustment unless another person, capable of rendering first aid and resuscitation, is present.
- If you energize this instrument by an auto transformer (for voltage reduction), make sure the common terminal is connected to the earth terminal of the power source.
- Whenever it is likely that the ground protection is impaired, you must make the instrument inoperative and secure it against any unintended operation.
- Do not operate the instrument in the presence of flammable gasses or fumes. Operation of any electrical instrument in such an environment constitutes a definite safety hazard.
- Do not install substitute parts or perform any unauthorized modification to the instrument.
- Capacitors inside the instrument may retain a charge even if the instrument is disconnected from its source of supply.
- Use caution when exposing or handling the CRT. Handling or replacing the CRT shall be done only by qualified maintenance personnel.

Safety Symbols



Instruction manual symbol: the product is marked with this symbol when it is necessary for you to refer to the instruction manual in order to protect against damage to the product.



Hazardous voltage symbol.



Earth terminal symbol: Used to indicate a circuit common connected to grounded chassis.

WARNING

The Warning sign denotes a hazard. It calls attention to a procedure, practice, or the like, which, if not correctly performed or adhered to, could result in personal injury. Do not proceed beyond a Warning sign until the indicated conditions are fully understood and met.

CAUTION

The Caution sign denotes a hazard. It calls attention to an operating procedure, practice, or the like, which, if not correctly performed or adhered to, could result in damage to or destruction of part or all of the product. Do not proceed beyond a Caution symbol until the indicated conditions are fully understood or met.

Product Warranty

This Agilent Technologies product has a warranty against defects in material and workmanship for a period of one year from date of shipment. Some newly manufactured products may contain remanufactured parts which are equivalent to new in performance. During the warranty period, Agilent Technologies will, at its option, either repair or replace products that prove to be defective.

For warranty service or repair, this product must be returned to a service facility designated by Agilent Technologies.

For products returned to Agilent Technologies for warranty service, the Buyer shall prepay shipping charges to Agilent Technologies and Agilent Technologies shall pay shipping charges to return the product to the Buyer. However, the Buyer shall pay all shipping charges, duties, and taxes for products returned to Agilent Technologies from another country.

Agilent Technologies warrants that its software and firmware designated by Agilent Technologies for use with an instrument will execute its programming instructions when properly installed on that instrument. Agilent Technologies does not warrant that the operation of the instrument software, or firmware will be uninterrupted or error free.

Limitation of Warranty

The foregoing warranty shall not apply to defects resulting from improper or inadequate maintenance by the Buyer, Buyer-supplied software or interfacing, unauthorized modification or misuse, operation outside of the environmental specifications for the product, or improper

site preparation or maintenance.

No other warranty is expressed or implied. Agilent Technologies specifically disclaims the implied warranties or merchantability and fitness for a particular purpose.

Exclusive Remedies

The remedies provided herein are the buyer's sole and exclusive remedies. Agilent Technologies shall not be liable for any direct, indirect, special, incidental, or consequential damages, whether based on contract, tort, or any other legal theory.

Assistance

Product maintenance agreements and other customer assistance agreements are available for Agilent Technologies products.

For any assistance, contact your nearest Agilent Technologies Sales Office.

Certification

Agilent Technologies certifies that this product met its published specifications at the time of shipment from the factory. Agilent Technologies further certifies that its calibration measurements are traceable to the United States National Institute of Standards and Technology, to the extent allowed by the Institute's calibration facility, and to the calibration facilities of other International Standards Organization members.

About this edition

This is the *Agilent Technologies 16533A 1-GSa/s and 16534A 2-GSa/s Digitizing Oscilloscope User's Reference*.

Publication number
16534-97014, March 2002
Printed in Malaysia.

Print history is as follows:
16534-97012, January 2000
16534-97009, February 1999
16534-97008, August 1997
16534-97007, December 1996

New editions are complete revisions of the manual. Many product updates do not require manual changes and manual corrections may be done without accompanying product changes. Therefore, do not expect a one-to-one correspondence between product updates and manual updates.

DECLARATION OF CONFORMITY

according to ISO/IEC Guide 22 and EN 45014

Manufacturer's Name: Agilent Technologies
Manufacturer's Address: Digital Design Product Generation Unit
1900 Garden of the Gods Road
Colorado Springs, CO 80907 USA

declares, that the product

Product Name: Digitizing Oscilloscope Module
Model Number(s): 16533A and 16534A
Product Option(s): All

conforms to the following Product Specifications:

Safety: IEC 1010-1:1990+A1 / EN 61010-1:1993
UL 3111
CSA-C22.2 No. 1010.1:1993

EMC: CISPR 11:1990 / EN 55011:1991 Group 1 Class A
IEC 555-2:1982 + A1:1985 / EN 60555-2:1987
IEC 555-3:1982 + A1:1990 / EN 60555-3:1987 + A1:1991
IEC 801-2:1991 / EN 50082-1:1992 4 kV CD, 8 kV AD
IEC 801-3:1984 / EN 50082-1:1992 3 V/m, {1kHz 80% AM, 27-1000 MHz}
IEC 801-4:1988 / EN 50082-1:1992 0.5 kV Sig. Lines, 1 kV Power Lines

Supplementary Information:

The product herewith complies with the requirements of the Low Voltage Directive 73/23/EEC and the EMC Directive 89/336/EEC and carries the CE marking accordingly.

This product was tested in a typical configuration with Agilent Technologies test systems.

Colorado Springs, 04/03/95

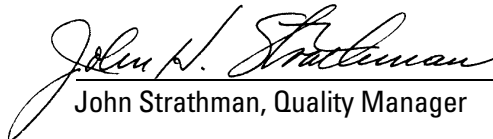
John Strathman, Quality Manager

European Contact: Your local Agilent Technologies Sales and Service Office or Agilent Technologies GmbH, Department ZQ / Standards Europe, Herrenberger Strasse 130, D-71034 Böblingen Germany (FAX: +49-7031-14-3143)

Product Regulations

Safety IEC 1010-1:1990+A1 / EN 61010-1:1993
UL 3111
CSA-C22.2 No.1010.1:1993

EMC This Product meets the requirement of the European Communities (EC)
EMC Directive 89/336/EEC.



Emissions EN55011/CISPR 11 (ISM, Group 1, Class A equipment)

Immunity	EN50082-1	Code ¹	Notes ²
	IEC 555-2	1	
	IEC 555-3	1	
	IEC 801-2 (ESD) 4kV CD, 8kV AD	1	
	IEC 801-3 (Rad.) 3 V/m	1	
	IEC 801-4 (EFT) 0.5 kV, 1kV	1	

¹ Performance Codes:

- 1 PASS - Normal operation, no effect.
- 2 PASS - Temporary degradation, self recoverable.
- 3 PASS - Temporary degradation, operator intervention required.
- 4 FAIL - Not recoverable, component damage.

² Notes: (none)

Sound Pressure Level N/A