

---

# User's Guide

Publication Number 01660-97017

First Edition, November 1995

For Safety Information, Warranties, and Regulatory Information, see the pages at the end of this manual.

© Copyright Hewlett-Packard Company 1991 - 1995

All Rights Reserved.

---

## HP 1660CS-Series Logic Analyzers

---

# HP 1660CS-Series Logic Analyzers

The HP 1660CS-series logic analyzers are 100-MHz state/500-MHz timing logic analyzers and 1 GSa/s digitizing oscilloscopes.

## **Logic Analyzer Features**

- 130 data channels and 6 clock/data channels in the HP 1660CS
- 96 data channels and 6 clock/data channels in the HP 1661CS
- 64 data channels and 4 clock/data channels in the HP 1662CS
- 32 data channels and 2 clock/data channels in the HP 1663CS
- 3.5-inch flexible disk drive and 540 MB hard disk drive
- HP-IB, RS-232-C, and Centronics interfaces
- Variable setup/hold time
- 4 K memory on all channels with 8 K in half-channel mode
- Marker measurements
- 12 levels of trigger sequencing for state and 10 levels of trigger sequencing for timing
- 100 MHz time tagging and number-of-states tagging
- Full programmability
- DIN mouse and keyboard support

## **Oscilloscope Features**

- 8000 samples per channel
- Automatic pulse parameters
  - displays time between markers, acquires until specified time between markers is captured, performs statistical analysis on time between markers
- Lightweight miniprobes

Options include Ethernet LAN Interface, Programmer's Guide, and Service Guide

---

## In This Book

This User's Guide shows you how to use the HP 1660CS-series logic analyzer. It contains measurement examples, field and feature definitions, and a basic service guide. Refer to this manual for information on what the menu fields do and how they are used. This manual covers all HP 1660CS-series analyzers.

The User's Guide is divided into four parts. The first part, chapters 1 through 4, covers general product information you need to use the logic analyzer. The second part, chapters 5 and 6, contains detailed examples to help you use your analyzer in performing complex measurements. The third part, chapters 7 through 9, contains reference information on the hardware and software, including the analyzer menus and how they are used. There are sections for each analyzer menu and a separate chapter on System Performance Analysis. The fourth part, chapters 10 through 12, provides a basic service guide.

<b>1</b>	<b>The Logic Analyzer at a Glance</b>	
<b>2</b>	<b>Connecting Peripherals</b>	
<b>3</b>	<b>Using the Logic Analyzer</b>	
<b>4</b>	<b>Using the Trigger Menu</b>	
<b>5</b>	<b>Triggering Examples</b>	
<b>6</b>	<b>File Management</b>	
<b>7</b>	<b>Reference</b>	
<b>8</b>	<b>System Performance Analysis (SPA) Software</b>	
<b>9</b>	<b>Concepts</b>	
<b>10</b>	<b>Troubleshooting</b>	
<b>11</b>	<b>Specifications</b>	
<b>12</b>	<b>Operator's Service</b>	
	<b>Glossary</b>	
	<b>Index</b>	



---

# Contents

## **1 Logic Analyzer Overview**

To make a measurement 1-4

## **2 Connecting Peripherals**

To connect a mouse 2-3

To connect a keyboard 2-4

To connect to an HP-IB printer 2-5

To connect to an RS-232-C printer 2-7

To connect to a parallel printer 2-8

To connect to a controller 2-9

## **3 Using the Logic Analyzer**

Accessing the Menus 3-3

To access the System menus 3-4

To access the Analyzer menus 3-6

To access the Scope menus 3-8

Using the Analyzer Menus 3-10

To label channel groups 3-10

To create a symbol 3-12

To examine an analyzer waveform 3-14

To examine an analyzer listing 3-16

To compare two listings 3-18

The Inverse Assembler 3-20

To use an inverse assembler 3-20

## **4 Using the Trigger Menu**

Specifying a Basic Trigger 4-3

To assign terms to an analyzer 4-4

To define a term 4-5

To change the trigger specification 4-6

Changing the Trigger Sequence 4-7

To add sequence levels 4-8

To change macros 4-9

Setting Up Time Correlation between Analyzers 4-10

To set up time correlation between two state analyzers 4-11

To set up time correlation between a timing and a state analyzer 4-11

Arming and Additional Instruments 4-12

To arm another instrument 4-12

To arm the oscilloscope with the analyzer 4-13

To receive an arm signal from another instrument 4-15

Managing Memory 4-16

To selectively store branch conditions (State only) 4-17

To place the trigger in memory 4-18

To set the sampling rates (Timing only) 4-19

## 5 Triggering Examples

### Single-Machine Trigger Examples 5-3

- To store and time the execution of a subroutine 5-4
- To trigger on the nth iteration of a loop 5-6
- To trigger on the nth recursive call of a recursive function 5-8
- To trigger on entry to a function 5-10
- To capture a write of known bad data to a particular variable 5-11
- To trigger on a loop that occasionally runs too long 5-12
- To verify correct return from a function call 5-13
- To trigger after all status bus lines finish transitioning 5-14
- To find the nth assertion of a chip select line 5-15
- To verify that the chip select line is strobed after the address is stable 5-16
- To trigger when expected data does not appear when requested 5-17
- To test minimum and maximum pulse limits 5-18
- To detect a handshake violation 5-20
- To detect bus contention 5-21

### Cross-Arming Trigger Examples 5-22

- To examine software execution when a timing violation occurs 5-23
- To look at control and status signals during execution of a routine 5-24
- To detect a glitch 5-25
- To capture the waveform of a glitch 5-26
- To view your target system processing an interrupt 5-27
- To trigger timing analysis of a count-down on a set of data lines 5-28
- To monitor two coprocessors in a target system 5-29

### Special displays 5-30

- To interleave trace lists 5-31
- To view trace lists and waveforms on the same display 5-32

## 6 File Management

- Transferring Files Using the Flexible Disk Drive 6-3
- To save a configuration 6-4
- To load a configuration 6-6
- To save a listing in ASCII format 6-7
- To save a screen's image 6-8
- To load additional software 6-9

## 7 Reference

Configuration Capabilities 7-3

Probing 7-5



General-purpose probing system description 7-8

Oscilloscope probes 7-11

Assembling the probing system 7-12

Keyboard Shortcuts 7-16

Moving the cursor 7-16

Entering data into a menu 7-17

Using the keyboard overlays 7-17

Common Menu Fields 7-18

Print field 7-19

Run/Stop field 7-20

Roll fields 7-21

Disk Drive Operations 7-22

Disk operations 7-22

Autoload 7-24

Format 7-24

Pack 7-24

Load and Store 7-25



## The RS-232-C, HP-IB, and Centronics Interfaces 7-26

The HP-IB interface 7-27

The RS-232-C interface 7-27

The Centronics interface 7-28

## System Utilities 7-29

Real Time Clock Adjustments field 7-29

Update FLASH ROM field 7-29

Shade adjustments 7-30

## The Analyzer Configuration Menu 7-31

Type field 7-31

Illegal configuration 7-31

## The Analyzer Format Menu 7-32

Pod threshold field 7-32

State. acquisition modes (state only) 7-32

Timing acquisition modes (timing only) 7-33

Clock Inputs display 7-34

Pod clock field (State only) 7-34

Master and Slave Clock fields (State only) 7-37

Symbols field 7-40

Label fields 7-41

Label polarity fields 7-42

## The Analyzer Trigger Menu 7-43

Trigger sequence levels 7-43

Modify trigger field 7-43

Timing trigger macro library 7-44

State trigger macro library 7-46

Modifying the user macro 7-48

Resource terms 7-51

Arming Control field 7-54

Acquisition Control field 7-56

Count field (State only) 7-57

## Contents

The Analyzer Listing Menu 7-58

Markers 7-58

The Analyzer Waveform Menu 7-60

sec/Div field 7-60

Accumulate field 7-60

Delay field 7-60

Waveform label field 7-61

Waveform display 7-62

The Analyzer Mixed Display Menu 7-63

Interleaving state listings 7-63

Time-correlated displays 7-64

Markers 7-64

The Analyzer Chart Menu 7-65

Min and Max scaling fields 7-66

Markers/Range field 7-66

The Analyzer Compare Menu 7-67

Reference Listing field 7-68

Difference Listing field 7-68

Copy Listing to Reference field 7-69

Find Error field 7-69

Compare Full/Compare Partial field 7-69

Mask field 7-70

Bit Editing field 7-70

Oscilloscope Common Menus 7-71

Run/Stop options 7-71

Autoscale 7-72

Time base 7-73

## The Scope Channel Menu 7-74

- Offset field 7-74
- Probe field 7-75
- Coupling field 7-75
- Preset field 7-75

## The Scope Display Menu 7-76

- Mode field 7-76
- Connect Dots field 7-77
- Grid field 7-77
- Display Options field 7-78

## The Scope Trigger Menu 7-79

- Trigger marker 7-79
- Mode/Arm menu 7-79
- Level field 7-81
- Source field 7-82
- Slope field 7-83
- Count field 7-83
- Auto-Trig field 7-84
- When field 7-85
- Count field 7-87

## The Scope Marker Menu 7-88

- Manual time markers options 7-88
- Automatic time markers options 7-90
- Manual/Automatic Time Markers option 7-94
- Voltage Markers options 7-94
- Channel Label field 7-96

## The Scope Auto Measure Menu 7-97

- Input field 7-97
- Automatic measurements display 7-97
- Automatic measurement algorithms 7-99

## **8 System Performance Analysis (SPA) Software**

- System Performance Analysis Software 8-2
- What is System Performance Analysis? 8-4
- Getting started 8-6
- SPA measurement processes 8-8
- Using State Overview, State Histogram, and Time Interval 8-21
- Using SPA with other features 8-30

## **9 Concepts**

- The File System 9-3
  - Directories 9-4
  - File types 9-5
- Transitional Mode Theory 9-7
  - 125-MHz transitional mode 9-7
  - 250-MHz transitional mode 9-8
  - Other transitional timing considerations 9-11
- The Trigger Sequence 9-12
  - Trigger sequence specification 9-13
  - Analyzer resources 9-15
  - Timing analyzer 9-18
  - State analyzer 9-18
- Configuration Translation Between HP Logic Analyzers 9-19
- The Analyzer Hardware 9-21
  - HP 1660CS-series analyzer theory 9-22
  - Logic acquisition board theory 9-25
  - Oscilloscope board theory 9-28
- Self-tests description 9-32

## 10 Troubleshooting

Analyzer Problems 10-3

Intermittent data errors 10-3

Unwanted triggers 10-3

No activity on activity indicators 10-4

Capacitive loading 10-4

No trace list display 10-4

Preprocessor Problems 10-5

Target system will not boot up 10-5

Slow clock 10-6

Erratic trace measurements 10-7

Inverse Assembler Problems 10-8

No inverse assembly or incorrect inverse assembly 10-8

Inverse assembler will not load or run 10-9

Error Messages 10-10

". . . Inverse Assembler Not Found" 10-10

"No Configuration File Loaded" 10-10

"Selected File is Incompatible" 10-10

"Slow or Missing Clock" 10-11

"Waiting for Trigger" 10-11

"Must have at least 1 edge specified" 10-12

"Time correlation of data is not possible" 10-12

"Maximum of 32 channels per label" 10-12

"Timer is off in sequence level n where it is used" 10-13

"Timer is specified in sequence, but never started" 10-13

"Inverse assembler not loaded - bad object code." 10-13

"Measurement Initialization Error" 10-14

"Warning: Run HALTED due to variable change" 10-14

## 11 Specifications



- Accessories 11-2
- Specifications (logic analyzer) 11-3
- Specifications (oscilloscope) 11-4
- Characteristics (logic analyzer) 11-5
- Characteristics (oscilloscope) 11-5
- Supplemental characteristics (logic analyzer) 11-6
- Supplemental characteristics (oscilloscope) 11-9
- Operating environment 11-13

## 12 Operator's Service



- Preparing For Use 12-3
  - To inspect the logic analyzer 12-4
  - To apply power 12-4
  - To set the line voltage 12-5
  - To degauss the display 12-6
  - To clean the logic analyzer 12-6
  - To test the logic analyzer 12-6
- Calibrating the oscilloscope 12-7
  - Set up the equipment 12-7
  - Load the default calibration factors 12-8
  - Self Cal menu calibrations 12-9
- Troubleshooting 12-11
  - To use the flowcharts 12-12
  - To check the power-up tests 12-14
  - To run the self-tests 12-15
  - To test the auxiliary power 12-22



---

# Logic Analyzer Overview

---

# HP 1660CS-Series Logic Analyzer

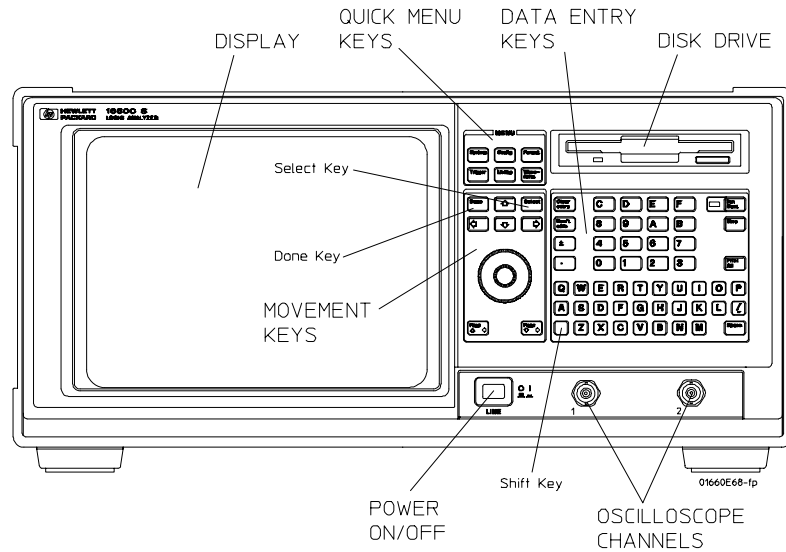

## Select Key

The Select key action depends on the type of field currently highlighted. If the field is an option field, the Select key brings up an option menu or, if there are only two possible values, toggles the value in the field. If the highlighted field performs a function, the Select key starts the function.

## Done Key

The Done key saves assignments and closes pop-up menus. In some fields, its action is the same as the Select key.

## Shift Key

The shift key, which is blue, provides lowercase letters and access to the functions in blue on some of the keys. You do not need to hold the shift key down while pressing the other key — just press the shift key first, and then the function key.

## Knob

The knob can be used in some fields to change values. These fields are indicated by a side view of the knob placed on top of the field when it is selected. The knob also scrolls the display and moves the cursor within lists. If you are using a mouse, you can do the same actions by holding down the right button of the mouse while dragging.



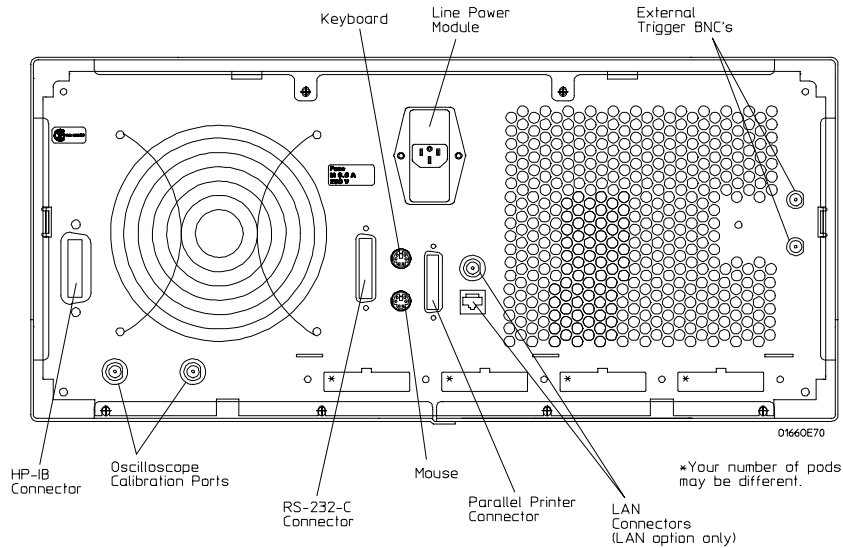
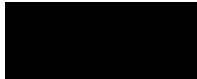

**Line Power Module**

Permits selection of 110-120 or 220-240 Vac and contains the fuses for each of these voltage ranges.

**External Trigger BNCs**

The External Trigger BNCs provide the "Port In" and "Port Out" connections for the Arm In and Arm Out of the Trigger Arming Control menu.

**RS-232-C, HP-IB, and Parallel Printer Connectors**

The RS-232-C connector is a standard DB-25 connector for RS-232-C printer or controller. The HP-IB connector is a standard HP-IB connector for connecting an HP-IB printer or controller. The Parallel Printer connector is a standard Centronics connector for connecting a parallel printer.

**Oscilloscope Calibration Ports**

Provides signals for operational accuracy calibration for the oscilloscope and the oscilloscope/probe together to optimize performance.

**LAN Connectors (with LAN option only)**

Connects the logic analyzer to your local Ethernet network. The BNC connector on top accepts 10Base2 ("thinlan"). The UTP connector below the BNC connector accepts 10Base-T ("ethertwist").

---

## To make a measurement

For more detail on any of the information below, see the referenced chapters or the Logic Analyzer Training Kit. If you are using a preprocessor with the logic analyzer, some of these steps may not apply.

### Map to target

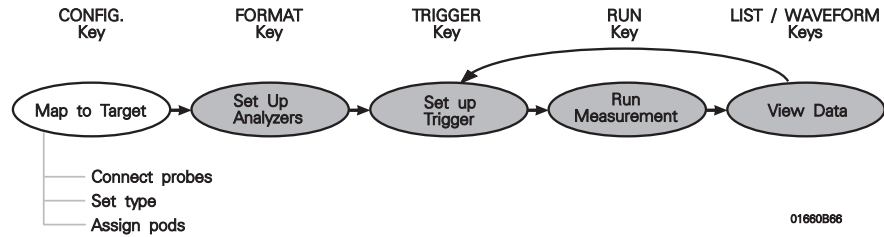

**Connect probes** Connect probes from the target system to the logic analyzer to physically map the target system to the channels in the logic analyzer. Attach probes to a pod in a way that keeps logically-related channels together. Remember to ground the pod.

### See Also

"Probing" in Chapter 7 for more detail on grounding and constructing probes.

**Set type\*** When the logic analyzer is turned on, Analyzer 1 is named Machine 1 and is configured as a timing analyzer, and Analyzer 2 is off. To use state analysis or software profiling, you must set the type of the analyzer in the Analyzer Configuration menu. You can only use one timing analyzer at a time.

**Assign pods\*** In the Analyzer Configuration menu, assign the connected pods to the analyzer you want to use. The number of pods on your logic analyzer depends on the model. Pods are paired and always assigned as a pair to a particular analyzer.

\* If you load a configuration file, this step is not necessary.

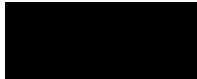

### Set up analyzers\*

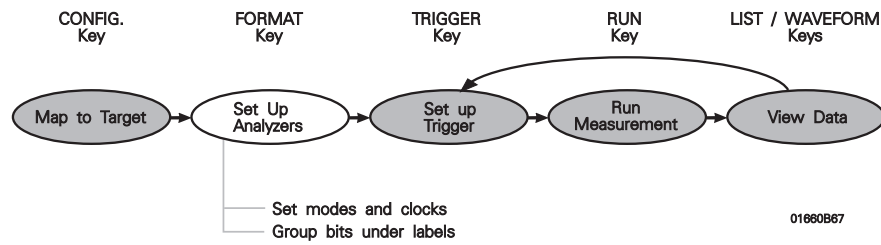

**Set modes and clocks** Set the state and timing analyzers using the Analyzer Format menu. In general, these modes trade channel count for speed or storage. The state analyzer also provides for complicated clocking. If your state clock is set incorrectly, the data gathered by the logic analyzer might indicate an error where none exists.

**See Also**

"The Format Menu" in Chapter 7 for more information on modes and clocks.

**Group bits under labels** The Analyzer Format menu indicates active pod bits. You can create groups of bits across pods or subgroups within pods and name the groups or subgroups using labels.

\* If you load a configuration file, this step is not necessary.

### Set up trigger\*

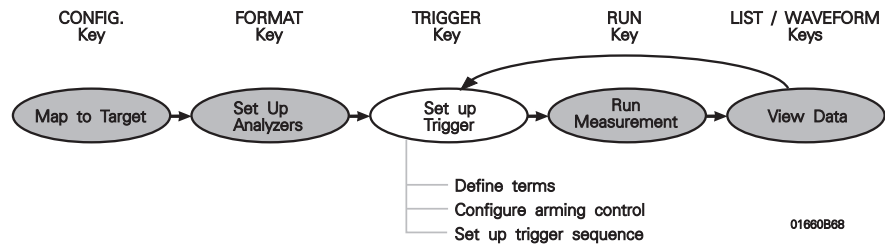

**Define terms** In the Analyzer Trigger menu, define trigger variables called terms to match specific conditions in your target system. Terms can match patterns, ranges, or edges across multiple labels.

**Configure Arming Control** Use Arming Control if

- you want to correlate the triggers and data of both analyzers
- you want to use the logic analyzer to trigger an external instrument or the built-in oscilloscope, or
- you want to use an external instrument or the built-in oscilloscope to trigger the logic analyzer.

**Set up trigger sequence** Create a sequence of steps that control when the logic analyzer starts and stops storing data and filters which data it will store. For common tasks, you can use a trigger macro to simplify the process or use the user-defined macros to loop and jump in sequence. You can also set the oscilloscope to trigger on a complex pattern.

### See Also

Chapter 4, "Using the Trigger Menu" and Chapter 5, "Triggering Examples" for more information on setting up a trigger.

"The Trigger Sequencer" in Chapter 9 for more information about the trigger sequence mechanism.

"To save a configuration" and "To load a configuration" in Chapter 6 for instructions on saving and loading the setup so you don't have to repeat setting up the analyzer and trigger.

\* If you load a configuration file, this step is not necessary.

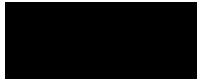

## Run measurement

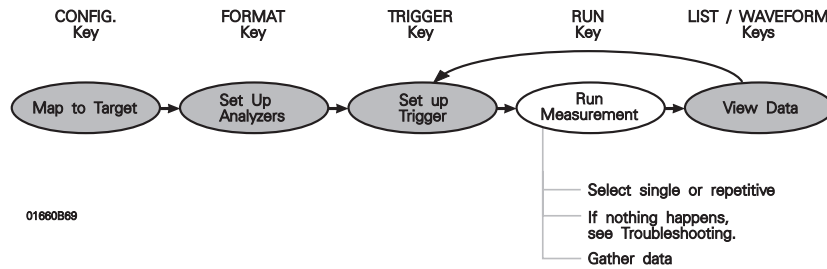

**Select single or repetitive** From any Analyzer or Scope menu, select the field labeled Run in the upper right corner to start measuring, or press the Run key. A single run will run once, until memory is full; a repetitive run will go until you select Stop or until a stop measurement condition that you set in the markers menu is fulfilled.

### See Also

"Markers Field" and "Scope Markers" in Chapter 7 for more information on markers and stop measurement conditions.

**If nothing happens, see Troubleshooting.** When you start a run, your analyzer menu changes to one of the display menus or a status message pops up. If nothing happens, press the Stop key or select Cancel. If the analyzer still does not display any measurements, see Chapter 10, "Troubleshooting."

**Gather data** You can gather statistics automatically by going to a Waveform or Listing menu, turning on markers, and setting patterns for the X and O markers. You can set the logic analyzer to stop if certain conditions are exceeded, or just use the markers to count valid runs.

### See Also

"Markers Field," "Scope Markers," and "Scope Auto-measure" in Chapter 7 for more information on markers.

## View data

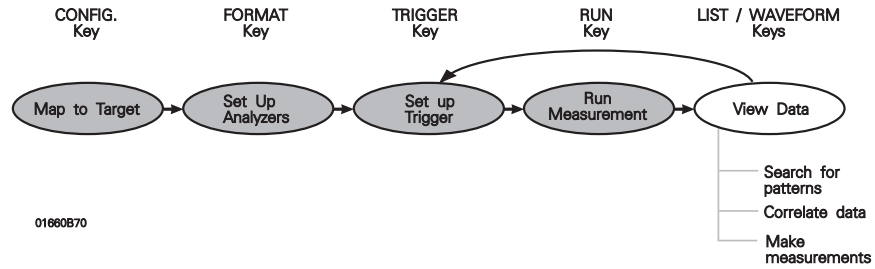

**Search for patterns** In both the Waveform and Listing menus you can use symbols and markers to search for patterns in your data. In the Analyzer Waveform or Analyzer Listing menu, toggle the Markers field to turn the pattern markers on and then specify the pattern. When you switch views, the markers keep their settings.

**Correlate data** You can correlate data by setting Count Time in your state analyzer's Trigger menu and then using interleaving and mixed display. Interleaving correlates the listings of two state analyzers. Mixed display correlates a timing analyzer waveform and a state analyzer listing, or a state analyzer and an oscilloscope waveform, or a state analyzer and both timing and oscilloscope waveforms. To correlate oscilloscope data, the oscilloscope arm mode must be set to Immediate. The System Performance Analysis (SPA) Software does not save a record of actual activity, so it cannot be correlated with either timing or state mode.

**Make measurements** The markers can count occurrences of events, measure durations, and collect statistics, and SPA provides high-level summaries to help you identify bottlenecks. To use the markers, select the appropriate marker type in the display menu and specify the data patterns for the marker. To use SPA, go to the SPA menu, select the most appropriate mode, fill in the parameters, and press Run.

### See Also

Chapter 8, "System Performance Analysis (SPA) Software" for more information on using SPA.

"The Waveform Menu" and "The Listing Menu" in Chapter 7 for additional information on the menu features.



---

## Connecting Peripherals

---

# Connecting Peripherals

Your HP 1660CS-series logic analyzer comes with a PS2 mouse. It also provides connectors for a keyboard, Centronics (parallel) printer, and HP-IB and RS-232-C devices. This chapter tells you how to connect peripheral equipment such as the mouse or a printer to the logic analyzer.

## **Mouse and Keyboard**

You can use either the supplied mouse and optional keyboard, or another PS2 mouse and keyboard with standard DIN connector. The DIN connector is the type commonly used by personal computer accessories.

## **Printers**

The logic analyzer communicates directly with HP PCL printers supporting the printer control language or with other printers supporting the Epson standard command set. Many non-Epson printers have an Epson-emulation mode. HP PCL printers include the following:

- HP ThinkJet
- HP LaserJet
- HP PaintJet
- HP DeskJet
- HP QuietJet

You can connect your printer to the logic analyzer using HP-IB, RS-232-C, or the parallel printer port. The logic analyzer can only print to printers directly connected to it. It cannot print to a networked printer.



## To connect a mouse

Hewlett-Packard supplies a mouse with the logic analyzer. If you prefer a different style of mouse you can use any PS2 mouse with a standard PS2 DIN interface.

- 1 Plug the mouse into the mouse connector on the back panel. Make sure the plug shows the arrow on top.
- 2 To verify connection, check the System External I/O menu for a mouse box.

The mouse box is on the right side above the Settings fields. If the logic analyzer was displaying the System External I/O menu when you plugged in the mouse, the menu won't update until you exit and then return to it.

The mouse pointer looks like a plus sign (+). To select a field, move the pointer over it and press the left button. To duplicate the front-panel knob, hold down the right button while moving the mouse. Moving the mouse up or to the right duplicates turning the knob clockwise. Moving the mouse down or to the left duplicates turning the knob counterclockwise.

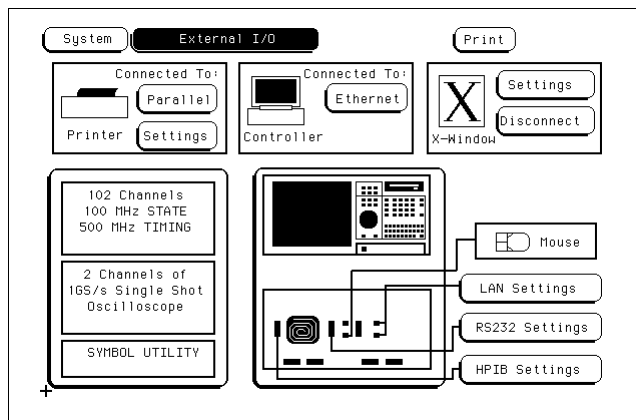

System External I/O menu showing mouse installed

---

## To connect a keyboard

You can use either the HP-recommended keyboard, HP E2427B, or any other keyboard with a standard DIN connector.

- 1 Plug the keyboard into the keyboard connector on the back panel.
- 2 To verify, check the System External I/O menu for a keyboard box.

The keyboard box is on the right side, above the Settings fields. If the logic analyzer was displaying the System External I/O menu while you plugged the keyboard in, the menu won't update until you exit and then return to it.

The keyboard cursor is the location on the screen highlighted in inverse video. To move the cursor, use the arrow keys. Pressing Enter selects the highlighted field. The primary keyboard keys act like the analyzer's front-panel data entry keys.

### See Also

"Keyboard Shortcuts" in the Chapter 7 for complete key mappings.

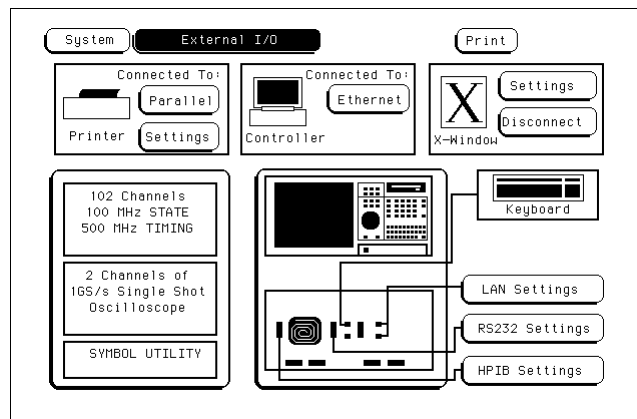

System External I/O menu showing keyboard installed

---

## To connect to an HP-IB printer

Printers connected to the logic analyzer over HP-IB must support HP-IB and Listen Always. When controlling a printer, the analyzer's HP-IB port does not respond to service requests (SRQ), so the SRQ enable setting does not have any effect on printer operation.

- 1 Turn off the analyzer and the printer, and connect an HP-IB cable from the printer to the HP-IB connector on the analyzer rear panel.
- 2 Turn on the analyzer and printer.
- 3 Make sure the printer is set to **Listen Always** or **Listen Only**.

For example, the figure below shows the HP-IB configuration switches for an HP-IB ThinkJet printer. For the Listen Always mode, move the second switch from the left to the 1 position. Since the instrument doesn't respond to SRQ EN (Service Request Enable), the position of the first switch doesn't matter.

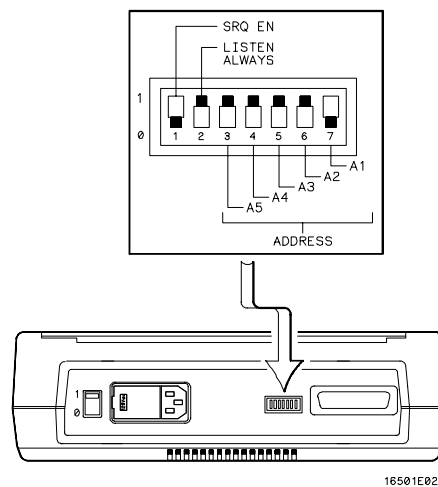

Listen Always switch setting

**4** Go to the System External I/O menu and configure the analyzer's printer settings.

- a** If the analyzer is not already set to HP-IB, select the field under Connected To: in the Printer box and choose HP-IB from the menu.
- b** Select the Printer Settings field.
- c** In the top field of the pop-up, select the type of printer you are using. If you are using an Epson graphics printer or an Epson-compatible printer, select Alternate.
- d** If the default print width and page length are not what you want, select the fields to toggle them.

If you select 132 characters per line when using a printer other than QuietJet, the listings are printed in a compressed mode. QuietJet printers can print 132 characters per line without going to compressed mode, but require wider paper.

- e** Press Done.

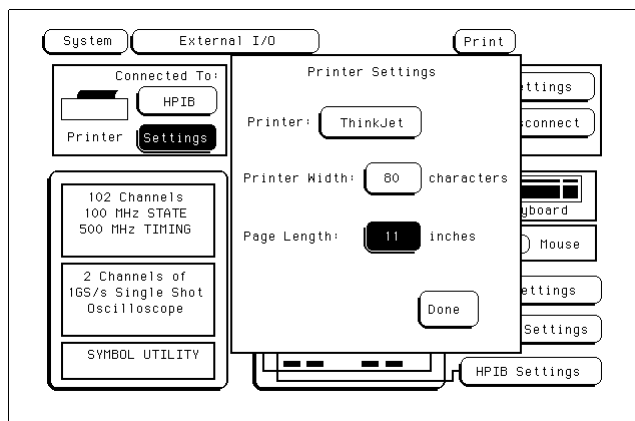

Printer Settings menu

---

## To connect to an RS-232-C printer

- 1** Turn off the analyzer and the printer, and connect a null-modem RS-232-C cable from the printer to the RS-232-C connector on the analyzer rear panel.
- 2** Before turning on the printer, locate the mode configuration switches on the printer and set them as follows:
  - For the HP QuietJet series printers, there are two banks of mode function switches inside the front cover. Push all the switches down to the 0 position.
  - For the HP ThinkJet printer, the mode switches are on the rear panel of the printer. Push all the switches down to the 0 position.
  - For the HP LaserJet printer, the factory default switch settings are okay.
- 3** Turn on the analyzer and printer.
- 4** Go to the System External I/O menu and configure the analyzer's printer settings.
  - a** If the analyzer is not already set to RS-232-C, select the field under Connected To: in the Printer box and choose RS-232C from the menu.
  - b** Select the Printer Settings field.
  - c** In the top field of the pop-up, select the type of printer you are using. If you are using an Epson graphics printer or an Epson-compatible printer, select Alternate.
  - d** If the default print width and page length are not what you want, select the fields to toggle them.

If you select 132 characters per line when using a printer other than QuietJet, the listings are printed in a compressed mode. QuietJet printers can print 132 characters per line without going to compressed mode, but require wider paper.
  - e** Press Done.
- 5** Select the RS232 Settings field and check that the current settings are compatible with your printer.

### See Also

"The RS-232-C Interface" section in Chapter 7 for more information on RS-232-C settings.

## To connect to a parallel printer

- 1** Turn off the analyzer and the printer, and connect a parallel printer cable from the printer to the parallel printer connector on the analyzer rear panel.
- 2** Before turning on the printer, configure the printer for parallel operation.

The printer's documentation will tell you what switches or menus need to be configured.
- 3** Turn on the analyzer and printer.
- 4** Go to the System External I/O menu and configure the analyzer's printer settings.
  - a** If the analyzer is not already set to Parallel, select the field under Connected To: in the Printer box and choose Parallel from the menu.
  - b** Select the Printer Settings field.
  - c** In the top field of the pop-up, select the type of printer you are using. If you are using an Epson graphics printer or an Epson-compatible printer, select Alternate.
  - d** If the default print width and page length are not what you want, select the fields to toggle them.

If you select 132 characters per line when using a printer other than QuietJet, the listings are printed in a compressed mode. QuietJet printers can print 132 characters per line without going to compressed mode, but require wider paper.
  - e** Press Done.

There are no settings specific to the parallel printer connector.

## To connect to a controller

You can control the HP 1660CS-series logic analyzer with another instrument, such as a computer running a program with embedded analyzer commands. The steps below outline the general procedure for connecting to a controller using HP-IB or RS-232-C.

**1 Turn off both instruments, and connect the cable.**

If you are using RS-232-C, the cable must be a null-modem cable. If you do not have a null-modem cable, you can purchase an adapter at any electronics supply store.

**2 Turn on the logic analyzer and then the controller.**

**3 In the System External I/O menu, select the field under Connected To: in the Controller box and set it appropriately.**

The figure below is for HP-IB.

**4 Select the appropriate Settings field and configure the values in the pop-up menu to be compatible with the controller.**

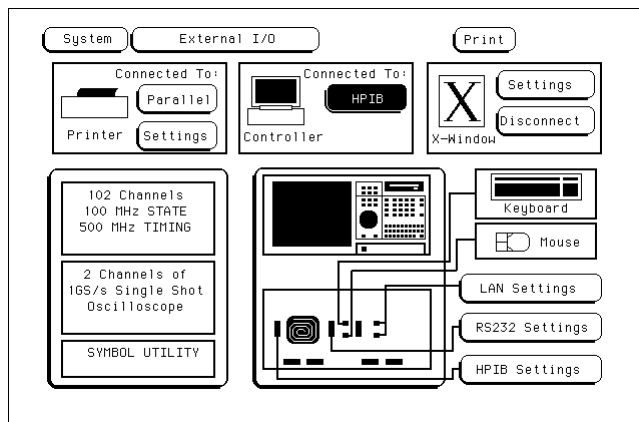

**See Also**

*HP 1660C/CS-Series Logic Analyzers Programmer's Guide* and the LAN User's Guide for more information on connecting controllers.







---

## Using the Logic Analyzer

---

## Using the Logic Analyzer

This chapter shows you how to perform the basic tasks necessary to make a measurement. Each section uses an example to show how the task fits into the overall goal of making a measurement.

---

## Accessing the Menus

When you power up the logic analyzer, the first screen after the system tests is the Analyzer Configuration menu. Menus are identified by two fields in the upper left corner. The leftmost field shows Analyzer. This field is sometimes referred to as the "mode field" or the "module field" because it controls which other set of menus you can access. The second field, just to the right of the mode field, accesses menus within the mode and so is called the "menu field". Menus are referred to by the titles that appear in the mode and menu fields, for example, the Analyzer Configuration menu.

The figure below shows the top of the first screen. The mode field, item 1, displays "Analyzer." The menu field, item 2, displays "Configuration." Because menus are identified by the titles in these two fields, this menu is referred to as the Analyzer Configuration menu. When there is no risk of confusion, the menu is sometimes referred to just by the title showing in the second field, for example, the Configuration menu.

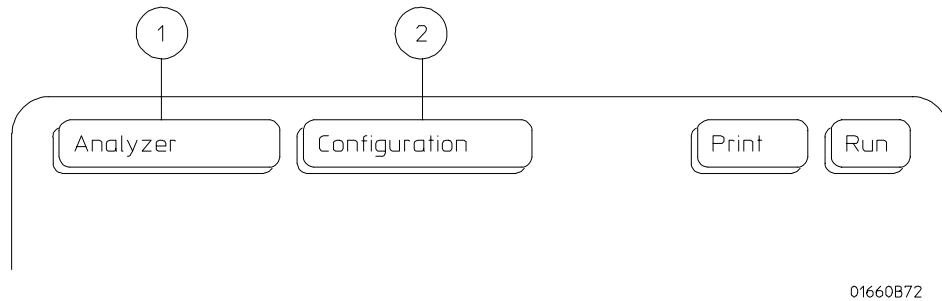

## To access the System menus

The System menus allow you to perform operations that affect the entire logic analyzer, such as load configurations, change colors, and perform system diagnostics.

### 1 Select the mode field.

Use the arrow keys to highlight the mode field, then press the Select key. Or, if you are using the mouse, click on the field. This operation is referred to as "select".

A pop-up menu appears with the choices System, Analyzer, and Scope. (If you have installed any optional software, there may be other choices as well.)

### 2 Select System.

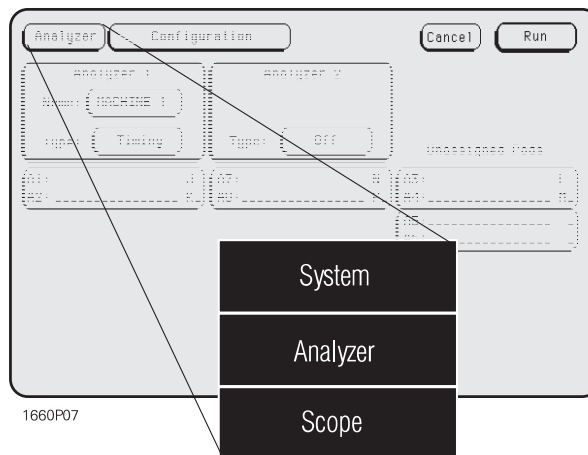

### 3 Select the menu field.

The pop-up lists five menus: Hard Disk, Flexible Disk, External I/O, Utilities, and Test.

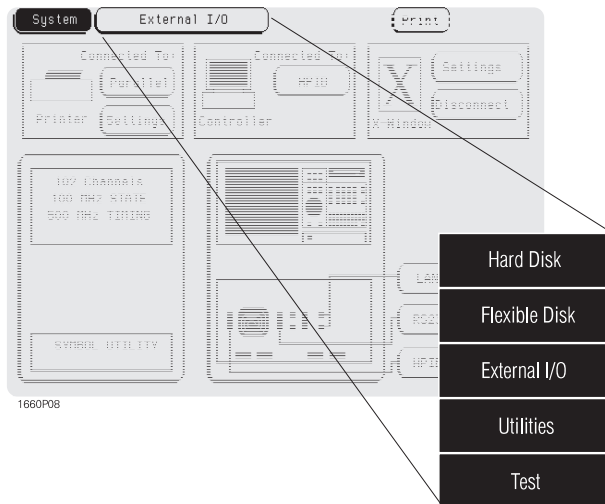

- Hard Disk allows you to perform file operations on the hard disk
- Flexible Disk allows you to perform file operations on the flexible disk.
- External I/O allows you to configure your HP-IB, RS-232-C, and LAN interfaces and connect to a printer and controller.
- Utilities allows you to set the clock, update the operating system software, and adjust the display.
- Test displays the installed software version number and loads the self tests.

**See Also**

For more information on operations available in the Disk menus, "File Management" chapter and "Disk Drive Operations" in Chapter 7.

For more information on the External I/O, "Connecting Peripherals" chapter and "The RS-232-C, HP-IB, and Centronics Interfaces" in Chapter 7.

For more information on the system utilities, "System Utilities" in Chapter 7.

For information on running the self-tests, "Operator's Service" chapter.

## To access the Analyzer menus

The Analyzer menus allow you to control the analyzer to make your measurement, perform operations on the data, and view the results on the display.

### 1 Select the mode field.

A pop-up menu appears with the choices System, Analyzer, and Scope. (If you have installed any optional software, there may be other choices as well.)

### 2 Select Analyzer.

### 3 Select the menu field.

The figure on the next page shows all possible menus. Your analyzer will never have all of them available at once, because certain menus are only accessible with the analyzer configured in a particular mode. For instance, the Compare menu is only available when you set an analyzer to state mode, and the SPA menu requires an analyzer set to SPA.

- Configuration is always available in Analyzer mode. Use Configuration to assign pods and set the analyzer type.
- Format is available whenever an analyzer is set to a type other than "Off." Use Format to create data labels and symbols, adjust the pod threshold level, and set modes and clocks.
- Trigger is available when an analyzer is set to State or Timing. Use Trigger to specify a trigger sequence which will filter the raw information into the measurement you want to see.
- Listing is available when an analyzer is set to State or Timing. Use Listing to view your measurement as a list of states. Using an inverse assembler, a state analyzer can display the measurement as though it were assembly code.
- Compare is available only when an analyzer is set to State. Use Compare to compare two listings and quickly scroll to the sections where they differ.

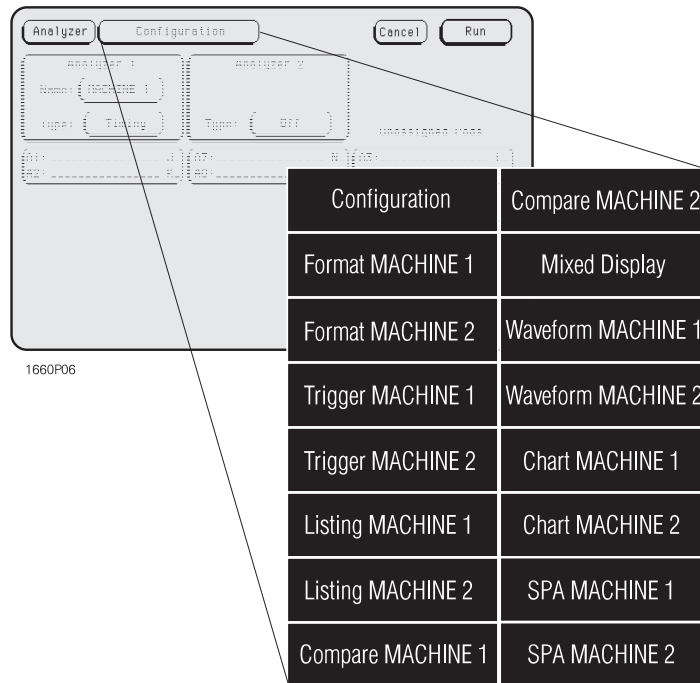

- Mixed Display always appears in the menu list when an analyzer is set to State or Timing, but it requires a State analyzer with time tags enabled.
- Waveform is available when an analyzer is set to State or Timing. Use Waveform to view the data as logic levels on discrete lines.
- Chart is available only when an analyzer is set to State. Use Chart to view your measurement as a graph of states versus time.
- SPA is available only when an analyzer is set to SPA. Use SPA to gather and view overall statistics about your system performance.

**See Also**

Chapter 7, "Reference" for details on the State and Timing menus and Chapter 8, "System Performance Analysis (SPA) Software" for information on the SPA menu.

"Using the Analyzer Menus" in this chapter for how to use the menus.

## To access the Scope menus

The Scope menus allow you to control the analyzer to make your measurement, perform operations on the data, and view the results on the display.

**1 Select the mode field.**

A pop-up menu appears with the choices System, Analyzer, and Scope. (If you have installed any optional software, there may be other choices as well.)

**2 Select Scope.**

**3 Select the menu field.**

The pop-up lists six menus: Scope Channel, Scope Display, Scope Trigger, Scope Marker, Scope Auto Measure, and Scope Calibration.

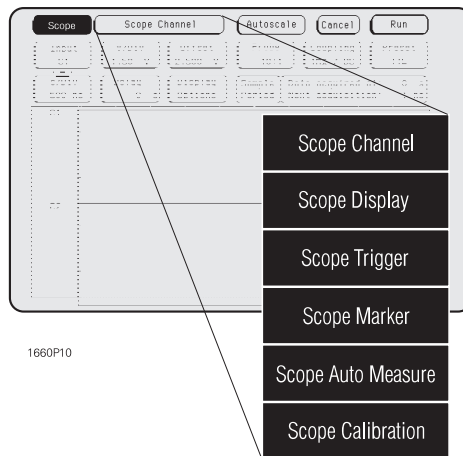

- Scope Channel lets you select the channel input. It lets you set values that control the vertical sensitivity, offset, probe attenuation factor, input impedance, and coupling of the input channel currently shown in the Input field. The Channel menu also gives you preset vertical sensitivity, offset, and trigger level values for ECL and TTL logic levels.
- Scope Display controls how the oscilloscope acquires and displays waveforms. You can acquire and display the waveforms in one of the following modes: Normal, Average, or Accumulate. The Display options also control the connect-the-dots display and grid display features.



- Scope Trigger allows you to choose the method you want to use to trigger the oscilloscope for a particular application. The three trigger modes are Edge, Pattern, and Immediate.
- Scope Markers has two sets of markers that allow you to make time and voltage measurements. These measurements can be made either manually (voltage and time markers) or automatically (time markers only).
- Scope Auto Measure provides nine automatic measurements to fit the acquired waveform to the display. These measurements are Period, Risetime, Falltime, Frequency, +Width, -Width, Vp\_p, Preshoot, and Overshoot.
- Scope Calibration allows you to calibrate the oscilloscope or the oscilloscope/probe system.

**See Also**

Chapter 12, "Operator's Service," for details on calibrating the oscilloscope.

---

## Using the Analyzer Menus

The following examples show how to use some of the Analyzer menus to configure the logic analyzer for measurements. These examples assume that you have already determined which signals are of interest and have connected the logic analyzer to the target system. Some of the examples use data from a Motorola 68360 target system, acquired with an HP E2456A Preprocessor Interface.

---

### To label channel groups

Hewlett-Packard logic analyzers give you the ability to separate or group data channels and label the groups with a name that is meaningful to your measurement. Labels also assist you in triggering only on states of interest.

Labels can only be assigned in the Analyzer Format menu. Once assigned, the labels are available in all display menus, where they can be added to or deleted from the display. Use labels when you want to group data channels by function with a name that has meaning to that function.

The default label names are Lab1 through Lab126. However, you can modify a name to any six-character string. If you are using an HP preprocessor interface, the configuration file has predefined labels for your specific processor.

To create or modify a label and assign channel groups, use the following procedure.

- 1** Press the Format key to go to the Format menu.
- 2** Select a label under the Labels heading. In the pop-up menu, select Modify Label.
- 3** Use the keyboard to type in a name for the label and press Done.

In this example, the label is called CYCLE.

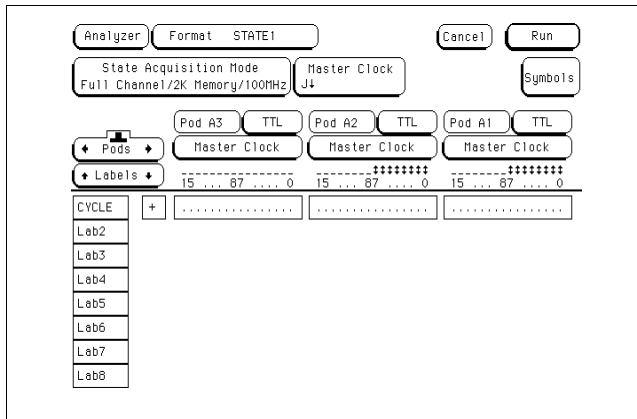

- 4 Select the pod containing the channels for the label. Use the knob or the arrow keys to position the selector over a channel you want to change.

An asterisk indicates the channel is selected; a dot indicates the channel is not part of the current group.

- 5 Toggle the channel's group status by pressing Select.

The indicator changes and the selector moves to the next channel.

In this example, the channels 3, 1, and 0 (Pod A1) are assigned to label CYCLE and the channels 6 and 3 (Pod A2) are assigned to the label Lab2.

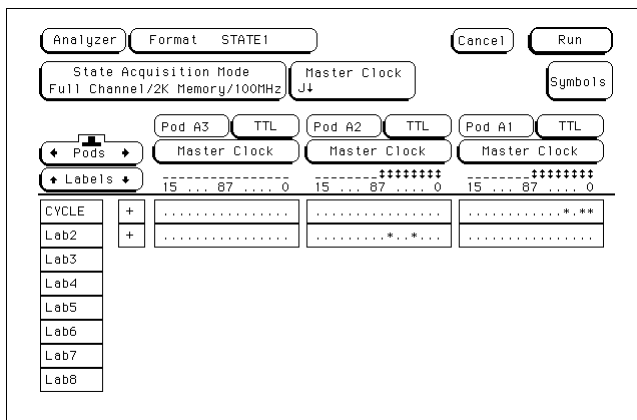

## To create a symbol

Symbols are alphanumeric mnemonics that represent specific data patterns or ranges. When you define a symbol and set the base type to Symbol in the Listing menu, the symbol is displayed in the data listing where the bit pattern would normally be displayed. The symbols also appear in the Waveform menu when you view a label in bus form. Symbols allow you to quickly identify data of interest.

To create a symbol, use the following procedure.

**1 In the Analyzer Format menu, select Symbols.**

The symbol table menu appears. The symbol table is where all user symbols are created and maintained. If you get a message, "No labels specified," check that you have at least one label turned on with channels assigned to it.

**2 In the Symbol menu select the Label field. In the pop-up menu select the label that contains the channel groups you want.**

When you open the symbol table menu, the Label field displays the name of the first active label.

If the label you want does not appear in the pop-up menu, the label is probably off. Return to the Format menu, select the label you want, and select Turn Label On. Another possibility is that the label is on the other analyzer. The two analyzers manage resources separately.

**3 Select the Base field. In the pop-up menu, select the base for the pattern.**

In this example, binary is used since CYCLE only contains three channels.

**4 Select the field below Symbol. Select Add a Symbol, type in the symbol name, then press Done.**

- 5 If additional Symbols are needed, repeat step 4 until you have added all symbols.

In this example three symbols are added: MEM RD, MEM WR, and DATA RD.

- 6 Toggle the Type field to "range" or "pattern".

When Type is range, a third field appears under the Stop column. To fully specify a range, you need to enter a value for it, too.

- 7 Select the Pattern/Start field and use the keypad to enter an appropriate value in the selected base. Use X for "don't care."
- 8 When the pattern is specified, press Done. If you created additional Symbols, repeat steps 6 and 7 until all symbols are specified.
- 9 To close the symbol table menu, select Done.

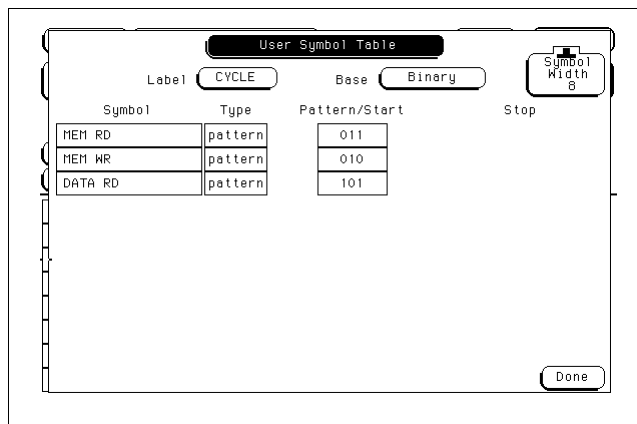

#### Symbol table menu showing three symbols

You can also download symbol tables created by your programming environment using HP E2450A Symbol Utility. The Symbol Utility is shipped with the HP 1660CS-series logic analyzers.

#### See Also

*HP E2450A Symbol Utility User's Guide* for more information on the Symbol Utility.

## To examine an analyzer waveform

The Analyzer Waveform menu allows you to view state or timing data in a format similar to an oscilloscope display. The horizontal axis represents states (in state mode) or time (in timing mode) and the vertical axis represents logic highs and lows.

**1 In Analyzer mode, press the Run key to acquire data.**

In any mode other than Analyzer or Scope, pressing the Run key has no effect. The menus which ignore Run lack the Run field onscreen. In Analyzer mode with Run available, the menu changes to a display menu.

**2 Go to the Analyzer Waveform menu.**

**3 To adjust the horizontal axis (sec/Div or states/Div) use the knob.**

If nothing happens when you turn the knob, make sure the Div field has a roll indicator above it, as in the figures on the next page. When you first enter the Waveform menu, the knob adjusts the horizontal axis but if you select another rollable field, the knob will control that field instead.

**4 To adjust the display relative to the trigger, select the Delay field and enter a value or use the knob.**

The portion of memory being displayed is indicated by a white bar along the bottom of the display area. The position of the trigger in memory is indicated by a white dot on the same line. When the bar includes the dot, then the trigger is visible on the display as indicated by a vertical line with a "t" underneath.

**5 To scroll through waveforms, select the large rectangle below the Div field and use the knob.**

The roll indicator appears at the top of the rectangle and the name of the first waveform is highlighted. The highlight moves as you turn the knob.

**6 To insert waveforms, select the large rectangle under the Div field. In the pop-up, select Insert, and then select the labels and channels.**

The Sequential field inserts all the channels of the label as individual waveforms; the Bus field groups the waveforms; the Bit N field inserts just the Nth bit. Waveforms are inserted after the currently highlighted one.

**7 To take measurements, select the Markers field and choose the appropriate marker type.**

The markers available depend on the type of analyzer and whether or not tagging is enabled. Use markers to locate patterns quickly.

See Also

"Count Field" and "Markers Field" in Chapter 7.

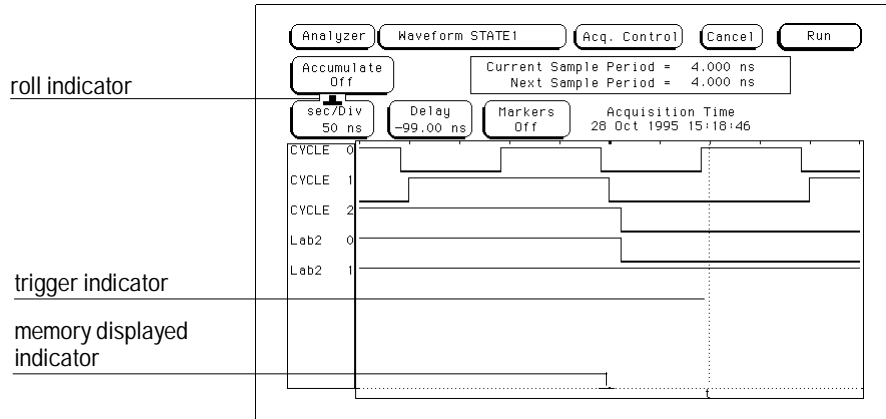

Example

The following example shows a state waveform from the Hewlett-Packard preprocessor interface for the Motorola 68360. Notice how the bus waveforms insert symbols or state data.

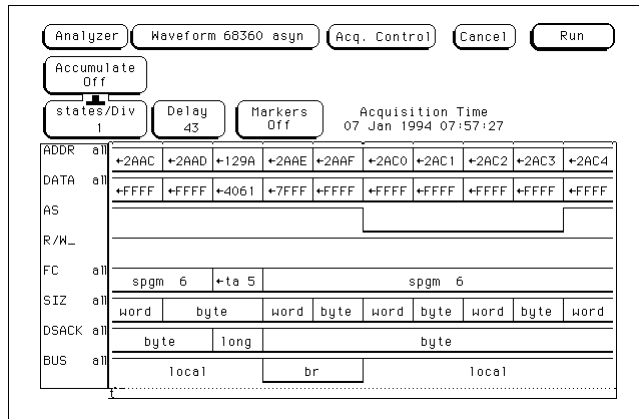

## To examine an analyzer listing

The Analyzer Listing menu displays state or timing data as patterns (states). The Listing menu uses any of several formats to display the data such as binary, ASCII, or symbols. If you are using an inverse assembler and select Invasm, the data is displayed in mnemonics that closely resemble the microprocessor source code.

### See Also

"The Inverse Assembler" at the end of this chapter for additional information on using an inverse assembler.

#### **1 In Analyzer mode, press the Run key to acquire data.**

In any mode other than Analyzer or Scope, pressing the Run key has no effect. The menus which ignore Run lack the Run field onscreen. In Analyzer mode with Run available, the menu changes to a display menu.

#### **2 Go to the Analyzer Listing menu.**

All labels defined in the Analyzer Format menu appear in the listing. If there are more labels than will fit on the screen, the Label/Base field is shaded like a normal field.

#### **3 To scroll the labels, select the Label/Base field and use the knob.**

If the Label/Base field is selectable, the roll indicator appears over the field as in the example. To move the labels one full screen at a time, press Shift and a Page key.

#### **4 To scroll the data, use the Page keys or select the data roll field and use the knob.**

If you select the data roll field, the roll indicator moves to it. No matter which field is currently controlled by the knob, however, the Page keys page the data up or down.

The numbers in the data roll column indicate how many samples the data is from the trigger. Negative numbers occurred before the trigger and positive numbers occurred after.

#### **5 If the labels have symbols associated with them, set the base to Symbol.**

The symbols you defined appear in the listing.



- 6** To insert a label, select one of the label fields, then select Insert from the pop-up and the label you want to insert.

The last label cannot be deleted, so there is always at least one label. You can insert the same label multiple times and display it in different bases.

- 7** To take measurements, select the Markers field and choose the appropriate marker type.

The markers available depend on the type of analyzer and whether or not tagging is enabled. Use markers to locate states quickly.

**See Also**

"Count Field" and "Markers Field" in Chapter 7.

**Example**

The following illustration shows a listing from the Hewlett-Packard preprocessor interface for the Motorola 68360. The ADDR label has the base set to Hex to conserve space on the display. The DATA label has the base set to Invasm for inverse assembly. The FC label has the base set to Symbol. Additional labels are located to the right of FC, and can be viewed by highlighting and selecting Label, then using the knob to scroll the display horizontally.

roll indicator

data roll field

Analyzer Listing 68360 asyn Invasm Options Cancel Run

Markers Off Acquisition Time 07 Jan 1994 07:57:27

Label>	ADDR	68360 DATA Bus	FC
Base>	Hex	10 = hex, 10. = decimal	Symbol
61	0003FB4	MOVE.L (0008,A6),-(A7)	spgm 6
65	0003FB8	JSR 00002A18	spgm 6
67	04012B0	00401B40 supr data read	sdata 5
68	04012A0	00401B40 supr data write	sdata 5
75	040129C	00003FBE supr data write	sdata 5
76	0002A18	LINK.W A6,#0000	spgm 6
80	0401298	004012A8 supr data write	sdata 5
81	0002A1C	MOVEA.L 0040147C,A0	spgm 6
87	0002A22	MOVE.W (A0),D0	spgm 6
89	040147C	00022000 supr data read	sdata 5
90	0002A24	BTST #15,D0	spgm 6
92	0022000	A000xxxx supr data read	sdata 5
95	0002A28	BEG.B 00002A2E	spgm 6
101	0002A2E	MOVEA.L *****A0	spgm 6
103	0002A82	UNLK A6	spgm 6
105	0002A84	RTS	spgm 6

## To compare two listings

The Compare menu allows you to take two state analyzer acquisitions and compare them to find the differences. You can use this function to quickly find all the effects after changing the target system or to quickly compare the results of quality tests with results from a working system.

**1 In Analyzer mode, press the Run key to acquire data.**

In any mode other than Analyzer or Scope, pressing the Run key has no effect. The menus which ignore Run lack the Run field onscreen. In Analyzer mode with Run available, the menu changes to a display menu.

**2 Go to the Analyzer Compare menu, select Copy Listing to Reference, and then select Execute.**

The Compare menu initially is empty, but when you select Execute the data appears.

**3 Set up the other test that you want to compare to the first.**

This can be a change to the hardware, or a different system. Do not change the trigger, however, or all the states will be different.

**4 Run the test again, then select the Reference listing field to toggle to Difference listing.**

The Difference listing is displayed on the next page.

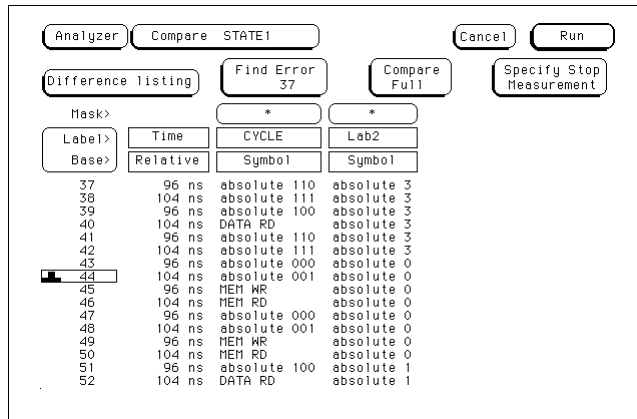

The Difference listing displays the states that are identical in dark typeface, and the states that are different in light typeface (indistinguishable in the above illustration). The light typeface shows the data from the compare file that is different from the data in the reference file.

- 5 Select the Find Error field and use the knob to scroll through the errors.

The display jumps past all states that are identical, and shows the number of errors through the current state in the Find Error field. In the above illustration, there are 37 errors through state 44 of the listing.

---

# The Inverse Assembler

When the analyzer captures a trace, it captures binary information. The analyzer can then present this information in symbol, binary, octal, decimal, hexadecimal, or ASCII. Or, if given information about the meaning of the data captured, the analyzer can inverse assemble the trace. The inverse assembler makes the trace list more readable by presenting the trace results in terms of processor opcodes and data transactions.

---

## To use an inverse assembler

Most preprocessors include an inverse assembler in their software. Loading the configuration file for the preprocessor sets up the logic analyzer to provide certain types of information for the inverse assembler. This section is provided in case you ever have to set up an analyzer for inverse assembly yourself.

The inverse assembly software needs at least these five pieces of information:

- Address bus. The inverse assembler expects to see the label ADDR, with bits ordered in a particular sequence.
- Data bus. The inverse assembler expects to see the label DATA, with bits ordered in a particular sequence.
- Status. The inverse assembler expects to see the label STAT, with bits ordered in a particular sequence.
- Start state for disassembly. This is the first displayed state in the trace list, *not* the cursor position. See the figure on the next page.
- Tables indicating the meaning of particular status and data combinations.

The particular sequences that each label requires depends on the type of chip the inverse assembler was designed for. Because of this, inverse assemblers cannot generally be transferred between platforms.

To run the inverse assembler, you must be sure the labels are spelled correctly as shown here, or as directed in your inverse assembler documentation. Even a minor difference such as not capitalizing each letter will cause the inverse assembler to not work.

The inverse assembler synchronizes at the first line in the trace list...

not at the cursor position

100/500MHz LA B		Listing 1	Invasm	Print	Run
Markers Off		Acquisition Time 27 Oct 1993 10:25:55			
Label>	ADDR	CPU32 Mnemonic	STAT		
Base>	Hex	hex	Symbol		
-7	41CE6	MOVE.B (A7)+,D0	Opcode Fetch		
-6	41CE8	MOVE.B D0,SWITCH R	Opcode Fetch		
-5	0FF7E	09xx data read	Data Read		
-4	41CEA	0000 pgm read	Opcode Fetch		
-3	41CEC	8100 pgm read	Opcode Fetch		
-2	41CEE	MOVE.B D0,-(A7)	Opcode Fetch		
-1	41CF0	BSR.W 00040A40	Opcode Fetch		
0	08100	09xx data write	Data Write		
1	41CF2	ED4E pgm read	Opcode Fetch		
2	0FF7E	09xx data write	Data Write		
3	0FF7A	0004 data write	Data Write		
4	0FF7C	1CF4 data write	Data Write		
5	40A40	MOVEM.L D0,-(A7)	Opcode Fetch		
6	40A42	8000 pgm read	Opcode Fetch		
7	40A44	MOVE.B (0008,A7),D0	Opcode Fetch		
8	40A46	000B pgm read	Opcode Fetch		

### Inverse assembly synchronization

When you press the Invasm key to begin inverse assembly of a trace, the inverse assembler begins with the first displayed state in the trace list. This is called *synchronization*. It looks at the status bits (STAT) and determines the type of processor operation, which is then displayed under the STAT label. If the operation is an opcode fetch, the inverse assembler uses the information on the data bus to look up the corresponding opcode in a table, which is displayed under the DATA label. If the operation is a data transfer, the data and corresponding operation are displayed under the DATA label. This continues for all subsequent states in the trace list.

If you roll the trace list to a new position and press Invasm again, the inverse assembler repeats the above process. However, it does not work backward in the trace list from the starting position. This may cause differences in the trace list above and below the point where you synchronized inverse assembly. The best way to ensure correct inverse assembly is to synchronize using the first state you know to be the first byte of an opcode fetch.

### See Also

The Preprocessor User's Guide for more information on controlling inverse assembly.

"Troubleshooting," Chapter 10, if you have problems using the inverse assembler.





---

## Using the Trigger Menu

---

## Using the Trigger Menu

To use the logic analyzer efficiently, you need to be able to set up your own triggers. This book provides examples of triggering in the next chapter. Those examples assume you already know where to find fields in the trigger menu. This chapter explains how to use those fields.

This chapter shows you how to:

- Specify a basic trigger
- Change a trigger sequence
- Set up time correlation between analyzers
- Arm from another instrument, or arm another instrument
- Manage memory

Much of the information here is also covered in the Logic Analyzer Training Kit, but this chapter presents the information in a more general form.



---

## Specifying a Basic Trigger

The default analyzer triggers are

```
While storing "anystate" TRIGGER on "a" 1 time
```

```
Store "anystate"
```

for state analyzers and

```
TRIGGER on "a" > 8 ns
```

for timing analyzers. The oscilloscope triggers separately from the logic analyzers. If you want to simply record data, these will get you started. They can quickly be tailored by specifying a particular pattern to look for instead of the general case.

Customizing a trigger generally requires these steps:

- Assign terms to both analyzers
- Define the terms
- Change the trigger to use the new terms

The oscilloscope can be used in complex triggering sequences managed by the logic analyzer, but its inherent trigger mechanism is much simpler. Using the oscilloscope in conjunction with one or both of the analyzers is covered in "Arming and Additional Instruments" in this chapter. The different modes of triggering the oscilloscope are covered in "The Scope Trigger Menu" in Chapter 7.

---

## To assign terms to an analyzer

When you turn the logic analyzer on, Analyzer 1 is named Machine 1 and Analyzer 2 is off. Trigger terms can only be used by one analyzer at a time, so all the terms are assigned to Analyzer 1. If you plan to use both analyzers in your measurement, you need to assign some of the terms to Analyzer 2.

**1 Go to the Trigger Machine 1 menu.**

If you have renamed Machine 1 in the Analyzer Configuration menu, the name you changed it to will appear in the menu instead of Machine 1.

**2 Select a term.**

The terms are the fields below the roll field "Terms". See the figure below.

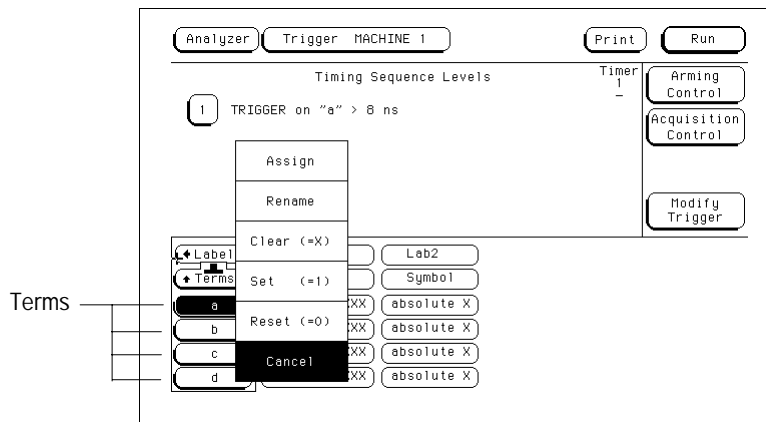

**3 Select Assign from the list that appears.**

The Resource Term Assignment menu appears. It is divided into two sections, one for each analyzer. All the terms are listed.

**4 To change a term assignment, select the term field.**

The term fields toggle from one section to the other. You can get all your terms assigned at once, or just change a few to meet immediate needs.

**5 To exit the term assignment menu, select Done.**

## To define a term

Both default triggers trigger on term "a". If you only need to look for the occurrence of a certain state, such as a write to protected memory, then you only need to define term "a" to make the measurement you want.

- 1 In the Trigger menu, select the field at the intersection of the term and the label whose value you want to trigger on.**

You set labels in the Analyzer Format menu. If the channels you want to monitor are not attached to a label, they will not appear in the trigger menu.

- 2 Enter the value or pattern you want to trigger on.**

If the label's base is Symbol, a pop-up menu appears offering a choice of symbols. For other bases, use the keypad. An "X" stands for "don't care".

If there are two conditions that need to be present at the same time, for example a protected address on the address bus and a write on the read/write line, define both values on the same term. See the figure below.

- 3 Press Done.**

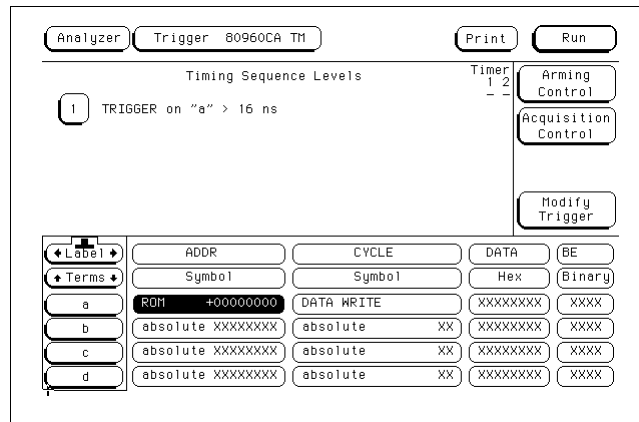

Term "a" defined as a data write to read-only memory

---

## To change the trigger specification

Most triggers use terms other than "a." Even a simple trigger might use additional terms to set conditions on the actual trigger. To use these terms, you must include them in the trigger sequence specification.

- 1 In the Trigger menu, select the number beside the specific level you want to modify.**

A Sequence Level menu pops up. It shows the current specification for that trigger level.

- 2 Select the field you want to change.**

In the top row of the pop-up are three action fields: Insert Level, Select New Macro, and Delete Level. The next section goes into detail on them. The fields after "While storing," "TRIGGER on," and "Else on" are completed with trigger terms. Selecting these fields pops up a menu of terms(see below).

- 3 Select the term you want to use from the pop-up, or enter a new value, as appropriate to the field.**

Selecting "Combination" pops up a menu to define a term combination. The combination mechanism is discussed in "Resource Terms" in Chapter 7 and "The Trigger Sequencer" in Chapter 9.

If you have renamed a term, that name is automatically used everywhere the term would appear.

- 4 Select Done until you are back at the Trigger menu.**

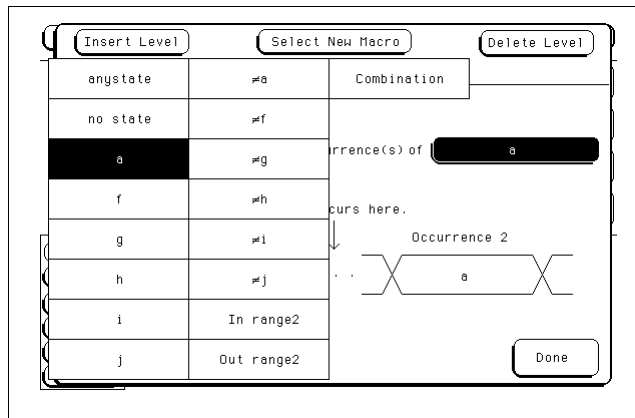

Term selection pop-up menu

---

## Changing the Trigger Sequence

Most measurements require more complicated triggers to better filter information. From the basic trigger, you can

- Add sequence levels
- Change macros

Your logic analyzer provides a macro library to make setting up the trigger easier. There are 12 state macros and 13 timing macros. Most macros take more than one level internally to implement, and can be broken down into their separate levels. Once broken down, the levels can be used to design your own trigger sequences.

---

## To add sequence levels

You can add sequence levels anywhere except after the final one.

- 1 In the Trigger menu, select the number beside the sequence level just after where you want to insert.**

For example, if you want to insert a sequence level between levels 1 and 2, you would select level 2. To insert levels at the beginning, select level 1.

A Sequence Level pop-up appears. Its exact contents depend on the analyzer configuration and the level specification. However, all Sequence Level pop-ups have an Insert Level field in the upper left corner.

- 2 Select Insert Level.**

Another pop-up offers the choices of Cancel, Before, or After. If the level you started from was the last level, After will not appear.

- 3 Select Before.**

The Trigger Macro pop-up replaces the Sequence Level pop-up. The macros available depend on whether the analyzer is configured as state or timing.

- 4 Use the knob to highlight a macro, and select Done.**

A new Sequence level pop-up appears. Its contents reflect the macro you just selected. The figure below shows a user macro for a state analyzer.

- 5 Fill in the fields and select Done.**

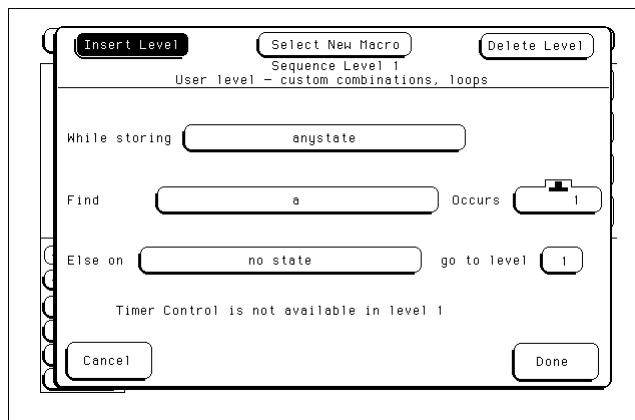

Sequence Level pop-up menu

---

## To change macros

You do not need to add and delete levels just to change a level's macro. This can be done from within the Sequence Level pop-up.

- 1 From the Trigger menu, select the sequence level number of the sequence level you want to modify.**

A Sequence Level pop-up appears. Its contents reflect the current macro.

- 2 Select Select New Macro.**

The Trigger Macro pop-up replaces the Sequence Level pop-up. The macros available depend on whether the analyzer is configured as state or timing.

- 3 Use the knob to highlight the macro you want, and select Done.**

A new Sequence Level pop-up appears. Its contents reflect the macro you just selected. The wording of this screen is very similar to the macro description, and the line drawing demonstrates what the macro is measuring.

- 4 Select the appropriate assignment fields and insert the desired pre-defined terms, numeric values, and other parameter fields required by the macro. Select Done.**

### See Also

"Timing Trigger Macro Library" and "State Trigger Macro Library" in Chapter 7 for a complete listing of macros.

---

## Setting Up Time Correlation between Analyzers

There are two possible combinations of analyzers: state and state, and state and timing. Timing and timing is not possible because the Analyzer Configuration menu only permits one analyzer at a time to be configured as a timing analyzer. For either combination, time correlation is necessary for interleaving and mixed display.

Time correlation is useful when you want to store different sorts of data for each trace, but see how they are related. For instance, you could set up a timing and a correlated state analyzer and see if setup and hold times are being met. Or, you could set up two state analyzers and have one watch normal program execution and the other watch the control and status lines.

Time correlation requires that state analyzers store time tags. You set the state analyzer to store time tags by turning on Count Time in the Analyzer Trigger menu. The timing analyzer already stores time tags when it samples data.

**See Also**

"Special Displays" in Chapter 5 for more information on interleaving and mixed display.



---

## To set up time correlation between two state analyzers

To correlate the data between two state analyzers, both must have Count Time turned on in their Trigger menus. Although both have Count State available, it is not possible to correlate data based on states even when they are identically defined.

**1 In the Analyzer Trigger menu, select Count.**

Count may be Count Off, Count Time, or Count States. Selecting the field causes a pop-up to appear.

**2 Select the field after Count: and select Time.**

A warning may appear about reduced memory. It will not prevent you from changing Count to Count Time.

**3 Select Done.**

**4 Repeat steps 1 through 3 for the other state analyzer.**

Now when you acquire data you will be able to interleave the listings.

---

## To set up time correlation between a timing and a state analyzer

To set up time correlation between a timing and a state analyzer, only the state analyzer needs to have Count Time turned on. The timing analyzer automatically keeps track of time.

**1 In the state Analyzer Trigger menu, select Count.**

Count may be Count Off, Count Time, or Count States. Selecting the field causes a pop-up to appear.

**2 Select the field after Count: and select Time.**

A warning may appear about reduced memory. It will not prevent you from changing Count to Count Time.

**3 Select Done.**

Now when you acquire data you will be able to set up a mixed display.

---

## Arming and Additional Instruments

Occasionally you may need to start the analyzer acquiring data when another instrument detects a problem. Or, you may want to have the analyzer itself arm another measuring tool. This is accomplished from the Arming Control field of the Analyzer Trigger menu.

---

### To arm another instrument

- 1 Attach a BNC cable from the External Trigger Output port on the back of the logic analyzer to the instrument you want to trigger.**

The External Trigger Output port is also referred to as "Port Out." It uses standard TTL logic signal levels, and will generate a rising edge when trigger conditions are met.

- 2 In the Analyzer Trigger menu, select Arming Control.**

Arming Control is below the Run button.

- 3 Select the Port Out field, and choose Analyzer from the list.**

- 4 If you are using both analyzers, set the Arm Out Sent From field in the upper right corner.**

This field does not appear if only one analyzer is configured.

The selected analyzer will send the arm signal when it finds its trigger.

- 5 Select Done.**

When you make a measurement, the analyzer will send an arm signal through the External Trigger Output when the analyzer finds its trigger.

---

## To arm the oscilloscope with the analyzer

If both analyzers and the oscilloscope are turned on, you can configure one analyzer to arm the other analyzer and the oscilloscope. An example of this is when a state analyzer triggers on a bit pattern, then arms a timing analyzer and the oscilloscope which capture and display the waveform after they trigger.

- 1 In the Analyzer Trigger menu, select Arming Control.**
- 2 Select the Analyzer Arm Out Sent From field, and choose from the list the Analyzer that will generate the arm.**
- 3 Select the Analyzer Arm In field, and choose Group Run.**

This allows you to time-correlate the data from the analyzers and the scope. The Scope Trigger Mode must be Immediate for correlation.
- 4 Select the field of the instrument which will arm the others, and in the pop-up set it to run from Group Run.**

The Scope field is not selectable. To set how the scope is run, select the field under Scope Arm In.
- 5 Select the other instrument fields and choose the mechanism which will arm them.**

The Analyzer Arm Out field determines which analyzer sends the arming signal to Port Out and to the oscilloscope if the oscilloscope is being armed by an analyzer.

As you set each machine, the arrows connecting the fields in the Arming Control menu change. The arrows show the order in which the instruments are armed.

See the example on the next page.
- 6 Select Done until you are back at the Trigger menu.**

---

**Example**

In this example STATE MACH triggers from Group Run, then arms TIME MACH and Scope.

To duplicate this, set STATE MACH to run from Group Run, TIME MACH to run from STATE MACH, and Scope Arm In to Analyzer.

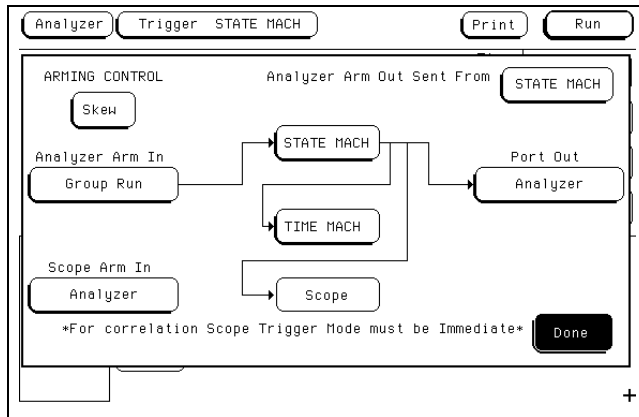

**Arming with two analyzers and an oscilloscope**

When the run starts, the state analyzer automatically begins evaluating its trigger sequence instruction. When the trigger sequence is satisfied, the state analyzer sends an "Arm" signal to the timing analyzer, the oscilloscope, and the external trigger.

---

---

## To receive an arm signal from another instrument

When you set the analyzer to wait for an arm signal, it does not react to data that would normally trigger it until after it has received the arm signal. The arm signal can be sent to any of the Trigger Sequence levels, but will go to level 1 unless you change it. Setting up the analyzer to receive an arm signal is more efficient when the sequence levels are already in place.

- 1** Connect a BNC cable from the instrument which will be sending the signal to the External Trigger Input port on the back of the logic analyzer.

---

**CAUTION**

Do not exceed 5.5 volts on the External Trigger Input.

The External Trigger Input port is also referred to as "Port In." It uses standard TTL logic signal levels, and expects a rising edge as input.

- 2** In the Analyzer Trigger menu, select Arming Control.

Arming Control is below the Run button.

- 3** Select the Analyzer Arm In field, and choose PORT IN.

- 4** To change the default settings, select the analyzer field.

A small pop-up menu appears. To change which device the analyzer is receiving its arm signal from, select the Run from field. To change which sequence level is waiting for the arm signal, select the Arm sequence level field.

- 5** Select Done until you are back at the Trigger menu.

---

## Managing Memory

Sometimes you will need every last bit of memory you can get on the logic analyzer. There are three simple ways to maximize memory when specifying your trigger:

- Selectively store branch conditions (State only)
- Place the trigger relative to memory
- Set the sampling rates (Timing only)

---

## To selectively store branch conditions (State only)

Besides setting up your trigger levels to store anystate, no state, or some subset of states, you can also choose whether or not to store branch conditions. Branch conditions are always stored by default, and can make tracing the analyzer's path through a complicated trigger easier. If you really need the extra memory, however, it is possible to not store the branch conditions.

You cannot set the analyzer to store only some branches in a trigger sequence specification.

**1 In the Analyzer Trigger menu, select Acquisition Control.**

The Acquisition Control menu pops up. If the acquisition mode is set to Automatic, the menu contains a single field and an explanation. If Acquisition has been customized, it has 3 fields and a picture showing where the trigger is currently placed in memory.

**2 If the mode is Automatic, select the field to toggle it to Manual.**

The menu now shows three fields and a picture.

**3 Select the Branches Taken Stored field.**

It toggles to Branches Taken Not Stored.

**4 Select Done.**

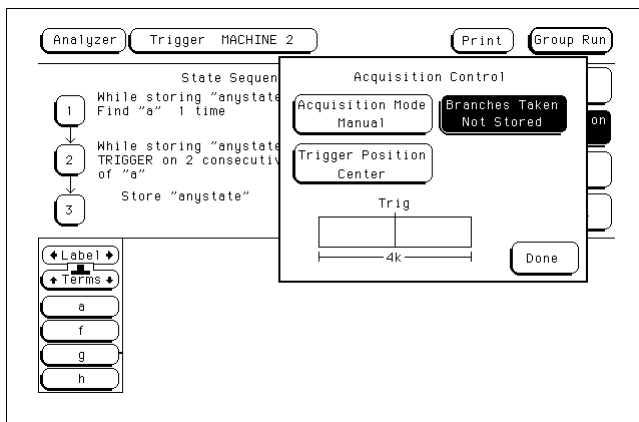

Acquisition Control menu with branches field highlighted

---

## To place the trigger in memory

In Automatic Acquisition Mode, the exact location of the trigger depends on the trigger specification but usually falls around the center. You can manually place it to be at the beginning, end, or anywhere else.

**1 In the Analyzer Trigger menu, select Acquisition Control.**

The Acquisition Control menu pops up. If the acquisition mode is set to Automatic, the menu contains a single field and an explanation. If Acquisition has been customized, it has 3 or 4 fields and a picture showing where the trigger is currently placed in memory.

**2 If the mode is Automatic, select the field to toggle it to Manual.**

The menu now shows three fields and a picture.

**3 Select the Trigger Position field.**

A list of choices appears, as shown in the timing trigger example below.

**4 Select the appropriate entry for your needs.**

Start, Center, and End place the trigger respectively at the beginning, middle, and end of the memory. Delay, available in timing analyzers only, causes the analyzer to not save any data before the time delay has elapsed. User Defined calls up a fourth field where you specify exactly where you want the trigger.

**5 Select Done.**

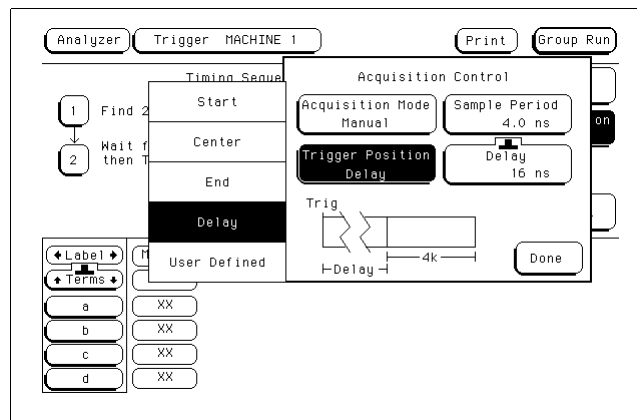

Acquisition Control menu with trigger position pop-up for a timing analyzer



## To set the sampling rates (Timing only)

A timing analyzer samples the data based on its own internal clock. A short sample period provides more detail about the device under test; a long sample period allows more time before memory is full. However, if the sample period is too large, some information may be missed.

- 1 In the Analyzer Trigger menu, select Acquisition Control.

The Acquisition Control menu pops up. If the acquisition mode is set to Automatic, the menu contains a single field and an explanation. If Acquisition has been customized, it has 3 or 4 fields and a picture showing where the trigger is currently placed in memory.

- 2 If the mode is Automatic, select the field to toggle it to Manual.

The menu now shows three fields and a picture.

- 3 Set the Sample Period field using the knob, or select it to use the keypad to enter the period.

- 4 Select Done.

Next time you take a measurement, the analyzer will sample at the rate you entered.

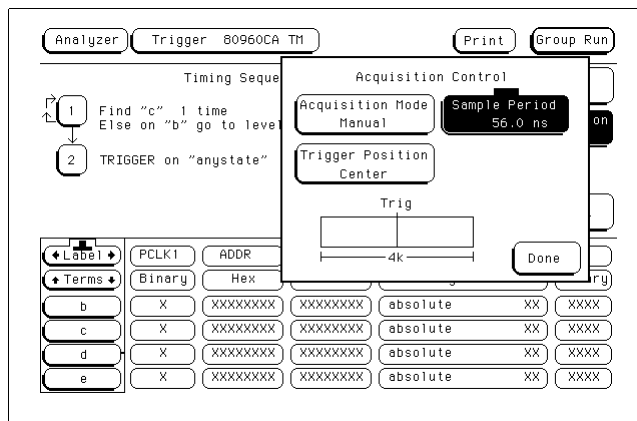

Acquisition Control menu with Sample Period selected





---

## Triggering Examples

---

## Triggering Examples

As you begin to understand a problem in your system, you may realize that certain conditions must occur before the problem occurs. You can use sequential triggering to ensure that those conditions have occurred before the analyzer recognizes its trigger and captures information.

If you are not familiar with the trigger menus, read through the previous chapter, "Using the Trigger Menu," and try working through the examples in the Logic Analyzer Training Kit manual.

---

## Single-Machine Trigger Examples

The following examples require only a single analyzer to make measurements. Sequence specifications are given in the form you see within the sequence levels, but the illustrations show the complete, multi-level sequence specification.

Although all the examples are case-specific, terms are named in a way that highlights their role in solving the trigger problem. You can easily apply the examples to your specific instance by changing the specific values assigned to the trigger terms.



## To store and time the execution of a subroutine

Most system software of any kind is composed of a hierarchy of functions and procedures. During integration, testing, and performance evaluation, you want to look at specific procedures to verify that they are executing correctly and that the implementation is efficient. The analyzer allows you to do this by triggering on entry to the address range of the subroutine and counting the elapsed time since the trigger state.

- 1** Go to the state analyzer's Trigger menu.
- 2** Set Count to Time.
- 3** Define a range term, such as Range1, to represent the address range of the particular subroutine.

You may need to examine the structure of your code to help determine this. If your subroutine calls are really procedure calls, then there is likely to be some code at the beginning of the routine that adjusts the stack for local variable allocation. This will precede the address of the first statement in the procedure. If your subroutine has no local storage and is called by a jump or branch, then the first statement will also be the entry address.

- 4** Under State Sequence Levels, enter the following sequence specification:
  - While storing "no state" TRIGGER on "In\_Range1" Occurs 1 Else on "no state" go to level 1
  - While storing "In\_Range1" Then find "Out\_Range1" Occurs 1 Else on "no state" go to level 2
  - Store "no state" on "no state" go to level 1

For processors that prefetch instructions or have pipelined architectures, you may want to add part or all of the depth of the pipeline to the start address for In\_Range1 to ensure that the analyzer does not trigger on a prefetched but unexecuted state.

The figure below shows what you would see on your analyzer screen after entering the sequence specification given in step 4.

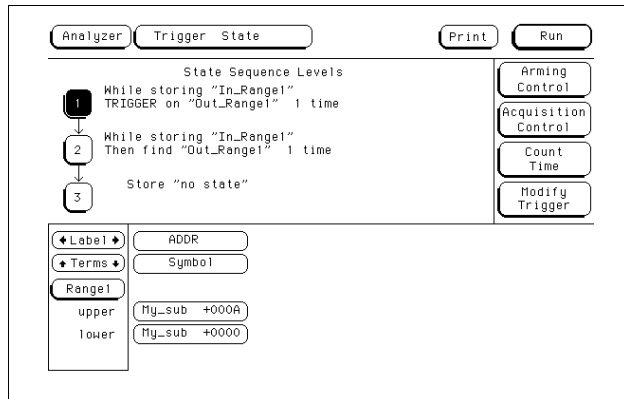

**Trigger setup for storing and timing execution of a subroutine**

Suppose you want to trigger on entry to a routine called MY\_SUB. You can create a symbol from the address of MY\_SUB in the Format menu, allowing you to reference the symbol name when setting up the trace specification. Assume that MY\_SUB extends for 0A hex locations. You can set up the trigger sequence as shown in the display.

---

## To trigger on the nth iteration of a loop

Traditional debugging requires print statements around the area of interest. This is not possible in most embedded systems designs, but the analyzer allows you to view the system's behavior when a particular event occurs. Suppose that your system behaves incorrectly on the last iteration of a loop, which, in this instance, happens to be the 10th iteration. You can use the analyzer's triggering capabilities to capture that iteration and subsequent processor activity.

- 1 Go to the state analyzer's Trigger menu.
- 2 Define the terms LP\_START and LP\_END to represent the start and end addresses of statements in the loop, and LP\_EXIT to represent the first statement executed after the loop terminates.
- 3 Change State Sequence Level 1's macro to "Find event2 n times after event1 before event3 occurs."
- 4 In the pop-up, enter the following sequence specification:
  - While storing anystate Find "LP\_START" "9" times after "LP\_END" before "LP\_EXIT" occurs.

You should use your value for n-1 instead of "9" in the sequence specification above.

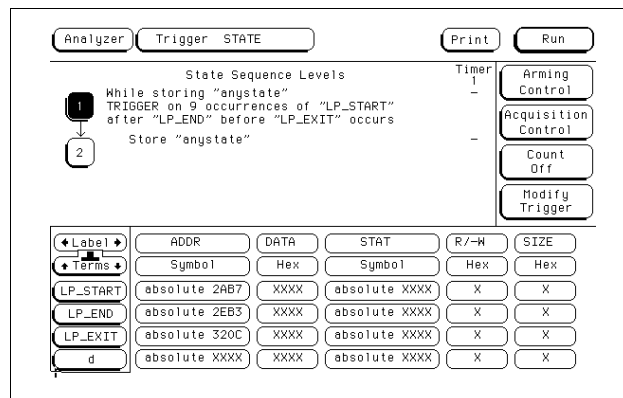

Trigger setup for triggering on the 10th iteration of a loop



The specification has some advantages and a potential problem.

- The advantages are that a pipelined processor won't trigger until it has executed the loop 10 times. Requiring LP\_END to be seen at least once first ensures that the processor actually entered the loop; then, 9 more iterations of LP\_START is really the 10th iteration of the loop. Also, no trigger occurs if the loop executes less than 10 times – the analyzer sees LP\_EXIT and restarts the trigger sequence.
- The potential problem is that LP\_EXIT may be too near LP\_END and thus appear on the bus during a prefetch. The analyzer will constantly restart the sequence and will never trigger. The solution to this problem depends on the structure of your code. You may need to experiment with different trigger sequences to find one that captures only the data you want to view.



## To trigger on the nth recursive call of a recursive function

- 1 Go to the state analyzer's Trigger menu.
- 2 Define the terms CALL\_ADD, F\_START, and F\_END to represent the called address of the recursive function, and the start and end addresses of the function. Define F\_EXIT to represent the address of the first program statement executed after the original recursive call has terminated.

Typically, CALL\_ADD is the address of the code that sets up the activation record on the stack, F\_START is the address of the first statement in the function, and F\_END is the address of the last instruction of the function, which does not necessarily correspond to the address of the last statement. If the start of the function and the address called by recursive calls are the same, or you are not interested in the function initialization code, you can use F\_START for both CALL\_ADD and F\_START.

- 3 Change State Sequence Level 1's macro to "Find event2 n times after event1 before event3 occurs."
- 4 In the pop-up, enter the following sequence specification:
  - While storing anystate Find "CALL\_ADD" "9" times after "F\_START" before "F\_EXIT" occurs.

You should use your value for n-1 instead of "9" in the specification.

- 5 Insert another sequence level before the current one. Select the User Level macro and enter the following specification:
  - While storing "no state" Find "F\_END" occurs "1" Else on "no state" go to level 1.

As with the trigger specification for "To trigger on the nth iteration of a loop," this specification helps avoid potential problems on pipelined processors by requiring that the processor already be in the first recursive call before advancing the sequencer. Depending on the exact code used for the calls, you may need to experiment with different trigger sequences to find one that captures only the data you want to view.

Single-Machine Trigger Examples  
 To trigger on the nth recursive call of a recursive function

Analyzer Trigger STATE Print Run

State Sequence Levels

1 While storing "no state"  
Find "F\_END" 1 time

2 While storing "anystate"  
TRIGGER on 9 occurrences of "CALL\_ADD"  
after "F\_START" before "F\_EXIT" occurs  
Store "anystate"

3

Timer 1 -

Arming Control

Acquisition Control

Count Off

Modify Trigger

Label	ADDR	DATA	STAT	R/-W	SIZE
Symbol	Hex	Symbol	Hex	Hex	
F_START	absolute 2AB7	XXXX	absolute XXXX	X	X
F_END	absolute 2EB3	XXXX	absolute XXXX	X	X
F_EXIT	absolute 320C	XXXX	absolute XXXX	X	X
CALL_ADD	absolute 256A	XXXX	absolute XXXX	X	X

Triggering on the 10th call of a recursive function

---

## To trigger on entry to a function

This sequence triggers on entry to a function only when it is called by one particular function.

- 1 Go to the state analyzer's Trigger menu.
- 2 Define the terms F1\_START and F1\_END to represent the start and end addresses of the calling function. Define F2\_START to represent the start address of the called function.
- 3 Change State Sequence Level 1's macro to "Find event2 n times after event1 before event3 occurs."
- 4 In the pop-up menu, enter the following sequence specification:
  - While storing anystate Find "F2\_START" "1" times after "F1\_START" before "F1\_END" occurs.

This sequence specification assumes there is some conditional logic in function F1 that chooses whether or not to call function F2. Thus, if F1 ends without the analyzer having seen F2, the sequence restarts.

The specification also stores all execution inside function F1, whether or not F2 was called. If you are interested only in the execution of F1, without the code that led to its invocation, you can change the storage specification from "anystate" to "nostate" for the second sequence term.

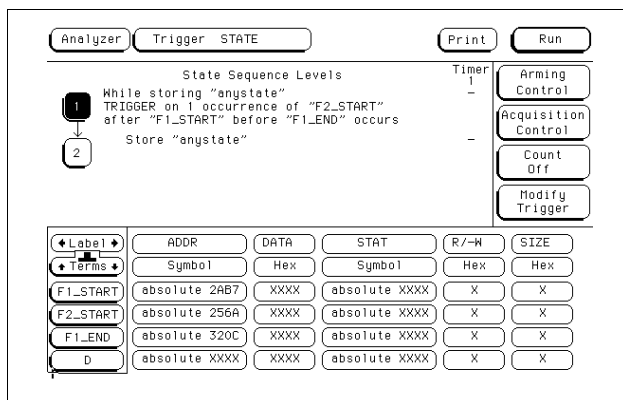

Triggering on entry to a function

---

## To capture a write of known bad data to a particular variable

The trigger specification ANDs the bad data on the data bus, the write transaction on the status bus, and the address of the variable on the address bus.

- 1 Go to the state analyzer's Trigger menu.
- 2 Define the terms BAD\_DATA, WRITE, and VAR\_ADDR to represent the bad data value, write status, and the address of the variable.
- 3 Under State Sequence Level 1, enter the following sequence specification (use the Combination trigger term):
  - While storing "anystate" TRIGGER on "BAD\_DATA • WRITE • VAR\_ADDR" Occurs "1" Else on "no state" go to level "1"

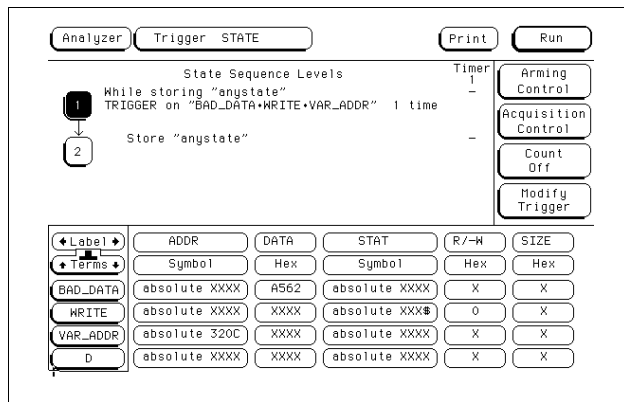

Capturing a bad write to a variable

## To trigger on a loop that occasionally runs too long

This example assumes the loop normally executes in 14  $\mu$ s.

- 1 Go to the state analyzer's Trigger menu.
- 2 Define terms LP\_START and LP\_END to represent the start and end addresses of the loop, and set Timer1 to the normal duration of the loop.
- 3 Change State Sequence Level 1's macro to "Find event2 occurring too late after event1."
- 4 In the pop-up menu, enter the following sequence specification:
  - While storing anystate Find "LP\_END" occurring too late after "LP\_START" Use Timer: "Timer1" Time="14  $\mu$ s"

Of course, you use your normal loop duration in place of "14  $\mu$ s." The macro will automatically start Timer1 for you.

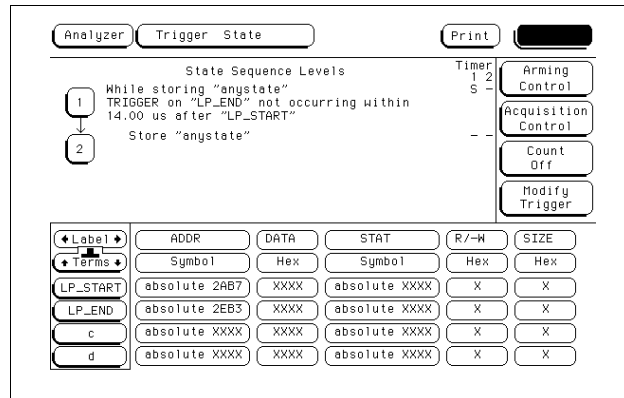

Triggering on a loop overrun

## To verify correct return from a function call

The exit code for a function will often contain instructions for deallocating stack storage for local variables and restoring registers that were saved during the function call. Some language implementations vary on these points, with the calling function doing some of this work, so you may need to adapt the procedure to suit your system.

- 1 Go to the state analyzer's Trigger menu.
- 2 Define terms SR\_START and SR\_END to represent the start and end addresses of the subroutine.
- 3 Under State Sequence Levels, insert 2 more sequence levels and enter the following sequence specification:
  - While storing "anystate" Find "SR\_START" Occurs "1" Else on "no state" go to level "1"
  - While storing "anystate" Then find "SR\_END" Occurs "1" Else on "no state" go to level "2"
  - While storing "anystate" TRIGGER on "≠ SR\_START" Occurs "1" Else on "SR\_START" go to level "2"

The screenshot shows the state analyzer interface with the Trigger menu set to 'STATE'. The State Sequence Levels are configured as follows:

- Level 1: While storing "anystate" Find "SR\_START" 1 time
- Level 2: While storing "anystate" Then find "SR\_END" 1 time
- Level 3: While storing "anystate" TRIGGER on "≠ SR\_START" 1 time Else on "SR\_START" go to level 2

The interface also includes a table for defining terms:

Label	ADDR	DATA	STAT	R/W	SIZE
SR_START	absolute 567A	XXXX	absolute XXXX	X	X
SR_END	absolute 6001	XXXX	absolute XXXX	X	X
c	absolute XXXX	XXXX	absolute XXXX	X	X
d	absolute 0000	0000	absolute 0000	0	0

Verifying correct return from a function call

---

## To trigger after all status bus lines finish transitioning

In some applications, you will want to trigger a measurement when a particular pattern has become stable. For example, you might want to trigger the analyzer when a microprocessor's status bus has become stable during the bus cycle.

- 1 Go to the timing analyzer's Trigger menu.
- 2 Define a term called PATTERN to represent the value to be found on the status bus lines.
- 3 Under Timing Sequence Levels, enter the following sequence specification:
  - TRIGGER on "PATTERN" > 40 ns

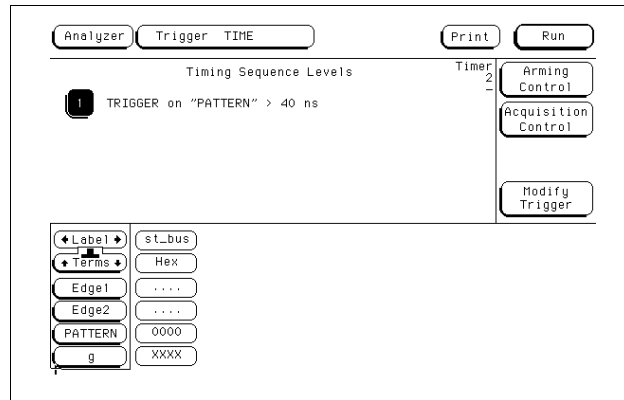

Triggering after lines have finished transitioning



---

## To find the nth assertion of a chip select line

- 1 Go to the timing analyzer's Trigger menu.
- 2 Define the Edge1 term to represent the asserting transition on the chip select line.

You can rename the Edge1 term to make it correspond more closely to the problem domain, for example, to CHIP\_SEL.

- 3 Under Timing Sequence Levels, enter the following sequence specification:

- TRIGGER on "CHIP\_SEL" Occurs "10" Else on "no state" go to level "1"

You should use your value for "n" in place of "10" in the specification above.

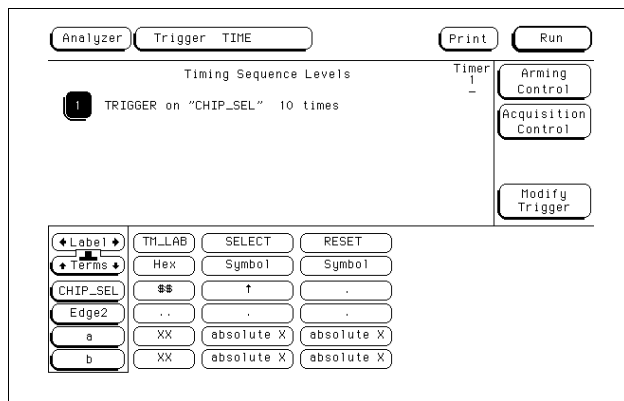

Triggering on the 10th assertion of a chip select line

---

## To verify that the chip select line is strobed after the address is stable

- 1 Go to the timing analyzer's Trigger menu.
- 2 Define a term called ADDRESS to represent the address in question and the Edge1 term to represent the asserting transition on the chip select line.

You can rename the Edge1 term to suit the problem, for example, to MEM\_SEL.

- 3 Under Timing Sequence Levels, enter the following sequence specification:
  - Find "ADDRESS" > 80 ns
  - TRIGGER on "MEM\_SEL" Occurs "1" Else on "≠ ADDRESS" go to level "1"

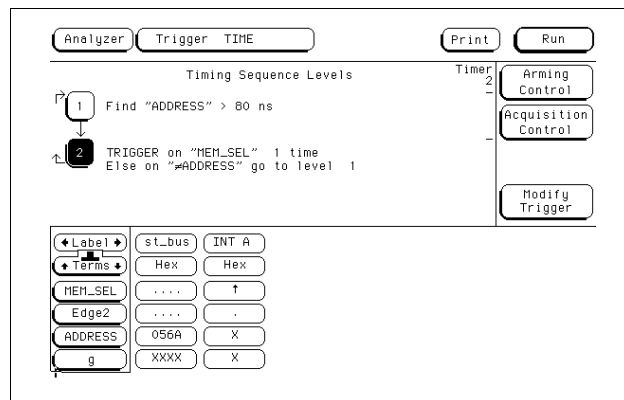

Verifying setup time for memory address

---

## To trigger when expected data does not appear when requested

- 1 Go to the timing analyzer's Trigger menu.
- 2 Define a term called DATA to represent the expected data, the Edge1 term to represent the chip select line of the remote device, and the Timer1 term to identify the time limit for receiving expected data.  
You can rename the Edge1 and Timer1 terms to match the problem domain, for example, to REM\_SEL and ACK\_TIME.
- 3 Under Timing Sequence Levels, enter the following sequence specification:
  - Find "REM\_SEL" Occurs "1" Else on "no state" go to level "1"
  - TRIGGER on "ACK\_TIME > 16.00  $\mu$ s" Occurs "1" Else on "DATA" go to level "1"

You will need to start ACK\_TIME timer (Timer1) upon entering this state. You do this using the Timer Control field in the menu for sequence level 2.

This sequence specification causes the analyzer to trigger when the data does not occur in 16  $\mu$ s or less. If it does occur within 16  $\mu$ s, the sequence restarts. Specifications of this type are useful in finding intermittent problems. You can set up and run the trace, then cycle the system through temperature and voltage variations, using automatic equipment if necessary. The failure will be captured and saved for later review.

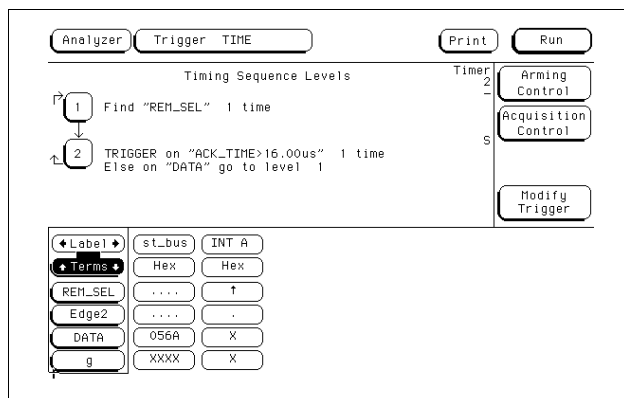

Triggering when data not returned

---

## To test minimum and maximum pulse limits

- 1 Go to the timing analyzer's Trigger menu.
- 2 Define the Edge1 term to represent the positive-going transition, and define the Edge2 term to represent the negative-going transition on the line with the pulse to be tested.

You can rename these terms to POS\_EDGE and NEG\_EDGE.

- 3 Define the Timer1 term to represent the minimum pulse width, and the Timer2 term to represent the maximum pulse width.

You can rename these terms to MIN\_WID and MAX\_WID. In this example, Timer1 was set to 496 ns and Timer2 was set to 1  $\mu$ s. Both timers start when sequence level 2 is active.

- 4 Under Timing Sequence Levels, enter the following sequence specification:

- Find "POS\_EDGE" Occurs "1" Else on "no state" go to level "1"
- Then find "NEG\_EDGE" Occurs "1" Else on "no state" go to level "2"

You will need to start both timers upon entering this second state. You do this using the Timer Control field in the menu for sequence level 2.

- TRIGGER on "MIN\_WID 496 ns + MAX\_WID 1.00  $\mu$ s" Occurs "1" Else on "anystate" go to level "1"

Because both timers start when entering sequence level 2, they start as soon as the positive edge of the pulse occurs. Once the negative edge occurs, the sequencer transitions to level 3. If at that point, the MIN\_WID timer is less than 496 ns or the MAX\_WID timer is greater than 1  $\mu$ s, the pulse width has been violated and the analyzer triggers. Otherwise, the sequence is restarted.

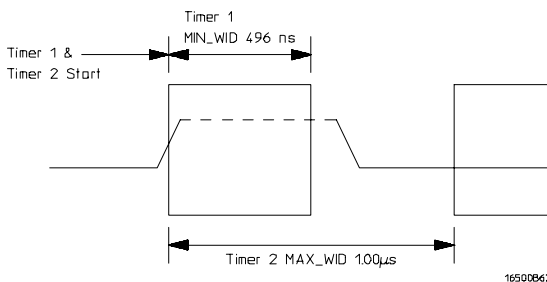

### Measurement of minimum and maximum pulse width limits

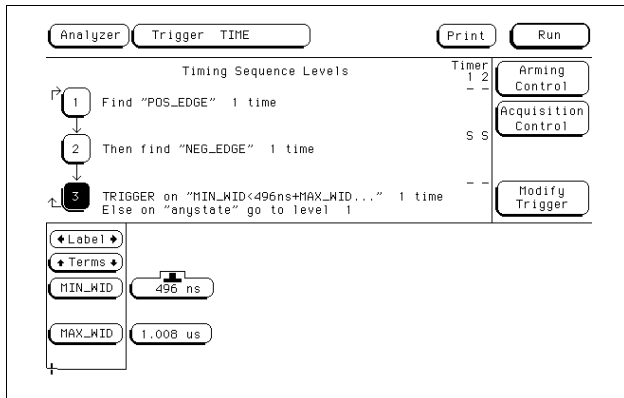

Triggering when a pulse exceeds minimum or maximum limits

---

## To detect a handshake violation

- 1 Go to the timing analyzer's Trigger menu.
- 2 Define the Edge1 term to represent either transition on the first handshake line, and the Edge2 term to represent either transition on the second handshake line.

You can rename these terms to match your problem, for example, to REQ and ACK.

- 3 Under Timing Sequence Levels, enter the following sequence specification:

- Find "REQ" Occurs "1" Else on "no state" go to level "1"
- TRIGGER on "REQ" Occurs "1" Else on "ACK" go to level "1"

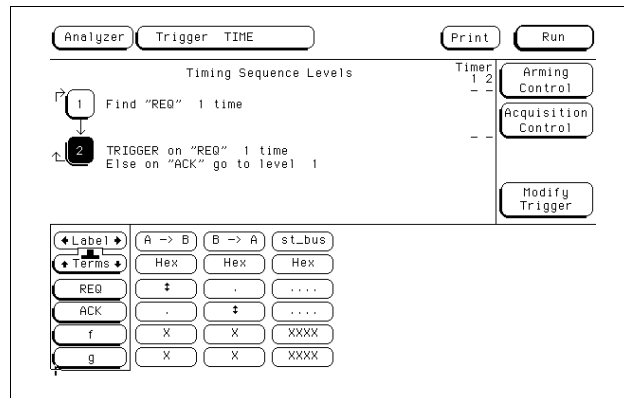

Triggering on a handshake violation

---

## To detect bus contention

In this setup, the trigger occurs only if both devices assert their bus transfer acknowledge lines at the same time.

- 1 Go to the timing analyzer's Trigger menu.
- 2 Define the Edge1 term to represent assertion of the bus transfer acknowledge line of one device, and Edge2 term to represent assertion of the bus transfer acknowledge line of the other device. You can rename these to BTACK1 and BTACK2.
- 3 Under Timing Sequence Levels, enter the following sequence specification:
  - TRIGGER on "BTACK1 • BTACK2" Occurs "1" Else on "no state" go to level "1"

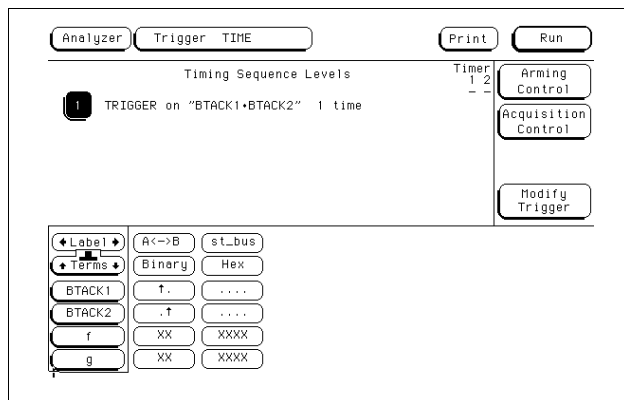

Triggering on bus contention

---

## Cross-Arming Trigger Examples

The following examples use cross arming to coordinate measurements between two separate analyzers within the logic analyzer or between analyzers and the oscilloscope. The analyzers can be configured as either a state analyzer and timing analyzer, or two state analyzers. It is not possible to set both to timing.

You set up cross arming in the Arming Control menu (obtained by selecting Arming Control in the Trigger menu). When coordinating measurements between two instruments, you need to select Count Time to correlate the measurements. When correlating measurements between an analyzer and the scope you also need to set the oscilloscope Trigger Mode to Immediate.

**See also**

"Arming and Additional Instruments" in Chapter 4 for more information on cross arming.



---

## To examine software execution when a timing violation occurs

The timing analyzer triggers when the timing violation occurs. When it triggers, it also sets its "arm" level to true. When the state analyzer receives the arm signal, it triggers immediately on the present state.

- 1 Set up one state analyzer and one timing analyzer.
- 2 Go to the timing analyzer's Trigger menu.
- 3 Define Edge1 to represent the control line where the timing violation occurs.
- 4 Under Timing Sequence Levels, enter the following sequence specification:
  - TRIGGER on "Edge1" Occurs "1" Else on "no state" go to level "1"
- 5 Go to the state analyzer's Trigger menu and check that term "a" is set to "don't care". In the Arming Control menu set the state analyzer to be run by the timing analyzer.

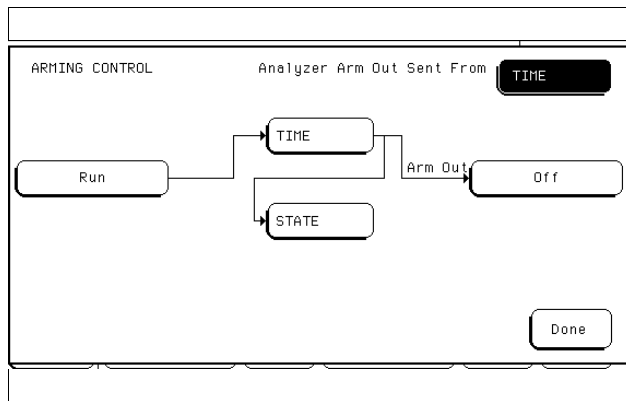

### Arming the state analyzer from the timing analyzer

- 6 Under State Sequence Levels, enter the following sequence specification:
  - While storing "anystate" TRIGGER on "arm • a" Occurs "1" Else on "no state" go to level "1"

---

## To look at control and status signals during execution of a routine

The state analyzer will trigger on the start of the routine whose control and status signals are to be examined more frequently than once per bus cycle. When the state analyzer triggers, it sends out an arm signal. The timing analyzer triggers when it receives the true arm level and detects the transition represented by Edge1.

- 1** Set up one state analyzer and one timing analyzer.
- 2** Go to the state analyzer's Trigger menu and define term R\_START to represent the starting address of the routine.
- 3** Under State Sequence Levels, enter the following sequence specification:
  - While storing "anystate" TRIGGER on "R\_START" Occurs "1" Else on "no state" go to level "1"
- 4** Go to the timing analyzer's Trigger menu.
- 5** Define the Edge1 term to represent a transition on one of the control signals.
- 6** Set the timing analyzer to be run by the state analyzer. Under Timing Sequence Levels, enter the following sequence specification:
  - TRIGGER on "arm • Edge1" 1 time

You do not need to use a combination trigger when one analyzer is armed from the other analyzer - the arm term is ANDed automatically with the term already in use.

---

## To detect a glitch

The following setup uses a state analyzer to capture state flow occurring at the time of the glitch. This can be useful in troubleshooting. For example, you might find that the glitch is ground bounce caused by a number of simultaneous signal transitions.

- 1 Set up a timing analyzer and a state analyzer.**
- 2 Go to the timing analyzer's Format menu and set the Timing Acquisition Mode to Glitch Half Channel 125 MHz.**  
Glitch mode only allows you to use one pod of a pod pair at a time. If the wrong pod is active, toggle by selecting the Pod button.
- 3 Go to the timing analyzer's Trigger menu.**
- 4 Select an Edge term. Then assign glitch detection "\*" to the channels of interest represented by the Edge term.**
- 5 Go to the state analyzer's Trigger menu.**
- 6 Set the analyzer to be armed by the timing analyzer. Leave the trigger set to trigger on any state.**

If you don't see the activity of interest in the state trace, try changing the trigger position using the Acquisition Control field in the Trigger menu of the state analyzer. By changing the Acquisition mode to manual, you can position the trigger at any state relative to analyzer memory.

The timing analyzer can detect glitch activity on a waveform. A glitch is defined as two or more transitions across the logic threshold between adjacent timing analyzer samples.

## To capture the waveform of a glitch

The following setup uses the triggering capability of the timing analyzer and the acquisition capability of the oscilloscope.

- 1 Set up a timing analyzer. Go to the timing analyzer's Format menu and set the Timing Acquisition Mode to Glitch Half Channel 125 MHz.**  
Glitch mode only allows you to use one pod of a pod pair at a time. If the wrong pod is active, toggle by selecting the Pod field.
- 2 Go to the timing analyzer's Trigger menu.**
- 3 Select an Edge term. Then assign glitch detection "\*" to the channels of interest represented by the Edge term.**
- 4 Go to the Arming Control menu. Set the Scope Arm In to Analyzer.**
- 5 Select Group Run in the Analyzer Arm In menu.**
- 6 Go to the Scope Trigger menu, and set Mode to Immediate.**

If you have trouble capturing the glitch waveform on the oscilloscope, try adjusting the skew in the Arming Control menu, so the oscilloscope triggers earlier.

A timing analyzer can trigger on a glitch and capture it, but a timing analyzer doesn't have the voltage or timing resolution to display the glitch in detail. An oscilloscope can display a glitch waveform with fine resolution, but cannot trigger on glitches, combinations of glitches, or sophisticated patterns involving many channels.

---

## To view your target system processing an interrupt

Use the oscilloscope to trigger on the asynchronous interrupt request.

- 1** Go to the state analyzer's Trigger menu, and set the analyzer to trigger on any state and store any state.
- 2** Select Arming Control. Set the analyzer to respond to the arm signal from the oscilloscope, and set the oscilloscope to Group Run.
- 3** Go to the Scope Trigger menu, and set the mode to Edge trigger. Set the Source field to C1, and probe the interrupt with Channel 1.
- 4** Press the Run key.

When the interrupt occurs, the oscilloscope will trigger, subsequently triggering the state analyzer.

If the analyzer doesn't capture the expected interrupt activity, ensure that the interrupt isn't masked due to the actions of other program code.

This setup can help you answer questions like the following:

- Does the processor branch to the proper interrupt handling routine?
- Are registers and status information saved properly?
- How long does it take to service the interrupt?
- Is the interrupt acknowledged properly?
- After the interrupt is serviced, does the processor restore registers and status information and continue with the interrupted routine as expected?

You can use the state analyzer to check the address of the interrupt routine as well as to see if interrupt processing is done as expected. Using a preprocessor and inverse assembler with the state analyzer will make it easier to read the program flow.

## To trigger timing analysis of a count-down on a set of data lines

Your target system may include various state machines that are started by system events such as interrupt processing or I/O activity. The state analyzer is ideal for recognizing the system events; the timing analyzer is ideal for examining the step-by-step operation of the state machines.

- 1** Set up a timing analyzer and a state analyzer.
- 2** Go to the state analyzer's Trigger menu.
- 3** Set the timing analyzer to be run from the state analyzer.
- 4** Set the state analyzer to trigger on the label and term that identify the start of the count-down routine.
- 5** Go to the timing analyzer's Trigger Menu.
- 6** Set the timing analyzer to trigger on any state and store any state.

## To monitor two coprocessors in a target system

Debugging coprocessor systems can be a complex task. Replicated systems and contention for shared resources increase the potential problems. Using two state analyzers with preprocessors can make it much easier to discover the source of such problems. For example, you may want to set up one analyzer to trigger only when a certain problem occurs, and set up the other analyzer to be armed by the first analyzer so that it takes its trace only when the first analyzer recognizes its trigger. This will let you observe the behavior of both coprocessors during the occurrence of a problem

- 1** Set up both analyzers as state analyzers.
- 2** Go to the first analyzer's Trigger menu.
- 3** Set the second analyzer to be run from the first analyzer.
- 4** Turn on "Count Time".
- 5** Set the first analyzer to trigger on the problem condition.

Some problems may involve complex sequences of conditions. See earlier examples in this chapter for more information on defining a trigger sequence.

- 6** Go to the Trigger menu of the second analyzer.
- 7** Check that the second analyzer is triggering on arm and that Count Time is set.

After the measurement is complete, you can interleave the trace lists of both state analyzers to see the activity executed by both coprocessors during related clock cycles.

You can use a similar procedure if you have only one processor, but want to monitor its activity with that of other system nodes, such as chip-select lines, I/O activity, or behavior of a watchdog timer. In some instances it may be easier to look at related activity with a timing analyzer.

### See Also

"Special Displays" in this chapter.

"To trigger timing analysis of a count-down on a set of data lines" in this chapter.

### **Interleaved trace lists**

Interleaved trace lists allow you to view data captured by two analyzers in a single display. When you interleave the traces, you see each state that was captured by each analyzer. These states are shown on consecutive lines.

You can interleave state listings from state analyzers when two are used together in a run. Interleaved state listings are useful when you are using multiple analyzers to look at interaction between two or more processors. They are also useful when you need more analysis width than is available in one analyzer.

### **Mixed Display mode**

The Mixed Display mode allows you to show state listings and timing waveforms together on screen. State listings are shown at the top of the screen and waveform displays are shown at the bottom. You can interleave state listings from two analyzers at the top of the screen, if desired. You can display waveforms from the timing analyzer at the bottom of the screen.



## To interleave trace lists

- 1 Set up both analyzers as state analyzers.
- 2 Go to the Trigger menu of the first analyzer.
- 3 Set Count to Time, and set up the trigger.

The logic analyzer uses the time tags stored with each state to determine the ordering of states shown in an interleaved trace list.

- 4 Set Count to Time, and set up the trigger on the second analyzer.

The second analyzer does not need to be run from the first analyzer, but both analyzers must have "Count Time" turned on in order to correlate the data.

- 5 Make the measurement run.
- 6 Go to one of the Listing menus.
- 7 Select one of the label fields in the trace list display, then select Interleave.
- 8 Select the name of the other analyzer and the label to interleave.

Interleaved data is displayed in a light shade. Trace list line numbers of interleaved data are indented. The labels identifying the interleaved data are shown above the labels for the current analyzer, and are displayed in a light shade.

If you have problems with the procedure, check that each analyzer has an independent clock from the target system.

Label	ST_LAB	TH_LAB	Time	ST_LAB
Base	Hex	Hex	Relative	Hex
29	82	82	8 ns	82
29	83	83	16 ns	83
30	84	83	16 ns	83
31	85	84	8 ns	84
32	85	85	8 ns	85
32	86	85	16 ns	85
33	86	86	8 ns	86
33	87	86	8 ns	86
34	88	87	16 ns	87
34	88	88	8 ns	88
35	89	88	8 ns	88
35	89	89	8 ns	89
36	8A	89	16 ns	89
36	8A	8A	8 ns	8A

Interleaved trace lists on the HP 1661CS

## To view trace lists and waveforms on the same display

- 1** Set up a timing and a state analyzer, or a state analyzer and the oscilloscope.
- 2** Go to the state analyzer's Trigger menu.
- 3** Set Count to Time, and set up the trigger as appropriate.  
You do not need to have one instrument arming the other to display the information jointly, but you do need to turn on Count Time so that the information may be correlated.
- 4** Set up the timing analyzer trigger, if you are using the timing analyzer.  
Timing analyzers implicitly count time because their sampling is driven by an internal clock, rather than an external state clock.
- 5** Set the oscilloscope mode to Immediate, if you are using the oscilloscope.
- 6** Make a measurement run.
- 7** Go to the Mixed Display menu.
- 8** To insert state listings, select any label field from the state listing. From the pop-up that appears, select the desired label to insert.  
You cannot view timing data in the listing area.
- 9** To insert timing or oscilloscope waveforms, double-select the label field to the left of the waveform display area. From the pop-up that appears, select insert, and then the appropriate label.  
You cannot view state analyzer data in the waveform display. However, you can view timing analyzer data and oscilloscope data simultaneously.  
You can also position X and O Time markers on the waveform display. Once set, the time markers will be displayed in both the listing and the waveform display areas. Note that even if you set X and O Time markers in another display, you must also set the Time markers in the Mixed Display if Time markers are desired.

You can use the Mixed Display feature in the analyzer menu to show both waveforms and trace lists in the same display, making it easier to correlate the events of interest.

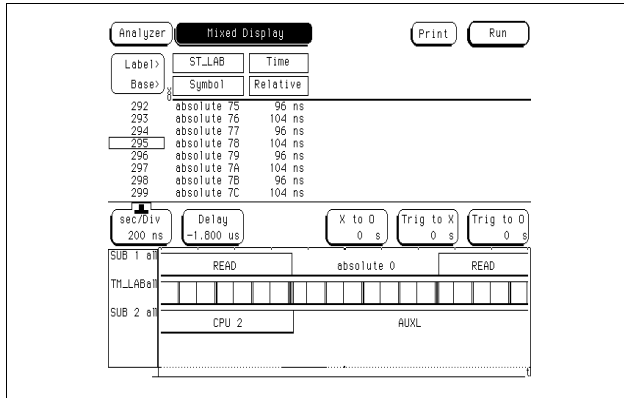

Mixed display using timing and state in the HP 1661CS

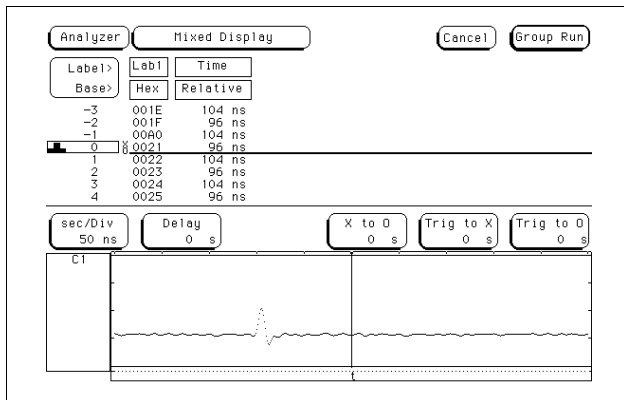

Mixed display using oscilloscope and state in the HP 1661CS





## File Management

---

# File Management

Being able to transfer data to a host computer, such as a PC or UNIX workstation, can enhance the logic analyzer in many ways. You can use the host to store configuration files or measurement results for later review. You can save screen images from the logic analyzer in bitmap files to include in reports developed using word processors or desktop publishing tools. Or, you can develop programs on the PC that manipulate measurement results to satisfy your problem-solving needs.

This chapter shows you how to save the different types of information. The examples store files on the flexible disk drive, but you can move the same files to your host computer using a network interface. The HP 1660CS family of logic analyzers have HP-IB and RS-232-C capabilities, and an optional Ethernet interface. If you need help using the optional LAN interface, see the LAN User's Guide.

You can also use a host computer to send the logic analyzer complex command sequences—allowing you to automate your measurement tasks. If you want to program the analyzer using a host computer, see the *HP 1660C/CS-Series Logic Analyzers Programmer's Guide*.

---

## Transferring Files Using the Flexible Disk Drive

Because the flexible disk drive on the HP 1660CS-series logic analyzer will read and write double-sided, double-density or high-density disks in MS-DOS format, it is a useful tool for transferring data to and from IBM PC-compatible computers as well as transferring data to and from other systems that can read and write MS-DOS format. You can save configuration files, measurement results, and even menu and measurement images from the screen.

This section shows you how to use the flexible disk drive to:

- Save a configuration
- Load a configuration
- Save a trace list in ASCII format
- Save a screen image (such as a display or menu)
- Load system software

---

## To save a configuration

You can save configurations on a 3.5-inch disk or on the internal hard disk for later use. This is especially useful for automating repetitive measurements for production testing.

- 1** Go to the System Hard Disk or System Flexible Disk menu.
- 2** Set the field under System to Store.
- 3** Select the type of configuration you want to save in the field to the right of Store.

You can save the analyzer configuration, the scope configuration, the system configuration, or all three at the same time.

### See Also

Scope, Analyzer, and System subheads of "Load and Store" in Chapter 7 for details of what is stored in a configuration file.

- 4** Specify a file name into which to save the configuration using the to file field.
- 5** Enter a description for the file using the file description field.
- 6** Select Execute.

If you want to save your file in a directory other than the root, you can select Change Directory from the disk operations field, then type the name of the desired directory in the directory name field or select it from the list of visible directories using the knob.



System Hard Disk Cancel

Store System to file: HPIBCTRL.---

file description: HPIB CONTROL CENTRONICS PRINT

Change Dir. file type: 16[6/7]x\_cnfg Execute

DOS Filename	Date	Time	Bytes	File Description
FAN	..A	10Nov95	14:56:42	232704
FAN	..B	10Nov95	14:56:44	69376
FAN	---	10Nov95	14:56:42	1792
GTTOLOAD	..A	12Nov95	13:46:12	75776 status: DISABLED
GTTOLOAD	..B	12Nov95	13:46:14	69376 status: DISABLED
GTTOLOAD	---	12Nov95	13:46:12	1792 status: DISABLED
HPIBCTRL	---	21Nov95	17:16:10	1792 HPIB CONTROL CENTRONICS PRINT
SCOPE	..A	11Nov95	16:23:52	232960 status: DISABLED
SCOPE	..B	11Nov95	16:23:54	69376 status: DISABLED
SCOPE	---	11Nov95	16:23:50	1792 status: DISABLED
SYSTEM		5Oct10	9:37:54	0 DIRECTORY
TAN	..B	21Nov95	14:07:38	69376
TCOPE	---	11Nov95	16:28:12	1792 status: DISABLED

PHD: \  
DOS Disk Space(bytes) - Total: 270,663,680 Free: 267,542,528

Saving the system configuration for programmatic control



## To load a configuration

You can quickly load a previously saved configuration, saving the trouble of manually setting up the measurement parameters.

- 1 Go to the System Hard Disk or System Flexible Disk menu.  
Your choice here depends on where you saved the configuration.
- 2 Select the field below System and select Load from the pop-up menu.
- 3 Select the destination from the module list.  
"System" loads only settings available under the System menus. "Analyzer" loads data and settings for the analyzer. Scope loads data and settings for the oscilloscope. "All" loads the system, oscilloscope, and analyzer configurations.  
You can only load configuration files to the area from which the configuration was taken. For instance, you cannot load an analyzer configuration file to the system. Thus, if you select System, then select a file that contains only an analyzer configuration, the configuration will fail. The file type field tells you what type of information is in a file. Analyzer configuration files show "166xan\_config", oscilloscope configuration files show "166Xsc\_config", and system configuration files show "16[6/7]x\_cnfg" in the file type field.
- 4 Specify a file name from which to load the configuration using the from file field or scrolling with the knob.
- 5 Select Execute.

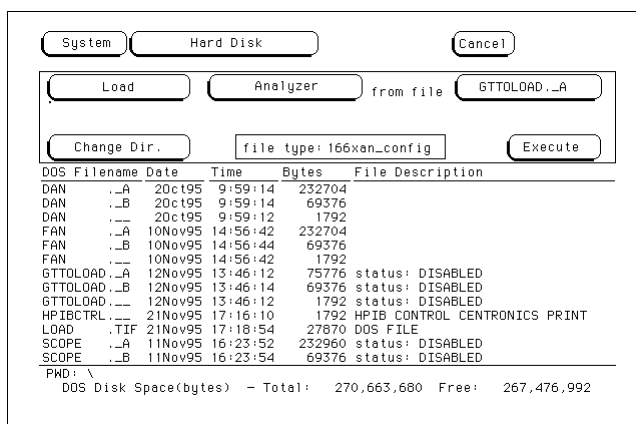

Loading system configuration for programmatic control

## To save a listing in ASCII format

Some screens, such as file lists and trace lists, contain columns of ASCII data that you may want to move to a computer for further manipulation or analysis. You can save these displays as ASCII files. While a screen capture saves only the data shown on screen, saving the display as an ASCII file captures all data in the list, even if it is offscreen.

- 1 Insert a DOS-formatted 3.5-inch disk in the flexible disk drive.
- 2 Set up the menu you want to capture, or run a measurement from which you want to save data.

Remember that only displays that present lists of textual data can be captured as ASCII files.

- 3 Select Print and choose Print Disk from the pop-up menu.
- 4 Select the Filename field and specify a file name to which the data will be saved.
- 5 Select ASCII (ALL) from the Output Format field.

If the current display contents can not be saved as an ASCII file, this option will not be present in the Output Format field.

- 6 Select Flexible Disk from the Output Disk menu, then select Execute.

Label	ADDR	CPU32 Mnemonic	STAT
0	406F4	ANDI.L #*****,(A6)+	Opcode Fetch
1	0FF7A	0004 data write	Data Write
2	0FF7C	06F6 data write	Data Write
3	40992	BSR.B 0004093E	Opcode Fetch
4	40994	nu MOVE.B #*****,(****,A7)	Opcode Fetch
5	0FF76	0004 data write	Data Write
6	0FF78	0994 data write	Data Write
7	4093E	MOVE.W #03FF,00FFFA46	Opcode Fetch
8	40940	03FF pgm read	Opcode Fetch
9	40942	00FF pgm read	Opcode Fetch
10	40944	FA46 pgm read	Opcode Fetch

Part of a trace listing saved as an ASCII file

---

## To save a screen's image

You can save menus and measurements to disk in one of four different graphical formats.

- 1 Insert a formatted flexible disk in the flexible disk drive.
- 2 Set up the menu whose image you want to capture, or run a measurement from which you want to save data.
- 3 Select Print and choose Print Disk from the pop-up menu.

If the screen contains a pop-up menu, the Print field is not available. Pop-up menus cannot be saved to file unless you are using a controller.

- 4 Select the Filename field and specify a file name to save to.
- 5 Select the Output Format field and choose the output format for the graphics file from the pop-up menu.

Choose one of the following formats:

- B/W TIF is a black-and-white TIFF (Tagged Image File Format), v 5.0.
- GRAY TIF is a grayscale TIFF file in TIFF version 5.0 format.
- PCX is a grayscale PCX file (PCX is the PC Paintbrush and Publisher's Paintbrush format from ZSoft).
- EPS is a black-and-white Encapsulated PostScript™ file.

- 6 Select Flexible Disk from the Output Disk menu, then select Execute.

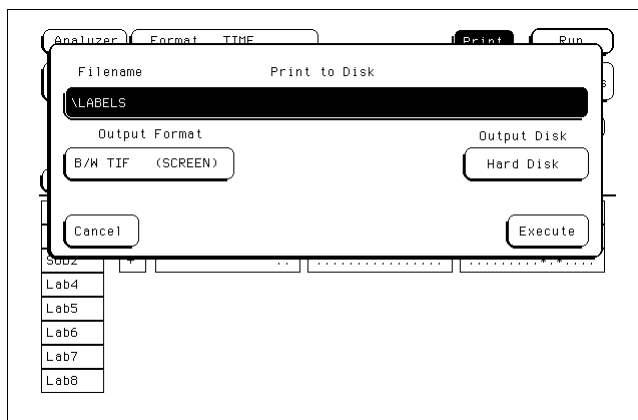

Print Disk menu

## To load additional software

You can enhance the power of your HP 1660CS-series logic analyzer by installing software such as symbol utilities. The software comes with installation instructions. In general, however, you can install logic analyzer software by following these instructions.

- 1 Turn off the logic analyzer.**
- 2 Insert the first disk of the software into the flexible disk drive.**
- 3 Turn on the logic analyzer.**  
The analyzer will load the software as it powers up.
- 4 To permanently install the software, follow the instructions that come with it.**

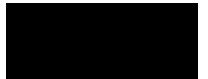





Reference

---

# Logic Analyzer Description

The HP 1660CS-series logic analyzers are part of a family of general-purpose logic analyzers. The HP 1660CS-series consists of four models ranging in channel width from 34 channels to 136 channels, with 100-MHz state and 500-MHz timing speeds and 1 GSa/s oscilloscope sampling rate. The HP 1660CS-series logic analyzers are designed as full-featured standalone or network-configurable instruments for use by digital and microprocessor hardware and software designers. All models have HP-IB, RS-232-C, and Centronics interfaces for hard copy printouts and control by a host computer, and have optional Ethernet LAN interfaces.

Analyzer memory depth is 4 K per channel in all pod pair groupings, or 8 K per channel on one pod of a pod pair (half-channel mode). Oscilloscope memory is 8000 samples per channel.

Measurement data is displayed as data listings and waveforms, and can also be plotted on a chart or compared to a reference image. Profiled data is displayed as histograms of activity by time, state, or address range.

The 100-MHz state analyzer has master, master/slave, and demultiplexed clocking modes available. Measurement data can be stamped with state or time tags. For triggering and data storage, the state analyzer uses 12 sequence levels with two-way branching, 10 pattern resource terms, 2 range terms, and 2 timers.

The 500-MHz timing analyzer has conventional, transitional, and glitch timing modes with variable width, depth, and speed selections. Sequential triggering uses 10 sequence levels with two-way branching, 10 pattern resource terms, 2 range terms, 2 edge terms and 2 timers.

The 1 GSa/s oscilloscope has immediate, edge, and pattern trigger modes. The pattern trigger mode uses both channels, an occurrence counter, and a timer for specifying complex patterns. The oscilloscope also provides statistics and nine automatic measurements.



---

# Configuration Capabilities

The four analyzer models in the HP 1660CS-series offer a wide variety of channel widths and memory depth combinations. The number of data channels range from 34 channels with the HP 1663CS, up to 136 channels with the HP 1660CS. In addition, a half-channel acquisition mode is available which doubles memory depth from 4 K to 8 K per channel while reducing channel width by half. All models have two scope channels and an oscilloscope memory depth of 8 K.

The configuration guide below illustrates the memory depth/channel width combinations in all acquisition modes with all analyzer models.

Table 7-1

---

**State Analyzer Configurations**

---

Mode	HP 1660CS	HP 1661CS	HP 1662CS	HP 1663CS
<b>half-channel 100 MHz</b>	8K-deep / 68 chan. 65 data + 3 data or clock	8K-deep / 51 chan. 48 data + 3 data or clock	8K-deep / 34 chan. 32 data + 2 data or clock	8K-deep / 17 chan. 16 data + 1 data or clock
<b>full-channel 100 MHz</b>	4K-deep / 136 chan. 130 data + 6 data or clock	4K-deep / 102 chan. 96 data + 6 data or clock	4K-deep / 68 chan. 64 data + 4 data or clock	4K-deep / 34 chan. 32 data + 2 data or clock

### State Analyzer Configuration Considerations

- Unused clock channels can be used as data channels.
- With Time or State tags turned on, memory depth is reduced by half. However, full depth is retained if you leave one pod pair unassigned.

Table 7-2

**Timing Analyzer Configurations**

Mode	HP 1660CS	HP 1661CS	HP 1662CS	HP 1663CS
<b>Conventional half-channel 500 MHz</b>	8K-deep / 68 chan. 65 data + 3 data or clock	8K-deep / 51 chan. 48 data + 3 data or clock	8K-deep / 34 chan. 32 data + 2 data or clock	8K-deep / 17 chan. 16 data + 1 data or clock
<b>Conventional full-channel 250 MHz</b>	4K-deep / 136 chan. 130 data + 6 data or clock	4K-deep / 102 chan. 96 data + 6 data or clock	4K-deep / 68 chan. 64 data + 4 data or clock	4K-deep / 34 chan. 32 data + 2 data or clock
<b>Transitional half-channel 250 MHz</b>	8K-deep / 68 chan. 65 data + 3 data or clock	8K-deep / 51 chan. 48 data + 3 data or clock	8K-deep / 34 chan. 32 data + 2 data or clock	8K-deep / 17 chan. 16 data + 1 data or clock
<b>Transitional full-channel 125 MHz</b>	4K-deep / 136 chan. 130 data + 6 data or clock	4K-deep / 102 chan. 96 data + 6 data or clock	4K-deep / 68 chan. 64 data + 4 data or clock	4K-deep / 34 chan. 32 data + 2 data or clock
<b>Glitch half-channel 125 MHz</b>	4K-deep / 68 chan. 65 data + 3 data or clock	4K-deep / 51 chan. 48 data + 3 data or clock	4K-deep / 34 chan. 32 data + 2 data or clock	4K-deep / 17 chan. 16 data + 1 data or clock

**Timing Analyzer Configuration Considerations**

- Unused clock channels can be used as data channels.
- In Glitch half-channel mode, memory is split between data and glitches.

---

# Probing

This section discusses the probing system for the logic analyzer. It also contains the information you need for connecting the probe system components to each other, to the logic analyzer and oscilloscope, and to the system under test.

## Probing Options

You can connect the logic analyzer to your system under test in one of the following ways:

- Microprocessor- and bus-specific interfaces (optional).
- Standard general-purpose probing (provided).
- Direct connection to a 20-pin, 3M-Series type header connector using the optional termination adapter.

### See Also

*Accessories for HP Logic Analyzers* for additional information about the microprocessor interface kits and for any new probing solutions.

### **Microprocessor and Bus-Specific Interfaces**

There are a number of microprocessor- and bus-specific interfaces available as optional accessories. Microprocessors are supported by Universal Interfaces or Preprocessor Interfaces, or in some cases, both.

Universal Interfaces are manufactured by other vendors. Universal Interfaces are aimed at initial hardware turn-on, and provide fast, reliable, and convenient connections to the microprocessor system. Many use passive probing and do not support inverse assembly.

Preprocessor interfaces are aimed at hardware turn-on and hardware/software integration, and provide the following:

- All clocking and demultiplexing circuits needed to capture the system's operation.
- Additional status lines to further decode the operation of the CPU.
- Inverse assembly software to translate logic levels captured by the logic analyzer into microprocessor mnemonics.

Bus interfaces will support bus analysis for the following:

- Bus support for HP-IB, RS-232-C, RS-449, SCSI, VME, and VXI.

### **General-Purpose Probing**

General-purpose probing connects the logic analyzer probes directly to your target system without using any interface. General-purpose probing does not limit you to specific hookup schemes.

General-purpose probing uses grabbers that connect to both through-hole and surface-mount components. General-purpose probing comes as the standard probing option. You will find a full description of its components and use later in this section.

### The Termination Adapter

The logic analyzer must be properly terminated to operate correctly. Most HP preprocessor interfaces have properly terminated state connectors; however, many of them require termination adapters for the timing connectors.

The optional termination adapter allows you to connect the logic analyzer probe cables directly to test ports on your target system without the probes.

The termination adapter is designed to connect to a 20-position (2x10), 4-wall, low-profile, header connector which is a 3M-Series 3592 or equivalent.

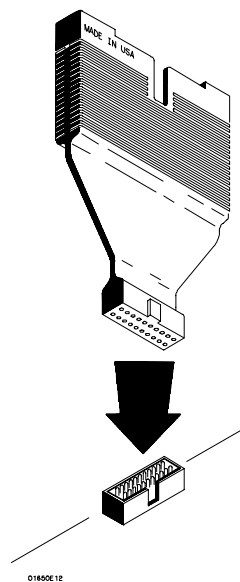

Termination adapter

---

## General-purpose probing system description

The standard probing system provided with the logic analyzer consists of a probe tip assembly, probe cable, and grabbers. Because of the passive design of the probes, there are no active circuits at the outer end of the cable. The rest of this chapter is dedicated to general-purpose probing.

The passive probing system is similar to the probing system used with high-frequency oscilloscopes. It consists of a series RC network (90 k $\Omega$  in parallel with 8 pF) at the probe tip, and a shielded, resistive transmission line. The advantages of this system include the following:

- 250  $\Omega$  in series with 8-pF input capacitance at the probe tip for minimal loading
- Signal ground at the probe tip for high-speed timing signals
- Inexpensive, removable probe tip assemblies

### Probe Tip Assemblies

Probe tip assemblies allow you to connect the logic analyzer directly to the target system. This general-purpose probing is useful for discrete digital circuits. Each probe tip assembly contains 16 probe leads (data channels), 1 clock lead, a pod ground lead, and a ground tap for each of the 16 probe leads.

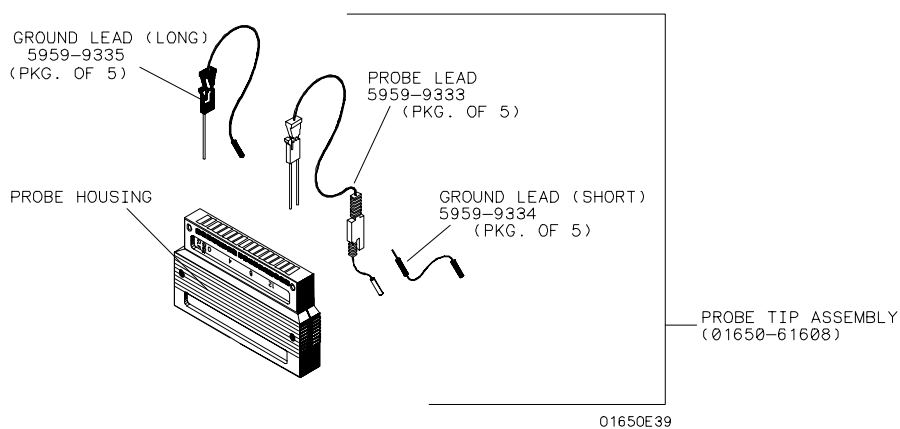

### Probe tip assembly

### Probe and Pod Grounding

Each pod is grounded by a long, black, pod ground lead. You can connect the ground lead directly to a ground pin on your target system or use a grabber. To connect the ground lead to grounded pins on your target system, you must use 0.63-mm (0.025-in) square pins, or use round pins with a diameter of 0.66 mm (0.026 in) to 0.84 mm (0.033 in). The pod ground lead must always be used.

Each probe can be individually grounded with a short black extension lead that connects to the probe tip socket. You can then use a grabber or the grounded pins on your target system in the same way you connect the data lines. For extra confidence in your measurements, grounding every third or fourth probe is recommended.

When probing signals with rise and fall times of 1 ns or less, grounding each probe lead with the 2-inch ground lead is recommended. In addition, always use the probe ground on a clock probe.

### Probe Leads

The probe leads consists of one 12-inch twisted-pair cable, one ground tap, and one grabber. The probe lead, which connects to the target system, has an integrated RC network with an input impedance of 100 k $\Omega$  in parallel with approximately 8 pF, and all in series with 250  $\Omega$ . The probe lead has a two-pin connector on one end that snaps into the probe housing.

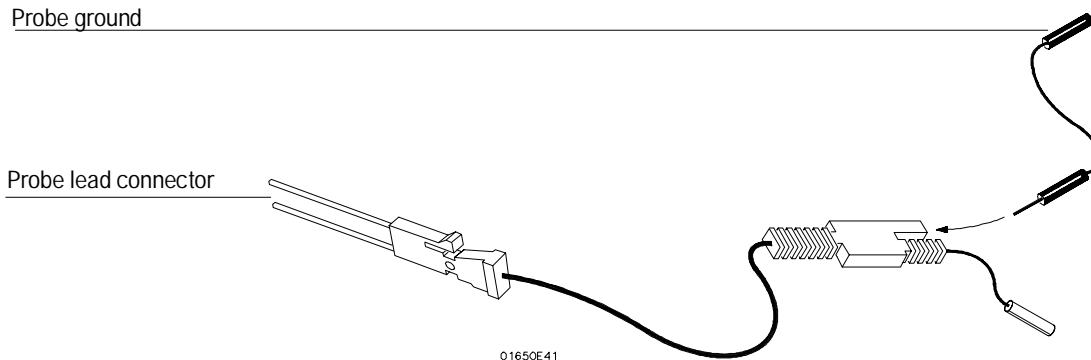

### Probe ground lead

### Grabbers

The grabbers have a small hook that fits around the IC pins and component leads. The grabbers have been designed to fit on adjacent IC pins on either through-hole or surface-mount components with lead spacing greater than or equal to 0.050 inches.

### Probe Cable

The probe cable contains 18 signal lines, 17 chassis ground lines and two power lines for preprocessor use. The cables are woven together into a flat ribbon that is 4.5 feet long. The probe cable connects the logic analyzer to the pods, termination adapter, or preprocessor. Each cable is capable of carrying 0.33 amps for preprocessor power.

---

**CAUTION**

DO NOT exceed 0.33 amps per cable, or the cable will be damaged.

Preprocessor power is protected by a current limiting circuit. If the current limiting circuit is activated, the fault condition must be removed. After the fault condition is removed, the circuit will reset in one minute.

### Minimum Signal Amplitude

Any signal line you intend to probe with the logic analyzer probes must supply a minimum voltage swing of 500 mV to the probe tip. If you measure signal lines with a voltage swing of less than 500 mV, you may not obtain a reliable measurement. Because the minimum input overdrive is the greater of 250 mV or 30% of input amplitude, be sure to correctly set the pod threshold in the Analyzer Format menu.

### Pod Thresholds

Logic analyzer pods have two preset thresholds and a user-definable pod threshold. The two preset thresholds are ECL (-1.3 V) and TTL (+1.5 V). The user-definable threshold can be set anywhere between -6.0 volts and +6.0 volts in 0.05 volt increments.

All pod thresholds are set independently.



---

## Oscilloscope probes

The two oscilloscope probes supplied with the logic analyzer are HP 10430A Miniature Passive Probes. These small, lightweight probes allow measurements that were previously very difficult in densely populated circuits.

For complete information on the operation, maintenance, and adjustments of the miniature passive probes, be sure to read the operating note that is packaged with the probes.

### Probe Inputs

Probe inputs are located on the front panel to the right of the line switch. Input 1 is on the left. The probes may be connected directly to the BNC input connectors. The signal is dc-coupled to the oscilloscope.

BNC cables can be connected directly to the BNC connectors. A BNC-to-BNC cable is not provided with the instrument, but you can order it separately.

### Maximum Probe Input Voltage



The maximum input voltage of each logic analyzer probe is  $\pm 40$  volts peak. The maximum input voltage of the oscilloscope is  $\pm 250$  volts dc at  $1M\Omega$  setting and  $\pm 5$  volts rms at  $50\Omega$  setting.

### Calibration Outputs

There are two calibration output BNCs located on the rear panel. One is the dc calibration signal source and the other is the ac calibration signal source. Both of these signals are used during calibration of the oscilloscope. The dc calibration signal can also be used for probe compensation adjustment (see your operating note).

---

## Assembling the probing system

The general-purpose probing system components are assembled as shown to make a connection between the measured signal line and the pods displayed in the Analyzer Format menu.

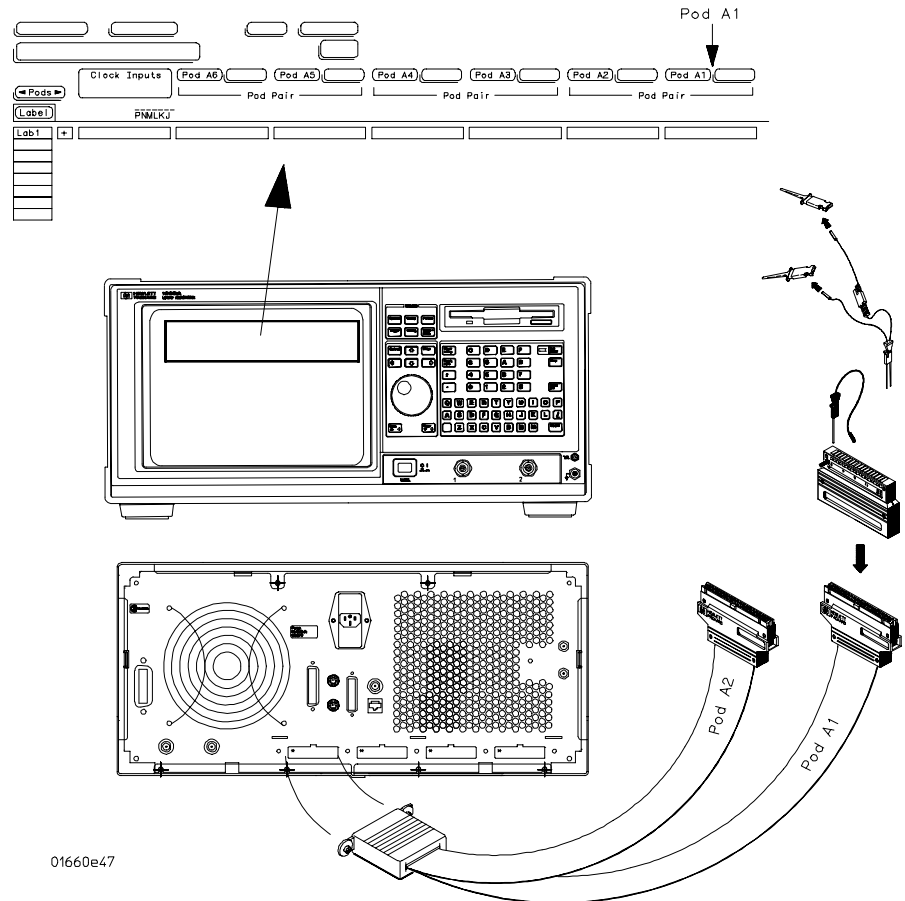

### Connecting probe cables to the logic analyzer

### Connecting Probe Cables to the Logic Analyzer

All probe cables are installed at Hewlett-Packard. If you need to replace a probe cable, refer to the *HP 1660CS/CS-Series Logic Analyzers Service Guide*, available from your HP sales office.

### Connecting the Probe Tip Assembly to the Probe Cable

To connect a probe tip assembly to a cable, align the key on the cable connector with the slot on the probe housing and press them together.

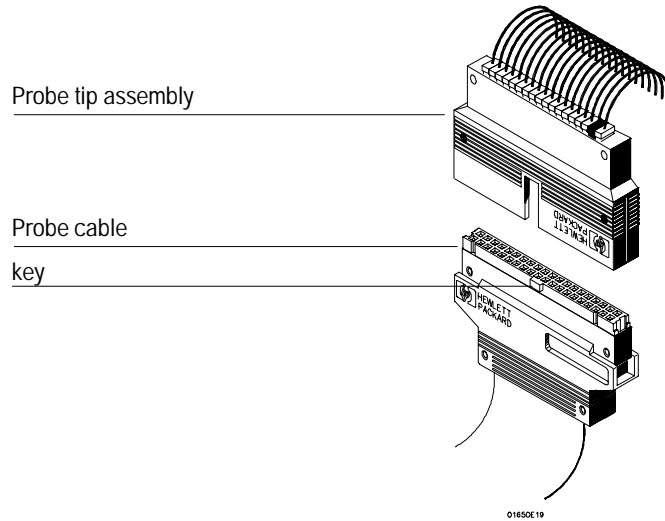

Connecting probe tip assembly

### Disconnecting Probe Leads from Probe Tip Assemblies

When you receive the logic analyzer, the probe leads are already installed in the probe tip assemblies. To keep unused probe leads out of your way during a measurement, you can disconnect them from the pod.

To disconnect a probe lead, insert the tip of a ballpoint pen into the latch opening. Push on the latch while gently pulling the probe out of the pod connector as shown in the figure.

To connect the probes into the pods, insert the double pin end of the probe into the probe housing. Both the double pin end of the probe and the probe housing are keyed so they will fit together only one way.

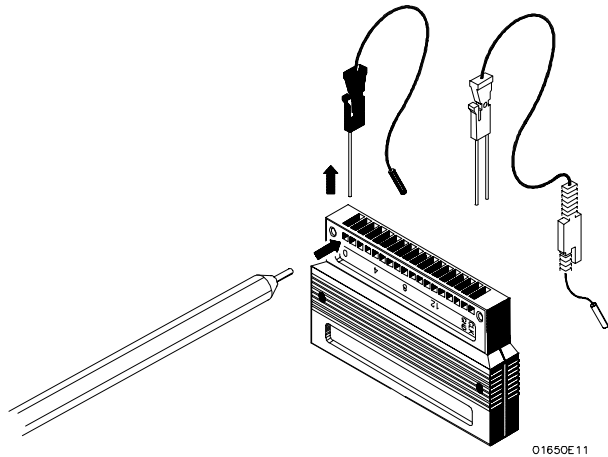

Installing probe leads

### Connecting the Grabbers to the Probes

Connect the grabbers to the probe leads by slipping the connector at the end of the probe onto the recessed pin located in the side of the grabber. If you need to use grabbers for either the pod or the probe grounds, connect the grabbers to the ground leads in the same manner.

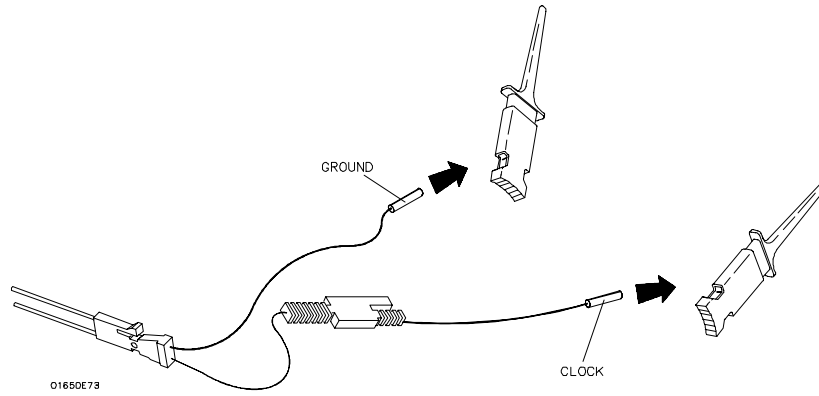

### Connecting grabbers to probes

---

# Keyboard Shortcuts

This section explains how to use the optional keyboard interface (HP E2427B Keyboard Kit). You can use the keyboard interchangeably with the knob and front-panel keypad for all menu applications. The keyboard functions fall into the two basic categories of cursor movement and data entry.

---

## Moving the cursor

The keyboard cursor is the location on the screen highlighted in inverse video. Move the cursor using one of the methods described below.

### **Keyboard cursor movement**

The four cursor keys marked with arrows on the keyboard act as follows:

- Up-pointing arrow moves the cursor up.
- Down-pointing arrow moves the cursor down.
- Right-pointing arrow moves the cursor to the right.
- Left-pointing arrow moves the cursor to the left.

The cursor keys do not wrap. This means that pressing the right-pointing arrow when the cursor is already at the rightmost point in a menu will have no effect. The cursor keys do repeat, so holding the key down is the fastest way to continue keyboard cursor movement in a given direction.

**Page Up and Page Down keys** The Page Up and Page Down keys page through listings. The Page Up key displays the previous page of data. The Page Down key displays the next page of data.

**Duplicating front panel knob** Shift-up arrow and shift-down arrow act like the front panel knob, and are easier to use than the mouse for small movement.

### **Selecting a menu item**

To select a menu item with the keyboard, position the cursor (highlighted in inverse video) on the menu item and press the Return or Enter key.

---

## Entering data into a menu

### Keyboard data entry

When an assignment field is selected, the cursor is displayed under the leftmost character in the field. When you type a character, it is displayed in the cursor position, and the cursor is advanced. Cursor keys move the cursor within the assignment field. Pressing either the Return key or the Enter key will terminate data entry for that item.

---

## Using the keyboard overlays

A keyboard overlay is included in the HP E2427B Keyboard Kit. The table below represents the key mappings.

Key	Functions Like	Key	Functions Like
F1	System Key	S	Select "seconds"
F2	Config Key	M	Select "milliseconds" or "millivolts"
F3	Format Key	U	Select "microseconds"
F4	Trigger Key	N	Select "nanoseconds"
F5	Listing Key	V	Select "volts"
F6	Waveform Key	B	Select "any (both) edge"
F7	Print All Key	R	Select "rising edge"
F8	Run Rep. Key	F	Select "falling edge"
F9	Stop	*	Assign glitch
F10	Done	.	Assign Don't Care (X)
F12	Assign Don't Care (X)		

---

## Common Menu Fields

There are a number of fields that appear throughout the different menus that have similar operation. These common fields are listed below:

- Mode (System/Analyzer/Scope) field
- Menu field
- Print field
- Run field
- Base field
- Label field
- Roll fields

Because most of these fields are self-explanatory, only the fields with less obvious features are described here.



---

## Print field

The Print field prints what is displayed on the screen at the time you initiate the printout. When you select the Print field, a print selection pop-up appears showing you one or more of the following options:

- Print Screen
- Print Disk
- Print All
- Print Partial
- Cancel

While printing, the Print field changes to Cancel and the user interface is not active except for Cancel. When the printout is complete, the user interface becomes active again. The Print field is not available with pop-up menus. The only way to print a pop-up menu to disk is with a controller.

### Print Screen

The Print Screen option sends the screen immediately to the specified printer. The option does not create a file; to do that, use Print Disk.

### Print Disk

The Print Disk option copies the screen in graphical form or ASCII, if available, to a file on either drive. Possible output formats are

- ASCII            8-bit standard ASCII text file
- B/W TIF        Black-and-white image in TIFF version 5.0 format
- GRAY TIF      Grayscale image in TIFF version 5.0 format
- PCX            Grayscale image in standard PCX format
- EPS            Line image in standard encapsulated PostScript format

## **Run/Stop field**

### **Print All**

The Print All option prints not only what is displayed on the screen, but data that is below the screen. This option is only available when an ASCII form of the screen is possible. For example, Print All is never available in Waveform.

When you select Print All with a Listing menu, make sure the first line you wish to print is in the state location box (data row field) at the center of the listing area. Lines above this box will not print.

### **Print Partial**

The Print Partial option is identical to the Print All option, except the start and end states are specified. The screen settings and specified data are printed in ASCII form.

---

## **Run/Stop field**

The Run field starts the analyzer measurement. When you select Run, the screen switches to the display menu last viewed and displays the acquired data. If Stop is selected during a single run, the data acquisition is aborted. If Stop is selected during a repetitive run, the current run cycle is completed before data is displayed.

### **Repetitive**

The Repetitive option runs the data acquisition cycle repeatedly until you select Stop or until a pre-assigned stop measurement condition is met. The stop measurement condition is set in the Analyzer Listing or Analyzer Waveform menus when pattern markers are turned on.

## Roll fields

Some data may not fit on screen when there are many pods or labels to display. When this happens, it is indicated by the Label/Base field becoming selectable and its color changing to the common field color. To move through the hidden data, select the field, wait for the roll indicator to appear, and then use the knob to move through the data. The figure below shows an active roll field.

If there is more than one rollable field, the roll indicator remains with the last rollable field activated. For example, the Listing menu shown below has both the Label/Base field and the state location field, which are both rollable. However, the only field affected when turning the knob is the field with the roll indicator.

Another way to move through data is the Page keys. The Page keys are independent of the knob rolling function and move through data without changing which labels or pods are displayed. Page keys page data up or down one screen at a time. To move data left or right one screen at a time, press the blue Shift key and then a page key.

Roll indicator

The screenshot shows an analyzer interface with a menu titled "Listing 80960CA TH". At the top, there are buttons for "Analyzer", "Listing 80960CA TH", "Cancel", and "Run". Below these are "Markers Time" and three trigger settings: "Trig to X -20 ns", "Trig to 0 8 ns", and "X to 0 28 ns". The main display is a table with columns: "Label", "Base", "ADDR", "DATA", "CYCLE", "Time", and "D/C". The "Label" and "Base" columns are highlighted in blue, indicating they are rollable. A roll indicator (a small vertical bar) is positioned over the "Label" column of the row with index -4. The table contains the following data:

	Label	Base	ADDR	DATA	CYCLE	Time	D/C
			Hex	Hex	Symbol	Absolute	Symbol
-11			E00F8888	15114444	DATA READ	-44 ns	DATA
-10			E00F8888	15114444	DATA READ	-40 ns	DATA
-9			E00F8888	15114444	DATA READ	-36 ns	DATA
-8			E00F8888	15114444	DATA READ	-32 ns	DATA
-7			E00F8888	15114444	DATA READ	-28 ns	DATA
-6			E00F8888	15114444	DATA READ	-24 ns	DATA
-5			X E00F8888	15114444	DATA READ	-20 ns	DATA
-4			F00F8888	15114444	DATA READ	-16 ns	DATA
-3			B0000000	15114444	absolute	1E -12 ns	DATA
-2			B0000000	15114444	ADDRESS CYCLE	-8 ns	CODE
-1			B0000000	15114444	ADDRESS CYCLE	-4 ns	CODE
0			B0000000	15114444	ADDRESS CYCLE	0 ns	CODE
1			B0000000	15114444	ADDRESS CYCLE	4 ns	CODE
2			B0000000	15114444	ADDRESS CYCLE	8 ns	CODE
3			B0000000	15114444	ADDRESS CYCLE	12 ns	CODE
4			B0000000	15114444	ADDRESS CYCLE	16 ns	CODE

Label and base roll field

---

# Disk Drive Operations

The logic analyzer has a built-in 3.5-inch, double-sided, high-density or double-density, flexible disk drive. The disk drive is compatible with both LIF (Logical Interchange Format) and DOS (Disk Operating System) formats. It also has an internal hard disk drive, which performs the same operations as the flexible disk drive.

---

## Disk operations

Ten disk operations are available:

- Autoload

Designates a set of configuration files to be loaded automatically the next time the analyzer is turned on.

- Copy

Copies files. Any file can be copied from one drive to another, from one directory to another, or to different flexible disks.

- Duplicate Disk

Copies one flexible disk to another flexible disk. You cannot copy the hard disk to a flexible disk in a single operation. All volume labels, directories, and file positions from one disk are copied exactly to another disk. The new disk is formatted to match the source disk if it is required. All files on the destination disk will be destroyed with this operation.

- Format Disk

Formats a flexible disk or the internal hard disk. Either can be formatted in LIF or DOS format. All files on the disk will be destroyed with this operation.

- Load

Loads a file into the logic analyzer, overwriting the current settings or information. You can load system configurations, analyzer measurement setups including measurement data, and inverse assembler files.

- **Make Directory**

Creates a new directory on a DOS disk. You can save or copy files to the new directory using the store and copy commands. This is not available with LIF disks.

- **Pack Disk**

Removes all empty or unused sectors between files on a LIF disk so that more space is available. If you select Pack Disk while a DOS disk is in the drive, nothing happens.

- **Purge**

Purges (deletes) the file you indicate. Deleted files cannot be recovered.

- **Rename**

Changes the name of the file you select.

- **Store**

Saves system and analyzer measurement setups including data.

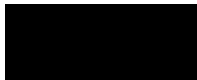

### **Disk operation safeguards**

If there is a problem or additional information is needed to execute an operation, a pop-up appears near the center of the screen displaying the status of the operation.

If executing a disk operation could destroy or damage a file, a pop-up appears when you select Execute. If you do not want to complete the operation, select Cancel to cancel the operation. Otherwise, select Continue.

## Autoload

The Autoload operation allows you to designate a set of configuration files to be loaded automatically the next time the analyzer is turned on. Autoload can change the default configuration of certain features to one that better fits your needs. If both the hard drive and flexible drive have autoload setups, only the setup on the flexible drive will be used.

Autoload loads all of the files for a given base filename. If you want to load only one type of file, rename that file or copy it to a separate name and enable it as the current Autoload file. As long as Autoload is enabled before the instrument is shut off, Autoload will remain enabled when you turn on the instrument and load the configuration files.

---

## Format

---

### CAUTION

---

**Executing Format Disk permanently erases all existing information from the disk. After formatting, there is no way to retrieve the original information.**

The logic analyzer recognizes a variety of sector sizes for LIF disks. However, it only creates 1024-byte sectors when formatting a LIF disk. DOS disks always have 512-byte sectors.

The logic analyzer does not support track sparing during formatting. If a bad track is found, the disk is considered bad. If a disk has been formatted elsewhere with track sparing, it will be read successfully.

When formatting a disk, the DISK ERROR message appears if the disk is unformatted. This is normal, and you can safely continue the format process.

---

## Pack

By purging files from the disk and adding other files, you may end up with blank areas on the disk (between files) that are too small for the new files you are creating. On LIF disks, the Pack Disk operation packs the current files together, removing unused areas from between the files so that more space is available for files at the end of the disk. On DOS disks, the Pack Disk operation is not available. If you do select Pack Disk while a DOS disk is in the drive, the disk is not affected.

---

## Load and Store

When you choose Load or Store, you next need to set the field immediately to the right. This field presents at least four choices: All, System, Analyzer, and Scope. If you have other software loaded, it might add to the list of choices.

### All

Choose All to store or load system, analyzer, and scope information. If you are storing, three files (one for the system, one for the analyzer, and one for the scope) are created. The system file ends in ".\_\_", the analyzer file in ".\_A", and the scope file in ".\_B".

### System

System files store system configurations. System information for the HP 1660CS-series consists of settings for printer, controller, RS-232-C, HP-IB, shade, and sound. LAN settings are not saved. System configuration files end in two underscores and have a file type of 16[6/7]x\_config.

### Analyzer

Analyzer configuration files store measurement setups, including data. If you are storing the current measurement and an inverse assembler is already loaded, when you reload the file you are now creating it will try to pull in the inverse assembler. Other attributes stored in analyzer configuration files include labels, trigger sequence, arming configuration, measurement data, markers, analyzer names, and pod assignments. Analyzer configuration files end in ".\_A" and have a file type of 166xan\_config.

### Scope

Oscilloscope configuration files store measurement setups, including data. Attributes stored in scope configuration files include labels, trigger sequence, arming configuration, measurement data, markers, and channel assignments. Oscilloscope configuration files end in ".\_B" and have a file type of 166Xsc\_config.

This section describes the controller and printer interfaces and their configurations found in the System External I/O menu. It defines the HP-IB interface and describes how to select a different HP-IB address. It also defines the RS-232-C interface and tells you how to select a baud rate, how to change the stop bits, how to set the parity and data bits, and how to change the protocol. The Centronics (parallel) interface (printer only) is also described.

### **Controller interface**

The logic analyzer is equipped with a standard RS-232-C interface and an HP-IB interface that allow you to connect to a controller. Either interface gives you remote access for running measurements, for uploading and downloading configurations and data, and connecting to printers. If you purchased the optional Ethernet LAN interface, it can also be used for controlling the logic analyzer.

### **Printer interface**

The logic analyzer can output its screen to various HP-IB, RS-232-C, and Centronics graphics printers. Configured menus as well as waveforms and other data can be printed for complete measurement documentation. Even with the optional Ethernet LAN interface installed, the analyzer cannot use a networked or shared printer.

### **See Also**

Chapter 2, "Connecting Peripherals" for more details on physically connecting equipment.

*HP 1660C/CS-Series Logic Analyzers Programmer's Guide* for more information on the controller interface.

The LAN User's Guide for more information on the optional LAN interface.



---

## The HP-IB interface

The Hewlett-Packard Interface Bus (HP-IB) is Hewlett-Packard's implementation of IEEE Standard 488-1978, "Standard Digital Interface for Programmable Instrumentation." HP-IB is a carefully defined interface that simplifies the integration of various instruments and computers into systems.

The HP-IB interface uses an addressing technique to ensure that each device on the bus (interconnected by HP-IB cables) receives only the data intended for it. To accomplish this, each device is set to a different address and this address is used to communicate with other devices on the bus. The HP-IB address is the only HP-IB interface setting configurable from the logic analyzer.

The HP-IB address can be set to 31 different HP-IB addresses, from 0 to 30. Simply choose a compatible address for your device and software. The default address for all HP-IB logic analyzers is 7. In the System External I/O menu, select HP-IB Settings and then set the Address field to your address.

---

## The RS-232-C interface

The RS-232-C interface is Hewlett-Packard's implementation of EIA Recommended Standard RS-232-C, "Interface Between Data Terminal Equipment and Data Communications Equipment Employing Serial Binary Data Interchange."

With this interface, data is sent one bit at a time and characters are not synchronized with preceding or subsequent data characters. Each character is sent as a complete entity independent of other events.

The paragraphs below describe the settings for RS-232-C. You can change these settings by going to the System External I/O menu and selecting RS232 Settings. Each field in the Settings pop-up menu presents a list of valid choices.

### **Baud rate**

The baud rate is the rate at which bits are transferred between the interface and the peripheral. The baud rate must be set to transmit and receive at the same rate as the peripheral.

### **Stop Bits**

Stop Bits are used to identify the end of a character. The number of Stop Bits must be the same for the controller as for the logic analyzer.

### **Parity**

The parity bit detects errors as incoming characters are received. If the parity bit does not match the expected value, the character was incorrectly received. The action taken when an error is detected depends on the interface and the device program configuration.

Parity is determined by the requirements of the system. The parity bit may be included or omitted from each character by enabling or disabling the parity function.

### **Data Bits**

Data Bits are the number of bits used to represent the binary code of a character. The HP 1660CS-series logic analyzers support 8-bit binary code.

### **Protocol**

Protocol governs the flow of data between the instrument and the external device. It can be controlled either by the hardware, in which case you select None in the RS-232-C Settings pop-up, or by the software, in which case you select Xon/Xoff. Xon/Xoff stands for Transmit On/Transmit Off.

With less than a 5-wire interface, selecting None does not allow the sending or receiving device to control how fast the data is being sent, increasing the possibility of missing data. With a full 5-wire interface, selecting None allows a hardware handshake to occur. With a hardware handshake, hardware signals control data flow. The HP 13242G cable allows the logic analyzer to support hardware handshake.

---

## **The Centronics interface**

The Centronics interface is an industry-standard parallel printer interface. It can only be used as a printer interface, and is not available to the controller. There are no Centronics-specific settings; page and line length are set in the Printer Settings menu.

### **See Also**

Chapter 2, "Connecting Peripherals," for more information on setting up the parallel printer port.

---

## System Utilities

The System Utilities menu is used for setting system level parameters such as the system clock, display intensity for each shade, and the sound. From this menu you can also rewrite the analyzer's memory with any new revisions of the operating system.

---

### Real Time Clock Adjustments field

A real-time clock is displayed in the Waveform and Listing menus. When you print a screen, the current clock and date appear on the hard copy. To change the clock, go to the System Utilities menu and select Real Time Clock Adjustments. Set the values to the desired date and time. Default Time sets the real time clock to January 1, 1992 at 12 noon.

If your logic analyzer has the optional LAN interface, you will also see a Time Zone field. The Time Zone field changes the logic analyzer's apparent file times when viewed over NFS. It does not affect the real-time clock. Set the Time Zone to the same Time Zone used by your LAN. This value is usually the same as the difference in hours between your local time and Greenwich Mean Time.

---

### Update FLASH ROM field

The logic analyzer uses flash ROMs to store the operating system. The analyzer you received should have an operating system in place and should also include the operating system files on a flexible disk, but you may occasionally need to update the operating system. Selecting Update FLASH ROM updates the analyzer's operating system.

---

**CAUTION**

---

Updating flash ROM without the proper files will damage the logic analyzer operating system.

- 1** Go to the System Utilities menu.
- 2** Insert the flexible disk containing the operating system files into the disk drive.

**3 Select Update FLASH ROM.**

The analyzer warns, "Selecting Continue Will Erase & Update Flash ROMs." and waits for you to select Cancel or Continue. If you select Continue, the analyzer will be reset. If you need to save the measurement data, select Cancel.

**4 Select Continue.**

The screen goes black and the analyzer performs its power-up self tests. It then displays a message listing the required files and provides further instructions.

**5 Insert the update disk into the flexible disk drive.**

**6 To search only the flexible disk drive, press the Done key. To search the flexible disk drive and then the hard drive, press any other key.**

If you press a key other than Done, the logic analyzer will not pause for you to insert the second disk when it finishes copying files on the first disk. Instead, it will look on the hard drive under the /SYSTEM directory. If it finds copies of the operating system files on the hard drive, those are used instead. This could result in incorrect installation of the updated operating system.

The logic analyzer warns, "We are about to erase flash ROM memory." This is the last point at which you can cancel the operation. Any loss of power between the time the analyzer starts to erase flash ROM and the time it finishes copying the update will destroy the operating system.

---

**CAUTION**

---

If you do not have the required files turn off the analyzer immediately. Pressing any key will destroy the operating system.

**7 If you are sure you are ready to continue, press any key.**

**8 When the analyzer has completed the update, press any key.**

The screen goes black and the analyzer reboots. You have finished updating the flash ROM and the new operating system is in place. It is now safe to turn off the logic analyzer.

---

## Shade adjustments

You can adjust the greys of the display to different levels of intensity. Select the shade number, then select luminosity and adjust it with the knob. Default Shades restores all shade intensity levels to the original factory settings.

---

# The Analyzer Configuration Menu

---

## Type field

The Type field allows you to configure the analyzer with either an internal clock (Timing mode) or an external clock (State and SPA). When the Type field is selected, the following choices are available.

**Timing** When Timing is selected, the analyzer uses its own internal clock to clock measurement data into the acquisition memory. This clock is asynchronous to the signals in the target system. Fields relating to external clocks such as the Analyzer Format menu's Master Clock do not appear and certain menus such as Compare are not available.

The analyzer can only be configured with one timing analyzer. If two are selected, the first will be turned off.

**State** When State is selected, the analyzer uses a clock from the system under test to clock measurement data into acquisition memory. This clock is synchronous to the signals in the target system.

**SPA** SPA stands for System Performance Analysis. It uses an external clock like a state analyzer but measures overall system performance rather than recording an activity trace. For more details on SPA, see Chapter 8.

---

## Illegal configuration

When both analyzers are turned on, the first pod pair 1,2 and the last pod pair (5,6 in the 96-channel model or 7,8 in the 128-channel model) cannot be assigned to the same analyzer machine. If this configuration is set, the analyzer will display a re-assignment menu when you try to leave the configuration screen. Use this re-assignment menu to configure the pod assignment automatically to a legal configuration.

---

# The Analyzer Format Menu

---

## Pod threshold field

The pod threshold field is used to set a voltage level that the data must reach before the analyzer recognizes and displays it as a change in logic levels. Threshold levels apply to single pods, and cover both data and clock channels.

**TTL** When TTL is selected as the threshold level, the data signals must reach +1.5 volts.

**ECL** When ECL is selected as the threshold level, the data signals must reach -1.3 volts.

**User** When User is selected as the threshold level, the data signals must reach a user selectable value. The range of this value is between -6.0 volts to +6.0 volts in 50 mV increments.

---

## State. acquisition modes (state only)

The State Acquisition Mode field identifies the channel width and memory depth of the selected acquisition mode. There are two configurations of channel width/memory depth.

**Full Channel/4K Memory/100 MHz** Full-channel mode uses both pods in a pod pair for 34 channels of width and a total memory depth of 4 K per channel. If time or state tags are turned on, the total memory is evenly split between data acquisition storage and time or state tag storage. To maintain the full 4 K per channel depth with state or time tags, leave one pod pair unassigned.

**Half Channel/8K Memory/100 MHz** Half-channel mode cuts the channel width to 17 channels. In this mode, the pod used within the pod pair is selected through the Pod field. In half-channel mode, the memory depth is increased to 8 K per channel. Time or state tags are not available in this mode.

## Timing acquisition modes (timing only)

The Timing Acquisition mode field identifies the acquisition type, the channel width, and sampling speed of the present acquisition mode. There are three acquisition modes, and a total of five configurations.

### Conventional Acquisition Mode

In Conventional Acquisition mode, the analyzer stores measurement data at each sampling interval.

**Conventional full-channel 250 MHz** The total memory depth is 4 K with data being sampled and stored as often as every 4 ns.

**Conventional half-channel 500 MHz** The total memory depth is 8 K with data being sampled and stored as often as every 2 ns.

### Transitional Acquisition Mode

In Transitional Acquisition mode the timing analyzer samples data at regular intervals, but it only stores the data when it detects a transition on some channel. Both transitional modes store time tags for each stored data sample.

**Transitional full-channel 125 MHz** The total memory depth is 4 K per channel with 34 channels per pod pair. Data is sampled for new transitions as often as every 8 ns.

**Transitional half-channel 250 MHz** The total memory depth is 8 K with 17 channels on one pod. The pod used within the pod pair is selectable. Data is sampled for new transitions as often as every 4 ns.

### Glitch Acquisition Mode

A glitch is defined as a pulse with a minimum width of 3.5 ns and a maximum width of the sample period. In Glitch Acquisition mode the timing analyzer samples data at regular intervals as it does in Conventional Acquisition mode, but it also looks for a rising and a falling edge occurring between samples. Every sample is stored. When an edge pair is detected in the sample period a vertical dashed line is displayed.

**Glitch half-channel 125 MHz** In Glitch mode, the total memory depth is split between data storage and glitch storage. Data acquisition memory depth is 2 K per channel. Glitch storage is 2 K per channel. Data is sampled for new transitions every 8 ns, or with every sample period if it is larger.

## Clock Inputs display

Beneath the Clock Inputs display, and next to the activity indicators, is a group of all clock inputs available in the present configuration. The number of available clocks depends on the model. The J and K clocks appear with pod pair 1/2, the L and M with pod pair 3/4, and N and P with pod pairs 7/8 for the HP 1660 and 5/6 for the HP 1661. In a model with more than three pod pairs, all other clock lines are displayed to the left of the displayed master clocks, and are used as only data channels.

With the exception of the Range resource, all unused clock bits can be used as data channels in the trigger terms. Activity indicators above the clock identifier show clock or data signal activity.

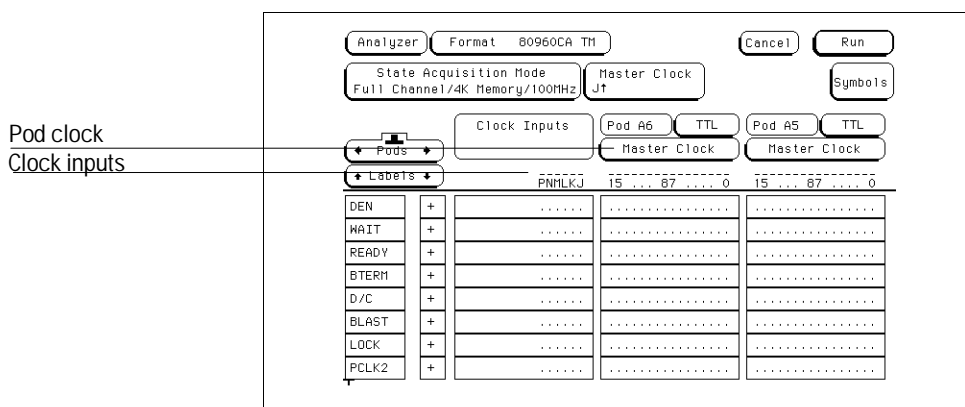

### Pod clocks

## Pod clock field (State only)

The pod clock field identifies the type of clock arrangement assigned to each pod. When the pod clock field is selected, a clock arrangement menu appears with the choices of Master, Slave, or Demultiplex. Once a pod clock is assigned a clock arrangement, its identity and function follows what is configured in the Master and Slave Clock fields.



**Master**

This option specifies that data on all pods designated "Master Clock," in the same analyzer, are strobed into memory when the status of the clock lines match the clocking arrangement specified under the Master Clock.

**See Also**

"Master and Slave Clock fields" found later in this section for information about configuring a clocking arrangement.

**Slave**

This option specifies that data on a pod designated "Slave Clock" is latched when the status of the slave clock meets the requirements of the slave clocking arrangement. Then, followed by a match of the master clock and the master clock arrangement, the slave data is strobed into analyzer memory along with the master data. See the figure below.

If multiple slave clocks occur between master clocks, only the data latched by the last slave clock prior to the master clock is strobed into analyzer memory.

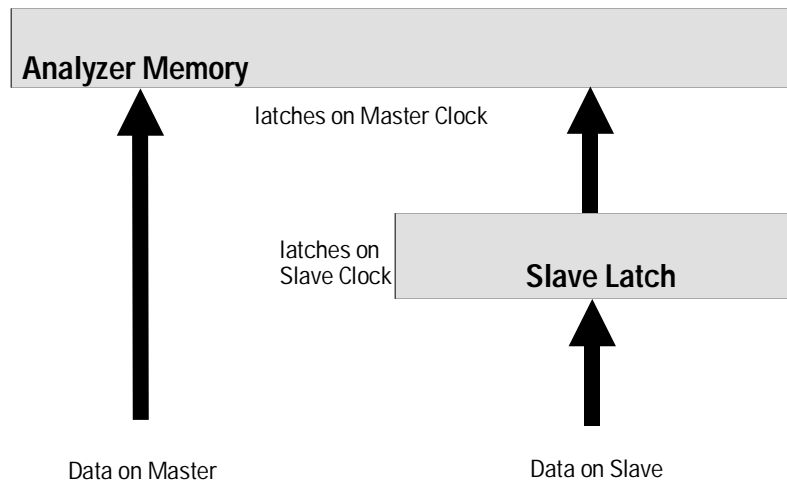
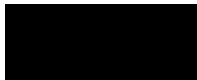

**Latching slave data**

**Demultiplex**

The Demultiplex mode is used to store two different sets of data that occur at different times on the same channels. In Demultiplex mode both the master and slave clocks are used, but only one pod of the pod pair is sampled.

The Analyzer Format Menu  
**Pod clock field (State only)**

Channel assignments are displayed as Demux Master and Demux Slave. For easy recognition of the two sets of data, assign slave and master data to separate labels.

When the analyzer sees a match between the slave clock input and the Slave Clock arrangement, Demux Slave data is latched. Then, followed by a match of the master clock and the master clock arrangement, the slave data is strobed into analyzer memory along with the master data. If multiple slave clocks occur between master clocks, only the most recently latched data is strobed into analyzer memory.

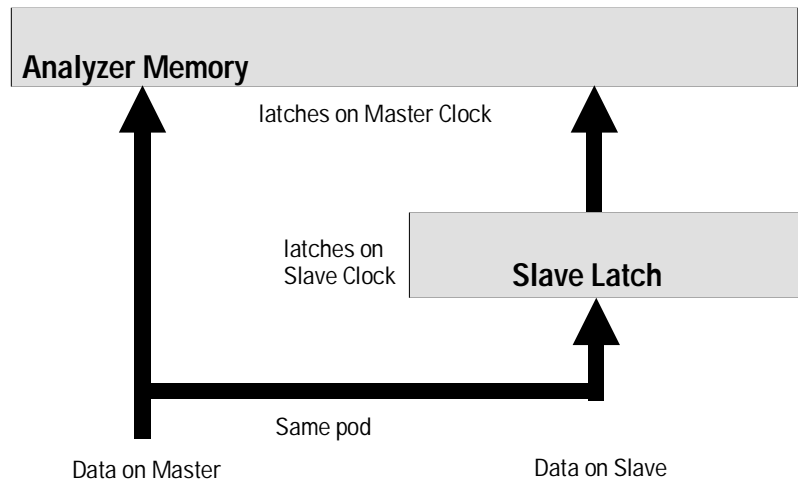

**Latching slave data in demultiplex mode**

## Master and Slave Clock fields (State only)

The Master and Slave Clock fields are used to construct a clocking arrangement. A clocking arrangement is the assignment of appropriate clocks, clock edges, and clock qualifier levels which allow the analyzer to synchronize itself on valid data.

### Clock selections

When the Master or Slave Clock field is selected, a clock/qualifier selection menu appears showing the available clocks and qualifiers for a clocking arrangement. Depending on the model, there are up to six clocks available (J through P), and up to four clock qualifiers available (Q1 through Q4).

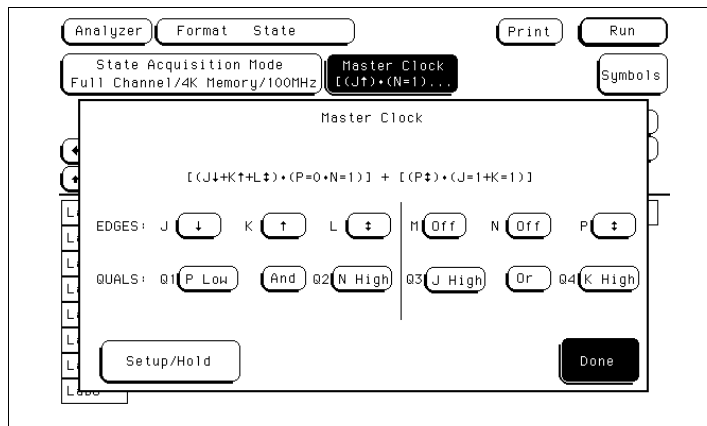

Clock/qualifier selection menu

The Analyzer Format Menu  
**Master and Slave Clock fields (State only)**

Clock edges are ORed to clock edges, clock qualifiers are ANDED to clock edges, and clock qualifiers can be either ANDED or ORed together. All clock and qualifier combinations on the left side of the graphic line are ORed to all combinations on the right side of the line. For example, in a six-clock model, all combinations of the J, K, and L clock with Q1 and Q2 qualifiers, are ORed to the clock combinations of the M, N, and P clocks with Q3 and Q4 qualifiers.

**See Also**

"Pod Clock Field" found earlier in this chapter for information on selecting clocking arrangement types, such as Master, Slave, or Demultiplex.

The screenshot shows the Analyzer Format Menu for a 66360 esyn device. It includes buttons for Analyzer, Format, Print, and Run. The Master Clock field is set to [(J+)+N=0] and the Slave Clock field is set to J+M. The Pod clock field is set to Pod A5. The Clock Inputs section shows Pod A5, TTL, and Demux Master/Demux Slave options. A table below shows the configuration for ADDR, DATA, HE, N\_shw2, STAT, FC, SIZ, and DSACK fields.

		↓...↓ NHLKJ	-----***** 15 ... 87 ... 0	-----***** 15 ... 87 ... 0
ADDR	+	.....	.....*****	*****
DATA	+	.....	.....*****	*****
HE	+	.....	****.....	.....
N_shw2	+	*.....	.....	.....
STAT	+	.....	.....	.....
FC	+	.....	.....	.....
SIZ	+	.....	.....	.....
DSACK	+	.....	.....	.....

**Clock fields**

**Setup/Hold field**

Setup/Hold, in the Master and Slave clock fields, adjusts the relative position of the clock edge with respect to the time period that data is valid. When the Setup/Hold field is selected, a configuration menu appears. Use this Setup/Hold configuration menu to select each pod in the analyzer and assign a Setup/Hold selection from the selection list.

With a single clock edge assigned, the choices range from 3.5-ns Setup/0.0-ns Hold to 0.0-ns Setup/3.5-ns Hold. With both edges of a single clock assigned, the choices are from 4.0-ns Setup/0.0-ns Hold to 0.0-ns Setup/4.0-ns Hold. If the analyzer has multiple clock edges assigned, the choices range from 4.5-ns Setup/0.0-ns Hold to 0.0-ns Setup/4.5-ns Hold.

The relationship of the clock signal and valid data under the default setup and hold is shown in the upper figure. If the relationship of the clock signal and valid data is such that the data is valid for 1 ns before the clock occurs and 3 ns after the clock occurs, you will want to use the 1.0 setup and 2.5 hold setting as shown in the lower figure.

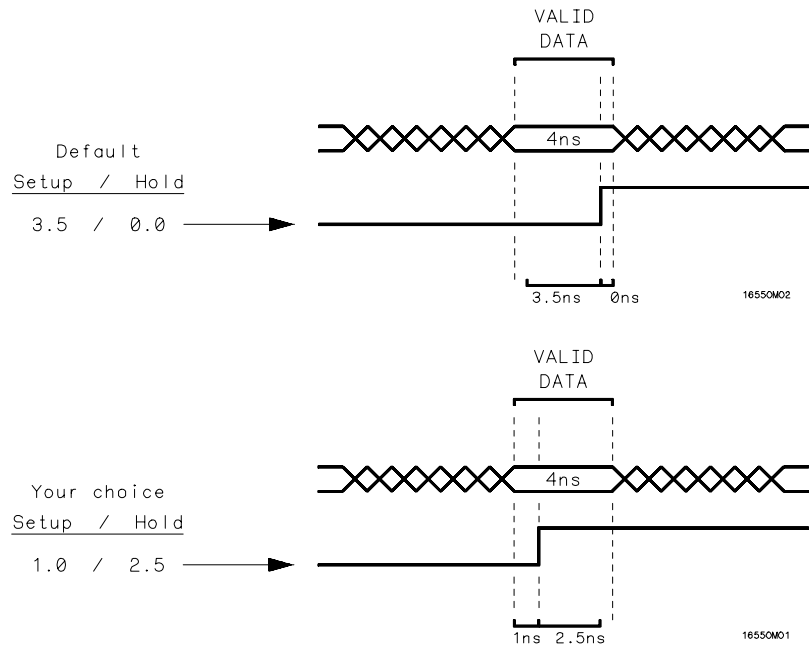

**Clock position in valid data**

---

## Symbols field

The Symbols field is located directly below the Run field in the upper right corner of the Format menu. Use this field to access the symbol tables.

Use symbol tables to define a mnemonic for a specific bit pattern of a label. You can specify up to 1000 total symbols, and use them freely between available analyzers. When measurements are made, the mnemonic is displayed where the bit pattern occurs using the selected symbol base. You can also download compiled symbol tables using HP E2450A Symbol Utility, which is supplied with the logic analyzer.

### See Also

*HP E2450A Symbol Utility User's Guide* for more information on downloading symbols

### Label field

The Label field identifies the label for which you are specifying symbols. When you select this field, a selection menu appears that lists all the labels turned on for that analyzer. Each label has a separate symbol table, so you can give the same name to symbols defined under different labels.

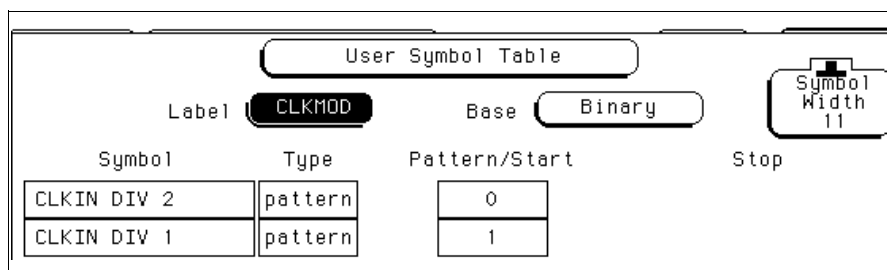

### Symbol pop-up menu

### Base field

Use the Base field to select the numeric base in which the pattern in the symbols menu is displayed. Binary is not available if more than 20 channels are assigned to a label because there is only enough room for 20 bits to be displayed on the screen.

You cannot specify a pattern or range when the base is ASCII. Define the pattern or range in one of the other bases, then switch to ASCII to see the ASCII characters.

### **Symbol Width field**

The Symbol Width field specifies how many characters of the symbol name will be displayed when the symbol is referenced in the Trigger, Waveform, and Listing menus. You can display from 1 to 16 characters of the symbol name.

### **Symbol name field**

When you first access the symbol table, there are no symbols specified. The symbol name field reads "New symbol." Select this field to enter a symbol name. When you are done, a symbol Type field becomes active.

### **Type field**

The symbol Type field toggles between pattern and range. When the symbol is defined as a pattern, a Pattern/Start field appears to the right of the Type field. To assign a pattern, select the Pattern/Start field and type in the desired pattern.

If the symbol is defined as a range, a Pattern/Start field and a Stop field appear. Use these fields to specify the upper and lower boundaries of the range. To assign values to the boundaries, select the fields and enter the pattern. You can specify ranges that overlap or are nested within each other.

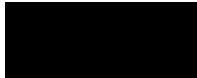

---

## **Label fields**

The label fields are the fields with label names along the left side of the display below the field captioned Labels. The default label names are Lab1 through Lab126. Selecting the label fields pops up a choice of Turn Label On, Turn Label Off, and Modify Label.

The Turn Label Off option turns off the label. When a label is turned off, the label name and the bit assignments are saved by the logic analyzer so that you can turn the label back on and not have to retype the bit assignments and name. With labels off, the label names remain displayed for identification and searching purposes. Turning labels off may save memory in transitional timing.

Labels may have from 1 to 32 channels assigned to them. If you try to assign more than 32 channels to a label, the logic analyzer will beep, indicating an error. A message will appear at the top of the screen telling you that 32 channels per label is the maximum.

**Label polarity fields**

Channels assigned to a label are numbered from right to left by the logic analyzer. The least significant assigned channel on the far right is numbered 0, the next assigned channel is numbered 1, and all other channels assigned sequentially up to the maximum of 16 per pod. Since 32 channels can be assigned to one label at most, the highest number that can be given to a channel is 31.

Although labels can contain split fields, assigned channels are always numbered consecutively within a label.

---

**Label polarity fields**

The label polarity fields, which are located just after the label, are used to assign a polarity to each label. The default polarity for all labels is positive (+). You change the label polarity by toggling the polarity field.

When the polarity is positive, 1 is high and 0 is low. When the polarity is negative, 1 is low and 0 is high. All data as well as bit-pattern specific configurations used for identifying, triggering, or storing data reflect the change of polarity. Numbers use the appropriate logical encoding, but waveforms and edges are still shown as logic levels – either low or high. In a timing analyzer with the data inverted, the waveform display remains positive true.

As an example, setting the logic analyzer to trigger on 0A hex with positive polarity is the same as setting it to trigger on F5 hex with negative polarity. The listing would show 0A with + polarity, F5 with - polarity. In the waveform menu, if the waveform is defined as bus the waveform shown as symbols inverts with a change of polarity. If the waveform is defined as individual channels or is not using symbols, it is not affected by changing polarity.



---

# The Analyzer Trigger Menu

---

## Trigger sequence levels

Sequence levels are the definable stages of the total trigger specification. Individual sequence levels are assigned using either a pre-defined trigger macro or a user-level trigger macro. The total trigger specification can contain both kinds of macro.

### See Also

Chapter 4, "Using the Trigger Menu," for more on setting up a trigger.

### Sequence level usage

Generally, you would think using one macro in one sequence level uses up one of the available sequence levels. This may not always be the case. Some of the more complex pre-defined macros require multiple sequence levels. Keep this point in mind if you are near the limit on remaining sequence levels. The exact number of internal levels required per macro, and the remaining available levels, are shown within the macro library list. User macros, however, use only one level almost all the time. The only instance where multiple levels are used with the User macro is when the "<" duration is assigned.

---

## Modify trigger field

The Modify Trigger field allows you to modify the statements of any single sequence level as well as other high-level actions like global clearing of existing trigger statements, and adding or deleting sequence levels. Break Down Macros/Restore Macros acts a bit differently than the others.

### Break Down Macros / Restore Macros

When a pre-defined macro is broken down, the contents of that macro are displayed in the same long form used in the User macro. If the macro uses multiple internal levels, all levels are separated out and displayed in the sequence levels of the Trigger menu. Once the macros in your trigger specification are broken down, Break Down Macros changes to Restore Macros. Use Restore Macros to restore all macros to their original structure.

When the macro is in a broken-down form, you can change the structure. However, when the macros are restored, all changes are lost and any branching that is part of the original structure is restored.

Use Break Down Macros if you want to view a particular macro part in its long form to see the exact sequence flow. Breaking down macros can also help in creating a custom trigger specification.

When a macro is broken down, you have all the assignment fields and branching options available as though they were a set of User macros. For information on the assignment fields, branching, occurrence counters, and time duration function, refer to the Chapter 4 on the mechanics of creating a trigger level.

---

## Timing trigger macro library

The following list contains all the macros in the library of timing trigger macros. They are listed in the same order as they appear onscreen.

### User Mode

#### **User level - custom combinations, loops**

The User level is a user-definable level. This level offers low-level configuration and uses one internal sequence level. If the "<" duration is used, four levels are required.

### Basic Macros

#### **1. Find anystate "n" times**

This macro becomes true when the first state it sees occurs "n" number of times. It uses one internal sequence level.

#### **2. Find pattern present/absent for > duration**

This macro becomes true when it finds a designated pattern that has been present or absent for greater than or equal to the set duration. It uses one internal sequence level.

#### **3. Find pattern present/absent for < duration**

This macro becomes true when it finds a designated pattern that has been present or absent for less than the set duration. It uses four or five internal sequence levels.

#### 4. Find edge

This macro becomes true when the designated edge is seen. It uses one internal sequence level.

#### 5. Find Nth occurrence of an edge

This macro becomes true when it finds the designated occurrence of a designated edge. It uses one internal sequence level.

Pattern/Edge  
Combinations

##### 1. Find edge within a valid pattern

This macro becomes true when a selected edge type is seen at the same time as a designated pattern. It uses one internal sequence level.

##### 2. Find pattern occurring too soon after edge

This macro becomes true when a designated pattern is seen occurring within a set duration after a selected edge type is seen. It uses three or four internal sequence levels.

##### 3. Find pattern occurring too late after edge

This macro becomes true when one selected edge type occurs, and for a designated period of time after that first edge is seen, a pattern is not seen. It uses two internal sequence levels.

Time Violations

##### 1. Find 2 edges too close together

This macro becomes true when a second selected edge is seen occurring within a designated period of time after the occurrence of a first selected edge. It uses three or four internal sequence levels.

##### 2. Find 2 edges too far apart

This macro becomes true when a second selected edge occurs beyond a designated period of time after the first selected edge. It uses two internal sequence levels.

##### 3. Find width violation on a pattern/pulse

This macro becomes true when the width of a pattern violates designated minimum and maximum width settings. It uses four or five internal sequence levels.

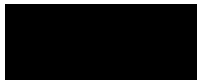

Delay

**1. Wait "t" seconds**

This macro becomes true after a designated time period has expired. It uses one internal sequence level.

---

## State trigger macro library

The following list contains all the macros in the library of state trigger macros. They are listed in the same order as they appear onscreen.

User Mode

**User level - custom combinations, loops**

The User level is a user-definable level. This level offers low-level configuration and uses one internal sequence level.

Basic Macros

**1. Find anystate "n" times**

This macro becomes true when the first state it sees occurs "n" number of times. It uses one internal sequence level.

**2. Find event "n" times**

This macro becomes true when it sees a designated pattern occurring a designated number of times consecutively or nonconsecutively. It uses one internal sequence level.

**3. Find event "n" consecutive times**

This macro becomes true when it sees a designated pattern occurring a designated number of consecutive times. It uses one internal sequence level.

**4. Find event 2 immediately after event 1**

This macro becomes true when the first designated pattern is seen immediately followed by a second designated pattern. It uses two internal sequence levels.

Sequence

Dependent macros

**1. Find event 2 "n" times after event 1, before event 3 occurs**

This macro becomes true when it first finds a designated pattern 1, followed by a selected number of occurrences of a designated pattern 2. In addition, if a designated pattern 3 is seen anytime while the sequence is not yet true, the sequence starts over. If pattern 2's "nth" occurrence is coincident with pattern 3, the sequence starts over. It uses two internal sequence levels.

**2. Find too few states between event 1 and event 2**

This macro becomes true when a designated pattern 1 is seen, followed by a designated pattern 2, and with less than a selected number of states occurring between the two patterns. It uses three or four internal sequence levels.

**3. Find too many states between event 1 and event 2**

This macro becomes true when a designated pattern 1 is seen, followed by at least a selected number of states, then followed by a designated pattern 2. It uses two internal sequence levels.

**4. Find n-bit serial pattern**

This macro finds an "n" bit serial pattern on a designated channel and a designated label. It uses "n" internal sequence levels.

Time Violations

**1. Find event 2 occurring too soon after event 1**

This macro becomes true when a designated pattern 1 is seen, followed by a designated pattern 2, and with less than a selected time period occurring between the two patterns. It uses two internal sequence levels.

**2. Find event 2 occurring too late after event 1**

This macro becomes true when a designated pattern 1 is seen, followed by at least a selected time period, before a designated pattern 2 occurs. It uses two internal sequence levels.

Delay

**1. Wait "n" external clock states**

This macro becomes true after a designated number of user clock states have occurred. It uses one internal sequence level.

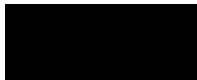

## Modifying the user macro

Before you begin building a trigger specification using the user macro, it should be noted that in most cases one of the pre-defined trigger macros will work.

If you need to accommodate a specific trigger condition, or you prefer to construct a trigger specification from scratch, use the User macro as a starting point. This macro appears in long form, which means it has the analyzer's total flexibility available in terms of resource terms, global timers, occurrence counters, duration counters, and two-way branching.

The User macro has a "fill-in-the-blanks" type statement. You have the following elements to use:

- Bit Patterns, Ranges, and Edges
- Storage Qualification
- < and > Durations
- Occurrence Counters
- Timers
- Branching

A typical method used during a debug operation is to first trigger on a known pattern, edge or range. From that point, it becomes an iterative process of adding more levels to further filter the data. It is important for you to know how to use such elements as occurrence counters, timers, and branching, to zero in and trigger at the desired point.

As the analyzer executes the trigger specification, it searches for a match between the resource term value and the data. When a match is found, that part of the sequence statement becomes true and the sequencing continues to the next part of the statement or the next sequence level.

Eventually a path of "true" resource terms leads to your trigger command. If timers or occurrence counters are used, the analyzer waits or counts occurrences of a specified value before continuing.

The following examples illustrate the use of resource terms, occurrence counters, timers, branching, and store qualification. You will use them in your trigger specification either by themselves or combined with each other.

### Using bit patterns, ranges, and edges

Bit patterns are set to match specific data values, and ranges are set to match a range of bit patterns. In the Timing Acquisition mode, edges are set to match specific edges of a timing pulse.

### Using storage qualification

Store qualification enables you to store all data, no data, or just selected data, before trigger occurs.

### Setting < and > durations (Timing only)

When a resource term is found during a timing sequence evaluation, you can dictate how long the term must remain before the term actually becomes true. When less than (<) or greater than (>) duration is assigned, the secondary branching (Else on) is not available.

**> field** When greater than (>) is used, the analyzer continues sequence level evaluation only after the resource term has been true for greater than or equal to the amount of duration specified.

**< field** When less than (<) is used, the analyzer continues sequence level evaluation only after the resource term has been true for less than or equal to the amount of duration specified. Using less than requires four sequence levels.

### Using the Occurrence Counters

**Occurs field** When "Occurs" is selected, the < and > duration functions change to an occurrence counter. Use the occurrence counter to delay sequence evaluation until the resource term has occurred a designated number of times. If the "else on" branch becomes true before all specified occurrences of the primary "Trigger on" branch, the secondary "else on" branch is taken.

### Using the timer

Timers are like other resource terms in that they are either true or false. Timers can be set to Start, Stop, Pause, or Continue as the analyzer enters a sequence level. The two timers are global, so each sequence level can control the same timer. The default timer condition in all sequence levels is Off.

Timers start as you enter the sequence level, and when the timer count expires, the timer becomes true. If a timer is paused in one level, it must be continued in another level before it can count through.

As more sequence levels are added, the timer status in the new levels defaults to Off. Timers must be continued or started in each new level as appropriate. When a timer expires or stops, its count resets to zero.

### **Branching**

If either the less than or greater than duration is used, only the primary branch is available. Otherwise, each sequence level except for the last has two-way branching.

If the primary branch is taken, the analyzer goes to the next level. If the primary branch is not found, the analyzer immediately evaluates the "Else on" secondary branching term.

If the "Else on" term is found, the secondary branch taken is to the designated sequence level. If the "Else on" term is not found, the analyzer continues to loop within the same sequence level until one of the two branches are found. If the "Else on" branch is taken, the occurrence counter is reset even if the "go to level" branch is back to the same level. If both branches are found true at the same time, the primary branch is taken.

Branching across the trigger level is possible. If this occurs, the sequence level evaluation could loop without ever seeing a trigger term. Be careful in designing your sequence instructions.



---

## Resource terms

Resource terms are user-defined variables that are assigned to sequence levels. They are placed into the sequence statement where their bit pattern or edge type is searched for within the data stream. When a match is found, a branch is initiated and the next statement or sequence level is acted upon. Resource terms take the following forms:

- Bit patterns terms a–j
- Range terms 1 and 2
- Edge terms 1 and 2 (Timing only)
- Global timers 1 and 2

All resource terms and timer terms are listed in a scrollable Terms field. To view all offscreen terms, select the Terms field, then use the knob to roll the terms list onscreen.

When the logic analyzer is configured as a state analyzer, you can use any of the ten bit pattern terms, range terms, or timers in your trigger specification. When you configure the logic analyzer as a timing analyzer, you can use any of these terms plus the edge terms.

### **Bit pattern terms a–j**

You can set a bit pattern consisting of any combination of 1s, 0s, or Xs (don't cares) for the 10 terms a – j. Bit pattern terms can also take the NOTed form of a – j.

### **Range terms 1 and 2**

Two range terms are available which can be set to a range of bit pattern values. The first pattern and the last pattern are part of the range which must be matched.

Range terms take the form of either In Range, or the NOTed form of Out Range.

### **Edge terms 1 and 2 (Timing only)**

The two edge terms are only available in the timing analyzer. Each edge term is assigned positive-going, negative-going, or any-transition edge type.

### Global timers 1 and 2

In addition to the resource terms available, there are two global timers available. Each timer can be started, paused, continued, or stopped, from any sequence level except the first.

### Assigning resource term names and values

The Terms field identifies the list of available resource terms within the analyzer. A resource term can be assigned to only one machine at a time. The resource term names (a – j, Edge1, Edge2, Range1, Range2) are default names that can be changed. You assign values in the following two ways:

- Using Preset Values
- Assigning Bit by Bit

**Changing resource properties** When any of the individual term fields are selected, a configuration pop-up appears. Use this pop-up menu to quickly set the resource term to a preset value.

### Using Preset Values

**Assign** Assign toggles which machine the term is assigned to. All of the available resource terms except the Edge terms can be assigned to any analyzer. However, a term can only be assigned to one analyzer at a time.

**Rename** Rename lets you change the term name. This function works for all terms.

**Clear (=X)** Clear sets the terms to their broadest possible meaning. For terms a – j, the assignment field is set to all Xs (don't cares). For Range 1 and 2, the boundaries are set to the maximum and minimum values. For Timers 1 and 2, the assignment field is set to a minimum time of 400 ns. For Edge 1 and 2, the assignment field is set to don't cares.

**Set (=1)** In terms a – j, the assignment field is set to its maximum value, with all bits set to 1. This option is not available for the Range, Timer, and Edge terms.

**Reset (=0)** In terms a – j, the assignment field is set to its minimum value, with all bits set to 0. This option is not available for the Range, Timer, and Edge terms.

### Assigning Bit by Bit

**Bit pattern terms** Just to the right of the bit pattern name fields are the term assignment fields. When any of the individual assignment fields are selected, a keypad appears. Use this keypad to assign real values or Don't Care (X) values.

**Edge terms** Assign edge terms the same way you do bit pattern terms. Edge terms can be used singularly or in combination with each other across all assigned channels. When you specify an edge on more than one channel, the analyzer ORs the edges.

After the assignment menu closes, you may see "\$" indicators in the field display. A "\$" indicates the assignment can't be displayed in the selected base because of Don't Cares. When you display the assignment in binary, however, you can see the actual pattern.

**Range terms** Range terms require an upper and lower bit pattern boundary. The range is recognized as the data that is numerically between or on the two specified boundaries. In addition, the range must be contained in a single label across a single pod pair, with no clock bits allowed.

**Timer terms** Timers are either true or false. Timers start as you enter the sequence level, and when its count expires, it becomes true. If a timer is paused in one level, it must be continued in another level before it can count through.

As more sequence levels are added, the timer status in the new levels defaults to Off. Timers must be continued or started in each new level if it is appropriate. When a timer expires or stops, its count resets to zero.

### Combination of terms

Combination terms are configured and selected from within trigger sequence levels. All user-defined resource terms can be combined to create complex qualifiers that occupy a single assignment field space.

When you select the term field in a Sequence Level menu, a pop-up selection list appears. If you then select "Combination," a logical assignment menu appears. Use this menu to turn on resource terms and input them into a chain of logical operators.

When the combination is placed in the assignment field, if the term is too long to fit in the assignment field, the display is truncated.

---

## Arming Control field

Arming Control sets up the order of triggering for complicated measurements involving more than one machine. You can set the analyzer or oscilloscope to begin running when it receives a signal from an external machine, have one analyzer start the other or the scope, have the scope start an analyzer, or have an analyzer or the scope send a signal to another external machine. The default configuration is to have both analyzers and the oscilloscope run independently without external communications.

### Arming control between analyzers and the oscilloscope

If both analyzers are turned on, you can configure one analyzer to arm the other, an analyzer to arm the oscilloscope, or the oscilloscope to arm an analyzer. The initial Arm In to the system can be Run (oscilloscope and analyzers operate independently), Group Run (oscilloscope and analyzers form a dependent system), or Port In to the oscilloscope and/or an analyzer (dependent or independent system, depending on the rest of the configuration). Any of the instruments can send an Arm Out signal.

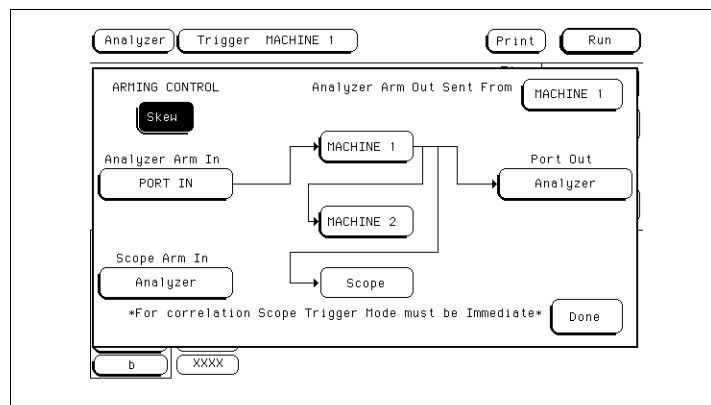

The fields to the left on the screen select the Arm In, and allow you to specify the arming dependencies between the analyzers and the oscilloscope. The fields to the right on the screen select the Arm Out. The analyzer name fields in the center allow you to further define the arming dependencies. When you select an analyzer name field, a pop-up menu for selecting the flow appears. This menu also selects the sequence level in which an "arm" flag is placed.

When an analyzer receives an Arm In signal, the arm term in the user-selected sequence level becomes true. If the analyzer was waiting at a

trigger sequence level for the arm term, the analyzer begins evaluating the rest of that sequence level. However, if the arm term is not part of the current sequence level, the preceding sequencing could trigger the analyzer before the arm term is seen. Generally, the arm term is evaluated and used the same as the other resource terms within the sequence instruction.

### **Skew**

Skew allows you to enter a time offset for either the oscilloscope or analyzer, to adjust the display. For correlation, the oscilloscope trigger mode must be set to Immediate.

Selecting Skew gives you pop-up menus for Analyzer and Scope. The two fields act jointly. For example, the effect of entering -8 ns in the Analyzer field is the same as entering 8 ns in the Scope field.

### **Cross-armed measurements**

By using the Group Run option you can time-correlate the measurements between the oscilloscope and a timing analyzer and display data from either machine on one display.

The oscilloscope trigger must be in Immediate mode when armed by the analyzer to cause correlation of both modes waveforms.

If you set the oscilloscope to Run in the Arming menu, the oscilloscope will be in the free-run mode and the waveform display will not be synchronized with the other measurements in your system.

### **Arming control using external BNCs**

The External BNCs on the rear panel provide more complex arming. In the Arming Control menu, the External Triggers are called "Port In" and "Port Out". The Arm In fields provide the selection for "PORT IN", and the Analyzer Arm Out Sent From/Port Out fields configure the "PORT OUT". The Port In can arm either or both the oscilloscope and the analyzers, while the Port Out can come from only a single instrument at a time.

One possible scenario is to have several test instruments, a logic analyzer, and the oscilloscope connected to a complex target system. The analyzer is armed by an external Arm In signal from another test/measurement entity. After the first analyzer triggers, it arms the second analyzer. After the second analyzer triggers, it arms the oscilloscope and sends a Port Out signal through the external BNC. This signal is used to arm another external test/measurement entity. Note that when Port Out specifies Analyzer and

the oscilloscope is armed by an analyzer, the oscilloscope can only be armed by the same analyzer that arms Port Out.

---

## Acquisition Control field

Selecting the Acquisition Control field pops up the Acquisition Control menu. The Acquisition Control menu sets the acquisition mode, the trigger position within acquisition memory, and the sample period.

### **Acquisition Mode field**

The Acquisition Mode field toggles between Manual and Automatic. When set to Automatic, the sample rate and the position of stored data relative to trigger are based on the sec/Div and delay settings in the Waveform menu.

When Acquisition Mode is set to Manual, additional configuration fields become available. The additional configuration fields work together with the sequence instructions in a prioritized manner to position the memory relative to the trigger point. A small picture at the bottom of the menu displays the sum effect of all the settings on the trigger position within memory.

### **Trigger Position field**

The Trigger Position field sets how much information is stored before and after the trigger. When a run is started, a timing analyzer will not look for a trigger until at least the proper percent of pre-trigger data has been stored. A state analyzer will trigger at the first occurrence of the trigger, but will notify you that the prestore was not completed. After a trigger has been detected, the rest of memory is filled before the analyzer halts.

In a timing analyzer, even when the trigger position is set to Start or End, there will always be a small portion of pre-trigger and post-trigger data stored. Most of the choices designate prestore and poststore percentages, but the Delay setting affects when the memory begins storing data relative to the trigger.

**Delay** The Delay field delays the start of acquisition storage after the trigger. The delay time range is affected by the sample period but could range from 16 ns to 8 ks. As the picture in the pop-up menu shows, any data falling between the trigger and the delay time is not stored.

### **Branches Taken Stored / Not Stored field**

The Branches Taken field is a toggle field that sets the analyzer to store, or not to store, the resource term that sent the analyzer off on a branch.

As the analyzer steps through the sequence instructions, it may take either branch of a sequence level. With Branches Taken set to Stored, the state data values that caused the branch are stored. When the analyzer is set to Branches Taken Not Stored, only the data you explicitly designate in the sequence levels is stored.

Branches Taken Stored/Not Stored is not available when the analyzer is configured as a timing analyzer.

---

## **Count field (State only)**

The Count field accesses a selection menu which indicates whether acquisition data is stamped with a Time tag or a State Count tag.

### **Time and State tags**

If you have all pod pairs assigned, the state acquisition memory is reduced by half when time or state tags are turned on. You can maintain full memory depth if you leave a specified pod pair unassigned.

**States** States places numbered tags on all data relative to the trigger. Pre-trigger data has negative numbers and post-trigger data has positive. In the display menus, State numbering is either relative to the previous memory location or absolute from the trigger point. You can set it in the display menus by toggling the Absolute/Relative field.

**Time** Count Time places time tags on all displayed data. Data stored before triggering has negative time numbers and data stored after triggering has positive time numbers. Time tag numbering is set to be either relative to the previous memory location or absolute from the trigger point. Selecting the Absolute or Relative option is done by toggling the Absolute/Relative field. Time tag resolution is 8 ns.

**To retain full memory using time or state tags** To retain full memory depth when using time or state tags requires that one pod pair be unassigned. The exact pair to unassign varies. Generally, it is best to unassign one of the middle pod pairs. If you have two analyzers configured, the ends must be assigned to different analyzers.

---

# The Analyzer Listing Menu

---

## Markers

The Markers field accesses the markers selection menu. When the Markers field is selected, a marker selection menu appears with the marker choices appropriate for the present analyzer configuration.

### **Off**

The Off selection turns off marker operations but does not turn off operations based on the markers. For example, if a stop measurement was previously specified and the stop measurement criteria are met, the measurement will stop even though the markers are off.

### **Pattern markers**

Pattern markers identify and mark unique bit patterns in the data listing. Once the unique bit patterns are marked, you can use them as reference points or as criteria for a stop measurement.

When a marker is positioned in the Listing menu, it is also positioned in the Chart menu and Waveform menu, but not in the Mixed Display.

### **State analyzer markers**

In a state analyzer with Count Off in the Trigger menu, only Pattern markers are available. With Count Time turned on, Time markers and Statistics markers become available. With Count States turned on, State markers become available.

### **Timing analyzer markers**

Timing analyzers always have marker choices of Pattern, Time, or Statistics. Timing analyzers do not have state markers. The pattern markers, though, can be used to count intervening patterns.

### **Stop measurement field**

The stop measurement function specifies a condition that stops the analyzer measurement during a repetitive run. If two analyzers are configured, both analyzers stop when either specified stop condition is satisfied.



**Off** The Off selection turns all Stop measurement operations off. If the stop measurement operation is not turned off and the stop measurement criteria is met, the measurement will stop even though the markers are set to other types or turned off.

**X-O** The X-O option is available in the Timing analyzer and in the State analyzer with its count set to Time.

When X-O is selected, a repetitive run is stopped when a comparison of the time period between the X and O markers and one of the time period options is true.

**Compare** When you select Compare, a repetitive run is stopped when a comparison of data in the Listing menu and data and criteria in the Reference listing of the Compare menu matches an equality selection. The equality selection is set from the Equal/Not Equal selection pop-up menu.

### **Statistics markers**

After patterns are assigned to the X and O markers, statistical information is available when markers are set to Statistics.

In a State analyzer, Statistics markers only become available when the Trigger menu Count field is set to Time.

Statistics are based on the time between the X and O. Both markers must be found before valid statistical information is displayed.

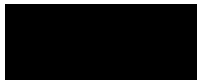

---

# The Analyzer Waveform Menu

---

---

## sec/Div field

When acquisition control is set to automatic, the sec/Div field affects the sample period. Timing waveforms are reconstructed relative to the sample period. A shorter sample period puts more sample points on the waveform for a more accurate reconstruction but also fills memory more quickly.

If the sec/Div is changed resulting in a change in the next sample period, you must run the analyzer again before the current sample period display is updated. The sample period is shown in the second row from the top when the markers are turned off.

---

## Accumulate field

The Accumulate field controls whether old data is cleared or displayed along with new data. The Accumulate field will toggle On/Off. When Accumulate is on, the analyzer displays the data from a current acquisition on top of the previously acquired data. When Accumulate is off, the display is cleared before each new run cycle.

If you leave the Waveform menu, or pop up a menu over the waveform display, any accumulated display data is lost and the accumulation process starts over.

---

## Delay field

Depending on the analyzer configuration, a positive or negative delay measured in either states (State only) or time (Timing only) can be set. The Delay field allows you to scroll the data and place the display window at center screen. Changing the delay will not affect the data acquisition unless it is a timing analyzer and the acquisition mode is automatic. In this case, the sample period changes.

The delay range of a timing analyzer is from  $-2500$  to  $+2500$  seconds. The delay range of a state analyzer is from  $-8192$  to  $+8192$  states.

---

## Waveform label field

The waveform label field, located on the left side of the waveform display, is both a display and configuration field for timing waveforms and oscilloscope waveforms. After all desired waveforms are configured for display, they are listed in the waveform label field. If there are more waveforms than can be displayed, you can roll the list by selecting the waveform label field, then after the roll indicator appears, turning the knob.

If the waveform label field is selected a second time, a waveform modification menu appears. Use this menu to configure the waveform display.

When the waveform modification menu appears, select the operation to insert, replace, delete, or scale waveforms into the display. For insert or replace, a second pop-up appears for scope or analyzer. You can display up to 24 waveforms on screen at one time, and up to 96 waveforms by scrolling the waveform display.

### **Viewing state values in the bus option**

When all assigned waveforms in a label are overlaid with the Bus option, the value of the data is displayed in the base selected in the Listing menu to the right of each new transition in the waveform display. This happens only when the waveform size is large.

If the sec/Div is set to view a large increment of time, or the waveform scaling is set to small or medium, the state data readout does not fit between transitions. To display the state data readouts within the waveform, expand the sec/Div and use the large waveform setting.

---

## Waveform display

### Display location reference line

At the bottom of the Waveform menu is a reference line which displays the relative location of the display window, the markers, and the trigger point with reference to the total memory.

Total memory is represented by a horizontal dotted line. The display window is represented by an overlaid solid line. The markers and trigger point are represented by small dots above the total memory line, and an X, O, and t label, all of which are located below the total memory line.

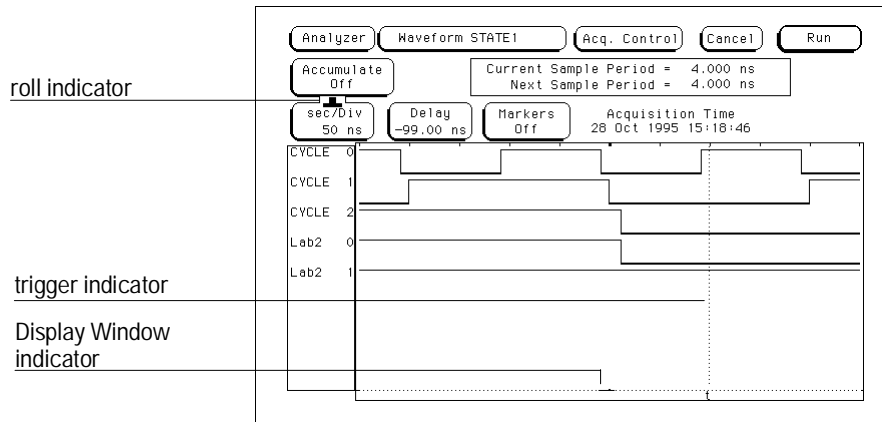

---

## The Analyzer Mixed Display Menu

The Mixed Display menu combines a state listing display located at the top of the menu and a timing waveform and/or oscilloscope display located at the bottom of the menu. The Mixed Display menu shows both state and timing data, state data and oscilloscope waveform, or state data and timing waveform and oscilloscope waveform in the same display.

The Mixed Display menu only becomes available when at least one analyzer is configured as a state analyzer, with its Count field in the Trigger menu set to Time. If two state analyzers are configured, both state listing displays can be interleaved as well as shown separately, however, the listing menus are the best display menus for a two-state analyzer configuration.

The waveform display area shows timing analyzer waveforms from the configured timing analyzer, the oscilloscope waveform, or both.

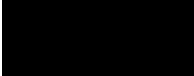

---

### Interleaving state listings

Interleaved state listings allows you to view two labels and their data from different analyzers in the same column. The process of interleaving state listings can be performed in either the Listing menu or the Mixed Display menu. For example, if data is interleaved in the Listing menu, it will be automatically interleaved in the Mixed Display menu.

The interleaved label is placed directly above the selected label, and all interleaved data is displayed in white. In addition, the state numbers of the interleaved data are indented to the right. Because of the lack of room available in the listing portion of the Mixed Display menu, the label identifying the interleaved data is not displayed. For this reason, when two state analyzers are configured the listing menu should be used to display interleaved labels.

---

## **Time-correlated displays**

Once the Time markers are set in the Waveform display area of the Mixed Display menu, time-correlated X and O Time markers will be displayed in both the listing and the waveform display areas.

---

## **Markers**

The markers in the Mixed Display menu are not the same as the markers in the individual Listing and Waveform menus. First, Mixed Display only has time markers. Second, markers placed in the individual waveform and listing menus will not transfer to the Mixed Display menu. You must place new Time markers on your points of interest in the Mixed Display.

---

## The Analyzer Chart Menu

State Chart is a software post-processing feature that provides the ability to build x-y charts of label activity using state data. The Chart menu builds a graphical representation of the system under test. The Y axis always represents data values for a specified label. You can select whether the X axis represents states (rows in the state listing) or the data values for another label.

When the X axis is set to State, X and O markers are available which display the current sample relative to the trace point and the corresponding Y axis data value. Marker placement is synchronized with the normal state listing.

An accumulate mode is available that allows the chart display to build up over several runs.

You can generate x-y charts of Label vs. Label or Label vs. State.

### **Label vs. Label charts**

When labels are assigned to both axes, the chart shows how the data acquired under one label varies in relation to the other for a particular measurement. Label values are always plotted in ascending order from the bottom to the top of the chart and in ascending order from left to right across the chart. Plotting a label against itself will result in a diagonal line from the lower left to upper right corner. All markers are disabled when plotting this kind of chart.

### **Label vs. State charts**

Label versus State is a plot of data values acquired under a label versus the memory location of the same data. The label value is plotted against successive memory locations numbers.

---

## Min and Max scaling fields

When State is selected for the X axis, the minimum and maximum values can range from -8192 to +8192 depending on the trace point location.

When Label is selected for either axis, the minimum and maximum values range from 00000000hex to FFFFFFFFhex regardless of the axis, because labels are restricted to 32 bits.

---

## Markers/Range field

The Marker/Range field is a toggle field. If the field is set to Range, X and Y range fields become available to set the chart minimum and maximum range points. If the field is set to Markers, a marker selection menu appears with marker choices available with the present analyzer configuration.

In a state analyzer with Count Off in the Trigger menu, only Pattern markers are available. With Count Time on, Time markers and Statistics markers become available. With Count States on, States markers are available. The markers function just like those of the Waveform and Listing displays.



---

## The Analyzer Compare Menu

State Compare is a software postprocessing feature that provides the ability to do a bit-by-bit comparison between the acquired state data listing and a reference listing. State Compare is only available when at least one analyzer is configured as a State analyzer.

The comparison between the acquired state listing data and the data in the reference listing is done relative to the trigger points. This means that the two data records are aligned at the trigger points and then compared bit-by-bit.

Any bits in the acquired data that do not match the bits in the compare image are treated as unequal.

You can separately view the acquired data, the reference listing, and a listing that highlights the bits in the acquired data that do not match the corresponding bits in the reference listing.

You can edit the reference listing for unique comparisons.

You can mask specific bits that you do not want to compare. These "Don't compare" bits can be specified individually for a given label and state row, or specified by channel across all state rows.

You can select a range of states to compare. When a range is selected, only the bits in states on or between the specified boundaries are compared. Also, you can save the reference listing along with the analyzer configuration to disk.

## Reference Listing field

The Reference listing and Difference listing field is a toggle field that switches the listing type between the Reference image listing and the Difference listing.

The Reference listing is a display of the image (or template) that acquired data is compared to during a comparison measurement. The boundaries of the image (or size of the template) are controlled by using the channel masking and compare range functions. Any bits in the reference listing displayed as "X" have been set to don't care bits during bit editing.

When the data listing is rolled, the difference data listing and the data listing in the Listing menu are also rolled.

---

## Difference Listing field

The Reference listing and Difference listing field is a toggle field that switches the listing type between the Reference image listing and the Difference listing.

The Difference listing is a display of the acquired data listing with the data that differs, if any, from the Reference listing, highlighted with inverse video. If the base is inverse-assembled symbols, the entire line is highlighted with inverse video.

The controls that roll the listing in all three menus (the normal State listing, the Reference listing, and the Difference listing) are synchronized unless the number of pre-trigger states differ between the Reference listing and the acquired data. This means that when you change the current row position in the Difference listing, the analyzer automatically updates the current row in the acquired State listing and Reference listing, and vice-versa.

If the three listings are synchronized and you acquire data again, the Reference listing may have a different number of pre-trigger states depending on the trigger criteria. The Reference listing can be resynchronized to the State and Difference listings by entering the desired state (acquisition memory) location from the front-panel keypad.

This allows you to view corresponding areas of all lists, to cross check alignment, and to analyze the bits that do not match.

---

---

## Copy Listing to Reference field

The initial Reference image is generated by either copying the data listing from the listing menu or by loading an analyzer configuration file which contains a Reference listing. Be aware that if you load an analyzer configuration to get a Reference image, the other menu setups will change.

When the Copy Listing to Reference field is selected, the contents of the acquisition data structure (Listing menu display) is copied to the Reference image buffer. The previous Reference image is lost if it has not been saved to a disk.

---

## Find Error field

The Find Error field allows you to easily locate any patterns that did not match in the last comparison. Occurrences of differences, or errors, are found in numerically ascending order from the start of the listing. The first occurrence of an error has the numerical value of one.

You select which error number to find by highlighting the Find Error field and entering a number from the front-panel keypad. If the roll indicator is in the Find Error field, simply turn the knob. The listing is then scanned sequentially until the specified occurrence is found and rolled into view.

---

## Compare Full/Compare Partial field

The Compare Full/Compare Partial field is a toggle field which allows you to compare either the full range of states or define a subset of the total number of states in the Reference image to be used in the comparison.

The Compare mode is accessed by selecting the Compare Full/Compare Partial field in either the Compare or Difference listing menus. When selected, a pop-up appears in which you select either the Full or Partial option.

When you select the Partial option, fields appear for setting the start state and stop state values. Only bits in states (lines) on or between the boundaries are compared against the acquired data.

---

## Mask field

The channel masking field is used to specify a bit, or bits in each label that you do not want compared. This causes the corresponding bits in all states to be ignored in the comparison. The Reference data image itself remains unchanged on the display.

When you select the Mask field an assignment pop-up appears in which you specify which channels are to be compared and which channels are to be masked. A "." (period) indicates a don't compare mask for that channel and an "\*" (asterisk) indicates that channel is to be compared.

---

## Bit Editing field

The bit editing fields are located in the center of the Reference listing display. A bit editing field exists for every label in the display unless the label's base is ASCII or inverse assembled symbols. Bit editing field allows you to modify the values of individual bits in the Reference image or specify them as don't compare bits.

You access data in the Reference listing by rolling the data listing using the knob until the data is located in the bit editing field. To enter a desired pattern or don't compare (X) for a bit, select the field and use the front-panel keypad.

---

# Oscilloscope Common Menus

The following options apply to all of the oscilloscope menus.

---

## Run/Stop options

There are three ways you can manually run and stop the oscilloscope: the Autoscale menu, the Run and Stop keys, and the Run/Stop field.

### Single and Repetitive modes

Single mode acquisition fills acquisition memory once with 8000 samples of the input waveform, automatically stops running, then displays the contents of acquisition memory. Each 8000-sample waveform record is acquired in a single acquisition. Each channel has a memory capacity of 8000 samples.

Repetitive mode acquisition fills acquisition memory with 8000 samples of the input waveform on continuing acquisitions, with each new acquisition overwriting the previous. The display is updated each time a new acquisition is made. Repetitive mode continues acquiring data in this manner until you select the Stop field. As in single mode, each 8000-sample waveform record is acquired in a single acquisition.

### Autoscale run

Select the autoscale field on the screen, then choose Continue from the pop-up menu. When autoscaling is complete, the oscilloscope automatically starts running.

If you have been using the Run field to initiate your runs, the oscilloscope will run in the mode (single or repetitive) that was last chosen using the Run options. If no run mode has been chosen prior to choosing autoscale, the run mode defaults to single mode.

If you have been using the Run key to initiate your runs, the oscilloscope will run in single mode.

### See Also

"Autoscale" later in this chapter for information on how the autoscale algorithm works.

## Autoscale

Autoscale is an algorithm that automatically optimizes the display of one or more waveforms. When you select the Autoscale field and choose Continue, the autoscale algorithm starts.

### **What the Autoscale algorithm does when a signal is found**

The autoscale algorithm first checks all input channels to determine whether or not there are any signals present. The vertical scaling is then set as required for each channel. Next the time base is scaled for a single input channel, the trigger channel is selected, the data is acquired, and the waveforms are displayed.

**Finding the vertical settings** The autoscale algorithm sets the vertical scaling (V/Div and offset) appropriate to the input signal for channel 1. This process is repeated for channel 2.

**Finding the time base settings** The time base settings (s/Div and delay) are determined based on the input signal of Channel 1 (if active) or Channel 2. The time base is scaled so that between two and five complete cycles of the time base scaling source input signal can be seen on the screen. The trigger settings are also changed by the autoscale algorithm and an edge mode trigger with CHAN 1 or CHAN 2 is selected. The channel selected for time base scaling is selected as the trigger source.

**Displaying the waveform** When the autoscale algorithm is complete, the oscilloscope automatically starts running, acquires the data, and displays waveforms for the inputs that have been selected.

The trigger point on the waveform is determined by the trigger level set by the autoscale algorithm. The trigger point is displayed as a dotted vertical line at the center of the screen (Delay = 0 s).

### **What the Autoscale algorithm does when a signal is not found**

If no signal is found, the autoscale algorithm toggles the Auto-Trig field to On, which places the oscilloscope in the automatic trigger mode. The oscilloscope then displays the message "Auto triggered." The automatic trigger mode allows the oscilloscope to sweep automatically and to display a baseline anytime a trigger signal is not present. All other settings are restored to their original values.

**Menus and fields changed by the Autoscale algorithm**

The following table shows the menus and their fields that are changed by the autoscale algorithm.

---

**Settings Changed by Autoscale**

---

Menu	Field	Autoscale Action
Channel	V/Div Offset	Scaled - depending on amplitude of input signal. Scaled - depending on offset of input signal.
Trigger	Mode Source Level Slope Count Auto-Trig	Defaults to Edge. Set to lowest numbered channel with signal present. Scaled - depending on amplitude of lowest numbered channel with signal present. Defaults to Positive. Defaults to 1. Defaults to On.
All Applicable	s/Div Delay	Scaled - depending on frequency of lowest numbered channel with signal present. Defaults to 0 s.

---

**Time base**

The s/Div and Delay fields are displayed on all of the oscilloscope menus, except for the Calibration menu.

**s/Div field**

The s/Div field allows you to set the sweep speed (time scale) on the horizontal axis of the display from 1 ns/div to 5 s/div. Sweep speed is measured in seconds per division.

**Delay field**

The Delay field allows you to set the horizontal position of the displayed waveform in relation to the trigger. Delay time is always measured from the trigger point on the waveform to the center of the screen. Delay time is measured in seconds. When acquisitions are stopped, the Delay field can be used to control the portion of acquisition memory displayed on screen.

---

## The Scope Channel Menu

The Channel menu selects the channel input and the values that control the vertical sensitivity, offset, probe attenuation factor, input impedance, and coupling. The Channel menu also gives you preset vertical sensitivity, offset, and trigger level values for ECL and TTL logic levels. Each channel may be set independently of the other channel.

---

### Offset field

You use the Offset field to set the vertical position of the waveform on the screen. Offset is the dc voltage that is added to or subtracted from the input signal so that the waveform can be centered on the waveform display. Offset range and resolution are dependent on vertical sensitivity (V/Div) as shown in the table below. The table values are based on a 1:1 probe setting.

---

#### Offset Range and Resolution

---

V/Div Setting	Offset Range	Offset Resolution
4 mV - 100 mV/Div	$\pm 2$ V	1 mV
>100 mV - 500mV/Div	$\pm 10$ V	1 mV
>500mV - 2.5 V/Div	$\pm 50$ V	1 mV
>2.5 V - 10 V/Div	$\pm 250$ V	2 mV

Offset changes are not reflected on the waveform until a Run is initiated and the next acquisition is displayed. Changes to Offset during a repetitive run will be seen on the next displayed acquisition because the hardware is reprogrammed between acquisitions.



---

## Probe field

You use the Probe field to set the probe attenuation factor for the input channel currently displayed in the Input field.

### Probe attenuation factor

The probe attenuation factor can be set from 1:1 to 1000:1 in increments of one. When you select a probe attenuation factor, the actual sensitivity at the input does not change. The voltage values shown on the display (V/div, offset, trigger level) are automatically adjusted to reflect the attenuation factor. The marker and automatic measurement voltage values change when a Run is initiated and the next acquisition is displayed.

---

## Coupling field

You use the Coupling field to set the input impedance for the channel currently displayed in the Input field.

### Coupling field selections

When you select the Coupling field, a pop-up appears that shows the input impedance values available. The selectable values are  $1\text{M}\Omega$  / DC,  $1\text{M}\Omega$  / AC, and  $50\Omega$  / DC.

---

### CAUTION

The maximum input voltage for the  $50\Omega$  / DC Coupling field selection is 5 Vrms.

---

## Preset field

When you select the Preset field, a pop-up appears, offering choices of TTL, ECL, and User. The Preset field automatically sets offset, V/div, and trigger level values to properly display TTL and ECL logic levels. Trigger level is in the Trigger menu and can be changed only when edge trigger is the selected trigger mode.

---

# The Scope Display Menu

The Display options control how the oscilloscope acquires and displays waveforms.

---

## Mode field

The Mode field provides three selections: Normal, Average, or Accumulate.

### **Normal mode**

In Normal mode, the oscilloscope acquires waveform data and displays the waveform acquired from that data. New acquisitions overwrite old data.

### **Average mode**

In Average mode, the oscilloscope averages new data with previously acquired data. Averaging helps eliminate random noise from your displayed waveforms.

When you select Average mode, a new field appears next to the Mode field which allows you to set the number of waveform acquisitions to average. The number of averages can be set to 2, 4, 8, 16, 32, 64, 128, or 256.

If you start repetitive run, the oscilloscope acquires and displays data, averaging each run with the preceding set accumulated since you selected repetitive run. When the oscilloscope has acquired the number of waveforms you selected, it displays the advisory message "Number of averages has been met." All new data is weighed at  $1/N$  and is averaged with the previous data. All data is retained.

If you set the Run mode to Single, acquisitions are not made until you initiate a Run. If Average # is set to 16, as in the previous example, the "Number of averages has been met" message will not be displayed until you have selected the Run field 16 times.

If you bring a waveform that is being averaged in the oscilloscope into the waveform display of another time correlated module, such as the timing analyzer, the waveform will not continue to average. Only the most recent acquisition, not the average trace data, will appear on the screen. To view an

averaged mode trace with other time correlated waveforms, bring those other waveforms into the display of the channel that is setup for average mode.

### **Accumulate mode**

In Accumulate mode, the oscilloscope accumulates all waveform acquisitions and displays them on the screen without erasing the previously acquired waveforms. This is similar to infinite persistence on an analog storage oscilloscope. These acquisitions will stay on the display until Mode is changed, or until the waveform is adjusted by a control that causes the display to change, such as s/Div, Delay, or Connect Dots from On to Off.

When in Accumulate mode, the operation of the display grid follows special rules when turned on or off (refer to the Grid Field paragraph later in this chapter).

---

## **Connect Dots field**

The oscilloscope display can be enhanced to show a better picture of a waveform by using the Connect Dots On / Off. The default setting for the Connect Dots field is Off.

If an edge is fast enough (relative to the sample rate), the signal may begin to look like dots scattered around the display, because each sample is displayed as a single dot. To give you a better idea of what the waveform looks like, the oscilloscope can connect the sample dots together. Selecting the Connect Dots field toggles the field between On and Off.

---

## **Grid field**

The oscilloscope display can be set to Grid On or Grid Off. Selecting the Grid field toggles the field between On and Off. In either Normal or Average modes, the grid can be turned On or Off when the oscilloscope is not currently running and the change appears on screen immediately. If the oscilloscope is currently acquiring data, the grid will be drawn or removed when the acquisition is completed. In Accumulate mode, the grid can be turned On or Off at any time, but it will not be changed until the next acquisition is completed or some change is made to the display screen that causes the display to be erased and redrawn, such as changing s/Div.

## Display Options field

The Display Options field allows you to display either sample period information or marker value information on the oscilloscope menus, and also provides access to the scope channel labeling menu.

The Display Options field appears on the Channel, Trigger, Display and Auto-Measure menus. Selecting the Display Options field provides a pop-up menu, which provides the Set Channel Labels menu. If either voltage or time markers are enabled, selecting the Display Options field reveals all three of the following selections:

### **Set Channel Labels**

Selecting Set Channel Labels from the Display Options pop-up will take you to the Scope Channel Labels menu. This menu allows you to assign labels to each of the oscilloscope channels. These labels will subsequently appear in the channel label area to the left of the waveform display area. The scope channel labels appear on single trace waveforms only. The default oscilloscope labels are used for overlay and waveform math displays.

### **Display Sample Period**

Selecting the Display Sample Period option displays the sample period information on the scope menus. Sample period information is the default display option and is always displayed when markers are turned off.

### **Display Marker Values**

This option displays the marker value information on the oscilloscope menus.

---

# The Scope Trigger Menu

The Scope Trigger menu allows you to choose the method you want to use to trigger the oscilloscope for a particular application.

---

## Trigger marker

The trigger marker is the dotted vertical line at the center of the waveform display. The point where the waveform from the trigger source crosses the trigger marker is called the trigger point. The trigger point always represents a delay time of zero seconds.

If you set Delay time to greater than  $\pm 5$  times the the setting for s/Div, the trigger marker will move off the screen.

---

## Mode/Arm menu

The Mode/Arm field provides a pop-up menu with three types of triggering, plus a fourth choice identical to the Arming Control field in the Analyzer Trigger menu. The three types of triggering are Edge, Pattern, and Immediate. For information on Arming Control, refer to "Arming Control field" earlier in this chapter. Note that to time-correlate the oscilloscope and the analyzer waveforms when the oscilloscope is armed by a logic analyzer, the Mode must be set to Immediate.

### **Edge trigger mode**

In the edge trigger mode, the oscilloscope triggers at a specified voltage level on a rising or falling edge of one of the input channels. In this mode you can specify which input is the trigger source, set a trigger level voltage, and specify which edge to trigger on.

When you select edge trigger mode, additional fields appear for Source, Level, Slope, Count, and Auto-Trig. These fields are discussed in the following sections.

### **Pattern**

Pattern trigger mode allows you to trigger the oscilloscope upon entering or exiting a specified pattern of the trigger channels or by specifying a pattern duration time or range. Each entry in the pattern shown in the Pattern row shows the trigger condition of the input above it in the Channel row.

You must set the trigger voltage level for each input you want to use in the pattern. To set the voltage level, first set the Mode to Edge, then set the level for each channel used in the Pattern. You can then return to Pattern mode. The trigger level marker does not appear when Pattern mode triggering is selected.

The pattern for each input may be specified as high (H), low (L), or "don't care" (X). H, L, and X conditions are as follows:

- H—the voltage value of this input channel must be greater than the edge trigger level of this input.
- L—the voltage level of this input channel must be less than the edge trigger level of this input.
- X—is a "don't care" condition. The "don't care" means the associated input channel will not be used in the pattern for the trigger qualifier. It does not equate to "trigger on anything."

The default condition for all patterns is X, "don't care." To change the pattern, select the Channel/Pattern field and use the pop-up menu.

A pattern of XX says to use NO channels to find the trigger.

Using NO channels to find the trigger does not equate to Immediate Mode when Auto-Trig is set to Off. This event will never occur in the hardware. Do not confuse XX with "don't care, trigger on anything."

### **Immediate trigger mode**

Immediate trigger mode causes the oscilloscope to trigger by itself. Immediate trigger mode can be used for dual time-base applications where, for instance, a timing analyzer arms the oscilloscope. The oscilloscope triggering mode must be set to Immediate in order to have the waveforms time-correlated.

This mode is very similar to Auto-Trig On, but immediate mode does not wait for a specified event to occur.

## Level field

The Level field shows the voltage value of the trigger level. When the voltage value on the trigger source input waveform equals the trigger level voltage value, the oscilloscope triggers.

When you change the trigger level voltage value, the waveform moves horizontally on the display to maintain the trigger point. (That is, the point where the waveform voltage value crosses the trigger point voltage value.) The following illustration shows this.

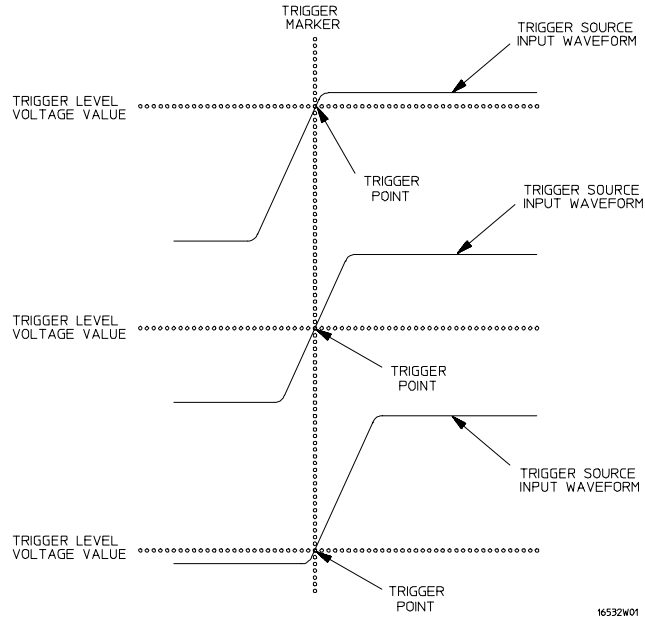

If the trigger point voltage level is set above or below the waveform amplitude, the trigger point cannot be found. If Auto-Trig is set to On, this causes the waveform display to become unsynchronized and to "float" on the display. If Auto-Trig is set to Off, the message "Waiting for trigger" is displayed.

The trigger point voltage can be set either by the autoscale function or by a voltage value set into the Level field. It can be set to any voltage value contained within the waveform display window, in increments of 0.05% of full scale vertical voltage range ( $V/Div \times 4$  divisions = full scale). For example, if full scale voltage range were 400 mV, trigger level would be set in increments

## Source field

of 2 mV ( $V/Div = 100 \text{ mV} \times 4 \times 0.005 = 2 \text{ mV}$ ). Values entered that are not in this range will be rounded to the nearest 0.05% increment.

Since the trigger level range is limited by the voltage values displayed in the waveform window, the voltage window limits can be easily determined. Turn the knob in both directions until the Level field reads minimum and maximum voltage. These voltage values are the limits of the waveform window. However, if the level is set at the min or max of a window and offset for that channel is changed, the trigger level will track that change, thereby changing the window limits.

If the trigger source channel is displayed in the waveform area of the screen, the trigger level marker will appear on the screen as a horizontal dashed line. The trigger level marker will move up and down on the screen as the trigger level voltage is changed.

If the trigger source channel is not in the waveform area of the screen, the trigger level marker will not be displayed.

If there are multiple occurrences of the trigger source waveform in the waveform area of the screen, only the uppermost occurrence of the trigger source waveform will display the trigger source marker.

The trigger level marker only appears when the trigger menu is selected.

The default value for the Level field is 1.620 V (TTL preset value).

---

## Source field

When you select the Source field, a pop-up menu appears showing the inputs available as the trigger source. The source can be channel 1 or channel 2.

At power-up, the default channel input selection for the Source field is the lowest numbered input channel. For example, if inputs are connected to both channels 1 and 2, the Source field defaults to 1. However, if an input signal is only connected to channel 2, the Source field defaults to 2 when you automatically scale with Autoscale, even though channel 1 is the default at power-up.



---

## Slope field

You can set the trigger slope to trigger on either the positive or negative edge of the trigger source waveform. When you select the Slope field, the field toggles between Positive and Negative.

The default selection for the Slope field is Positive.

---

## Count field

The Count field defines the number of trigger events that must occur after the first trigger qualifier before the oscilloscope will trigger and acquire a waveform. In edge trigger mode, you can define a positive or negative edge and the trigger level as a trigger qualifier. When the oscilloscope detects the trigger qualifier, it will trigger at a user-specified number of edges (Count field) on the waveform. Count can be set to any integer from 1 to 32,000.

This type of triggering is commonly referred to as "events triggering" or "delay-by-events triggering". It is very useful when trying to trigger on a specific pulse in a burst of pulses, with a long time delay, before the next burst occurs.

The default value for the Count field is 1.

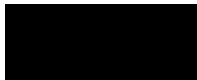

## Auto-Trig field

The Auto-Trig field allows you to specify whether or not the acquisitions should wait for the specified trigger condition to occur. When you select the Auto-Trig field, the field toggles between On and Off. The On and Off fields are discussed below.

The default selection for the Auto-Trig field is On.

### **On**

When you set auto-trigger to On, the oscilloscope waits 50 ms (20-Hz rate) for a trigger to occur. If a trigger does not occur within that time, the current contents of acquisition memory are displayed. The message "Auto triggered" is displayed if one of the following conditions occurs:

- No signal is on the input. In this case, the oscilloscope will display a baseline.
- There is a signal but the specified trigger condition has not been met within 50 ms. In this case, the waveform display will not be synchronized to a trigger point.

### **Off**

When you set auto-trigger to Off, the oscilloscope waits until a trigger is received before the waveform display is updated. If a trigger does not occur, the screen is not updated and the message "Waiting for Trigger" is displayed. Use this mode when:

- The trigger source signal has less than a 20-Hz repetition rate.
- The trigger events counter (refer to "Count field") is set so that the number of trigger events would not occur before 50 ms.
- When you want to trigger on a specific event only.

---

## When field

The When field appears only when Pattern mode is selected. When you select this field, a pop-up menu appears that lets you specify the trigger When condition.

### **Pattern When condition pop-up menu**

The Pattern When pop-up menu is used to specify the trigger-when condition for pattern triggering. The default selection for the When field is When Entered.

**When Entered** When this field is active, the oscilloscope triggers on the first transition that makes the pattern specification true for every input used in the pattern trigger specification. If the count set in the Count field is more than 1, the pattern must be true for the number of times set in the count field.

**When Exited** When this field is active, the oscilloscope triggers on the first transition that causes the pattern specification to be false for every input used in the pattern trigger specification. If the count set in the Count field is more than 1, the pattern must be true for the number of times set in the count field before turning false.

**Present >** When this field is active, the scope triggers on the first transition that causes the pattern specification to be false for any input used in the pattern trigger specification if the specified pattern has been true for the time duration specified. If the pattern specification becomes false before the specified duration time has elapsed, the search for a trigger condition starts again. If the pattern specification remains true longer than the specified duration time, the trigger point will be the point at which the pattern specification becomes false.

The pattern duration time can be any value between 20 ns and 160 ms in 10 ns steps.

If the count set in the Count field is one, the trigger event will be the first pattern event that meets both the pattern specification and the duration specification. If the count is greater than one, only the first pattern event must meet the duration specification. Once the pattern duration specification has been met, subsequent pattern events that meet the pattern specification can be of any duration and each such pattern event will contribute to meeting the count specification. For instance, with a pattern

**When field**

specification of HX, a duration specification of >100 ns, and a count of 3, a pulse string with pulse widths 80 ns, 150 ns, 50 ns, 75 ns, 20 ns, 200 ns would trigger on the trailing edge of the 75 ns pulse. In this example, the 150 ns pulse meets the duration specification and is count 1, the 50 ns pulse is count 2, and the 75 ns pulse is count 3.

**Present <** When this field is active, the scope triggers on the first transition that causes the pattern specification to be false for any input used in the pattern trigger specification if the specified pattern has been true for less than the time duration specified. If the pattern specification remains true after the specified duration time has elapsed, the search for a trigger condition starts again the next time the pattern specification becomes true. If the pattern specification becomes false before the specified duration time, the trigger point will be the point at which the pattern specification becomes false.

The pattern duration time can be any value between 20 ns and 160 ms in 10 ns steps.

If the count set in the Count field is one, the trigger event will be the first pattern event that meets both the pattern specification and the duration specification. If the count is greater than one, only the first pattern event must meet the duration specification. Once the pattern duration specification has been met, subsequent pattern events that meet the pattern specification can be of any duration and each such pattern event will contribute to meeting the count specification. For instance, with a pattern specification of HX, a duration specification of <100 ns, and a count of 3, a pulse string with pulse widths 200 ns, 80 ns, 150 ns, 50 ns, 75 ns, 20 ns would trigger on the trailing edge of the 50 ns pulse. In this example, the 80 ns pulse meets the duration specification and is count 1, the 150 ns pulse is count 2, and the 50 ns pulse is count 3.

**Range** When this field is active, the scope triggers on the first transition that causes the pattern specification to be false for any input used in the pattern trigger specification if the specified pattern has been true for greater than the first time value and less than the second time value that make up the pattern duration range.

If the pattern specification remains true for longer than the maximum duration range limit or becomes false before the minimum duration range limit, the search for a trigger condition starts again the next time the pattern specification becomes true. If the pattern specification becomes false within the specified duration time range, the trigger point will be the point at which the pattern specification becomes false.

The minimum pattern duration time can be any value between 20 ns and 160 ns in 10 ns steps. The maximum pattern duration time must be at least 10 ns greater than the minimum time value.

If the count set in the Count field is one, the trigger event will be the first pattern event that meets both the pattern specification and the duration specification. If the count is greater than one, only the first pattern event must meet the duration specification. Once the pattern duration specification has been met, subsequent pattern events that meet the pattern specification can be of any duration and each such pattern event will contribute to meeting the count specification. For instance, with a pattern specification of HX, a duration specification of >60 ns & <100 ns, and a count of 3, a pulse string with pulse widths 200 ns, 80 ns, 150 ns, 50 ns, 75 ns, 20 ns would trigger on the trailing edge of the 50ns pulse. In this example, the 80 ns pulse meets the duration specification and is count 1, the 150 ns pulse is count 2, and the 50 ns pulse is count 3.

---

## Count field

In pattern trigger mode, you can define a pattern as a trigger qualifier. When the oscilloscope detects the trigger qualifier, it will trigger when the number of patterns specified in the Count field have occurred on all inputs.

The Count field defines the number of events that must occur after the first trigger qualifier before the oscilloscope will trigger and acquire a waveform. Count can be set to any integer from 1 to 32,000. The default value for the Count field is 1.

---

## The Scope Marker Menu

The oscilloscope has two sets of markers that allow you to make time and voltage measurements. These measurements can be made either manually (voltage and time markers) or automatically (time markers only). The markers are accessed when you select the Markers choice on the oscilloscope menu pop-up.

The default selection for both the time and voltage Markers fields is Off.

---

### Manual time markers options

Turn on the time markers by selecting the T Markers field and choosing On from the pop-up menu. Three new fields appear to the right of the T Markers field: Tx to To, Trig to X, and Trig to O. These fields allow you to position the Tx (Time X) marker and the To (Time O) marker by entering time values for these markers.

#### **Tx to To field**

The Tx to To field displays the time difference between the Tx marker and the To marker. When you select the Tx to To field, turning the knob moves both the Tx and To markers across the display without changing the value in the Tx to To field. However, the values in the Trig to X and Trig to O fields will change to reflect the movement of the Tx and To markers.

You can change the value in the Tx to To field by changing the Trig to X or Trig to O values, or by changing the Tx to To value using the keypad.

When you change the time value of Tx to To by using the keypad, the difference between the new value and old value is split equally between Tx and To.

#### **Trig to X and Trig to O fields**

The trigger point is always Time 0. Resolution for Trig to X and Trig to O time values is 2% of the sweep speed(s/Div) setting. The default value for these fields is 0 s, the trigger point.

When you select the Trig to X field and turn the knob, the Tx marker will move across the display. As you move the marker, the time value in the Trig to X field changes. A negative time value indicates the marker is placed before the trigger point, and a positive time value indicates the marker is placed after the trigger point. The Trig to O field works similarly.

As you turn the knob when either the Trig to X or Trig to O field is selected, the time value in the Tx to To field also changes, showing the time difference between the Tx and To markers. If the time displayed in the Tx to To field is negative, the To marker is to the left of the Tx marker.

When you select the Tx to To field and turn the knob, the Tx and To markers will move in unison and maintain the preset Tx to To time value.

You can also change the Tx to To, Trig to X, and Trig to O fields with the pop-up keypad. Refer to the earlier paragraph entitled "Tx to To Field" for a description and results of keypad entries in the Tx to To field.

### **T Marker value display**

Any time the markers (either voltage or time) are turned on, the current marker settings may be displayed on the channel, trigger, display and auto-measure menus by using the Display Options field located to the right of the time base Delay field. The Display Options field provides a pop-up menu that allows you to either select to set channel labels or to view the Sample Period display or the Marker Value display.

The Marker Value display consists of two blocks. One contains settings for the voltage markers, the second contains settings for the time markers. If only one set of markers is turned on, only one of the two blocks will appear on the screen.

On the marker menu, if time markers are turned off, the Sample Period display will appear on the marker menu. If time markers are selected as either On or Auto, the Sample Period display is not visible on the Marker menu.

The Display Options field never appears on the Marker menu.



## Automatic time markers options

When you select the T Markers field, a pop-up menu appears. When you choose the Auto field in the pop-up a pop-up menu for automatic time marker measurements is displayed.

The automatic time marker measurements are made by setting the time markers to levels that are a percentage of the top-to-base voltage value of a waveform or to specific voltage levels. The top-to-base voltage value of a waveform is typically not the same as the peak-to-peak voltage value. The oscilloscope determines the top and base voltages by finding the flattest portions of the top and bottom of the waveform. The top and base values do not typically include preshoot or overshoot of the waveform. The peak-to-peak voltage is the difference between the minimum and maximum voltages found on the waveform.

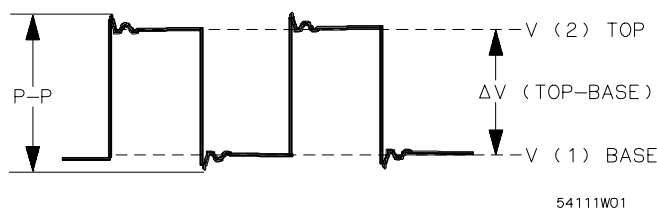

If the signal is clipped, the time markers will not be automatically placed.

When searching for the marker patterns, the search will occur only on that part of the waveform that is displayed, not the entire stored waveform.

The default Auto markers pop-up menu options are discussed in the following sections.

### Set on field

The Set on field assigns an input waveform to the Tx or To marker, or allows the marker to be set manually (with the MANUAL selection in the pop-up). When you select the Set on field, a pop-up appears showing the waveform sources available.

The default selection for the Set on field is the lowest letter and number combination.



### **Type field**

The Type field selects the units in which an automatic time marker level will be specified. The automatic time marker can have a level expressed as either a percentage of the waveform top-base voltage (Percent) or as an absolute voltage level (Absolute). The default selection is Percent.

### **at Level field**

When the marker type is Percent, the at Level field sets the Tx or To marker to a percentage level (from 10% to 90%) of the top-base voltage on the waveform selected by the Set on field. When you select the at Level field, you can change the percentage by turning the knob or by entering a value using the keypad. You can enter any percentage from 10% to 90% in increments of 1%.

When the marker type is Absolute, the at Level field sets the Tx or To marker to the specific voltage level. The allowable voltage range that can be selected is the vertical range for the selected channel (that is, offset  $\pm 2$  times v/div). You can enter any voltage from -12 V to 4 V in increments of 30 mV.

The default value for the at Level field is 50%.

The power-up default value for the at Level field is the selected channel offset value. If the vertical range parameters (for example: v/div, offset, probe factor) of a channel are changed such that the current at Level voltage is no longer valid, the at Level voltage will track the limit of the vertical range.

### **Slope field**

The Slope field sets the Tx or To marker on either the positive or negative edge of the selected occurrence of a waveform. When you select the Slope field, the slope toggles between Positive and Negative.

The default selection for the Slope field is Positive.

### **Occur field**

The Occur field sets the Tx or To marker on a specific occurrence of a displayed edge on the waveform. You can define the edge to be displayed all the way from the 1st edge up to the 100th edge. The count of edge occurrences is made starting with the first edge displayed on the screen.

Auto-marker measurements are made with data that is displayed on the screen. Make sure the data of interest is fully displayed on the screen.

Any number from 1 to 100 in increments of 1 can be entered. The default value for the Occur field is 1.

### **Statistics field**

The Statistics field allows you to make minimum, maximum, and mean time interval measurements from marker Tx to marker To. When you select the Statistics field, it toggles between On and Off. The default selection for the Statistics field is On.

**On** When Statistics is set to On, the minimum, maximum, and mean (average) Tx to To marker time interval data is accumulated and displayed to the right of the T Markers field until one of the following happens:

- Auto is deselected as the time marker option.
- Auto-marker parameters are changed.
- Statistics is set to Off.
- Run Repetitive mode is stopped.

**Off** When Statistics is set to Off, the Tx to To, Trig to X, and Trig to O fields appear next to the T Markers field on the Marker menu.

The marker statistics (minimum, maximum, and mean) are reset to zero only when you select the Done field on the auto-markers pop-up after making a change to one of the auto-marker placement specification fields (Set On, Type, Level, Slope, or Occur).

Other oscilloscope menu changes do not reset marker statistics, but may have an impact on the values computed for the marker statistics.

### **Run Until Time X-O field**

This field allows you to set up a stop condition for the time interval between the Tx marker and To marker. When the stop condition is met, the oscilloscope stops making acquisitions and displays the message "Stop condition satisfied." You define the stop conditions with selections you make after you select the Run Until Time X-O field. The default selection for this field is Off.

The Run Until Time X-O feature is only valid if the Run field is set to Repetitive.

**Less Than field** When you select this field from the pop-up, a time value field appears next to the Run Until Time X-O Less Than field. The time value field default value is 0 seconds.

Resolution is 10 ps up to  $\pm 99.99$  ns, and can be set to 5-digit resolution otherwise. Positive times are used when the Tx marker is displayed before the To marker, and negative times are used when the To marker is displayed before the Tx marker.

When you select Less Than, the oscilloscope runs until the Tx-To time interval is less than the value entered for the Less Than time field. When the condition is met, the oscilloscope stops making acquisitions and displays the message "Stop condition satisfied."

**Greater Than field** When you select this field from the pop-up, a time value field appears next to the Run Until Time X-O Greater Than field. The time value field default value is 0 s. When you select the time value field, you can enter the time in the same manner as for the Less Than field.

When you select Greater Than, the oscilloscope runs until the Tx-To time interval is greater than the value entered for the Greater Than time field. When the condition is met, the oscilloscope stops making acquisitions and displays the message "Stop condition satisfied."

**In Range field** When you select this field from the pop-up, two time value fields appear next to the Run Until Time X-O In Range field. You need to enter the time range values for the stop condition in these two time fields. Select each time value field, in turn, and enter the time value in the same manner as for the Less Than field.

When you select In Range, the oscilloscope runs until the Tx-To time interval is in the range of the time values entered for the In Range time fields. When the condition is met, the oscilloscope stops making acquisitions and displays the message "Stop condition satisfied."

**Not In Range field** When you select this field from the pop-up, two time value fields appear next to the Run Until Time X-O Not In Range field. You need to enter the time range values for the stop condition in these two time fields. Select each time value field, in turn, and enter the time values in the same manner as for the Less Than field.

When Not In Range is selected, the oscilloscope runs until the Tx-To time interval is not in the range of the time values entered for the Not In Range time fields. When the condition is met, the oscilloscope stops acquisitions and displays the message "Stop condition satisfied."

## Manual/Automatic Time Markers option

The manual/automatic combination allows you to have one time marker set to automatic mode and one time marker set to be controlled manually with the knob.

### **Setting the Manual/Automatic Time Markers Option**

To set the manual/automatic option, you select the T Markers field and choose the Auto field from the pop-up. You then select the Set on field for either the Tx or To marker, and then choose MANUAL from the pop-up menu.

When you choose Done in the auto-markers pop-up menu, you return to the waveform display. Now when you select the T Markers field again and choose On from the pop-up menu, the marker you selected with the MANUAL field is set to the manual mode and the other marker is set to fall on the parameters you set while in the automatic mode.

---

## Voltage Markers options

When you select the V Markers field on the display, a pop-up menu appears. When you select the On field in the pop-up to turn Voltage Markers On, you can manually move the Va and Vb markers to make voltage measurements.

When you select the On field in the V Markers menu, five new fields appear to the right of the V Markers field: Va On, Va Volts, Vb On, Vb Volts, and Va to Vb fields. These fields allow you to position the Va marker and the Vb marker by entering channel numbers and voltage levels for these markers.

If you turn the voltage markers on while the time markers are also turned on, the voltage levels that correspond to the time marker waveform crossings will be deleted from the channel label field. If you turn the voltage markers off while the time markers are turned on, the voltage levels that correspond to the time marker waveform crossings will appear in the channel label field.

### **Va On field**

The Va marker is shown on the waveform display as a horizontal dashed line.

The Va On field assigns the Va marker to one of the oscilloscope acquisition channels. The default channel is channel 1.

---

The channel selected for assignment to the Va marker does not have to be displayed in the waveform area. If the selected waveform is not in the waveform area of the screen, the Va marker will not be displayed. If there are multiple occurrences of the selected waveform in the waveform area of the screen, only the uppermost occurrence of the waveform will display the Va marker.

Overlay and waveform math traces cannot be selected for voltage marker placement.

The Vb On field works similarly.

### **Va Volts field**

The Va marker is shown on the waveform display as a horizontal dashed line. The voltage displayed in the Va Volts field is measured relative to the zero-volt reference for this channel.

When you select the Va Volts field, you can change the voltage value by turning the knob or by entering a voltage value from the pop-up keypad. The range of voltage levels for the Va Volts field is  $\pm 2$  times maximum range for the selected channel. The maximum range value is affected by the probe factor and v/div settings.

The Vb Volts field works similarly.

### **Va to Vb field**

This field displays the difference between the Va and Vb markers. This value is dependent on channel selections and represents Vb minus Va.

### **Center Screen Field**

The Center Screen field appears on the right side of the Marker menu. The Center Screen field centers the screen on the chosen timebase marker.

If time markers are turned off, the only marker choice available on the Center screen pop-up will be the trigger marker. If time markers are turned on, the Tx and To markers will also appear in the Center Screen pop-up menu. If the auto time markers are enabled, only the trigger marker appears in the Center Screen pop-up menu.

Selecting one of the possible time markers for centering the waveform data will cause the timebase delay value to be changed such that the selected marker is positioned at the center of the screen. All acquisition channels are shifted when the trace data is centered. The timebase delay field value will be updated when the centering operation is performed.

### **V Marker value display**

Any time the markers (either voltage and/or time) are turned on, the current marker settings may be displayed on the channel, trigger, display and auto-measure menus by using the Display Options field located to the right of the timebase Delay field. The Display Options field provides a pop-up menu that allows you to either select channel labels or to view the Sample Period display or the Marker Value display.

The Marker Value display consists of two blocks. One contains settings for the voltage markers, the second contains settings for the time markers. If only one set of markers is turned on, only one of the two blocks will appear on the screen.

On the marker menu, if time markers are turned off, the Sample Period display will appear on the marker menu. If time markers are selected as either On or Auto, the Sample Period display is not visible on the Marker menu.

The Display Options field never appears on the Marker menu.

---

## **Channel Label field**

The channel label field is the field to the left of the waveform display. When you turn time markers on with voltage markers off, the voltage values where the Tx and To markers intersect each waveform are displayed under each channel label.

---

# The Scope Auto Measure Menu

One of the primary features of the oscilloscope is its ability to make parametric measurements on displayed waveforms. This section provides details on how automatic measurements are performed and gives some tips on how to improve automatic measurement results.

There are nine automatic measurements available in the automatic measurement menu:

Period	Frequency	Vp_p
Risetime	+Width	Preshoot
Falltime	-Width	Overshoot

There are two Automatic-Measurement fields. They are the Input field and the actual automatic measurement display. These fields are discussed in the following paragraphs.

---

## Input field

The Input field allows you to select the source of the waveform to be measured. When you select this field, a pop-up menu appears which shows the input sources. Make sure the proper source is selected for the input you are using.

---

## Automatic measurements display

The large field in the middle row of the menu is called the automatic measurements display. This display shows the nine automatic measurements and their values.

### See Also

"Automatic Measurement Algorithms" at the end of this section for an explanation of each of these fields.

### **Measurement setup requirements**

Measurements typically should be made at the fastest possible sweep speed in order to obtain the most accurate measurement possible. You can only make automatic measurements with data that is currently being displayed in the waveform display area. Keep the following in mind when making measurements:

- At least one full cycle of the waveform, with at least two like edges, must be displayed for Period and Freq measurements.
- A complete positive pulse must be displayed to make a +Width measurement.
- A complete negative pulse must be displayed to make a –Width measurement.
- The leading (rising) edge of the waveform must be displayed for Risetime, and rising edge Preshoot and Overshoot measurements.
- The trailing (falling) edge of the waveform must be displayed for Falltime, and falling edge Preshoot and Overshoot measurements.
- Risetime, Falltime, Preshoot, and Overshoot measurements will be more accurate if you expand the edge of the waveform by selecting a faster sweep speed.
- If the signal is clipped, the automatic measurements cannot be made.

### **Criteria used for making automatic measurements**

If more than one waveform, edge, or pulse is displayed, the measurements are made on the first (leftmost) portion of the displayed waveform that can be used. When any of the defined measurements are requested, the oscilloscope first determines the top (100%) and base (0%) voltages of the waveform. From this information, it can determine the other important voltage values (10% voltage, 90% voltage, and 50% voltage) required to make the measurements. The 10% and 90% voltage values are used in the rise time and fall time measurements. The 50% voltage value is used for measuring frequency, period, and pulse width.



---

## Automatic measurement algorithms

The following explains top and base voltages, then defines the measurement algorithms.

### Top and base voltages

All measurements except  $V_{p-p}$  are calculated using the  $V_{top}$  (100% voltage) and  $V_{base}$  (0% voltage) levels of the displayed waveform. The  $V_{top}$  and  $V_{base}$  levels are determined from an occurrence density histogram of the data points displayed on the screen.

The digitizing oscilloscope displays 8-bit vertical voltage resolution. In other words, the vertical axis of the display is divided into  $2^8$  voltage levels. Each of these 256 levels is called a quantization level. Each waveform has at least 500 data points displayed on the horizontal axis of the screen. Each of these data points has one quantization level assigned to it. The histogram is calculated by adding the number of occurrences of each quantization level of all displayed points on the displayed waveform.

The quantization level with the greatest number of occurrences in the top half of the waveform corresponds to the  $V_{top}$  level. The quantization level with the greatest number of occurrences in the bottom half of the waveform corresponds to the  $V_{base}$  level.

If  $V_{top}$  and  $V_{base}$  do not contain at least 5% of the 500 data points displayed on screen,  $V_{top}$  defaults to the maximum voltage ( $V_{maximum}$ ) and  $V_{base}$  defaults to the minimum voltage ( $V_{minimum}$ ) found on the display. An example of this case would be measurements made on sine or triangle waves.

From this information, the instrument can determine the 10%, 50%, and 90% points, which are used in most automatic measurements. The  $V_{top}$  or  $V_{base}$  of the waveform is not necessarily the maximum or minimum voltage present on the waveform. If a pulse has a slight amount of overshoot, it would be wrong to select the highest peak of the waveform as the top because the waveform proper rests below the perturbation.

### Measurement algorithms

**Frequency (Freq)** The frequency of the first complete cycle displayed is measured using the 50% levels.

If the first edge on the display is rising, then

$$\mathbf{Freq} = \frac{1}{t_{\text{rising edge 2}} - t_{\text{rising edge 1}}}$$

If the first edge on the display is falling, then

$$\mathbf{Freq} = \frac{1}{t_{\text{falling edge 2}} - t_{\text{falling edge 1}}}$$

**Period** The period is measured at the 50% voltage level of the waveform.

If the first edge on the display is rising, then

$$\mathbf{Period} = t_{\text{rising edge 2}} - t_{\text{rising edge 1}}$$

If the first edge on the display is falling, then

$$\mathbf{Period} = t_{\text{falling edge 2}} - t_{\text{falling edge 1}}$$

**Peak-to-Peak Voltage (Vp\_p)** The maximum and minimum voltages for the selected source are measured:

$$\mathbf{Vp\_p} = V_{\text{maximum}} - V_{\text{minimum}}$$

where  $V_{\text{maximum}}$  and  $V_{\text{minimum}}$  are the maximum and minimum voltages present on the selected source.

**Positive Pulse Width (+Width)** Pulse width is measured at the 50% voltage level.

If the first edge on the display is rising, then

$$\mathbf{+Width} = t_{\text{falling edge 1}} - t_{\text{rising edge 1}}$$

If the first edge on the display is falling, then

$$\mathbf{+Width} = t_{\text{falling edge 2}} - t_{\text{rising edge 1}}$$

**Negative Pulse Width (-Width)** Negative pulse width is the width of the first negative pulse on screen using the 50% levels.

If the first edge on the display is rising, then

$$\mathbf{-Width} = t_{\text{rising edge 2}} - t_{\text{falling edge 1}}$$

If the first edge on the display is falling, then

$$\mathbf{-Width} = t_{\text{rising edge 1}} - t_{\text{falling edge 1}}$$

**Rise time** The rise time of the first displayed rising edge is measured. To obtain the best possible measurement accuracy, set the sweep speed as fast as possible while leaving the full leading edge of the waveform on the display. The rise time is determined by measuring time at the 10% and 90% voltage points on the rising edge:

$$\mathbf{Rise\ time} = t_{90\%} - t_{10\%}$$

**Fall time** Fall time is measured between the 10% and 90% points of the falling edge. To obtain the best possible measurement accuracy, set the sweep speed as fast as possible while leaving the falling edge of the waveform on the display:

$$\mathbf{Fall\ time} = t_{10\%} - t_{90\%}$$

**Preshoot and Overshoot** Preshoot and Overshoot measure the perturbation on a waveform above or below the top and base voltages (see the "Top and Base Voltages" section earlier in this chapter). These measurements use all data displayed on the screen; therefore, it is very important that only the data of interest be displayed. If you want to measure preshoot and overshoot on one edge of a waveform, then only display that edge. If you want to measure the maximum preshoot and overshoot on a waveform, then display several cycles of the waveform.

Preshoot is a perturbation before a rising or a falling edge and is measured as a percentage of the top-base voltage.

Overshoot is a perturbation after a rising or a falling edge and it is measured as a percentage of the top-base voltage.

If the measured edge is rising, then

$$\mathbf{Preshoot} = \left[ \frac{V_{base} - V_{minimum}}{V_{top} - V_{base}} \right] \times 100$$

and,

$$\mathbf{Overshoot} = \left[ \frac{V_{maximum} - V_{top}}{V_{top} - V_{base}} \right] \times 100$$

If the measured edge is falling, then

$$\mathbf{Preshoot} = \left[ \frac{V_{maximum} - V_{top}}{V_{top} - V_{base}} \right] \times 100$$

and,

$$\mathbf{Overshoot} = \left[ \frac{V_{base} - V_{minimum}}{V_{top} - V_{base}} \right] \times 100$$





---

## System Performance Analysis (SPA) Software

---

# System Performance Analysis Software

The System Performance Analysis (SPA) software is included as standard software in the HP 1660C/CS-series and HP 1670A-series logic analyzers. It was originally HP 10390A System Performance Analysis (SPA) Software, a software package for the HP 16550A logic analyzer module and the HP 1660A/AS-series logic analyzers.

SPA provides you with a set of functions for performing statistical analysis on your target system. Its functions include State Overview, State Histogram, and Time Interval modes.

To be successful with this software, you should be familiar with the operation of the logic analyzer.

The screen shots shown in this chapter are HP 16550A screens. If you are using an HP 1660- or HP 1670-series logic analyzer, your screens will be similar. This chapter is organized as follows:

- "What is System Performance Analysis?" outlines typical SPA applications, and describes the operating characteristics for each SPA mode.
- "Getting Started" describes how to access the SPA menus and how to select the SPA modes and set the specifications.
- "SPA Measurement Processes" is a detailed description of the measurement processes used by the SPA package. This theory of operation explains how the SPA software samples and sorts the data from the target system, and how the on-screen measurement values are computed for the State Overview, State Histogram, and Time Interval modes.
- "Using State Overview, State Histogram, and Time Interval" leads you through the State Overview, State Histogram, and Time Interval modes. It also tells how to set up SPA for the three modes, how to interpret the acquired data, and how to make measurements on specific areas of interest.
- "Using SPA with Other Features" tells you how to use SPA with other features.

Error messages and warnings used by SPA are the same as those used by the logic analyzer. Refer to "Troubleshooting," Chapter 10, for descriptions of these messages.

If you are just getting started, the first two sections are recommended reading. Part 3 is optional. If you are an experienced user, the last sections will help you with your SPA measurements. Use the first three sections for review when necessary. If you need programming information, refer to the *HP 1670A-Series Logic Analyzers Programmer's Guide*, available from your HP sales office.



## What is System Performance Analysis?

The logic analyzer's state or timing analyzer is used to make quantitative measurements on specific events in the target system. For example, they can measure a specific time interval on a microprocessor's control lines or can find out how a particular subroutine was called.

System Performance Analysis, on the other hand, is used for qualitative measurements on the target system. SPA provides statistical analysis functions so you can determine how efficiently your target system is operating.

SPA repeatedly samples signals of interest, such as an address bus or the output of a counter. The multiple data sets from the repeated sampling are then used to build histograms and to compile statistics that describe your target system's performance over time.

Some typical examples of SPA applications include

- Obtaining an overview of system activity.
- Identifying software problems that lock up the microprocessor.
- Determining the best-case and worst-case execution times for a software module or a state machine.
- Establishing standards for software modules or state machines.
- Identifying inefficient use of mass storage and other peripherals.
- Evaluating memory utilization, such as illegal access in protected portions of memory, and locality of execution.

### **Operating characteristics**

The following describes the operating characteristics of the System Performance Analysis software for the three SPA measurement modes.

**State Overview** The State Overview mode displays a bar chart of a label's state value versus the relative number of occurrences of each value in the defined range of the label. State Overview is available on any label defined in the Format Specification.

- The X axis is the defined range for the specified label divided into 256 buckets.
- The range of the specified label is user-definable.



- The Y axis is the relative number of occurrences in each bucket.
- Maximum value of the Y axis is constantly updated to reflect the number of occurrences in the bucket that has the most occurrences, and is displayed as "Max count."
- The total number of states sampled for the selected label is presented as Total count. This includes states that may be outside the user-specified X axis range.
- Two markers are available on the X axis to determine the range of a bucket and number of occurrences in any bucket.
- Choice of base for a specified label is user-definable.

**State Histogram** The State Histogram mode displays states that occur within user-defined ranges of a label. State Histogram is available on any label defined in the Format Specification.

- Maximum number of ranges is 11.
- Other States included/excluded is available and displays a histogram of all states not covered by the user-defined ranges.
- You can tTrace All States or pattern Qualified States.
- Total samples displays the total number of occurrences in all displayed ranges.
- Choice of base for specified label is user-definable.

**Time Interval** The Time Interval mode displays time intervals between user-defined start and end events.

- Start and end events can be defined over all labels defined in the Format Specification.
- 10 ns is the minimum sample period and time interval resolution.
- The maximum number of time interval ranges is 8.
- Time interval range size is 10 ns to 9,999,999 seconds.
- Calculated statistics provides Maximum time, Minimum time, Average time, and Total number of time intervals sampled (one time interval defined to be a paired start/end event).
- Auto-range feature automatically scales the eight time intervals over maximum and minimum times using a logarithmic scale or linear scale.
- Choice of base for labels is user-definable.

---

## Getting started

This section describes how to access the System Performance Analysis (SPA) menus. Also, it describes selecting the SPA modes and setting the specifications.

### Accessing the menus

The SPA menus are accessed through the Analyzer Configuration menu. When the configuration menu is displayed, select the Type field and choose SPA from the pop-up.

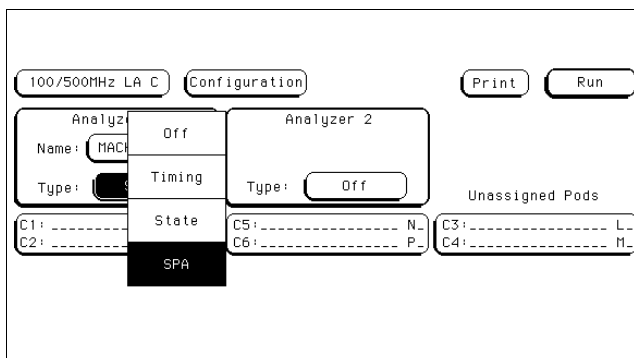

### Configuring an analyzer for SPA

#### Selecting State Overview, State Histogram, or Time Interval modes

To access one of the three SPA modes, select the analyzer menu field after configuring one of the analyzers as SPA and select SPA.

Once in the SPA menu, you can move from State Overview, State Histogram, or Time Interval Modes by selecting the Trace Mode field as shown in the SPA menu on the next page. A pop-up menu appears, and you can select one of the three SPA modes in the pop-up.

If you change modes while the logic analyzer is acquiring data, it will stop the acquisition.

### Setting up the State Format specification

When a State or Timing analyzer is changed to SPA, SPA will retain the State or Timing Format specification. For complete details on changing from a State or Timing Analyzer to SPA, see "Using SPA with other features."

The State and Timing format specification menus provide symbol tables. You can use any defined symbols to specify the Low and High values in State Overview, to define the ranges and the qualified states in State Histogram, or to specify the Start and End conditions in Time Interval.

Your ability to use existing State or Timing configurations with SPA depends on your application and target system. If your SPA measurement uses the same physical signals from the target system as an existing State or Timing configuration, it may be easier to load the state or timing configuration from the disk instead of entering a new one.

This manual assumes you already have a basic understanding of the Analyzer Format menu, and it will not be covered here.

The screenshot shows the 'Default SPA menu' interface. At the top, there are buttons for '100/500MHz LA C', 'SPA 1', 'Print', and 'Run'. Below these are 'Trace Mode' and 'State Overview' buttons. To the right are 'Label' (set to 'Lab1'), 'Base' (set to 'Hex'), 'X marker' (set to '0100'), and '0 marker' (set to '0000'). Below these are 'Low value' (set to '0000') and 'High value' (set to 'FFFF') fields. The main area contains a vertical list of counts: 'Max count' (0), 'X Mark count' (0), '0 Mark count' (0), and 'Total count' (0). A large empty rectangular box is positioned to the right of these counts.

Default SPA menu

## SPA measurement processes

This section introduces you to the measurement processes of the System Performance Analysis (SPA) software. It tells you how to select the appropriate trace mode and labels. It also explains how SPA samples and sorts data.

### **Selecting and changing trace modes**

SPA has three trace modes: State Overview, State Histogram, and Time Interval. These are selected by the Trace Mode field in the SPA data display.

Only the currently displayed trace mode is affected during an acquisition. While acquiring and viewing data in one trace mode, the other two trace modes are not updated. If the trace mode or any other critical variable is changed during an acquisition, the logic analyzer stops the acquisition and displays "Warning: Run HALTED due to variable change."

Each trace mode only performs statistics on its own database. Therefore, if acquisitions are completed in two different trace modes, the two modes will not contain the same data.

For example, you select the State Overview mode and press the Run key. After the data accumulates for a period, press Stop. You then select the Time Interval mode and the screen is blank since no data has been acquired in this mode. You again press Run and let data accumulate and press Stop. In this example, two separate data sets are acquired, the first for State Overview mode, the second for Time Interval. You can now move between the modes and see the correct data for the associated measurement.

This separate acquisition data applies to all three trace modes. In this way, three separate views of the target system can be acquired and stored in SPA.

### **Sampling methods and data sorting**

SPA provides a statistical summary of target system behavior over time. The greater the number of samples, the more accurate the statistics. Therefore, SPA should always be run in the Repetitive mode. By doing this, the analyzer will continue to sample the data and update the display until Stop is **pressed** or until a **sampling variable is changed on the display**.

After SPA completes an acquisition, each sample in the current acquisition is compared to the ranges or buckets for the current trace mode. If the sample matches a range or bucket, it is sorted into that range or bucket. This process is repeated for every sample in the acquisition. After the entire acquisition

has been sorted, the histograms and displayed statistics are updated, and the analyzer is re-armed for the next acquisition.

Refer to the following sections on the three trace modes for details on sorting criteria and statistical computation.

Between each successive acquisition, there is blind time during which the captured data is unloaded and sorted, the display is updated, and the analyzer is restarted. The length of the blind time is a function of the complexity of the SPA measurement.

### Selecting and changing labels

A label in Hewlett-Packard logic analyzers is defined in the Format menu. A label is any named group of 32 or fewer data channels.

The State Overview and State Histogram modes monitor one label at a time. Any labels that are defined in the Format Specification are available. A typical example is the ADDR (address) label used in many of the Hewlett-Packard inverse assembler configurations. Often, SPA measurements will use the ADDR label to monitor memory activity.

Qualified State Histogram and Time Interval modes use all of the labels in the Format Specification to define either the qualified state or the start and stop events, respectively. While State Overview and State Histogram deal with recorded states, Time Interval deals with time.

Changing from one label to another in State Overview or State Histogram mode or changing the Start or End pattern in Time Interval erases any configuration and data for the original label. When returning to the original label, the display returns to its default mode. Loss of configurations and data when changing between labels can be prevented by saving configurations of interest to the disk before making the change, or by printing the results.

### State Overview mode

State Overview mode is an X-versus-Y chart of the activity on a specified label. It provides a global view of the distribution of activity of the target system signals grouped under the specified label.

**X axis scaling** The X axis represents the defined range of the specified label and is divided into a series of buckets, or smaller ranges. The range of the X axis is defined by the Low value and High value fields, and is

divided equally among 256 buckets. For example, if the range defined by the low and high values is 1100, then 1100 divided by 256 equals 4.29. This value will be rounded up to 5, each bucket will have a range of 5, and only 220 buckets will be used ( $1100/5 = 220$ ). The display grid will be truncated on the right because only 220 buckets are displayed.

If the full range of the label or the portion of the label defined by the Low value and High value is less than 255, then the number of buckets will be the difference between the Low and High values.

The Low and High values can be specified as discrete values in Binary, Octal, Decimal, or Hexadecimal. If Symbols have been defined in the Format Specification, they can also be used for the low and high values.

**Data sampling and sorting** When Run is pressed, all input channels defined in the Format Specification are sampled. Once acquired, the sampled data is sorted into the buckets of the specified label, and the State Overview display is updated. The acquisition is repeated until Stop is pressed or until a display variable is changed.

**Y axis scaling** The display builds a vertical histogram where the Y axis represents the relative number of occurrences in each of the buckets. As successive acquisitions are acquired and sorted, the display is constantly re-scaled vertically so that the upper limit of the Y axis represents the largest number of occurrences in any bucket.

The Y axis maximum limit is displayed in Max count.

**Total count** The Total count field is the total number of states sampled over the entire label range since the measurement was started.

**X and O markers** Markers can be placed on any bucket to determine the number of occurrences in that bucket. The X Mark count and O Mark count fields display the number of occurrences at the markers. The markers move only on the bucket boundaries.

The range of each bucket can be determined by selecting the X marker or O marker fields and noting the change in the marker value in the pop-up as the marker is moved slowly across the display.

**Example**

**State Overview example**

An example of a State Overview measurement is testing for access to a reserved area of memory. In this case, the address bus of the target system would need to be grouped under a single label, such as ADDR. By selecting the ADDR label in State Overview mode, and by defining the full range of the label (Low value = 0000, High value = FFFF with a 16-bit ADDR label), activity over the entire address range can be monitored. Access into reserved memory is easily identified.

By selecting only the range of the reserved area of memory with the Low and High values, the number of address values per bucket is decreased and a more detailed analysis can be performed.

The figure below shows a State Overview display.

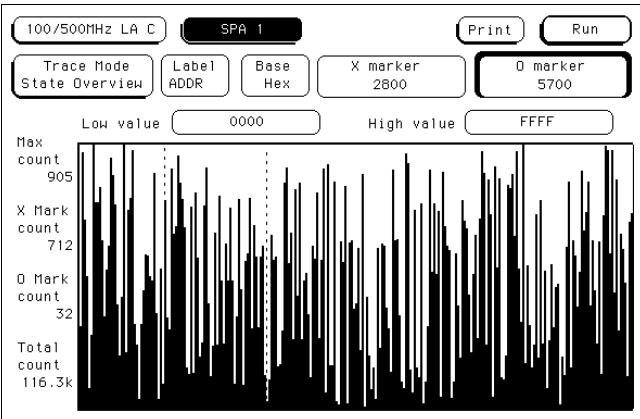

SPA State Overview menu

### **State Histogram mode**

State Histogram mode displays relative activity of ranges of a specified label. The ranges can also be compared to activity on the rest of the label not defined in the ranges. Data qualification is possible with State Histogram, so data can be filtered during acquisition.

**Data sampling and sorting** When Run is pressed, all input channels defined in the Format Specification are sampled. Once acquired, each sample in the acquisition is compared to each defined range. If the sample value is inclusively within the range and if the range is on, the count for that range is incremented, then the State Histogram display is updated. The acquisition is repeated until Stop is pressed or until a display variable is changed.

The histogram is displayed on a percentage scale, and each bar represents the fraction of all samples in that range. For example, if a bar reaches the 40% value on the display, then the range for that bar contains 40% of all the samples displayed. If the total of all bars equals greater than 100%, then ranges have been overlapped and data has been counted twice.

**State Histogram vs. State Overview** State Histogram is similar to State Overview, but there are key differences between the two modes. State Overview shows relative distribution of activity over a single contiguous range of a label. State Histogram also allows several non-contiguous ranges of a label to be defined.

State Overview requires minimal setup, and provides a quick overview of system activity. State Histogram requires more setup, but provides greater resolution and measurement flexibility.

State Overview mode does not display data that falls out of the range of its Low and High values. State Histogram, on the other hand, has an "Other States included/excluded" feature that will present a histogram of any activity that does not fall into the defined ranges (see "Other States Included/ Excluded," later in this section).

State Overview samples and displays all activity on the specified label. But State Histogram allows data qualification so that only activity of interest is sampled and displayed (see "Trace Type: All States vs. Qualified States," later in this section).

**Range specifiers** Up to 11 ranges are available. The ranges are defined by specifying a low and high value on the specified label and by a name you define. The ranges need not be contiguous. If two ranges overlap in any manner, acquired data will be counted in both ranges.



If a range has a low and high value and a name defined, and the range is turned off, it will retain the low and high value and name when turned back on.

**User-defined ranges vs. symbols** When defining low and high values for the State Histogram ranges, you may use symbols instead of entering discrete values. Symbols can only be used for labels selected in the State Histogram mode if they are defined in the Format Specification, and only if the base in the State Histogram menu is set to Symbol.

Pattern or range symbols defined in the Format Specification can be used to set the low or high value of a range.

**Total samples** The total samples field displays the total number of samples in all the displayed ranges. If Other States included is selected, then total samples is the total of all displayed samples plus the other states. If any ranges are overlapped and samples fall in multiple buckets, these samples are only counted once in total samples.

**Number of samples per range** Displayed next to each bar is a value representing the number of samples for that range. The ratio of these values to total samples determines the relative size of the histograms. These values are updated as the repeated acquisitions are sorted and displayed.

**Other States included/excluded** Usually the defined ranges will not cover the entire range of the specified label. The Other States included/excluded field provides an optional histogram showing all activity on the specified label that does not fall within any of the defined ranges. By selecting excluded, the relative activity of only the defined ranges is displayed. If included is selected, the "other" histogram appears under the ranges.

If a range is turned off, any activity in that range is included in Other States. The activity of a turned off range is included in the other range whether included or excluded other states is displayed or not.

**Trace Type: All States vs. Qualified States** State Histogram mode can qualify data as it is sampled. Qualifying data while sampling allows only data of interest to be stored, while the rest is thrown away.

When Trace Type is set to Qualified States, a new field appears in the upper row of the display. The new field, Specify States, is where the data qualification is defined. The data qualification is not limited only to the label selected in the State Histogram menu. It is defined over all labels defined in

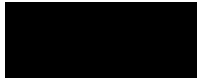

the Format Specification as a combination of values, in the current base, and don't cares.

For example, a microprocessor target system memory may contain two arrays. In State Histogram, the address ranges of the arrays can be defined and the relative activity in the arrays monitored. But, what if you only want to monitor writes to the array? In this case, you can define the data qualification as "Memory Write" on the STATUS label.

States that do not meet the qualification criteria are not stored by the analyzer, so they are not included in Other States.

---

**Example**

**State Histogram example**

A computer system has several I/O devices, such as a data terminal, disk drive, tape drive, and printer. Each device has its own service routines stored in memory. The problem is that one or more of the devices is tying up the CPU.

The address bus of the system is monitored using State Histogram to define the memory blocks where the service routines are stored. The histograms quickly show that the print spooler is not working because the printer is constantly interrupting the CPU and is consuming 80% of address bus activity.

The figure below shows a sample State Histogram display.

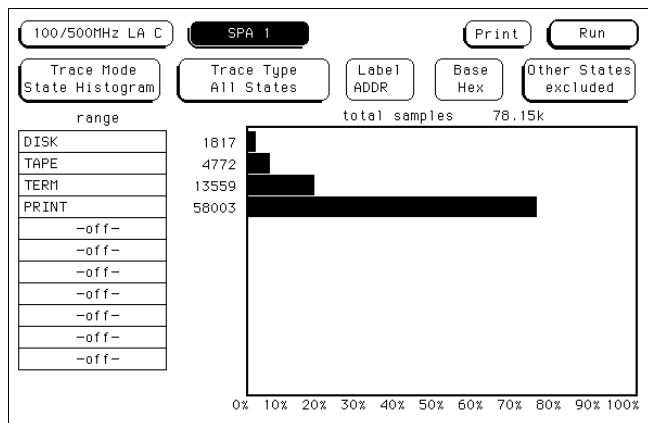

**SPA State Histogram menu**

### **Time Interval mode**

Time Interval mode shows distribution of execution time of a single event. The event is defined by specifying Start and End conditions as patterns across all labels defined in the Format Specification.

**Data sampling and sorting** When you press Run, the analyzer samples the target system using the definitions entered in the Format Specification. During acquisition, the state analyzer searches the data for the start and end conditions, and uses the analyzer's time tag feature to time the event. The time durations for each Start/End pair are then sorted into user-definable time interval ranges on the display. The acquisition is repeated until Stop is pressed or until a display variable is changed.

Because time tags are not available in the half-channel mode as specified in the Format menu, time interval mode will not function when half-channel mode is selected.

After the data is sampled, timed, and sorted, the histogram for each time interval range is updated.

If two time intervals are adjacent and have a common boundary (the upper limit of one equals the lower limit of the next), and a sampled time interval falls on the common boundary, the sample will be sorted into the higher time interval.

**Start/End conditions** Start and end conditions for Time Interval are specified on all labels defined in the Format Specification as a combination of values, in the current base, and don't cares.

If a start or end condition is not found during an acquisition, the histogram will not change. The analyzer will only update when a start and stop event are both found.

Start and end conditions need not be adjacent in the data stream. For example, when the state analyzer sees the specified start condition, it starts the timer. If the start condition occurs again before the end condition occurs, the timer will not be reset.

For measurement purposes, the analyzer measures the time between the first occurrence of the start condition and the first occurrence of the stop condition.

**Time Interval ranges** Up to 8 time interval ranges are available. Each range has a lower and upper limit which can be entered manually. The

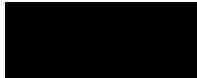

Auto-range feature will automatically scale the eight ranges. The minimum allowable limit is 0 ns, the maximum 9,999,999 seconds.

Ranges do not have to be contiguous. However, gaps between ranges increase the risk of missed data. If two ranges overlap, data will be counted in both ranges. This applies to any number of overlapping ranges, or any portions of overlapping ranges. Common boundaries of adjacent ranges are not considered to be overlapped.

A range can be turned off by setting the lower and upper values to zero.

**Auto-range** The Time Interval ranges can be scaled quickly by selecting "Auto-range." This option requires a global Minimum time and Maximum time for the eight time interval ranges. The eight ranges are then scaled using either a log scale or linear scale.

All the ranges may be quickly initialized to off by selecting Auto-range, setting Minimum time and Maximum time to zero, and performing a linear scale.

The smallest increment allowable using Auto-scale is 10 ns. If the time interval defined by the minimum and maximum times is too small to allow all 8 ranges to be scaled, Auto-range will scale as many as possible and exclude some upper time interval ranges. The maximum resolution of each time interval is 10 ns.

**Min, Max, and Avg Time Statistics** The Time Interval mode display shows three statistics: Maximum (Max) time, Minimum (Min) time, and Average (Avg) time. These values are displayed whether or not they fall into any of the time interval ranges. Therefore, they are helpful in determining if the appropriate time intervals have been chosen.

The maximum resolution of the statistics is 8 ns.

**Total samples** Total samples is displayed above the histogram. A sample is defined as one Start/End pair. The Total samples field is not updated until the analyzer's memory is full or until Stop is pressed.

**Example**

**Time Interval example**

A team of applications programmers is writing a math package for a spreadsheet. They need to develop standards for the various math functions. Using time interval mode, they can test the execution time of each of the math functions.

For each math function, they enter the starting and ending addresses in the Time Interval menu. They run the math function while monitoring its execution time with their logic analyzer in the Time Interval mode. Using Auto-range, they can quickly vary the time interval ranges for either greater time coverage or greater time resolution.

If the programmers wanted to see the details of the time intervals, they could set up a state analyzer measurement (not using SPA) and capture the activity between the start and stop events. The details could then be viewed in the state listing menu.

The figure below shows a sample Time Interval menu and its display.

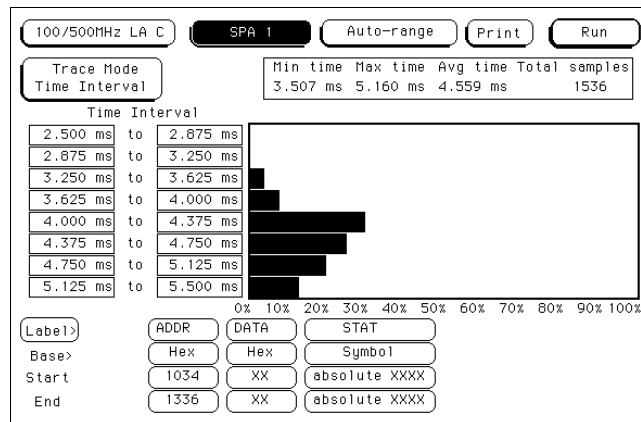

**SPA Time Interval menu**

### Measurement example using all three trace modes

In a 32-bit microprocessor system, you want to determine how efficiently the CPU is being utilized. Critical questions might be: are any processes consuming excessive processing time, are any processes getting stuck in wait loops, and is the system handling service calls and interrupts efficiently?

You connect the HP logic analyzer to the address bus of your system. In the Format Specification, you define a 32-bit label called ADDR and the state clocking. In many cases, HP provides preprocessors, inverse assemblers and standard configurations for popular microprocessors, and you need not enter the configuration manually or worry about probing issues.

In the State Overview mode, you select the ADDR label and start the acquisition to monitor the entire memory space. After several acquisitions, five areas of relatively high activity begin to build on the histogram. Using the X and O markers to determine the address boundaries of these five regions, you quickly recognize two programs, a delay routine in the operating system kernel, and a keyboard interrupt routine. The figure below shows the State Overview display.

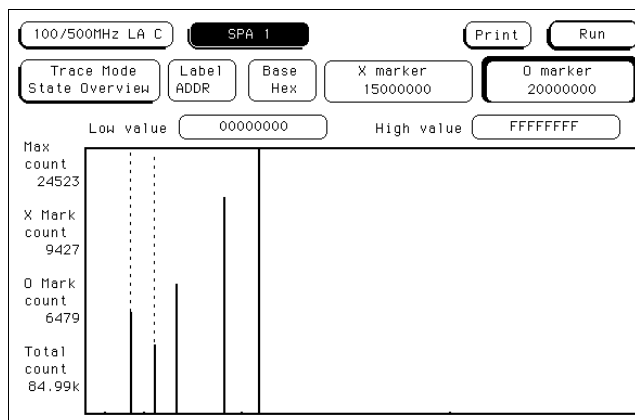

SPA State Overview

Next, you go to the State Histogram menu and enter the names and boundaries of the five routines in the state histogram ranges.

State Histogram then displays the relative activity of the five routines. After several acquisitions, it is apparent that the interrupt routine is being accessed more often than expected.

The figure below shows the State Histogram display for this example.

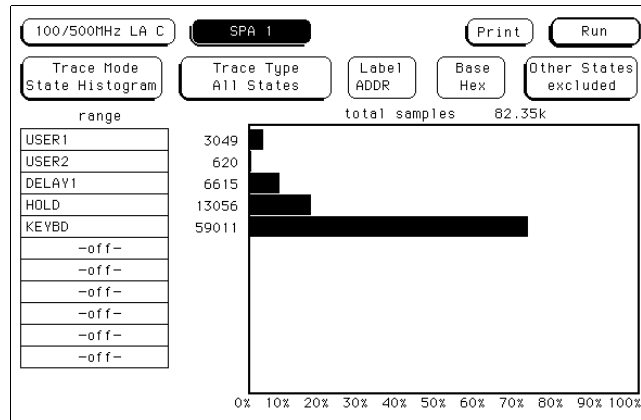

### SPA State Histogram

You now go to the Time Interval menu and enter the Start and End conditions for the suspect interrupt routine. Before altering the default Time Interval ranges, you start the acquisition and observe the Maximum (Max), Minimum (Min), and Average (Avg) times. From these values, the typical execution times of the interrupt are apparent, and provide good starting values for the Time Interval ranges using Auto-range. From the Max time, it is apparent that the interrupt routine is having problems.

Running the acquisition again, you discover that the interrupt usually takes the expected 8 microseconds, but occasionally it takes as long as 8 milliseconds. After experimenting with the target system while monitoring the interrupt with Time Interval mode, a faulty key on the keyboard is discovered. The key is bouncing excessively, resulting in an extended interrupt routine call.

The figure on the next page shows the Time Interval display for this example.

# System Performance Analysis (SPA) Software

## SPA measurement processes

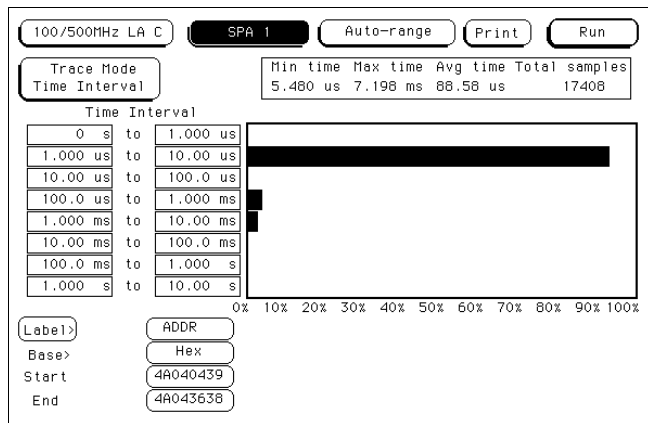

SPA Time Interval



## Using State Overview, State Histogram, and Time Interval

This section explains how to select the display fields, set up the logic analyzer and use the State Overview, State Histogram and Time Interval modes of SPA.

### Setting up the logic analyzer

This section assumes you have defined the format and have connected the logic analyzer probes to the target system. For complete details on these topics, refer to the appropriate reference section.

For a detailed description of State Overview, State Histogram, and Time Interval mode measurement processes, refer to the third section, "SPA Measurement Processes."

### Using State Overview mode

**Choosing a label to monitor** To specify a label to monitor, select the "Label" field in the State Overview menu (item 1 in the figure on the next page). The pop-up shows a list of all the labels defined in the Format Specification. From this list, choose the label you want to monitor.

Changing from one label to another will erase the display setup for the first label. If you want to change to a different label, but don't want to lose the setup for the current one, first save the current one to disk or print it.

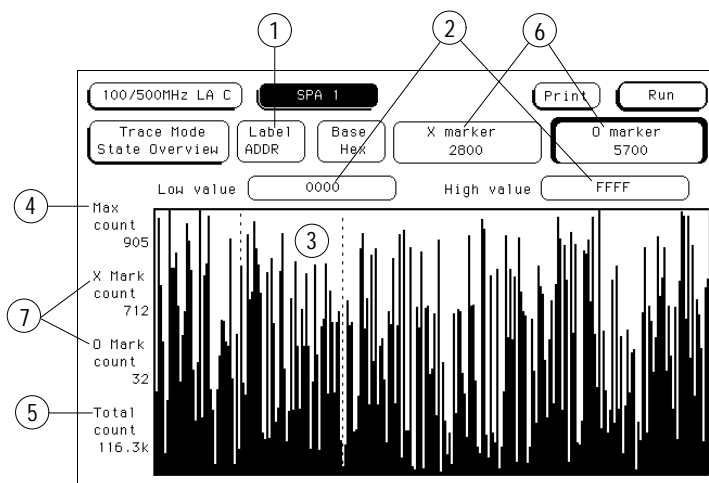

SPA State Overview menu with fields called out

**Specifying Low and High values** The range of the X axis is determined by the Low value and High value fields (item 2 in figure above). To change the X axis range, select the Low value or High value fields and enter new limits. The range you specified will then be divided among the 256 available buckets along the X axis (unless the range is less than 256 or the histogram frame is truncated due to bucket range round-off).

For example, you might set the low and high values so that the range is 1100. 1100 divided by 256 is 4.29. This will be rounded up to 5, and each bucket will have a range of 5. Since 1100 divided by 5 is 220, the histogram frame will be truncated at the right because the X axis will have only 220 of the 256 buckets.

The default high and low values represent the full range of the label you chose. Before changing these values, you may want to run the acquisition and acquire some data to view activity over the entire range of the label. You can then zoom in on areas of interest.

You can enter low and high values in binary, octal, decimal, hexadecimal, ASCII, or symbol.

**Interpreting the histogram display** Press the blue Shift key and Run to start the State Overview acquisition. As the data is sampled and sorted, the buckets along the X axis will accumulate (item 3 in the figure on the previous page). The relative size of the vertical bars show the distribution of activity on the label you chose. The analyzer will continue to sample, sort the data, and update the display until you press Stop or until you change a display variable.

Max count (item 4 in the figure on the previous page) represents the current upper limit of the Y axis for the bucket with the greatest number of data samples. Max count for the limit of the Y axis will increase as the buckets fill with samples.

Read Total count (item 5 in the figure on the previous page) to find the total number of samples taken over the specified range of the label. This is not affected by the low and high values.

**Using the markers** To find the number of data samples in any bucket, select the X marker or O marker field (item 6 in the figure on the previous page). Turn the knob to move the marker to the area of interest. Read the X Mark count or O Mark count values to determine the number of samples in the current bucket (item 7 in the figure on the previous page).

As you move either marker across the display, the value in the X Marker or O Marker pop-up will change. The amount of change of the marker's value represents the size of the bucket.

**Zooming in on an area of interest** When viewing the State Overview display, you may see areas of high activity and areas of little or no activity. To zoom in on one of these areas for more resolution, put the X and O markers on the boundaries of the area, then adjust the low and high values to match the X and O marker positions.



### Using State Histogram mode

**Choosing a label to monitor** To specify a label to monitor, select the Label field in the State Histogram display (item 1 in the figure below). In the pop-up, you will see a list of all the labels defined in the Format specification. From this list, choose the label you want to monitor.

Changing from one label to another will erase the display setup for the first label. If you want to change to a different label, but do not want to lose the setup for the current one, save the current one to a disk.

**Defining the ranges** To define a range on the specified label, select one of the 11 range fields (item 2 in the figure below). When you select one of the 11 ranges, you will see the Range Definition pop-up (item 3 in the figure below). This pop-up has fields where you enter the low and high value, a name for the range, and whether the range is on or off.

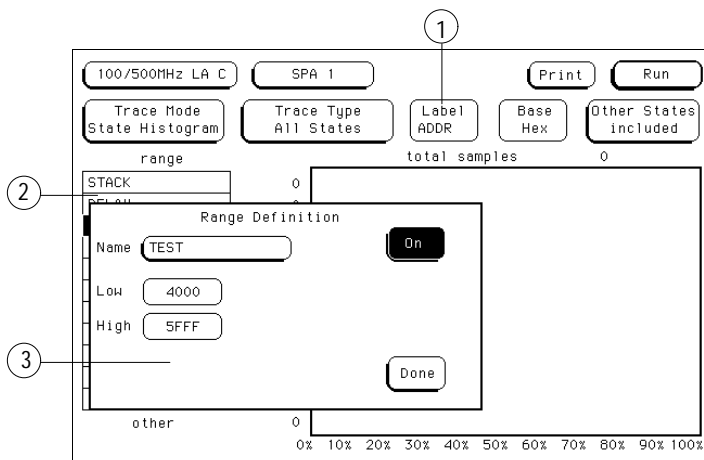

SPA State Histogram menu with fields called out

**Using symbols for ranges** In the Format menu, you can define symbols for any available label. The symbols can be defined as Pattern Symbols or as Range Symbols. For complete information on defining and using symbols, see "Symbols Field" in Chapter 7.

If you set the base field in the State Histogram display to Symbol, you can use any defined range or pattern symbol to set the lower and upper values of the ranges.

**Tracing All States vs. Qualified States** You can qualify the data sampled and sorted in the State Histogram by selecting the Trace Type field and setting it to Qualified States (item 1 in the figure below). This creates a new field at the top of the display called "Specify States."

Select Specify States (item 2 in the figure below) and you will see a pop-up that contains a pattern field for every label defined in the Format Specification. Use the pattern fields to define the data qualification.

For example, in the State Histogram you may want to monitor the address bus of a microprocessor system to examine memory activity. But, you may want to monitor only writes to memory. In the Specify States pop-up, you can tell the analyzer to sample only memory writes by entering under the STATUS label the bit pattern or symbol that corresponds to memory writes.

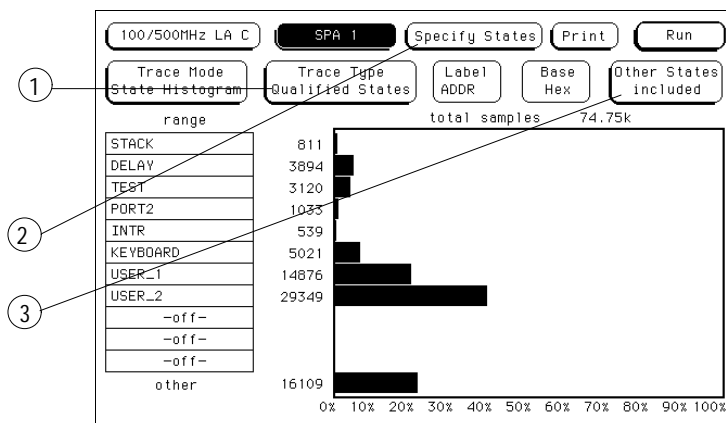

SPA State Histogram menu with fields called out

**Interpreting the histogram display** Press the blue Shift key and Run to start the State Histogram acquisition. The relative activity over the ranges you defined is displayed as histograms (see the figure on the previous page). The total samples field shows the total number of data samples displayed in all of the ranges. The number of samples for each range is displayed to the left of each histogram.

The percentage amounts of the histograms total 100% (note the scale at the bottom of the display). If they add up to more than 100%, you have overlapped two or more ranges, and the data samples are being counted in multiple ranges.

The analyzer will continue to sample, sort the data, and update the display until you press Stop or until you change a display variable.

**Other States included/excluded** The histograms show the relative distribution of activity over the ranges you have defined. In most cases, the ranges will not cover the full range of the label you chose to monitor.

To view the activity over the entire range of the label, including activity not covered by the ranges, select the Other States field and change it to included (item 3 in the figure on the previous page). Another histogram bar called "other" will appear at the bottom of the display. This will show activity not covered by the ranges. You can toggle included/excluded if the analyzer is running since it only affects the display and not the accumulated data that has been acquired.

Note that changing between included and excluded changes the absolute sizes of the histograms. Unless you have defined overlapping ranges, the total percentage size of the all the range histograms plus the histogram for other should equal 100%.

### Using Time Interval mode

Use Time Interval mode to determine the distribution of time between two specific events. The state analyzer uses the time tag feature to time the event; thus, in Time Interval mode, the minimum state clock period is 10 ns.

**Specifying an event** To use Time Interval mode, you must define an event that you want timed. At the bottom of the display, note the Start and End fields (item 1 in figure below). To define an event, select the appropriate labels in the Start and End fields to define the boundaries.

For example, start and end might be the beginning and ending addresses of a subroutine stored in memory. If you are timing a counter period, start and end might be the initial and final count values.

Note that in start and end, you are not limited to a single label. You define the event over all available labels as patterns including don't cares. Be sure that the start and end conditions actually occur in the target system or the analyzer will not find the timing reference points and will not make the time interval measurement. You may want to use the state analyzer (not SPA) to verify that the Start and Stop events actually occur.

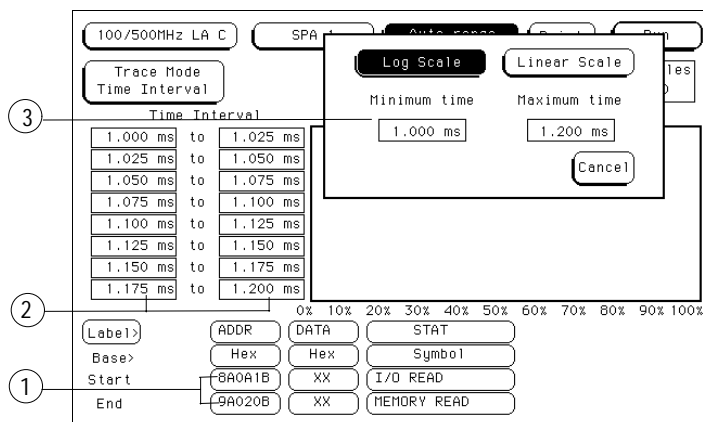

### SPA Time Interval menu with fields called out

For measurement purposes, the analyzer measures the time between the first occurrence of the Start condition and the first occurrence of the Stop condition.

**Defining the Time Interval ranges** Before changing the ranges from their default values, you may want to press Run and acquire some data. From this initial run, the Maximum (Max), Minimum (Min), and Average (Avg) statistics on the display will help you choose the appropriate set of Time Interval ranges.

To define the ranges, select the fields for the lower and upper limits (item 2 in the figure on the previous page) and enter the limits of the range. The ranges do not need to be contiguous, but if you leave gaps between the ranges, critical data may be missed. Also, if you overlap ranges, data may be counted multiple times and present a misleading histogram.

**Using Auto-range** To quickly set up all 8 time interval ranges, select the Auto-range field. Enter the minimum time and maximum time for all 8 ranges combined. Then, when you select Log Scale or Linear Scale, all 8 ranges will be scaled accordingly between the Minimum and Maximum times. See item 3 in the figure on the previous page for the Auto-range pop-up. Common boundaries of adjacent ranges are not considered overlapped. Values that fall on the common boundary will be included in the highest range.

A fast way to set up the Time Interval display is to define your Start and End events and select Run using the default ranges. Select Repetitive Run mode. After accumulating data for a while, press Stop. Then select Auto-range and enter the Min time and Max time display statistics in the Auto-range Minimum time and Maximum time fields. When you select Log Scale or Linear Scale, the ranges will be defined automatically.

**Interpreting the histogram display** As the analyzer samples the data, it searches for Start/End event pairs. One event pair is considered one sample. The time value for each event pair is compared to each defined time interval range. The range's count is incremented if the time value falls within that range.



The analyzer continues to search for Start/End event pairs until you press Stop or until you change a display variable. The distribution of the events' time duration is displayed as histograms (see figure below).

The Max time, Min time, and Avg time statistics give you useful statistics for the event you defined no matter what ranges you've set up (item 1 in figure below).

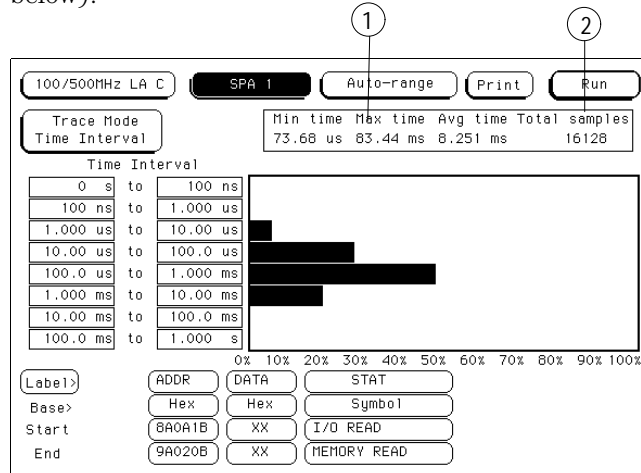

**SPA Time Interval menu with statistics called out**

The Total samples field shows the number of Start/End event pairs found by the analyzer, whether they are covered by the ranges or not (item 2 in figure above).

## Using SPA with other features

### **Programming with SPA**

SPA is programmable. Refer to the *HP 1670A-Series Logic Analyzers Programmer's Guide* for SPA commands. The Programmer's Guide is available as an option with the logic analyzer. Contact your HP Sales Office for more information.

### **Changing between SPA and a State/Timing Analyzer**

If you have configured a state or timing analyzer in the logic analyzer, you can quickly change to SPA, or from SPA to a state or timing analyzer. You can use the same Format Specification in your SPA measurements as you did in your state or timing analysis measurements.

To change between a state analyzer and SPA, go to the Analyzer Configuration menu, select the Type field, and select SPA from the list.

When SPA is selected, a separate trace specification definition is used. Even though the Qualified State Histogram and Time Interval modes use the same pattern recognizers as SPA, the SPA definitions are kept separate from those entered in the state or timing analyzer mode. As a result, switching between SPA and state or timing recovers the user's original pattern recognizers for the selected mode.

Any Symbols in the Format Specification will also carry over to SPA.

### **Using SPA in Group Runs**

In the HP 16500A Logic Analysis System, you can define an intermodule sequence using various combinations of modules and run it singly or repetitively. Similarly, the HP 1660CS-series logic analyzers allow you to set up group runs using the Arming Control field of the other machine's Trigger menu.

By its statistical nature, SPA runs best as a repetitive measurement system. Therefore, if you include SPA in a Group Run, it will execute and update the SPA displays, but the data may not be acquired in a statistically random-repetitive fashion. It may not represent a true statistical analysis of your target system.

Another way to make SPA measurements in conjunction with other analysis is to run SPA independently (do not include it in the Group Run), and set up the other machines as you normally would. In this way, SPA will provide a truer statistical analysis of your target system.



Concepts

---

# Concepts

Understanding how the analyzer does its job will help you use it more effectively and minimize measurement problems. This chapter explains the structure of the file system, the details of transitional timing mode, the general operation of the trigger sequence, and the details of the hardware and self-tests.

---

## The File System

The HP 1660CS-series logic analyzers have a complex internal file system, but most of the file system is only accessible over a LAN connection. From the logic analyzer's front panel, the only parts of the file system you can examine are the hard disk drive and the flexible disk drive. The hard disk drive contains the SYSTEM directory with the X Window fonts and some example files, and also whatever other files and directories you have created on it. The flexible disk drive directory contains whatever files are on the disk in the disk drive.

**See Also**

The LAN User's Guide for more information on the LAN-accessible portions of the file system.

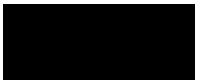

## Directories

### **Hard disk drive**

When you receive the logic analyzer, the hard disk drive is already DOS-formatted. The factory also creates a directory on the hard disk drive named "/SYSTEM". The /SYSTEM directory is intended to store system software such as backup copies of the operating system files and the performance verification files. When you receive your logic analyzer, the /SYSTEM directory already contains two X Window font files and several files of examples.

The files on the hard disk drive are not essential to the logic analyzer's correct operation. However, you can store important files such as optional software, autoload files, configurations, and software backups here. You can configure the logic analyzer to Autoload files from the hard disk at power up.

When the logic analyzer searches for autoload files and software options, it first looks in the flexible disk drive. If the flexible disk drive contains an autoload file and two software options, the analyzer does not check the hard disk drive. If some of these were not found, the analyzer next checks the hard drive's root and /SYSTEM directory.

You can manually copy files, such as performance verification files, to the /SYSTEM directory, but they will not necessarily be installed when the analyzer powers up. To automatically load software, follow the installation instructions provided with the software. It will change the power-up sequence to include the software option and also copy the files to the /SYSTEM directory.

### **Flexible disk drive**

The flexible disk drive reads 3.5-inch flexible disks in both DOS and LIF format. If a disk is in the drive when the analyzer is turned on, the analyzer checks the disk for software and autoload files. If these files are found, they are loaded into the analyzer.

---

## File types

There are seven file types on the HP 1660CS-series logic analyzer. In addition, there are seven common filename endings.

### Standard file types

The file type is shown in a small display box centered on the line above the file listings.

**autoload\_file** indicates the file, almost always named AUTOLOAD, is an autoload file. The file description indicates if the autoload file is enabled or disabled, and the file it autoloads. Autoload files are created by executing "Autoload" in the System Disk menu.

**166xan\_config** indicates the file is an analyzer configuration. These files are created by executing "Store Analyzer" or "Store All" in the System Disk menu.

**166Xsc\_config** indicates the file is an oscilloscope configuration. These files are created by executing "Store Scope" or "Store All" in the System Disk menu.

**16[6/7]x\_cnfg** indicates the file is a system configuration. These files are created by executing "Store System" or "Store All" in the System Disk menu.

**DOS** indicates the file is in DOS format. It might be a screenshot or a file created on a PC and copied to the disk. These files are not loadable.

**directory** indicates the file is a directory and that you can change to that directory. Other files are within it.

**16[6/7]x\_opt** indicates the file is software that can be used with either the HP 1660 or HP 1670 family of logic analyzers.

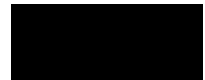

**Filename endings**

Filename endings are not restricted to certain types. These descriptions are just general guidelines. In addition, other tools you use with the logic analyzer will likely have their own set of filename endings.

**[none]** Of the common file types you can create using the logic analyzer, only the ASCII listings do not have a default ending. If you supply one in the Print to Disk filename field, that ending will be used, but no ending is automatically appended as with other filenames.

Three other types of files commonly do not have a default ending: directories, software, and autoload files. Check the file type field to be sure what type of file you are selecting.

**.\_A** This ending is appended to analyzer configuration files created with the Store operation from the System Disk menu.

**.\_B** This ending is appended to oscilloscope configuration files created with the Store operation from the System Disk menu.

**.\_\_** This ending is appended to system configuration files created with the Store operation from the System Disk menu.

**.TIF** This ending is appended to TIFF version 5.0-format screenshots created with the Print to Disk function.

**.EPS** This ending is appended to EPS-format screenshots created with the Print to Disk function.

**.PCX** This ending is appended to PCX-format screenshots created with the Print to Disk function.



---

# Transitional Mode Theory

In Transitional acquisition mode, the timing analyzer samples data at regular intervals, but only stores data when there is a transition on currently assigned bits of a pod pair. Each time a level transition occurs on any of the bits, all bits of the pod pair are stored. A time tag is stored with each stored data sample so the measurement can be reconstructed and displayed later.

One issue when using transitional timing is how many transitions can be stored. The number depends on the mode and frequency of transition occurrence. The following overview explains the number of transitions stored for each transitional timing mode and why.

---

## 125-MHz transitional mode

When the timing analyzer runs in the 125-MHz mode, it operates like the state analyzer with Count Time turned on, the exceptions being that the store qualification comes from transition detectors instead of the trigger sequence and that the analyzer uses an internal clock.

With 4 K of memory per channel and Count Time selected, the analyzer uses half its memory (2 K) to store time tags. Because each pod pair must store transitions at its own rate, each pod pair must store its own set of time tags. This is why you do not have the option of using a free pod to retain full memory as you have in the normal state mode.

When a transition is detected after a sample with no detected transition, both samples are stored. If the next sample also indicates a transition, only one sample is stored. If the next sample does not indicate a transition, no sample is stored this time and the next transition again stores two samples.

### **Minimum transitions stored**

Sometimes transitions occur at a relatively slow rate, slow enough to ensure at least one sample with no transitions between the samples with transitions. This is illustrated in the figure on the next page with time tags 2, 5, 7, and 14. When transitions happen at this rate, two cycles are stored for every transition. This means that with 2 K of memory, 1 K (1024) samples are stored. Subtract 1 for the starting point and you have a minimum of 1023 stored transitions.

## Transitional Mode Theory 250-MHz transitional mode

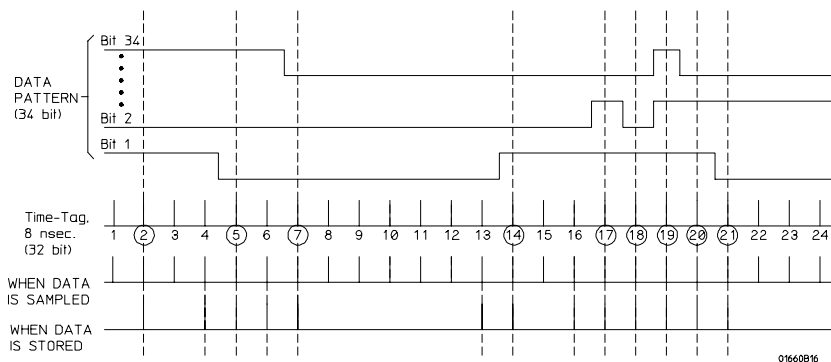

### Storing time tags and transitions

#### Maximum transitions stored

If transitions occur at a fast rate, such that there is a transition at each sample point, only one sample is stored for each transition as shown by time tags 17 through 21 above. If this continues for the entire trace, the number of transitions stored is 2 K divided by 1 sample per transition. Again, you must subtract the starting point sample, yielding a maximum of 2047 stored transitions.

In most cases a transitional timing trace is stored by a mixture of the minimum and maximum cases. Therefore, the actual number of transitions stored will be between 1023 and 2047.

---

## 250-MHz transitional mode

Transitional timing running at 250 MHz is the same as the 125-MHz mode, except that two single-pod data samples are stored instead of one full-pod-pair data sample. This is because in half-channel mode, data is multiplexed into the pipeline in two samples. The first sample is latched, and at the next sample both samples are sent down the pipeline.

This operation keeps the pipeline frequency at 125 MHz, which means the transition detector still looks at a full 34 bits. Essentially, the transition detector is looking at two samples at a time instead of one. In the 250-MHz mode, between 682 and 4094 transitions are stored.

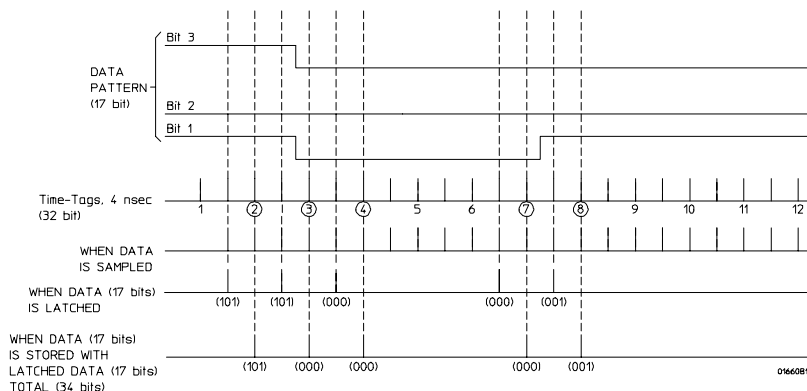

**Minimum transitions stored**

**Minimum transitions stored**

The figure above shows what data is stored from a data stream with transitions that occur at a slow rate (more than 24 ns apart).

As shown, transitions are stored in two different ways, depending strictly on chance. Remember that the transition detector only looks at the full 34 bits while the data is stored as two 17-bit samples. So, the transition detector will not see time tag 3 (101/000) as a transition. However, when the detector compares the transition to time tags 2 (101/101) or 4 (000/000), it sees a difference and detects them as transitions. For this first set of time tags, the transition detector sees more transitions than are really there. This causes the analyzer to store 6 samples per transition (three 34-bit sample pairs), instead of just two, as in the 125-MHz mode. If all the transitions will be stored in this way throughout the trace, the minimum number of stored transitions is 682 (4096/6).

However, as you see with time tags 7 (000/000) and 8 (001/001), transitions can fall between the pairs of samples. When this happens, only one transition is detected and only 4 samples (two sample pairs) are stored. If all transitions will be stored in this way, 1023 (4096/4) transitions are stored.

From run to run, the actual number of transitions stored for transitions that occur at a slower rate will fall between these two numbers, based on the probability of a transition falling between a sample pair or falling within a sample pair.

**Maximum transitions stored**

The following example shows the case where the transitions are occurring at a 4-ns rate:

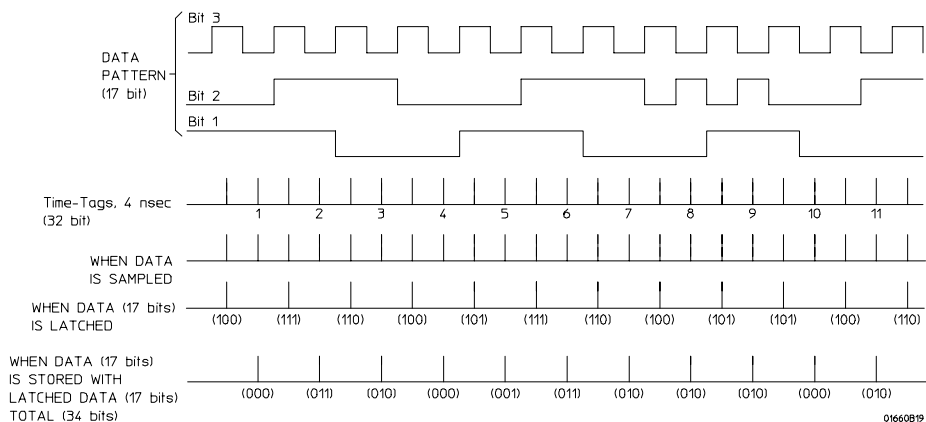

**Maximum transitions stored**

In this case, transitions are being detected with each sample so all samples are stored. This situation also means each sample pair contains a transition. For example, time tag 1 (100/000) contains a transition and is different from time tag 2 (111/011), which also contains a transition. The difference between the sample pairs of time tag 1 and time tag 2 will trigger the transition detector.

If this were to continue throughout the trace, the analyzer would store a single sample for the entire 4 K of memory, or 4096 samples. Again, subtract one for the initial sample which is not a transition for a final total of 4095 transitions recorded. As with the 125-MHz mode, the actual number of transitions stored will fall somewhere between 682 and 4095, depending on the frequency of transitions.

## Other transitional timing considerations

**Pod pairs are independent** In single run mode each pod pair runs independently. This means when one pod pair fills its trace buffer it will not shut the others down. If you have a pod pair with enabled data lines and no transitions on its lines, you get a message "Storing transitions after trigger for pods nn/nn." In repetitive run mode, a full pod pair waits 2 seconds, then halts all other pod pairs.

**Increasing duration of storage** In the 125-MHz mode a transition on any one of the 34 bits in a sample (if they are all turned on) will cause storage. Reducing the number of bits that are turned on for any one pod pair will more than likely increase data storage time.

Separating data lines which contain frequent transitions from lines with less frequent transitions also helps. When doing this, be sure to cross pod pair boundaries. It does not help to move fast lines from pod 1 to pod 2; fast lines must be moved to pod 3, a different pod pair.

In the 250-MHz mode a transition on any one of 17 bits (half-channel) each sample (if they are all turned on) will cause storage.

**Invalid data** The analyzer only looks for transitions on data lines that are turned on. Data lines that are turned off store data, but only when one of the lines that is turned on transitions. If the data line is turned on after a run, you would see data, but it is unlikely that every transition that occurred was captured.



---

## The Trigger Sequence

HP 1660CS-series logic analyzers have triggering and data storage features that allow you to capture only the system activity of interest. Understanding how these features work will help you set up analyzer trigger specifications that satisfy your measurement needs.

In both the state and timing analyzers, the trigger sequence acts as a filtering mechanism, with a minimum of two steps and a maximum of twelve steps in the state analyzer and ten steps in the timing analyzer. Some trigger macros may use more than one step. The steps are the sequence level specifications. The analyzer searches for a trigger sequence by matching input values on the pods to branch conditions, which control transitions between sequence levels. You can insert or delete levels to make the trigger sequence as simple or complex as needed for your application.

## Trigger sequence specification

See the following figure, which shows a sequence specification with four levels. To define the trigger sequence, you specify sequence-advance, sequence-else, storage, and trigger-on specifications.

Each level except the last has two branch conditions, the sequence-advance and sequence-else specification. The storage specification indicates whether data should be stored or not while the logic analyzer is at that sequence level. (The trigger-on specification is a special sequence-advance specification that is described in the section "Trigger On Specification.")

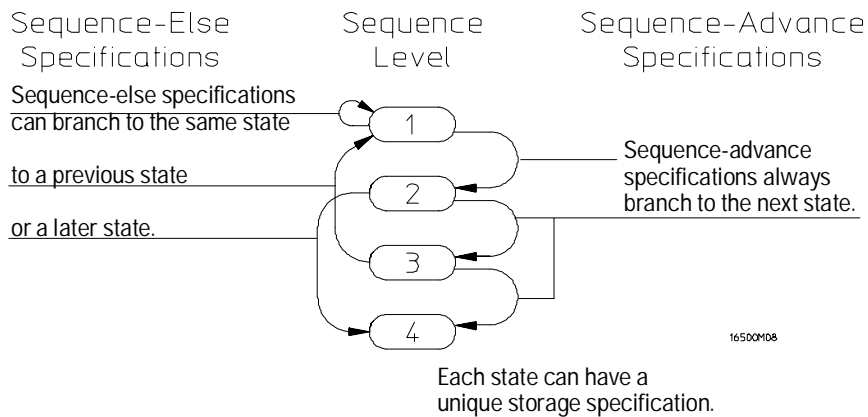

### State analyzer sequence with four states

**Sequence-advance specification** The sequence-advance branch, sometimes called the "if" branch or primary branch, always branches to the next level. You can specify the following kinds of sequence-advance specifications:

Find (or Then find) "<TERM>" <OCCURS> time(s)

Find (or Then find) "<TERM>" <TIME PERIOD>

If the <TERM> is found <OCCURS> number of times or the <TERM> remains stable for <TIME PERIOD>, the analyzer advances to the next sequence level.

**Sequence-else specification** The sequence-else branch, sometimes called the "else if" branch or secondary branch, may branch to any other state, including the current state, a previous state, or a later state. The sequence-else specification looks like the following:

```
Else on "<TERM>" go to level <sequence level>
```

If the Sequence-Else specification is satisfied before the sequence-advance specification, the trigger sequence goes to <sequence level>.

The last state may only have a sequence-else branch specification, which may branch to the same state or a prior state.

**Storage specification** In each state, a storage specification determines the data stored by the analyzer while it is searching for the sequence-advance, sequence-else, and trigger specifications. Storage specifications are defined using the same pattern, range, and timer resources available for defining branching specifications.

```
While storing "anystate", "no state", or "<TERM>"
```

Note that if you specify "no state," the analyzer still stores sequence-advance terms and trigger terms unless you also set Branches Taken Not Stored in Acquisition Control in the Analyzer Trigger menu.

**Trigger on specification** If there are branch and storage specifications for each sequence level, what does the trigger term mean? The trigger term is a special sequence-advance specification in that, when found, it locks the contents of analyzer acquisition memory. The trigger can be positioned at the beginning, middle, or end of acquisition memory.

The trigger specification can look like the following:

```
TRIGGER on "<TERM>" <OCCURS> times
```

```
TRIGGER on "<TERM>" <TIME PERIOD>
```

If the trigger term is found <OCCURS> times, or if the trigger term remains stable for <TIME PERIOD>, the trigger is captured in memory. Then the analyzer advances to the next sequence level. If you want to capture activity after the trigger is captured, define an additional sequence level and specify the desired storage qualification for post-trigger activity (for example, store anystate).



---

## Analyzer resources

The sequence-advance, sequence-else, storage, and trigger-on specifications are set by a combination of up to 10 pattern terms, 2 range terms, 2 timers, and 2 edge terms (timing analyzer only). A resource can only be assigned to one analyzer at a time.

**10 pattern terms** The pattern terms, a through j, represent single states to be found on labeled sets of bits. For example, you could have an address on the address bits or a status on the status bits, or both the address and status occurring together. Pattern terms AND conditions occurring on separate labels.

**2 timers** You can start, stop, continue, or pause the timers upon entry to a sequence state, then use a comparison of current timer value against a preset value to determine whether to branch to another state.

**2 range terms** The range terms, Range1 and Range2, represent ranges of values to be found on labeled sets of bits. For example, you could have a range of addresses to be found on the address bus or a range of data values to be found on the data bus. Range terms are satisfied by any value within the range for "In\_Range," and any value outside the range for "Out\_Range."

**2 edge terms (timing analyzer only)** The edge terms, Edge1 and Edge2, represent edges. The edge terms can be set to catch glitches even when the timing analyzer is not in glitch mode. When an edge term comprises more than one channel, it ORs the channel conditions together and any of the specified transitions satisfy the term.

You can combine the pattern terms and range terms with logical operators to form complex pattern expressions in the sequence-advance, sequence-else, and TRIGGER on specifications.

For example,

```
Find "( <TERM1> • <TERM2> ) + ( <TERM3> • <TERM4> )"
```

Where <TERM> can be a single value on a set of labels, any value within a range of values on a set of labels, or a glitch or edge transition on a bit or set of bits.

**Limitations affecting use of analyzer resources** There are limitations on the way resources can be combined to form complex pattern expressions. Resources are combined in a four-level hierarchy. First, resources are divided into two groups. The groups can be combined with AND or OR. Second, within these groups, resources are combined into pairs. Pairs can also be logically combined using AND or OR. Third, individual resources are combined into pairs using AND, NAND, OR, NOR, XOR, and NXOR. Fourth, individual resources may be included or excluded from participating in a pattern expression. You can also include the logical negation of the resource. Fifth, the timing terms are not available in the first sequence level.

The following table shows how resources are divided in the logic analyzer. Remember that some resources may not be available, depending on the analyzer configuration. For example, if you are using the analyzer as a state analyzer, the Edge1 and Edge2 resources are not available, and only one analyzer may use a resource at a time.

---

**Resource Combination Hierarchy**

---

Group	Pair	Resource Operation	Resource	Pair Links	Group Link
Group 1	Pair 1	Off, On, Negate	a	Combine resources within pairs using AND, NAND, OR, NOR, XNOR	Combine pairs within groups or group 1 and group 2 using AND or OR
		Off, On, Negate	b		
	Pair 2	Off, On, Negate	c		
		Off, In Range, Out of Range	Range 1		
	Pair 3	Off, On, Negate	d		
		Off, On, Negate	Edge 1		
	Pair 4	Off, On, Negate	e		
		Off, <, >	Timer 1		
Group 2	Pair 1	Off, On, Negate	f	Combine resources within pairs using AND, NAND, OR, NOR, XNOR	
		Off, On, Negate	g		
	Pair 2	Off, On, Negate	h		
		Off, In Range, Out of Range	Range 2		
	Pair 3	Off, On, Negate	i		
		Off, On, Negate	Edge 2		
	Pair 4	Off, On, Negate	j		
		Off, <, >	Timer 2		

---

For example, the following combinations are valid combinations for the analyzer:

$(a+b) \cdot (In\_Range2 + Timer2 > 400\ ns)$   
 $(c \cdot Out\_Range1) + (f\ xor\ g)$

The following combinations are not valid, because resources cross pair boundaries:

$a\ xor\ c$   
 $(d + Timer1 < 400\ ns) \cdot Edge1$

The first example shows that a and c cannot be combined at the first level. The following figure shows the possible combinations of the a, b, c and Range1 terms:

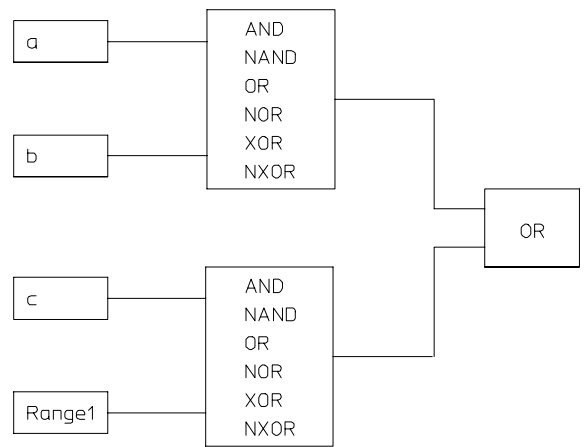

#### Combining a, b, c, and Range1 terms

The following combination is not valid, because pairs cross group boundaries:

$((a+b) + (h \cdot In\_Range2)) \cdot (j\ xor\ Timer2 > 400\ ns)$

Although the analyzer interface will not allow you to enter invalid combinations, you need to be aware of what combinations are legal, so that you can make the desired measurement.

Another limitation is that the analyzer cannot handle ranging for input pods that are assigned to different pod pairs. For example, if you need to define a 32-bit range term, you must do it using pods 1/2, 3/4, or 5/6. Trying to define a range across pods 2/3, 4/5, or 1/6 will not work.

## Timing analyzer

When you configure a timing analyzer, the trigger sequence follows the general outlines given previously. The trigger sequence of the timing analyzer differs from the state analyzer in the following ways:

- There are 10 levels available to build a trigger with.
- The trigger term is always the last step.
- The timing analyzer has two additional resources, Edge1 and Edge2.
- Edge1 and Edge2 recognize occurrences of a glitch, rising edge, falling edge, either edge, or no edge on a bit or ORed set of bits.

---

## State analyzer

When you configure a state analyzer, the trigger sequence follows the general outlines given previously. The trigger sequence of the state analyzer differs from the timing analyzer in the following ways:

- There are 12 levels available to build a trigger with.
- The trigger term is never the last step.
- The state analyzer cannot use Edge1 and Edge2.

---

## Configuration Translation Between HP Logic Analyzers

Analyzer configuration files cannot be transferred directly from one type of analyzer to another because each analyzer has internal architectural differences, reflected in the number of pods, clock configurations, trigger sequence features, analyzer resources, and so on. To help you move configuration files from one analyzer to another, most HP logic analyzers support automatic translation of analyzer configurations. The HP 1660CS-series logic analyzer can translate configuration files from the following common analyzer models:

- HP 16510
- HP 16511
- HP 16540
- HP 16541
- HP 16550
- HP 1660AS

If you save an analyzer configuration from one model of analyzer, then load that configuration into a model that supports configuration translation and was released after the original analyzer, the translator will adjust the configuration as required to account for differences between the models.

The configuration translator needs to account for many aspects of the analyzer architecture. Some of the considerations are as follows:

- When a range term is split across multiple pods, the term must span adjacent odd/even pairs, starting with 1. Thus, terms could span pods 1 and 2, 3 and 4, 5 and 6, or 7 and 8, but not 2 and 3. Again, the translator may display messages asking you to reconnect cables in a different configuration.
- When loading a configuration into an analyzer with fewer pods than the one on which the configuration was saved, the translator must remove pod assignments. Which pods are removed from the configuration will depend on the widths of each pod in the original analyzer and new analyzer.

The configuration translation also needs to account for many differences in the format and trace menus between the analyzers, including label names, polarities, thresholds, symbols, clocking, number of sequence levels, branch conditions, and patterns, among others.

To ensure that trace measurements act as expected when you move configuration files from one analyzer to another, follow these recommendations:

- Ensure that the analyzer pods are hooked up as required by the configuration translation and the new analyzer. The onscreen messages given by the translator will help you identify which analyzer pods must be swapped. If you are using an HP preprocessor, the preprocessor User's Guide may contain information showing the cable connections for different analyzer models.
- Review all trace format and trigger menu settings to verify that they will meet your measurement requirements. You should check label assignments, channel masks, pattern and range definitions, sequencer setup, and general analyzer configuration (which pods are mapped to each analyzer).

When you move a configuration file from one analyzer to another, the trace data from previous measurements is not moved. If you need to store trace data for future reference, see "To save a listing in ASCII format" in Chapter 6.

---

## The Analyzer Hardware

This section describes the theory of operation for the logic analyzer and describes the self-tests. The information in this section is to help you understand how the logic analyzer operates and what the self-tests are testing. This information is not intended for component-level repair.

The block-level theory is divided into two parts: theory for the logic analyzer and theory for the acquisition boards. A block diagram is shown with each theory.



---

## HP 1660CS-series analyzer theory

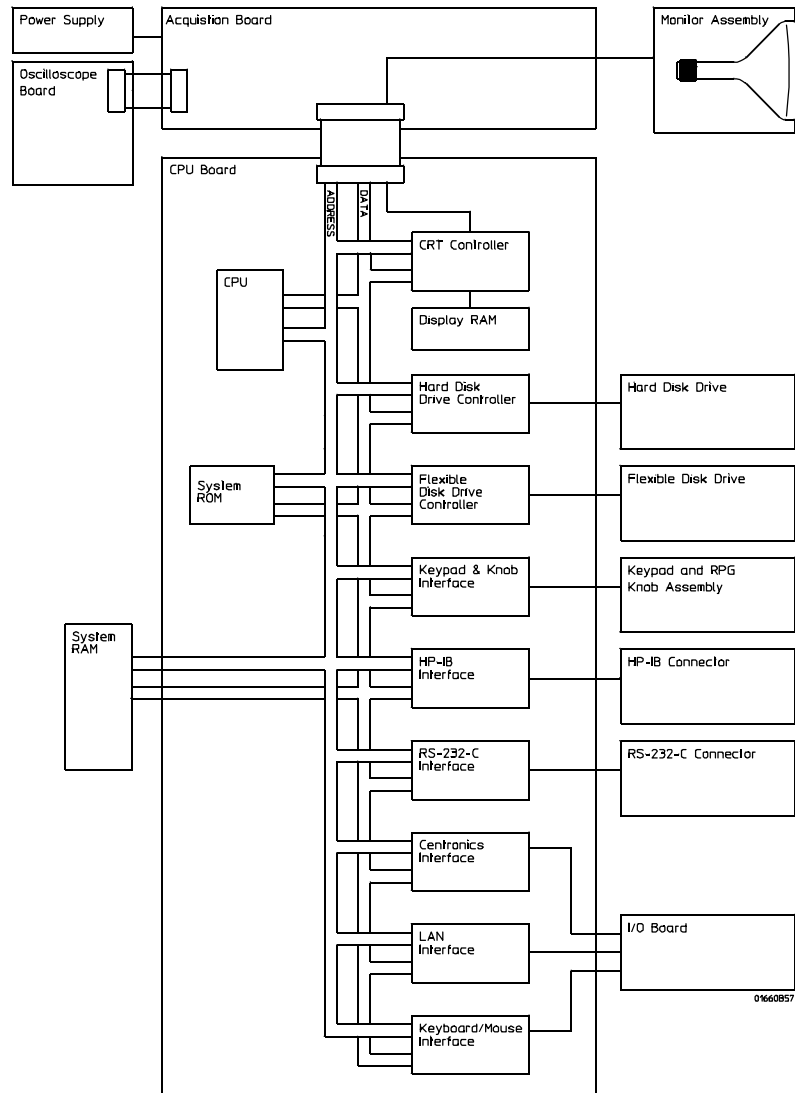

### HP 1660C/CS logic analyzer



### **CPU board**

The microprocessor is a Motorola 68EC020 running at 25 MHz. The microprocessor controls all of the functions of the logic analyzer including processing and storing data, displaying data, and configuring the acquisition ICs to obtain and store data.

### **System memory**

The system memory is made up of both read-only memory (ROM) and random access memory (RAM). Two types of ROM are used. A single 128Kx8 EPROM is used as a boot ROM, and four 512Kx8 Flash ROMs are configured to provide a 512Kx32 Flash ROM space. One SIMM socket supports 2-MB, 4-MB, or 8-MB SIMMs.

On power-up, instructions in the boot ROM command the instrument to execute its boot routine. The boot routine includes power-up operation verification of the instrument subsystems and entering the operating system. The CPU searches for the operating system on flash ROM. Then, if the operating system is in flash ROM, the instrument will be initialized with the default configuration and await front panel instructions from you. If the operating system is not in flash ROM, the CPU accesses the disk drives to see if the operating system is on the disks.

The DRAM stores the instrument configuration, acquired data to be processed, and any inverse assembler loaded in the instrument by the user.

### **Keypad and knob interface**

The front panel keypad is scanned directly from the microprocessor address bus during the video blanking cycle of the CRT. When a front panel key is pressed the associated address bits are fed to the data bus through the pressed key and read by the microprocessor.

The rotary pulse generator (RPG) knob has its own interface. Pulses and direction of rotation information are directed to the RPG interface. The microprocessor then reads and interprets the RPG signals and performs the desired tasks.

### **HP-IB interface**

The instrument interfaces to HP-IB as defined by IEEE Standard 488.2. The interface consists of an HP-IB controller and two octal drivers/receivers. The microprocessor routes HP-IB data to the controller. The controller then buffers the 8-bit HP-IB data bits and generates the bus handshaking signals. The data and handshaking signals are then routed to the HP-IB bus through the octal line drivers/receivers. The drivers/receivers provide data and control signal transfer between the bus and controller.

### **RS-232-C interface**

The instrument RS-232-C interface is compatible with standard RS-232-C protocol. The interface consists of a controller and drivers/receivers. The controller serializes parallel data from the microprocessor for transmission. At the same time the controller also receives serial data and converts the data to parallel data characters for the microprocessor.

The controller contains a baud rate generator that can be programmed from the logic analyzer front panel. Other RS-232-C communications parameters can also be programmed from the logic analyzer front panel.

The drivers/receivers interface the instrument with data communications equipment. Slew rate control is provided on the ICs eliminating the need for external capacitors.

### **Power supply**

A low voltage power supply provides all dc voltages needed to operate the logic analyzer. The power supply also provides the +5 V dc voltage to the probe cables to power logic analyzer accessories and preprocessors.

Unfiltered voltages of +12 V, -12 V, +5 V, -5.2 V, and +3.5 V are supplied to the acquisition board where they are filtered and distributed to the CPU board, CRT Monitor Assembly, and probe cables.

## Logic acquisition board theory

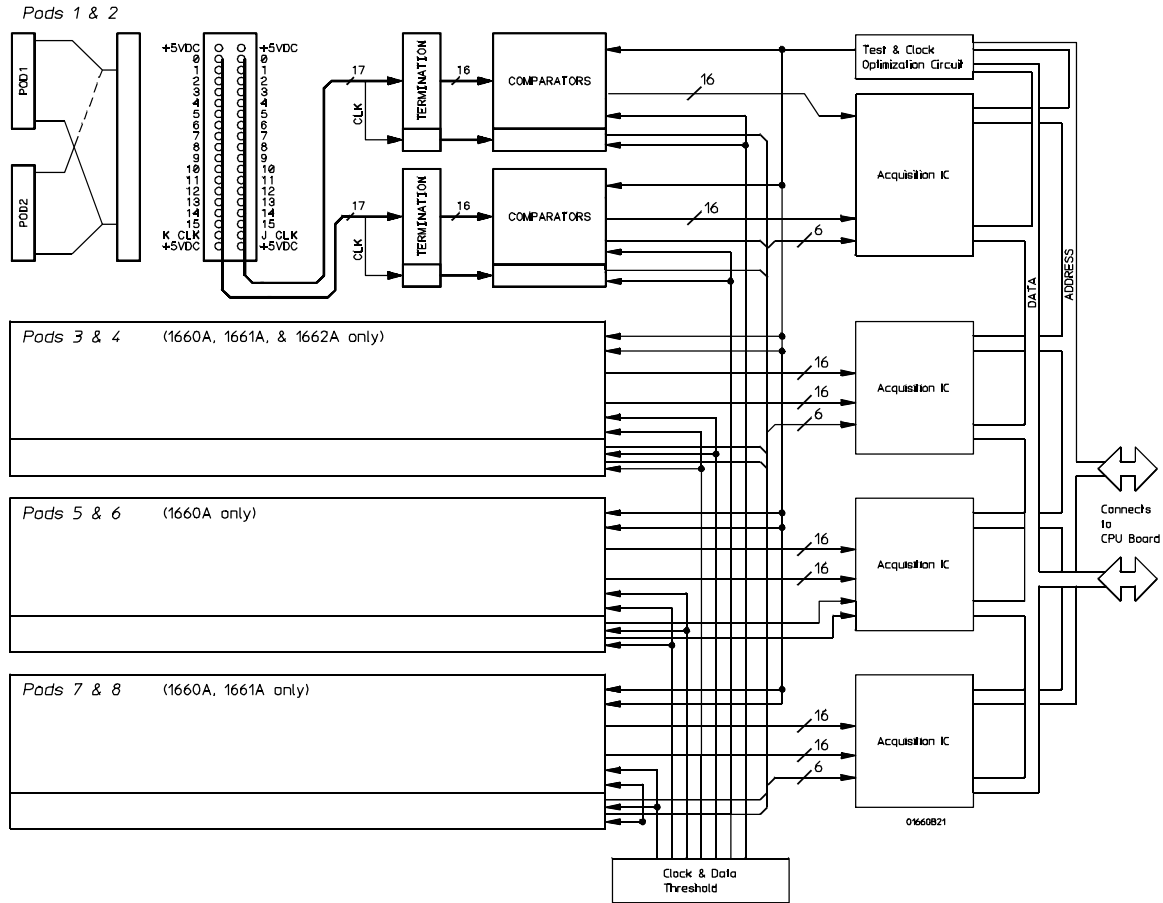

### Logic acquisition board

#### Probing

The probing circuit includes the probe cable and terminations. The probe cable consists of two 17-channel pods which are connected to the circuit board using a high-density connector. Sixteen single-ended data channels and one single-ended clock/data channel per pod are passed to the circuit board. If the clock/data channel is not used as a state clock in state

acquisition mode, it is available as a data channel. The clock/data channel is also available as a data channel in timing acquisition mode. Eight (HP 1660CS), six (HP 1661CS), four (HP 1662CS), or two (HP 1663CS) clock/data channels are available as data channels; however, only six clock/data channels can be assigned as clock channels in the HP 1660CS and HP 1661CS. All clock data channels available in the HP 1662CS and HP 1663CS can be assigned as clock channels.

The cables use nichrome wire woven in polyaramid yarn for reliability and durability. The pods also include one ground path per channel in addition to a pod ground. The channel grounds are configured such that their electrical distance is the same as the electrical distance of the channel. The probe tip assemblies and termination modules connected at the end of the probe cables have a divide-by-10 RC network that reduces the amplitude of the data signals as seen by the circuit board. This adds flexibility to the types of signals the circuit board can read in addition to improving signal integrity.

The terminations on the circuit board are resistive terminations that reduce transmission line effects on the cable. The terminations also improve signal integrity to the comparators by matching the impedance of the probe cable channels with the impedance of the signal paths of the circuit board. All 17 channels of each pod are terminated in the same way. The signals are reduced by a factor of 10.

### **Comparators**

Two proprietary 9-channel comparators per pod interpret the incoming data and clock signals as either high or low depending on where the user-programmable threshold is set. The threshold voltage of each pod is individually programmed, and the voltage selected applies to the clock channel as well as the data channels of each pod.

Each of the comparator ICs has a serial test input port used for testing purposes. A test bit pattern is sent from the Test and Clock Synchronization Circuit to the comparator. The comparators then propagate the test signal on each of the nine channels of the comparator. Consequently, all data and clock channel pipelines on the circuit board can be tested by the operating system software from the comparator.

### **Acquisition**

The acquisition circuit is made up of a single HP-proprietary ASIC. Each ASIC is a 34-channel state/timing analyzer, and one such ASIC is included for every two logic analyzer pods. All of the sequencing, pattern/range recognition, and event counting functions are performed on board the IC.

In addition to the storage qualification and counting functions, the acquisition ASICs also perform master clocking functions. All six state acquisition clocks are fed to each IC, and the ICs generate their own sample clocks. Every time you select run, the ICs individually perform a clock optimization before data is stored.

Clock optimization involves using programmable delays on board the IC to position the master clock transition where valid data is captured. This procedure greatly reduces the effects of channel-to-channel skew and other propagation delays.

In the timing acquisition mode, an oscillator-driven clock circuit provides a four-phase, 100-MHz clock signal to each of the acquisition ICs. For high speed timing acquisition (100 MHz and faster), the sample period is determined by the four-phase, 100-MHz clock signal.

For slower sample rates, one of the acquisition ICs divides the 100-MHz clock signal to the appropriate sample rate. The sample clock is then fed to all acquisition ICs.

### **Threshold**

A precision octal DAC and precision op amp drivers make up the threshold circuit. Each of the eight channels of the DAC is individually programmable which allows you to set the thresholds of the individual pods. The 16 data channels and the clock channel of each pod are all set to the same threshold voltage.

### **Test and clock synchronization circuit**

ECLinPS ICs are used in the test and clock synchronization circuit for reliability and low channel-to-channel skew. Test patterns are generated and sent to the comparators during software operation verification. The test patterns are propagated across all data and clock channels and read by the acquisition ASIC to ensure both the data and clock pipelines are operating correctly.

The test and clock synchronization circuit also generates a four-phase, 100-MHz sample/synchronization signal for the acquisition ICs operating in the timing acquisition mode. The synchronizing signal keeps the internal clocking of the individual acquisition ASICs locked in step with the other ASICs at fast sample rates. At slower sample rates, one of the acquisition ICs divides the 100-MHz clock signal to the appropriate sample rate. The slow speed sample clock is then used by all acquisition ICs.

## Oscilloscope board theory

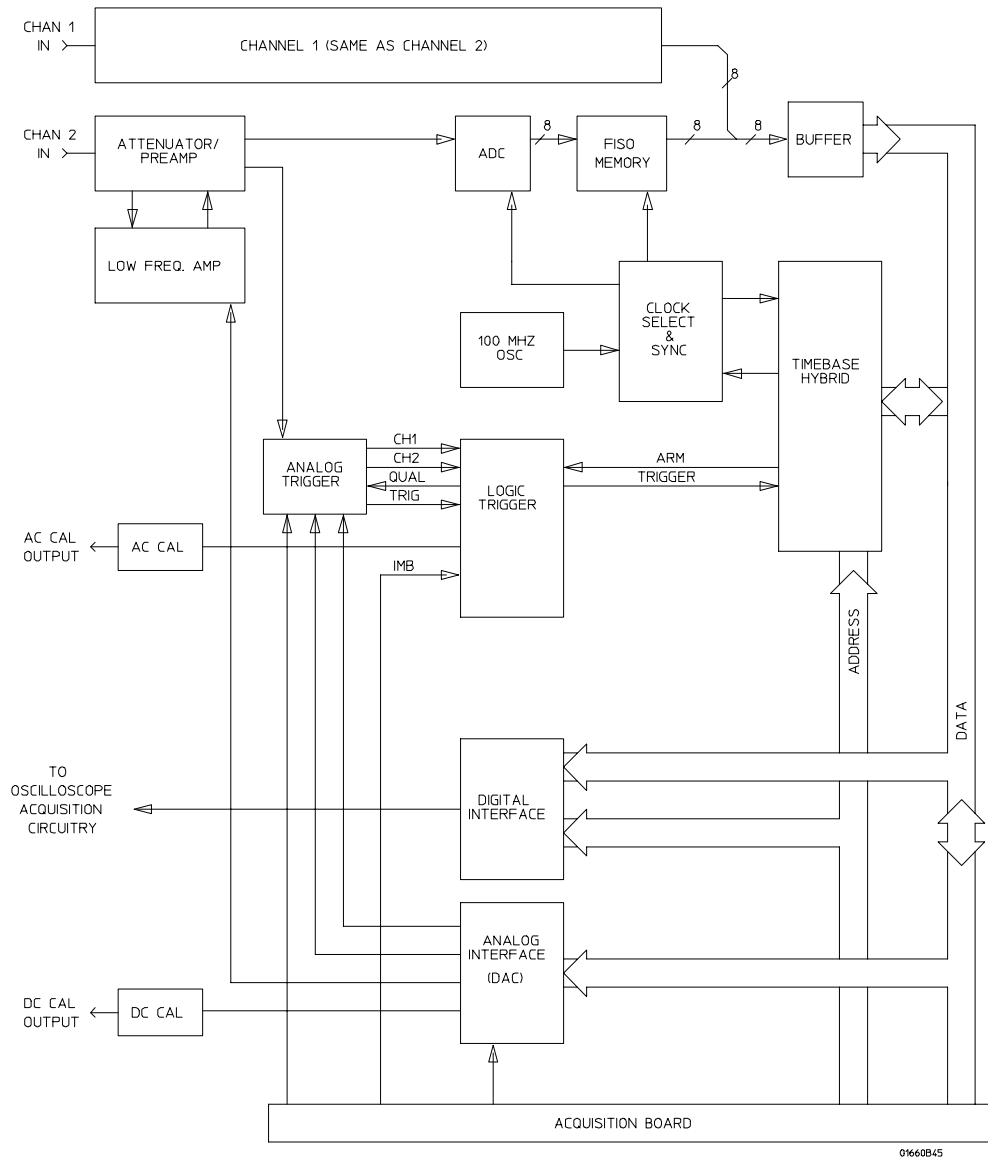

Oscilloscope board

### Attenuator/Preamp theory of operation

The channel signals are conditioned by the attenuator/preamps, thick film hybrids containing passive attenuators, impedance converters, and a programmable amplifier. The channel sensitivity defaults to the standard 1-2-4 sequence (other sensitivities can be set also). However, the firmware uses passive attenuation of 1, 5, 25, and 125, with the programmable preamp, to cover the entire sensitivity range.

The input has a selectable 1 M $\Omega$  input impedance with ac or dc coupling or a 50 $\Omega$  input impedance with dc coupling. Compensation for the passive attenuators is laser-trimmed and is not adjustable. After the passive attenuators, the signal is split into high-frequency and low-frequency components. Low frequency components are amplified on the main assembly, where they are combined with the offset voltage. The ac coupling is implemented in the low frequency amplifier.

The high- and low-frequency components of the signal are recombined and applied to the input FET of the preamp. The FET provides a high input impedance for the preamp. The programmable preamp adjusts the gain to suit the required sensitivity and provides the output signal to the main assembly. The output signal is then sent to both the trigger circuitry and ADC.

### Oscilloscope acquisition

The acquisition circuitry provides the sampling, digitizing, and storing of the signals from the channel attenuators. The channels are identical. Trigger signals from each channel and the external triggers synchronize acquisition through the time base circuitry. A 100 MHz oscillator and a time base provide system timing and sample clocking. A voltage-controlled oscillator (VCO), frequency divider, and digital phase detector provide the sample clock for higher sample rates. After conditioning and sampling, the signals are digitized, then stored in a hybrid IC containing a FISO (fast in, slow out) memory.

**ADC** The eight-bit ADC digitizes the channel signal. Digitization is done by comparators in a flash converter. The sample clock latches the digitized value of the input to save it so that it can be sent to memory.

**FISO memory** 8000 samples of the FISO (fast in, slow out) memory are used per measurement per channel. Memory positions are not addressed directly. The configuration is a ring which loops continuously as it is clocked. Memory position is tracked by counting clocks. The clocking rate is the same as the ADC, however the clock frequency is half

that of the ADC since the FISO clocks on both transitions of the clock period. Data is buffered onto the CPU data bus for processing.

**Triggering** There are two main trigger circuits that control four trigger sources. The two trigger circuits are the analog trigger and the logic trigger. The analog trigger IC operates as a multichannel Schmidt trigger/comparator. A trigger signal (a copy of the analog input signal) from each of the inputs (channel 1 and channel 2) is directed to the analog trigger IC inputs. The trigger signal is continuously compared with the trigger reference level selected by the user. Once the trigger condition is met, the trigger true signal is fed to the logic trigger, which begins the acquisition and store functions by way of the time base.

The four trigger sources are Channel 1, Channel 2, Intermodule Bus (IMB), and external BNC. Channel 1 and channel 2 triggers were discussed previously. The IMB trigger signal is sent directly to the logic trigger. External triggering is provided by the BNC input of the HP 1660CS-series logic analyzer.

**Time base** The time base provides the sample clocks and timing necessary for data acquisition. It consists of the 100 MHz reference oscillator and time base hybrid.

The 100 MHz reference oscillator provides the base sample frequency.

The time base hybrid has programmable dividers to provide the rest of the sample frequencies appropriate for the time range selected. The time base uses the time-stretched output of the fine interpolator to time-reference the sampling to the trigger point. The time base has counters to control how much data is taken before (pre-trigger data) and after (post-trigger data) the trigger event. After the desired number of pre-trigger samples has occurred, the time base hybrid sends a signal to the logic trigger (trigger arm) indicating it is ready for the trigger event. When the trigger condition is satisfied, the logic trigger sends a signal back to the time base hybrid. The time base hybrid then starts the post-trigger delay counter.

When the countdown reaches zero, the sample clocks are stopped and the CPU is signaled that the acquisition is complete. The fine interpolator is a dual-slope integrator that acts as a time-interval stretcher. When the logic trigger receives a signal that meets the programmed triggering requirements, it signals the time base. The time base then sends a pulse to the fine interpolator. The pulse is equal in width to the time between the trigger and the next sample clock. The fine interpolator stretches this time by a factor of approximately 500. Meanwhile, the time base hybrid runs a counter with a



clock derived from the sample rate oscillator. When the interpolator indicates the stretch is complete, the counter is stopped. The count represents, with much higher accuracy, the time between the trigger and the first sample clock. The count is stored and used to place the recently acquired data in relationship with previous data.

**AC Cal** The AC Cal is a multiplexer circuit that can provide several signals to the Probe Compensation/AC Calibrator output on the rear panel. The signal provided depends on the mode of the instrument. It can be either a probe compensation signal, a pulse representing the trigger event, signals used for self-calibration, or the 100 MHz reference oscillator when sample period is 1 ns.

**DC Cal** The DC Cal output, a rear panel signal, is used for self-calibration. It is one output from the 16-channel DAC.

**Digital Interface** The Digital Interface provides control and interface between the system control and digital functions in the acquisition circuitry.

**Analog Interface** The Analog Interface provides control of analog functions in the acquisition circuitry. It is primarily a 16-channel DAC with an accurate reference and filters on the outputs. It controls channel offsets and trigger levels, and provides the DC Cal output.



---

## Self-tests description

The self-tests identify the correct operation of major functional areas in the logic analyzer. The self-tests are not intended for component-level diagnostics.

Three types of tests are performed on the HP 1660CS-series logic analyzers: the power-up self-tests, the functional performance verification self-tests, and the parametric performance verification tests.

The power-up self-tests are performed when power is applied to the instrument. The power-up self-tests are divided into two parts. The first part is the system memory tests and the second part is the microprocessor interrupt test. The system memory tests are performed before the logic analyzer actually displays the power-up self-test screen. Both the system ROM and RAM are tested during power-up. The interrupt test is performed after the power-up self-test screen is displayed.

The functional performance verification self-tests are run using a separate operating system, the performance verification (PV) operating system. The PV operating system resides on a separate disk that must be loaded when running the functional performance verification self-tests. The system and analyzer tests are functional performance verification tests.

Parametric performance verification requires the use of external test equipment that generates and monitors test data for the logic analyzer to read. Refer to chapter 3, "Testing Performance," of the *HP 1660C/CS-Series Logic Analyzers Service Guide* for further information about parametric performance verification.



## Troubleshooting

---

# Troubleshooting

Occasionally, a measurement may not give the expected results. If you encounter difficulties while making measurements, use this chapter to guide you through some possible solutions. Each heading lists a problem you may encounter, along with some possible solutions. Error messages which may appear on the logic analyzer are listed below in quotes ". Symptoms are listed without quotes.

If you still have difficulty using the analyzer after trying the suggestions in this chapter, please contact your local Hewlett-Packard Service Center.

---

**CAUTION**

---

When you are working with the analyzer, be sure to power down both the analyzer and the target system before disconnecting or connecting cables, probes, and preprocessors. Otherwise, you may damage circuitry in the analyzer, preprocessor, or target system.

---

# Analyzer Problems

This section lists general problems that you might encounter while using the analyzer.

---

## Intermittent data errors

This problem is usually caused by poor connections, incorrect signal levels, or marginal timing.

- With the logic analyzer and all connected equipment turned off, remove and reseat all cables and probes; ensure that there are no bent pins on the preprocessor interface or poor probe connections.
- Adjust the threshold level of the data pod in the Format menu to match the logic levels in the system under test.
- Use an oscilloscope to check the signal integrity of the data lines.

Clock signals for the state analyzer must meet particular pulse shape and timing requirements. Data inputs for the analyzer must meet pulse shape and setup and hold time requirements.

### See Also

See "Capacitive Loading" in this section for information on other sources of intermittent data errors.

---

## Unwanted triggers

Unwanted triggers can be caused by instructions that were fetched but not executed.

- Add the prefetch queue or pipeline depth to the trigger address.

The depth of the prefetch queue depends on the processor that you are analyzing. Suppose you are analyzing a pipelined processor having fetch, decode, execute, and memory stages. The processor fetches 32-bit words. To ensure that the processor has begun executing a particular routine when the

trigger occurs, set the trigger to the module entry address plus 08 hex. (This assumes that there is no immediate data in the instruction stream.)

---

## No activity on activity indicators

- Ensure that the Threshold settings in the Format menu match the logic family being probed.
- Check for loose cables, board connections, and preprocessor interface connections.
- Check for bent or damaged pins on the preprocessor probe.

---

## Capacitive loading

Excessive capacitive loading can degrade signals, resulting in incorrect capture by the preprocessor interface, or system lockup in the microprocessor. All preprocessor interfaces add additional capacitive loading, as can custom probe fixtures you design for your application. To reduce loading, remove as many pin protectors, extenders, and adapters as possible.

Careful layout of your target system can minimize loading problems and result in better margins for your design. This is especially important for systems that are running at frequencies greater than 50 MHz.

---

## No trace list display

If there is no trace list display, it may be that your trigger specification is not correct for the data you want to capture, or that the trace memory is only partially filled.

- Check your trigger specification to ensure that it will capture the events of interest.
- Try stopping the analyzer; if the trace list is partially filled, this should display the contents of trace memory.

---

# Preprocessor Problems

This section lists problems that you might encounter when using a preprocessor. If the solutions suggested here do not correct the problem, you may have a defective preprocessor. Refer to the User's Guide for your preprocessor for test procedures. Contact your local Hewlett-Packard Sales Office if you need further assistance.

---

## Target system will not boot up

If the target system will not boot up after connecting the preprocessor interface, the microprocessor or the preprocessor interface may not be installed properly, or they may not be making electrical contact.

- Ensure that you are following the correct power-on sequence for the preprocessor and target system.

**1** Power up the analyzer and preprocessor.

**2** Power up the target system.

If you power up the target system before you power up the preprocessor, interface circuitry in the preprocessor may latch up, preventing proper target system operation.

- Verify that the microprocessor and the preprocessor interface are properly rotated and aligned, so that the index pin on the microprocessor (such as pin 1 or A1) matches the index pin on the preprocessor interface.
- Verify that the microprocessor and the preprocessor interface are securely inserted into their respective sockets.
- Verify that the logic analyzer cables are in the proper sockets of the preprocessor interface and are firmly inserted.
- Reduce the number of extender sockets.

### See Also

"Capacitive Loading" in the previous section of this chapter.

## Slow clock

If you have the preprocessor interface hooked up and running and observe a slow clock or no activity from the interface board, the +5 V supply coming from the analyzer may not be getting to the interface board.

- To check the +5 V supply coming from the analyzer, disconnect one of the logic analyzer cables from the preprocessor and measure across pins 1 and 2 or pins 39 and 40.

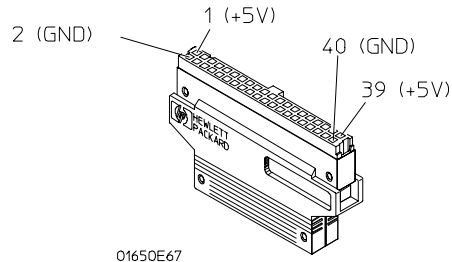

- If +5 V is not present, check the internal preprocessor fuse or current limiting circuit on the logic analyzer. For information on checking this fuse or circuit, refer to the *HP 1660C/CS Logic Analyzers Service Guide*.
- If +5 V is present and the cable connection to the preprocessor appears sound, contact your nearest Hewlett-Packard Sales Office for information on servicing the board.



---

## Erratic trace measurements

There are several general problems that can cause erratic variations in trace lists and inverse assembly failures.

- Ensure that the preprocessor configuration switches are correctly set for the measurement you are trying to make.**

Some preprocessors include configuration switches for various features (for example, to allow dequeuing of the trace list). See your Preprocessor User's Guide for more information.

- Try doing a full reset of the target system before beginning the measurement.**

Some preprocessor designs require a full reset to ensure correct configuration.

- Ensure that your target system meets the timing requirements of the processor with the preprocessor probe installed.**

See "Capacitive Loading" in this chapter. While preprocessor loading is slight, pin protectors, extenders, and adapters may increase it to unacceptable levels. If the target system design has poor timing margins, such loading may cause incorrect processor functioning, giving erratic trace results.

- Ensure that you have sufficient cooling for the preprocessor probe.**

Current processors such as the i486, Pentium™, and MC68040 generate substantial heat. This is exacerbated by the active circuitry on the preprocessor board. You should ensure that you have ambient temperature conditions and airflow that meet or exceed the requirements of the microprocessor manufacturer.

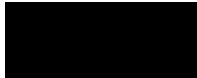

---

## Inverse Assembler Problems

This section lists problems that you might encounter while using the inverse assembler.

When you obtain incorrect inverse assembly results, it may be unclear whether the problem is in the preprocessor or in your target system. If you follow the suggestions in this section to ensure that you are using the preprocessor and inverse assembler correctly, you can proceed with confidence in debugging your target system.

---

### No inverse assembly or incorrect inverse assembly

This problem is due to incorrect synchronization, modified configuration, incorrect connections, or a hardware problem in the target system. A locked status line can cause incorrect or incomplete inverse assembly.

- Verify that the inverse assembler has been synchronized by placing an opcode at the top of the display (not at the input cursor) and pressing the **Invasm** key.

Because the inverse assembler works from the first line of the trace *display*, if you jump to the middle of a trace and select **Invasm**, prior trace states are not disassembled correctly. If you move to several random places in the trace list and select **Invasm** each time, the trace disassembly is only guaranteed to be correct from the top of the display forward for each selection.

#### See Also

"The Inverse Assembler" in chapter 3.

- Ensure that each analyzer pod is connected to the correct preprocessor cable.

There is not always a one-to-one correspondence between analyzer pod numbers and preprocessor cable numbers. Preprocessors must supply address (ADDR), data (DATA), and status (STAT) information to the analyzer in a predefined order, so the cable connections for each preprocessor are often altered to support that need. Thus, one preprocessor might require that you connect cable 2 to analyzer pod 2, while another will

require you to connect cable 5 to analyzer pod 2. See the User's Guide for your preprocessor for further information.

- Check the activity indicators for status lines locked in a high or low state.
- Verify that the STAT, DATA, and ADDR format labels have not been modified from their default values.

These labels must remain as they are configured by the configuration file. Do not change the names of these labels or the bit assignments within the labels. Some preprocessors also require other data labels; check your Preprocessor User's Guide for more information.

- Verify that all microprocessor caches and memory managers have been disabled.

In most cases, if the microprocessor caches and memory managers remain enabled you should still get inverse assembly, but it may be incorrect since some of the execution trace was not visible to the logic analyzer.

- Verify that storage qualification has not excluded storage of all the needed opcodes and operands.

---

## Inverse assembler will not load or run

You need to ensure that you have the correct system software loaded on your analyzer.

- Ensure that the inverse assembler is on the same disk as the configuration files you are loading.

Configuration files for the state analyzer contain a pointer to the location of the corresponding inverse assembler. If you delete the inverse assembler or move it to another location, the configuration process will fail.

- Make sure you are using the version of the inverse assembler software that corresponds to the operating system revision installed on your analyzer.

See your Preprocessor User's Guide for details.

---

## Error Messages

This section lists some of the messages that the analyzer displays when it encounters a problem.

---

### ". . . Inverse Assembler Not Found"

This error occurs if you rename or delete the inverse assembler file that is attached to the configuration file. Ensure that the inverse assembler file is not renamed or deleted, and that it is on the same flexible disk or in the same directory as the configuration file.

---

### "No Configuration File Loaded"

This is usually caused by trying to load a configuration file for one type of module or the system into a different type of module.

- Verify that the appropriate module has been selected as the target of the Load operation. Selecting Load All will cause incorrect operation when loading most preprocessor interface configuration files.

#### See Also

"To Load a Measurement Configuration" in chapter 6, "File Management."

---

### "Selected File is Incompatible"

This occurs when you try to load a configuration file for the wrong module. Ensure that you are loading a translatable configuration file for your logic analyzer.

---

## "Slow or Missing Clock"

- This error might occur if the target system is not running properly. Ensure that the target system is on and operating properly.
- Check your State clock configuration. The proper clocking scheme should be listed in your preprocessor interface User's Guide.
- If the error message persists, check that the logic analyzer pods are connected to the proper connectors. See the User's Guide for your preprocessor interface to determine the proper connections.

---

## "Waiting for Trigger"

If a trigger pattern is specified, this message indicates that the specified trigger pattern has not occurred. Verify that the triggering pattern is correctly set.

- When analyzing microprocessors that fetch only from long-word aligned addresses, if the trigger condition is set to look for an opcode fetch at an address not corresponding to a long-word boundary, the trigger will never be found.

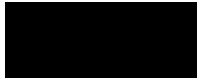

**"Must have at least 1 edge specified"**

---

**"Must have at least 1 edge specified"**

You must assign at least one clock edge to one of the available clocks in the clocking arrangement. The analyzer will not let you close the clock assignment pop-up until an edge is specified.

---

**"Time correlation of data is not possible"**

To time-correlate data, it must be stored with time tags.

- Set the Count field in the Analyzer Trigger menu to Time.

---

**"Maximum of 32 channels per label"**

You have tried to assign more than 32 channels to a single label.

- Unassign some of the channels. If you need more than 32 channels to specify trigger conditions, you can AND terms in the Analyzer Trigger menu.

---

### "Timer is off in sequence level n where it is used"

If you use timers as part of your trigger sequence, you must remember to turn them on using Timer Control in the Sequence Level pop-up menu.

- Check that your timers are turned on. The timer status is shown in the right side of the Sequence Level display of the Trigger menu. An "S" means "Start", "P" means "Pause", "C" means "Continue", and "-" means "off".

---

### "Timer is specified in sequence, but never started"

This message often appears with "Timer is off in sequence level n where it is used," but is not quite the same. That message refers to a particular sequence level, but this message is a general warning that the timer has not been set to Start in any level.

- Start the timer in one of the levels before where it is used.

---

### "Inverse assembler not loaded - bad object code."

The inverse assembler file has been corrupted.

- Try loading a different copy of the inverse assembler.

---

## "Measurement Initialization Error"

The logic analyzer failed its internal hardware calibration.

- Run the Performance Verification tests.

### See Also

Chapter 12, "Operator's Service," or the *HP 1660C/CS-Series Logic Analyzers Service Guide* for information on running the Performance Verification test.

---

## "Warning: Run HALTED due to variable change"

This message appears when certain analyzer settings are changed during a repetitive run. When this occurs, the analyzer stops.





## Specifications

---

# General Information

This chapter lists the accessories, specifications, and characteristics for the HP 1660CS-series logic analyzers.

---

## Accessories

The following accessories are supplied with the HP 1660CS-series logic analyzers. The part numbers are current as of the edition of the User's Guide, but future upgrades may change the part numbers. Do not be concerned if the accessories you receive have different part numbers.

<b>Accessories supplied</b>	<b>HP part number</b>	<b>Qty</b>
Probe tip assemblies	01650-61608	Note 1
Probe cables	01660-61605	Note 2
Grabbers (20 per pack)	5090-4356	Note 1
Probe ground (5 per pack)	5959-9334	Note 1
Logic Analyzer Training Kit	E2433-60009	1
HP 1660CS User's Guide	01660-99019	1
Symbol Utility (disk and manual)	E2450A	1
Accessories pouch	01660-84501	1
RS-232-C loopback connector	01650-63202	1
PS2 mouse	A2839B	1
10:1 probes	10430A	2
BNC miniprobe adapter	1250-1454	1

Note 1 Quantities:	8 - 1660CS	Note 2 Quantities:	4 - 1660CS
	6 - 1661CS		3 - 1661CS
	4 - 1662CS		2 - 1662CS
	2 - 1663CS		1 - 1663CS

---

## Specifications (logic analyzer)

The specifications are the performance standards against which the product is tested. Refer to the *HP 1660C/CS Logic Analyzers Service Guide*, available from your HP sales office, for testing procedures.

Maximum state speed	100 MHz
Minimum state clock pulse width *	3.5 ns
Minimum master to master clock time *	10.0 ns
Minimum glitch width*	3.5 ns
Threshold accuracy	± (100 mV + 3% of threshold setting)

**Setup/Hold time:\***

Single clock, single edge	0.0/3.5 ns through 3.5/0.0 ns, adjustable in 500-ps increments
Single clock, multiple edges	0.0/4.0 ns through 4.0/0.0 ns, adjustable in 500-ps increments
Multiple clocks, multiple edges	0.0/4.5 ns through 4.5/0.0 ns, adjustable in 500-ps increments

\* Specified for an input signal  $V_H = -0.9$  V,  $V_L = -1.7$  V, slew rate = 1 V/ns, and threshold = -1.3 V.

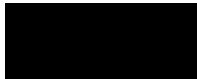

---

## Specifications (oscilloscope)

Specifications are valid within  $\pm 10^\circ \text{C}$  of auto-calibration temperature, excluding bandwidth—see note 1 for bandwidth specification.

The oscilloscope includes the following specifications:

<b>Bandwidth</b> <sup>(1)</sup>	dc to 250 MHz (real time, dc-coupled)
<b>Time interval measurement accuracy</b> <sup>(2)</sup>	$\pm[(0.005\% \times \Delta t) + (2 \times 10^{-6} \times \text{delay setting}) + 150 \text{ ps}]$
<b>DC offset accuracy</b>	$\pm(1.0\% \text{ of channel offset} + 2.0\% \text{ of full scale})$
<b>Voltage measurement accuracy</b> <sup>(3)</sup>	$\pm [(1.5\% \text{ of full scale} + \text{offset accuracy}) + (0.008 \times \text{V/div})]$
<b>Trigger sensitivity</b>	<b>dc to 50 MHz: 0.063 x full scale,</b> <b>50 to 250 MHz: 0.125 x full scale</b>
<b>Input R (selectable)</b>	<b>1 M<math>\Omega</math>: <math>\pm 1\%</math>, 50 <math>\Omega</math>: <math>\pm 1\%</math></b>

1. Upper bandwidth reduces by 2.5 MHz for every degree C above  $35^\circ \text{C}$ .

2. Specification applies to the maximum sampling rate. At lower rates, the specification is:  $\pm [(0.005\% \times \Delta t) + (2 \times 10^{-6} \times \text{delay setting}) + (0.15 \times \text{sample interval})]$  for bandwidth limited signals ( $t_r = 1.4 \times \text{sample interval}$ ).

Sample interval is defined as  $\frac{1}{\text{samplerate}}$

3. Digitizing level =  $(\# \text{vertical divisions}) \left(\frac{1}{2}\right) \left(\frac{1}{\text{LSB}}\right)$ , where  $\text{LSB} = 2^{\# \text{bits in ADC}}$

## Characteristics (logic analyzer)

These characteristics are not specifications, but are included as additional information.

	<b>Full Channel</b>	<b>Half Channel</b>
Maximum state clock rate	100 MHz	100 MHz
Maximum conventional timing rate	250 MHz	500 MHz
Maximum transitional timing rate	125 MHz	250 MHz
Maximum timing with glitch rate	N/A	125 MHz
Memory depth	4K	8K*
Channel count:		
HP 1660CS	136	68
HP 1661CS	102	51
HP 1662CS	68	34
HP 1663CS	34	17

\* For all modes except glitch.

## Characteristics (oscilloscope)

These characteristics are included as additional information.

<b>Maximum sample rate</b>	1 Gigasample per second
<b>Number of channels</b>	2
<b>Rise Time<sup>(1)</sup></b>	1.4 ns
<b>ADC</b>	8-bit real time
<b>Vertical resolution</b>	8 bits over 4 vertical divisions ( $\pm 0.4\%$ )
<b>Waveform record length</b>	8000 points
<b>Vertical (dc) gain accuracy<sup>(2)</sup></b>	$\pm 1.25\%$ of full scale
<b>Input coupling</b>	1 M $\Omega$ : ac and dc, 50 $\Omega$ : dc only
<b>Input Capacitance</b>	Approximately 7 pF

1. Rise time is calculated from the formula:  $t_r = \frac{0.35}{bandwidth}$

2. Vertical gain accuracy decreases 0.08% per degree C from software calibration temperature.

---

## Supplemental characteristics (logic analyzer)

### Probes

Input resistance	100 k $\Omega$ , $\pm$ 2%
Input capacitance	$\sim$ 8 pF
Minimum voltage swing	500 mV, peak-to-peak
Threshold range	$\pm$ 6.0 V, adjustable in 50-mV increments, CAT I

### State analysis

State/Clock qualifiers	1660/61C - 6; 1662CS - 4; 1663CS - 2
Time tag resolution*	8 ns or 0.1%, whichever is greater
Maximum time count between states	34 seconds
Maximum state tag count*	$4.29 \times 10^9$

\* Maximum state clock rate with time or state tags on is 100 MHz. When all pods are assigned to a state or timing machine, time or state tags halve the memory depth.

### Timing analysis

Sample period accuracy	0.01 % of sample period
Channel-to-channel skew	2 ns, typical
Time interval accuracy	$\pm$ [sample period + channel-to-channel skew + (0.01%)(time reading)]

### Triggering

Sequence speed	125 MHz, maximum
State sequence levels	12
Timing sequence levels	10
Maximum occurrence counter value	1,048,575
Pattern recognizers	10
Maximum pattern width	136 channels in HP 1660CS, 102 channels in HP 1661CS, 68 channels in HP 1662CS, 34 channels in HP 1663CS
Range recognizers	2

Range width	32 bits each
Timers	2
Timer value range	400 ns to 500 seconds
Glitch/Edge recognizers	2 (timing only)
Maximum glitch/edge width	136 channels in HP 1660CS, 102 channels in HP 1661CS, 68 channels in HP 1662CS, 34 channels in HP 1663CS

### Measurement and display functions

**Displayed waveforms** 24 lines maximum, with scrolling across 96 waveforms.

### Measurement functions

**Run/Stop functions** Run starts acquisition of data in specified trace mode.

**Stop** In single trace mode or the first run of a repetitive acquisition, Stop halts acquisition and displays the current acquisition data. For subsequent runs in repetitive mode, Stop halts acquisition of data and does not change the current display.

**Trace mode** Single mode acquires data once per trace specification. Repetitive mode repeats single mode acquisitions until Stop is pressed or until the time interval between two specified patterns is less than or greater than a specified value, or within or not within a specified range.

### Indicators

**Activity indicators** Provided in the Configuration and Format menus for identifying high, low, or changing states on the inputs.

**Markers** Two markers (X and O) are shown as vertical dashed lines on the display.

**Trigger** Displayed as a vertical dashed line in the Timing Waveform display and as line 0 in the State Listing display.

### Data entry/display

**Labels** Channels may be grouped together and given a 6-character name. Up to 126 labels in each analyzer may be assigned with up to 32 channels per label.

**Display modes** State Listing, State Waveforms, Chart, Compare Listing, Compare Difference Listing, Timing Waveforms, and Timing Listings. State Listing and Timing Waveforms can be time-correlated on the same displays.

**Timing waveform** Pattern readout of timing waveforms at X or O marker.

**Bases** Binary, octal, decimal, hexadecimal, ASCII (display only), two's complement, and user-defined symbols.

**Symbols** 1,000 maximum. Symbols can be downloaded over RS-232 or HP-IB, or the optional LAN.

### Marker functions

**Time interval** The X and O markers measure the time interval between a point on a timing waveform and the trigger, two points on the same timing waveform, two points on different waveforms, or two states (time tagging on).

**Delta states (state analyzer only)** The X and O markers measure the number of tagged states between one state and trigger or between two states.

**Patterns** The X and O markers can be used to locate the nth occurrence of a specified pattern from trigger, or from the beginning of data. The O marker can also find the nth occurrence of a pattern from the X marker.

**Statistics** X and O marker statistics are calculated for repetitive acquisitions. Patterns must be specified for both markers, and statistics are kept only when both patterns can be found in an acquisition. Statistics are minimum X to O time, maximum X to O time, average X to O time, and ratio of valid runs to total runs.

### Auxiliary power

Power through cables 1/3 amp at 5 V maximum per cable



## Supplemental characteristics (oscilloscope)

### Vertical (at BNC)

Vertical sensitivity range (1:1 Probe) 4 mV/div to 10 V/div in 1-2-4 increments

DC offset range (1:1 probe)	<b>Vertical sensitivity</b>	<b>Available offset</b>
	4 mV/div to 100 mV/div	±2 V
	>100 mV/div to 500 mV/div	±10 V
	>500 mV/div to 2.5 V/div	±50 V
	>2.5 V/div to 10 V/div	±250 V



Probe factors Any integer ratio from 1:1 to 1000:1

Maximum safe input voltage 1 MΩ: ±250 V [dc + peak ac (< 10 KHz)], CAT II  
 50 Ω: ±5 VRMS

Channel-to-channel isolation dc to 50 MHz: 40 dB, 50 MHz to 250 MHz: 30 dB

### Timebase

Range 1 ns/div to 5 s/div

Resolution 20 ps

Delay pre-trigger range

<b>Time/div setting</b>	<b>Available delay</b>
1 μs to 5 s/div	-8 x (s/div)
1 ns to 500 ns/div	-4 μs

Delay post-trigger range

<b>Time/div setting</b>	<b>Available delay</b>
100 ms to 5 s/div	2.5 ks
1 μs to 50 ms/div	33,500 x (s/div)
1ns to 500 ns/div	16.7 ms

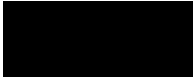

**Triggering**

Trigger level range	Within display window (full scale and offset)
Trigger modes	
Immediate	Triggers immediately after arming condition is met.
Edge	Triggers on rising or falling edge of any internal channel, count adjustable from 1 to 32,000.
Pattern	Triggers on entering or exiting a specified pattern of both internal channels, count adjustable from 1 to 32,000.
Pattern duration	Triggers on pattern duration specified across one or both channels. Modes are "Present<", "Present>", and "Range." Patterns longer than 20 ns but shorter than 160 ms can be detected.
Pattern occurrence	Triggers on entering or exiting a specified pattern across one or both channels.
Auto-trigger	If enabled, the module will self-trigger if no trigger condition is found within approximately 50 ms after arming.
Events delay	The trigger can be set to occur on the nth edge or pattern, as specified by the user. The number of events (n) can be set from 1 to 32,000 events. Maximum count frequency is 70 MHz.
Intermodule	Arms another measurement module or triggers the rear panel BNC.
External	If enabled, the oscilloscope will trigger on an ECL level signal (-1.3 V).

**Digitizer**

Resolution	8 bits (1 part in 256)
Digitizing rate	Up to 1 Gigasample per second
Digitizing technique	Real-time digitizing; each 8000 samples are acquired on a single acquisition
Acquisition memory size	8000 samples per channel

**Waveform display**

Displayed waveforms	Eight waveform windows maximum, with scrolling across 96 waveforms.
Display formats	Waveforms can be displayed in an overlapping and/or non-overlapping format. Display capability of A-B and A+B is also provided.
Display resolution	500 points horizontal, 240 points vertical.

**Display modes**

Normal (single)	New acquisition replaces old acquisition on screen.
Accumulate	New acquisition is displayed in addition to previous acquisitions until screen is erased.
Average	New acquisitions are averaged with old acquisitions, with the updated waveform displayed until erased. Maximum number of averages is 256.
Overlay	Up to 8 acquired waveforms from separate channels can be overlaid in the same display area.
Connect-the-dots	Provides a display of the sample points connected by straight lines.
Waveform reconstruction	When there is insufficient data to fill every horizontal location, a post acquisition reconstruction filter fills in missing data points for time base < 50 ns/div.
Waveform math	Display capability of A-B and A+B functions is provided.

**Measurement and display functions**

**Time markers** Two vertical markers, X and O, are provided for measurements of time and voltage. Capabilities are: measure voltage at point where X and O markers cross each analog waveform; measure time from trigger to X, trigger to O, and X to O; automatic marker placement by specifying percentage of edge, edge number, and rising or falling edge type; run until X to O > than, < than, in range, and not in range provides selective event search; X to O statistics (mean, max, and min) provide analysis of time interval deviation.

**Voltage markers** Two horizontal markers, A and B, are provided for voltage measurements. These markers can each be placed on any acquisition channel trace. A delta voltage display provides delta V between markers on the same channel or between channels.

**Automatic search** Searches for a percentage voltage level at a positive or negative edge, count adjustable from 1 to 100.

**Auto search statistics** Mean, maximum, and minimum values for elapsed time from X to O markers for multiple runs. Number of valid runs and total number of runs available.

**Automatic measurements** The following pulse parameter measurements can be performed automatically:

Frequency	Rise time	+ pulse width
Period	Fall time	-pulse width
V p-p	Preshoot	V amplitude*
	Overshoot	

(\*gives difference between top and base voltages; only available over the HP-IB bus)

**Grid** Graticules can be displayed in background of waveform.

### Setup aids

**Autoscale** Autoscales the vertical and horizontal ranges, offset, and trigger level to display the input signals. Requires a frequency between 50 Hz and 250 MHz.

**Presets** Scales the vertical range, offset, and trigger level to predetermined values for displaying ECL or TTL waveforms.

**Calibration** Vertical, trigger, delay, and all defaults. Calibration factors stored in nonvolatile RAM on the circuit board.

**Probe compensation source** External BNC supplies a square wave approximately 0.0 mV to -800 mV into the open circuit at approximately 1000 Hz.

## Operating environment

<b>Temperature</b>	Instrument, 0 °C to 55 °C (+32 °F to 131 °F). Probe lead sets and cables, 0 °C to 65 °C (+32 °F to 149 °F). Flexible disk media, 10 °C to 40 °C (+50 °F to 104 °F)
<b>Humidity</b>	Instrument, probe lead sets, and cables, up to 80% relative humidity at +40 °C (+122 °F).
<b>Altitude</b>	To 3067 m (10,000 ft).
<b>Vibration</b>	<b>Operating:</b> Random vibration 5 to 500 Hz, 10 minutes per axis, ≈0.3 g (rms).  <b>Non-operating:</b> Random vibration 5 to 500 Hz, 10 minutes per axis, ≈ 2.41 g (rms); and swept sine resonant search, 5 to 500 Hz, 0.75 g (0-peak), 5 minute resonant dwell at 4 resonances per axis.

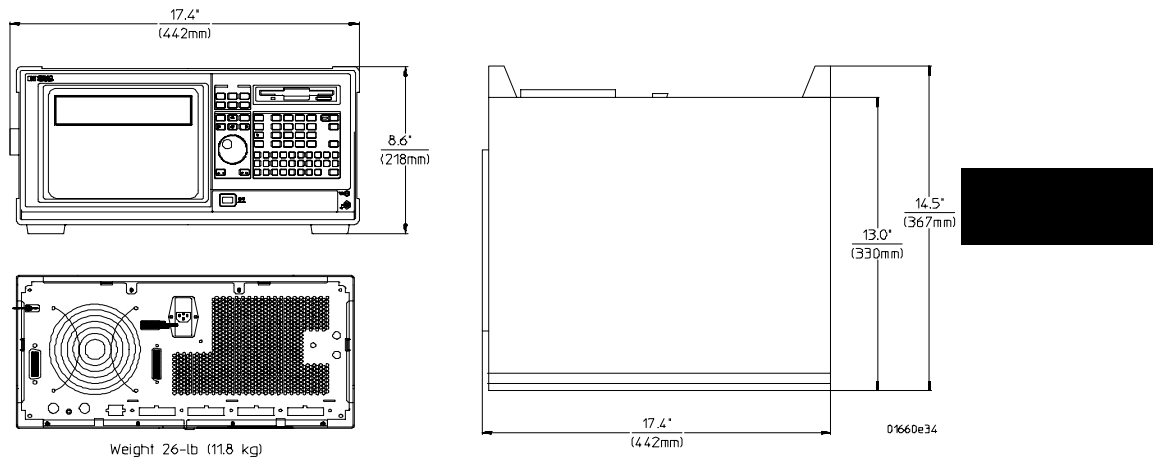

## Dimensions





Operator's Service

---

## Operator's Service

This chapter provides the operator with information on how to prepare the logic analyzer for use, and contains self-tests and flow charts used for troubleshooting the logic analyzer.

The *HP 1660C/CS-Series Logic Analyzers Service Guide* contains detailed service procedures. Service guides can be ordered through your HP Sales Office; they are not shipped with the logic analyzer.



---

# Preparing For Use

This section gives you instructions for preparing the logic analyzer for use.

## **Power requirements**

The logic analyzer requires a power source of either 115 Vac or 230 Vac, -22% to +10%, single phase, 48 to 66 Hz, 200 Watts maximum power.

## **Operating environment**

The operating environment is listed in chapter 11. Note the noncondensing humidity limitation. Condensation within the instrument can cause poor operation or malfunction. Provide protection against internal condensation.

The logic analyzer will operate at all specifications within the temperature and humidity range given in chapter 11. However, reliability is enhanced when operating the logic analyzer within the following ranges:

- Temperature: +20 °C to +35 °C (+68 °F to +95 °F)
- Humidity: 20% to 80% noncondensing

## **Storage**

Store or ship the logic analyzer in environments within the following limits:

- Temperature: -40 °C to +75 °C
- Humidity: Up to 90% at 65 °C
- Altitude: Up to 15,300 meters (50,000 feet)

Protect the logic analyzer from temperature extremes which cause condensation on the instrument.

## To inspect the logic analyzer

**1 Inspect the shipping container for damage.**

If the shipping container or cushioning material is damaged, keep them until you have checked the contents of the shipment and checked the instrument mechanically and electrically.

**2 Check the supplied accessories.**

Accessories supplied with the logic analyzer are listed in "Accessories" in chapter 11.

**3 Inspect the product for physical damage.**

Check the logic analyzer and the supplied accessories for obvious physical or mechanical defects. If you find any defects, contact your nearest Hewlett-Packard Sales Office. Arrangements for repair or replacement are made, at Hewlett-Packard's option, without waiting for a claim settlement.

---

## To apply power

**1 Check that the line voltage selector, located on the rear panel, is on the correct setting and the correct fuse is installed.**

See also, "To set the line voltage" on the next page.

**2 Connect the power cord to the instrument and to the power source.**

This instrument is equipped with a three-wire power cable. When connected to an appropriate ac power outlet, this cable grounds the instrument cabinet. The type of power cable plug shipped with the instrument depends on the country of destination.

**3 Turn on the instrument power switch located on the front panel.**

---

## To set the line voltage

When shipped from HP, the line voltage selector is set and an appropriate fuse is installed for operating the instrument in the country of destination.

---

### CAUTION

---



- 1 Turn the power off, then remove the power cord from the instrument.
- 2 Remove the fuse module by carefully prying at the top center of the fuse module until you can grasp it and pull it out by hand.

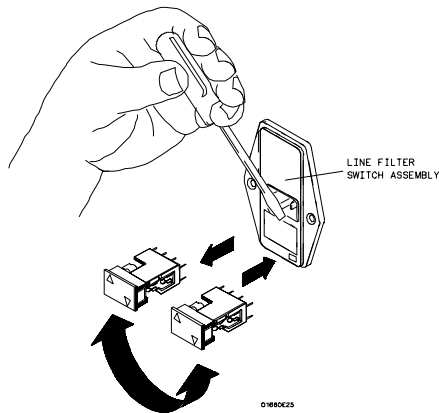

- 3 Reinsert the fuse module with the arrow for the appropriate line voltage aligned with the arrow on the line filter assembly switch.

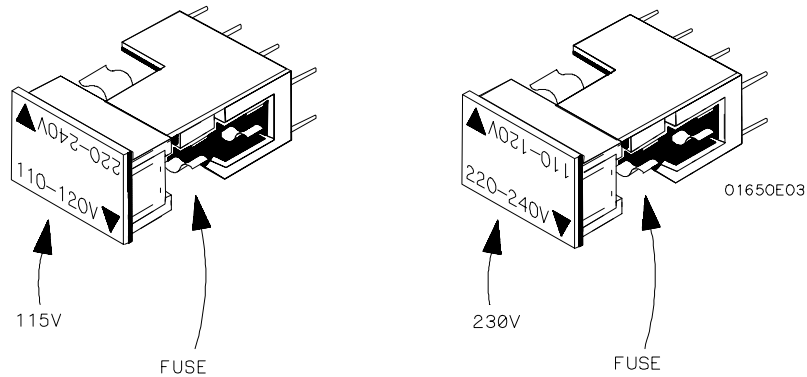

- 4 Reconnect the power cord and turn the instrument on.

### To degauss the display

If the logic analyzer has been subjected to strong magnetic fields, the CRT might become magnetized and display data might become distorted. To correct this condition, degauss the CRT with a conventional external television type degaussing coil.

---

### To clean the logic analyzer

With the instrument turned off and unplugged, use mild soap and water to clean the front and cabinet of the logic analyzer. Harsh soap might damage the water-base paint. Do not immerse the logic analyzer in water.

---

### To test the logic analyzer

- If you require a test to verify the specifications, the *HP 1660C/CS Series Logic Analyzers Service Guide* is required. Start at the beginning of chapter 3, "Testing Performance."
- If you require a test to initially accept the operation, perform the self-tests described in Troubleshooting in this chapter.
- If the logic analyzer does not operate correctly, go to the flow charts provided in Troubleshooting in this chapter.

---

## Calibrating the oscilloscope

---

### Equipment Required

---

Equipment	Critical Specification	Recommended Model/Part	Qty
Cable (2)	BNC, 9-inch (equal length)	HP 10502A	1
Cable	50 $\Omega$ BNC (m-to-m) 48-inch	HP 10503A	1
Adapter	BNC tee (m)(f)(f)	HP 1250-0781	1
Adapter	BNC (f)(f) (ug-914/u)	HP 1250-0080	1

---

---

### Set up the equipment

Turn on the logic analyzer. Let it warm up for 30 minutes if you have not already done so.

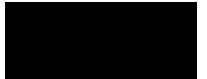

## Load the default calibration factors

Note that once the default calibration factors are loaded, all calibrations must be done. This includes all of the calibrations in the Self Cal menu. The calibration must be performed in the exact sequence listed below.

- 1 Go to the Scope Calibration menu.
- 2 Select the Mode field, then select Service Cal from the pop-up menu.
- 3 Select the Procedure field, then select Default Values from the pop-up menu.
- 4 Select the Start field and follow the instructions on the display.

The screenshot shows the 'Scope Calibration' menu with several options: Scope, Scope Calibration, Autoscale, Print, and Run. Below these are two pop-up menus: 'Mode Service Cal' and 'Procedure Default Values'. At the bottom are 'Start' and 'Continue' buttons. A table displays the calibration status for various functions.

FUNCTION	C1	C2
A/D	D	D
Gain	D	D
Offset	D	D
Hysteresis	D	D
Trigger	D	D
Delay	D	D
Time Null		D
Logic Trigger	D	

P = passed, F = failed, D = defaulted, C = corrupted  
Prefixed by \* if new software revision without re-cal

After you select the Start field, you can abort the calibration procedure by selecting either the Mode or Procedure fields if the Continue field is still displayed on the screen.

---

## Self Cal menu calibrations

Messages will be displayed as each calibration routine is completed to indicate calibration has passed or failed. The resulting calibration factors are automatically stored to nonvolatile RAM at the conclusion of each calibration routine.

The Self Cal menu lets you optimize vertical sensitivity (Vert Cal) for channels 1 and 2 individually or both channels on a board simultaneously. Also, the Self Cal menu lets you optimize delay (Delay) for channel 1 and 2 separately, then Time Null for channel 2 and the Logic Trigger.

### 1 Optimize Vert Cal of the Self Cal.

- a** Connect two BNC 50- $\Omega$ , 9-inch cables to the BNC tee adapter. Connect the BNC 50 $\Omega$  (f)(f) adapter to the BNC tee adapter, and connect the 48-inch BNC cable to the BNC 50 $\Omega$  (f)(f) adapter. Once you select Start, the instrument will prompt you to connect the cables to the appropriate locations on the rear panel of the instrument.
- b** Select the Mode field, then select Self Cal from the pop-up menu.
- c** Select the Procedure field, then select Vert Cal from the pop-up menu.
- d** Select the Channel field, then select a channel choice from the pop-up menu.
- e** Select the Start field and follow the instructions on the display.
- f** After completion of Vertical Calibration, remove the cables from the instrument.

### 2 Optimize Delay of the Self Cal.

- a** Obtain a BNC 50- $\Omega$ , 48-inch cable. Once you select Start, the instrument will prompt you to connect the cable to the appropriate location on the rear panel of the instrument.
- b** Select the Procedure field, then select Delay from the pop-up menu.
- c** Select the Channel field, then select C1.
- d** Select the Start field and follow the instructions on the display.
- e** Repeat steps c and d for channel 2.
- f** After completing all of the channel delay calibrations, remove the cable from the oscilloscope.

- 3 Optimize the Time Null of the Self Cal.**
  - a** Connect two BNC 50- $\Omega$ , 9-inch cables to the BNC tee adapter. Connect the BNC 50 $\Omega$  (f)(f) adapter to the BNC tee adapter, and connect the 48-inch BNC cable to the BNC 50 $\Omega$  (f)(f) adapter. Once you select Start, the instrument will prompt you to connect the cables to the appropriate locations on the rear panel of the instrument.
  - b** Select the Procedure field, then select Time Null from the pop-up menu.
  - c** Select the Start field and follow the instructions on the display.
  - d** After completion of the Time Null calibration, remove the cables from the instrument.
- 4 Calibrate the Logic Trigger of the Self Cal.**
  - a** Obtain a BNC 50- $\Omega$ , 48-inch cable.
  - b** Select Start. The instrument will prompt you to connect the cable to the appropriate location on the rear panel of the instrument.
  - c** Select the Procedure field, then select Logic Trigger from the pop-up menu.
  - d** Select the Start field and follow the instructions on the display.
  - e** After completion of the Logic Trigger calibration, remove the cable from the instrument.



---

## Troubleshooting

This section helps you troubleshoot the logic analyzer to find the problem. The troubleshooting consists of flowcharts, self-test instructions, and tests.

If you suspect a problem, start at the top of the first flowchart. During the troubleshooting instructions, the flowcharts will direct you to perform other tests.

This instrument can be returned to Hewlett-Packard for all service work, including troubleshooting. Contact your nearest Hewlett-Packard Sales Office for more details.



## To use the flowcharts

Flowcharts are the primary tool used to isolate problems in the logic analyzer. The flowcharts refer to other tests to help isolate the trouble. The circled letters on the charts indicate connections with the other flowcharts. Start your troubleshooting at the top of the first flowchart.

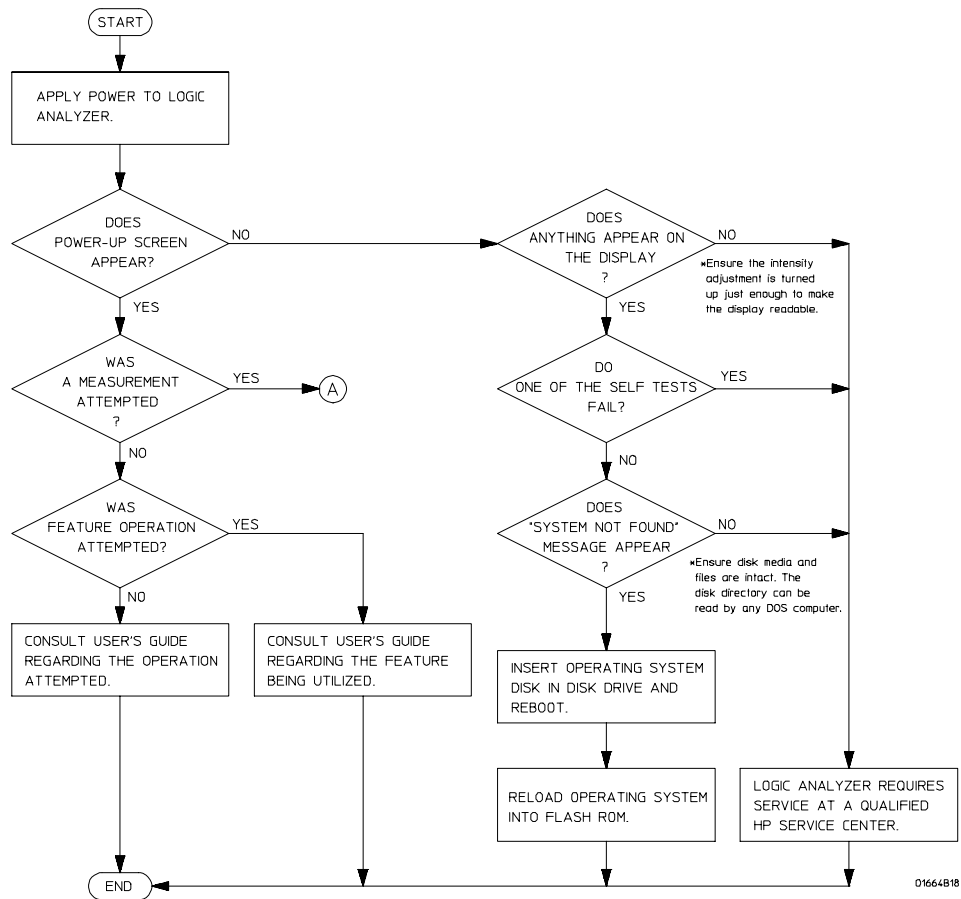

Troubleshooting Flowchart 1

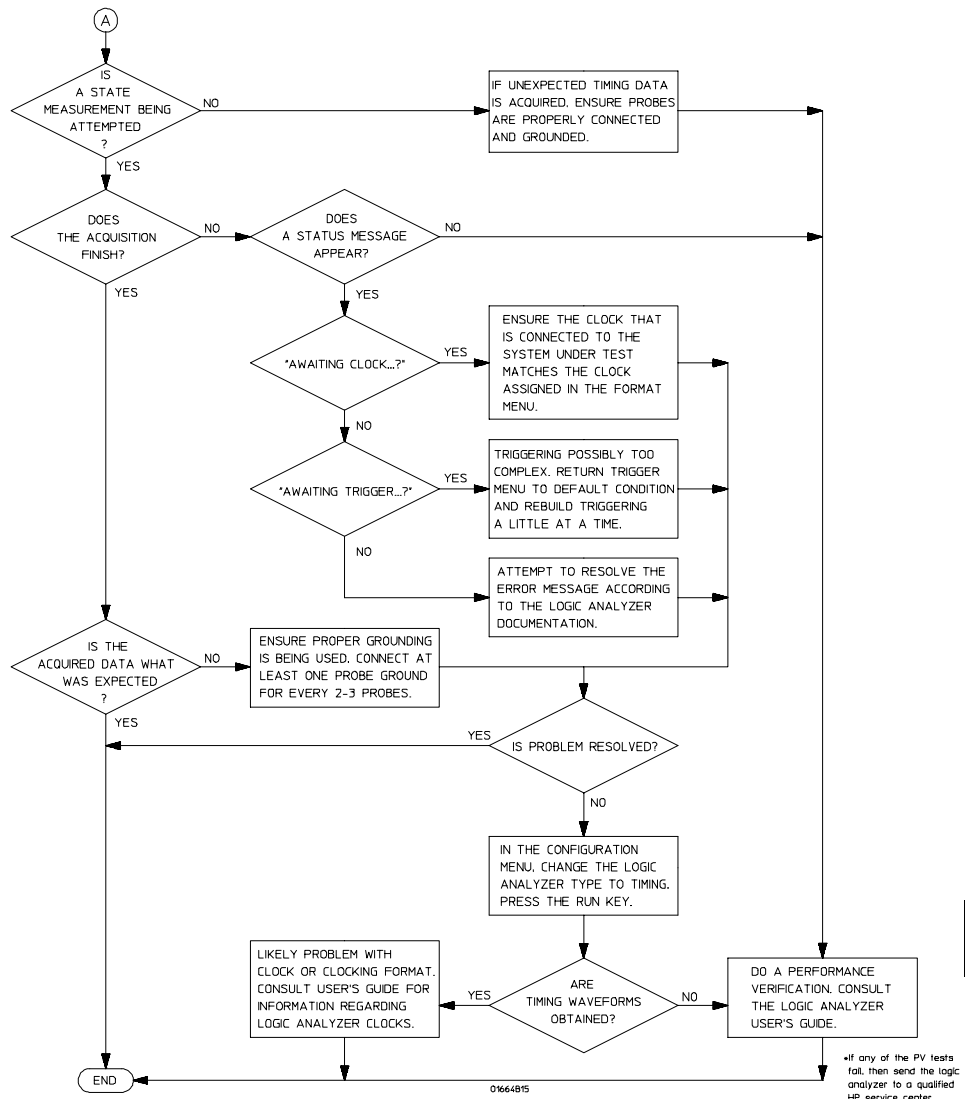

Troubleshooting Flowchart 2

## To check the power-up tests

The logic analyzer automatically performs power-up tests when you apply power to the instrument. The revision number of the operating system shows in the upper-right corner of the screen during these power-up tests. As each test completes, either "passed" or "failed" prints on the screen in front of the name of each test.

- 1 Disconnect all inputs, then insert a formatted disk into the flexible disk drive.**
- 2 Let the instrument warm up for a few minutes, then cycle power by turning off then turning on the power switch.**

If the instrument is not warmed up, the power-up test screen will complete before you can view the screen.

- 3 As the tests complete, check if they pass or fail.**

The Flexible Disk Test reports No Disk if a disk is not in the disk drive.

### Performing Power-Up Self-Tests

passed	ROM test
passed	RAM test
passed	Interrupt test
passed	Display test
passed	PS2 Controller Test
passed	Hard Disk Test
No Disk	Flexible Disk Test

---

## To run the self-tests

Self-tests identify the correct operation of major functional areas of the instrument. You can run all self-tests without accessing the interior of the instrument. If a self-test fails, the troubleshooting flowcharts instruct you to change a part of the instrument.

These procedures assume the files on the PV disk have been copied to the /SYSTEM subdirectory on the hard disk drive. If they have not already been copied, insert the PV disk in the flexible disk drive before starting this procedure.

- 1 If you just did the power-up self-tests, go to step 2.

If you did not just do the power-up self-tests, disconnect all inputs, then turn on the power switch. Wait until the power-up tests are complete.

- 2 Press the System key, then select the field next to System. Then, select Test in the pop-up menu.

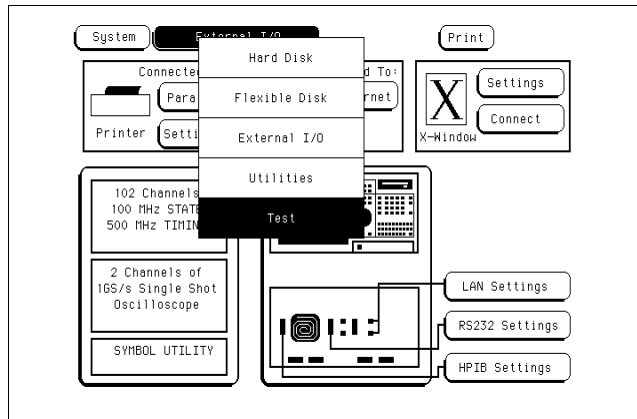

- 3 Select the box labeled Load Test System, then select Continue.

- 4 Press the System key, then select the field next to Sys PV. Select System Test to access the system tests.

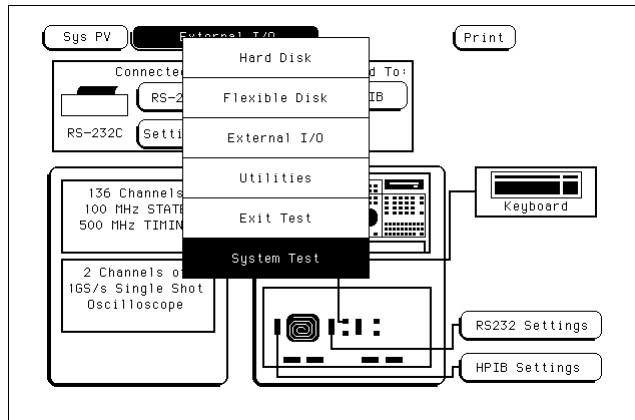

- 5 Select ROM Test. The ROM Test screen is displayed.

You can run all tests at one time by running All System Tests. To see more details about each test, you can run each test individually. This example shows how to run an individual test.

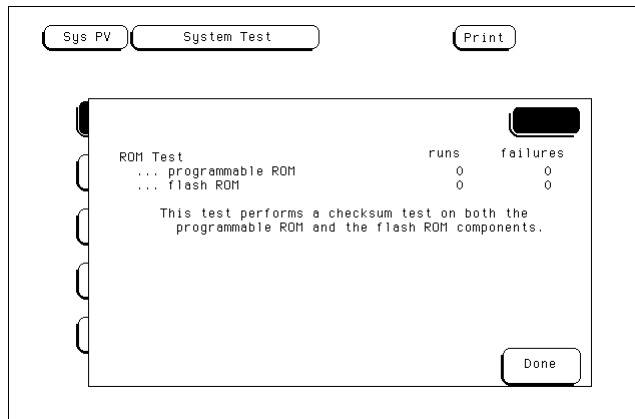

**6 Select Run, then select Single.**

To run a test continuously, select Repetitive. Select Stop to halt a repetitive test.

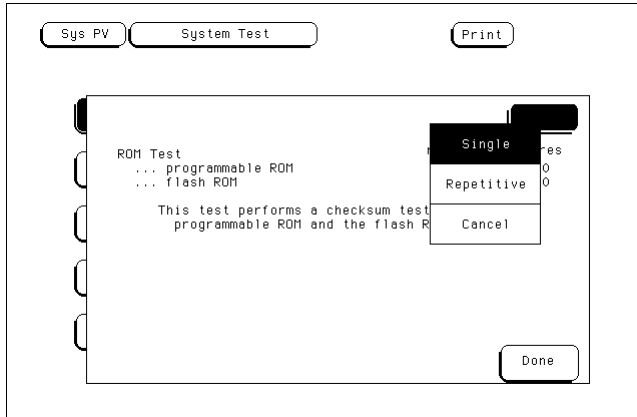

For a Single run, the test runs one time, and the screen shows the results.

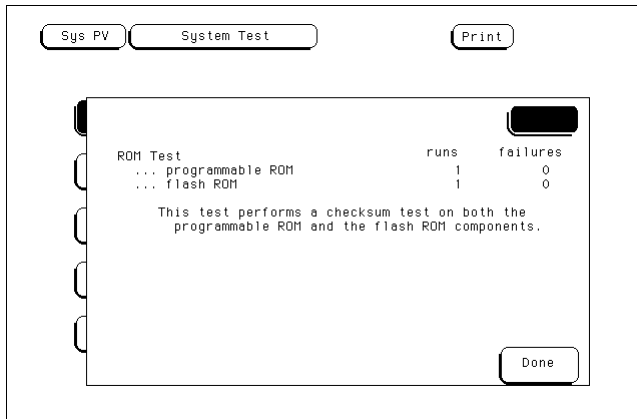

- 7 To exit the ROM Test, select Done. Note that the status changes to PASSED or FAILED.

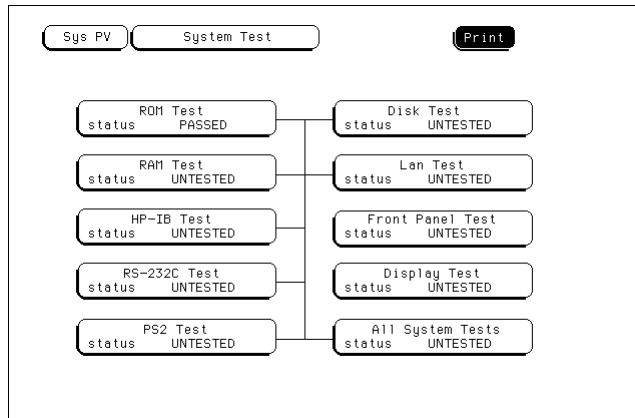

- 8 Install a formatted disk that is not write-protected into the flexible disk drive. Connect an RS-232-C loopback connector onto the RS-232-C port. Run the remaining System Tests in the same manner.

- 9 Select the Front Panel Test.

A screen duplicating the front-panel appears on the screen.

- a Press each key on the front panel. The corresponding key on the screen will change from a light to a dark color.
- b Test the knob by turning it in both directions.
- c Note any failures, then press the Done key a second time to exit the Front Panel Test. The test screen shows the Front Panel Test status changed to TESTED.

- 10 Select the Display Test.

A white grid pattern is displayed. These display screens can be used to adjust the display.

- a Select Continue and the screen changes to full bright.
- b Select Continue and the screen changes to half bright.
- c Select Continue and the test screen shows the Display Test status changed to TESTED.



**11 Select Sys PV, then select Analy PV in the pop-up menu. Select Chip 2 Tests.**

You can run all the analyzer tests at one time by selecting All Analyzer Tests. To see more details about each test, you can run each test individually. This example shows how to run Chip 2 Tests. Chip 3, 4, and 5 Tests operate the same as Chip 2 Tests.

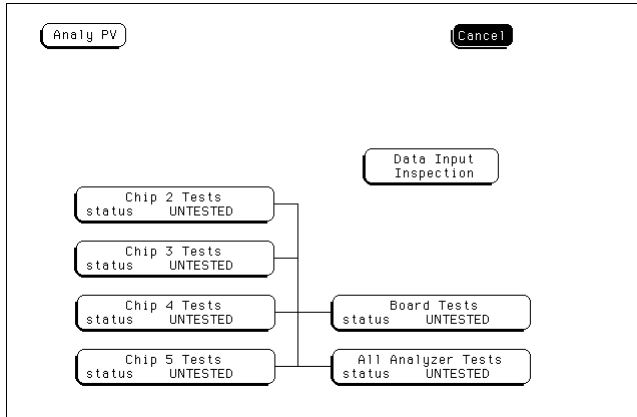

**12 In the Chip 2 Tests menu, select Run, then select Single. The test runs one time, then the screen shows the results. When the test is finished, select Done. Then, perform the other Chip Tests.**

To run a test continuously, select Repetitive. Select Stop to halt a Run Repetitive.

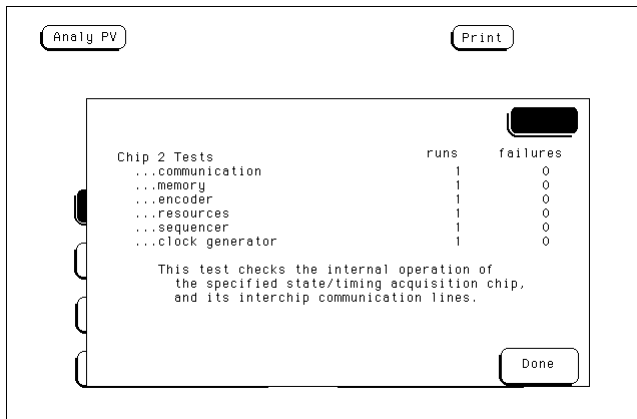

- 13** Select Board Tests, then select Run. When the Board Tests are finished, select Done.

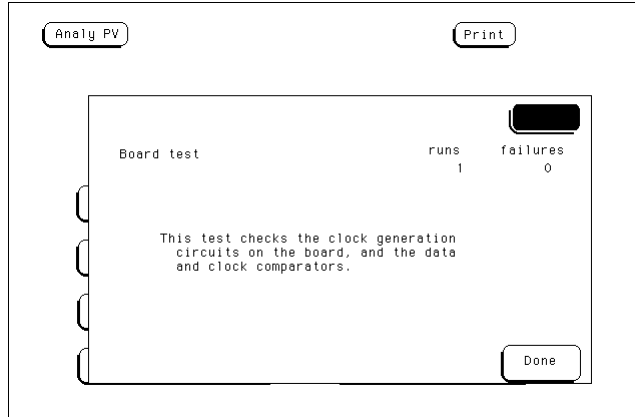

- 14** Select Data Input Inspection. All lines should show activity. Select Done to exit the Data Input Inspection.

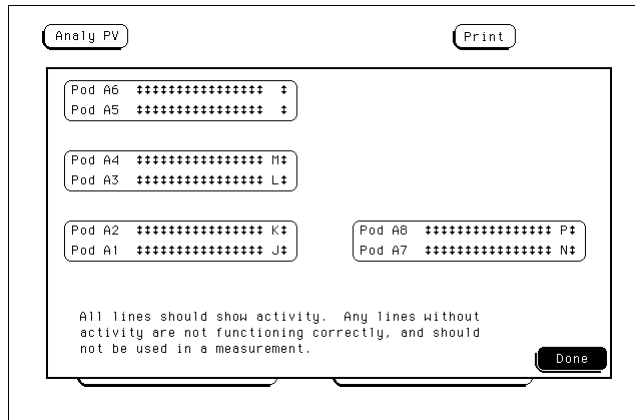

- 15** Select Analy PV, then select Scope PV in the pop up menu. Select Functional Tests.

**16** Select one of the Scope PV tests.

You can run all of the tests at one time by selecting All Tests, or you can run each test individually. For this example, select Data Memory Test.

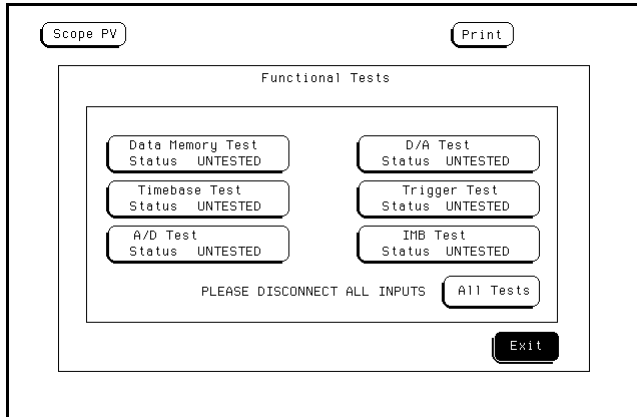

**17** In the Data Memory Test menu, select Run, then select Single. The test runs one time, then the screen shows the results. When the test is finished, select Done.

To run a test continuously, select Repetitive. Select Stop to halt a Repetitive Run.

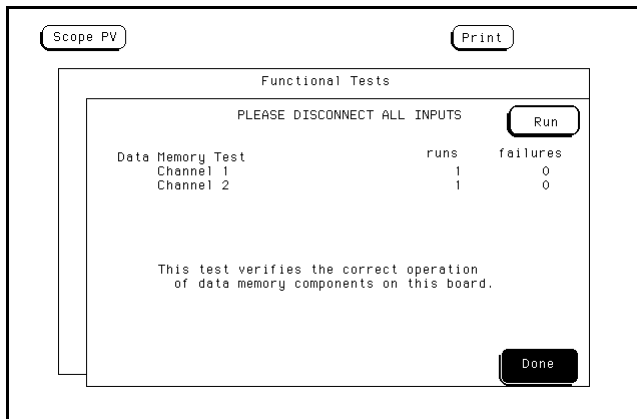

**15** To exit the tests, press the System key. Select the field to the right of the Sys PV field.

**16** Select the Exit Test System.

If you are performing the self-tests as part of the troubleshooting flowchart, return to the flowchart.

---

## To test the auxiliary power

The +5 V auxiliary power is protected by a current overload protection device. If the current on pins 1 and 39 exceed 0.33 amps, the circuit will open. When the short is removed, the circuit will reset in approximately 1 minute. There should be +5 V after the 1 minute reset time.

---

### Equipment Required

---

Equipment	Critical Specifications	Recommended Model/Part
Digital Multimeter	0.1 mV resolution, better than 0.005% accuracy	HP 3478A

- Using the multimeter, verify the +5 V on pins 1 and 39 of the probe cables.

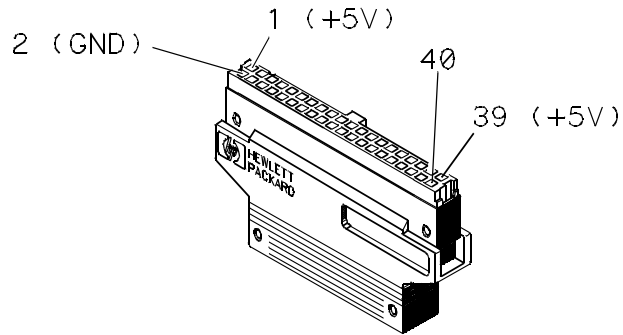

MISC/EX50

---

## Glossary

**benchtop logic analyzer** A small, standalone HP logic analyzer that is not part of the HP 16500 logic analysis system.

**bit** The information the logic analyzer stores for one sample of one physical line. Bits are either "low" or "high." See also channel.

**bucket** In the SPA State Overview mode, an individual subrange of states displayed on the histogram's X axis.

**channel** The analyzer's mapping of a single physical line. Channel is often used interchangeably with bit. Channels are grouped into labels in the Analyzer Format menu.

**don't care** Signifies that the signal state should be ignored. "Don't cares" are represented by "X" in assignment fields.

**glitch** A pulse of very short duration, usually less than the setup or hold time. To the logic analyzer, a glitch is two or more transitions across the logic threshold between consecutive samples.

**label** A name for a group of functionally-related channels. Three common labels, which are required by HP preprocessor interface inverse assemblers, are ADDR, DATA, and STAT. If a label is on, it appears in all display menus and the Trigger menu, enabling you to quickly display, store, or trigger on information of interest. See also symbol and term.

**listing** An alphanumeric display of state information. See also trace and waveform.

**menu field** The field to the right of the mode field. The menu field allows you to set up the instrument selected in the mode field.

**mode field** Also known as module field. The field in the upper-left corner of the logic analyzer. This field selects the mode, such as "Analyzer" or "System."

**module field** See mode field.

**OMF Symbol Table** OMF stands for Object Module File. The HP E2450A Symbol Utility uses the OMF to produce a table of symbols in the executable.

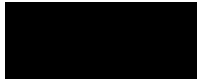

**storage qualification** Storage qualification allows you to specify the type of information to be stored in memory. Use storage qualification to prevent memory from being filled with unwanted activity.

**symbol** An alphanumeric name given to a specified bit-pattern or range for the bits in a particular label (see label). A label can have many symbols, each having a different meaning. For example, if the CYCLE label includes the bits for the Read/Write (R/W) and I/O signals, one symbol might be I/O READ, with I/O and R/W both high, while another symbol might be I/O WRITE, with I/O high and R/W low. Symbols are named and specified in the Format menu. Symbols are available only when the associated label is on. Symbols are also available for defining trigger terms. See also label and term.

**term** A resource for specifying storage conditions or trigger conditions. A term uses the bits in a label to identify the condition for storage or triggering. If symbols have previously been defined for the label, they can be used as the conditions, or you can specify new patterns or ranges. For example, if the CYCLE label includes the symbols I/O READ and I/O WRITE, term "a" could be I/O

READ and term "b" could be I/O WRITE, and the trigger/storage macro could be to start storing at term "a" and stop storing at term "b."

**trace** The record of target system activity stored by the state or timing analyzer. This record can be displayed as either a waveform or a listing. See also listing and waveform.

**trigger** A reference event around which you want to gather information. In the analyzer, you might want to trigger on a glitch in hardware or entry to a subroutine in software. When beginning, you might want to trigger on the first occurrence of any kind (trigger on "anystate"). As you learn more about the problem you are trying to isolate, you may enter more specific trigger conditions. When you want to gather a continuous stream of activity leading up to a system crash, you will want to trigger on "no state." Note that some microprocessors fetch instructions on 32-bit boundaries. If you are tracing activity of one of these processors, and you specify trigger on an address that is not on a 32-bit boundary, that address will never appear on the address bus; therefore, the analyzer will never find its trigger. Make sure you specify triggers that the analyzer will find. The state

analyzer, timing analyzer, and oscilloscope cannot complete their measurement unless they find a trigger.

**user symbol table** A table containing the symbols that are created by the user, using the Symbols option in the Format menu. This is the standard symbol capability of the HP logic analyzer. See also OMF Symbol Table.

**waveform** An oscilloscope-like display of a trace. Because analyzers only record whether a line is "low" or "high" at the time of sampling, the waveforms are sharp square waves rather than the rough curves of an oscilloscope. See also listing and trace.







---

# Index

---

- \$ indicator, 7-53
  - (<) field less than, 7-49
  - (>) field greater than, 7-49
  - 8-bit vertical voltage resolution, 7-99
  - 8000 samples, 7-71
  
  - A**
  - Accessories, 11-2
  - Accumulate display mode
    - See Display mode, 7-77
  - Accumulate field, 7-60
  - Acquisition control
    - field, 4-17
    - mode types, 7-56
    - trigger position, 7-56
  - Acquisition memory
    - in repetitive run mode, 7-71
    - in single run mode, 7-71
  - Acquisition mode, 7-32, 7-56
  - Activation record, 5-8
  - Address bus, 3-20
  - Address ranges, 5-4
  - Alternate functions
    - accessing, 1-2
  - Analyzer
    - concepts, 9-2
    - configuration capabilities, 7-3 to 7-4
    - invalid combinations, 9-17
    - valid combinations, 9-17
  - Analyzer menu, 3-6
  - Analyzer problems, 10-3
    - capacitive loading, 10-4
    - false errors, 1-5
    - intermittent data errors, 10-3
    - unwanted triggers, 10-3
  - Anystate, 9-14
  - Applying Power, 12-4
  - Arm level, 4-15, 5-24
  - Arm signal, 4-15, 5-23
  - Arming
    - between analyzers, 4-13 to 4-14
  - Arming Control, 1-6, 4-12, 7-54 to 7-55
  - ASCII
    - print to disk, 7-19
  - Asynchronous interrupt request
    - trigger on, 5-27
  - At Level field, 7-91
  
  - Attenuation
    - See Probe attenuation
  - Auto markers options
    - default, 7-90
  - Auto-range, 8-5, 8-16
  - Auto-Trig field, 7-84
  - Auto-Trig Off field, when to use, 7-84
  - Autoload, 7-22, 7-24
  - Automatic markers
    - Run Until Time X-O field default, 7-92
    - Set on field, 7-90
    - Set on field default, 7-90
    - type absolute, 7-91
  - Automatic measurements
    - +Width, 7-100
    - Width, 7-100
    - algorithms, 7-99
    - See also Auto-Measure
    - criteria used for making measurements, 7-98
    - display, 7-97 to 7-98
    - Falltime, 7-101
    - Frequency, 7-100
    - Input field, 7-97
    - measurement setup requirements, 7-98
    - measurements available, 1-8, 3-9, 7-97
    - Overshoot, 7-101
    - Period, 7-100
    - Preshoot, 7-101
    - Risetime, 7-101
    - things to remember, 7-98
    - top and base voltages, 7-99
    - Vp\_p, 7-100
  - Automatic measurements display, 7-97 to 7-98
  - Automatic time markers
    - at Level field default value, 7-91
    - Occur field, default value, 7-91
    - percentage of top-to-base voltage value, 7-90
    - setting, 7-94
    - Slope field, 7-91
    - specific voltage levels, 7-90
    - Statistics field, 7-92
  - Autoscale, 7-72
    - algorithm, 7-72
    - continue, 7-72
    - displaying the waveform, 7-72
    - field options, 7-72
    - finding the time base settings, 7-72
    - finding the vertical settings, 7-72
    - run, 7-71
    - settings changed by, 7-73
    - trigger point location, 7-72
    - when a signal cannot be found, 7-72
  - Auxiliary power, 12-22
  - Average display mode
    - See Display mode
  
  - B**
  - Bar chart, 8-4
  - Base and top voltages, 7-99
  - Baud rate
    - defined, 7-27
  - Bit Editing field, 7-70
  - Bit patterns, 7-49, 7-51
  - Blind time, 8-9
  - Branch conditions, 9-13
  - Branches Taken Stored/Not Stored, 4-17, 7-57
  - Branching, 7-48, 7-50, 7-57
  - Break down/restore macros, 7-43
  - Buckets, 8-4
  - Bus contention, 5-21
  
  - C**
  - Calibration
    - oscilloscope, 12-7
  - Center screen field, 7-95
  - Centronics
    - interface, 7-26 to 7-28
    - printers, 2-8
  - Changing between
    - SPA and a State/Timing Analyzer, 8-30
  - Changing date & time, 7-29
  - Channel label field, 7-96
  - Channel masking, 7-70
  - Channel numbering, 7-42
  - Chart Menu, 7-65 to 7-66
    - label vs label, 7-65
    - label vs state, 7-65
    - markers field, 7-66
    - min and max scaling fields, 7-66
    - post-processing features, 7-65
    - types, 7-65
-

- 
- Chip select lines, 5-29
  - Choosing a label to monitor, 8-21
  - Cleaning, 12-6
  - Clock inputs display, 7-34
  - Clock qualifiers, 7-38
  - Clocks, 1-5
    - as data channels, 7-34
    - demultiplexed clocking arrangement, 7-35
    - master clocking arrangement, 7-35
    - selecting master and slave, 7-37
    - slave clocking arrangement, 7-35
    - state configuration, 7-31
    - timing configuration, 7-31
  - Common Menu Fields, 7-18 to 7-21
    - print field, 7-19
    - run field, 7-20
  - Compare Full/Compare Partial field, 7-69
  - Compare image, 7-68
  - Compare menu, 3-18, 7-67 to 7-70
    - bit editing field, 7-70
    - compare full/compare partial field, 7-69
    - copy trace to compare field, 7-69
    - difference listing field, 7-68
    - find error field, 7-69
    - mask field, 7-70
    - post-processing features, 7-67
    - reference listing field, 7-68
  - Configuration
    - analyzer, 7-25
    - and inverse assembler, 7-25
    - file types, 6-6, 7-25
    - loading, 6-6
    - oscilloscope, 7-25
    - saving, 6-4 to 6-5
    - system, 7-25
  - Configuration Menu, 7-31
    - type: field, 7-31
  - Connect dots field, 7-77
  - Connecting, 1-4
    - controller, 2-9
    - Grabbers to probes, 7-15
    - probe cables to analyzer, 7-12
  - Continue option of autoscale field, 7-72
  - Control signals, 5-24
  - Controller
    - connecting to, 2-9
    - interface defined, 7-26
  - Conventional Acquisition Mode, 7-33
  - Coprocessor systems
    - debugging, 5-29
  - Copy, 7-22
  - Copy Trace to Compare field, 7-69
  - Count field, 4-11, 7-57, 7-83, 7-87
  - Coupling field
    - selections, 7-75
    - setting input impedance, 7-75
  - Cross-arming, 5-22 to 5-29
  - Cursor keys
    - duplicating knob motion, 7-16
  - D**
  - Data
    - correlating, 1-8
    - triggering on bad, 5-11
  - Data bits, 7-28
  - Data bus, 3-20
  - Data points on the horizontal axis, 7-99
  - Data sorting, 8-8
    - and sampling, 8-10, 8-12, 8-15
  - Date
    - Changing, 7-29
  - Default time, 7-29
  - Degaussing the display, 12-6
  - Delay field, 4-18, 7-56, 7-73
    - negative/positive, 7-60
  - Delay time
    - reference point, 7-73
  - Delay-by-events triggering, 7-83
  - Delete, 7-23
  - Description
    - configuration capabilities, 7-3 to 7-4
    - logic analyzer, 7-2
  - Difference Listing field, 7-68
  - Disk drive
    - flexible, 7-22
    - See also Flexible disk drive
    - hard, 7-22
    - See also Hard disk
    - operations, 6-3, 7-22
  - Disk error, 7-24
  - Disk operations
    - autoload, 7-22
    - copy, 7-22
    - duplicate disk, 7-22
    - format disk, 7-22
    - load, 7-22
    - pack disk, 7-23
    - purge, 7-23
    - rename, 7-23
    - store, 7-23
  - Display adjustment, 7-30
  - Display Mode
    - Accumulate, 7-77
    - Average, 7-76
    - Normal, 7-76
    - options, 7-76
  - Display options, 7-76 to 7-78
  - DOS format, 6-3, 7-22, 7-24, 9-4 to 9-5
    - and Pack operation, 7-24
    - file types, 6-8
  - Dotted vertical line, 7-79
  - Duplicate disk, 7-22
  - E**
  - ECL
    - levels, 7-10, 7-32
    - preset values, 7-75
  - Edge terms, 9-15
  - Edge trigger, 3-9, 7-75, 7-79 to 7-80
    - multiple channel, 7-53
    - Auto-Trig field, 7-84
    - Auto-Trig field default, 7-84
    - Count field, 7-83
    - Count field default, 7-83
    - Count field range, 7-83
    - Level field, 7-81
    - Level field, default, 7-82
    - Slope field, 7-83
    - Slope field default, 7-83
    - Source field, 7-82
  - Else-if branch, 9-14
  - Encapsulated PostScript files, 6-8
  - Entry address, 5-4
  - Environment
    - Operating, 12-3
    - Storage, 12-3
  - EPS
    - print to disk, 7-19
  - Epson printers, 2-2
  - Error messages, 10-10
  - Events triggering, 7-83
  - Examples
    - State Histogram Mode, 8-14
-

State Overview Mode, 8-11  
 Time Interval Mode, 8-17  
 using all three trace modes, 8-18  
 External trigger, 4-12, 4-15

**F**

File description field, 6-4  
 File management, 6-2  
 File types, 6-8, 7-25  
 Find Error field, 7-69  
 First statement, 5-4  
 FLASH ROM Update, 7-29  
 Flexible disk drive, 6-3, 6-7, 7-22, 9-4  
 operations, 6-3  
 Flowcharts, 12-12 to 12-13  
 Format disk, 7-22  
 sector size, 7-24  
 Format Menu, 7-32 to 7-42  
 clock inputs display, 7-34  
 label polarity fields, 7-42  
 master and slave clock field, 7-37 to 7-39  
 pod clock field, 7-34 to 7-36  
 pod threshold field, 7-32  
 setup/hold field, 7-39  
 state acquisition mode field, 7-32  
 symbol field, 7-40  
 timing acquisition mode field, 7-33  
 Function entry triggering, 5-10  
 Function keys, 7-17  
 Fuse, 1-3, 12-5

**G**

General Purpose Probing, 7-8 to 7-10  
 Glitch detection  
 "x\*", 5-25 to 5-26  
 glitch acquisition mode, 7-33  
 oscilloscope, 5-26  
 timing analyzer, 5-25  
 Glitch waveforms, 5-26  
 Grabbers, 7-10  
 Graphics files  
 B/W TIF, 6-8  
 EPS, 6-8  
 GRAY TIF, 6-8  
 PCX, 6-8  
 Ground bounce, 5-25 to 5-26  
 Groups, 9-16  
 boundaries, 9-17

**H**

Handshake violation, 5-20  
 Hard disk, 7-22  
 default format, 9-4  
 Histograms, 8-4  
 HP-IB  
 interface, 7-26 to 7-28  
 interface defined, 7-27  
 settings, 7-27  
 HP-IB printer  
 Listen Always, 2-5  
 set up, 2-5 to 2-6

**I**

I/O activity, 5-29  
 If branch, 9-13  
 Illegal configuration, 7-31, 7-57  
 Images, 6-8  
 Immediate trigger mode, 7-80  
 Independent clocks, 5-31  
 Independent mode, Intermodule menu,  
 7-55  
 Initialization code, 5-8  
 Input field  
 automatic measurements, 7-97  
 Input impedance  
 See Coupling field  
 Input voltage for probes, 7-11  
 Inspection, 12-4  
 Interface  
 Centronics, 7-28  
 HP-IB, 7-27  
 RS-232-C, 7-27  
 Interleaved trace lists, 5-30  
 mixed display, 7-63  
 setting up, 5-31  
 Interleaving, 4-10  
 Interrupt processing, 5-27  
 Invasm key, 3-21  
 Inverse assembler, 3-20, 7-6, 7-25, 9-2  
 Inverse Assembler problems, 10-8  
 incorrect inverse assembly, 10-8  
 inverse assembler will not load or run,  
 10-9  
 no inverse assembly, 10-8

**K**

Keyboard, 7-16  
 cursor keys, 7-16  
 Enter key, 7-17  
 function keys, 7-17  
 functions, 7-16  
 home key, 7-16  
 next and previous keys, 7-16  
 overlays, 7-17  
 Select key, 7-17  
 types of, 2-4  
 using, 2-4  
 Keyboard overlays  
 function keys, 7-17  
 using, 7-17  
 Knob, 1-2  
 duplicating from keyboard, 7-16  
 duplicating with mouse, 2-3

**L**

Label polarity fields, 7-42  
 Labels, 3-10, 7-96, 8-9  
 changing, 8-9  
 selecting, 8-9  
 State Histogram Mode, 8-9  
 State Overview Mode, 8-9  
 Time Interval Mode, 8-9  
 LAN  
 See *LAN User's Guide*  
 Level field, 7-81  
 LIF format, 7-24, 9-4  
 Line at center of screen, 7-72  
 Line Voltage Selector, 12-5  
 Listen Always, 2-5  
 Listing menu, 3-16, 7-58 to 7-59  
 markers field, 7-58 to 7-59  
 statistics markers, 7-59  
 stop measurement field, 7-58  
 Load, 7-22, 10-4  
 Loading on signal line, 7-10  
 Logic analyzer, 7-2  
 Loop iteration triggering, 5-6

**M**

Macros  
 state, 7-46 to 7-47  
 timing, 7-44 to 7-45  
 using, 4-9

- 
- Manual acquisition mode, 5-25
  - Manual/automatic markers
    - setting, 7-94
  - Markers, 1-7
    - automatic markers, 7-88 to 7-96
    - channel label field, 7-96
    - default selection, 7-88
    - listing menu, 7-58
    - manual options, 7-88 to 7-89
    - See also markers, automatic
    - O, 8-10
    - options, 7-88 to 7-96
    - oscilloscope, 3-9
    - statistics markers, 7-59
    - Trig to O field, 7-88
    - Trig to X field, 7-88 to 7-89
    - Tx to To field, 7-88
    - voltage, 7-94 to 7-95
    - voltage, Va On field, 7-94
    - voltage, Va to Vb field, 7-95
    - voltage, Va Volts field, 7-95
  - Markers field, 7-58 to 7-59, 7-66
  - Markers, automatic
    - at Level field, 7-91
    - Occur field, 7-91
    - Run Until Time X-O field, 7-92
    - set on field, 7-90
    - Slope field, 7-91
    - Statistics field, 7-92
    - Statistics field, default, 7-92
    - type absolute, 7-91
    - type field, 7-91
  - Mask field, 7-70
  - Masked interrupts, 5-27
  - Master clock, 7-37 to 7-39
    - defined, 7-35
    - selecting, 7-37
  - Maximum probe input voltage, 7-11
  - Maximum states, 9-12
  - Maximum time interval measurements, 7-92
  - Mean time interval measurements, 7-92
  - Measurement algorithms, 7-100
  - Measurement configurations
    - loading, 6-6
    - saving, 6-4
  - Memory, 7-2
    - maximizing, 4-16, 7-3 to 7-4, 7-32, 7-41, 7-57, 9-11
  - Menus
    - accessing, 3-4 to 3-5
    - accessing SPA, 8-6
    - how named, 3-3
    - saving as images, 6-8
  - Message
    - Auto triggered, 7-84
    - Number of averages has been met, 7-76
    - Stop condition satisfied, 7-92 to 7-93
    - Waiting for Trigger, 7-84
  - Min and Max Scaling Fields, 7-66
  - Min, Max, and Avg Time Statistics, 8-16
  - Minimum states, 9-12
  - Minimum time interval measurements, 7-92
  - Mixed Display
    - mode, 4-10
    - setting up, 5-32 to 5-33
  - Mixed Display menu, 5-30, 7-63 to 7-64
    - interleaving state listings, 7-63
    - markers, 7-64
    - time-correlated displays, 7-64
  - Modify trigger field, 7-43
  - Mouse, 2-3
    - pointer, 2-3
  - N**
    - No state, 5-4, 9-14
    - Normal display mode
      - See Display mode, 7-76
    - Not, 9-14
    - Number of samples per range, 8-13
  - O**
    - Occur field, 7-91
    - Occur field range, 7-91
    - Occur value, tips for using, 7-91
    - Occurrence counters, using, 7-49
    - Occurs Field, 7-49
    - Offset field, 7-74
    - offset range and resolution, 7-74
    - Oscilloscope
      - calibration procedure, 12-7 to 12-10
      - probes, 7-11
      - See also Scope
    - Oscilloscope calibration ports, 1-3, 7-11
    - Other States included/excluded, 8-5, 8-13
    - Output Format field, 6-7
    - Overdrive, 7-10
    - Overshoot, 7-101
  - P**
    - Pack disk, 7-23 to 7-24
    - Page keys, 7-21
    - Paging data, 7-21
    - Pair boundaries, 9-17
    - Pairs, 9-16
    - Parallel printers, 2-8
      - See also Printers, Centronics
    - Parameters changed by autoscale, 7-73
    - Parity
      - defined, 7-28
    - Pattern, 7-51
      - bit patterns, 7-49
      - combination, 9-16
      - defining, 4-5
      - don't care, 4-5
      - durations, 7-49
      - expressions, 9-16
      - terms, 9-15
    - Pattern markers, 7-58
    - Pattern trigger, 3-9
      - Count field, 7-87
      - Count field default, 7-87
      - Count field range, 7-87
      - H, L, and X conditions, 7-80
      - When Entered field, 7-85
      - When Exited field, 7-85
      - When field default, 7-85
      - When Present field, 7-86
      - When Present field, 7-85
      - When Range field, 7-86
      - When Range values, 7-87
    - PCX, 6-8
      - print to disk, 7-19
    - Peak-to-peak voltage, 7-90
    - Percent Type field, 7-91
    - Pipelining
      - add depth to start address, 5-4, 10-3
    - Pod Clock Field, 7-34 to 7-36
    - Pod field, 7-32
    - Pod grounding, 7-9
-

- 
- Pod threshold, 7-10, 7-32
    - ECL, 7-32
    - TTL, 7-32
    - User, 7-32
  - Port in, 4-15
  - Port out, 4-12
  - Post-processing features
    - chart menu, 7-65
    - compare menu, 7-67
  - Power requirements, 1-3, 12-3
  - Power-up tests, 12-14
  - Preparation for use, 12-3 to 12-6
  - Preprocessor problems, 10-5
    - erratic trace measurements, 10-7
    - slow clock, 10-6
    - target system will not boot up, 10-5
  - Preset ECL values, 7-75
  - Preset field, 7-75
  - Preset TTL values, 7-75
  - Preshoot, 7-101
  - Print
    - all, 7-20
    - disk, 7-19
    - field, 7-19
    - partial, 7-20
  - Print to disk
    - ASCII, 7-19
    - B/W TIFF, 7-19
    - EPS, 7-19
    - PCX, 7-19
  - Printer, 7-26
    - Centronics, 2-8
    - HP-IB setup, 2-5 to 2-6
    - interface, 7-26
    - parallel, 2-8, 7-28
    - RS-232, 2-7
    - supported, 2-2
  - Probe attenuation factor, 7-75
  - Probe attenuation factor range, 7-75
  - Probe Cables, 7-10
  - Probe Connecting
    - disconnecting probes from pods, 7-14
    - grabbers to probes, 7-15
    - pods to probe cables, 7-13
    - probe cables to analyzer, 7-12 to 7-13
  - Probe field, 7-75
  - Probe leads, 7-9
  - Probe tip assemblies, 7-8
  - Probing, 7-5 to 7-15
    - assembly, 7-12 to 7-15
    - general purpose, 7-6
    - General Purpose Probing, 7-6
    - grabbers, 7-10
    - maximum probe input voltage, 7-11
    - microprocessor and bus, 7-6
    - minimal signal amplitude, 7-10
    - options, 7-5
    - oscilloscope, 7-11
    - pod thresholds, 7-10
    - probe and pod grounding, 7-9
    - probe cable, 7-10
    - probe leads, 7-9
    - probe tip assemblies, 7-8
    - termination adapter, 7-7
  - Problems, 10-2
  - Programming
    - See *HP 1660C/CS Logic Analyzers Programmers Guide*
  - Protocol
    - defined, 7-28
  - Pulse limits
    - test minimum and maximum, 5-18
  - Purge, 7-23
  - R**
    - Range specifiers, 8-12
    - Range terms, 9-15
    - Real Time Clock Adjustment, 7-29
    - Recursive call triggering, 5-8
    - Reference Listing field, 7-68
    - Registers
      - verifying correct storage, 5-13
    - Rename, 7-23
    - Repetitive measurements
      - automating, 6-4
    - Resource terms, 7-51 to 7-53
      - assigning, 7-52, 7-53
      - bit patterns, 7-51
      - edge terms, 7-51
      - range terms, 7-51
      - timers, 7-51 to 7-52
      - using bit by bit, 7-53
    - Resources, 9-16
    - Rolling data, 7-21
    - RS-232-C
      - cable, 7-28
      - interface, 7-26 to 7-28
      - printers, 2-7
    - Run field, 7-20
    - Run key, 7-72
    - Run repetitive, 7-20
    - Run until time X-O
      - field, 7-92
      - Greater Than field, 7-93
      - In Range field, 7-93
      - Less Than field, 7-92
      - Less Than field resolution, 7-93
      - Not In Range field, 7-93
    - Run/Stop options, 7-71
    - Running the oscilloscope
      - using Autoscale, 7-71
  - S**
    - s/Div field, 7-73
    - Sample period
      - Time interval mode, minimum, 8-5
      - timing analyzers, 4-19
    - Sampling methods
      - blind time, 8-9
    - Saving
      - menus or measurements as images, 6-8
      - to a flexible disk or internal drive, 6-4
    - Scope
      - Auto Measure menu, 3-9, 7-97
      - Autoscale menu, 7-72
      - Calibration menu, 3-9, 12-8
      - Channel menu, 3-8, 7-74
      - Display menu, 3-8, 7-76
      - Marker menu, 7-88
      - Markers menu, 3-9
      - Trigger menu, 3-9, 7-79
    - Screen images, 6-2, 6-8, 7-19
    - Secondary branch, 9-14
    - Select key, 7-17
    - Selecting
      - fields, 1-2, 3-4
      - SPA modes, 8-6
      - State Histogram Mode, 8-6
      - State Overview Mode, 8-6
      - Time Interval Mode, 8-6
      - waveforms display, 7-61
    - Selecting fields
      - display, 8-21
      - with mouse, 2-3
-

- 
- Sequence levels
    - branching, 7-48, 7-50
    - types, 7-43
    - usage, 7-43
  - Set on, MANUAL field, 7-94
  - Setting Line Voltage, 12-5
  - Setting up
    - logic analyzer (SPA), 8-21
    - State Format specification, 8-7
  - Settings
    - Centronics, 7-28
    - controller, 2-9
    - HP-IB, 7-27
    - printer, 2-6 to 2-8
    - RS-232-C, 7-27
  - Setup/Hold field, 7-39
  - Show field, 7-89, 7-96
  - Signal Line Loading, 7-10
  - Slave clock, 7-37 to 7-39
    - defined, 7-35
    - multiple, 7-35
    - selecting, 7-37
  - Slope field, 7-83
  - Source field, 7-82
  - Specifications
    - analyzer, 11-3
    - oscilloscope, 11-4
  - Specify States field, 8-13
  - Specifying low and high values, 8-22
  - Stacks
    - verifying correct storage, 5-13
  - Start state, 3-20
  - Start/End conditions, 8-15
  - State Acquisition Mode, 7-32
  - State analyzers, 7-3
    - using two to monitor coprocessors, 5-29
    - vs SPA, 8-4
    - vs timing analyzer, 5-28
  - State Data in Timing Waveform Display, 7-61
  - State flow, 5-27
  - State Format Specification
    - setting up, 8-7
  - State Histogram Mode, 8-5, 8-11
    - All States vs Qualified States, 8-13
    - choosing a label to monitor, 8-24
    - data sampling and sorting, 8-12
    - defining the ranges, 8-24
    - example, 8-14
    - interpreting the Histogram Display, 8-26
    - maximum number of ranges, 8-5
    - number of samples per range, 8-13
    - operating characteristics, 8-5
    - Other States included/excluded, 8-13, 8-26
    - range specifiers, 8-12
    - selecting, 8-6
    - State Histogram vs State Overview, 8-12
    - total samples, 8-13
    - tracing All States vs Qualified States, 8-25
    - User-defined Ranges vs Symbols, 8-13
    - using, 8-24
    - using symbols for ranges, 8-25
  - State listings
    - comparing, 3-18
    - inserting, 5-32
  - State mode
    - and memory, 7-32
  - State Overview Mode, 8-4, 8-9
    - choosing a label to monitor, 8-21
    - data sampling and sorting, 8-10
    - example, 8-11
    - interpreting the Histogram Display, 8-23
    - operating characteristics, 8-4
    - selecting, 8-6
    - specifying low and high values, 8-22
    - total count, 8-10
    - using, 8-21
    - using the markers, 8-23
  - X axis scaling, 8-9
  - Y axis scaling, 8-10
  - zooming in on an area of interest, 8-23
  - State tags, 4-11, 7-3, 7-57
  - Statistics field, 7-92
  - Statistics Markers
    - listing menu, 7-59
    - valid, 7-59
  - Status, 3-20
  - Status signals, 5-24
  - Stop bits
    - defined, 7-28
  - Stop Measurement field, 7-58
    - compare, 7-59
    - x - o, 7-59
  - Stop/Run options, 7-71
  - Storage qualification, 4-17, 7-49
  - Store, 7-23
    - configuration files, 6-2
    - See also Saving
  - Storing Branches, 7-57
  - Subroutines
    - storing and timing, 5-4
    - triggering on execution, 5-4
    - verifying storage before exiting, 5-13
  - sweep speed, 7-73
    - range, 7-73
  - Symbol field, 7-40
  - Symbol tables, 7-40
  - Symbols, 3-12, 7-40
    - label and base fields, 7-40
    - name field, 7-41
    - pattern and range fields, 7-41
    - width field, 7-41
  - Synchronization, 3-21
  - System menu, 3-4
  - System Performance Analysis, 8-2
    - definition, 8-4
    - operating characteristics, 8-4
    - using with other features, 8-30
  - System Utilities Menu, 7-29 to 7-30
- T**
- Tagging Data, 7-57
  - Template, 7-68
  - Termination Adapter, 7-7
  - Testing, 12-6
  - TIFF
    - files, 6-8
    - print to disk, 7-19
  - Time
    - changing, 7-29
    - counted implicitly, 5-32
  - Time base functions, 7-73
  - Time difference
    - Tx to To time field, 7-89
  - Time Interval Mode, 8-5, 8-15
    - auto-range, 8-16
    - data sampling and sorting, 8-15
    - defining the time interval ranges, 8-28
    - example, 8-17
    - interpreting the Histogram Display, 8-28
    - min, max, and avg time statistics, 8-16
    - operating characteristics, 8-5
    - resolution, 8-5
-

- 
- selecting, 8-6
  - specifying an event, 8-27
  - start/end conditions, 8-15
  - total samples, 8-16
  - using, 8-27
  - using Auto-range, 8-28
  - Time Interval Ranges, 8-15
    - maximum time, 8-16
    - minimum time, 8-16
    - range of, 8-5
  - Time marker value display, 7-89
  - Time markers, 5-32
  - Time stamps, 5-31
  - Time statistics, 8-16
  - Time tags, 4-10, 5-31, 7-3, 7-33, 7-57
  - Time Zone field, 7-29
  - Time-Correlated Displays, 4-10, 7-64
  - Timer Control Field, 5-12, 5-17 to 5-18
  - Timers, 9-15
  - Timing Acquisition Mode, 7-33
  - Timing analyzer, 4-10, 7-4
    - and delay, 7-60
    - sample period, 4-19
    - vs oscilloscope, 5-26
    - vs SPA, 8-4
    - vs state analyzer, 5-28
  - Top and base voltages, 7-99
  - Total count
    - State Overview, 8-5, 8-10
  - Total samples
    - State Histogram Mode, 8-13
    - Time Interval Mode, 8-16
  - Trace lists
    - comparing, 3-18
    - indented line numbers, 5-31
    - interleaving, 5-29 to 5-30
    - saving in ASCII format, 6-7
    - viewing with waveforms, 5-32
  - Trace modes, 8-8
    - selecting, 8-8
    - State Histogram, 8-8
    - State Overview, 8-8
    - Time Interval, 8-8
  - Trace Type
    - All States vs Qualified States, 8-13
  - Transitional Timing, 7-33
    - full channel 125MHz mode, 7-33
    - half channel 250MHz mode, 7-33
    - other considerations, 7-41, 9-11
  - Trig to X default value, 7-88
  - Trig to X field, 7-88 to 7-89
  - Trig to X time value resolution, 7-88
  - Trigger
    - add sequence level, 4-8
    - capabilities, 1-6
    - changing terms, 4-6
    - cross-arming, 5-22 to 5-29
    - default triggers, 4-3
    - Edge trigger, 7-79 to 7-80
    - events counter, 7-84
    - Immediate, 3-9, 7-80
    - marker, 7-79
    - memory use, 4-16
    - modes, 3-9
    - point, 7-79
    - positioning in memory, 4-18, 5-25
    - sequence levels, 7-43
    - setting the trigger point, 7-81
    - shown in display, 3-14
    - source, 7-82
    - store qualification, 4-17
    - terms, 4-4
    - trigger level voltage value, 7-81
    - trigger point range, 7-81
    - Trigger Position field, 7-56
    - Trigger sequence, 9-2, 9-12
    - Trigger term, 9-14
  - Trigger Menu
    - count field, 7-57
  - Trigger Mode field, 7-79 to 7-87
  - Trigger point, 7-89
    - location, 7-72
  - Trigger qualifier, 7-83
  - Triggering
    - after lines finish transitioning, 5-14
    - between analyzers, 7-54
    - delay-by-events, 7-83
    - events, 7-83
    - menus, 5-2
    - on a handshake violation, 5-20
    - on a loop that runs too long, 5-12
    - on a timing violation, 5-23
    - on asserting chip select lines, 5-15
    - on bad data, 5-11
    - on bus contention, 5-21
    - on control and status signals, 5-24
    - on entry to a function, 5-10
    - on intermittent problems, 5-17
    - on interrupt request, 5-27
    - on loop iteration, 5-6
    - on pulse limits, 5-18
    - on recursive function call, 5-8
    - on subroutine execution, 5-4
    - when expected data does not appear, 5-17
  - Troubleshooting, 12-11 to 12-22
  - TTL
    - levels, 7-10, 7-32
    - preset values, 7-75
  - Tx to To field, 7-88
  - Type: field, 7-31
- U**
- Unsynchronized waveform, 7-81, 7-84
  - Updating operating system, 7-29
  - User interface
    - keyboard, 7-16
  - User-defined threshold, 7-10
  - User-level macro, modify, 7-48 to 7-50
  - Using SPA
    - in group runs, 8-30
- V**
- Valid runs, 7-59
  - Vbase, 7-99
  - Verifying
    - chip select line is strobed, 5-16
    - correct execution, 5-4
    - correct storage, 5-13
    - efficiency, 5-4
  - Vertical position
    - See Offset field
  - Vertical voltage resolution, 7-99
  - Viewing
    - trace lists and waveforms together, 5-32
  - Vmaximum, 7-99
  - Vminimum, 7-99
  - Voltage markers, 7-94 to 7-95
    - value display, 7-96
-

---

Voltage values at Tx and To markers

See channel label field

Vp\_p, 7-99

Vtop, 7-99

## W

Watchdog timer behavior, 5-29

Waveform

unsynchronized, 7-81, 7-84

Waveform Display, 7-62

Waveform menu, 3-14, 7-60 to 7-62

accumulate field, 7-60

delay field, 7-60

waveform display, 7-62

Waveform reconstruction, 7-60

Waveforms

viewing with trace lists, 5-32

When field, 7-85 to 7-86

## X

X and O markers, 8-10

O Mark count, 8-10

Trig to X field, 7-88

X Mark count, 8-10

X axis, 8-4, 8-9

high value, 8-9

low value, 8-9

Xon/Xoff, 7-28

## Y

Y axis, 8-5, 8-10

maximum value, 8-5



© Copyright Hewlett-Packard Company 1995

All Rights Reserved.

MS-DOS<sup>®</sup> is a US registered trademark of Microsoft Corporation.

Pentium<sup>®</sup> is a U.S. registered trademark of Intel Corporation

Postscript<sup>™</sup> is a trademark of Adobe Systems Incorporated which may be registered in certain jurisdictions.

Reproduction, adaptation, or translation without prior written permission is prohibited, except as allowed under the copyright laws.

#### Document Warranty

The information contained in this document is subject to change without notice.

**Hewlett-Packard makes no warranty of any kind with regard to this material, including, but not limited to, the implied warranties or merchantability and fitness for a particular purpose.**

Hewlett-Packard shall not be liable for errors contained herein or for incidental or consequential damages in connection with the furnishing, performance, or use of this material.

Complete product warranty information is given on the last page of this guide.

#### Safety

This apparatus has been designed and tested in accordance with IEC Publication 348, Safety Requirements for Measuring Apparatus, and has been supplied in a safe condition. This is a Safety Class I instrument (provided with terminal for protective earthing). Before applying power, verify that the correct safety precautions are taken (see the following warnings). In addition, note the external markings on the instrument that are described under "Safety Symbols."

#### Warning

- Before turning on the instrument, you must connect the protective earth terminal of the instrument to the protective conductor of the (mains) power cord. The mains plug shall only be inserted in a socket outlet provided with a protective earth contact. You must not negate the protective action by using an extension cord (power cable) without a protective conductor (grounding). Grounding one conductor of a two-conductor outlet is not sufficient protection.
- Only fuses with the required rated current, voltage, and specified type (normal blow, time delay, etc.) should be used. Do not use repaired fuses or short-circuited fuseholders. To do so could cause a shock or fire hazard.

- Service instructions are for trained service personnel. To avoid dangerous electric shock, do not perform any service unless qualified to do so. Do not attempt internal service or adjustment unless another person, capable of rendering first aid and resuscitation, is present.

- If you energize this instrument by an auto transformer (for voltage reduction), make sure the common terminal is connected to the earth terminal of the power source.

- Whenever it is likely that the ground protection is impaired, you must make the instrument inoperative and secure it against any unintended operation.

- Do not operate the instrument in the presence of flammable gasses or fumes. Operation of any electrical instrument in such an environment constitutes a definite safety hazard.

- Do not install substitute parts or perform any unauthorized modification to the instrument.

- Capacitors inside the instrument may retain a charge even if the instrument is disconnected from its source of supply.

- Use caution when exposing or handling the CRT. Handling or replacing the CRT shall be done only by qualified maintenance personnel.

#### Safety Symbols



Instruction manual symbol: the product is marked with this symbol when it is necessary for you to refer to the instruction manual in order to protect against damage to the product.



Hazardous voltage symbol.



Earth terminal symbol: Used to indicate a circuit common connected to grounded chassis.

#### WARNING

The Warning sign denotes a hazard. It calls attention to a procedure, practice, or the like, which, if not correctly performed or adhered to, could result in personal injury. Do not proceed beyond a Warning sign until the indicated conditions are fully understood and met.

#### CAUTION

The Caution sign denotes a hazard. It calls attention to an operating procedure, practice, or the like, which, if not correctly performed or adhered to, could result in damage to or destruction of part or all of the product. Do not proceed beyond a Caution symbol until the indicated conditions are fully understood or met.

---

**Product Warranty**

This Hewlett-Packard product has a warranty against defects in material and workmanship for a period of one year from date of shipment. During the warranty period, Hewlett-Packard Company will, at its option, either repair or replace products that prove to be defective.

For warranty service or repair, this product must be returned to a service facility designated by Hewlett-Packard.

For products returned to Hewlett-Packard for warranty service, the Buyer shall prepay shipping charges to Hewlett-Packard and Hewlett-Packard shall pay shipping charges to return the product to the Buyer. However, the Buyer shall pay all shipping charges, duties, and taxes for products returned to Hewlett-Packard from another country.

Hewlett-Packard warrants that its software and firmware designated by Hewlett-Packard for use with an instrument will execute its programming instructions when properly installed on that instrument.

Hewlett-Packard does not warrant that the operation of the instrument software, or firmware will be uninterrupted or error free.

**Limitation of Warranty**

The foregoing warranty shall not apply to defects resulting from improper or inadequate maintenance by the Buyer, Buyer-supplied software or interfacing, unauthorized modification or misuse, operation outside of the environmental specifications for the product, or improper site preparation or maintenance.

No other warranty is expressed or implied. Hewlett-Packard specifically disclaims the implied warranties or merchantability and fitness for a particular purpose.

**Exclusive Remedies**

The remedies provided herein are the buyer's sole and exclusive remedies.

Hewlett-Packard shall not be liable for any direct, indirect, special, incidental, or consequential damages, whether based on contract, tort, or any other legal theory.

**Assistance**

Product maintenance agreements and other customer assistance agreements are available for Hewlett-Packard products.

For any assistance, contact your nearest Hewlett-Packard Sales Office.

**Certification**

Hewlett-Packard Company certifies that this product met its published specifications at the time of shipment from the factory. Hewlett-Packard further certifies that its calibration measurements are traceable to the United States National Institute of Standards and Technology, to the extent allowed by the Institute's calibration facility, and to the calibration facilities of other International Standards Organization members.

**About this edition**

This is the first edition of the *HP 1660CS-Series Logic Analyzers User's Guide*

Publication number  
01660-97017

Printed in USA.

Edition dates are as follows:  
First edition, November 1995

New editions are complete revisions of the manual. Update packages, which are issued between editions, contain additional and replacement pages to be merged into the manual by you. The dates on the title page change only when a new edition is published.

A software or firmware code may be printed before the date. This code indicates the version level of the software or firmware of this product at the time the manual or update was issued. Many product updates do not require manual changes; and, conversely, manual corrections may be done without accompanying product changes. Therefore, do not expect a one-to-one correspondence between product updates and manual updates.

The following list of pages gives the date of the current edition and of any changed pages to that edition.

All pages original edition