

Agilent Technologies
3458A Multimeter
Calibration Manual

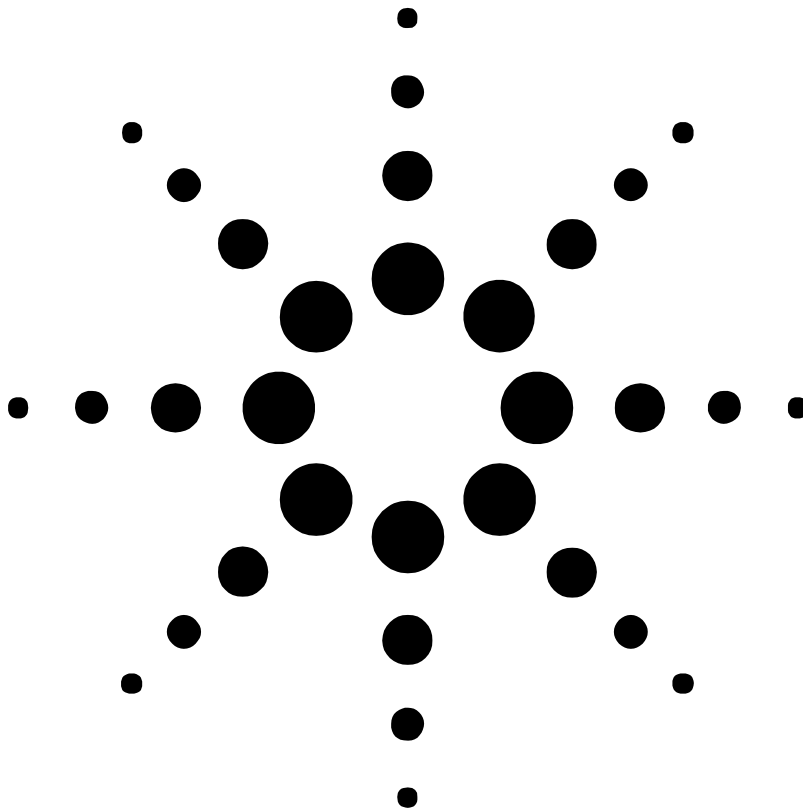

Agilent Technologies

Manual Part Number: 03458-90017
Printed in U.S.A

AGILENT TECHNOLOGIES WARRANTY STATEMENT

AGILENT PRODUCT: 3458A Multimeter

DURATION OF WARRANTY: 1 year

1. Agilent Technologies warrants Agilent hardware, accessories and supplies against defects in materials and workmanship for the period specified above. If Agilent receives notice of such defects during the warranty period, Agilent will, at its option, either repair or replace products which prove to be defective. Replacement products may be either new or like-new.
2. Agilent warrants that Agilent software will not fail to execute its programming instructions, for the period specified above, due to defects in material and workmanship when properly installed and used. If Agilent receives notice of such defects during the warranty period, Agilent will replace software media which does not execute its programming instructions due to such defects.
3. Agilent does not warrant that the operation of Agilent products will be interrupted or error free. If Agilent is unable, within a reasonable time, to repair or replace any product to a condition as warranted, customer will be entitled to a refund of the purchase price upon prompt return of the product.
4. Agilent products may contain remanufactured parts equivalent to new in performance or may have been subject to incidental use.
5. The warranty period begins on the date of delivery or on the date of installation if installed by Agilent. If customer schedules or delays Agilent installation more than 30 days after delivery, warranty begins on the 31st day from delivery.
6. Warranty does not apply to defects resulting from (a) improper or inadequate maintenance or calibration, (b) software, interfacing, parts or supplies not supplied by Agilent, (c) unauthorized modification or misuse, (d) operation outside of the published environmental specifications for the product, or (e) improper site preparation or maintenance.
7. TO THE EXTENT ALLOWED BY LOCAL LAW, THE ABOVE WARRANTIES ARE EXCLUSIVE AND NO OTHER WARRANTY OR CONDITION, WHETHER WRITTEN OR ORAL, IS EXPRESSED OR IMPLIED AND AGILENT SPECIFICALLY DISCLAIMS ANY IMPLIED WARRANTY OR CONDITIONS OF MERCHANTABILITY, SATISFACTORY QUALITY, AND FITNESS FOR A PARTICULAR PURPOSE.
8. Agilent will be liable for damage to tangible property per incident up to the greater of \$300,000 or the actual amount paid for the product that is the subject of the claim, and for damages for bodily injury or death, to the extent that all such damages are determined by a court of competent jurisdiction to have been directly caused by a defective Agilent product.
9. TO THE EXTENT ALLOWED BY LOCAL LAW, THE REMEDIES IN THIS WARRANTY STATEMENT ARE CUSTOMER'S SOLE AND EXCLUSIVE REMEDIES. EXCEPT AS INDICATED ABOVE, IN NO EVENT WILL AGILENT OR ITS SUPPLIERS BE LIABLE FOR LOSS OF DATA OR FOR DIRECT, SPECIAL, INCIDENTAL, CONSEQUENTIAL (INCLUDING LOST PROFIT OR DATA), OR OTHER DAMAGE, WHETHER BASED IN CONTRACT, TORT, OR OTHERWISE.

FOR CONSUMER TRANSACTIONS IN AUSTRALIA AND NEW ZEALAND: THE WARRANTY TERMS CONTAINED IN THIS STATEMENT, EXCEPT TO THE EXTENT LAWFULLY PERMITTED, DO NOT EXCLUDE, RESTRICT OR MODIFY AND ARE IN ADDITION TO THE MANDATORY STATUTORY RIGHTS APPLICABLE TO THE SALE OF THIS PRODUCT TO YOU.

U.S. Government Restricted Rights

The Software and Documentation have been developed entirely at private expense. They are delivered and licensed as "commercial computer software" as defined in DFARS 252.227- 7013 (Oct 1988), DFARS 252.211-7015 (May 1991) or DFARS 252.227-7014 (Jun 1995), as a "commercial item" as defined in FAR 2.101(a), or as "Restricted computer software" as defined in FAR 52.227-19 (Jun 1987)(or any equivalent agency regulation or contract clause), whichever is applicable. You have only those rights provided for such Software and Documentation by the applicable FAR or DFARS clause or the Agilent standard software agreement for the product involved.



3458A Multimeter Calibration Manual
Edition 3







Copyright © 1988, 1992, 2000 Agilent Technologies, Inc. All rights reserved.

Documentation History

All Editions and Updates of this manual and their creation date are listed below. The first Edition of the manual is Edition 1. The Edition number increments by 1 whenever the manual is revised. Updates, which are issued between Editions, contain replacement pages to correct or add additional information to the current Edition of the manual. Whenever a new Edition is created, it will contain all of the Update information for the previous Edition. Each new Edition or Update also includes a revised copy of this documentation history page.

Edition 1	May, 1988
Update 1	February, 1992
Edition 2	October, 1992
Edition 3	February, 1994
Edition 4	December, 2000

Safety Symbols

	Instruction manual symbol affixed to product. Indicates that the user must refer to the manual for specific WARNING or CAUTION information to avoid personal injury or damage to the product.		Alternating current (AC)
	Indicates the field wiring terminal that must be connected to earth ground before operating the equipment — protects against electrical shock in case of fault.		Direct current (DC).
	or 		WARNING, RISK OF ELECTRIC SHOCK.
	Frame or chassis ground terminal—typically connects to the equipment's metal frame.	WARNING	Calls attention to a procedure, practice, or condition that could cause bodily injury or death.
		CAUTION	Calls attention to a procedure, practice, or condition that could possibly cause damage to equipment or permanent loss of data.

WARNINGS

The following general safety precautions must be observed during all phases of operation, service, and repair of this product. Failure to comply with these precautions or with specific warnings elsewhere in this manual violates safety standards of design, manufacture, and intended use of the product. Agilent Technologies assumes no liability for the customer's failure to comply with these requirements.

Ground the equipment: For Safety Class 1 equipment (equipment having a protective earth terminal), an uninterruptible safety earth ground must be provided from the mains power source to the product input wiring terminals or supplied power cable.

DO NOT operate the product in an explosive atmosphere or in the presence of flammable gases or fumes.

For continued protection against fire, replace the line fuse(s) only with fuse(s) of the same voltage and current rating and type. **DO NOT** use repaired fuses or short-circuited fuse holders.

Keep away from live circuits: Operating personnel must not remove equipment covers or shields. Procedures involving the removal of covers or shields are for use by service-trained personnel only. Under certain conditions, dangerous voltages may exist even with the equipment switched off. To avoid dangerous electrical shock, **DO NOT** perform procedures involving cover or shield removal unless you are qualified to do so.

DO NOT operate damaged equipment: Whenever it is possible that the safety protection features built into this product have been impaired, either through physical damage, excessive moisture, or any other reason, **REMOVE POWER** and do not use the product until safe operation can be verified by service-trained personnel. If necessary, return the product to Agilent for service and repair to ensure that safety features are maintained.

DO NOT service or adjust alone: Do not attempt internal service or adjustment unless another person, capable of rendering first aid and resuscitation, is present.

DO NOT substitute parts or modify equipment: Because of the danger of introducing additional hazards, do not install substitute parts or perform any unauthorized modification to the product. Return the product to Agilent for service and repair to ensure that safety features are maintained.

Measuring high voltages is always hazardous: ALL multimeter input terminals (both front and rear) must be considered hazardous whenever inputs greater than 42V (dc or peak) are connected to ANY input terminal.

Permanent wiring of hazardous voltage or sources capable of delivering greater than 150 VA should be labeled, fused, or in some other way protected against accidental bridging or equipment failure.

DO NOT leave measurement terminals energized when not in use.

DO NOT use the front/rear switch to multiplex hazardous signals between the front and rear terminals of the multimeter.



Manufacturer's Name: Agilent Technologies, Incorporated
Manufacturer's Address: 815 14th ST. S.W.
Loveland, CO 80537
USA

Declares, that the product

Product Name: Multimeter
Model Number: 3458A
Product Options: *This declaration covers all options of the above product(s).*

Conforms with the following European Directives:

The product herewith complies with the requirements of the Low Voltage Directive 73/23/EEC and the EMC Directive 89/336/EEC (including 93/68/EEC) and carries the CE Marking accordingly

Conforms with the following product standards:

EMC	Standard	Limit
	IEC 61326-1:1997+A1:1998 / EN 61326-1:1997+A1:1998	
	CISPR 11:1990 / EN 55011:1991	
	IEC 61000-4-2:1995+A1:1998 / EN 61000-4-2:1995	Group 1 Class A
	IEC 61000-4-3:1995 / EN 61000-4-3:1995	4kV CD, 8kV AD
	IEC 61000-4-4:1995 / EN 61000-4-4:1995	3 V/m, 80-1000 MHz
	IEC 61000-4-5:1995 / EN 61000-4-5:1995	0.5kV signal lines, 1kV power lines
	IEC 61000-4-6:1996 / EN 61000-4-6:1996	0.5 kV line-line, 1 kV line-ground
	IEC 61000-4-11:1994 / EN 61000-4-11:1994	3V, 0.15-80 MHz I cycle, 100%
	Canada: ICES-001:1998	Dips: 30% 10ms; 60% 100ms
	Australia/New Zealand: AS/NZS 2064.1	Interrupt > 95%@5000ms
	<i>The product was tested in a typical configuration with Agilent Technologies test systems.</i>	

Safety
IEC 61010-1:1990+A1:1992+A2:1995 / EN 61010-1:1993+A2:1995
Canada: CSA C22.2 No. 1010.1:1992
UL 3111-1: 1994

8 March 2001

Date

Ray Corson

Product Regulation Program Manager

For further information, please contact your local Agilent Technologies sales office, agent or distributor.
Authorized EU-representative: Agilent Technologies Deutschland GmbH, Herrenberger Straße 130, D 71034 Böblingen, Germany

Contents

Chapter 1 3458A Calibration Introduction	
Introduction	7
Calibration Security	7
Security Code	7
Changing the Security Code	8
Hardware Lock-Out of Calibration	9
Number of Calibrations	9
Monitoring For CAL Violations	10
Monitoring Calibration Constants	10
Chapter 2 Operational Verification Tests	
Introduction	13
Operational Tests	13
Required Equipment	13
Preliminary Steps	13
2-Wire Ohms Function Offset Test	14
4-Wire Ohms Function Gain Test	15
DC Voltage Function Gain Test	15
DC Voltage Function Offset Test	17
Chapter 3 Adjustment Procedures	
Introduction	21
Required Equipment	21
Preliminary Adjustment Procedure	22
Front Terminal Offset Adjustment	23
Rear Terminal Offset Adjustment	24
DC Gain Adjustment	24
Resistance and DC Current Adjustment	26
AC Adjustment	27
Chapter 4 Performance Verification Tests	
Introduction	33
Required Equipment	33
Test Card	33
Calibration Cycle	33
Test Considerations	34
General Test Procedure	36
DC Voltage Performance Tests	38
Required Equipment	38
Preliminary Steps	38
DC Voltage Function Offset Test	39
DC Voltage Function Gain Test	39
Analog AC Voltage Performance Tests	41
Required Equipment	41
Preliminary Steps	41
AC Voltage Test Procedure	41
DC Current Performance Tests	43
Required Equipment	43
Preliminary Steps	43
DC Current Function Offset Test	44
DC Current Function Gain Test	44
Ohms Performance Tests	45
Required Equipment	45
Preliminary Steps	45
2-Wire Ohms Function Offset Test	46
4-Wire Ohms Function Offset Test (Rear Terminals)	47
4-Wire Ohms Function Gain Test	47
Frequency Counter Performance Tests	48
Required Equipment	48
Preliminary Steps	48
Frequency Counter Accuracy Test	49
Chapter 5 Command Summary	
ACAL	62
CAL	64
CAL?	65
CALNUM?	73
CALSTR	74
REV?	75
SCAL	76
SECURE	77
TEMP?	79
TEST	80
Appendix A Specifications	
Appendix B Electronic Calibration of the 3458A (Product Note 3458A-3)	

Chapter 1 3458A Calibration Introduction

Introduction

This manual provides operation verification procedures, adjustment procedures, and performance verification procedures for the 3458A Multimeter.

WARNING The information contained in this manual is intended for the use of service-trained personnel who understand electronic circuitry and are aware of the hazards involved. Do not attempt to perform any of the procedures outlined in this section unless you are qualified to do so.

The manual contains five chapters and two appendixes.

Chapter 1: Introduction describes the manual contents and calibration security features of the 3458A.

Chapter 2: Operational Verification provides a short test procedure to verify that the multimeter is functioning properly.

Chapter 3: Adjustment Procedure gives the procedures for adjusting the multimeter to obtain best accuracy.

Chapter 4: Performance Verification is comprised of test procedures used to verify that all parts of the instrument are functioning properly and within specification. This chapter contains Test Cards for recording the results of each test.

Chapter 5: Command Summary provides an alphabetical summary of commands that are used in adjusting and performance testing the 3458A.

Appendix A: 3458A Technical Specifications.

Appendix B: Electronic Calibration of the 3458A, Product Note 3458A-3.

Calibration Security

The calibration security feature of the 3458A allows the person responsible for calibration to enter a security code to prevent accidental or unauthorized calibration (CAL) or autocalibration (ACAL). The SECURE command is used to change the security code of the 3458A.

Security Code

The security code is an integer from $-2.1E-9$ to $2.1E9$. If the number specified is not an integer, the multimeter rounds it to an integer value. The multimeter

is shipped from the factory with its security code set to 3458. Specifying 0 for the new_code in the SECURE command disables the security feature making it no longer necessary to enter the security code to perform a calibration or autocal.

Changing the Security Code

The security code is changed with the SECURE command which has the following syntax:

```
SECURE old_code, new_code [,acal_secure]
```

The procedure for changing the security code is as follows:

1. Access the SECURE command. (Press the blue SHIFT key, then the S menu key. If using the full command menu use the ↓ scroll key to display the SECURE command).
2. Enter the old security code, the delimiter (,) and the new security code. If you want to control the auto calibration of the multimeter, enter another delimiter (,) and the acal_secure parameter ON. The instrument is shipped from the factory with the security code set to 3458 and the acal_secure parameter set to ON (security code required to do an acal).
3. Press the Enter key. The instrument will now respond to the new security code.

In the event the security code is unknown, the security feature can be disabled to permit a new code to be entered. Perform the following procedure to disable the current unknown security code and enter a known code:

- a. Turn the instrument off and remove the line cord and all external inputs to the 3458A.
- b. Remove the top cover.
 1. Remove both rear handle brackets with a #2 Pozidrive.
 2. Remove the rear bezel by loosening the four #15 TORX screws.
 3. With the back of the instrument facing you, remove the #10 TORX screw securing the top cover to the right side.
 4. Remove the top cover.
- c. Change the position of jumper JM600 on the 03458-66505 assembly, or option 001 03458-66515 assembly from the left position to the right position (front of instrument facing you).
- d. Reconnect the power and turn the instrument on.
- e. Access the SECURE command (Press the blue SHIFT key then the S MENU key. Use the ↓ scroll key if in the full command menu to

display the SECURE command).

- f. Enter the number 0 followed by the delimiter (,) and the security code you want to use.
- g. Press the ENTER key.
- h. Turn the instrument off, disconnect power, and return jumper JM600 to the left position (front of instrument facing you).
- i. Replace the top cover and reconnect power. The instrument will now respond to the new security code you just entered.

Note When jumper JM600 is in the right position, the security feature is disabled (i.e. old_code = 0). It is possible to calibrate the instrument without entering a security number under these conditions. If a new security number (new_code of SECURE command) is not entered while the jumper is in the right position the original number will again be in effect when jumper JM600 is returned to the left position

Hardware Lock-Out of Calibration

You can set jumper J132 on the 03458-66505 or -66515 (option 001) assembly to require removing the instrument cover and repositioning this jumper whenever adjustments (CAL command) are to be made. Use the following procedure to set hardware "lock-out" of the CAL and ACAL commands.

1. Remove the instrument top cover as described in steps a and b of the previous section.
2. With the instrument front facing you, set jumper J132 to the right position. Neither the CAL or ACAL command can be executed when the jumper is in this position even when the correct security code is entered.
3. Replace the top cover.

To perform an adjustment with the CAL command or do an auto-calibration with the ACAL command, you must remove the top cover and set jumper J132 to the left position (instrument front facing you). You may attach a seal to the top cover that must be broken to remove the cover indicating if unauthorized access to the hardware has occurred.

Number of Calibrations

You can monitor the number of times calibration has been performed (CAL and ACAL combined if ACAL is secured by the SECURE command) by using the CALNUM? command. CALNUM? (calibration number query) returns a decimal number indicating the number of times the multimeter has been unsecured and adjusted. The number of calibrations is stored in cal-protected memory and is not lost when power is removed. The calibration number is incremented by 1 whenever the multimeter is unsecured and a

CAL. (or ACAL if secured) is executed. If autocal is secured, the calibration number is also incremented by 1 whenever an autocal is performed; if unsecured, autocal does not affect the calibration number.

Note The multimeter was adjusted before it left the factory. This has incremented the calibration number. When you receive the multimeter, read the calibration number to determine the initial value you start with. The procedure for reading the number of calibrations is presented after this note.

Read the number of calibrations with the following procedure:

1. Access the CALNUM? command. In the full command menu, press the blue SHIFT key then the C menu key. Use the ↓ scroll key to display the CALNUM? command. (Full command menu is obtained by pressing the blue SHIFT key, the "menu" key, the ↑ scroll key, and ENTER key.)
2. Press the ENTER key.
3. The display indicates CALNUM and the current number of calibrations.

Monitoring For CAL Violations

You can use the CALSTR command in conjunction with the CALNUM? command to monitor for calibration (CAL) violations. After each authorized calibration has taken place, use the CALNUM? command to access the current number of calibrations as described in the previous section. Store this number in the calibration string (must be done remotely) with the CALSTR command i.e. OUTPUT 722;"CALSTR 'calnum = 270' ". At any later time, you can execute the CALNUM? and CALSTR? commands and compare the two calibration numbers. If the CALNUM is greater than the CALSTR entry, calibration security has been violated and unauthorized adjustments performed.

The following example illustrates monitoring for CAL violations:

1. After adjustments are performed, execute CALNUM?. Display shows "CALNUM 270"
2. Remotely execute OUTPUT 722;"CALSTR 'CALNUM=270' "
3. At a later time you can verify if CAL has been violated by executing CALNUM? and CALSTR shift ? to see if CALNUM is greater than that stored in CALSTR.

Monitoring Calibration Constants

Each time you do an ACAL, most calibration constants are recalculated. Executing an ACAL ALL recalculates 197 of the 253 calibration constants.

The remaining constants (such as internal reference and offset constants) are externally derived and not changed by an ACAL. Periodically you may want to monitor a particular constant and track its movement within the lower and upper limits (see CAL? command, cal_item parameter). This may give you an indication of the calibration cycle you want to establish for your 3458A. Information on the externally derived calibration constants and the 197 internally derived calibration constants is presented on the last page of Appendix B. Detailed information about each constant appears in the CAL? command located in Chapter 5 (Command Summary).

WARNING Only qualified, service trained personnel who are aware of the hazards involved should remove or install the multimeter or connect wiring to the multimeter. Disconnect the multimeter's power cord before removing any covers, changing the line voltage selector switches, or installing or changing the line power fuse.

Measuring high voltage is always hazardous. All multimeter input terminals (both front and rear) must be considered as hazardous whenever inputs in excess of 42V are connected to any terminal. Regard all terminals as being at the same potential as the highest voltage applied to any terminal.

Agilent Technologies recommends that the wiring installer attach a label to any wiring having hazardous voltages. This label should be as close to the input terminals as possible and should be an eye-catching color, such as red or yellow. Clearly indicate on the label that high voltages may be present.

Caution The current input terminals (I) are rated at $\pm 1.5A$ peak with a maximum non-destructive input of $<1.25A$ RMS. Current inputs are fuse protected. The multimeter's input voltage ratings are:

	Rated Input	Maximum Non-Destructive Input
HI to LO Input:	$\pm 1000V$ peak	$\pm 1200V$ peak
HI/LO Ω Sense to LO Input:	$\pm 200V$ peak	$\pm 350V$ peak
HI to LO Ω Sense:	$\pm 200V$ peak	$\pm 350V$ peak
LO Input to Guard:	$\pm 200V$ peak	$\pm 350V$ peak
Guard to Earth Ground:	$\pm 500V$ peak	$\pm 1000V$ peak
HI/LO Input, HI/LO Ω Sense, or I terminal to earth ground:	$\pm 1000V$ peak	$\pm 1500V$ peak
Front terminals to rear terminals:	$\pm 1000V$ peak	$\pm 1500V$ peak

The multimeter will be damaged if any of the above maximum non-destructive inputs are exceeded.

Chapter 2 Operational Verification Tests

Introduction

This section contains Operational Verification Tests which provide an abbreviated method of testing the operation and accuracy of the unit. The Operational Verification Tests are designed to provide a 90% confidence that the 3458A is operational and meets the specifications listed in Appendix A.

Operational Verification Tests perform a three point verification. These three points are the basis for all internal electronic adjustments (see the section titled "The Basis for Auto-Calibration" in Appendix B, Electronic Calibration of the 3458A). Prior to the three point test, a self test verifies that all calibration constants are within their upper and lower limits, an indicator of proper operation.

Operational Tests

Required Equipment

The following equipment or its equivalent is required for these operational tests.

- Stable DC voltage/resistance standard (Fluke 5700A or equivalent)
- Transfer standard DMM (3458A Opt. 002 within 90 days of CAL)
- Low thermal short (copper wire)
- Low thermal test leads (such as Agilent 11053A, 11174A, or 11058A)

Note

Equipment required for the adjustment procedures can be used for operational tests since the three-point test verifies the external adjustment points of the adjustment procedure.

To have your transfer standard 3458A OPT. 002 calibrated to 90 day specifications, contact your Agilent Technologies sales and service office.

Preliminary Steps

4. Verify that the DC voltage/resistance standard is properly warmed up.
5. The 3458A requires a 4 hour warm-up period. If this has not occurred turn the instrument ON and allow it to warm up before proceeding.
6. The internal temperature of the 3458A under test must be within 5°C of its temperature when last calibrated. Use the **TEMP?** command to obtain the current internal temperature and compare it to the calibration temperature obtained by executing the command **CAL? 59** for DCV and **CAL? 60** for OHMS. You can use the ← and

- scroll keys to view entire CAL? message. Record the temperatures on the Test Card.
7. If the instrument self test has not been run, make certain all inputs are disconnected and execute the TEST function. The display must read "SELF TEST PASSED".
 8. Execute the ACAL OHMS function. This auto calibration will take approximately ten minutes to complete.
 9. Configure the transfer standard DMM as follows:
 - OHM
 - NDIG 8
 - NPLC 100
 - TRIG SGL
 10. Configure the DMM under test as follows:
 - OHM
 - NDIG 8
 - NPLC 100
 - TRIG SGL

2-Wire Ohms Function Offset Test

This procedure operation verifies 2-wire ohms offset for both the front and rear terminals.

1. Connect a low thermal short across the 3458A front **HI** and **LO** terminals (see Figure 1 in Chapter 3).
2. Verify that the **Terminals** switch is in the **Front** position.
3. Set the 3458A under test to the 10 Ω range (function = OHM). Allow five minutes for the range relays to thermally stabilize.
4. Execute **Trig** from the front panel two times and use the Operational Test Card to record the offset reading. Reading must be less than the limit specified on the test card.
5. Remove the short from the front panel input terminals and connect it to the rear input **HI** and **LO** terminals.
6. Change the **Terminals** switch to the **Rear** position.
7. Allow 5 minutes for thermal stabilization.
8. Execute **Trig** from the front panel two times and record the rear terminal offset reading on the Operational Test Card. Reading must be less than the limit specified on the test card. If reading is greater than the limit, refer to Chapter 3 to make adjustments.

9. Remove the short from the rear input terminals.

4-Wire Ohms Function Gain Test

The following procedure verifies the gain of the ohms function. The 10 K Ω point is used for internal electronic calibration using ACAL. The procedure requires alternately connecting the transfer standard DMM and then the 3458A under test to the resistance verification standard as described in the Chapter 4 section titled "General Test Procedure".

1. Connect the resistance standard to the transfer standard DMM 4-wire ohms front input terminals.
2. Set the Terminals switch of both DMMs to the Front position.
3. Set the range of the transfer standard DMM to 10 K Ω (function = OHMF).
4. Set the range of the 3458A under test to 10 K Ω (function = OHMF).
5. Set the resistance standard to 10 K Ω .
6. Execute **Trig** from the front panel two times and read the value of the resistance standard as measured with the transfer standard DMM and record this reading in the "Transfer Standard Reading" column of the Ohms Gain Operational Test Card.
7. Remove the connection between the transfer standard DMM and the resistance standard.
8. Connect the resistance standard to the 4-wire ohms input terminals of the 3458A under test.
9. Execute **Trig** from the front panel two times and read the value as measured with the 3458A under test and record this value in the "Unit Under Test Reading" column of the 4-Wire Ohms Function Gain Operational Test Card.
10. Calculate, and record in the column provided, the difference (absolute value) between the transfer standard DMM reading and the unit under test reading for the test.
11. If the difference calculated is greater than the specified limits, refer to Chapter 3 "Adjustment Procedures", to make adjustments.
12. Disconnect the resistance standard from the 3458A input terminals.

DC Voltage Function Gain Test

The following procedure verifies the 10V input on the 10V range. This test verifies the gain of the DC voltage function and checks the point used for internal adjustments by ACAL. The procedure requires alternately connecting the transfer standard DMM and then the 3358A under test to the DC verification source as described in the general test description of

chapter 4, Performance Verification Tests.

1. Execute the ACAL DCV command using the front panel "Auto Cal" key and scroll keys. This auto calibration will take approximately two minutes to complete.
2. Configure the transfer standard DMM as follows:
 - DCV
 - NDIG 8
 - NPLC 100
 - Trig SGL
3. Configure the DMM under test as follows:
 - DCV
 - NDIG 8
 - NPLC 100
 - Trig SGL
4. Set the range of the transfer standard DMM to 10V (function = DCV).
5. Set the range of the 3458A under test to 10V (function = DCV).
6. Connect the DC voltage source to the transfer standard DMM.
7. Set the DC voltage source to 10V
8. Execute Trig SGL and read the output of the DC voltage source as measured with the transfer standard DMM and record this reading in the "Transfer Standard Reading" column of the DC voltage Operational Test Record.
9. Remove the connection from the transfer standard DMM to the DC voltage source.
10. Connect the 3458A under test to the DC voltage source.
11. Execute Trig SGL and read the value as measured with the 3458A under test and record this value in the "Unit Under Test" column of the DC voltage Operational Test Record.
12. Connect the DC voltage source to the transfer standard DMM.
13. Repeat steps 8 through 11 for a -10V DC voltage source output.
14. Calculate, and record in the column provided, the difference (absolute value) between the transfer standard DMM reading and the unit under test reading.
15. If the difference calculated is greater than the specified limits, refer to

DC Voltage Function Offset Test

This procedure tests the DCV offset voltage specification on the 10V range. This reading and the 10V and -10V readings from the previous DCV gain test are used to do a turnover check of the A-D converter and verify its linearity.

1. Connect a low thermal short across the front panel **HI** and **LO** input terminals of the DMM under test (see Figure 1).
2. Set the range of the 3458A under test to 10V
3. Let the instrument sit for five minutes before taking a reading to allow the short and relays to thermally stabilize.
4. Execute **Trig** and record the offset reading on the Test Card.

Turnover Check

The turnover check is a calculation using the unit under test readings from tests 4, 5, and 6 on the Test Card. This check verifies the linearity of the A-to-D converter which is fundamental to the 3458A's calibration technique. Calculate the following:

$$(\text{UUT Reading \#4}) - (\text{UUT Reading \#6}) = A$$

$$(\text{UUT Reading \#5}) - (\text{UUT Reading \#6}) = B$$

If the A-to-D converter is linear, the difference in the absolute values of A and B will be less than or equal to 4 μV .

OPERATIONAL TEST CARD - 1 YEAR LIMITS

Agilent Model 3458A Digital Multimeter Test Performed By _____

Serial Number _____ Date _____

CAL? 60 _____

TEMP? _____

Difference _____ - (must be less than 5 degrees C)

Perform an ACAL OHMS

Test #	3458A Input Range	3458A Range	Transfer Standard Reading	Unit Under Test Reading	Difference	Limit (Std)	Limit (Opt 002)	Pass	Fail
--------	-------------------	-------------	---------------------------	-------------------------	------------	-------------	-----------------	------	------

2-Wire Ohms Function Offset Tests

1	Short	10 Ω	N/A	_____	N/A	00.25007	00.25007	_____	_____
				(Front terminals)					
2	Short	10 Ω	N/A	_____	N/A	00.25007	00.25007	_____	_____
				(Rear terminals)					

4-Wire Ohms Function Gain Test

3	10 KΩ	10 KΩ	_____	_____	_____	00.000142	00.000142	_____	_____
---	-------	-------	-------	-------	-------	-----------	-----------	-------	-------

CAL? 59 _____

TEMP? _____

Difference _____ - (must be less than 5 degrees C)

Perform an ACAL DCV

DC Voltage Function Gain Test

4	10 V	10 V	_____	_____	_____	00.0000892	00.0000624	_____	_____
5	-10 V	10 V	_____	_____	_____	00.0000892	00.0000624	_____	_____

DC Voltage Function Offset Test

6	Short	10 V	N/A	_____	N/A	00.0000023	00.0000023	_____	_____
---	-------	------	-----	-------	-----	------------	------------	-------	-------

Introduction

This section contains procedures for adjusting the 3458A Multimeter. The 3458A uses closed-box electronic adjustment. No potentiometers or other electro-mechanical adjustments are used and the complete adjustment is done without removing any of the multimeter's covers. Only a voltage standard, a resistance standard, a low-thermal short, and an AC signal source are needed to perform all of the adjustments. This chapter contains the following adjustment procedures.

1. Front Terminal Offset Adjustment
2. Rear Terminal Offset Adjustment
3. DC Gain Adjustment
4. Resistance and DC Current Adjustment
5. AC Adjustment

You must perform the adjustments in the order presented in this chapter. All of the adjustments can be performed in approximately one hour (you must allow 4 hours of warm-up time from the time power is applied to the multimeter before performing any adjustments). Whenever adjusting the multimeter, always perform the adjustments numbered 1 through 4 in the above list. Adjustment number 5 (AC Adjustment) is required only once every 2 years or whenever the 03458-60502 or 03458-66503 PC assembly has been replaced or repaired. Product Note 3458A-3 in Appendix B discusses the purpose of each adjustment in detail.

An Adjustment Record is located at the back of this chapter. You should make photocopies of this record and complete the record whenever the multimeter is adjusted. The record contains information such as the date, which adjustments were performed, the calibration number, and the multimeter's adjustment temperature. You can then file the adjustment records to maintain a complete adjustment history for the multimeter.

Required Equipment

You will need the following equipment to perform the adjustments:

- A low-thermal 4-terminal short for the offset adjustments (this is typically a bent piece of copper wire as shown in Figure 1).
- 10 VDC Voltage Standard--Fluke 732A or equivalent (for the DC Gain Adjustment).
- 10 k Ω Resistance Standard--Fluke 742-10 K or equivalent (for the Resistance and DC Current Adjustment).
- AC Source-Agilent 3325A Synthesizer/Function Generator or equivalent (for the AC adjustment).

The resultant accuracy of the multimeter depends on the accuracy of the equipment used, the thermal characteristics of the short, and the type of cabling used. We recommend high impedance, low dielectric absorption cables for all connections.

Preliminary Adjustment Procedure

Perform the following steps prior to adjusting the 3458A:

1. Select the adjustment area. You can adjust the 3458A on the bench or in a system cabinet. The temperature of the adjustment environment should be between 15°C and 30°C. The more thermally stable the environment is, the more accurate the adjustment.
2. Connect the 3458A to line power and turn the multimeter on. Refer to "Installing the Multimeter" in Chapter 1 of the 3458A User's Guide for information on setting the line voltage switches and installing the line power fuse.
3. Remove all external input signals from the front and rear input terminals.
4. Select the DCV function (use the DCV key) and the 100 mV range (repeatedly press the down arrow key until the range no longer changes). (Refer to Chapter 2 of the 3458A User's Guide for more information on front panel operation.)
5. Set the front panel Terminals switch to the Front position.
6. Allow the multimeter to warm up for 4 hours from the time power was applied. (At this point, you can connect the 4-terminal short to the front terminals as shown in Figure 1 to prepare for the Front Terminal Offset Adjustment.)

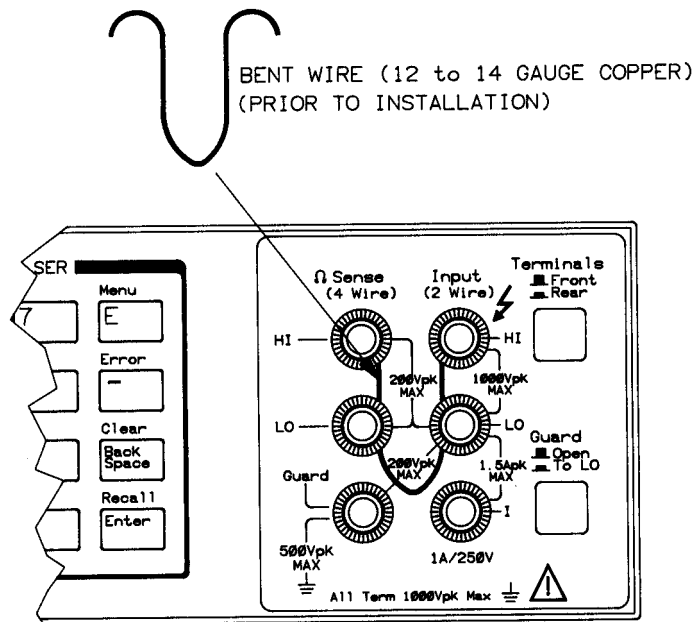

Figure 1. 4-Terminal Short

Front Terminal Offset Adjustment

This adjustment uses an external 4-terminal short. The multimeter makes offset measurements and stores constants for the DCV, DCI, OHM, and OHMF functions. These constants compensate for internal offset errors for front terminal measurements.

Equipment required: A low-thermal short made of 12 or 14 gauge solid copper wire as shown in Figure 1.

1. Make sure you have performed the steps described previously under "Preliminary Adjustment Procedures".
2. Connect a 4-terminal short across the front panel **HI** and **LO** Input terminals and the **HI** and **LO** Ω Sense terminals as shown in Figure 1.
3. After connecting the 4-terminal short, allow 5 minutes for thermal equilibrium.

Note Take precautions to prevent thermal changes near the 4-wire short. You should not touch the short after it is installed. If drafts exist, you should cover the input terminals/short to minimize the thermal changes.

4. Execute the CAL 0 command. The multimeter automatically performs the front terminal offset adjustment and the display shows each of the various steps being performed. This adjustment takes about 5 minutes. When the adjustment is complete, the multimeter returns to displaying DC voltage measurements.

Rear Terminal Offset Adjustment

This adjustment compensates for internal offset errors for rear terminal measurements.

1. Connect the 4-terminal short to the rear terminals.
2. Set the front panel Terminals switch to Rear.
3. After connecting the 4-terminal short, allow 5 minutes for thermal equilibrium.

Note Take precautions to prevent thermal changes near the 4-wire short. You should not touch the short after it is installed. If drafts exist, you should cover the input terminals/short to minimize the thermal changes.

4. Execute the CAL 0 command. The multimeter automatically performs the rear terminal offset adjustment and the display shows each of the various steps being performed. This adjustment takes about 5 minutes. When the adjustment is complete, the multimeter returns to displaying DC voltage measurements.
5. Remove the 4-terminal short from the rear terminals.

DC Gain Adjustment

In this adjustment, the multimeter measures the standard voltage using its 10V range. The multimeter then adjusts its gain so that the measured value agrees with the standard's exact value (specified using the CAL command). The multimeter then measures its 7V internal reference voltage using the 10V range and stores both the 10V gain adjustment constant and the value of the internal 7V reference. This adjustment also automatically performs the DCV autocalibration with computes DC gain constants.

Equipment required: A DC voltage standard capable of providing 10 VDC (the resultant accuracy of the 3458A depends on the accuracy of the voltage

standard).

Note Voltage standards from 1V DC to 12V DC can be used for this procedure. However, using a voltage standard <10V DC will degrade the multimeter's accuracy specifications.

1. Select the DC Voltage function.
2. Set the front panel **Terminals** switch to **Front**.
3. Connect the voltage standard to the multimeter's front panel **HI** and **LO Input** terminals as shown in Figure 2. If using a **Guard** wire (as shown in Figure 2), set the **Guard** switch to the **Open** position. If not using a **Guard** wire, set the **Guard** switch to the **To LO** position.
4. Execute the CAL command specifying the exact output voltage of the standard. For example, if the standard's voltage is 10.0001 VDC, execute CAL 10.0001. The multimeter automatically performs the DC gain adjustment and the display shows each of the various steps being performed. This adjustment takes about 2 minutes. When the adjustment is complete, the multimeter returns to displaying DC voltage measurements.
5. Disconnect the voltage standard from the multimeter.

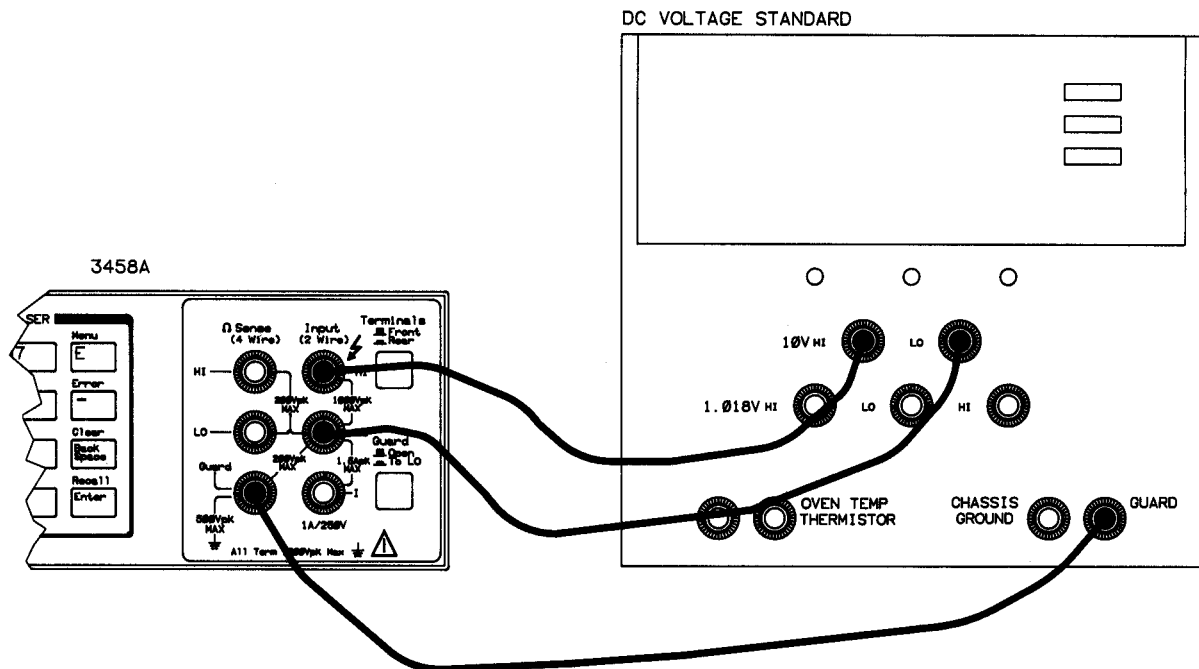

Figure 2. DC Gain Adjustment Connections

Resistance and DC Current Adjustment

This adjustment calculates gain corrections for the resistance and DC current ranges. The DC Gain Adjustment must be performed prior to this adjustment because this adjustment relies on the values calculated by the DC Gain Adjustment.

Note When offset compensated ohms is enabled (OCOMP ON command), the default delay time used by the multimeter for this adjustment is 50ms (50ms is the settling time used after the current source is switched on or off). For most resistance standards and cabling, this provides adequate settling time for the measurements made during the adjustment. If, however, the resistance standard and/or cabling has slow transient response or high dielectric absorption you should specify a longer delay. You can determine this experimentally prior to performing the following adjustment by measuring the resistance standard using a 50ms delay and then measuring it using a much longer delay (e.g., 1 second). If the two measurements are significantly different, you should use a longer delay in the adjustment procedure. You must specify the longer delay using the DELAY command prior to executing the CAL command (step 5). For example, to specify a 200ms delay execute: DELAY 200E-3. The multimeter will then use the specified delay in the adjustment. If a value of less than 50ms is specified, the multimeter will automatically use a delay of 50ms. Do not specify a delay longer than 60 seconds; a delay >60 seconds will adversely affect the adjustment.

Equipment required: A 10k Ω resistance standard (the resultant accuracy of the multimeter depends on the accuracy of the resistance standard used).

Note Resistance standards from 1k Ω to 12k Ω can be used for the procedure. However, using a resistance standard <10k Ω will degrade the multimeter's accuracy specifications.

1. Select the 4-wire ohms measurement function (use the shifted **OHM** key).
2. Execute the OCOMP ON command (use the front panel **Offset Comp** Ω key).

Note You can perform this adjustment with offset compensation disabled (OCOMP OFF command). This eliminates the settling time requirement (DELAY command) when dealing with high dielectric absorption in the adjustment setup (see note at the beginning of this adjustment). However, with offset compensation disabled, any offset voltages present will affect the adjustment. For most applications, we recommend enabling offset compensation for this adjustment.

3. Set the front panel **Terminals** switch to **Front**.
4. Connect the resistance standard to the multimeter's front panel **HI** and **LO Input** and **HI** and **LO Sense** terminals as shown in Figure 3. If using a **Guard** wire (as shown in Figure 2), set the **Guard** switch to the **Open** position. If not using a **Guard** wire, set the **Guard** switch to the **To LO** position.
5. Execute the CAL command specifying the exact value of the resistance standard. For example, if the standard's value is 10.003k Ω , execute CAL 10.003E3. The multimeter automatically performs the resistance and DC current adjustment and the display shows each of the various steps being performed. This adjustment takes about 12 minutes. When the adjustment is complete, the multimeter returns to displaying resistance readings.
6. Disconnect the resistance standard from the multimeter.
7. Execute the ACAL AC command (use the **AUTO CAL** key). This autocalibrates the multimeter's AC section since the following AC Adjustment is normally performed only once every two years or whenever the 03458-66502 or 03458-66503 PC Assembly has been replaced or repaired. The AC autocalibration takes about 2 minute to complete.

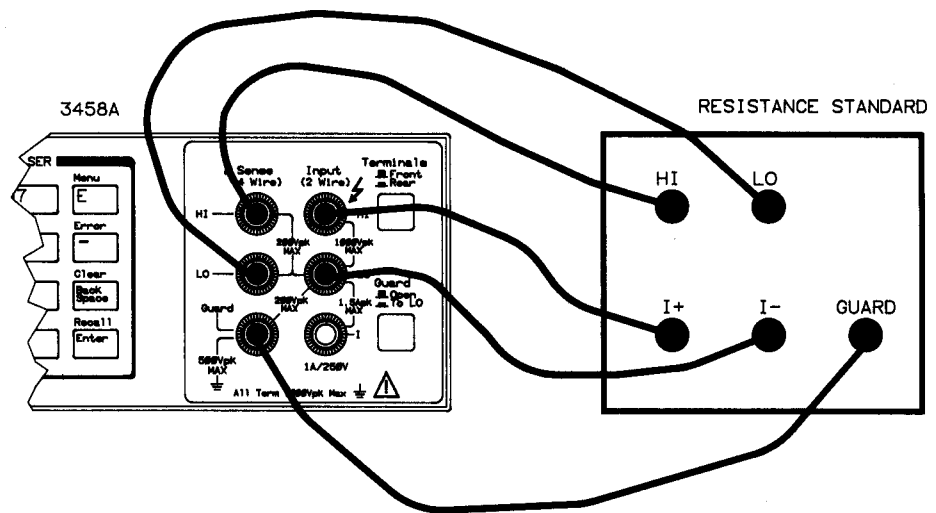

Figure 3. Resistance and DC Current Adjustment Connections

AC Adjustment

This adjustment is only required once every two years or whenever the 03458-66502 PC Assembly or the 03458-66503 PC Assembly has been replaced or repaired. This adjustment sets the internal crystal frequency for

the frequency and period measurement functions: adjusts the attenuator and amplifier high frequency response; and adjusts the Time Interpolator timing accuracy. Following this adjustment, the internal circuits have constant gain versus frequency.

Equipment required:

- Agilent 3325A Synthesizer/Function Generator or equivalent.
- 3V Thermal Converter, Ballantine 1395A-3 or equivalent.
- 1V Thermal Converter, Ballantine 1395A-1 or equivalent.
- 0.5V Thermal Converter, Ballantine 1395A-0.4 or equivalent.
- 50Ω BNC cable (keep this cable as short as possible)
- 50Ω resistive load (typically a 50Ω carbon composition or metal film resistor).
- BNC to Banana Plug Adapter--Agilent 1251-2277 or equivalent.

Caution In the following procedure, the output voltage of the synthesizer is adjusted with the thermal converters in-circuit. Thermal converters are typically easily damaged by voltage overload. Use extreme care to ensure the voltage applied to the thermal converters does not exceed the thermal converter's maximum voltage rating.

Procedure

In the following procedure, steps 1 through 12 characterize the frequency flatness of the synthesizer and cabling configuration. The equipment setting determined from this characterization are then used in the remaining steps to precisely adjust the multimeter.

Note The voltages referenced in this procedure are 3V, 1V and 100mV rms for the SCAL 10, SCAL 1, and SCAL .1 commands, respectively. If necessary, you can use any value between 3V and 10V rms wherever 3V is referenced, 300mV to 1V rms wherever 1V is referenced, and 30mV to 100mV wherever 100mV is referenced (make sure not to exceed the voltage rating of the thermal converters). (You still execute the SCAL 10, SCAL 1, and SCAL.1 commands regardless of the rms voltage value used). Whenever making low-level measurements, take precautions to minimize noise and interference in the test setup. Refer to "Test Considerations" in Chapter 4 for more information.

1. Execute the ACAL AC command. Following the autocal, execute the RESET command.
2. Set the front panel **Terminals** switch to **Front**. Set the **Guard** switch to the **To LO** position.

- Set the synthesizer to deliver a 3V rms sinewave at a frequency of 100 kHz. Connect the synthesizer, the 3V thermal converter, and the multimeter as shown in Figure 4. Record the exact DC voltage measured by the multimeter on Line A of the Adjustment Record.

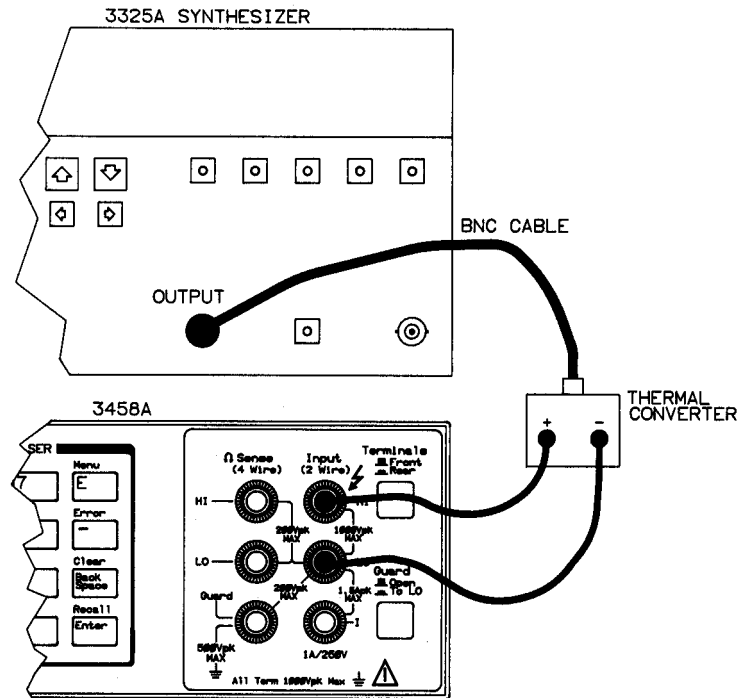

Figure 4. Characterizing the Adjustment Setup

- Set the synthesizer to deliver a 3V rms sinewave at a frequency of 2 MHz. Adjust the synthesizer's output voltage until the voltage displayed on the multimeter is within 0.2% of the voltage recorded on Line A. Record the synthesizer's voltage setting on Line C of the Adjustment Record.
- Set the synthesizer to deliver a 3V rms sinewave at a frequency of 8 MHz. Adjust the synthesizer until the voltage displayed on the multimeter is within 0.2% of the voltage recorded on Line A. Record the synthesizer's voltage setting on Line D of the Adjustment Record.
- Set the synthesizer to deliver a 1V rms sinewave at a frequency of 100 kHz. Replace the 3V thermal converter with the 1V thermal converter. Record the exact DC voltage measured by the multimeter on Line E of the Adjustment Record.
- Set the synthesizer to deliver a 1V rms sinewave at a frequency of 8 MHz. Adjust the synthesizer until the voltage displayed on the multimeter is within 0.2% of the voltage recorded on Line E. Record the synthesizer's voltage setting on Line F of the Adjustment Record.

8. Set the synthesizer to deliver a 100mV rms sinewave at a frequency of 100 kHz. Replace the 1V thermal converter with the 0.5V thermal converter. Record the exact DC voltage measured by the multimeter on Line G of the Adjustment Record.
9. Set the synthesizer to deliver a 100mV rms sinewave at a frequency of 8 MHz. Adjust the synthesizer until the voltage displayed on the multimeter is within 0.2% of the voltage recorded on Line G. Record the synthesizer's voltage setting on Line H of the Adjustment Record.
10. Disconnect the thermal converter and connect the synthesizer, 50Ω resistive load, and multimeter as shown in Figure 5.

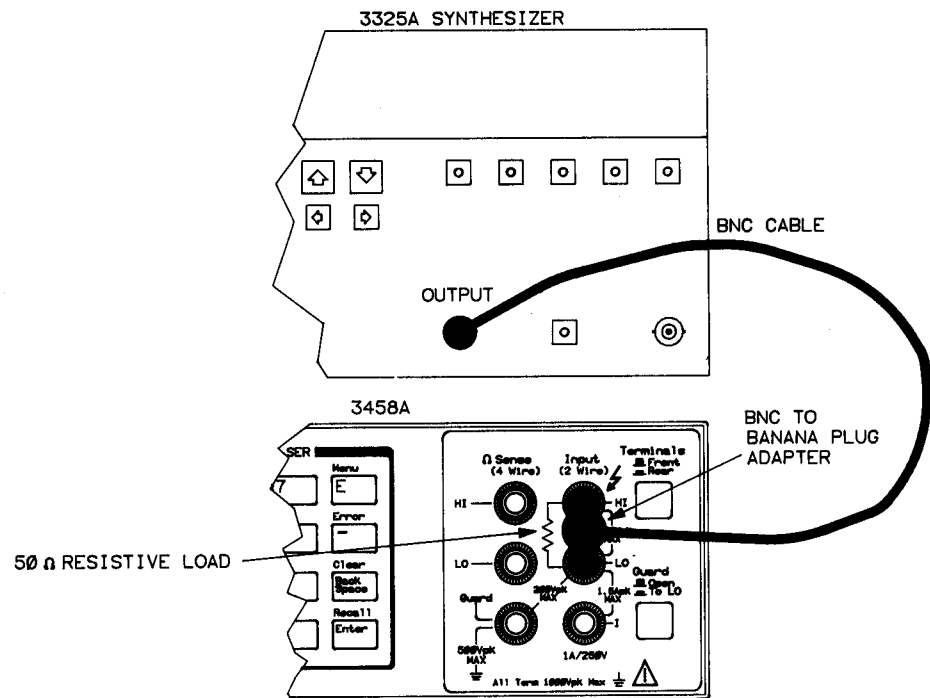

Figure 5. AC Adjustment Connections

11. Set the synthesizer to output 3V rms at 100kHz. Execute the SCAL 1E5 command. The multimeter automatically performs the adjustment. When the adjustment is complete, the multimeter returns to displaying DC voltage readings.
12. Without changing the synthesizer settings, execute the SCAL 10 command as shown on Line B of the Adjustment Record.
13. Set the synthesizer to the voltage and frequency shown on Line C of the Adjustment Record. Execute the SCAL command as shown on Line C of the Adjustment Record.

14. Repeat step 13 for each synthesizer setting and SCAL command shown on Lines D through H on the Adjustment Record.
15. Disconnect all equipment from the multimeter.
16. Execute the ACAL AC command.

3458A Adjustment Record

Adjusted by: _____ Date: _____

3458A serial number or other device ID number: _____

Previous calibration number (CALNUM? command): _____ (record this number before adjusting the multimeter)

Adjustments performed:*

1. ___ Front Terminal Offset Adjustment
2. ___ Rear Terminal Offset Adjustment
3. ___ DC Gain Adjustment (DCV Standard Uncertainty = _____)
4. ___ Resistance and DC Current Adjustment (Resistance Standard Uncertainty = _____)
5. ___ AC Adjustment:

	Multimeter Reading	Synthesizer setting	AC source frequency	Execute Command	Adjustment Description
Line A	_____ V	3V	100 kHz	SCAL 1E5	Frequency Adjustment
Line B	_____	3V	100 kHz	SCAL 10	Low-freq. voltage reference
Line C	_____	_____ V	2 MHz	SCAL 10	Time interpolator & flatness
Line D	_____	_____ V	8 MHz	SCAL 10	Flatness Adjustment
Line E	_____ V	1V	100 kHz	SCAL 1	Low-freq voltage reference
Line F	_____	_____ V	8 MHz	SCAL 1	Flatness Adjustment
Line G	_____ V	100mV	100 kHz	SCAL .1	Low-freq voltage reference
Line H	_____	_____ V	8 MHz	SCAL .1	Flatness Adjustment

Internal adjustment temperature (TEMP? command): _____ °C

Calibration number (CALNUM? command): _____ (record this number after adjusting the multimeter)

Calibration secured: _____ unsecured: _____

*Always perform the above adjustments numbered 1 through 4: adjustment number 5 is only required once every 2 years or whenever the 03458-66502 or 03458-66503 PC Assembly has been replace or repaired.

Chapter 4 Performance Verification Tests

Introduction

This chapter contains performance tests designed to verify that the 3458A Multimeter is operating within the specifications listed in Appendix A. The Performance Tests are performed without access to the interior of the instrument.

Required Equipment

The equipment required for the performance tests is listed below. Equipment other than that recommended can be used as long as the specifications of the substituted equipment is equivalent to that recommended.

- Fluke 5700A AC/DC Standard
- Agilent 3325A Function Generator/Frequency Synthesizer
- Transfer standard DMM (3458A Opt. 002 within 90 days of CAL)
- Low thermal short (see Figure 1)
- Low thermal test leads (such as Agilent 11053A, 11174A, or 11058A)
- Shielded test leads (such as Agilent 11000-60001)

Note

To have your transfer standard 3458A Opt. 002 calibrated to 90 day specifications, contact your Agilent Technologies sales and service office.

Test Card

Results of the performance tests may be tabulated on the appropriate Test Card located at the end of the test procedures. Make copies of the Test Cards for performance test tabulations and retain the originals to copy for use in future performance testing. The Test Cards list all of the tested functions and the acceptable limits for the test results.

Calibration Cycle

The frequency of performance verification depends on the instrument's usage and the environmental operating conditions. To maintain 24 hour or 90-day specifications, the instrument should be checked at these intervals by a metrology lab with test capability for these accuracies. For normal operation, it is recommended you perform performance verification every year.

Test Considerations

This section discusses many of the major problems associated with low-level measurements. Many of the measurements in this manual fall into this category. It is beyond the scope of this manual to go into great detail on this subject. For more information, refer to a textbook dealing with standard metrology practices.

- **Test leads:** Using the proper test leads is critical for low-level measurements. We recommend using Teflon®¹ cable or other high impedance, low dielectric absorption cable for all measurement
- **Connections.** It is important to periodically clean all connection points (including the multimeter terminals) using a cotton swab dipped in alcohol.
- **Noise Rejection:** For DC voltage, DC current, and resistance measurements, the multimeter achieves normal mode noise rejection (NMR)² for noise at the A/D converter's reference frequency (typically the same as the power line frequency) when the integration time is ≥ 1 power line cycles. You can specify integration time in terms of power line cycles (PLCs) using the NPLC command. For maximum NMR of 80dB, set the power line cycles to 1000 (NPLC 1000 command).
- **Guarding:** Whenever possible, make measurements with the multimeter's Guard terminal connected to the low side of the measurement source and the Guard switch set to the Open position (guarded measurements). This provides the maximum effective common mode rejection (ECMR).
- **Thermoelectric Voltages (Thermal EMF):** This is a common source of errors in low-level measurements. Thermal EMF occurs when conductors of dissimilar metals are connected together or when different parts of the circuit being measured are at different temperatures. Thermal EMF can become severe in high-temperature environments. To minimize thermal EMF, minimize the number of connections: use the same type of metal for all connections; minimize the temperature variations across the measurement wiring: try to keep the multimeter and the wiring at the same temperature: and avoid high-temperature environments whenever possible.
- **Electromagnetic Interference (EMI):** This type of interference is generally caused by magnetic fields or high levels of radio frequency (RF) energy. Magnetic fields can surround all types of equipment operating off of AC line power, especially electric motors. RF energy from nearby radio or television stations or communications equipment can also be a problem. Use shielded wiring whenever the measurement setup is in the presence of high EMI. If possible, move farther away or

1. Teflon® is a registered trademark of EI DuPont de Nemours and Company.

2. Normal mode noise rejection is the multimeter's ability to reject noise at the power line frequency from DC voltage, DC current, or resistance measurements.

turn off sources of high EMI. It may be necessary to test in a shielded room.

- **Ground Loops:** Ground loops arise when the multimeter and the circuit under test are grounded at physically different points. A typical example of this is when a number of instruments are plugged into a power strip in an equipment rack. If there is a potential difference between the ground points, a current will flow through this ground loop. This generates an unwanted voltage in series with the circuit under test. To eliminate ground loops, ground all equipment/circuits at the same physical point.
- **Internal Temperature:** The internal temperature of the 3458A under test must be within 5°C of its temperature when last adjusted. If the multimeter's temperature is not within 5°C first check the multimeter's fan operation and clean the filter. Also, make sure that you adjust the operating environment such that the ambient temperature is at or very near 25°C. You will achieve the best results if you maintain your environment close to 25°C. If you choose to verify performance when the temperature is not within 5°C, you must recalculate all test limits based on the temperature variation beyond the 5°C limitation. The published test limits were calculated without additional temperature coefficient errors added.

General Test Procedure

The following performance tests utilize a transfer standard DMM to precisely measure the verification source. The transfer standard DMM recommended is an 3458A option 002 (high stability) that is within a 90-day calibration. The verification source is first measured by the transfer standard DMM and then connected to the unit under test. The general test procedure is as follows:

A. Performed one time prior to testing (Preliminary steps).

1. Verify that the Verification Source is properly warmed up
2. The 3458A requires a 4 hour warm-up period. Verify that the transfer standard DMM and the 3458A unit under test (UUT) are properly warmed up.
3. The internal temperature of the 3458A under test must be within 5 degrees C of its temperature when last adjusted (CAL 0, CAL 10, and CAL 10K). These temperatures can be determined by executing the commands **CAL? 58**, **CAL? 59**, **CAL? 60**.
4. If the instrument self test has not been run, verify all inputs are disconnected and execute the TEST function. The display must read "SELF TEST PASSED".

B. Repeated for each function and range tested.

5. Execute the ACAL command for the function being tested on both the transfer standard and the unit under test (UUT).
6. Configure the transfer DMM as specified in each test.
7. Configure the DMM under test as specified in each test.
8. Connect the Verification source to the transfer standard DMM and determine the source output (see Figure 6A). Record this value on the Test Card under "Transfer Standard Reading".
9. Disconnect the Verification Source from the transfer standard DMM and connect it to the 3458A under test (see Figure 6B). Record this value on the Test Card under "Unit Under Test Reading".
10. Calculate the difference between the transfer standard DMM reading and the UUT reading. Record the absolute value (ignore sign) of the difference on the Test Card under "Difference".
11. Compare this difference to the allowable difference specified on the Test Card. If less than the specified difference, note that the test passed. If greater than the specified difference, note that the test failed.

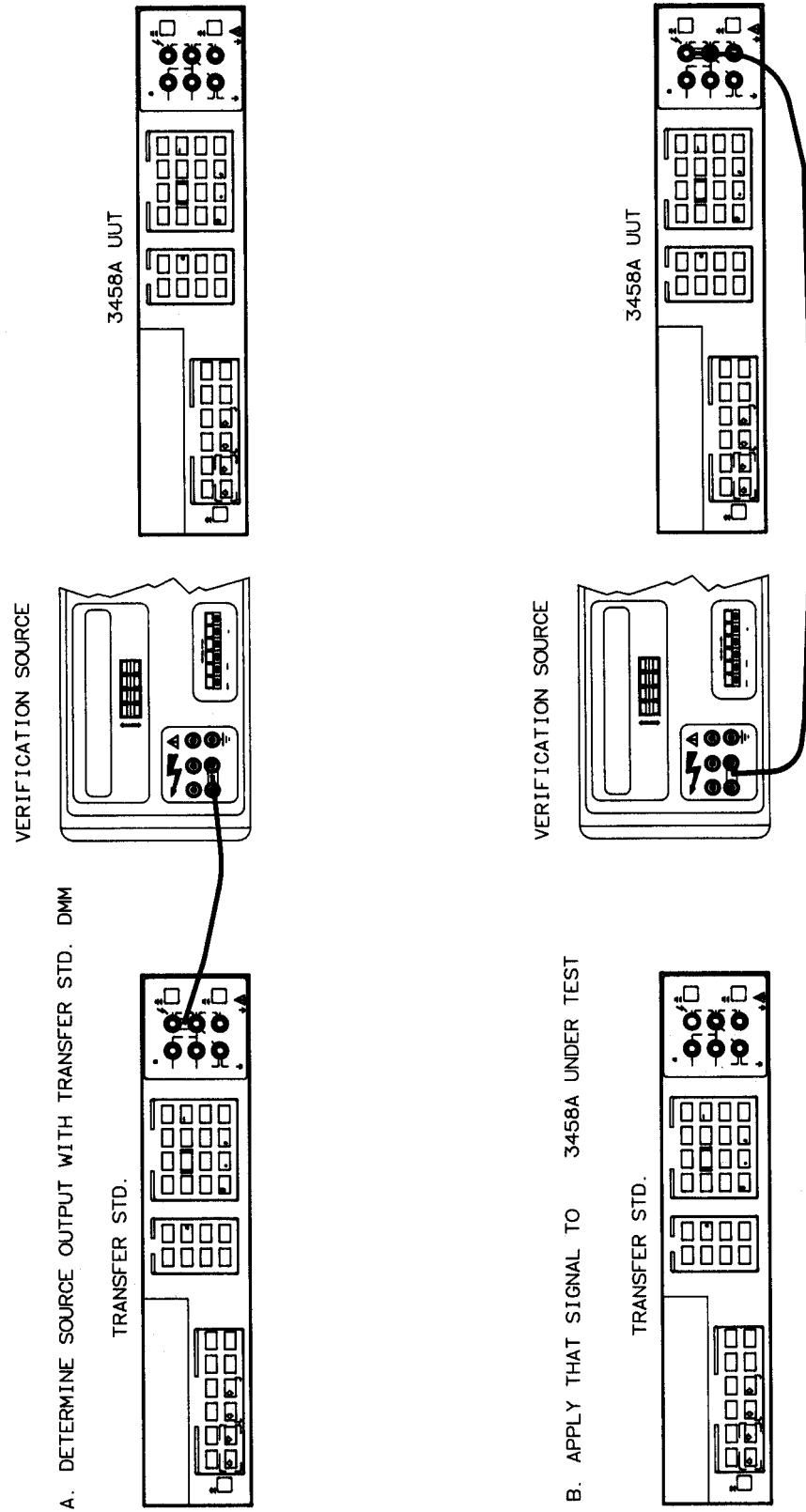

Figure 6. General Test Procedure

DC Voltage Performance Tests

Required Equipment

The following equipment or its equivalent is required for these performance tests.

- Stable DC voltage source (Fluke 5700A or equivalent)
- Transfer standard DMM (3458A Opt. 002 within 90 days of CAL)
- Low thermal short (copper wire)
- Low thermal test leads (such as Agilent 11053A, 11174A, 11058A)

Preliminary Steps

1. Verify that the DC source is properly warmed up.
2. The 3458A requires a 4-hour warm-up period. If this has not been done, turn the instrument ON and allow it to warm up before proceeding.
3. The internal temperature of the 3458A under test must be within 5 degrees C of its temperature when last adjusted. Use the TEMP? command to obtain the current internal temperature and compare it to the calibration temperature obtained by executing the command CAL? 59. Record the temperatures obtained on the DC VOLTAGE TESTS test card.
4. If the instrument self test has not been run, make certain all inputs are disconnected and execute the TEST function. The display must read "SELF TEST PASSED".
5. Execute the ACAL DCV command on both the transfer standard DMM and the UUT using the front panel "Auto Cal" key and scroll keys. This auto calibration will take approximately two minutes to complete.
6. Configure the transfer standard DMM as follows:
 - DCV
 - NDIG 8
 - NPLC 100
 - Trig SGL
7. Configure the DMM under test as follows:
 - DCV
 - NDIG 8
 - NPLC 100
 - Trig SGL

DC Voltage Function Offset Test

The following procedure tests the offset voltage specification with the input terminals shorted. A low-thermal short must be used to minimize thermally induced errors. Also, you must allow five minutes before making the first measurement to allow for thermal stabilization of the range relays.

1. Connect a low thermal short across the front panel **HI** and **LO** input terminals of the DMM under test (see Figure 1).
2. Set the range of the 3458A under test as specified in Table 1.
3. Let the instrument sit for five minutes before taking the first reading to allow the range relay and short to thermally stabilize. NOTE: The thermal stabilization achieved for the 100 mV range is present for the 1V and 10V ranges since these ranges use the same relays. The range relays are opened for the 100V and 1000V ranges and therefore, have no thermal impact on the measurement.
4. Execute Trig and record the offset reading (absolute value) for each range listed in Table 1 and on the DC VOLTAGE TESTS Test Card provided at the end of this chapter.

Table 1. Offset Performance Tests

Offset Test Number	DMM Range
1	100 mV
2	1 V
3	10 V
4	100 V
5	1000 V

5. If any of the offset readings are greater than the limits specified on the DC VOLTAGE TESTS Test Card, the instrument should be adjusted. Refer to Chapter 3. "Adjustment Procedures", to make adjustments.
6. Remove the short from the front panel terminals.

DC Voltage Function Gain Test

The following is a step-by-step procedure for all test points that performance verify gain of the DC voltage function. The procedure requires alternately connecting the transfer standard DMM and then the 3458A under test to the DC verification source as described in the general test description.

1. Connect the DC voltage source to the transfer standard DMM.
2. Set the range of the transfer standard DMM as specified in Table 2.
3. Set the range of the 3458A under test as specified in Table 2.
4. Set the DC source to the voltage level specified in Table 2. Let the instrument sit for five minutes before taking the first reading to

allow the range relay and short to thermally stabilize. NOTE: The thermal stabilization achieved for the 100 mV range is present for the 1V and 10V ranges since these ranges use the same relays. The range relays are opened for the 100V and 1000V ranges and therefore, have no thermal impact on the measurement.

5. Execute **Trig SGL** and read the output of the DC voltage source as measured with the transfer standard DMM and record this reading in the "Transfer Standard Reading" column of the DC VOLTAGE TESTS test card.
6. Remove the connection from the transfer standard DMM to the DC voltage source.
7. Connect the 3458A under test to the DC voltage source.
8. Execute **Trig SGL** and read the value as measured with the 3458A under test and record this value in the "Unit Under Test Reading" column of the DC voltage Test Record.
9. Repeat steps 1 through 8 for each of the remaining DC voltage test points as specified in Table 2.

Table 2. DCV Gain Performance Tests

DC Gain Test Number	DMM Range	Source Output
1	100 mV	100 mV
2	1 V	1 V
3	10 V	1 V
4	10 V	-1 V
5	10 V	-10 V
6	10 V	10 V
7	100 V	100 V
8 ^a	1000 V	1000 V

a.NOTE: After completing test 8, decrease the 1000V DCV standard output to 0V before disconnecting.

10. After all DC gain tests have been performed, calculate and record in the column provided. the difference (absolute value) between the transfer standard DMM reading and the unit under test reading for each of the test points.
11. If any of the differences calculated are beyond the specified limits, refer to Chapter 3. "Adjustment Procedures", to make adjustments.

Analog AC Voltage Performance Tests

Required Equipment

The following list of equipment is required to test the analog AC performance of the 3458A.

- Stable AC voltage source (Fluke 5700A or equivalent).
- Transfer Standard DMM (3458A Opt. 002 within 90 days of Cal.)
- Shielded test leads terminated with dual banana plugs (such as Agilent 11000-60001).

Preliminary Steps

1. Make certain that the AC source is properly warmed up.
2. The 3458A requires a 4 hour warm up period. If this has not been done, turn the instrument ON and allow it to warm up.
3. Execute the ACAL AC function on both the transfer standard DMM and the UUT. This auto calibration will take approximately 1 minute to complete.
4. If the instrument Self Test has not been run, make certain all inputs are disconnected and execute the TEST function. The display must read "SELF TEST PASSED".
5. Configure the transfer standard DMM as follows:
 - ACV
 - SETACV SYNC
 - ACBAND 10,2E6
 - RANGE10
 - RES .001
 - TRIG SGL
 - LFILTER ON
6. Configure the DMM under test as follows:
 - ACV
 - SETACV ANA
 - ACBAND 10,2E6
 - RANGE10
 - RES .01
 - TRIG SGL
 - LFILTER ON

AC Voltage Test Procedure

The following is a step-by-step procedure for all test points in the AC performance verification section. The procedure requires alternately connecting the transfer standard DMM and then the 3458A under test to the AC source. Because of this and because the accuracy of AC coupled measurements does not suffer due to small thermal induced offsets, the test

connection can be made using shielded test leads terminated with dual banana plugs. Refer to the general test procedure for test connections.

1. Connect the AC voltage source to the transfer standard DMM.
2. Set the range of the transfer standard DMM as specified in Table 3.
3. Set the range of the 3458A under test as specified in Table 3.
4. Set the AC source to the voltage level and frequency specified in Table 3
5. Execute **Trig SGL** and read the output of the AC source as measured with the transfer standard DMM and record this reading in the "Transfer Standard Reading" column of the AC VOLTAGE TESTS Test Card.
6. Remove the connection from the transfer standard DMM to the AC source.
7. Connect the 3458A under test to the AC source.
8. Execute **Trig SGL** and read the value as measured with the 3458A under test and record this value in the "Unit Under Test Reading" column of the AC VOLTAGE TESTS Test Card.
9. Repeat steps 1 through 8 for each of the remaining AC voltage test points as specified in Table 3.

Table 3. AC Performance Tests

AC Test Number	DMM Range	Source Level	Source Frequency
1	100 mV	100 mV	1 KHz
2	1 V	1 V	1 KHz
3	10 V	1 V	1 KHz
4	10 V	10 V	20 Hz
5	10 V	10 V	1 KHz
6	10 V	10 V	20 KHz
7	10 V	10 V	100 KHz
8	10 V	10 V	1 MHz
9	100 V	100 V	1 KHz
10 ^a	1000 V	700 V	1 KHz

a.NOTE: After completing test 10, reduce the ACV standard voltage to 0V before disconnecting.

10. After all AC voltage tests have been performed, calculate and record in the column provided, the difference between the transfer standard DMM reading and the unit under test reading for each of the test

- points.
11. If any of the differences calculated are greater than the specified limits, refer to Chapter 3, "Adjustment Procedures", to make adjustments.

DC Current Performance Tests

Required Equipment

The following equipment or its equivalent is required for these performance tests.

- Stable DC current source (Fluke 5700A or equivalent)
- Transfer standard DMM (3458A Opt. 002 within 90 days of CAL)
- Low thermal test leads (such as Agilent 11053A, 11174A, or 11058A)

Preliminary Steps

1. Verify that the DC current source is properly warmed up.
2. The 3458A requires a 4 hour warm-up period. If this has not been done, turn the instrument ON and allow it to warm up before proceeding.
3. The internal temperature of the 3458A under test must be within 5 degrees C of its temperature when last adjusted. The current internal temperature is obtained by executing TEMP?. Compare this temperature to the calibration temperature obtained by executing the command CAL? 60. Record these temperatures on the DC CURRENT TESTS Test Card.
4. If the instrument self test has not been run, make certain all inputs are disconnected and execute the TEST function. The display must read "SELF TEST PASSED".
5. Execute the ACAL OHMS function on both the transfer standard DMM and the UUT. This auto calibration will take approximately ten minutes to complete.
6. Configure the transfer standard DMM as follows:
 - DCI
 - NDIG 8
 - NPLC 100
 - Trig SGL
7. Configure the DMM under test as follows:
 - DCI
 - NDIG 8
 - NPLC 100
 - Trig SGL

DC Current Function Offset Test

The following procedure tests the DC current offset specifications with the input terminals open.

1. Set the 3458A under test to the DC Current Function (DCI).
2. Set the range of the 3458A under test as specified in Table 4
3. Let the instrument sit for 5 minutes to allow the range relays to thermally stabilize.
4. Execute Trig and record the absolute value of the offset reading of each range listed in Table 4 on the DC CURRENT TESTS Test Card provided at the end of this section.

Table 4. Current Offset Performance Tests

Offset Test Number	DMM Range
1	100 μ A
2	1 mA
3	10 mA
4	100 mA
5	1 A

5. If the offset tests are out of specification, perform another ACAL before performing step 6 below.
6. If any of the offset readings are beyond the limits specified in the Test Record, the instrument should be adjusted. Refer to Chapter 3 to make adjustments.

DC Current Function Gain Test

The following is a step-by-step procedure for all test points that performance verify gain of the DC current function. The procedure requires alternately connecting the transfer standard DMM and then the 3458A under test to the DC verification source as described in the section titled "General Test Procedure".

1. Connect the DC current source to the transfer standard DMM I and LO input terminals using low thermal test leads.
2. Set the range of the transfer standard DMM as specified in Table 5.
3. Set the range of the 3458A under test as specified in Table 5.
4. Set the DC source to the current level specified in Table 5.
5. Execute **Trig SGL** and read the output of the DC current source as measured with the transfer standard DMM and record this reading in the "Transfer Standard Reading" column of the DC CURRENT TESTS Test Card.
6. Remove the connection from the transfer standard DMM to the DC

current source.

7. Connect the DC current source to the 3458A under test HI and LO input terminals.
8. Execute **Trig** and read the value as measured with the 3458A under test and record this value in the "Unit Under Test Reading" column of the DC CURRENT TESTS Test Card.
9. Repeat steps 1 through 8 for each of the remaining DC current test points as specified in Table 5.

Table 5. DCI Gain Performance Tests

DCI Gain Test Number	Source and DMM Range	Source Output
1	100 μ A	100 μ A
2	1 mA	1 mA
3	10 mA	10 mA
4	100 mA	100 mA
5	1 A	1 A

10. After all DC current gain tests have been performed, calculate and record in the column provided, the difference (absolute value) between the transfer standard DMM reading and the unit under test reading for each test point.
11. If any of the differences calculated are beyond the specified limits, refer to Chapter 3, "Adjustment Procedures", to make adjustments.
12. Reduce the output of the DC Current Source and disconnect it from the 3458A input terminals.

Ohms Performance Tests

Required Equipment

The following list of equipment is required to test the ohms performance of the 3458A.

- Stable resistance standard (Fluke 5700A or equivalent)
- Transfer standard DMM (3458A Opt. 002 within 90 days of CAL)
- Low thermal short (copper wire)
- Low thermal test leads (such as Agilent 11053A, 11174A, or 11058A)

Preliminary Steps

1. Verify that the resistance standard is properly warmed up.
2. The 3458A requires a 4-hour warm-up period. If this has not been

done, turn the instrument ON and allow it to warm up before proceeding.

3. The internal temperature of the 3458A under test must be within 5 degrees C of its temperature when last ohms adjusted. The current internal temperature can be obtained by executing TEMP?. Compare this temperature to adjustment temperature obtained by executing the command CAL? 60 and record both temperatures on the OHMS TESTS Test Card.
4. If the instrument self test has not been run, make certain all inputs are disconnected and execute the TEST function. The display must read "SELF TEST PASSED".
5. If you have just performed DCI tests, you have done an ACAL OHMS which takes approximately ten minutes to complete. Compare the TEMP? temperatures recorded on the DC CURRENT TESTS and OHMS TESTS Test Cards. If they differ by more than 1°C. execute ACAL OHMS again. If DCI tests have not been done previously, execute ACAL OHMS.
6. Configure the transfer standard DMM as follows:
 - OHMF
 - NDIG 8
 - NPLC 100
 - OCOMP ON
 - Trig SGL
7. Configure the DMM under test as follows:
 - OHM
 - NDIG 8
 - NPLC 100
 - OCOMP ON
 - Trig SGL

2-Wire Ohms Function Offset Test

The following procedure performance verifies the front terminal ohms offset.

1. Connect a low thermal short across the front panel **HI** and **LO** input terminals of the 3458A under test as shown in Figure 1.
2. Set the 3458A under test to the 10 Ω range. Allow 5 minutes for the range relays to thermally stabilize.
3. Execute **Trig** and use the OHMS TESTS Test Card to record the offset reading.
4. Remove the short from the front panel input terminals.

4-Wire Ohms Function Offset Test (Rear Terminals)

This procedure performance verifies the rear terminal ohms offset.

1. Connect a low thermal short across the rear terminals of the 3458A as shown for the front terminals in Figure 1.
2. On the 3458A under test, select 4-wire ohms and the 10 Ω range by executing **OHMF, 10**.
3. Execute **Trig** and use the OHMS TESTS Test Card to record the offset reading.
4. Remove the short from the rear panel input terminals.

4-Wire Ohms Function Gain Test

The following is a step-by-step procedure for all test points that performance verify gain of the ohms function. The procedure requires alternately connecting the transfer standard DMM and then the 3458A under test to the resistance verification source as described in the section titled "General Test Procedure".

1. Connect the resistance standard to the transfer standard DMM 4-wire ohms front input terminals.
2. Set the range of the transfer standard DMM as specified in Table 6.
3. Set the range of the 3458A under test as specified in Table 6.
4. Set the resistance standard to the ohms level specified in Table 6.
5. Execute Trig and read the output of the resistance standard as measured with the transfer standard DMM and record this reading in the "Transfer Standard Reading" column of the OHMS TESTS Test Card.
6. Remove the connection from the transfer standard DMM to the resistance standard.
7. Connect the resistance standard to the front panel 4-wire ohms input terminals of the 3458A under test.
8. Execute **Trig two times** and read the value as measured with the 3458A under test and record this value in the "Unit Under Test Reading" column of the OHMS TESTS Test Card.
9. Repeat steps 1 through 8 for each of the remaining resistance test points as specified in Table 6.

Table 6. OHMF Gain Performance Tests

OHMF Gain Test Number	Source and DMM Range	Source Output
1	10 Ω	10 Ω
2	100 Ω	100 Ω
3	1 k Ω	1 k Ω
4	10 k Ω	10 k Ω
5	100 k Ω	100 k Ω
6	1 M Ω	1 M Ω
7	10 M Ω	10 M Ω

10. After all OHMF gain tests have been performed, calculate and record in the column provided, the difference (absolute value) between the transfer standard DMM reading and the unit under test reading for each of the test points.
11. If any of the differences calculated are beyond the specified limits, refer to Chapter 3 to make adjustments.
12. Disconnect the resistance standard from the 3458A input terminals.

Frequency Counter Performance Tests

Required Equipment

The following equipment is required for testing the frequency counter performance of the 3458A.

- Stable frequency source (Agilent 3325A Frequency Synthesizer or equivalent)
- Shielded test leads, BNC to dual banana plug (such as Agilent 11001-60001)

Preliminary Steps

1. Verify that the frequency source is properly warmed up.
2. The 3458A requires a 4-hour warm-up period. If this has not been done, turn the instrument ON and allow it to warm up before proceeding.
3. If the instrument self test has not been run, make certain all inputs are disconnected and execute the TEST function. The display must read "SELF TEST PASSED".

4. Configure the DMM under test as follows:
 - FREQ
 - Trig SGL
 - FSOURCE ACDCV
 - LEVEL 0,DC

Frequency Counter Accuracy Test

1. Execute FSOURCE ACDCV (specifies the type of signal to be used as the input signal for frequency measurement).
2. Set the Frequency Standard to output a 1 volt p-p, 1 Hz sine-wave. Record the exact Frequency Standard Value on the FREQUENCY TESTS Test Card. Connect the output of the Frequency Standard to the HI and LO input terminals of the 3458A under test.
3. Execute **Trig** and record the Unit Under Test Reading on the FREQUENCY TESTS Test Card.
4. Subtract the 1 Hz Unit Under Test Readings from the 1 Hz Frequency Standard Value. Record the difference on the FREQUENCY TESTS Test Card.
5. Change the Frequency Standard to 10 MHz and record the exact Frequency Standard Value on the FREQUENCY TESTS Test Card. Execute **Trig**, and record the Unit Under Test Reading on the FREQUENCY TESTS Test Card.
6. Subtract the 10 MHz Unit Under Reading from the 10 MHz Frequency Standard Value. Record the difference on the FREQUENCY TESTS Test Card.
7. If either of the differences are beyond the limits specified, the instrument should be adjusted. See Chapter 3, "Adjustment Procedures," to make adjustments.

PERFORMANCE TEST CARD - 1 YEAR LIMITS

Agilent Model 3458A Digital Multimeter

Test Performed By _____

Serial Number _____

Date _____

DC VOLTAGE TESTS

CAL? 59 _____

TEMP? _____

Difference _____ - (must be less than 5 degrees C)

Perform an ACAL DVC

Test #	3458A Input	3458A Range	Transfer Standard Reading	Unit Under Test Reading	Difference	Limit (Std)	Limit (Opt 002)	Pass	Fail
<u>OFFSET TESTS (NOTE: Math Null is Disabled)</u>									
1	Short	100 mV	N/A	_____	N/A	000.00106 mV	000.00106 mV	_____	_____
2	Short	1 V	N/A	_____	N/A	0.0000106 V	0.0000106 V	_____	_____
3	Short	10 V	N/A	_____	N/A	00.0000023 V	00.0000023 V	_____	_____
4	Short	100 V	N/A	_____	N/A	000.0000036 V	000.0000036 V	_____	_____
5	Short	1000 V	N/A	_____	N/A	0000.00010 V	0000.00010 V	_____	_____
<u>GAIN TESTS</u>									
1	100 mV	100 mV	_____	_____	_____	000.00212 mV	000.00188 mV	_____	_____
2	1 V	1 V	_____	_____	_____	0.0000998 V	0.0000740 V	_____	_____
3	1 V	10 V	_____	_____	_____	00.0000111 V	00.0000085 V	_____	_____
4	-1 V	10 V	_____	_____	_____	00.0000111 V	00.0000085 V	_____	_____
5	-10 V	10 V	_____	_____	_____	00.0000892 V	00.0000624 V	_____	_____
6	10 V	10 V	_____	_____	_____	00.0000892 V	00.0000624 V	_____	_____
7	100 V	100 V	_____	_____	_____	000.001114 V	000.000853 V	_____	_____
8	1000 V	1000 V	_____	_____	_____	0000.02396 V	0000.01934 V	_____	_____

PERFORMANCE TEST CARD - 1 YEAR LIMITS

Agilent Model 3458A Digital Multimeter

Test Performed By _____

Serial Number _____

Date _____

AC VOLTAGE TESTS

Perform an ACAL AC

Test #	3458A Input	3458A Range	Transfer Standard Reading	Unit Under Test Reading	Difference	Limit (Std)	Limit (Opt 002)	Pass	Fail
1	100 mV, 1KHz	100 mV	_____	_____	_____	000.0250 mV	000.0250 mV	_____	_____
2	1 V, 1KHz	1 V	_____	_____	_____	0.000250 V	0.000250 V	_____	_____
3	1 V, 1KHz	10 V	_____	_____	_____	00.00096 V	00.00096 V	_____	_____
4	10 V, 20 Hz	10 V	_____	_____	_____	00.01338 V	00.01338 V	_____	_____
5	10 V, 1KHz	10 V	_____	_____	_____	00.00250 V	00.00250 V	_____	_____
6	10 V, 20KHz	10 V	_____	_____	_____	00.00272 V	00.00272 V	_____	_____
7	10 V, 100 KHz	10 V	_____	_____	_____	00.05372 V	00.05372 V	_____	_____
8	10 V, 1MHz	10 V	_____	_____	_____	00.55450 V	00.55450 V	_____	_____
9	100 V, 1KHz	100 V	_____	_____	_____	000.0364 V	000.0364 V	_____	_____
10	700 V, 1 KHz	1000 V	_____	_____	_____	0000.544 V	0000.544 V	_____	_____

PERFORMANCE TEST CARD - 1 YEAR LIMITS

Agilent Model 3458A Digital Multimeter

Test Performed By _____

Serial Number _____

Date _____

DC CURRENT TESTS

CAL? 60 _____

TEMP? _____

Difference _____ - (must be less than 5 degrees C)

Perform an ACAL OHMS

Test #	3458A Input	3458A Range	Transfer Standard Reading	Unit Under Test Reading	Difference	Limit (Std)	Limit (Opt 002)	Pass	Fail
<u>OFFSET TESTS (NOTE: Math Null is Disabled)</u>									
1	Open	100 μ A	N/A	_____	N/A	000.00095 μ A	000.00095 μ A	_____	_____
2	Open	1 mA	N/A	_____	N/A	0.0000065 mA	0.0000065 mA	_____	_____
3	Open	10 mA	N/A	_____	N/A	00.0000065 mA	00.0000065 mA	_____	_____
4	Open	100 mA	N/A	_____	N/A	000.000065 mA	000.000065 mA	_____	_____
5	Open	1 A	N/A	_____	N/A	0.0000115 A	0.0000115 A	_____	_____
<u>GAIN TEST</u>									
1	100 μ A	100 μ A	_____	_____	_____	000.00356 μ A	000.00356 μ A	_____	_____
2	1 mA	1 mA	_____	_____	_____	0.0000323 mA	0.0000323 mA	_____	_____
3	10 mA	10 mA	_____	_____	_____	00.0000323 mA	00.0000323 mA	_____	_____
4	100 mA	100 mA	_____	_____	_____	000.00489 mA	000.00489 mA	_____	_____
5	1 A	1 A	_____	_____	_____	0.0001349 A	0.0001349 A	_____	_____

PERFORMANCE TEST CARD - 1 YEAR LIMITS

Agilent Model 3458A Digital Multimeter

Test Performed By _____

Serial Number _____

Date _____

OHMS TESTS

CAL? 60 _____

TEMP? _____

Difference _____ - (must be less than 5 degrees C)

Perform an ACAL OHMS

Test #	3458A Input	3458A Range	Transfer Standard Reading	Unit Under Test Reading	Difference	Limit (Std)	Limit (Opt 002)	Pass	Fail
<u>TWO WIRE</u>									
1	Short	10 Ω	N/A	_____	N/A	00.25007 Ω	00.25007 Ω	_____	_____
<u>FOUR WIRE</u>									
2	Short	10 Ω	N/A	_____	N/A	00.00007 Ω	00.00007 Ω	_____	_____
3	10 Ω	10 Ω	_____	_____	_____	00.00028 Ω	00.00028 Ω	_____	_____
4	100 Ω	100 Ω	_____	_____	_____	000.00231 Ω	000.00231 Ω	_____	_____
5	1 KΩ	1 KΩ	_____	_____	_____	0.0000142 KΩ	0.0000142 KΩ	_____	_____
6	10 KΩ	10 KΩ	_____	_____	_____	00.000142 KΩ	00.000142 KΩ	_____	_____
7	100 KΩ	100 KΩ	_____	_____	_____	000.00142 KΩ	000.00142 KΩ	_____	_____
8	1 MΩ	1 MΩ	_____	_____	_____	0.0000209 MΩ	0.0000209 MΩ	_____	_____
9	10 MΩ	10 MΩ	_____	_____	_____	00.000703 MΩ	00.000703 MΩ	_____	_____

PERFORMANCE TEST CARD - 1 YEAR LIMITS

Agilent Model 3458A Digital Multimeter

Test Performed By _____

Serial Number _____

Date _____

FREQUENCY TESTS

Test #	3458A Input	3458A Range	Frequency Standard Value	Unit Under Test Reading	Difference	Limit (Std)	Limit (Opt.002)	Pass	Fail
1	1 Hz	N/A	_____	_____	_____	±0.000500 Hz	±0.000500 Hz	_____	_____
2	10 MHz	N/A	_____	_____	_____	±00.00100 MHz	±00.00100 MHz	_____	_____

This section provides an alphabetical summary of commands that are used in calibrating the 3458A (adjustments or performance verification). Detailed command reference pages for each command are also included in this chapter.

- ACAL** **Autocal.** Instructs the multimeter to perform one or all of its automatic calibrations.
- CAL** **Calibration.** Calibrates the internal 7V reference to an external 10V standard (CAL 10) followed by an ACAL DCV. It also calibrates the internal 40 K Ω reference to an external 10 K Ω standard (CAL 10E3) followed by an ACAL OHMS. Offset for the front and rear terminals are also calculated (CAL 0).
- CAL?** **Calibration query.** Returns one of four values for the calibration constant specified; the initial (nominal) value, low limit, high limit, or actual value of the specified constant.
- CALNUM?** **Calibration number query.** Returns a decimal number indicating the number of times the multimeter has be adjusted.
- CALSTR** **Calibration string (remote only).** Stores a string in the multimeter's nonvolatile calibration RAM. Typical uses for this string include the date or place of adjustment/verification, technician's name, or the scheduled date for the next adjustment.
- REV?** **Revision query.** Returns two numbers separated by a comma. The first number is the multimeter's outguard firmware revision. The second number is the inguard firmware revision.
- SCAL** **Service calibration.** Adjusts the AC section of the instrument. Calculates the corrections to accurately measure frequency and calibrates the ac ranges.
- SECURE** **Security code.** Allows the person responsible for calibration to enter a security code to prevent accidental or unauthorized adjustment or autocalibration
- TEMP?** **Temperature query.** Returns the multimeter's internal temperature in degrees Centigrade.
- TEST** **Self-test.** Causes the multimeter to perform a series of internal self-tests. If all constants are within their lower and upper limits, the self-test passes.

ACAL

Description **Autocal.** Instructs the multimeter to perform one or all of its automatic calibrations.

Syntax ACAL [type][,security_code]

type The *type* parameter choices are:

type	Parameter	Numeric Query Equivalent	Description
	ALL	0	Performs the DCV, AC and OHMS autocal
	DCV	1	DC voltage gain and offset (see first Remark)
	AC	2	ACV flatness, gain, and offset (see second Remark)
	OHMS	4	OHMS gain and offset (see third Remark)

security_code When autocal is secured, you must enter the correct security code to perform an autocal (when shipped from the factory, autocal is secured with the security code 3458). When autocal is not secured, no security code is required. Refer to the SECURE command for more information on the security code and how to secure or unsecure autocal.

- Remarks**
- Since the DCV autocal applies to all measurement functions, you should perform it before performing the AC or OHMS autocal. When ACAL ALL is specified, the DCV autocal is performed prior to the other autocal.
 - The AC autocal performs specific enhancements for ACV or ACDCV (all measurement methods), ACI or ACDCI, DSAC, DSDC, SSAC, SSDC, FREQ, and PER measurements.
 - The OHMS autocal performs specific enhancements for 2- or 4-wire ohms, DCI, and ACI measurements.
 - Always disconnect any AC input signals before you perform an autocal. If you leave an input signal connected to the multimeter, it may adversely affect the autocal.
 - The autocal constants are stored in continuous memory (they remain intact when power is removed). You do not need to perform autocal simply because power has been cycled.
 - The approximate time required to perform each autocal routine is:
 - ALL: 14 minutes**
 - DCV: 2 minutes and 20 seconds**
 - AC: 2 minutes and 20 seconds**
 - OHMS: 10 minutes**
 - If power is turned off or the **Reset** button is pushed during an ACAL, an error is generated. You must perform an ACAL ALL to recalculate new calibration constants.
 - **Related Commands:** CAL, SCAL, SECURE

Example OUTPUT 722;"ACAL ALL,3458" IRUNS ALL AUTOCALS, SECURITY
CODE IS 3458! (FACTORY SECURITY CODE SETTING)

CAL

Description **Calibration.** Calibrates the internal 7V reference to an external 10V standard (CAL10) and does the equivalent of ACAL DCV. Also calibrates the internal 40 K reference to an external 10 K standard (CAL 10E3) and does the equivalent of ACAL OHMS. Alternate CAL standard values can be used as described in the first remark. It also calculates the offset for the front and rear terminals (CAL 0).

Syntax CAL value [,security _ code]

value Specifies the value of the adjustment source that will be used to adjust the multimeter. For highest accuracy, 10V and 10 K ohm standards are recommended and the *value* sent must be the exact output value of the adjustment source. If the 10V source actually outputs 10.0001, then specify a value of 10.0001 in the CAL command.

security_code When a security code is set to a number other than 0 by the SECURE command, you must enter the correct security code to perform a CAL. If CAL is not secured (security code = 0), no security code is required to execute CAL. Refer to the SECURE command for more information on the security code and how to secure the calibration of the 3458A.

- Remarks**
- For highest accuracy, the value sent with the CAL command must exactly equal the actual output value of the adjustment source. It is recommended that 10V be used for CAL 10 and 10 K ohms be used for CAL 10E3.
NOTE: Any standard value between 1 V and 12V or 1 K Ω and 12 K Ω can be used. A value less than 10V or less than 10 K Ω will introduce additional uncertainty to the multimeter's accuracy specifications. For example, a 1 V DC standard can be used instead of 10V (you would execute CAL 1.0000). A 1 K Ω standard can be used instead of 10 K Ω (you would execute CAL 1E3). Each case degrades the accuracy specifications of the instrument.
 - For highest accuracy when performing a CAL 0, a four-point short must be used. Also, CAL 0 must be performed twice, once for the front terminals and again for the rear terminals. You must manually switch the terminals to be calibrated using the front panel switch.
 - It is recommended that the OCOMP command be executed prior to adjusting with the 10 K source and OCOMP be set to ON. This will account for any thermals and result in a more accurate adjustment.
 - **Related Commands:** ACAL, SCAL, SECURE

Example OUTPUT 722: "CAL 10.0011" ! DCV ADJUSTMENT SOURCE =
10.0011 VOLTS
OUTPUT 722:"OCOMP ON"
OUTPUT 722:"CAL 10000.001" !RESISTANCE ADJUSTMENT SOURCE
= 10000.001 OHMS

CAL?

Description **Calibration query.** Returns a string containing one of four values for the calibration constant specified; the initial (nominal) value, low limit, high limit, or actual value of the specified constant. The returned string also contains a description of the constant. This command is in the full command menu; it is not in the short command menu.

Syntax **CAL? const_id [,cal_item]**

cal_item Specifies which of the four calibration constant values is to be returned. The *cal_item* parameter choices are:

<i>cal_item</i>	Description
0	Initial (nominal) value
1	Actual value ^a
3	Upper limit
5	Lower limit

a. The default for *cal_item* is the actual value.

const_id Specifies the identifier number for the calibration constant of interest. Each *const_id* and the associated calibration constant description is listed below.

const_id	Description	Constant derived from	
1	40 K Reference	External gain adjustment	
2	7V Reference	External gain adjustment	
3	dcv zero front 100mV	-	
4	dcv zero rear 100mV		
5	dcv zero front 1V		
6	dcv zero rear 1V		
7	dcv zero front 10V		
8	dcv zero rear 10V		
9	dcv zero front 100V		
10	dcv zero rear 100V		
11	dcv zero front 1 KV		
12	dcv zero rear 1 KV		
13	ohm zero front 10		-External zero adjustment
14	ohm zero front 100		
15	ohm zero front 1 K		
16	ohm zero front 10 K		
17	ohm zero front 100 K		
18	ohm zero front 1M		
19	ohm zero front 10M		
20	ohm zero front 100M		
21	ohm zero front 1G		

22	ohm zero rear 10	
23	ohm zero rear 100	
24	ohm zero rear 1 K	
25	ohm zero rear 10 K	
26	ohm zero rear 100 K	
27	ohm zero rear 1M	
28	ohm zero rear 10M	
29	ohm zero rear 100M	
30	ohm zero rear 1G	
31	ohmf zero front 10	
32	ohmf zero front 100	
33	ohmf zero front 1 K	
34	ohmf zero front 10 K	
35	ohmf zero front 100 K	
36	ohmf zero front 1M	
37	ohmf zero front 10M	
38	ohmf zero front 100M	
39	ohmf zero front 1G	
40	ohmf zero rear 10	-External zero adjustment
41	ohmf zero rear 100	
42	ohmf zero rear 1 K	
43	ohmf zero rear 10 K	
44	ohmf zero rear 100 K	
45	ohmf zero rear 1M	
46	ohmf zero rear 10M	
47	ohmf zero rear 100M	
48	ohmf zero rear 1G	
49	offset ohm 10	
50	offset ohm 100	
51	offset ohm 1 K	
52	offset ohm 10 K	
53	offset ohm 100 K	
54	offset ohm 1M	
55	offset ohm 10M	
56	offset ohm 100M	
57	offset ohm 1G	
58	cal 0 temperature	
59	cal 10 temperature	-Internal temperatures at
60	cal 10 K temperature	time of last CAL adjustment
61	vos dac (Dac count to zero boot-strap amp Q7, U12)	-External zero adj
62	dci zero rear 100 nA	
63	dci zero rear 1 μ A	
64	dci zero rear 10 μ A	
65	dci zero rear 100 μ A	-ACAL OHMS
66	dci zero rear 1 mA	

67	dci zero rear 10 mA	-ACAL OHMS
68	dci zero rear 100 mA	
69	dci zero rear 1A	
70	dcv gain 100 mV	-ACAL DCV
71	dcv gain 1V	
72	dcv gain 10V	
73	dcv gain 100V	
74	dcv gain 1 KV	
75	ohm gain 10	-ACAL OHMS
76	ohm gain 100	
77	ohm gain 1 K	
78	ohm gain 10 K	
79	ohm gain 100 K	
80	ohm gain 1M	
81	ohm gain 10M	
82	ohm gain 100M	
83	ohm gain 1G	
84	ohm ocomp gain 10	-ACAL OHMS
85	ohm ocomp gain 100	
86	ohm ocomp gain 1 K	
87	ohm ocomp gain 10 K	
88	ohm ocomp gain 100 K	
89	ohm ocomp gain 1M	
90	ohm ocomp gain 10M	
91	ohm ocomp gain 100M	
92	ohm ocomp gain 1G	
93	dci gain 100 nA	-ACAL OHMS
94	dci gain 1 μ A	
95	dci gain 10 μ A	
96	dci gain 100 μ A	
97	dci gain 1 mA	
98	dci gain 10 mA	
99	dci gain 100 mA	
100	dci gain 1 A	
101	precharge dac	-ACAL OHMS
102	mc dac (Dac settings to minimize charge coupling from input fets)	
103	high speed gain	
104	il (OFF leakage of ohmmeter current source)	
105	il2 (Input leakage correction used on 1M Ω and higher)	
106	rin (Value of 10 M Ω attenuator RP7)	

107	low aperture	}	-ACAL DCV
108	high aperture		
109	high aperture slope .01 PLC		
110	high aperture slope .1 PLC		
111	high aperture null .01 PLC		
112	high aperture null .1 PLC		
113	underload dcv 100 mV	}	-ACAL DCV
114	underload dcv 1V		
115	underload dcv 10V		
116	underload dcv 100V		
117	underload dcv 1000V		
118	overload dcv 100 mV	}	-ACAL DCV
119	overload dcv 1V		
120	overload dcv 10V		
121	overload dcv 100V		
122	overload dcv 1000V		
123	underload ohm 10	}	-ACAL OHMS
124	underload ohm 100		
125	underload ohm 1 K		
126	underload ohm 10 K		
127	underload ohm 100 K		
128	underload ohm 1M		
129	underload ohm 10M		
130	underload ohm 100M		
131	underload ohm 1G		
132	overload ohm 10		
133	overload ohm 100		
134	overload ohm 1 K		
135	overload ohm 10 K		
136	overload ohm 100 K		
137	overload ohm 1M		
138	overload ohm 10M		
139	overload ohm 100M		
140	overload ohm 1G		
141	underload ohm ocomp 10	}	-ACAL OHMS
142	underload ohm ocomp 100		
143	underload ohm ocomp 1 K		
144	underload ohm ocomp 10 K		
145	underload ohm ocomp 100 K		
146	underload ohm ocomp 1M		
147	underload ohm ocomp 10M		
148	underload ohm ocomp 100M		
149	underload ohm ocomp 1G		
150	overload ohm ocomp 10		

151	overload ohm ocomp 100	
152	overload ohm ocomp 1 K	
153	overload ohm ocomp 10 K	
154	overload ohm ocomp 100 K	
155	overload ohm ocomp 1M	
156	overload ohm ocomp 10M	
157	overload ohm ocomp 100M	
158	overload ohm ocomp 1G	
159	underload dci 100 nA	
160	underload dci 1 μ A	
161	underload dci 10 μ A	
162	underload dci 100 μ A	-ACAL OHMS
163	underload dci 1 mA	
164	underload dci 10 mA	
165	underload dci 100 mA	
166	underload dci 1A	
167	overload dci 100 nA	
168	overload dci 1 μ A	
169	overload dci 10 μ A	
170	overload dci 100 μ A	
171	overload dci 1 mA	
172	overload dci 10 mA	
173	overload dci 100 mA	
174	overload dci 1A	
175	acal dcv temperature	
176	acal ohm temperature	-Last ACAL temperatures
177	acal acv temperature	
178	ac offset dac 10 mV	
179	ac offset dac 100 mV	
180	ac offset dac 1V	
181	ac offset dac 10V	
182	ac offset dac 100V	
183	ac offset dac 1 KV	
184	acdc offset dac 10 mV	
185	acdc offset dac 100 mV	
186	acdc offset dac 1V	
187	acdc offset dac 10V	
188	acdc offset dac 100V	
189	acdc offset dac 1 KV	
190	acdc offset dac 100 μ A	-ACAL AC
191	acdc offset dac 1 mA	
192	acdc offset dac 10 mA	
193	acdc offset dac 100 mA	
194	acdc offset dac 1A	
195	flatness dac 10 mV	

196	flatness dac 100 mV	
197	flatness dac 1V	
198	flatness dac 10V	
199	flatness dac 100V	
200	flatness dac 1 KV	
201	level dac dc 1.2V	
202	level dac dc 12V	
203	level dac ac 1.2V	
204	level dac dc 12V	
205	dcv trigger offset 100 mV	
206	dcv trigger offset 1V	
207	dcv trigger offset 10V	
208	dcv trigger offset 100V	
209	dcv trigger offset 1000V	
210	acdcv sync offset 10 mV	
211	acdcv sync offset 100 mV	
212	acdcv sync offset 1V	
213	acdcv sync offset 10V	
214	acdcv sync offset 100V	
215	acdcv sync offset 1KV	
216	acv sync offset 10 mV	
217	acv sync offset 100 mV	
218	acv sync offset 1V	
219	acv sync offset 10V	
220	acv sync offset 100V	
221	acv sync offset 1 KV	
222	acv sync gain 10 mV	
223	acv sync gain 100 mV	
224	acv sync gain 1V	
225	acv sync gain 10V	
226	acv sync gain 100V	
227	acv sync gain 1 KV	-ACAL AC
228	ab ratio	
229	gain ratio	
230	acv ana gain 10 mV	
231	acv ana gain 100 mV	
232	acv ana gain 1V	
233	acv ana gain 10V	
234	acv ana gain 100V	
235	acv ana gain 1 KV	
236	acv ana offset 10 mV	
237	acv ana offset 100 mV	
238	acv ana offset 1V	
239	acv ana offset 10V	
240	acv ana offset 100V	

241	acv ana offset 1 KV	}
242	rmsdc ratio	
243	sampdc ratio	
244	aci gain	-SCAL
245	freq gain	
246	attenuator high frequency dac	
247	amplifier high frequency dac 10 mV	
248	amplifier high frequency dac 100 mV	
249	amplifier high frequency dac 1V	
250	amplifier high frequency dac 10V	
251	amplifier high frequency dac 100V	
252	amplifier high frequency dac 1 KV	
253	interpolator	

Remarks **Related Commands:** ACAL, CAL, SCAL

Example The following two program examples query the calibration constants. The first program returns an individual response while the second program lists all 253 calibration constants. The parameter "T" in each program specifies the *cal_item* which calls for the initial value, lower limit, upper limit, or actual value.

Return an individual calibration constant (#2).

```

10  PRINTER IS 701
20  DIM A$ [100]
30  T=3                               !Specifies the cal_item
40  PRINT "Cal item=", T
50  OUTPUT 722;"QFORMAT ALPHA"       !Enables alpha/numeric query response
60  OUTPUT 722;"CAL? 2", T          !Queries constant #2
70  ENTER 722;A$
80  PRINT A$
90  END

```

Return the entire set of calibration constants.

```

10  PRINTER IS 701
20  DIM A$ [100]
30  T=3                               !Specifies the cal_item
40  FOR N=1 TO 253
50  PRINT "Cal item=", T

```

```
60 PRINT "CONST =", N
70 OUTPUT 722;"QFORMAT ALPHA"
80 OUTPUT 722;"CAL?";N,T
90 ENTER 722; A$
100 PRINT A$
110 NEXT N
120 END
```

CALNUM?

Description Calibration Number Query. Returns a decimal number indicating the number of times the multimeter has been adjusted.

Syntax CALNUM?

- Remarks**
- The calibration number is incremented by 1 whenever the multimeter is unsecured and adjusted. If autocal is secured, the calibration number is also incremented by 1 whenever an autocal is performed; if unsecured, autocal does not affect the calibration number.
 - The calibration number is stored in cal-protected memory and is not lost when power is removed.
 - The multimeter was adjusted before it left the factory which increments the CALNUM. When you receive the multimeter, read the calibration number to determine its initial value.
 - **Related Commands:** CAL. CALSTR. SCAL

Example

```
10 OUTPUT 722;"CALNUM?" !READS CALIBRATION NUMBER
20 ENTER 722;A           !ENTERS RESPONSE INTO COMPUTER
30 PRINT A               !PRINTS RESPONSE
40 END
```

CALSTR

Description Calibration String (remote only). Stores a string in the multimeter's nonvolatile calibration RAM. Typical uses for this string include the date or place of calibration, technician's name, last CALNUM value, or the scheduled date for the next calibration.

Syntax CALSTR string[,security_code]

string This is the alpha/numeric message that will be appended to the calibration RAM. The *string* parameter must be enclosed in single or double quotes. The maximum string length is 75 characters (the quotes enclosing the string are not counted as characters).

security_code When the calibration RAM is secured (SECURE command) you must include the *security_code* in order to write a message to the calibration RAM. (You can always read the string using the CALSTR? command regardless of the security mode). Refer to the SECURE command for information on securing and unsecuring the calibration RAM.

Remarks

- **Query Command.** The CALSTR? query command returns the character string from the multimeter's calibration RAM. This is shown in the second example below.
- **Related Commands:** CAL, CALNUM?, SCAL, SECURE

Examples CALSTR

OUTPUT 722; "CALSTR 'CALIBRATED 04/02/1987; temp(C)=43.1'"

CALSTR?

```
10 DIM A$[80]                !DIMENSION STRING VARIABLE
20 OUTPUT 722; "CALSTR?"     !READ THE STRING
30 ENTER 722;A$              !ENTER STRING
40 PRINT A$                  !PRINT STRING
50 END
```

REV?

Description **Revision Query.** Returns two numbers separated by a comma. The first number is the multimeter's outguard firmware revision. The second number is the inguard firmware revision.

Syntax **REV?**

Example

```
10 OUTPUT 722; "REV?" !READ FIRMWARE REVISION NUMBERS
20 ENTER 722; A,B      !ENTER NUMBERS
30 PRINT A,B           !PRINT NUMBERS
40 END
```

SCAL

Description **Service Calibration.** Adjusts the AC sections of the instrument. Calculates the corrections to accurately measure frequency and adjusts the ac ranges. The SCAL command is located in the full command menu.

Note The SCAL command is used in the AC adjustment procedure of Chapter 3 and the procedure must be performed in the order specified.

Syntax SCAL *value* [,*security_code*]

value Specifies the value of the adjustment source that will be used to do the service adjustment of the multimeter. Valid choices for *value* are 1E5, 10, 1, and 0.1. 1E5 performs a frequency calibration while 10, 1, and 0.1 do ac range adjustment.

security_code When a security code is set to a number other than 0 by the SECURE command, you must enter the correct security code to perform an SCAL. If SCAL is not secured (security code = 0), no security code is required to execute SCAL. Refer to the SECURE command for more information on the security code and how to secure the adjustment of the 3458A.

- Remarks**
- The SCAL command is in the full menu; it is not in the short menu.
 - With a 100 KHz input, SCAL 1E5 calculates the constants allowing the multimeter to indicate 100 KHz.
 - SCAL 10, SCAL 1, and SCAL 0.1 do ac range calibration calculating high frequency dac and interpolator constants.
 - For fastest calibration with SCAL, the multimeter can be left in the DCV function.
 - **Related Commands:** ACAL, CAL, SECURE

Example

```
OUTPUT 722;"SCAL 1E5"           !Adjusts for frequency
OUTPUT 722;"SCAL 10"           !Adjusts range
OUTPUT 722;"SCAL 1"
OUTPUT 722;"SCAL 0.1"
```

SECURE

Description **Security Code.** Allows the person responsible for adjustment to enter a security code to prevent accidental or unauthorized adjustment or autocalibration (autocal).

Syntax `SECURE old_code, new_code [,acal_secure]`

old_code This is the multimeter's previous security code. The multimeter is shipped from the factory with its security code set to 3458.

new_code This is the new security code. The code is an integer from -2.1E-9 to 2.1E9. If the number specified is not an integer, the multimeter rounds it to an integer value.

acal_secure Allows you to secure autocalibration. The choices are:

acal_secure Parameter	Numeric Query Equivalent	Description
OFF	0	Disables autocal security; no code required for autocal
ON	1	Enables autocal security; the security code is required to perform autocal (see ACAL for example).

Power-on acal_secure = Previously specified value (OFF is the factory setting).

Default acal_secure = OFF.

- Remarks**
- Specifying 0 for the *new_code* disables the security feature making it no longer necessary to enter the security code to perform an adjustment or autocal.
 - The front panel's **Last Entry** key will not display the codes used in a previously executed SECURE command.
 - In the event that the secure code is lost or unknown by the user, a procedure is presented in Chapter 1 (section titled "Changing the Security Code") that allows for unsecuring the instrument after removal of the top cover.
 - **Related Commands:** ACAL. CAL. CALNUM?. CALSTR. SCAL

Examples **Changing the Code**

```
OUTPUT 722;"SECURE 3458,4448,ON" !CHANGE FACTORY SECURITY  
CODE TO 4448, !ENABLE AUTOCAL SECURITY
```

Disabling Security

```
OUTPUT 722;"SECURE 3458,0" !DISABLES SECURITY FOR  
ADJUSTMENT AND AUTOCAL
```

TEMP?

Description **Temperature Query.** Returns the multimeter's internal temperature in degrees Centigrade.

Syntax TEMP?

- Remarks**
- Monitoring the multimeter's temperature is helpful to determine when to perform autocalibration.
 - **Related Commands:** ACAL, CAL, CALSTR

Example

```
10 OUTPUT 722; "TEMP?"           !READ TEMPERATURE
20 ENTER 722; A                   !ENTER RESULT
30 PRINT A                         !PRINT RESULT
40 END
```

TEST

Description Causes the multimeter to perform a series of internal self-test.

Syntax TEST

- Remarks**
- Always disconnect any input signals before you run self-test. If you leave an input signal connected to the multimeter, it may cause a self-test failure.
 - If a hardware error is detected, the multimeter sets bit 0 in the error register and a more descriptive bit in the auxiliary error register. The display's **ERR** annunciator illuminates whenever an error register bit is set. You can access the error registers using ERRSTR? (both registers'), ERR? (error register only) or AUXERR? (auxiliary error register only).
 - **NOTE:** The internal self-test checks all calibration constants and verifies they are within the lower and upper limits.
 - **Related Commands:** AUXERR?, ERR?, ERRSTR?

Example OUTPUT 722;"TEST" !RUNS SELF-TEST

Introduction

The 3458A accuracy is specified as a part per million (ppm) of the reading plus a ppm of range for dcV, Ohms, and dcl. In acV and acl, the specification is percent of reading plus percent of range. Range means the name of the scale, e.g. 1 V, 10 V, etc.; range does not mean the full scale reading, e.g. 1.2 V, 12 V, etc. These accuracies are valid for a specific time from the last calibration.

Absolute versus Relative Accuracy

All 3458A accuracy specifications are relative to the calibration standards. Absolute accuracy of the 3458A is determined by adding these relative accuracies to the traceability of your calibration standard. For dcV, 2 ppm is the traceability error from the Agilent factory. That means that the absolute error relative to the U.S. National Institute of Standards and Technology (NIST) is 2 ppm in addition to the dcV accuracy specifications. When you recalibrate the 3458A, your actual traceability error will depend upon the errors from your calibration standards. These errors will likely be different from the Agilent error of 2 ppm.

Example 1: Relative Accuracy; 24 Hour Operating temperature is Tcal ± 1°C

Assume that the ambient temperature for the measurement is within ± 1°C of the temperature of calibration (Tcal). The 24 hour accuracy specification for a 10 V dc measurement on the 10 V range is 0.5 ppm ± 0.05 ppm. That accuracy specification means:

$$0.5 \text{ ppm of Reading} + 0.05 \text{ ppm of Range}$$

For relative accuracy, the error associated with the measurement is:

$$(0.5/1,000,000 \times 10 \text{ V}) + (0.05/1,000,000 \times 10 \text{ V}) = \pm 5.5 \mu\text{V or } 0.55 \text{ ppm of } 10 \text{ V}$$

Errors from temperature changes

The optimum technical specifications of the 3458A are based on auto-calibration (ACAL) of the instrument within the previous 24 hours and following ambient temperature changes of less than ±1°C. The 3458A's ACAL capability corrects for measurement errors resulting from the drift of critical components from time and temperature.

The following examples illustrate the error correction of auto-calibration by computing the relative measurement error of the 3458A for various temperature conditions. Constant conditions for each example are:

10 V DC input
10 V DC range
Tcal = 23°C

90 day accuracy specifications

Example 2: Operating temperature is 28°C;

With ACAL

This example shows basic accuracy of the 3458A using auto-calibration with an operating temperature of 28°C. Results are rounded to 2 digits.

$$(4.1 \text{ ppm} \times 10 \text{ V}) + (0.05 \text{ ppm} \times 10 \text{ V}) = 42 \mu\text{V}$$

$$\text{Total relative error} = 42 \mu\text{V}$$

Example 3: Operating temperature is 38°C;

Without ACAL

The operating temperature of the 3458A is 38°C, 14°C beyond the range of Tcal ±1°C. Additional measurement errors result because of the added temperature coefficient without using ACAL.

$$(4.1 \text{ ppm} \times 10 \text{ V}) + (0.05 \text{ ppm} \times 10 \text{ V}) = 42 \mu\text{V}$$

Temperature Coefficient (specification is per °C):

$$(0.5 \text{ ppm} \times 10 \text{ V} + 0.01 \text{ ppm} \times 10 \text{ V}) \times 14^\circ\text{C} = 71 \mu\text{V}$$

$$\text{Total error} = 113 \mu\text{V}$$

Example 4: Operating temperature is 38°C;

With ACAL

Assuming the same conditions as Example 3, but using ACAL significantly reduces the error due to temperature difference from calibration temperature. Operating temperature is 10°C beyond the standard range of Tcal ±5°C.

$$(4.1 \text{ ppm} \times 10 \text{ V}) + (0.05 \text{ ppm} \times 10 \text{ V}) = 42 \mu\text{V}$$

Temperature Coefficient (specification is per °C):

$$(0.15 \text{ ppm} \times 10 \text{ V} + 0.01 \text{ ppm} \times 10 \text{ V}) \times 10^\circ\text{C} = 16 \mu\text{V}$$

$$\text{Total error} = 58 \mu\text{V}$$

Example 5: Absolute Accuracy; 90 Day

Assuming the same conditions as Example 4, but now add the traceability error to establish absolute accuracy.

$$(4.1 \text{ ppm} \times 10 \text{ V}) + (0.05 \text{ ppm} \times 10 \text{ V}) = 42 \mu\text{V}$$

Temperature Coefficient (specification is per °C):

$$(0.15 \text{ ppm} \times 10 \text{ V} + 0.01 \text{ ppm} \times 10 \text{ V}) \times 10^\circ\text{C} = 16 \mu\text{V}$$

Agilent factory traceability error of 2 ppm:

$$(2 \text{ ppm} \times 10 \text{ V}) = 20 \mu\text{V}$$

$$\text{Total absolute error} = 78 \mu\text{V}$$

Additional errors

When the 3458A is operated at power line cycles below 100, additional errors due to noise and gain become significant. Example 6 illustrates the error correction at 0.1 PLC.

Example 6: operating temperature is 28°C; 0.1 PLC

Assuming the same conditions as Example 2, but now add additional error.

$$(4.1 \text{ ppm} \times 10 \text{ V}) + (0.05 \text{ ppm} \times 10 \text{ V}) = 42 \mu\text{V}$$

Referring to the Additional Errors chart and RMS Noise Multiplier table, additional error at 0.1 PLC is:

$$(2 \text{ ppm} \times 10 \text{ V}) + (0.4 \text{ ppm} \times 1 \times 3 \times 10 \text{ V}) = 32 \mu\text{V}$$

$$\text{Total relative error} = 74 \mu\text{V}$$

1 / DC Voltage

DC Voltage

Range	Full Scale	Maximum Resolution	Input Impedance	Temperature Coefficient (ppm of Reading + ppm of Range) / ° C	
				Without ACAL ¹	With ACAL ²
100 mV	120.00000	10 nV	>10 GΩ	1.2 + 1	0.15 + 1
1 V	1.20000000	10 nV	>10 GΩ	1.2 + 0.1	0.15 + 0.1
10 V	12.0000000	100 nV	>10 GΩ	0.5 + 0.01	0.15 + 0.01
100 V	120.000000	1 μV	10 MΩ ± 1%	2 + 0.4	0.15 + 0.1
1000 V	1050.00000	10 μV	10 MΩ ± 1%	2 + 0.04	0.15 + 0.01

Accuracy³ (ppm of Reading (ppm of Reading for Option 002) + ppm of Range)

Range	24 Hour ⁴	90 Day ⁵	1 Year ⁵	2 Year ⁵
100 mV	2.5 + 3	5.0 (3.5)+ 3	9 (5)+ 3	14 (10)+ 3
1 V	1.5 + 0.3	4.6 (3.1)+0.3	8 (4)+ 0.3	14 (10)+0.3
10 V	0.5 + 0.05	4.1 (2.6) + 0.05	8 (4) + 0.05	14 (10)+0.05
100 V	2.5 + 0.3	6.0 (4.5) + 0.3	10 (6)+0.3	14 (10)+ 0.3
1000 V ⁶	2.5 + 0.1	6.0 (4.5)+ 0.1	10 (6)+ 0.1	14 (10)+ 0.1

Transfer Accuracy/Linearity

Range	10 Min, Tref ± 0.5°C (ppm of Reading + ppm of Range)	Conditions
100 mV	0.5 + 0.5	<ul style="list-style-type: none"> Following 4 hour warm-up. Full scale to 10% of full scale Measurements on the 1000 V range are within 5% of the initial measurement value and following measurement setting. Tref is the starting ambient temperature. Measurements are made on a fixed range (>4 min.) using accepted metrology practices
1 V	0.3 + 0.1	
10 V	0.05 + 0.05	
100 V	0.5 + 0.1	
1000 V	1.5+0.05	

Settling Characteristics

For first reading or range change error, add 0.0001% of input voltage step additional error. Reading settling times are affected by source impedance and cable dielectric absorption characteristics.

Additional Errors

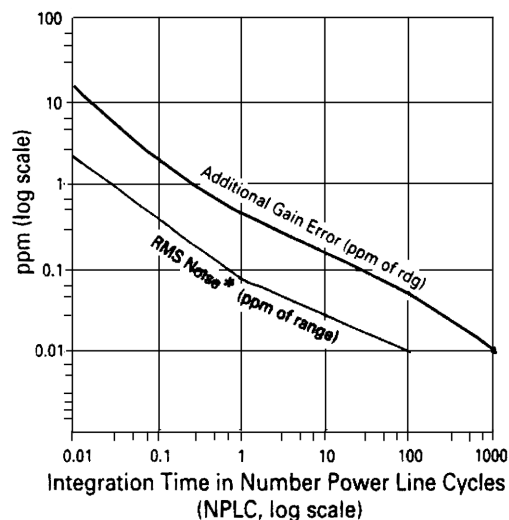

Noise Rejection (dB)⁷

	AC NMR ⁸	AC ECMR	DC ECMR
NPLC < 1	0	90	140
NPLC > 1	60	150	140
NPLC > 10	60	150	140
NPLC > 100	60	160	140
NPLC = 1000	75	170	140

*RMS Noise

Range	Multiplier
0.1 V	x20
1 V	x2
10 V	x1
100 V	x2
1000 V	x1

For RMS noise error, multiply RMS noise result from graph by multiplier in chart. For peak noise error, multiply RMS noise error by 3.

1. Additional error from Tcal or last ACAL ± 1 ° C.
2. Additional error from Tcal ± 5° C
3. Specifications are for PRESET, NPLC 100.
4. For fixed range (> 4 min.), MATH NULL and Tcal ± 1°C.
5. Specifications for 90 day, 1 year and 2 year are within 24 hours and ±1° C of last ACAL; Tcal ± 5°C, MATH NULL and fixed range.

ppm of Reading specifications for High Stability (Option 002) are in parentheses.

Without MATH NULL, add 0.15 ppm of Range to 10 V, 0.7 ppm of Range to 1 V, and 7 ppm of Range to 0.1 V. Without math null and for fixed range less than 4 minutes, add 0.25 ppm of Range to 10 V, 1.7 ppm of Range to 1 V and 17 ppm of Range to 0.1 V.

Add 2 ppm of reading additional error for Agilent factory traceability to US NIST. Traceability error is the absolute error relative to National Standards associated with the source of last external calibration.

6. Add 12 ppm X (Vin/1000)² additional error for inputs > 100 V.

7. Applies for 1 kΩ unbalance in the LO lead and ± 0.1% of the line frequency currently set for LFREQ.

8. For line frequency ± 1%, ACNMR is 40 dB for NPLC ≥ 1, or 55 dB for NPLC ≥ 100. For line frequency ± 5%, ACNMR is 30 dB for NPLC ≥ 100.

Reading Rate (Auto-Zero Off)

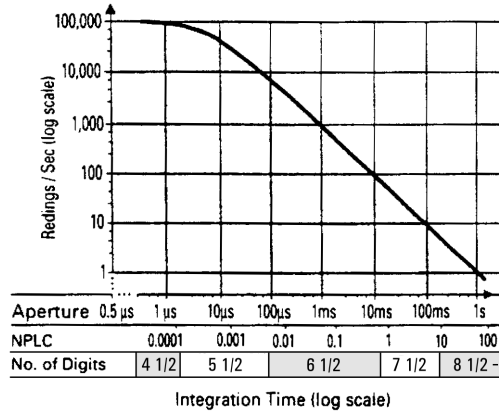

Temperature Coefficient (Auto-Zero off)

For a stable environment $\pm 1^\circ\text{C}$ add the following additional error for AZERO OFF

Range	Error
100 mV–10 V	5 $\mu\text{V}/^\circ\text{C}$
100 V–1000 V	500 $\mu\text{V}/^\circ\text{C}$

Selected Reading Rates ¹

NPLC	Aperture	Digits	Bits	Readings / Sec	
				A-Zero Off	A-Zero On
0.0001	1.4 μs	4.5	16	100,000 ³	4,130
0.0006	10 μs	5.5	18	50,000	3,150
0.01	167 μs^2	6.5	21	5,300	930
0.1	1.67 ms^2	6.5	21	592	245
1	16.6 ms^2	7.5	25	60	29.4
10	0.166 s^2	8.5	28	6	3
100		8.5	28	36/min	18/min
1000		8.5	28	3.6/min	1.8/min

- For PRESET; DELAY 0; DISP OFF; OFORMAT DINT; ARANGE OFF.
- Aperture is selected independent of line frequency (LFREQ). These apertures are for 60 Hz NPLC values where 1 NPLC = 1/LFREQ. For 50 Hz and NPLC indicated, aperture will increase by 1.2 and reading rates will decrease by 0.833
- For OFORMAT SINT

Maximum Input

	Rated Input	Non-Destructive
HI to LO	± 1000 V pk	± 1200 V pk
LO to Guard ⁴	± 200 V pk	± 350 V pk
Guard to Earth ⁵	± 500 V pk	± 1000 V pk

Input Terminals

Terminal Material: Gold-plated Tellurium Copper
Input Leakage Current: <20pA at 25°C

- $> 10^{10} \Omega$ LO to Guard with guard open.
- $> 10^{12} \Omega$ Guard to Earth.

2 / Resistance

Two-wire and Four-wire Ohms (OHM and OHMF Functions)

Range	Full Scale	Maximum Resolution	Current Source ⁶	Test Voltage	Open Circuit	Maximum Lead Resistance (OHMF)	Maximum Series Offset (OCOMP ON)	Temperature Coefficient (ppm of Reading + ppm of Range) / °C	
								Without ACAL ⁷	With ACAL ⁸
10 Ω	12.00000	10 $\mu\Omega$	10 mA	0.1 V	12 V	20 Ω	0.01 V	3+1	1+1
100 Ω	120.00000	10 $\mu\Omega$	1 mA	0.1 V	12 V	200 Ω	0.01 V	3+1	1+1
1 k Ω	1.2000000	100 $\mu\Omega$	1 mA	1.0 V	12 V	150 Ω	0.1 V	3+0.1	1+0.1
10 k Ω	12.000000	1 m Ω	100 μA	1.0 V	12 V	1.5 k Ω	0.1 V	3+0.1	1+0.1
100 k Ω	120.00000	10 m Ω	50 μA	5.0 V	12 V	1.5 k Ω	0.5 V	3+0.1	1+0.1
1 M Ω	1.2000000	100 m Ω	5 μA	5.0 V	12 V	1.5 k Ω		3+1	1+1
10 M Ω	12.000000	1 Ω	500 nA	5.0 V	12 V	1.5 k Ω		20+20	5+2
100 M Ω ⁹	120.00000	10 Ω	500 nA	5.0 V	5 V	1.5 k Ω		100+20	25+2
1 G Ω ⁷	1.2000000	100 Ω	500 nA	5.0 V	5 V	1.5 k Ω		1000+20	250+2

- Current source is $\pm 3\%$ absolute accuracy.
- Additional error from Tcal or last ACAL $\pm 1^\circ\text{C}$.
- Additional error from Tcal $\pm 5^\circ\text{C}$.
- Measurement is computed from 10 M Ω in parallel with input

2 Accuracy¹ (ppm of Reading + ppm of Range)

Range	24 Hour ²	90 Day ³	1 Year ³	2 Year ³
10 Ω	5+3	15+5	15+5	20+10
100 Ω	3+3	10+5	12+5	20+10
1 kΩ	2+0.2	8+0.5	10+0.5	15+1
10 kΩ	2+0.2	8+0.5	10+0.5	15+1
100 kΩ	2+0.2	8+0.5	10+0.5	15+1
1 MΩ	10+1	12+2	15+2	20+4
10 MΩ	50+5	50+10	50+10	75+10
100 MΩ	500+10	500+10	500+10	0.1%+10
1 GΩ	0.5%+10	0.5%+10	0.5%+10	1%+10

- Specifications are for PRESET; NPLC 100; OCOMP ON; OHMF.
- Tcal ± 1°C.
- Specifications for 90 day, 1 year, and 2 year are within 24 hours and ± 1°C of last ACAL; Tcal ± 5°C. Add 3 ppm of reading additional error for Agilent factory traceability of 10 KΩ to US NIST. Traceability is the absolute error relative to National Standards associated with the source of last external calibration.

Two-Wire Ohms Accuracy

For Two-Wire Ohms (OHM) accuracy, add the following offset errors to the Four-Wire Ohms (OHMF) accuracy. 24 Hour: 50 mΩ. 90 Day: 150 mΩ. 1 Year: 250 mΩ. 2 Year: 500 mΩ

Additional Errors

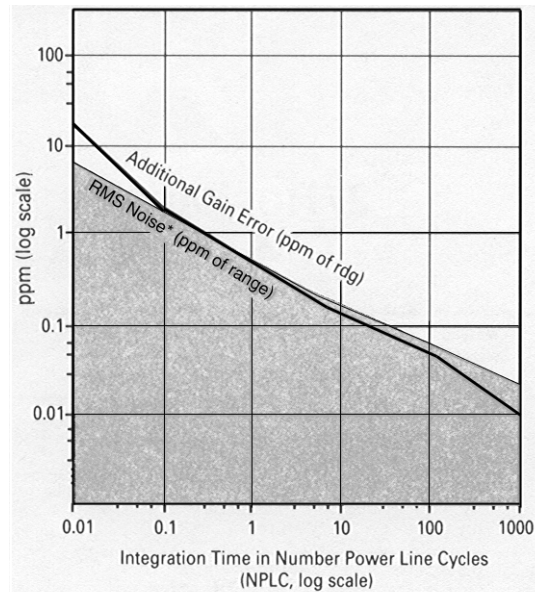

*RMS Noise

Range	Multiplier
10 Ω & 100 Ω	×10
1k Ω to 100 kΩ	×1
1 MΩ	×1.5
10 MΩ	×2
100 MΩ	×120
1 GΩ	×1200

For RMS noise error, multiply RMS noise result from graph by multiplier in chart. For peak noise error, multiply RMS noise error by 3.

Settling Characteristics

For first reading error following range change, add the total 90 day measurement error for the current range. Preprogrammed settling delay times are for < 200 pF external circuit capacitance.

Selected Reading Rates⁴

NPLC ⁵	Aperture	Digits	Readings/Sec	
			Auto-Zero Off	Auto-Zero On
0.0001	1.4 μs	4.5	100,000 ⁷	4,130
0.0006	10 μs	5.5	50,000	3,150
0.01	167 μs ⁶	6.5	5,300	930
0.1	1.66 ms ⁶	6.5	592	245
1	16.6 ms ⁶	7.5	60	29.4
10	0.166 s ⁶	7.5	6	3
100		7.5	36 /min	18/min

Measurement Consideration

Agilent recommends the use of Teflon* cable or other high impedance, low dielectric absorption cable for these measurements.

Maximum Input

	Rated Input	Non-Destructive
HI to LO	± 1000 V pk	± 1000 V pk
HI & LO Sense to LO	± 200 V pk	± 350 V pk
LO to Guard	± 200 V pk	± 350 V pk
Guard to Earth	± 500 V pk	± 1000 V pk

Temperature Coefficient (Auto-Zero off)

For a stable environment ± 1°C add the following error for AZERO OFF. (ppm of Range) /°C

Range	Error	Range	Error
10 Ω	50	1 MΩ	1
100 Ω	50	10 MΩ	1
1 kΩ	5	100 MΩ	10
10 kΩ	5	1 GΩ	100
100 kΩ	1		

- For PRESET; DELAY 0; DISP OFF; OFORMAT DINT; ARANGE OFF. For OHMF or OCOMP ON, the maximum reading rates will be slower.
- Ohms measurements at rates < NPLC 1 are subject to potential noise pickup. Care must be taken to provide adequate shielding and guarding to maintain measurement accuracies.
- Aperture is selected independent of line frequency (LFREQ). These apertures are for 60 Hz NPLC values where 1 NPLC=1/ LFREQ. For 50 Hz and NPLC indicated, aperture will increase by 1.2 and reading rates will decrease by 0.833.
- For OFORMAT SINT
*Teflon is a registered trademark of E. I. duPont deNemours and Co.

3 / DC Current

DC Current (DCI Function)

Range	Full Scale	Maximum Resolution	Shunt Resistance	Burden Voltage	Temperature Coefficient (ppm of Reading + ppm of Range) / °C	
					Without ACAL ¹	With ACAL ²
					100 nA	120.000
1 μA	1.200000	1 pA	45.2 kΩ	0.045 V	2+20	2+5
10 μA	12.000000	1 pA	5.2 kΩ	0.055 V	10+4	2+1
100 μA	120.00000	10 pA	730 Ω	0.075 V	10+3	2+1
1 mA	1.2000000	100 pA	100 Ω	0.100 V	10+2	2+1
10 mA	12.000000	1 nA	10 Ω	0.100 V	10+2	2+1
100 mA	120.00000	10 nA	1 Ω	0.250 V	25+2	2+1
1 A	1.0500000	100 nA	0.1 Ω	<1.5 V	25+3	2+2

Accuracy³ (ppm Reading + ppm Range)

Range	24 Hour ⁴	90 Day ⁵	1 Year ⁵	2 Year ⁵
100 nA ⁶	10+400	30+400	30+400	35+400
1 μA ⁶	10+40	15+40	20+40	25+40
10 μA ₆	10+7	15+10	20+10	25+10
100 μA	10+6	15+8	20+8	25+8
1 mA	10+4	15+5	20+5	25+5
10 mA	10+4	15+5	20+5	25+5
100 mA	25+4	30+5	35+5	40+5
1 A	100+10	100+10	110+10	115+10

Settling Characteristics

For first reading or range change error, add .001% of input current step additional error. Reading settling times can be affected by source impedance and cable dielectric absorption characteristics.

Additional Errors

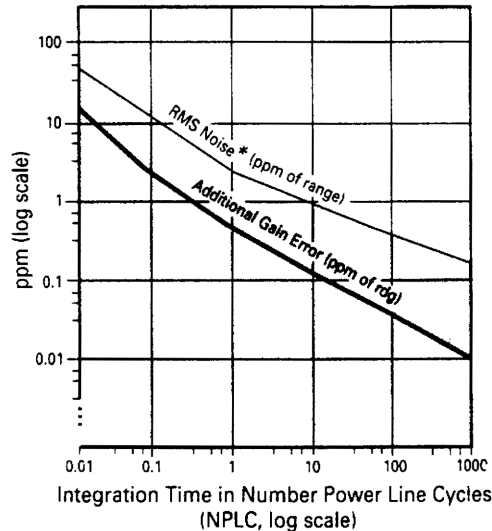

*RMS Noise		For RMS noise error, multiply RMS noise result from graph by multiplier in chart. For peak noise error, multiply RMS noise error by 3.
Range	Multiplier	
100 nA	×100	
1 μA	×10	
10 μA to 1A	×1	

Measurement Considerations

Agilent recommends the use of Teflon cable or other high impedance, low dielectric absorption cable for low current measurements. Current measurements at rates <NPLC 1 are subject to potential noise pickup. Care must be taken to provide adequate shielding and guarding to maintain measurement accuracies

Selected Reading Rates⁷

NPLC	Aperture	Digits	Readings / Sec
0.0001	1.4 μs	4.5	2,300
0.0006	10 μs	5.5	1,350
0.01	167 μs ⁸	6.5	157
0.1	1.67 ms ⁸	6.5	108
1	16.6 ms ⁸	7.5	26
10	0.166 s ⁸	7.5	3
100		7.5	18/min

Maximum Input

	Rated Input	Non-Destructive
I to LO	±1.5 A pk	<1.25 A rms
LO to Guard	±200 V pk	±350 V pk
Guard to Earth	±500 V pk	±1000 V pk

1. Additional error from Tcal or last ACAL±1°C.
2. Additional error from Tcal± 5°C.
3. Specifications are for PRESET; NPLC 100.
4. Tcal± 1°C.
5. Specifications for 90 day, 1 year, and 2 year are within 24 hours and ±1°C of last ACAL; Tcal±5°C
Add 5 ppm of reading additional error for Agilent factory traceability to US NIST. Traceability error is the sum of the 10 V and 10 kΩ traceability values.
6. Typical accuracy.

7. For PRESET; DELAY 0; DISP OFF; OFORMAT DINT; ARANGE OFF.
8. Aperture is selected independent of line frequency (LFREQ). These apertures are for 60 Hz NPLC values where 1 NPLC = 1/ LFREQ. For 50 Hz and NPLC Indicated, aperture will increase by 1.2 and reading rates will decrease by 0.833.

4 / AC Voltage

General Information

The 3458A supports three techniques for measuring true rms AC voltage, each offering unique capabilities. The desired measurement technique is selected through the SETACV command. The ACV functions will then apply the chosen method for subsequent measurements.

The following section provides a brief description of the three operation modes along with a summary table helpful in choosing the technique best suited to your specific measurement need.

SETACV SYNC Synchronously Sub-sampled Computed true rms technique.

This technique provides excellent linearity and the most accurate measurement results. It does require that the input signal be repetitive (not random noise, for example). The bandwidth in this mode is from 1 Hz to 10 MHz.

SETACV ANA Analog Computing true rms conversion technique.

This is the measurement technique at power-up or following an instrument reset. This mode works well with any signal within its 10 Hz to 2 MHz bandwidth and provides the fastest measurement speeds.

SETACV RNDM Random Sampled Computed true rms technique.

This technique again provides excellent linearity; however, the overall accuracy is the lowest of the three modes. It does not require a repetitive input signal and is, therefore, well suited to wideband noise measurements. The bandwidth in this mode is from 20 Hz to 10 MHz.

Selection Table

Technique	Frequency Range	Best Accuracy	Repetitive Signal Required	Readings /Sec	
				Minimum	Maximum
Synchronous Sub-sampled	1 Hz – 10 MHz	0.010%	Yes	0.025	10
Analog	10 Hz – 2 MHz	0.03%	No	0.8	50
Random Sampled	20 Hz – 10 MHz	0.1%	No	0.025	45

Synchronous Sub-sampled Mode (ACV Function, SETACV SYNC)

Range	Full Scale	Maximum Resolution	Input Impedance	Temperature Coefficient ¹ (% of Reading + % of Range) /°C
10 mV	12.00000	10 nV	1 MΩ±15% with <140pF	0.003 + 0.02
100 mV	120.00000	10 nV	1 MΩ±15% with <140pF	0.0025 + 0.0001 ²
1 V	1.2000000	100 nV	1 MΩ±15% with <140pF	0.0025 + 0.0001
10 V	12.000000	1 μV	1 MΩ±2% with <140pF	0.0025 + 0.0001
100 V	120.00000	10 μV	1 MΩ±2% with <140pF	0.0025 + 0.0001
1000 V	700.0000	100 μV	1 MΩ±2% with <140pF	0.0025 + 0.0001

AC Accuracy²

24 Hour to 2 Year (% of Reading + % of Range)

Range	ACBAND ≤ 2 MHz							
	1 Hz to ³ 40 Hz	40 Hz to ³ 1 kHz	1 kHz to ³ 20 kHz	20 kHz to ³ 50 kHz	50 kHz to 100 kHz	100 kHz to 300 kHz	300 kHz to 1 MHz	1 MHz to 2 MHz
10 mV	0.03 + 0.03	0.02 + 0.011	0.03 + 0.011	0.1 + 0.011	0.5 + 0.011	4.0 + 0.02		
100 mV–10 V	0.007 + 0.004	0.007 + 0.002	0.014 + 0.002	0.03 + 0.002	0.08 + 0.002	0.3 + 0.01	1 + 0.01	1.5 + 0.01
100 V	0.02 + 0.004	0.02 + 0.002	0.02 + 0.002	0.035 + 0.002	0.12 + 0.002	0.4 + 0.01	1.5 + 0.01	
1000 V	0.04 + 0.004	0.04 + 0.002	0.06 + 0.002	0.12 + 0.002	0.3 + 0.002			

1. Additional error beyond ±1°C, but within + 5°C of last ACAL. For ACBAND > 2 MHz, use 10 mV range temperature coefficient for all ranges.
2. Specifications apply full scale to 10% of full scale, DC < 10% of AC, sine wave input, crest factor = 1.4, and PRESET. Within 24 hours and ±1°C of last ACAL. Lo to Guard Switch on. Peak (AC + DC) input limited to 5 x full scale for all ranges in ACV function. Add 2 ppm of reading additional error for Agilent factory traceability of 10 V DC to US NIST.
3. LFILTER ON recommended.

AC Accuracy (continued): 24 Hour to 2 Year (% of Reading + % of Range)

Range	ACBAND > 2 MHz				
	45 Hz to 100 kHz	100 kHz to 1 MHz	1 MHz to 4 MHz	4 MHz to 8 MHz	8 MHz to 10 MHz
10 mV	0.09 + 0.06	1.2 + 0.05	7 + 0.07	20 + 0.08	
100 mV – 10 V	0.09 + 0.06	2.0 + 0.05	4 + 0.07	4 + 0.08	15 + 0.1
100 V	0.12 + 0.002				
1000 V	0.3 + 0.01				

Transfer Accuracy

Range	% of Reading
100 mV – 100 V	(0.002 + Resolution in %) ¹

Conditions

- Following 4 Hour warm-up
- Within 10 min and ±0.5°C of the reference measurement
- 45 Hz to 20 kHz, sine wave input
- Within ±10% of the reference voltage and frequency

1. Resolution in % is the value of RES command or parameter (reading resolution as percentage of measurement range).
2. Additional error beyond ±1°C, but within ±5°C of last ACAL. (% of Range)/°C. For ACBAND > 2 MHz, use 10 mV range temperature coefficient. Lo to Guard switch on.

AC + DC Accuracy (ACDCV Function)

For ACDCV Accuracy apply the following additional error to the ACV accuracy. (% of Range)

DC < 10% of AC Voltage			
Range	ACBAND ≤ 2 MHz	ACBAND > 2 MHz	Temperature Coefficient ²
10 mV	0.09	0.09	0.03
100 mV – 1000 V	0.008	0.09	0.0025

DC > 10% of AC Voltage			
Range	ACBAND ≤ 2 MHz	ACBAND > 2 MHz	Temperature Coefficient ²
10 mV	0.7	0.7	0.18
100 mV – 1000 V	0.07	0.7	0.025

Additional Errors

Apply the following additional errors as appropriate to your particular measurement setup. (% of Reading)

Source R	Input Frequency ³			
	0–1 MHz	1–4 MHz	4–8 MHz	8–10 MHz
0 Ω	0	2	5	5
50 Ω Terminated	0.003	0	0	0
75 Ω Terminated	0.004	2	5	5
50 Ω	0.005	3	7	10

Crest Factor	Resolution Multiplier ¹
1–2	(Resolution in%) × 1
2–3	(Resolution in%) × 2
3–4	(Resolution in%) × 3
4–5	(Resolution in%) × 5

3. Flatness error including instrument loading.

Reading Rates⁴

ACBAND Low	Maximum Sec / Reading
1 – 5 Hz	6.5
5 – 20 Hz	2.0
20 – 100 Hz	1.2
100 – 500 Hz	0.32
>500 Hz	0.02

% Resolution	Maximum Sec / Reading
0.001 – 0.005	32
0.005 – 0.01	6.5
0.01 – 0.05	3.2
0.05 – 0.1	0.64
0.1 – 1	0.32
>1	0.1

4. Reading time is the sum of the Sec / Reading shown for your configuration. The tables will yield the slowest reading rate for your configuration. Actual reading rates may be faster. For DELAY– 1; ARANGE OFF.

Settling Characteristics

There is no instrument settling required.

Common Mode Rejection

For 1 kΩ imbalance in LO lead, > 90 dB, DC to 60 Hz.

High Frequency Temperature Coefficient Maximum Input

For outside Tcal ±5°C add the following error.
(% of Reading)/°C

Range	Frequency	
	2 – 4 MHz	4 – 10 MHz
10 mV – 1 V	0.02	0.08
10 V – 1000 V	0.08	0.08

	Rated Input	Non-Destructive
HI to LO	±1000 V pk	±1200 V pk
LO to Guard	±200 V pk	±350 V pk
Guard to Earth	±500 V pk	±1000 V pk
Volt – Hz Product	1x10 ⁸	

Analog Mode (ACV Function, SETACV ANA)

Range	Full Scale	Maximum Resolution	Input Impedance	Temperature Coefficient ¹ (% of Reading+ % of Range) / °C
10 mV	12.00000	10 nV	1 MΩ±15% with<140pF	0.003 + 0.006
100 mV	120.0000	100 nV	1 MΩ±15% with<140pF	0.002 + 0
1 V	1.200000	1 μV	1 MΩ±15% with<140pF	0.002 + 0
10 V	12.00000	10 μV	1 MΩ±2% with<140pF	0.002 + 0
100 V	120.0000	100 μV	1 MΩ±2% with<140pF	0.002 + 0
1000 V	700.000	1 mV	1 MΩ±2% with<140pF	0.002 + 0

1. Additional error beyond ±1°C, but within ±5°C of last A CAL.
2. Specifications apply full scale to 1/20 full scale, sinewave input, crest factor = 1.4, and PRESET. Within 24 hours and ±1°C of last ACAL, Lo to Guard switch on to.
Maximum DC is limited to 400 V in ACV function.
Add 2 ppm of reading additional error for factory traceability of 10V DC to US NIST.

AC Accuracy²

24 Hour to 2 Year (% Reading + % Range)

Range	10Hz to 20 Hz	20 Hz to 40 Hz	40 Hz to 100 Hz	100 Hz to 20 kHz	20 kHz to 50 kHz	50 kHz to 100 kHz	100 kHz to 250 kHz	250 kHz to 500 kHz	500 kHz to 1 MHz	1 MHz to 2 MHz
10 mV	0.4 + 0.32	0.15 + 0.25	0.06 + 0.25	0.02 + 0.25	0.15 + 0.25	0.7 + 0.35	4 + 0.7			
100 mV–10 V	0.4 + 0.02	0.15 + 0.02	0.06 + 0.01	0.02 + 0.01	0.15 + 0.04	0.6 + 0.08	2 + 0.5	3 + 0.6	5+2	10+5
100 V	0.4 + 0.02	0.15 + 0.02	0.06 + 0.01	0.03 + 0.01	0.15 + 0.04	0.6 + 0.08	2 + 0.5	3 + 0.6	5+2	
1000 V	0.42+0.03	0.17+0.03	0.08 + 0.02	0.06 + 0.02	0.15 + 0.04	0.6 + 0.2				

AC+ DC Accuracy (ACDCV Function)

For ACDCV Accuracy apply the following additional error to the ACV accuracy. (% of Reading + % of Range)

Range	DC < 10% of AC Voltage		DC > 10% of AC Voltage	
	Accuracy	Temperature Coefficient ³	Accuracy	Temperature Coefficient ³
10 mV	0.0 + 0.2	0 + 0.015	0.15 + 3	0 + 0.06
100 mV–1000 V	0.0 + 0.02	0 + 0.001	0.15 + 0.25	0 + 0.007

3. Additional error beyond ±1°C, but within ±5°C of last ACAL, (% of Reading + % of Range) / °C.

Additional Errors

Apply the following additional errors as appropriate to your particular measurement setup.

LOW Frequency Error (% of Reading)

Signal Frequency	ACBAND Low		
	10 Hz–1 kHz NPLC > 10	1–10 kHz NPLC > 1	> 10 kHz NPLC > 0.1
10–200 Hz	0		
200–500 Hz	0	0.15	
500–1 kHz	0	0.015	0.9
1–2 kHz	0	0	0.2
2–5 kHz	0	0	0.05
5–10 kHz	0	0	0.01

Crest Factor Error (% of Reading)

Crest Factor	Additional Error
1–2	0
2–3	0.15
3–4	0.25
4–5	0.40

Reading Rates ¹

ACBAND Low	NPLC	Sec / Reading	
		ACV	ACDCV
≥10 Hz	10	1.2	1
≥1 kHz	1	1	0.1
≥10 kHz	0.1	1	0.02

- For DELAY-1: ARANGE OFF
For DELAY 0; NPLC .1 , unspecified reading rates of greater than 500/Sec are possible.

Settling Characteristics

For first reading or range change error using default delays, add .01% of input step additional error. The following data applies for DELAY 0.

Function	ACBAND Low	DC Component	Settling Time
ACV	≥ 10 Hz	DC < 10% AC	0.5 sec to 0.01%
		DC > 10% AC	0.9 sec to 0.01%
ACDCV	10 Hz-1 kHz		0.5 sec to 0.01%
	1 kHz-10 kHz		0.08 sec to 0.01%
	≥10 kHz		0.015 sec to 0.01%

Maximum Input

	Related Input Non-Destructive	
HI to LO	±1000 V pk	±1200 V pk
LO to Guard	±200 V pk	± 350 V pk
Guard to Earth	± 500 V pk	±1000 V pk
Volt - Hz Product	1 × 10 ⁸	

Common Mode Rejection

For 1 kΩ imbalance in LO lead, > 90 dB, DC - 60 Hz.

Random Sampled Mode (ACV Function, SETACV RNDM)

Range	Full Scale	Maximum Resolution	Input Impedance	(Temperature Coefficients ² % of Reading+% of Range)/°C
10 mV	12.000	1 μV	1 MΩ ±15% with <140 pF	0.002 + 0.02
100 mV	120.00	10 μV	1 MΩ ±15% with <140 pF	0.001 + 0.0001
1 V	1.2000	100 μV	1 MΩ ±15% with <140 pF	0.001 + 0.0001
10 V	12.0000	1 mV	1 MΩ ±2% with <140 pF	0.001 + 0.0001
100 V	120.00	10 mV	1 MΩ ±2% with <140 pF	0.0015 + 0.0001
1000 V	700.0	100 mV	1 MΩ ±2% with <140 pF	0.001 + 0.0001

- Additional error beyond ±1° C. but within ±5°C of last ACAL.
For ACBAND > 2 MHz, use 10 mV range temperature coefficient for all ranges.

AC Accuracy ³

24 Hour to 2 Year (% of Reading + % of Range)

Range	ACBAND ≤ 2 MHz				ACBAND > 2 MHz				
	20 Hz to 100 kHz	100 kHz to 300 kHz	300 kHz to 1 MHz	1 MHz to 2 MHz	20 Hz to 100 kHz	100 kHz to 1 MHz	1 MHz to 4 MHz	4 MHz to 8 MHz	8 MHz to 10 MHz
10 mV	0.5+0.02	4+0.02			0.1+0.05	1.2+0.05	7 + 0.07	20 + 0.08	
100 mV-10 V	0.08+0.002	0.3+0.01	1+0.01	1.5+0.01	0.1 +0.05	2+0.05	4 + 0.07	4 + 0.08	15 + 0.1
100 V	0.12+0.002	0.4+0.01	1.5+0.01		0.12+0.002				
1000 V	0.3+0.01				0.3+0.01				

- Specifications apply from full scale to 5% of full scale. DC < 10% of AC, sine wave input, crest factor=1.4, and PRESET. Within 24 hours and ±1°C of last ACAL. LO to Guard switch on.
Add 2 ppm of reading additional error for Agilent factory traceability of 10V DC to US NIST.
Maximum DC is limited to 400V in ACV function.

AC + DCV Accuracy (ACDCV Function)

For ACDCV Accuracy apply the following additional error to the ACV accuracy. (% of Range).

Range	DC ≤10% of AC Voltage			DC >10% of AC Voltage		
	ACBAND ≤ 2 MHz	ACBAND >2 MHz	Temperature Coefficient ¹	ACBAND ≤ 2 MHz	ACBAND >2 MHz	Temperature Coefficient ¹
10 mV	0.09	0.09	0.03	0.7	0.7	0.18
100 mV–1 kV	0.008	0.09	0.0025	0.07	0.7	0.025

Additional Errors

Apply the following additional errors as appropriate to your particular measurement setup. (% of Reading)

Source R	Input Frequency ²				Crest Factor	Resolution Multiplier
	0–1 MHz	1–4 MHz	4–8 MHz	8–10 MHz		
0 Ω	0	2	5	5	1–2	(Resolution in %) × 1
50 Ω Terminated	0.003	0	0	0	2–3	(Resolution in %) × 3
75 Ω Terminated	0.004	2	5	5	3–4	(Resolution in %) × 5
50 Ω	0.005	3	7	10	4–5	(Resolution in %) × 8

1. Additional error beyond ±1°C, but within ±5°C of last ACAL. (% of Reading) / °C.

For ACBAND > 2 MHz, use 10 mV range temperature coefficient for all ranges.

2. Flatness error including instrument loading.

Reading Rates³

% Resolution	Sec/Reading	
	ACV	ACDCV
0.1 – 0.2	40	39
0.2 – 0.4	11	9.6
0.4 – 0.6	2.7	2.4
0.6 – 1	1.4	1.1
1 – 2	0.8	0.5
2 – 5	0.4	0.1
>5	0.32	0.022

High Frequency Temperature Coefficient

For outside Tcal ±5°C add the following error. (% of Reading) / °C

Range	2– 4 MHz	4– 10 MHz
10 mV – 1 V	0.02	0.08
10 V – 1000 V	0.08	0.08

3. For DELAY –1;ARANGE OFF. For DELAY 0 in ACV, the reading rates are identical to ACDCV.

Settling Characteristics

For first reading or range change error using default delays, add 0.01% of input step additional error. The following data applies for DELAY 0.

Function	DC Component	Settling Time
ACV	DC < 10% of AC	0.5 sec to 0.01%
	DC > 10% of AC	0.9 sec to 0.01%
ACDCV	No instrument settling required.	

Common Mode Rejection

For 1 kΩ imbalance in LO lead, > 90 dB, DC to 60 Hz.

Maximum Input

	Rated Input	Non-Destructive
HI to LO	±1000 V pk	±1200 V pk
LO to Guard	± 200 V pk	± 350 V pk
Guard to Earth	± 500 V pk	±1000 V pk
Volt – Hz Product	1 x 10 ⁸	

5 / AC Current

AC Current (ACI and ACDCI Functions)

Range	Full Scale	Maximum Resolution	Shunt Resistance	Burden Voltage	Temperature Coefficient ¹ (% of Reading + % of Range) / °C
100 µA	120.0000	100 pA	730 Ω	0.1 V	0.002+0
1 mA	1.200000	1 nA	100 Ω	0.1 V	0.002+0
10 mA	12.000000	10 nA	10 Ω	0.1 V	0.002+0
100 mA	120.0000	100 nA	1 Ω	0.25 V	0.002+0
1 A	1.050000	1 µA	0.1 Ω	< 1.5 V	0.002+0

AC Accuracy²

24 Hour to 2 Year (% Reading + % Range)

Range	10 Hz to 20 Hz	20 Hz to 45 Hz	45 Hz to 100 Hz	100 Hz to 5 kHz	5 kHz to 20 kHz ³	20 kHz to 50 kHz ³	50 kHz to 100 kHz ³
100 µA ⁴	0.4+0.03	0.15+0.03	0.06+0.03	0.06+0.03			
1 mA – 100 mA	0.4+0.02	0.15+0.02	0.06+0.02	0.03+0.02	0.06+0.02	0.4 +0.04	0.55+0.15
1 A	0.4+0.02	0.16+0.02	0.08+0.02	0.1+0.02	0.3+0.02	1+0.04	

AC + DC Accuracy (ACDCI Function)

For ACDCI Accuracy apply the following additional error to the ACI accuracy.
(% of Reading + % of Range).

DC ≤ 10% of AC Accuracy	Temperature Coefficient ⁵	DC > 10% of AC Accuracy	Temperature Coefficient ⁵
0.005+0.02	0.0+0.001	0.15+0.25	0.0+0.007

Additional Errors

Apply the following additional errors as appropriate to your particular measurement setup.

LOW Frequency Error (% of Reading)

Signal Frequency	ACBAND Low		
	10 Hz-1 kHz NPLC > 10	1 to 10 kHz NPLC > 1	> 10 kHz NPLC > 0.1
10–200 Hz	0		
200–500 Hz	0	0.15	
500–1 kHz	0	0.015	0.9
1–2 kHz	0	0	0.2
2–5 kHz	0	0	0.05
5–10 kHz	0	0	0.01

Crest Factor Error (% of Reading)

Crest Factor	Additional Error
1–2	0
2–3	0.15
3–4	0.25
4–5	0.40

Reading Rates⁶

ACBAND Low	NPLC	Maximum Sec / Reading	
		ACI	ACDCI
≥ 10 Hz	10	1.2	1
≥ 1 kHz	1	1	0.1
≥ 10 kHz	0.1	1	0.02

1. Additional error beyond ±1°C, but within ±5°C of last ACAL.
2. Specifications apply full scale to 1/20 full scale, for sine wave inputs, crest factor = 1.4, and following PRESET within 24 hours and ±1°C of last ACAL.
Add 5 ppm of reading additional error for Agilent factory traceability to US NIST. Traceability is the sum of the 10V and 10 kΩ traceability values.
3. Typical performance
4. 1 kHz maximum on the 100 µA range.
5. Additional error beyond ±1°C, but within ±5°C of last ACAL
(% of Reading + % of Range) / °C.

6. For DELAY-1; ARANGE OFF. For DELAY 0; NPLC.1, unspecified reading rates of greater than 500/sec are possible.

Settling Characteristics

For first reading or range change error using default delays, add .01% of input step additional error for the 100 μ A to 100 mA ranges. For the 1 A range add .05% of input step additional error.

The following data applies for DELAY 0.

Function	ACBAND Low	DC Component	Settling Time
ACI	≥ 10 Hz	DC < 10% AC	0.5 sec to 0.01%
		DC > 10% AC	0.9 sec to 0.01%
ACDCI	10 Hz – 1 kHz		0.5 sec to 0.01%
	1 kHz – 10 kHz		0.08 sec to 0.01%
	≥ 10 kHz		0.015 sec to 0.01%

Maximum Input

	Rated Input	Non-Destructive
I to LO	± 1.5 A pk	< 1.25A rms
LO to Guard	± 200 V pk	± 350 V pk
Guard to Earth	± 500 V pk	± 1000 V pk

6 / Frequency/ Period

Frequency / Period Characteristics

	Voltage (AC or DC Coupled) ACV or ACDCV Functions ¹	Current (AC or DC Coupled) ACI or ACDCI Functions ¹
Frequency Range	1 Hz – 10 MHz	1 Hz – 100 kHz
Period Range	1 sec – 100 ns	1sec – 10 μ s
Input Signal Range	700 V rms – 1 mV rms	1 A rms – 10 μ A rms
Input Impedance	1 M Ω \pm 15% with <140 pF	0.1 – 730 Ω^2

1. The source of frequency measurements and the measurement input coupling are determined by the FSOURCE command.
2. Range dependent, see ACI for specific range impedance values.
3. Gate Time is determined by the specified measurement resolution.
4. For Maximum Input specified to fixed range operation. For auto range, the maximum speed is 30 readings/sec for ACBAND ≥ 1 kHz.

Accuracy

Range	24 Hour- 2 Year 0°C-55°C
1 Hz–40 Hz	
1 s–25 ms	0.05% of Reading
40 Hz – 10 MHz	
25 ms–100 ns	.01% of Reading

Reading Rates

Resolution	Gate Time ³	Readings/sec ⁴
0.00001%	1 s	0.95
>0.0001%	100 ms	9.6
> 0.001%	10 ms	73
> 0.01%	1 ms	215
> 0.1%	100 μ s	270

Measurement Technique:

Reciprocal Counting

Time Base:

10 MHz \pm 0.01%, 0°C to 55°C

Level Trigger:

\pm 500% of Range in 5% steps

Trigger Filter:

Selectable 75 kHz Low Pass Trigger Filter

Slope Trigger:

Positive or Negative

Actual Reading Speed is the longer of 1 period of the input, the chosen gate time, or the default reading time-out of 1.2 sec.

7 / Digitizing Specifications

General Information

The 3458A supports three independent methods for signal digitizing. Each method is discussed below to aid in selecting the appropriate setup best suited to your specific application.

DCV	Standard DCV function. This mode of digitizing allows signal acquisition at rates from 0.2 readings / sec at 28 bits resolution to 100k readings / sec at 16 bits. Arbitrary sample apertures from 500 ns to 1 sec are selectable with 100 ns resolution. Input voltage ranges cover 100 mV to 1000 V full scale. Input bandwidth varies from 30 kHz to 150 kHz depending on the measurement range.
DSDC	Direct Sampling DC Coupled measurement technique.
DSAC	Direct Sampling AC Coupled measurement technique. In these modes the input is sampled through a track / hold with a fixed 2 ns aperture which yields a 16 bit resolution result. The sample rate is selectable from 6000 sec / sample to 20 μ s / sample with 100 ns resolution. Input voltage ranges cover 10 mV peak to 1000 V peak full scale. The input bandwidth is limited to 12 MHz.
SSDC	Sub-Sampling (Effective time sampling) DC Coupled.
SSAC	Sub-Sampling (Effective time sampling) AC Coupled. These techniques implement synchronous sub-sampling of a repetitive input signal through a track / hold with a 2 ns sample aperture which yields a 16 bit resolution result. The effective sample rate is settable from 6000 sec / sample to 10 ns / sample with 10 ns resolution. Sampled data can be time ordered by the instrument and output to the GPIB. Input voltage ranges cover 10 mV peak to 1000 V peak full scale. The input bandwidth is limited to 12 MHz.

Summary of Digitizing Capabilities

Technique	Function	Input Bandwidth	Best Accuracy	Sample Rate
Standard	DCV	DC – 150 kHz	0.00005 – 0.01%	100 k/sec
Direct-sampled	DSDC / DSAC	DC – 12 MHz	0.02%	50 k/sec
Sub-sampled	SSDC / SSAC	DC – 12 MHz	0.02%	100 M / sec (effective)

Standard DC Volts Digitizing (DCV Function)

Range	Input Impedance	Offset Voltage ¹	Typical Bandwidth	Settling Time to 0.01% of Step
100 mV	>10 ¹⁰ Ω	<5 μ V	80 kHz	50 μ s
1 V	>10 ¹⁰ Ω	<5 μ V	150 kHz	20 μ s
10 V	>10 ¹⁰ Ω	<5 μ V	150 kHz	20 μ s
100 V	10 M Ω	<500 μ V	30 kHz	200 μ s
1000 V	10 M Ω	<500 μ V	30 kHz	200 μ s

1. $\pm 1^\circ$ C of an AZERO or within 24 hours and $\pm 1^\circ$ C of last ACAL.

DC Performance

0.005% of Reading + Offset¹

Maximum Sample Rate (See DCV for more data)

Readings / sec	Resolution	Aperture
100 k	15 bits	0.8 μ s
100 k	16 bits	1.4 μ s
50 k	18 bits	6.0 μ s

Sample Timebase

Accuracy: 0.01 %
Jitter: < 100 ps rms

External Trigger

Latency: < 175 ns ²
Jitter: < 50 ns rms

Level Trigger

Latency: < 700 ns
Jitter: < 50 ns rms

2. <125 ns variability between multiple 3458As

Dynamic Performance

100 mV, 1 V, 10 V Ranges; Aperture = 6 μ s

Test	Input (2 x full scale pk-pk)	Result
DFT-harmonics	1 kHz	< -96 dB
DFT-spurious	1 kHz	< -100 dB
Differential non-linearity	dc	< 0.003% of Range
Signal to Noise Ratio	1 kHz	>96 dB

Direct and Sub-sampled Digitizing (DSDC, DSAC, SSDC and SSAC Functions)

Range 1	Input Impedance	Offset Voltage ²	Typical Bandwidth
10 mV	1 M Ω with 140 pF	<50 μ V	2 MHz
100 mV	1 M Ω with 140 pF	<90 μ V	12 MHz
1 V	1 M Ω with 140 pF	<800 μ V	12 MHz
10 V	1 M Ω with 140 pF	<8 mV	12 MHz
100 V	1 M Ω with 140 pF	<80 mV	12 MHz ³
1000 V	1 M Ω with 140 pF	<800 mV	2 MHz ³

1. Maximum DC voltage limited to 400 V DC in DSAC or SSAC functions.
2. \pm 1°C and within 24 hours of last ACAL ACV.
3. Limited to 1 x10⁸ V-Hz product.

DC to 20 kHz Performance

0.02 % of Reading + Offset ²

Maximum Sample Rate

Function	Readings / sec	Resolution
SSDC, SSAC	100 M (effective) ⁴	16 bits
DSDC, DSAC	50 k	16 bits

Dynamic Performance

100 mV, 1 V, 10 V Ranges; 50,000 Samples/sec

Test	Input (2 x full scale pk-pk)	Result
DFT-harmonics	20 kHz	<-90 dB
DFT-harmonics	1.005 MHz	<-60 dB
DFT-spurious	20 kHz	<-90 dB
Differential non-linearity	20 kHz	<0.005 % of Range
Signal to Noise Ratio	20 kHz	>66 dB

Sample Timebase

Accuracy: 0.01 %
Jitter: < 100 ps rms

External Trigger

Latency: < 125 ns ⁵
Jitter: < 2 ns rms

Level Trigger

Latency: < 700 ns
Jitter: < 100 ps, for 1 MHz full scale input

4. Effective sample rate is determined by the smallest time increment used during synchronous sub-sampling of the repetitive input signal, which is 10 ns.
5. <25 ns variability between multiple 3458As

8 / System Specifications

Function-Range-Measurement

The time required to program via GPIB a new measurement configuration, trigger a reading, and return the result to a controller with the following instrument setup: PRESET FAST; DELAY 0; AZERO ON; OFORMAT SINT; INBUF ON; NPLC 0.

TO - FROM Configuration Description	GPIB Rate ¹	Subprogram Rate
DCV \leq 10 V to DCV \leq 10 V	180/sec	340/sec
any DCV / OHMS to any DCV / OHMS	85/sec	110/sec
any DCV/OHMS to any DCV/ OHMS with DEFEAT ON	150/sec	270/sec
TO or FROM any DCI	70/sec	90/sec
TO or FROM any ACV or ACI	75/sec	90/sec

1. Using HP 9000 Series 350.
2. SINT data is valid for APER \leq 10.8 μ s.

Selected Operating Rates ²

Conditions	Rate
DCV Autorange Rate (100 mV to 10 V)	110 / sec
Execute simple command changes (CALL, OCOMP, etc.)	330 / sec
Readings to GPIB, ASCII	630 / sec
Readings to GPIB, DREAL	1000 / sec
Readings to GPIB, DINT	50,000 / sec
Readings to internal memory, DINT	50,000 / sec
Readings from internal memory to GPIB, DINT	50,000 / sec
Readings to GPIB, SINT	100,000 / sec
Readings to internal memory, SINT	100,000 / sec
Readings from internal memory to GPIB, SINT	100,000 / sec
Maximum internal trigger reading rate	100,000 / sec
Maximum external trigger reading rate	100,000 / sec

Memory

	Standard		Option 001	
	Readings	Bytes	Readings	Bytes
Reading Storage (16 bit)	10,240	20 k	+65,536	+128 k
Non-volatile, for subprograms and / or state storage		14 k		

Delay Time

Accuracy	$\pm 0.01\% \pm 5$ ns
Maximum	6000 s
Resolution	10 ns
Jitter	50 ns pk-pk

Timer

Accuracy	$\pm 0.01\% \pm 5$ ns
Maximum	6000 s
Resolution	100 ns
Jitter	<100 ps rms

9 / Ratio

Type of Ratio ¹

DCV / DCV	Ratio = (Input) / (Reference)
ACV / DCV	Reference: (HI Sense to LO) – (LO Sense to LO)
ACDCV / DCV	Reference Signal Range: ± 12 V DC (autorange only)

1. All SETACV measurement types are selectable. LO Sense to LO limited to ± 0.25 V.

Accuracy

\pm (Input error + Reference Error)

Input error = $1 \times$ Total Error for input signal measurement function (DCV, ACV, ACDCV)

Reference error = $1.5 \times$ Total error for the range of the reference DC input

10 / Math Functions

General Math Function Specifications

Math is executable as either a real-time or post processed operation.

Math function specifications do not include the error in X (the instrument reading) or errors in user entered values. The range of values input or output is $+ 1.0 \times 10^{-37}$ to $+ 1.0 \times 10^{37}$. Out of range values indicate OVLD in the display and 1×10^{38} to GPIB. The minimum execution time is the time required to complete one math operation after each reading has completed.

NULL:

X-OFFSET

Minimum Execution Time = 180 μ s

PERC:

$100 \times (X- \text{PERC}) / \text{PERC}$

Minimum Execution Time = 600 μ s

dB:

$20 \times \text{Log} (X/\text{REF})$

Minimum Execution Time = 3.9 ms

RMS:

1 –pole digital filter

Computed rms of inputs.

Minimum Execution Time = 2.7 ms

STAT:

MEAN, SDEV computed for sample population (N-1). NSAMP, UPPER, LOWER accumulated.

Minimum Execution Time = 900 μ s

CTHRM2K (FTHRM2K):

$^{\circ}\text{C}$ ($^{\circ}\text{F}$) temperature conversion for 2.2 k Ω thermistor (Agilent 40653A).

Minimum Execution time = 160 μ s

CRTD85 (FRTD85):

$^{\circ}\text{C}$ ($^{\circ}\text{F}$) temperature conversion for RTD of 100 Ω , Alpha = 0.00385

Minimum Execution Time = 160 μ s

SCALE:

(X-OFFSET) / SCALE

Minimum Execution Time = 500 μ s

PFAIL:

Based on MIN, MAX registers

Minimum Execution Time = 160 μ s

dBm:

$10 \times \text{Log} [(X^2/\text{RES}) / 1 \text{ mW}]$

Minimum Execution Time = 3.9 ms

FILTER:

1 –pole digital filter

Weighted Average of inputs

Minimum Execution Time = 750 μ s

CTHRM10K (FTHRM10K):

$^{\circ}\text{C}$ ($^{\circ}\text{F}$) temperature conversion for 10 k Ω thermistor (Agilent 40653C).

Minimum Execution Time = 160 μ s

CRTD92 (FRTD92):

$^{\circ}\text{C}$ ($^{\circ}\text{F}$) temperature conversion for RTD of 100 Ω , Alpha = 0.003916

Minimum Execution Time = 160 μ s

CRTD92 (FRTD92):

$^{\circ}\text{C}$ ($^{\circ}\text{F}$) temperature conversion for RTD of 100 Ω , Alpha = 0.003916

Minimum Execution time = 160 μ s

11 / General Specifications

Operating Environment

Temperature Range: 0°C to 55°C
Operating Location: Indoor Use Only
Operating Altitude: Up to 2,000 Meters
Pollution Rating: IEC 664 Degree 2

Operating Humidity Range

up to 95% RH at 40°C

Physical Characteristics

88.9 mm H x 425.5 mm W x 502.9 mm D
Net Weight: 12 kg (26.5 lbs)
Shipping Weight 14.8 kg (32.5 lbs)

Storage Temperature

-40°C to + 75°C

Warm-Up Time

4 Hours to published specifications

Power Requirements

100/120 V, 220/240 V \pm 10%
48-66Hz, 360-420Hz (auto sensed)
<30 W, <80 VA (peak)
Fused: 1.5 @ 115 V or 0.5 A @230 V

Cleaning Guidelines

To clean the instrument, use a clean cloth slightly dampened with water.

Warranty Period

One year

Input Terminals

Gold-plated Tellurium Copper

Input Limits

Input HI to LO: 300 Vac Max (CAT II)

IEEE-488 Interface

Complies with the following:
IEEE-488.1 Interface Standard
IEEE-728 Codes/Formats Standard
CIIIL (Option 700)

Included with Agilent 3458A:

Test Lead Set (Agilent 34118A)
Power Cord
User's Guide
Calibration Manual
Assembly Level Repair Manual
Quick Reference Guide

Field Installation Kits	Agilent Part Number
Option 001 Extended Reading Memory	03458-87901
Option 002 High Stability Reference	03458-80002
Extra Keyboard Overlays (5 each)	03458-84303

Available Documentation	Agilent Part Number
Product Note 3458A-1: Optimizing Throughput and Reading Rate	5953-7058
Product Note 3458A-2: High Resolution Digitizing with the 3458A	5953-7059
Product Note 3458A-3: Electronic Calibration of the 3458A	5953-7060
Extra Manual Set	03458-90000

Appendix B Electronic Calibration of the 3458A (Product Note 3458A-3)

A voltmeter has four basic functional blocks.

The input signal must first pass through some type of signal conditioner. For a DC input voltage, the signal conditioner may consist of an attenuator for the higher voltage ranges and a DC amplifier for the lower ranges. If the input signal is an AC voltage, an RMS converter changes the AC signal to an equivalent DC value. By supplying a DC current, an ohms converter changes resistance to a DC voltage. In nearly all cases, the input signal conditioner converts the unknown quantity to a DC voltage that is within the range of the A-to-D converter.

The job of the A-to-D converter is to take a pre-scaled DC voltage and convert it to digits. A-to-D converters are single range DC voltage devices. Some take a 1 V full-scale input while others take a 10 V full-scale input. For this reason, the signal conditioner must attenuate higher voltages and amplify lower voltages to give the voltmeter a selection of ranges.

Let's take an example. Suppose we apply 250 V AC to a voltmeter with an A-to-D converter that requires a 1 V DC input. The AC signal is attenuated on the 1000 V AC range and converted to a DC voltage equal to 0.25 V. The final reading appears as "250.0 V AC." (In general, AC in the 3458A Multimeter uses 2 V full-scale.)

These first two building blocks govern the voltmeter's basic characteristics such as its number of digits, its ranges, and its sensitivity. The A-to-D converter governs a voltmeter's speed, resolution, and, in some cases, its ability to reject noise.

The logic block manages the flow of information and the correct sequence of various internal functions. The logic also acts as a communicator with the outside world. Specifically, the logic manages the outward flow of digital information and accepts programming instructions from other devices. The display communicates visually the result of a measurement. In selecting a voltmeter to fill a specific application, these building blocks combine to give the instrument its specific performance characteristics.

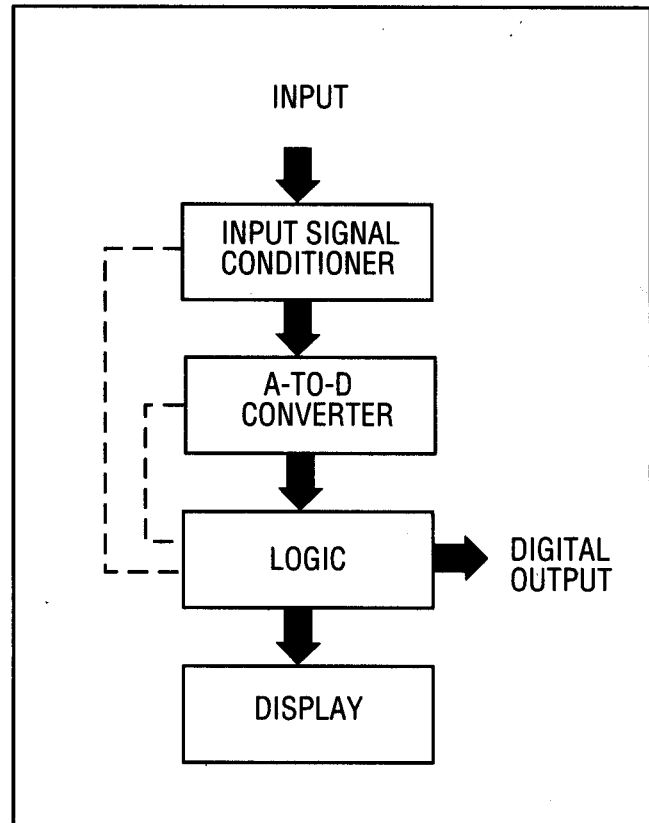

Saving Calibration Time and Money

The increasing accuracy required of today's instrumentation tends to increase complexity and cost of maintaining calibration of these instruments. In an effort to reduce the cost and complexity of calibration, the 3458A Multimeter reduces the number of external reference standards required for calibration. All functions and ranges require only one external DC voltage standard and only one external resistance standard.

Many of the external reference standards traditionally maintained and used by metrology laboratories for calibration (for example, resistive networks and DC-to-AC transfer devices) are being replaced with internal circuitry and algorithms that can achieve comparable results. With the 3458A Multimeter, all adjustments are electronic - there are no potentiometers in this instrument.

For many applications, you can substantially increase the time between calibrations, saving costs. For example, the standard 3458A Multimeter is as accurate at the end of a year as most multimeters are at the end of a day.

In systems, rack temperatures are typically more than 40°C and have wide temperature variations. Auto-calibration of the 3458A Multimeter improves measurement accuracy under these circumstances.

The end result is that the 3458A Multimeter measures DC and AC with unmatched accuracy, precision, and speed, while avoiding the usual high cost of maintaining such an instrument.

The Basis for Auto-Calibration

Only three external inputs are needed as the basis for all normal adjustments:

- Four-wire short
- 10 V DC voltage standard
- 10 k Ω resistance standard

Normal calibration, described below, provides traceability of all functions, ranges, and internal reference standards to the two external standards. An additional auto-calibration process adjusts the 3458A Multimeter using internal reference standards that are traceable to the external standards via the normal calibration process. Thus invoking auto-calibration at any time produces exemplary accuracy over a long time frame and over widely varying operating temperatures.

Multimeter designers and users have always had to cope with how to reduce offset and gain error introduced into measurements by internal circuits of the multimeter. These errors constantly change because component characteristics vary with time, temperature, humidity, and other environmental conditions. Early multimeters reduced internal errors by adjusting the value of key components. The use of adjustable components had two major drawbacks. First, making adjustments often required removing the multimeter's covers. Unfortunately, removing the covers changed the temperature within the multimeter. Second, adjustable components were often a major contributor to drift that caused inaccuracies.

With the emergence of non-volatile memory, multimeters were designed with few or no adjustable components. Instead, microprocessors were used to calculate a gain and offset correction for each function and range. These correction constants were then stored in non-volatile memory and used to correct the errors of the internal circuitry. Calibration was improved because covers were removed during calibration and the multimeter's internal circuits required no adjustable components.

The 3458A goes beyond these techniques by conveniently correcting errors due to time or environmental variations. Adjustments primarily consist of offset and gain constants, although all other errors are considered. A patent pending technique prevents the loss of calibration constants in non-volatile memory.

The analog-to-digital converter's linearity and transfer accuracy are fundamentally important to the calibration technique used in the 3458A Multimeter. The linearity of the analog-to-digital converter gives the instrument the ability to measure the ratio of two DC voltages at state-of-the-art accuracies. In other words, this converter maintains its accuracy over the entire measurement range, without any internal adjustments. The speed of the analog-to-digital converter allows an internal DC to AC transfer of accuracy, again state-of-the-art.

The analog-to-digital converter achieves this performance using a patented technique known as "multislope integration." This technique uses charge balancing, where the charge from the input signal is cancelled by charge injected from reference signals. Multi-slope integration also allows the integration aperture to be changed so that measurement resolution can be traded for measurement speed.

Measurements using a Josephson junction standard confirm linearity of the analog-to-digital converter design. These measurements reveal integral linearity below 0.1 parts per million and differential linearity of 0.02 parts per million. This performance, incidentally, is comparable to a Kelvin-Varley divider.

The only errors not removed in the 3458A Multimeter calibration are drifts of the internal voltage reference and the internal resistance standard. The internal reference voltage has an average drift during its first 90 days of less than 2 parts per million. As shown in Figure 1, the three sigma points are less than 4 parts per million. For DC volt transfer measurements, the 3458A Multimeter's short-term stability is within 0.1 parts per million of reading.

The internal reference resistor has a specified drift of 5 parts per million per year and a temperature coefficient of 1 part per million per Celsius degree.

Auto-calibration adjusts for time and temperature drifts in the rest of the circuitry, relative to these internal references.

Offset Adjustments

To remove offset errors of internal circuits, the multimeter internally connects a short in place of the input terminals and measures the offset. Normal measurements of signals on the input terminals subtract this offset to give the correct reading. The only offset errors not removed by this approach are thermocouple offsets along the path from the input terminals to the point that is switched to the internal short.

These errors require a four-wire short on both the front and rear input terminals (switch selected). With these external inputs, one command, CAL 0, executes zero offset measurements that result in additional offset calibration constants to correct subsequent readings.

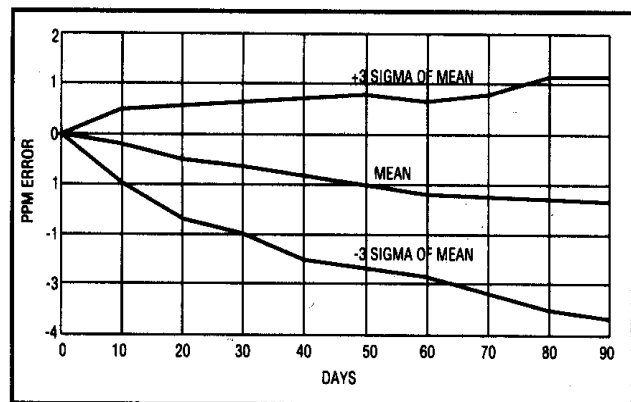
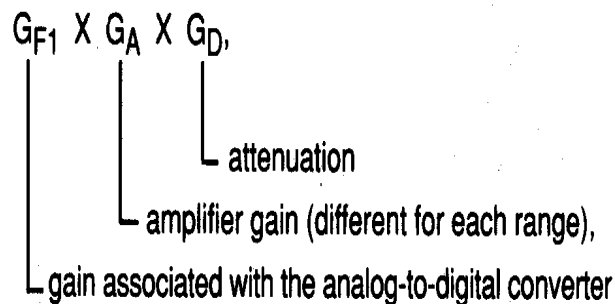

Figure 1.
This plot shows stability with time of the reference voltage standard used in the 3458 Multimeter.

Other multimeters use this approach to removing offset errors. The 3458A Multimeter simply makes improvements by using more stable components, again minimizing time and environmental errors.

DC Gain Adjustments

Gain adjustments of all five DC voltage ranges (100 mV full-scale to 1000 V full-scale) require only one external DC voltage standard. The DC voltage input path, shown in Figure 2, requires three adjustments, potentially. The product, represents the calibration gain used on any given range.



Internal tolerance limits for each gain adjustment are factory set. A gain value outside the associated tolerance indicates a malfunctioning instrument. Therefore, as the gain adjustments are being computed, the instrument checks the value of each gain adjustment and flags errors accordingly.

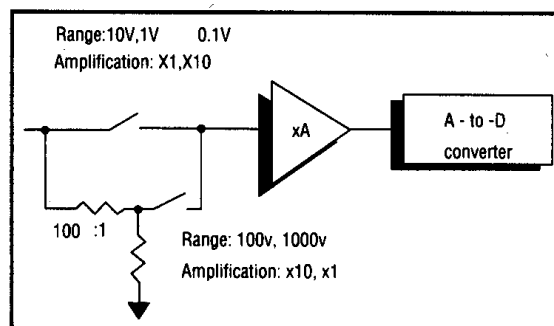

Figure 2.
The DC input path to the analog-to-digital converter is either through an amplifier only or through an additional resistive attenuator, depending on the range used.

The user enters the exact value of the external 10 V DC voltage standard (for example, "CAL 10"). The following sequence, performed automatically by the 3458A Multimeter, determines gain constants for all ranges:

1. Measure the external "10 V" standard on the 10 V range.
2. Create the gain adjustment for the 10 V range using the ratio of the measured and actual values.
3. Measure accuracy of the internal reference voltage relative to the external standard, and store the difference as a reference adjustment. (When subsequently invoked, auto-calibration uses this stored value to re-determine all gain adjustment constants).

Gain adjustments are now made for all other DC voltage ranges.

4. Using the input path for the 10 V range, accurately measure 1 V generated internally.

Linearity of the measurement circuits allows a measurement that accurately reflects the actual 1 V output. In other words, we transfer traceable accuracy from the 10 V range to all other ranges.

The lower ranges use amplifiers to condition the input for the 10 V full-scale analog-to-digital converter. Each amplifier used requires a gain constant, G_A , to adjust normal readings. The following process determines these constants.

5. In the 1 V range, measure the same 1 V previously measured with the 10 V range.
6. Calculate a 1 V range gain adjustment so that the two measurements agree. Note that neither the precise value nor the long-term stability of the internal 1 volt source are important. The internal 1 volt source need only be stable for the time it takes to measure it twice.
7. Using the adjusted 1 V range, accurately measure 0.1 V generated internally.
8. Measure the same 0.1 V using the 100 mV range.
9. Calculate a 100 mV range gain adjustment so that the two measurements agree.

Normal 100 V and 1000 V range measurements use a 100:1 resistor network to attenuate the input. To correct errors introduced by this network, we apply zero volts to the input. Then, we apply 10 V and measure the actual value. Finally, we measure 0.1 V, with the zero error removed, and compute the gain adjustment constant.

Input voltages greater than 100 V (1000 V range) create a self-heating error in the resistor network, as shown in Figure 3. This easily identified error is simply specified as part of the instrument's published error.

Additional measurements result in constants to compensate for switching transients and leakage currents.

Figure 3.
On the 1000 V range, nonlinear self-heating errors of the 100:1 resistive attenuator are noticeable.

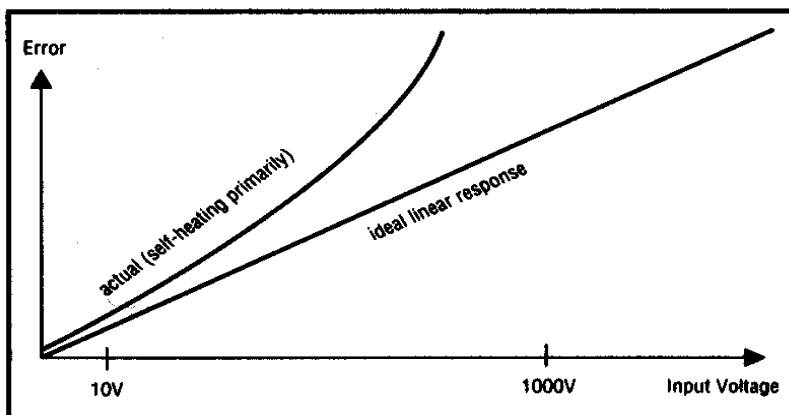

Resistance and DC Current Adjustments

Calibration of all resistance (nine ranges from 10 Ω to 1 G Ω) and DC current ranges (eight ranges from 100 nA to 1 A) requires only one external resistance standard. Resistance is measured by applying a known current through the unknown resistance and measuring the voltage across it. Current is measured by applying the unknown current through a known shunt resistor and measuring the voltage across it. The process explained previously has already corrected errors in the DC voltage input path. Measuring the actual values of the current sources and shunt resistors results in the additional information needed to adjust resistance and current measurements.

Both current and resistance are calibrated concurrently. For resistance measurements, a current source provides 500 nA to 10 mA, depending on the measurement range. Current measurements use shunt resistor values that vary from 0.1 Ω to 545.2 k Ω .

The user enters the exact value of the external 10 kilohm standard (for example, "CAL 10E3"). The following sequence, performed automatically by the 3458A Multimeter, determines adjustment constants for all ranges of resistance and DC current:

1. Make a four-wire offset-compensated measurement of the external "10 k Ω " standard using the 10 k Ω range.
2. Use the ratio of the measured and actual values as the 10 k Ω range calibration constant (current source adjustment for the 10 k Ω range).

3. Measure the internal reference resistor relative to the external standard, and store the difference as a reference adjustment. (When subsequently invoked, auto-calibration uses this stored value to re-determine adjustment constants.)
4. Use the calibrated internal reference resistor to adjust current source values used for other resistance ranges.
5. Use calibrated current sources to adjust shunt resistor values used for DC current measurements.

Leakage currents for resistance measurements and offsets produced with shunt resistors for current measurements are additional sources of error. Adjustment of these errors is simply a matter of measuring and storing the results as adjustment constants.

AC Flatness and Gain Adjustments

Routine calibration of AC voltage and current functions requires no external AC standards. To accurately measure AC signals, the internal circuits must have constant gain versus frequency of the input signal. An Agilent Technologies patented technique electronically adjusts the entire AC section, shown in Figure 4. This technique first adjusts frequency response flatness of the AC attenuator network, then adjusts gains of the RMS converter and track-and-hold amplifier.

Similar to the adjustment of an oscilloscope probe, proper adjustment of the AC attenuator network produces a maximally flat response to a step input voltage, as shown in Figure 5. A circuit that responds to a step input with an undistorted step output has constant gain versus frequency of the input signal, which can be shown using Fourier transform theory.

Figure 4.
The AC input paths are first adjusted for flatness. Later, in the normal calibration process, gain adjustments are made.

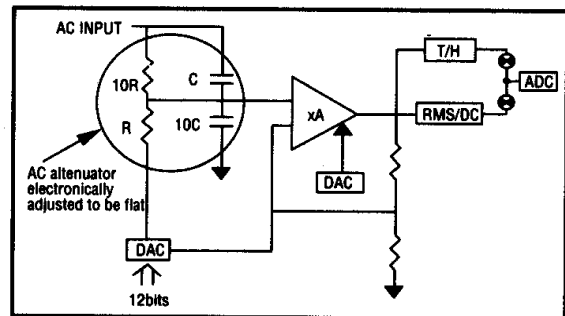

The 3458A Multimeter produces the required step input voltage. Then, its analog-to-digital converter samples the attenuator output. These measurement results determine constants used to control the output of the flatness adjusting DAC. Control of the DAC output effectively changes the resistance in one leg of the attenuator to produce the desired maximally flat response. Calibration constants are separately determined for each AC range.

AC converters normally have turnover errors. A standard metrology practice is to use \pm signals to correct these errors. A shorter time between samples of these \pm signals reduces $1/f$ noise. Thus the 3458A Multimeter samples at a higher rate to give $1/f$ rejection, as indicated in Figure 6.

These signals are applied to the RMS converter and track-and-hold amplifier paths. Attenuated or amplified levels produce inputs appropriate for each of six AC voltage ranges. The 3458A Multimeter measures the correct values of these DC levels with the DC input path that has already been calibrated. These known values are compared with the measured gains of the RMS converter and track-and-hold amplifier paths. Gain constants are the result of transferring accuracy between ranges, as discussed under DC gain adjustments.

Gain of the RMS converter is non-linear at one-tenth full scale. This non-linearity is effectively an offset corrected by applying the chopped DC levels at one-tenth the full-scale voltage.

One-time Adjustments

The following electronic adjustments are only performed once at the factory or following repair of the circuitry involved.

1. Determine the actual frequency value of the crystal used for frequency and period measurements.
2. Adjust time base interpolator accuracy.
3. Adjust high frequency response of the AC attenuator and amplifier by transfer of accuracy at 100 kHz to 2 MHz and 8 MHz.

Traceability

The above methods result in all functions and ranges being traceable to one or both of the internal reference standards. These internal standards are, in turn, traceable to the external standards. The problem is knowing the uncertainty to which they are traceable. The answer lies in knowing the maximum uncertainty of each transfer measurement made. The dominant sources of transfer uncertainty are the linearity errors of the internal circuits and the noise of each measurement. Each transfer measurement contributes some error. With multiple transfers between ranges, the error is cumulative.

However, the excellent short-term stability of the internal references and the superior linearity of the analog-to-digital converter minimizes these errors. For example, the cumulative transfer error for the 3458A Multimeter is less than 1 part per million on the lower three DC volt ranges.

All calibration transfer errors and noise errors are included in the published accuracy specifications of the 3458A Multimeter.

Figure 5.

The frequency response of the AC attenuator is adjusted based on two readings taken at specific delays after application of a step input. Shown in this drawing are two different uncompensated responses representing under shoot and overshoot.

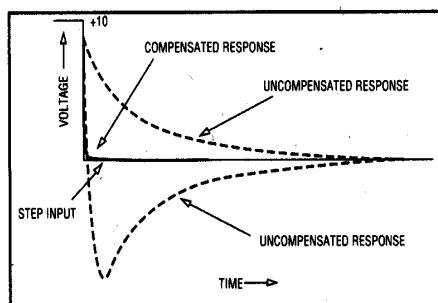
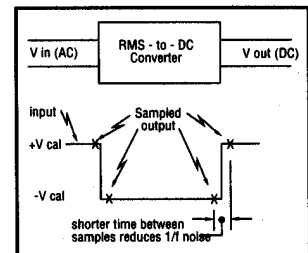

Figure 6.

Positive and negative signals are internally provided to eliminate turnover errors. This input is also sampled at a higher rate to reject $1/f$ noise.



Summary

Electronic internal calibration of the 3458A Multimeter simplifies and shortens the calibration time, while maintaining accuracy and traceability. This multimeter removes all drift errors, with the exception of the internal reference standard drift errors. As a result, the scheme relies on the excellent stability of the reference voltage and resistor, and superb linearity of the analog to-digital converter.

Depending on the application, auto-calibration using the internal reference standards results in one or more of the following benefits:

- Improved measurement accuracy
- Extended time between calibrations
- Extended operating temperature range
- Reduced errors resulting from other environmentally- caused errors, such as circuit changes with humidity

These benefits are especially significant when compared with earlier generation multimeters used in metrology, electronic test, and many other demanding applications.

There are a total of 253 calibration constants stored in the 3458A Multimeter (these constants can be queried). Of these constants, only 44 are routinely determined from external measurements.

Externally Derived Calibration Constants

Offset Constants:

DC volts, 0.1 V to 10 V ranges, Front and rear input terminal paths; 6 offset constants

Two-wire resistance, 10 Ω to 1 G Ω ranges, Front and rear input terminal paths; 18 offset constants

Four-wire resistance, 10 Ω to 1 G Ω ranges, Front and rear input terminal paths; 18 offset constants

Internal Reference Constants:

Voltage - value of internal reference voltage; 1 constant

Resistance - value of internal reference resistor; 1 constant

Of the remaining 209 calibration constants in the instrument, 6 are determined through one-time external calibrations. These constants provide adjustments for frequency and period measurements, time base interpolation, and the high frequency (beyond 2 MHz) AC response.

Six additional constants are provided for user convenience. These constants record the temperature of the last offset calibration, last external voltage standard calibration, last external resistance standard calibration, last auto-calibration of DC, last auto-calibration of AC, and last auto-calibration of resistance.

The remaining 197 constants are determined through internal ratio transfer measurements as previously described. These constants are also updated each time auto-calibration (ACAL ALL) is executed, reducing time, temperature, or environmentally-induced drift errors. This capability enhances measurement accuracies over extended time intervals and operating temperature ranges.

