

HP 35665A Dynamic Signal Analyzer

Quick Start Guide

For Instruments with Firmware Revision
A.01.00



HP Part Number 35665-90035
Microfiche Part Number 35665-90235
Printed in U.S.A.

Print Date: September 1991

©Hewlett-Packard Company, 1991. All rights reserved.
8600 Soper Hill Road Everett, Washington 98205-1298 U.S.A.

C

C

C



Safety Summary

The following general safety precautions must be observed during all phases of operation, service, and repair of this instrument. Failure to comply with these precautions or with specific warnings elsewhere in this manual violates safety standards of design, manufacture, and intended use of the instrument. Hewlett-Packard Company assumes no liability for the customer's failure to comply with these requirements. This is a Safety Class 1 instrument.

Ground The Instrument

To minimize shock hazard, the instrument chassis and cabinet must be connected to an electrical ground. The instrument is equipped with a three-conductor ac power cable. The power cable must either be plugged into an approved three-contact electrical outlet or used with a three-contact to two-contact adapter with the grounding wire (green) firmly connected to an electrical ground (safety ground) at the power outlet. The power jack and mating plug of the power cable meet International Electrotechnical Commission (IEC) safety standards.

Do Not Operate In An Explosive Atmosphere

Do not operate the instrument in the presence of flammable gases or fumes. Operation of any electrical instrument in such an environment constitutes a definite safety hazard.

Keep Away From Live Circuits

Operating personnel must not remove instrument covers. Component replacement and internal adjustments must be made by qualified maintenance personnel. Do not replace components with power cable connected. Under certain conditions, dangerous voltages may exist even with the power cable removed. To avoid injuries, always disconnect power and discharge circuits before touching them.

Do Not Service or Adjust Alone

Do not attempt internal service or adjustment unless another person, capable of rendering first aid and resuscitation, is present.

Do Not Substitute Parts or Modify Instrument

Because of the danger of introducing additional hazards, do not install substitute parts or perform any unauthorized modification to the instrument. Return the instrument to a Hewlett-Packard Sales and Service Office for service and repair to ensure the safety features are maintained.

Dangerous Procedure Warnings

Warnings, such as the example below, precede potentially dangerous procedures throughout this manual. Instructions contained in the warnings must be followed.

Warning



Dangerous voltages, capable of causing death, are present in this instrument. Use extreme caution when handling, testing, and adjusting.

Safety Symbols

The following safety symbols are used throughout this manual and in the instrument. Familiarize yourself with each symbol and its meaning before operating this instrument.

General Definitions of Safety Symbols Used On Equipment or In Manuals.



Instruction manual symbol: the product will be marked with this symbol when it is necessary for the user to refer to the instruction manual in order to protect against damage to the instrument.



Indicates dangerous voltage (terminals fed from the interior by voltage exceeding 1000 volts must be so marked.)

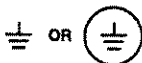

Protective conductor terminal. For protection against electrical shock in case of a fault. Used with field wiring terminals to indicate the terminal which must be connected to ground before operating equipment.



Low-noise or noiseless, clean ground (earth) terminal. Used for a signal common, as well as providing protection against electrical shock in case of a fault. A terminal marked with this symbol must be connected to ground in the manner described in the installation (operating) manual, and before operating the equipment.



Frame or chassis terminal. A connection to the frame (chassis) of the equipment which normally includes all exposed metal structures.



Alternating current (power line).



Direct current (power line).



Alternating or direct current (power line).

Warning



The **WARNING** sign denotes a hazard. It calls attention to a procedure, practice, condition or the like, which if not correctly performed or adhered to, could result in injury or death to personnel.

Caution



The **CAUTION** sign denotes a hazard. It calls attention to an operating procedure, practice, condition or the like, which, if not correctly performed or adhered to, could result in damage to or destruction of part or all of the product.

Note



The **NOTE** sign denotes important information. It calls attention to procedure, practice, condition or the like, which is essential to highlight.

Guide to HP 35665A Documentation

If you are thinking about...	And you want to...	Then read...
<p>◆ Unpack and install the HP 35665A</p>	<p>Install the HP 35665A Dynamic Signal Analyzer</p> <p>Do operation verification or performance verification tests</p>	<p><i>HP 35665A Installation and Verification Guide</i></p> <p><i>HP 35665A Installation and Verification Guide</i></p>
<p>◆ Getting started</p>	<p>Make your first measurements with your new analyzer</p> <p>Review measurement basics</p> <p>Learn what each key does</p>	<p><i>HP 35665A Quick Start Guide</i></p> <p><i>HP 35665A Concepts Guide</i></p> <p><i>HP 35665A Operator's Reference</i> or use the analyzer's [Help] key</p>
<p>◆ Making measurements</p>	<p>Learn how to make typical measurements with the HP 35665A</p> <p>Understand each of the analyzer's instrument modes</p>	<p><i>HP 35665A Operator's Guide</i></p> <p><i>HP 35665A Concepts Guide</i></p>
<p>◆ Creating automated measurements</p>	<p>Learn the HP Instrument BASIC interface</p> <p>Record keystrokes for a particular measurement</p> <p>Program with HP Instrument BASIC</p>	<p><i>Using HP Instrument BASIC with the HP 35665A</i></p> <p><i>HP 35665A Operator's Guide</i></p> <p><i>HP Instrument BASIC User's Handbook</i></p>
<p>◆ Remote operation</p>	<p>Learn about the HP-IB</p> <p>Learn how to program with HP-IB</p> <p>Find specific HP-IB commands</p>	<p><i>HP-IB Programming with the HP 35665A</i></p> <p><i>HP-IB Programming with the HP 35665A</i></p> <p><i>HP 35665A HP-IB Commands: Quick Reference</i></p>
<p>◆ Servicing the analyzer</p>	<p>Adjust, troubleshoot, or repair the analyzer</p>	<p><i>HP 35665A Service Guide</i></p>

Table of Contents

Chapter 1: Before You Begin

Introducing the HP 35665A Dynamic Signal Analyzer...	1-1
Other Options	1-1
The HP 35665A at a Glance	1-2
Firmware Revision Date	1-3
Need Assistance?	1-3
Notation Conventions	1-4
Hardkeys	1-4
Softkeys	1-4
Toggle Keys	1-4
Ghosted Softkeys	1-4
Where to find Additional Information	1-5
Using the [Help] key	1-5
The HP 35665A Documentation Set	1-5
Demonstration Disc	1-5
Application Notes.	1-5
Using the Optional Keyboard...	1-6

Chapter 2: Source Characterization

Task Overview	2-1
Task Setup	2-2
The Task	2-3

Chapter 3: Device Characterization

Task Overview	3-1
Task Setup	3-2
The Task	3-3

Chapter 4: Device Characterization with Swept Sine Mode

Task Overview	4-1
Task Setup	4-2
The Task	4-3

Chapter 5: Introduction to Octave Analysis

Task Overview	5-1
Task Setup	5-2
The Task	5-3

Index

Before You Begin

Introducing the HP 35665A Dynamic Signal Analyzer...

The Hewlett-Packard 35665A Dynamic Signal Analyzer is a two-channel FFT spectrum/network analyzer with a frequency range that extends from dc to just over 100 kHz. Although the HP 35665A is primarily a frequency-domain analyzer, you can also use it to make time-domain and amplitude-domain measurements.

The standard HP 35665A has three *instrument modes*. To extend measurement capability, there are three other optional instrument modes. An instrument mode is, in effect, an individual “personality” that configures the analyzer to make specific types of measurements. For example, in FFT Analysis mode, the analyzer functions as a standard low-frequency FFT spectrum/network analyzer. In Octave Analysis mode, the analyzer functions as a real-time, parallel-filter acoustics analyzer.

The standard HP 35665A is equipped with the following instrument modes:

- FFT Analysis.
- Correlation Analysis.
- Histogram/Time.

Additionally, your HP 35665A may be equipped with the following optional instrument modes:

- Octave Analysis.
- Order Analysis.
- Swept Sine.

To learn more about instrument modes, see the *HP 35665A Concepts Guide*.

Other Options

In addition to the extended measurement capability available with the optional instrument modes, there are other options available for the HP 35665A Dynamic Signal Analyzer. These include:

- HP Instrument BASIC
- Curve Fit/Synthesis
- External Keyboard
- Additional Memory (two or six Megabytes)
- Arbitrary Waveform Source

The HP 35665A at a Glance

For a detailed overview of the analyzer's front panel, see the *HP 35665A Operator's Reference*.

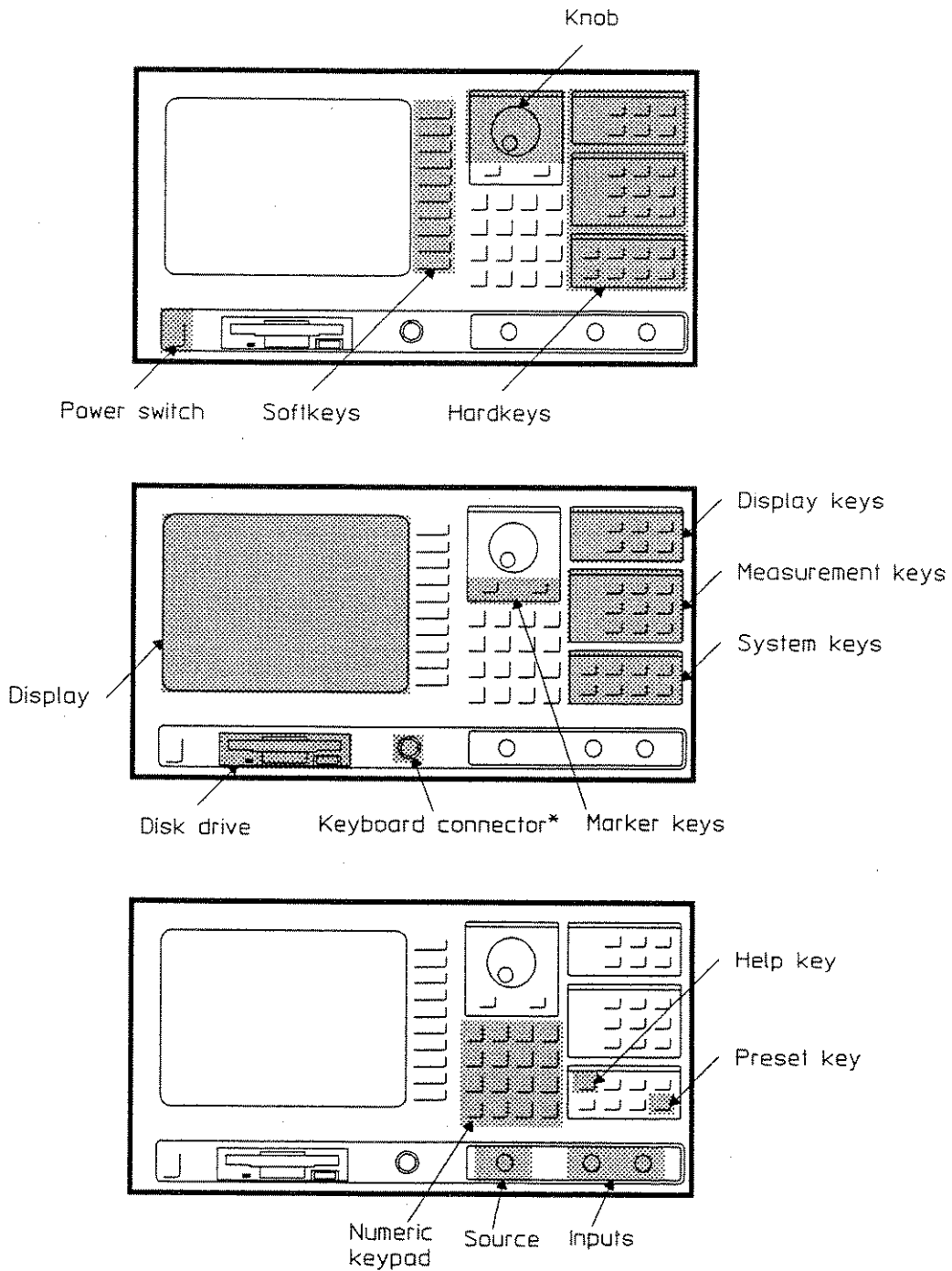

* may be rear-panel mounted on some instruments

Firmware Revision Date

This book should be used with HP 35665A Dynamic Signal Analyzers having firmware revision A.01.00. If your analyzer has significantly different firmware, contact your local HP Sales/Service office to obtain a documentation set that matches your firmware revision date.

Firmware revisions are significant *only if the first two digits in the firmware revision date are changed*. For example, A.01.00 indicates a significant change from A.00.00. However, a change to A.00.01 from A.00.00 indicates very minor changes that do not affect the documentation set.

To check your instrument's firmware revision date, press [**System Utility**] and then [**S/N VERSION**].

Need Assistance?

If you need assistance, contact your nearest Hewlett-Packard Sales and Service Office listed in the HP Catalog, or contact your nearest regional office listed at the back of this guide. If you are contacting Hewlett-Packard about a problem with your HP 35665A Dynamic Signal Analyzer, please provide the following information:

- Model number: HP 35665A
- Serial number:
- Firmware version:
- Options :
- Date the problem was first encountered:
- Circumstances in which the problem was encountered:
- Can you reproduce the problem?
- What effect does this problem have on you?

Notation Conventions

Hardkeys

Throughout this book, they are printed like this: [**Inst Mode**]. Hardkeys are front-panel buttons whose functions are always the same. Hardkeys have a label printed directly on the key itself.

Softkeys

Throughout this book, softkeys are printed like this: [FFT ANALYSIS]. Softkeys are keys whose functions change with the analyzer's current menu selection. A softkey's function is indicated by a video label to the left of the key (at the edge of the analyzer's screen).

Toggle Keys

Some keys toggle through different settings. Toggle softkeys have a highlighted word in their label that changes with each press of the softkey. Throughout this book, toggle softkeys are depicted as they *appear after you make the keypress*. For example, "toggle to [X-AXIS **LIN** LOG]" means to press [X-AXIS LIN/LOG] until the word LIN is highlighted.

There is only one toggle hardkey. This is the [**Pause-Cont**] hardkey.

Ghosted Softkeys

Occasionally, a softkey may be inactive—this occurs when a softkey is not appropriate for a particular measurement. When this happens, the analyzer "ghosts" the inactive softkey. For example, if you set the analyzer to one-channel mode, and then press [**Meas Data**], the [FREQUENCY RESPONSE] softkey will be ghosted. This is because frequency response measurements are only possible when the analyzer is in two-channel mode.

Where to find Additional Information

Using the [Help] key

The [Help] key on the analyzer's front panel provides fast, easy-to-read information about specific instrument controls and features. To use it, press [Help]. To exit, press [0] on the numeric keypad.

The [Help] key is a good way to learn about the analyzer, or to refresh your memory if you don't use the analyzer very often—particularly if you don't have the *Operator's Reference* near at hand. The help facility also has an index that lets you request information by key name or by topic.

The HP 35665A Documentation Set

In addition to the *HP 35665A Quick Start Guide*, there are other books that you will find useful. To learn about these, see the documentation map at the beginning of this book.

Demonstration Disc

Consider ordering the *HP Dynamic Signals Demo Disc* (HP part number 35665-95900). This contains captured signals from microphones and vibration transducers for 72 different types of signals. These may be helpful as you learn to use the HP 35665A Dynamic Signal Analyzer—particularly if you are interested in making acoustics or vibration measurements.

To use the demonstration disc, you simply connect a standard audio Compact Disc player to the analyzer's input connectors. Each disk is shipped with documentation to explain the signals and to offer appropriate measurement suggestions. For more information, contact your local Hewlett-Packard Sales and Service Office.

Application Notes

Additionally, you will find applications information in numerous Hewlett-Packard application notes. These are available from your local HP Sales and Service Office.

Using the Optional Keyboard...

The HP 35665A analyzer has a connector that lets you attach an optional alphanumeric keyboard. You can use the keyboard to perform the same functions as you would using the front-panel alpha keys—for example, when specifying filenames or when entering a trace title. And using the keyboard makes it much easier to edit HP Instrument BASIC programs.

It's important to know that the keyboard remains active *even when the analyzer is not in alpha entry mode*. This means that you can operate the analyzer using the external keyboard rather than the front panel. Pressing the appropriate keyboard key does the same thing as pressing a hardkey or a softkey on the analyzer's front panel.

Caution



Use only the approved keyboard for this product. Hewlett-Packard does not warrant damage or performance loss caused by a non-HP approved keyboard. Currently, approved Hewlett-Packard keyboards are as follows:

- U.S. ASCII (C1405A #ABA)
- U.K. English (C1405A #ABU)
- German (C1405A #ABD)
- French (C1405A #ABF)
- Italian (C1405A #ABZ)
- Spanish (C1405A #ABE)
- Swedish/Finnish (C1405A #ABS)

Note



In addition to the U.S. English keyboard, the HP 35665A Dynamic Signal Analyzer supports French, German, Italian, Spanish, U.K./English, and Swedish/Finnish keyboards. To configure your analyzer for a keyboard other than U.S. English, press [**System Utility**] [**KEYBOARD SETUP**]. Then press the appropriate softkey to select the language.

Configuring your analyzer to use a different keyboard only ensures that the analyzer recognizes the proper keys for that particular keyboard. Configuring your analyzer to use another keyboard *does not* localize the on-screen annotation or the analyzer's online HELP facility.

To learn more about the optional keyboard, see the *HP 35665A Operator's Reference*.

Source Characterization

Task Overview

This task shows you how to look at the analyzer's sine source output, measure its frequency, and measure its harmonic distortion. You will be using the analyzer's FFT Analysis mode.

What you will need:

- One connecting cable, 12 inches (30 cm) or longer; this should be a BNC male to BNC male cable.

What you will do:

- Look at a 10 kHz signal.
- Measure the frequency and amplitude of the fundamental.
- Look for the second harmonic of the fundamental frequency, and measure its amplitude.
- Learn how to use the relative marker.
- Learn how to use the analyzer's harmonic distortion marker function.

Task Setup

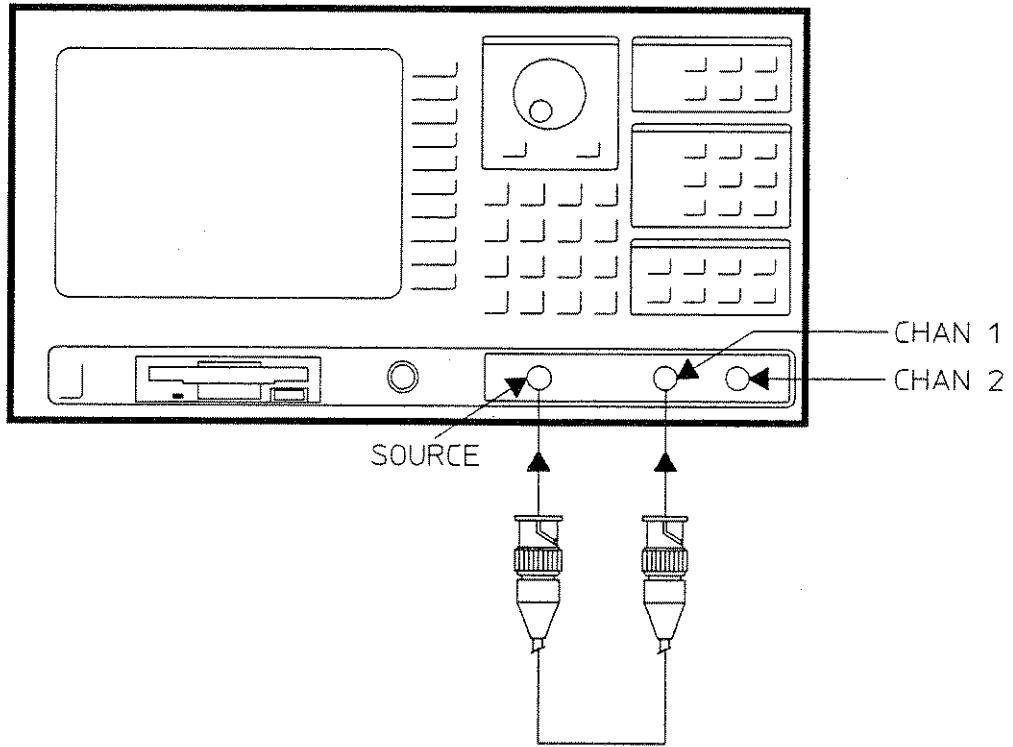

The Task

1. Connect the analyzer's source to the channel 1 input, as shown in the task setup illustration.
2. If the analyzer is turned off, turn it on.

Then press [**Preset**].

Now press [DO PRESET].

3. Press [**Source**].

Now toggle to [SOURCE **ON** OFF].

4. Press [**LEVEL**].

Now press [**0**] and then press [dBVrms].

For this task, we'll use the analyzer's internal sine source.

Presetting returns most of the analyzer settings to their default positions.

The [**Preset**] hardkey is green. It's the only hardkey that's green—this makes it easy to find.

This turns on the analyzer's source. The default source is a 10.24 kHz sine signal. However, the signal is not yet visible because its default output level is 0 volts.

This sets the sine source as close as possible to 0 dBVrms (1 Vrms). Entering a numeric value is a two-step process—first you enter the number with the numeric keypad, then you press a softkey to specify an appropriate unit suffix.

Source Characterization
The Task

- Now look at the analyzer's screen. You should see the fundamental and at least one harmonic.

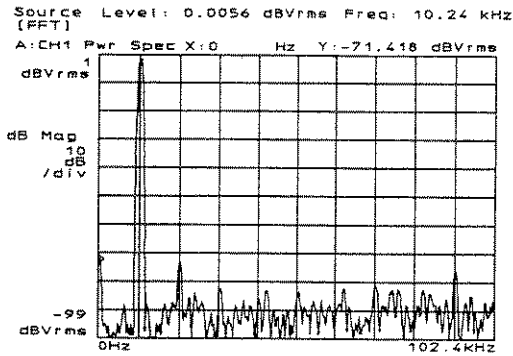

- Press [Avg].

Then toggle to [AVERAGE ON OFF].

- Press [Start].

The default frequency span is 0 Hz to 102.4 kHz. The 10.24 kHz test signal thus appears at the left side of the analyzer's display, near the the first graticule line from the left.

This turns on averaging. The default number of averages is 10. The analyzer shows the average count at the bottom of the display—this is updated after each average.

Note how another averaged measurement begins.

8. Press [Marker] and

press [MARKER TO PEAK].

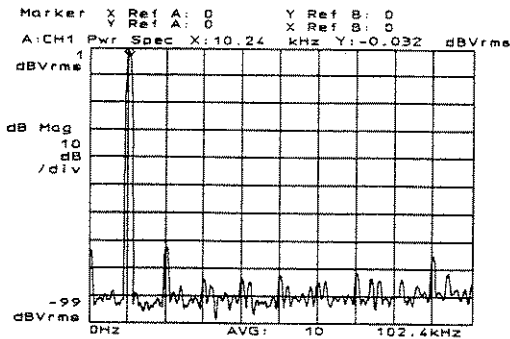

This brings up the marker menu and then moves the marker to the largest frequency component on the display—in this case, the 10.24 kHz fundamental.

The X-axis marker readout (at the top of the screen) verifies that this frequency is 10.24 kHz. The Y-axis marker readout shows that the amplitude of this component is 0 dBVrms.

The marker you are using is the *absolute marker*. It indicates the absolute x-axis and y-axis coordinate of the current marker position. There's also a *relative marker*—but you'll learn about that in a few moments.

9. Press [NEXT PEAK RIGHT].

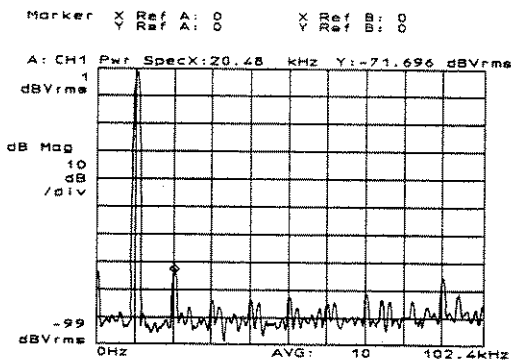

This moves the marker to the next largest frequency component on the display to the right of the previous marker position. In this case, the location should be around 20 kHz, the second harmonic.

Alternatively, you could turn the knob to move the marker to the second harmonic. The knob is also useful when entering numeric values, as we'll discover later.

Note the amplitude value indicated by the marker's Y-axis position. This value is about -72 dBVrms. Since the fundamental is about 0 dBVrms, the second harmonic is about 72 dB below the fundamental. This value is about -72 dBVrms. Since the fundamental is about 0 dBVrms, the second harmonic is about 72 dB below the fundamental.

Source Characterization
The Task

10. Press [MARKER TO PEAK] and
press [REFERENCE TO MARKER].

This turns on the relative marker and zeroes it at the marker current marker position. Both X and Y marker readouts are now set to zero—this point now becomes the reference.

11. Press [NEXT PEAK RIGHT].

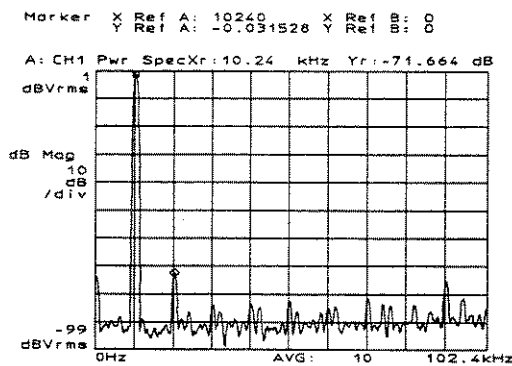

Note how the Y-axis marker readout indicates a relative reading of approximately -72 dB, and the X-axis marker shows the frequency offset from the fundamental (around 10 kHz in this case).

12. Press [MARKER TO PEAK] and
toggle to [MKR VALUE ABS REL].

This moves the marker back to the fundamental and turns off the relative marker. You have to turn off the relative marker, since you turned it on in step 10.

13. Press [Marker Fctn],

press [HARMONIC MARKER],

press [FUNDAMNTL FREQUENCY].

Press [Marker Value]. This hardkey is located in the numeric keypad.

Then press [THD].

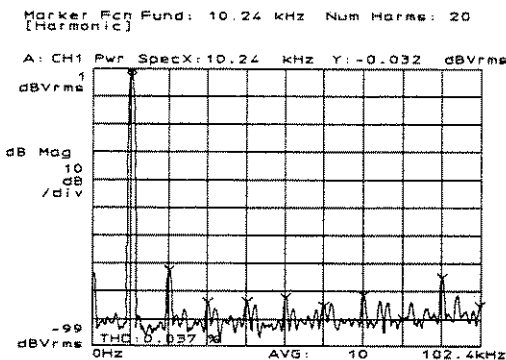

This turns on the harmonic distortion marker and sets the fundamental frequency to equal the current marker position—in this case, 10.24 kHz.

Pressing [THD] displays the results of the THD calculation. The results appear at the bottom left of the analyzer's display. In the example here, the THD should be about 0.03 percent.

Note the markers that appear over the harmonic frequencies. The "Num Harms" message that appears at the top of the screen shows the number of harmonics the analyzer used to calculate THD. Because you didn't specify a number, the analyzer will try to use the default value of 20 harmonics.

The THD results reflect the harmonics found in the current frequency span. The number of harmonics you specify is the *maximum* number the analyzer will use in the THD calculation. For example, if you press [NUMBER OF HARMONICS] and enter 15 harmonics, the THD calculation will not include all 15 harmonics if some of these harmonics are out of the range of the current span. (In the example shown here, there were less than 20 harmonics available, so less than 20 harmonics were used for the distortion calculation.)

The analyzer calculates THD by comparing the energy of the fundamental to the energy at the harmonics. Noise and other signals at other points along the frequency spectrum are not taken into account (unless they happen to occur at the fundamental frequency or at the harmonics). This is different than older distortion analyzers that simply rejected the fundamental frequency and measured any remaining energy as harmonic distortion (more accurately, harmonic distortion plus noise).

Device Characterization

Task Overview

This task shows you how to use the analyzer's FFT Analysis mode to make a typical network measurement. In this example, you'll be characterizing the analyzer's own built-in A-weight filter.

What you will need:

- Two connecting cables, 12 inches (30 cm) or longer; these should be BNC male to BNC male cables.
- One BNC "T" adapter.

What you will do:

- Look at the frequency response of a device-under-test.
- Find the peak of the frequency response.
- Measure the gain at the peak response.

Task Setup

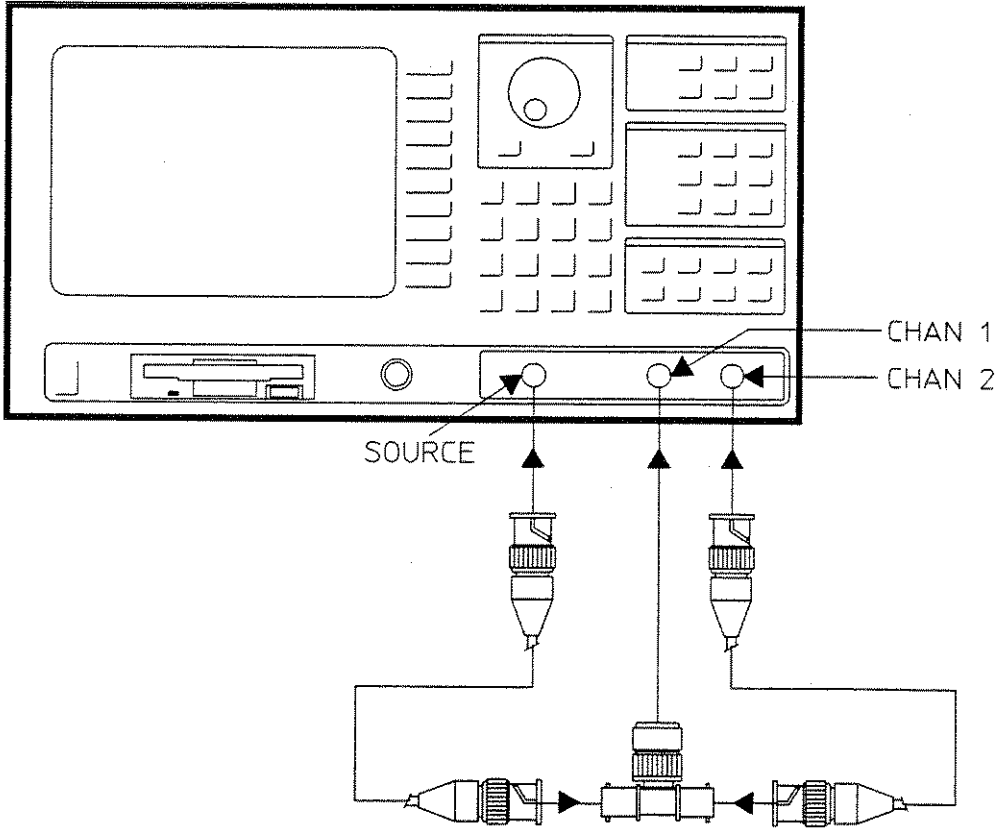

The Task

1. Connect the analyzer's source to the channel 1 and channel 2 inputs, as shown in the task setup illustration.
2. If the analyzer is turned off, turn it on.

Then press [**Preset**].

Now press [**DO PRESET**].

3. Press [**Inst Mode**] and press [**2 CHANNEL**].

4. Press [**Meas Data**] and press [**FREQUENCY RESPONSE**].

Normally, to characterize a device-under-test, you would connect the device-under-test between channel 1 and channel 2. For this measurement, however, our test device is the analyzer's internal channel 2 input A-weight filter. When you turn on the channel 2 A-weight filter, its location is between channel 1 and channel 2.

Presetting returns most of the analyzer settings to their default positions.

This configures the analyzer to make two channel measurements. Network measurements, such as device characterization, can only be made in two channel mode.

The [**Inst Mode**] hardkey is a darker gray than the other hardkeys, to make it easier to find.

This sets the display to show the frequency response trace for the current measurement.

Device Characterization
The Task

5. Press [Input] and

press [CHANNEL 2 SETUP].

Now toggle to

[A WT FLTR **ON** OFF].

This turns on the analyzer's channel 2 input A-weight filter. An A-weight filter is useful for acoustics measurements and for characterization of audio-frequency devices since its response simulates that of the human ear. To learn more about A-weighting, see the *HP 35665A Concepts Guide*.

6. Press [Source] and

press [BURST RANDOM].

Now toggle to [SOURCE **ON** OFF].

This turns on the analyzer's source and selects a burst random noise waveform. This is similar to random noise but is not continuous. Because a burst waveform is turned on and then off again during its operation, the analyzer can trigger from this type of waveform. In a few moments, we'll set the analyzer to trigger on this type of noise.

The burst random noise signal is not yet visible because its default output level is 0 volts.

7. Press [LEVEL].

Now press [1] and then
press [Vrms].

This sets the sine source as close as possible to 1 Vrms. Entering a numeric value is a two-step process—first you enter the number with the numeric keypad, then you press a softkey to specify an appropriate unit suffix.

8. Press [**Avg**].

Toggle to [AVERAGE **ON** OFF].

This turns on averaging. The default number of averages is ten. That's fine for this example.

9. Press [**Scale**].

Toggle to [AUTOSCALE **ON** OFF].

This turns on autoscaling.

Autoscaling means the analyzer automatically selects an appropriate scale for the currently displayed trace.

10. Press [**Trigger**] and

press [SOURCE TRIGGER].

Then press [**Window**] and

press [UNIFORM].

A triggered measurement can produce a more accurate characterization for some devices. In the example here, the combination of a triggered measurement and the uniform window selection produces a much more accurate response at the low end of the frequency spectrum, which is important for this type of filter.

“Windowing” is a concept basic to all FFT spectrum/network analyzers. To learn more about windowing, triggering, and the various source types, see the *HP 35665A Concepts Guide*.

11. Press [**Start**].

Note how another averaged measurement begins.

Device Characterization
The Task

12. Press [Marker] and

press [MARKER TO PEAK].

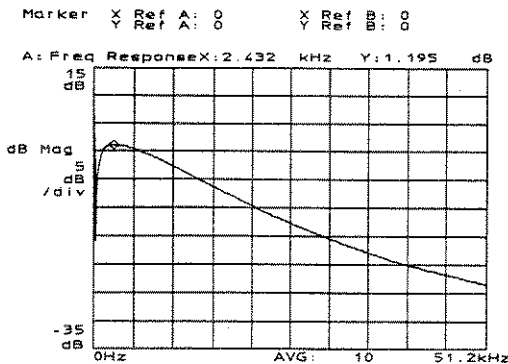

13. Press [Trace Coord].

Then toggle to [X-AXIS LIN LOG].

Move the marker with the knob to view the absolute gain/loss of this particular filter network at different frequencies.

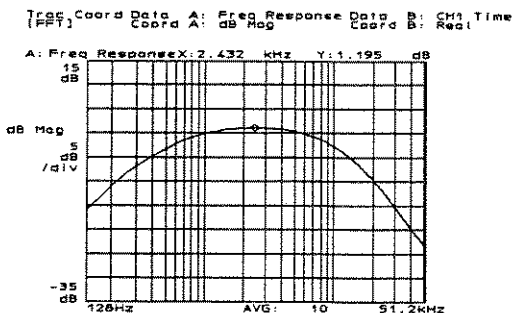

This moves the marker to the largest part of the frequency response trace. Because we are looking at a frequency response trace, the Y-marker indicates the gain (or loss) of the network-under-test.

Since we are using the *absolute* marker, the marker readouts indicate the absolute gain/loss of the network under test. To determine relative levels, you would use the *relative marker* which we introduced in chapter 2.

In the example here, the A-weight filter has a peak response of about plus 1.2 dB at approximately 2.4 kHz. Move the marker with the knob to view the absolute gain/loss of this particular filter network at different frequencies.

This displays the measurement data on a logarithmic scale. This is more useful for viewing the frequency response of an audio-frequency device.

As you move the marker with the knob, notice how the distance between each frequency resolution point is less as you move toward the right-hand side of the display. This is because the analyzer is displaying a measurement with linear resolution on a logarithmic scale.

To make a frequency response measurement with true logarithmic resolution—not just logarithmic X-axis scaling—you must use the analyzer's Swept Sine mode with a logarithmic sweep. We'll show you how to do that in the next chapter.

Device Characterization with Swept Sine Mode

Swept Sine measurements are available only with those HP 35665A analyzers that are equipped with Option 1D12. To see what options your HP 35665A analyzer has, press the [System Utility] hardkey and then press the [OPTIONS SETUP] softkey.

Task Overview

This task shows you how to use the analyzer's Swept Sine mode to make a typical network measurement. In this example, we will characterize the analyzer's own built-in A-weight filter. This task is nearly identical to the task in chapter 3 *except that you will be characterizing a device with a swept sine signal rather than a random noise waveform.*

What you will need:

- Two connecting cables, 12 inches (30 cm) or longer; these should be BNC male to BNC male cables.
- One BNC "T" adapter.

What you will do:

- Look at the frequency response of a device-under-test.
- Find the peak of the frequency response.
- Measure the gain at the peak response.

Task Setup

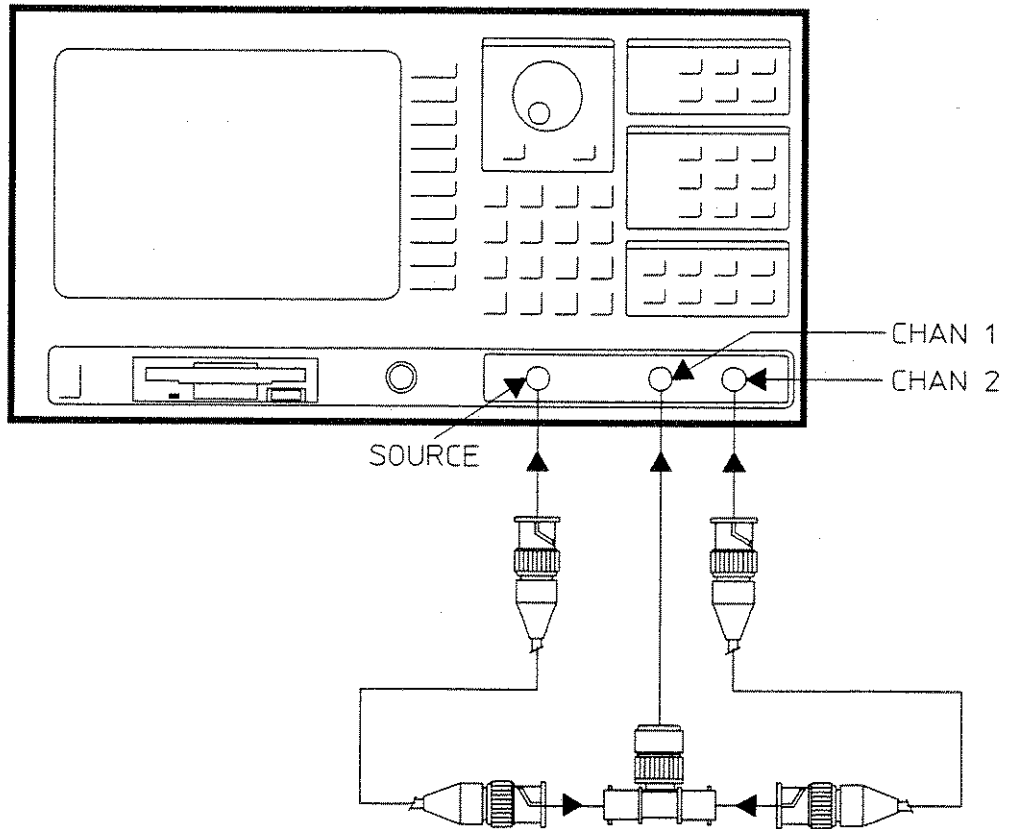

The Task

1. Connect the analyzer's source to the channel 1 and channel 2 inputs, as shown in the task setup illustration.
2. If the analyzer is turned off, turn it on.

Then press [Preset].

Now press [DO PRESET].

3. Press [Inst Mode] and press [SWEPT SINE].

Normally, to characterize a device-under-test, you would connect the device-under-test between channel 1 and channel 2. For this measurement, however, our test device is the analyzer's internal channel 2 input A-weight filter. When you turn on the channel 2 A-weight filter, its location is between channel 1 and channel 2.

Presetting returns most of the analyzer settings to their default positions.

This configures the analyzer to make swept sine measurements. Notice how the [1 CHANNEL] softkey is ghosted—this is because the analyzer operates only in 2 channel mode when making swept sine measurements.

Device Characterization with Swept Sine Mode
The Task

4. Press [**Input**] and

press [CHANNEL 2 SETUP].

Now toggle to

[A WT FLTR **ON** OFF].

This turns on the analyzer's channel 2 input A-weight filter—we could use an external A-weight filter and get the same results, but it's more convenient to use the analyzer's built-in filter.

An A-weight filter is useful for acoustics measurements and for characterization of audio-frequency devices since its response simulates that of the human ear. To learn more about A-weighting, see the *HP 35665A Concepts Guide*.

5. Press [**Source**] and

press [LEVEL].

Now press [1] and then
press [Vrms].

This sets the sine source as close as possible to 1 Vrms. Entering a numeric value is a two-step process—first you enter the number with the numeric keypad, then you press a softkey to specify an appropriate unit suffix.

6. Press [Freq].

Toggle to [SWEEP LIN LOG].

This selects a logarithmic sweep. This is useful for characterizing the swept response of an audio-frequency device.

When you select a logarithmic sweep, the analyzer automatically switches to a logarithmic X-axis when you press [Start].

7. Press [Start].

This starts the swept sine measurement. Notice how the analyzer automatically changed to a logarithmic X-axis.

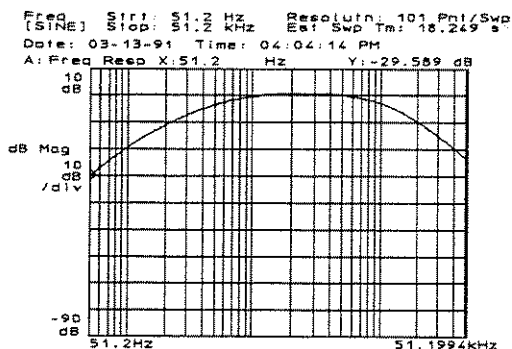

If you wanted to use a linear X-axis for a log sweep, you'd have to press [Trace Coord] and toggle to [X-AXIS LIN LOG].

8. Wait until the analyzer finishes a sweep.

Then press [Scale] and toggle to [AUTOSCALE ON OFF].

The **OV2** indicator flashes, showing that the analyzer is autoranging during the measurement to provide the best signal-to-noise ratio.

This turns on autoscaling.

Autoscaling means the analyzer automatically selects an appropriate scale for the currently displayed trace.

Device Characterization with Swept Sine Mode
The Task

9. Press [Marker] and

press [MARKER TO PEAK].

Move the marker with the knob to view the absolute gain/loss of this particular filter network at different frequencies.

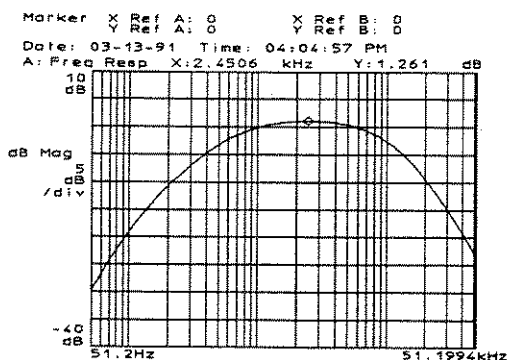

This moves the marker to the largest part of the frequency response trace. Because we are looking at a frequency response trace, the Y-marker indicates the gain (or loss) of the network-under-test.

In the example here, the A-weight filter has a peak response of about plus 1.2 dB at approximately 2.4 kHz.

Since we are using the *absolute* marker, the marker readouts indicate the absolute gain/loss of the network under test. To determine relative levels, you would use the *relative marker* which we introduced in chapter 2.

As you move the marker with the knob, notice how the distance between each frequency resolution point is the same no matter where you move the marker. This is because you used a logarithmic sweep to make this measurement and a logarithmic X-axis to display it.

Introduction to Octave Analysis

Octave measurements are available only with those HP 35665A analyzers that are equipped with Option 1D1. To see what options your HP 35665A analyzer has, press the [System Utility] hardkey and then press the [OPTIONS SETUP] softkey.

Task Overview

This task introduces the analyzer's Octave mode and demonstrates the difference between *random noise* and *pink noise*. You will also see the effects of switching in the analyzer's built-in A-weight filter.

What you will need:

- One connecting cable, 12 inches (30 cm) or longer; this should be a BNC male to BNC male cable.

What you will do:

- Select the analyzer's Octave Analysis mode and look at full-octave (1/1), third-octave (1/3), and twelfth-octave (1/12) displays.
- Examine the spectra of white noise and pink noise and contrast the two.
- Select the analyzer's A-weight filters and view the effects of this filter on pink noise.

Task Setup

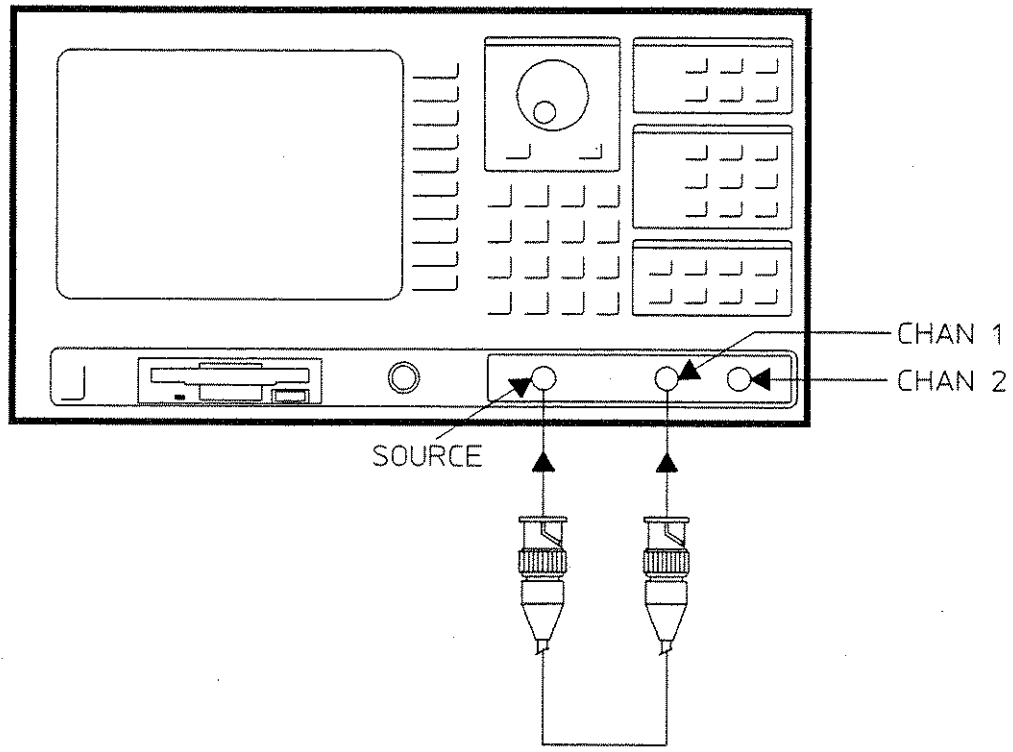

The Task

1. Connect the analyzer's source to the channel 1 input, as shown in the task setup illustration.
2. If the analyzer is turned off, turn it on.

Then press [**Preset**].

Now press [DO PRESET].

3. Press [**Inst Mode**] and
press [OCTAVE ANALYSIS].

For this task, we'll be using the analyzer's internal source to generate both random noise and pink noise waveforms.

Presetting returns most of the analyzer settings to their default positions.

This configures the analyzer to make octave measurements. Notice how the X-axis is automatically changed to a logarithmic scale—octave measurements are always made on a logarithmic scale.

Octave mode is different than the analyzer's other instrument modes since it makes measurements that simulate proportional bandwidth filters. This provides resolution that is equal across each octave span.

The default resolution for Octave mode is third octave (1/3). This is standard for many acoustics measurements. Also available are full octave (1/1) resolution and twelfth octave (1/12) resolution.

Introduction to Octave Analysis
The Task

4. Press [**Source**] and

press [**RANDOM NOISE**].

Now toggle to [**SOURCE ON OFF**].

5. Press [**LEVEL**].

Now press [**1**] and then
press [**Vrms**].

6. Press [**Freq**] and

press [**FULL OCTAVE**].

7. Press [**Pause-Cont**].

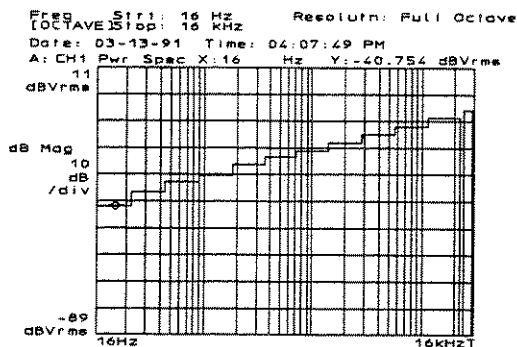

This turns on the analyzer's source and selects the random noise waveform. The random noise signal is not yet visible because its default output level is 0 volts.

This sets the noise level as close as possible to 1 Vrms.

Entering a numeric value is a two-step process—first you enter the number with the numeric keypad, then you press a softkey to specify an appropriate unit suffix.

This selects full octave mode and will make it easier for you to compare the difference between random noise and pink noise.

This pauses the current measurement. It's easier to read marker values if you pause the measurement first.

Some type of averaging is always used for octave measurements—the default average type is exponential.

- Using the knob, move the marker to the rightmost octave (16 kHz).

- Press [Marker] and

press [REFERENCE TO MARKER].

- Slowly turn the knob to jump from octave to octave.

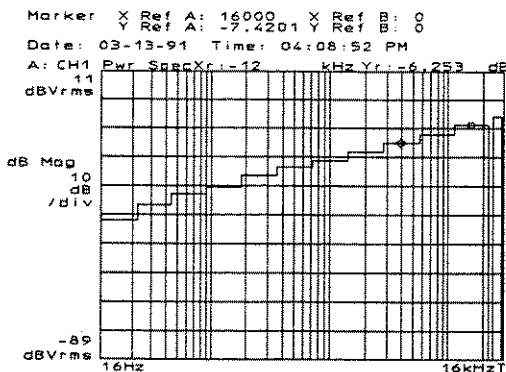

- Press [Source] and

press [PINK NOISE].

There are 11 octaves used in the current measurement. The narrow bar to the extreme right of the display does not represent an octave. Rather, it represents the total energy within all displayed octaves.

Note the letter "T" under the rightmost bar—this represents total acoustic energy.

This turns on the relative marker and zeroes it at the marker current marker position. The marker readouts are now relative to this position.

Notice how as you move to octaves at lower frequencies, the power in each octave decreases by approximately 3 dB per octave.

Random noise—often called *white noise* or *gaussian noise*—has its energy distributed equally across all frequencies (constant bandwidth). In contrast, *pink noise* has its energy distributed equally per octave (proportional bandwidth). In a moment, we'll demonstrate the difference between these two noise sources.

This selects the analyzer's pink noise source.

As we mentioned earlier, pink noise differs from random (white) noise in that pink noise has more energy at lower frequencies. This produces a signal that has equal energy per octave (proportional) bandwidths.

Introduction to Octave Analysis
The Task

12. Press [Start].

This begins a new series of averaged octave measurements.

13. Press [Pause-Cont].

Now, slowly turn the knob to jump to the rightmost octave.

14. Press [Marker] and .

press [REFERENCE TO MARKER].

This zeroes the relative marker to a new value, at the highest octave.

15. Again, slowly turn the knob. As you move the marker, notice how the power is nearly equal at each octave.

This demonstrates that pink noise provides equal excitation across all octave bands. This is different from random noise, where power distribution changed by 3 dB per octave.

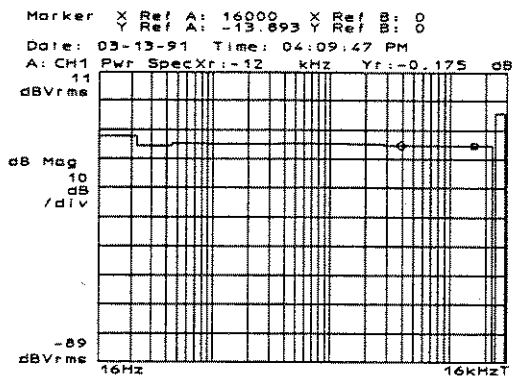

16. Press [Input] and

press [CHANNEL 1 SETUP].

Then toggle to

[A WT FLTR **ON** OFF].

17. Press [Start].

18. To get better resolution, press
[Freq] and press [1/3 OCTAVE] or
[1/12 OCTAVE].

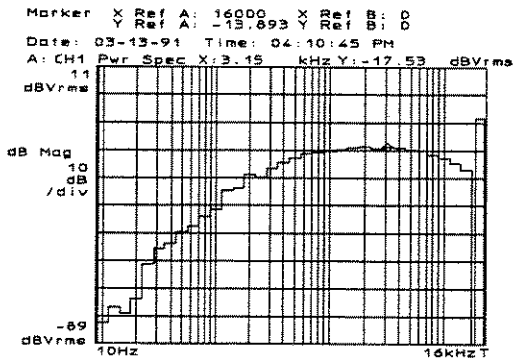

This turns on the analyzer's channel 1 input A-weight filter. An A-weight filter is useful for acoustics measurements and for characterization of audio-frequency devices since its response simulates that of the human ear.

You can also apply a weighting function *after* making a measurement—by using an A-, B-, or C-weighting math operation.

This begins a new series of averaged octave measurements. But this time, you will see the response of the A-weight filter. This is similar to the results of the swept sine task in chapter 4.

In addition to full-octave measurements, the HP 35665A also makes third-octave and twelfth-octave measurements.

Index

A

A-weight filter 3-4
absolute marker
 See marker, absolute
autoscaling 3-5
averaging 2-4

D

demonstration disc 1-5
device characterization
 FFT mode 3-1
 swept sine mode 4-1

F

frequency response measurements
 See device characterization

H

hardkey, toggle 1-4
hardkeys 1-4
HELP key 1-5

I

instrument modes 1-1

K

keyboard, optional 1-6

L

logarithmic resolution 3-6
logarithmic scale 3-6
logarithmic sweep 4-5

M

marker
 absolute 2-5
 harmonic distortion 2-7
 relative 2-6

N

numeric values, entering 2-3

O

octave mode 5-1
offset marker
 See marker, relative

P

pink noise 5-5

R

random noise 5-5
relative marker
 See marker, relative

S

softkeys 1-4
 ghosted 1-4
 toggle 1-4
source characterization 2-1

T

toggle keys
 See softkeys, toggle
triggered measurements 3-5

W

windowing 3-5

