

Agilent 35670A Quick Start Guide

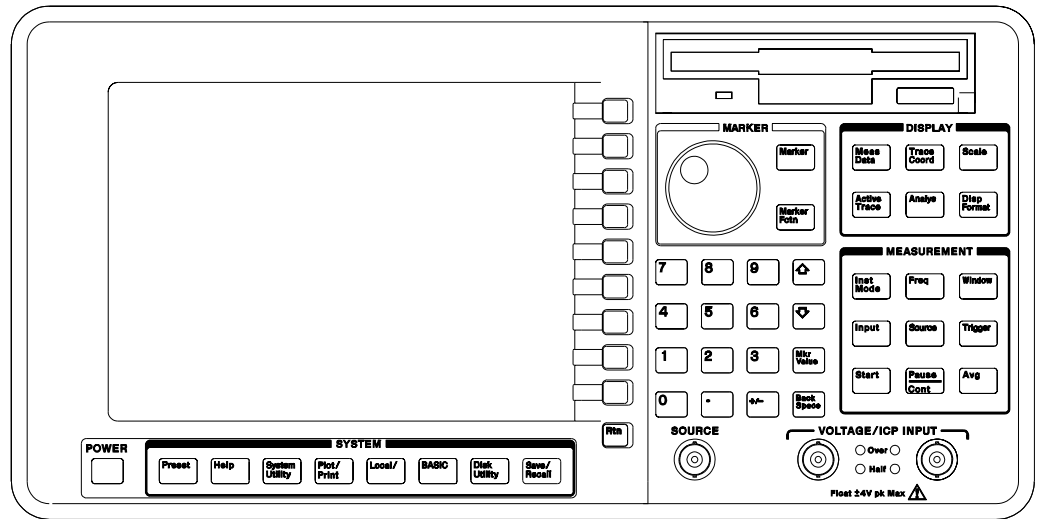

Agilent Part Number 35670-90056
Printed in U.S.A.

Print Date: October 2000

© Agilent Technologies, Inc., 1992, 1995, 2000. All rights reserved.
8600 Soper Hill Road Everett, Washington 98205-1209 U.S.A.

The Agilent 35670A at a Glance (Front Panel)

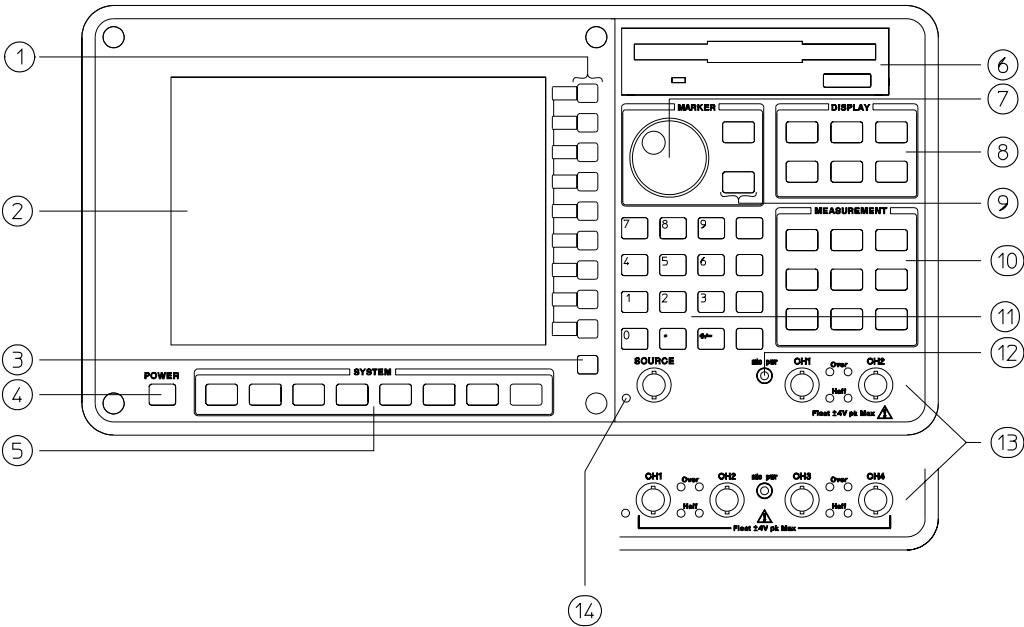

Agilent 35670A Front Panel

1-Use the softkeys to select items from the current menu. A softkey's function is indicated by a video label on the analyzer's screen. Throughout this book, softkeys are printed like this: [FFT ANALYSIS].

Hardkeys are front-panel buttons whose functions are always the same. They have a label printed directly on the key itself. Throughout this book, hardkeys are printed like this: [**Inst Mode**].

2-The analyzer's screen is divided into the menu area and the display area. The menu area displays video labels for the softkeys. The data area displays measurement data and information about the parameter settings.

3-The [**Rtn**] key returns the menu to the previous level.

4 -The POWER switch turns on the analyzer.

5 -Use the SYSTEM keys to control various system-level functions. These functions include saving files, plotting measurement data, and accessing online help.

6 -Use the disk drive to save your work on 3.5 inch flexible disks.

7-The knob moves the markers and the cursor. It also steps through numeric values and scrolls through online help.

8 -Use the DISPLAY keys to control what appears on the analyzer's traces. They only affect how data is displayed; DISPLAY keys do not change measurement parameters. *You can press keys in the DISPLAY menus without losing measurement parameters.*

9 -Use the MARKER keys to select a variety of marker features.

10-Use the MEASUREMENT keys to control the analyzer's source and inputs. They also control measurement parameters. *You must make a new measurement if you change a MEASUREMENT parameter.*

11-Use the numeric-entry keys to enter a numeric value.

12-The microphone power connector provides power (8 Vdc) for the Microphone Adapter Kit (Option UK4).

13-The connector area of the front panel has two different configurations. The standard analyzer has a source output connector and two input connectors. The 4-channel analyzer (Option AY6) has four input connectors.

Range indicators are located next to each input connector. The upper LED is the over-range indicator (the signal level exceeds the current range setting). The lower LED is the half range indicator (the signal level exceeds half the current range setting).

14-A source on/off indicator is located at the left edge of the connector area.

The standard Agilent 35670A (2-channel) has a source connector on the front panel.

The Agilent 35670A at a Glance (Rear Panel)

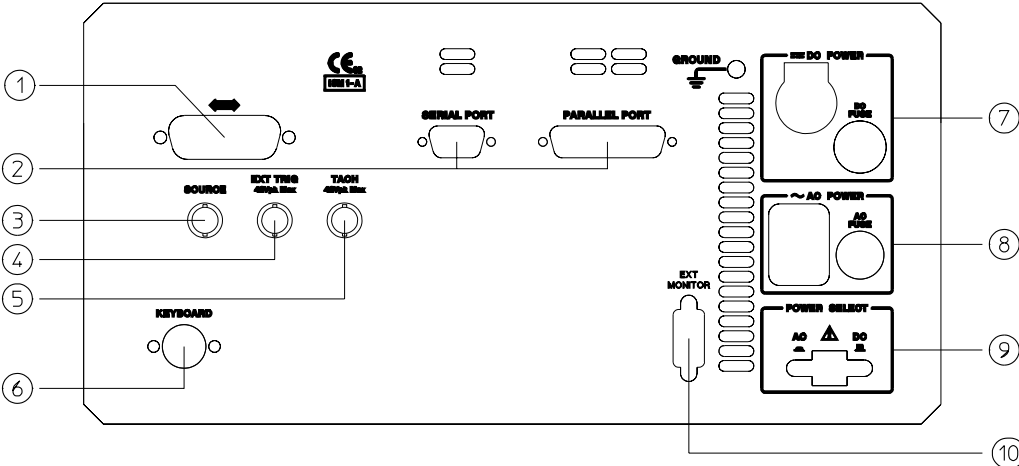

Agilent 35670A Rear Panel

1-The GPIB connector links the Agilent 35670A to other GPIB devices. GPIB parameters are set in the [Local/GPIB] and [Plot/Print] menus.

2-The SERIAL PORT and the PARALLEL PORT link the analyzer to plotters and printers. These parameters are set in the [Plot/Print] menu.

3-The SOURCE connector outputs the analyzer's source signal. An LED on the front panel indicates if the source is on or off. The source parameters are set in the [Source] menu.

The standard Agilent 35670A (2-channel) also has a source connector on the front panel.

4-The EXT TRIG connector links the analyzer to an external trigger signal. The external trigger parameters are set in the [Trigger] menu.

5-The TACH connector links the analyzer to a tachometer. The tachometer parameters are set in the [Input] menu.

6-The KEYBOARD connector attaches an optional keyboard to the analyzer.

7-The DC POWER connector accepts DC power levels from 12 - 28 Vdc (nominal).

8-The AC POWER connector accept a wide range of ac voltage levels.

9-The POWER SELECT switch determines whether the analyzer is powered via the AC POWER connector or the DC POWER connector.

10-The EXT MONITOR port links the analyzer to multi-sync monitors.

Safety Summary

The following general safety precautions must be observed during all phases of operation of this instrument. Failure to comply with these precautions or with specific warnings elsewhere in this manual violates safety standards of design, manufacture, and intended use of the instrument. Agilent Technologies, Inc. assumes no liability for the customer's failure to comply with these requirements.

GENERAL

This product is a Safety Class 1 instrument (provided with a protective earth terminal). The protective features of this product may be impaired if it is used in a manner not specified in the operation instructions.

All Light Emitting Diodes (LEDs) used in this product are Class 1 LEDs as per IEC 60825-1.

ENVIRONMENTAL CONDITIONS

This instrument is intended for indoor use in an installation category II, pollution degree 2 environment. It is designed to operate at a maximum relative humidity of 95% and at altitudes of up to 2000 meters. Refer to the specifications tables for the ac mains voltage requirements and ambient operating temperature range.

BEFORE APPLYING POWER

Verify that the product is set to match the available line voltage, the correct fuse is installed, and all safety precautions are taken. Note the instrument's external markings described under Safety Symbols.

GROUND THE INSTRUMENT

To minimize shock hazard, the instrument chassis and cover must be connected to an electrical protective earth ground. The instrument must be connected to the ac power mains through a grounded power cable, with the ground wire firmly connected to an electrical ground (safety ground) at the power outlet. Any interruption of the protective (grounding) conductor or disconnection of the protective earth terminal will cause a potential shock hazard that could result in personal injury.

FUSES

Only fuses with the required rated current, voltage, and specified type (normal blow, time delay, etc.) should be used. Do not use repaired fuses or short-circuited fuse holders. To do so could cause a shock or fire hazard.

DO NOT OPERATE IN AN EXPLOSIVE ATMOSPHERE

Do not operate the instrument in the presence of flammable gases or fumes.

DO NOT REMOVE THE INSTRUMENT COVER

Operating personnel must not remove instrument covers. Component replacement and internal adjustments must be made only by qualified service personnel.

Instruments that appear damaged or defective should be made inoperative and secured against unintended operation until they can be repaired by qualified service personnel.

WARNING

The WARNING sign denotes a hazard. It calls attention to a procedure, practice, or the like, which, if not correctly performed or adhered to, could result in personal injury. Do not proceed beyond a WARNING sign until the indicated conditions are fully understood and met.

Caution

The CAUTION sign denotes a hazard. It calls attention to an operating procedure, or the like, which, if not correctly performed or adhered to, could result in damage to or destruction of part or all of the product. Do not proceed beyond a CAUTION sign until the indicated conditions are fully understood and met.

Safety Symbols



Warning, risk of electric shock



Caution, refer to accompanying documents



Alternating current



Both direct and alternating current



Earth (ground) terminal



Protective earth (ground) terminal



Frame or chassis terminal



Terminal is at earth potential.



Standby (supply). Units with this symbol are not completely disconnected from ac mains when this switch is off

Table of Contents

The Basics 1

- To turn on the analyzer — AC power 2
- To turn on the analyzer — DC Power 3
- To display help for a key 4
- To preset the analyzer 5
- To activate the input channels 6
- To activate the input channels—Option AY6 7
- To select an instrument mode 8
- To type a text string 9
- To change a numeric parameter 10
- To move the main marker 11
- To measure a value relative to a reference 12

Setting Up 13

- To set the analyzer's GPIB address 14
- To set the analyzer's clock 15
- To select the default disk 16

Working with the Display 17

- To select the active trace 18
- To display traces 19
- To select measurement data 20
- To scale measurement data 22
- To display the measurement state 23
- To change parameters using the measurement state 24
- To display a waterfall 25

Making Measurements 27

- To measure a spectrum 28
- To measure frequency response — FFT 30
- To measure frequency response — Swept Sine (Option 1D2) 32
- To calibrate a microphone — Octave Analysis (Option 1D1) 34
- To measure sound pressure level — Octave Analysis (Option 1D1) 36
- To measure harmonic distortion 38
- To characterize a tach pulse 40
- To specify tachometer holdoff time 42
- To measure an order spectrum 44

Saving and Plotting Data 47

- To format a flexible disk 48
- To save a trace to a file 49
- To recall a trace from a file 50
- To save a trace to a data register 51
- To setup your plotter — GPIB 52
- To setup your plotter — Serial 53
- To plot screen contents 54

Automating Measurements 55

- To select the active Instrument BASIC program 56
- To record a measurement sequence 57
- To execute a recorded measurement sequence 58
- To customize your analyzer 59
- To save an Instrument BASIC program to disk 60

Index

Guide to 35670A Documentation

Need Assistance?

About this Edition

The Basics

To turn on the analyzer — AC power

- 1 Depress the power select switch on the rear panel to select “AC” power.
- 2 Connect the power cord to the analyzer.
- 3 Depress the power switch.

The power switch is located in the lower-left corner of the front panel.

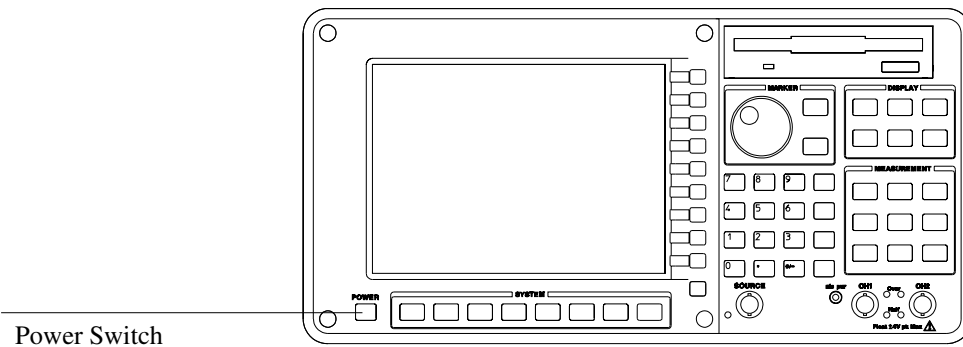
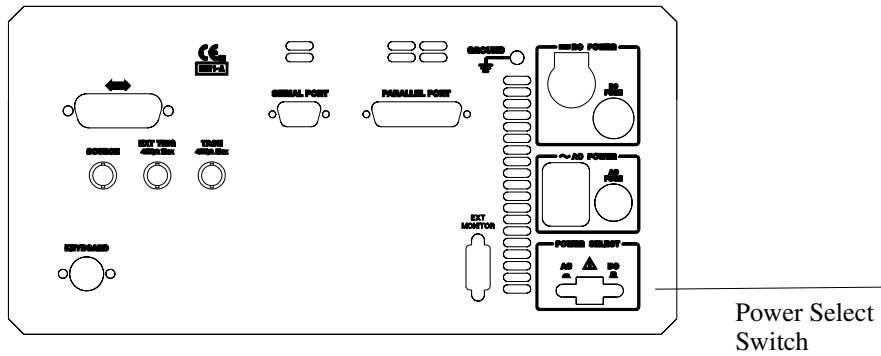

To display help for a key

- 1 Press [HELP].
- 2 Press any hardkey or softkey.
- 3 Press the down-arrow or up-arrow hardkey to page.
or
Turn the knob to scroll.
- 4 Repeat steps 2 and 3 for each key you want help on.
- 5 Press [HELP] to quit online help.

The first time you press , take a few minutes to read the help overview. It is only four pages long, and it includes descriptions of advanced help features—like the index and cross-reference “links”—that can help you locate the information you need quickly.

When you quit help, the analyzer restores the menu that was displayed before you activated help.

Title shows you which topic is displayed

```

Topic: Help hardkey

How to use online Help

-----
To do this:                               Press this key:
-----
Turn help on.....[ Help ]
Turn help off.....[ 0 ]
Get help on a key.....[ <key> ]
Jump to a topic.....[ 4 ]
Return to previous topic.....[ 7 ]
Go to index.....[ 1 ]
Display next page.....[ down arrow ]
Display previous page.....[ up arrow ]
Select help topic or link.....Turn the knob
Print the current screen.....[ 8 ]

Highlighted or underlined text indicates a link to other
help text. See page 3 ("Displaying help on a related
topic") for information on using links.

See the next pages for detailed instructions on using
online help. (Press the down arrow key to display the
next page.)

-----
Prev Topic-7      Print-8      Prev Page-↑      Index-1
Jmp To Topic-4   Help On Help-5  Next Page-↓      Quit-0
    
```

Scroll bar indicates how much of the topic is displayed

Legend shows you which help functions are assigned to the numeric keypad

To preset the analyzer

- 1 Press [**Preset**].
- 2 Press [**DO PRESET**].

You can preset the analyzer to return it to a known state. This known state provides a convenient starting point when you are setting up a new measurement.

The following illustration lists the states of important parameters after you preset the analyzer. You can display this listing on your analyzer by pressing [**Disp Format**] [MEASURMNT STATE].) For more information on the analyzer’s preset state, use online help. To define your own preset state, see “To customize your analyzer,” in the *Automating Measurements* section.

Disp Frmat

```

Inst Mode  FFT
           Measurement Source
Channels 2
           INPUT
Meas Data  Data A   PWR SPEC1
           Data C   TIME1
           Data B   PWR SPEC2
           Data D   TIME2
Trac Coord Coord A  MLINEAR
           Coord C  REAL
           Coord B  MLINEAR
           Coord D  REAL
Freq       Start   0 Hz
           Center  25.6 kHz
           Rec Len 7.81 ms
           Stop    51.2 kHz
           Span    51.2 kHz
           Resoltn 400
Window     CH1 Type FLATTOP
           CH2 Type FLATTOP
           BW      488.88 Hz
           BW      488.88 Hz
Avg        Status  OFF
           Number  10
           Fast Avg OFF
           Rept Avg FREEZE
           Type    RMS
           Overlap 0 %
           Update  5
           Ovid Rej OFF
Trigger    Type    IMMEDIATE
           Slope   POSITIVE
           Ext lvl  1.48 V
           Ext fltr OFF
           CH1 Delay 0 s
           Level   0 V
           CH2 Delay 0 s
    
```

Measurement State
after pressing
[Preset] [Do Preset]

To activate the input channels

- 1 Press [Inst Mode].
- 2 Press [CHANNELS 1 2] to highlight 1 for a one channel measurement.

This selection must be made before the measurement is started. If you change the number of input channels, you must restart the measurement. At preset, the analyzer is set to measure with two channels.

Channel 1 is the reference channel for measurement results that require data for two channels.

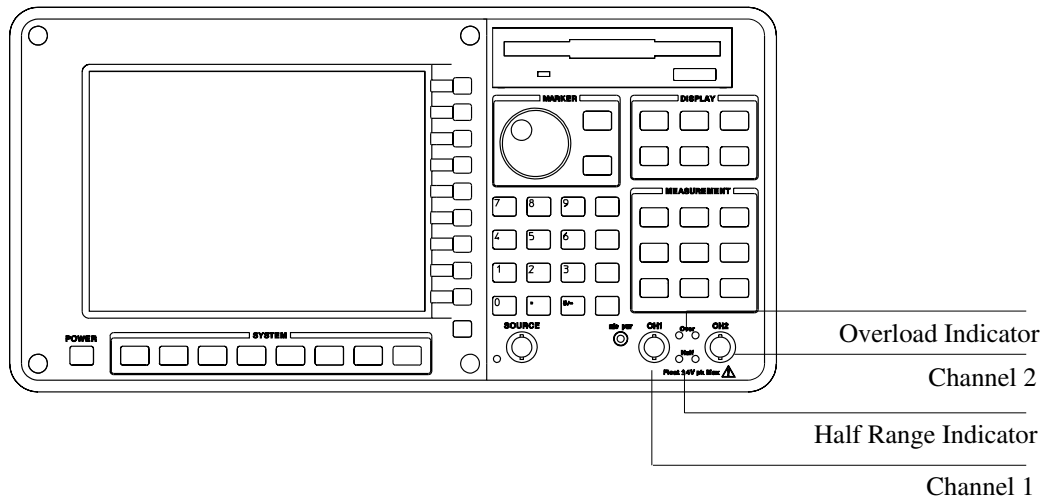

To activate the input channels—Option AY6

- 1 Press [Inst Mode].
- 2 Press [CHANNELS 1 2 4] to highlight 4 for a four channel measurement. Press it again to highlight 1 for a single channel measurement.
- 3 If you want to make Channel 3 the reference channel to Channel 4, press [REF CHANS 1 1,3] to highlight 1,3.

This selection must be made before the measurement is started. If you change the number of input channels, you must restart the measurement. At preset, the analyzer is set to measure with two channels.

Channel 1 is the default reference channel. If you want to use channel pairs, set Channel 3 as the reference to Channel 4. Channel 1 remains the reference to Channel 2.

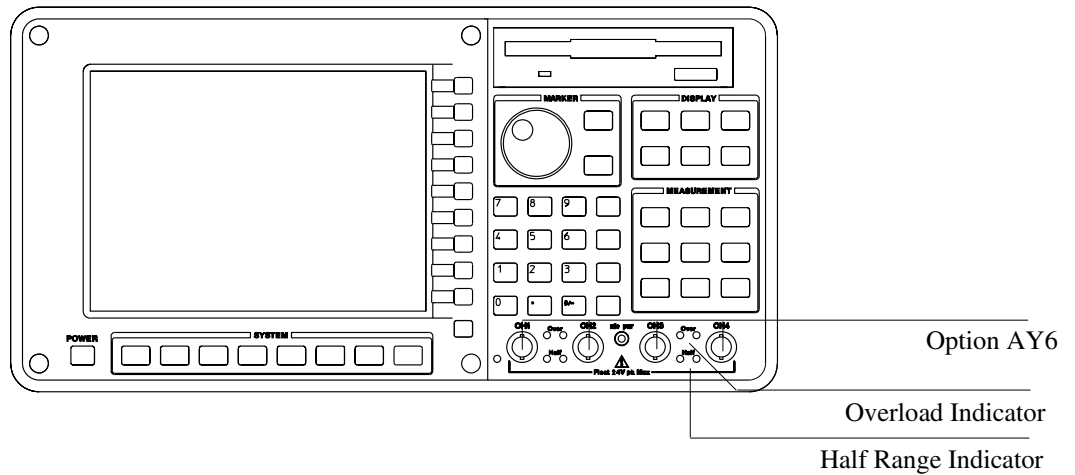

To select an instrument mode

- 1** Press [**Inst Mode**].
- 2** Press [FFT ANALYSIS].
 - or
 - Press [OCTAVE ANALYSIS] to select Realtime Octave Measurements (Option 1D1 only).
 - or
 - Press [ORDER ANALYSIS] to select Computed Order Tracking (Option 1D0 only).
 - or
 - Press [SWEPT SINE] to select Swept Sine Measurements (Option 1D2 only).
 - or
 - Press [CORRELATN ANLYSIS].
 - or
 - Press [HISTOGRAM/TIME] to select histograms and time domain.

The analyzer can make measurements that fall into six broad categories, some available as special options. These categories are called instrument modes.

You should select an instrument mode before specifying other measurement parameters. *Instrument modes are not coupled.* Parameters set in one instrument mode are independent of parameters set in the other modes.

For more information on the six instrument modes, use online help.

To type a text string

- 1 Plug in the optional keyboard.
- 2 Press a softkey that displays a text prompt box. (For example, press [Save/Recall], [SAVE DATA], [SAVE TRACE], [INTO FILE].)
- 3 Type the text. All characters—alpha, numeric and special—are enabled.
- 4 Use the [BACK SPACE] key or cursor keys one or more times if you make a mistake.
- 5 Press [ENTER] to accept the string you typed.

You do not need the optional keyboard to enter a text string. The analyzer enters alpha-entry mode when you press a softkey that displays a text prompt. While the analyzer is in this mode

- Most front-panel hardkeys are remapped as alpha characters.
- The numeric keypad is active.
- The alpha-entry menu gives you access to special characters and other typing functions.

For more information on alpha-entry mode, use online help. (Alpha-entry mode can be accessed through the online help index.)

Each remapped hardkey inserts the character adjacent to its lower-right corner

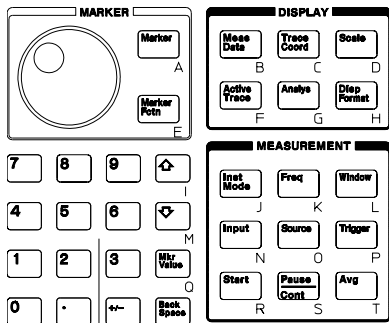

This text prompt is displayed when you press [SAVE TRACE]

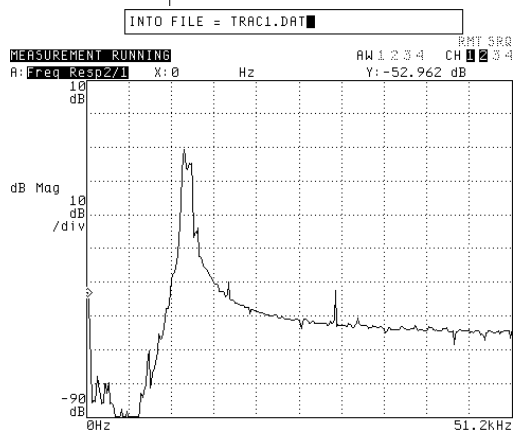

[UPPERCASE lowercase] works like CAPS LOCK on a keyboard

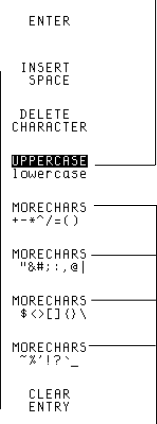

[Back Space] backs up over mistakes

Numeric hardkeys insert numbers

MORECHARS softkeys insert special characters

To change a numeric parameter

- 1 Press a softkey that displays a numeric-entry prompt box (for example [SPAN] in the [Freq] menu).
- 2 Press one of the arrow hardkeys.
or
Type a value with the optional keyboard.
or
Turn the knob before the prompt box disappears.
or
Type a value with the numeric keypad.
- 3 If you typed a number, press a unit softkey or [ENTER] to complete the entry .
If you are using an optional keyboard, press the corresponding function key.

When you press a softkey that controls a numeric parameter, the analyzer activates the key (indicated by highlighting the softkey) and displays a numeric-entry prompt box. The prompt box is removed after a short time if you do not change the value, *but the softkey remains active*. An active softkey is always ready to accept entry from the arrow keys or numeric keypad, even when the prompt box is not displayed.

The arrow hardkeys and the knob change a numeric parameter by stepping it through successive values. In some cases, you can specify the size of the step. The knob is more convenient if you need to step a parameter quickly through many successive values, but the prompt box must be displayed before you start turning the knob.

This numeric-entry prompt is displayed when you press [Freq] [Span]

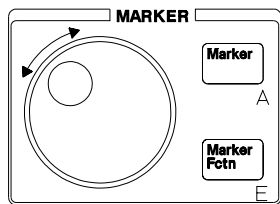

Increase a value by turning the knob clockwise or pressing the up-arrow hardkey

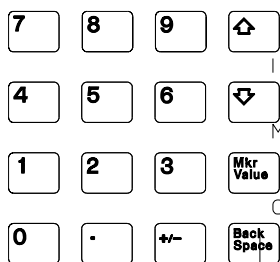

Decrease a value by turning the knob counter-clockwise or press the down-arrow hardkey

[Back Space] backs up over mistakes

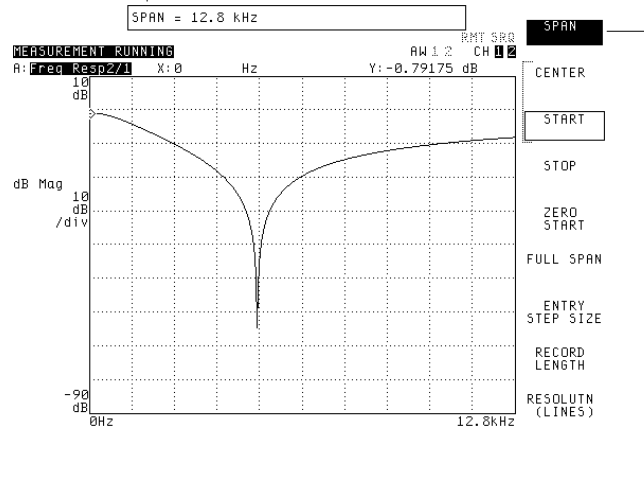

Highlighting (also called inverse video) shows that [SPAN] is the active softkey

To move the main marker

- 1 Press **[Marker]**.
- 2 Turn the knob.

You can easily determine the X- and Y-axis values of any point on a trace. Just move the main marker to the point of interest and read its value from the marker readout. The main marker appears as a small diamond.

You do not always need to press **[Marker]** before you turn the knob, but it is a good habit to develop. The knob has two primary functions outside of text entry: moving the main marker and changing the value of numeric parameters. When you press **[Marker]**, you ensure that the knob is assigned to moving the marker.

In addition to using the knob, you can move the main marker by pressing the arrow keys or entering an X-axis position. In both cases, you must press **[Marker]** first. You can also press one of the marker search softkeys. For more information on moving markers, see online help for the softkeys in the **[Marker]** menu.

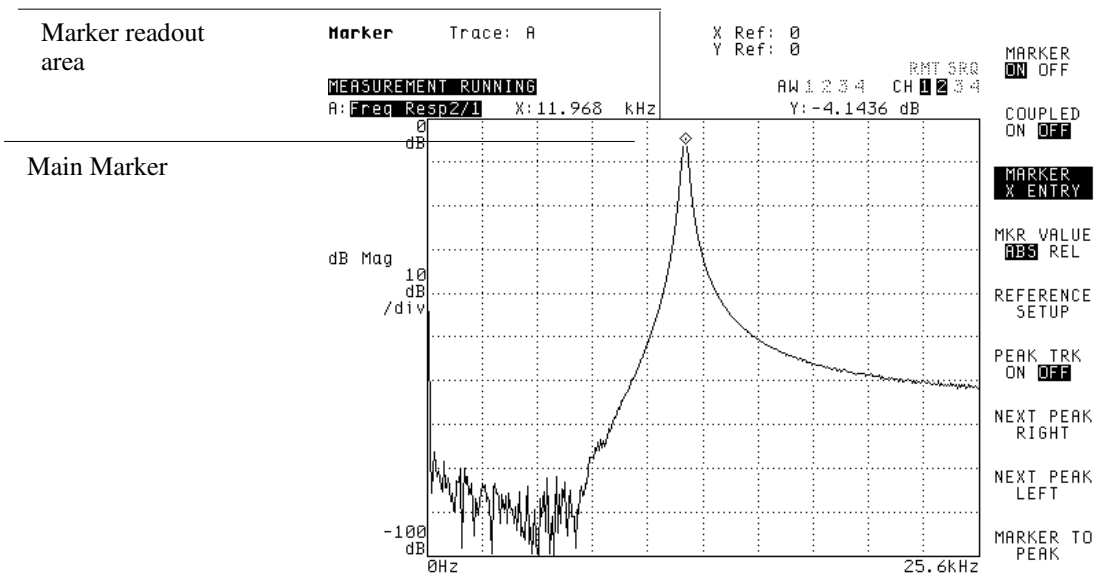

To measure a value relative to a reference

- 1 To stop a measurement, press [Pause-Cont].
- 2 Press [Marker], [REFERENCE SETUP].
- 3 Using the knob, move the main marker to the reference position.
- 4 Press [REFERENCE TO MARKER].
- 5 Using the knob, move the relative marker to the point of interest.
- 6 Read the Xr and Yr values which are relative to the main marker's reference position.

The [REFERENCE TO MARKER] key turns on the relative marker and zeroes it at the main marker's current marker position. The marker reference appears as a small square. The marker readouts, Xr and Yr at the top of the grid, are relative to this position.

The relative marker let you easily determine the peak-to-peak value of a spectrum. It can also be used to measure the holdoff time for a tachometer signal.

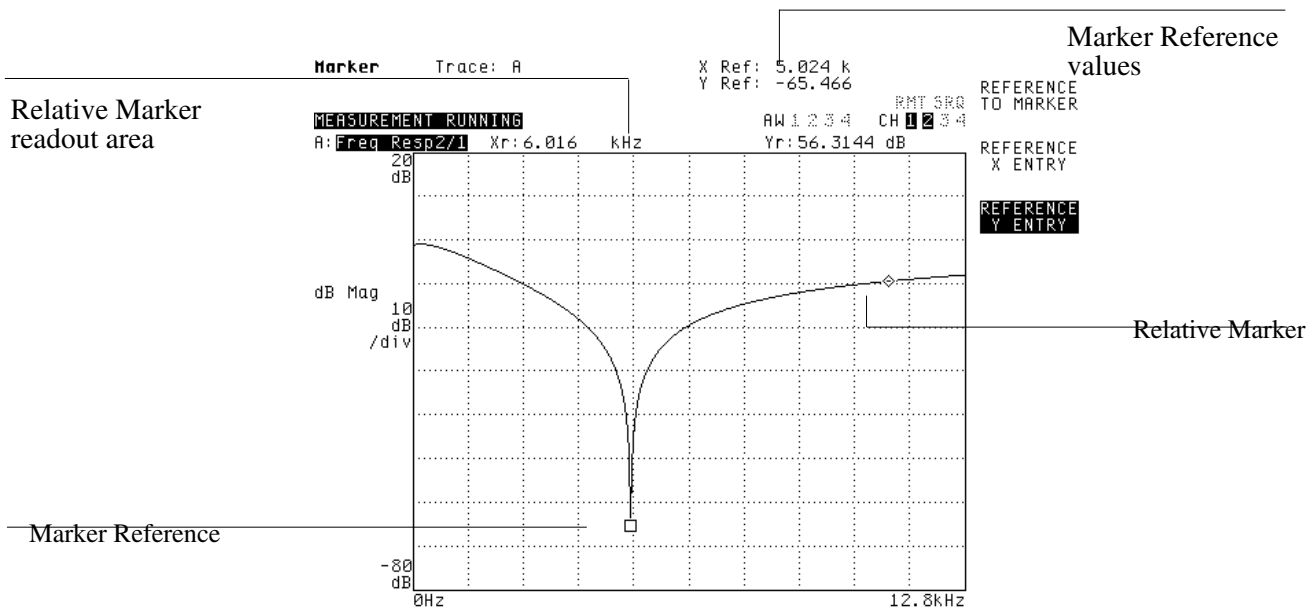



Setting Up

Setting Up

This section shows you how to initialize some important settings that you will rarely need to change. The settings are stored in the analyzer's battery-backed memory so they are not lost when you turn off the analyzer or when you press [Preset][**DO PRESET**].

This section does not show you how to install your analyzer. If you have just unpacked your analyzer, refer to your *Agilent35670A Installation and Verification Guide*.

To set the analyzer's GPIB address

- 1 Press [Local/GPIB].
- 2 Verify the analyzer's GPIB address at the top of the display.
- 3 To change the address, press [ANALYZER ADDRESS] <number> [ENTER].

You can create a GPIB system by connecting your analyzer to other devices with GPIB cables. For example, you create a simple GPIB system when you connect the analyzer to a GPIB plotter. To make the system function properly, you must assign a unique address to each attached device—even the analyzer.

The analyzer's address is set to 11 at the factory. Valid values include all integers from 0 through 30.

Current GPIB Address
Settings

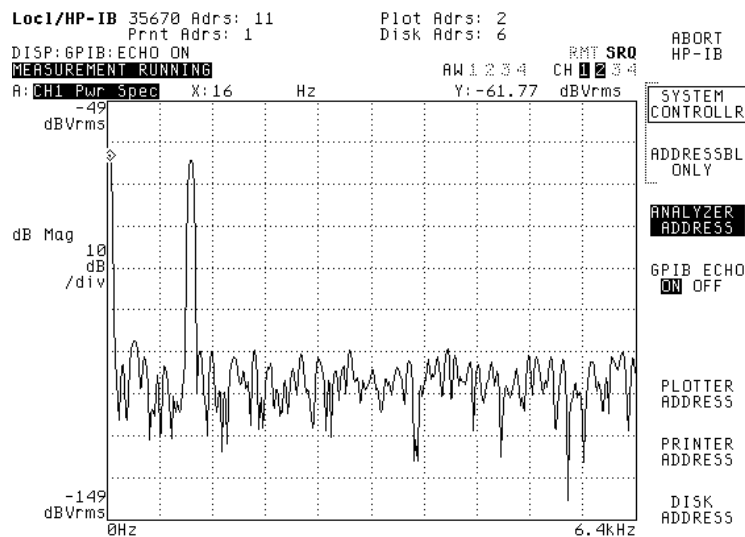

To set the analyzer's clock

- 1 Press [System Utility] [CLOCK SETUP].
- 2 Press [TIME HHMM] <time> [ENTER].
- 3 Press [DATE MMDDYY] <date> [ENTER].

You can set the analyzer's battery-backed clock to match the current time and date. After you set the clock, it maintains the time and date—even when the analyzer is turned off.

Enter <time> and <date> using the numeric keypad. Use a 24-hour format for <time> and a month-day-year format for <date>.

The time stamp determines how the analyzer displays the date and time. To change the format of the time stamp, press [System Utility] [CLOCK SETUP] [TIME STAMP SETUP]. The analyzer provides several formats. See online help for more information.

Time and date are included in top-left corner when you plot or print with [TIME STMP ON] in [Plot/Print] [MORE SETUP] menus

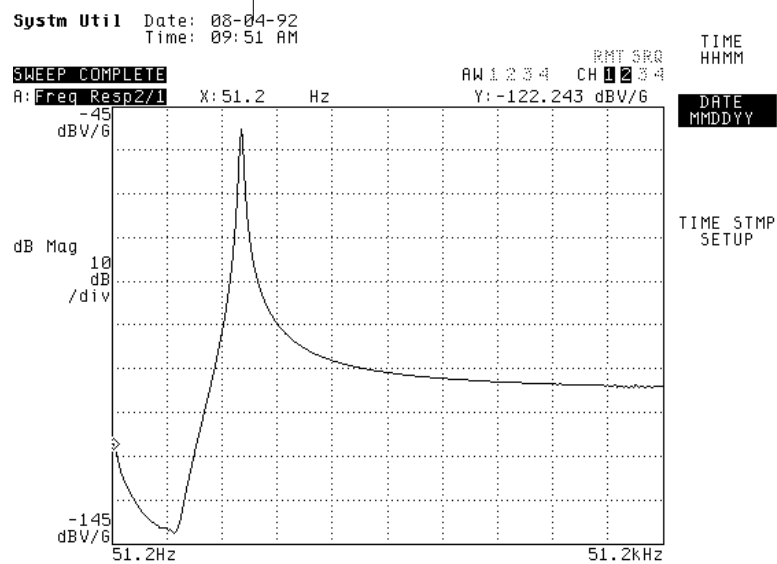

To select the default disk

- 1 Press [**Disk Utility**] [DEFAULT DISK].
or
Press [**Save/Recall**] [DEFAULT DISK].
- 2 Press [NON-VOL RAM DISK]
or
Press [VOLATILE RAM DISK]
or
Press [INTERNAL DISK]
or
Press [EXTERNAL DISK].

Your default disk selection tells the analyzer which disk to use when it is saving and recalling files. You can use online help to learn more about these options, but here is an overview:

- [NON-VOL RAM DISK] selects the analyzer's battery-backed RAM disk. There is approximately 100 Kbytes of storage space for data. (Option UFF adds an additional 1 Mbytes of non-volatile RAM.) The data is not lost when you turn off the analyzer.
- [VOLATILE RAM DISK] selects the analyzer's volatile RAM disk. Data is lost when you turn off the analyzer. However, you can format the disk to hold more data than the non-volatile RAM disk, and file operations are much faster than on the internal disk.
- [INTERNAL DISK] selects the analyzer's internal disk drive. The internal disk uses 3.5-inch flexible disks (double-sided, double- or high-density). For more information, see "To format a flexible disk" later in this book.
- [EXTERNAL DISK] selects an external GPIB disk. (You must specify a disk unit number with the [EXTERNAL DISK UNIT] softkey.) Enter the address of the disk drive in the [**Local/GPIB**] menu with the [DISK ADDRESS] softkey. The analyzer must be set as the [SYSTEM CONTROLLER]. For more information on setting addresses, see online help.

To select the active trace

- 1 Press [Active Trace].
- 2 Press one of the following softkeys:
 - [A]
 - [B]
 - [C]
 - [D]
 - [A B]
 - [C D]
 - [A B C D].

The analyzer has four trace buffers that are *independent* of the input channels: trace A, trace B, trace C, and trace D. In addition to the individual traces, the following traces can be active at the same time:

- A and B—trace A is the “most active” trace.
- C and D—trace C is the “most active” trace.
- ABCD—trace A is the “most active” trace.

Trace pairs AC and BD *cannot* be active at the same time.

The “most active” trace data is saved during a save operation and menu selections show the “most active” trace setup.

You have many options for selecting and displaying the contents of a trace, but you must activate the trace before you can change these options. For example, most of the selections under the [Marker] and [Display] menus only affect the active trace.

Inverse video indicates which traces are active

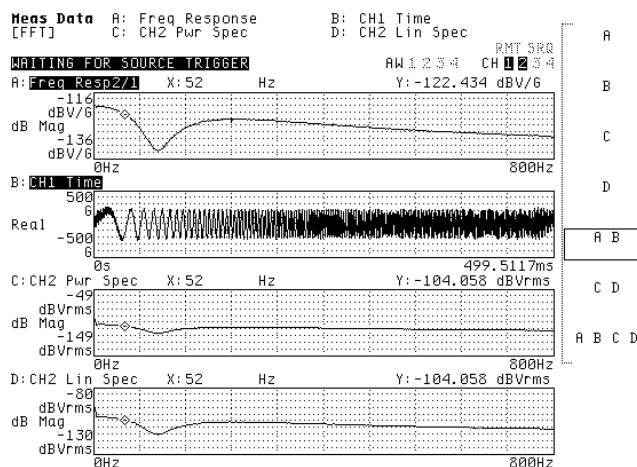

To display traces

- 1 Press [Disp Format].
- 2 Press [SINGLE].
 - or
 - press [SINGLE FRNT/BACK].
 - or
 - press [UPPER/LOWER].
 - or
 - press [UPPER/BIG LOWER].
 - or
 - press [UPPR/LOWR FRNT/BACK].
 - or
 - press [QUAD].

When you display multiple traces, any number of them can be active. The analyzer uses inverse video to show you which traces are active.

If you select the front/back formats (press [SINGLE FRNT/BACK] or [UPPR/LOWR FRNT/BACK]), the “back” trace is ghosted (displayed with half-bright characters).

The analyzer allows only one active trace if you select the single-trace display format. The analyzer selects the “most active” trace. See the previous task if you do not understand what it means to activate a trace.

Upper/lower trace format

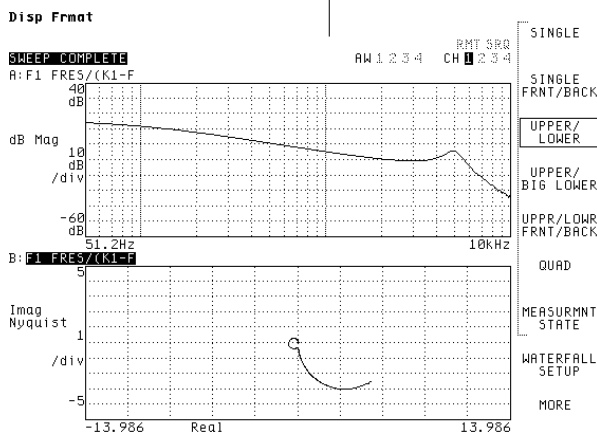

Back trace appears ghosted

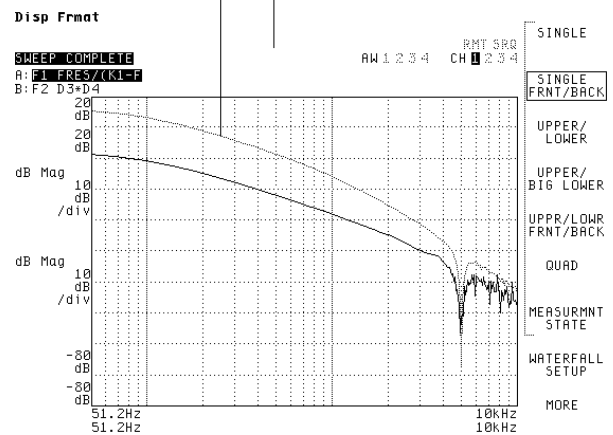

Single Front/Back format

To select measurement data

- 1 Select the active traces. (See “To select the active trace,” the first task in this section.)
- 2 Press [Meas Data].
- 3 Press [CHANNEL 1 2]
or
Press [CHANNEL 1 2 3 4] (option AY6). The analyzer steps through the channel selections as you press [CHANNEL 1 2 3 4].
- 4 Press one of the measurement data softkeys. The [MORE CHOICES] softkey displays another menu of measurement data selections.

If measurement data is not available, its softkey label is ghosted (displayed using half-bright characters). The availability of trace data is limited by:

- your selection of instrument mode (See “To select an instrument mode” in the first section.)
- the number of active channels

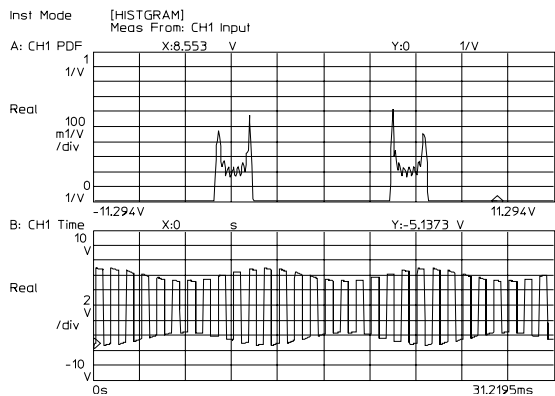
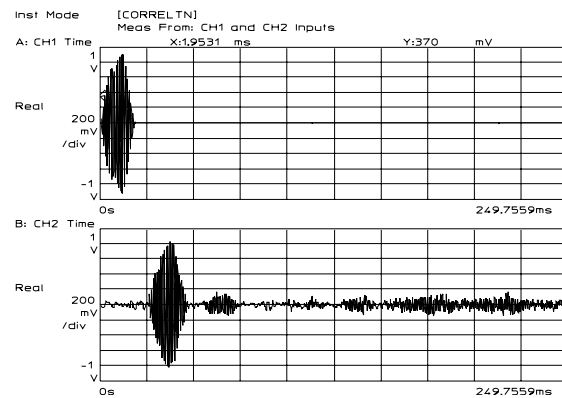
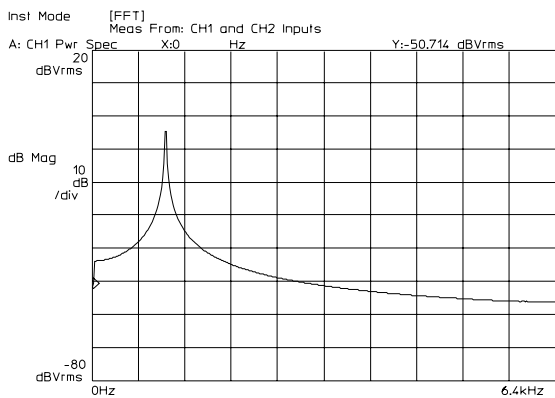

When the analyzer has two active input channels and multiple active traces, selecting measurement data while the [ALL CHANNELS] softkey is highlighted, sets:

- Channel 1 measurement data to Trace A.
- Channel 2 measurement data to Trace B.
- Channel 1 measurement data to Trace C.
- Channel 2 measurement data to Trace D.

When the analyzer has four active input channels (Option AY6) and four active traces, selecting measurement data while the [ALL CHANNELS] softkey is highlighted, sets:

- Channel 1 to Trace A.
- Channel 2 to Trace B.
- Channel 3 to Trace C.
- Channel 4 to Trace D.

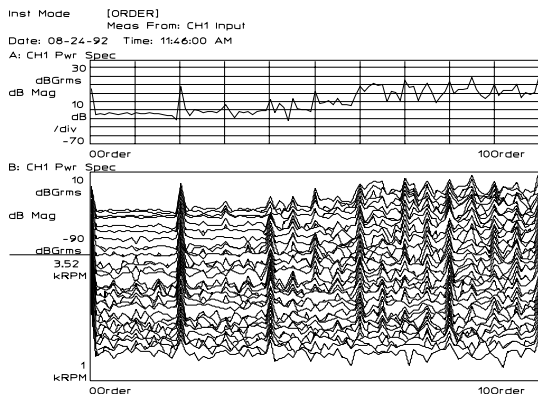
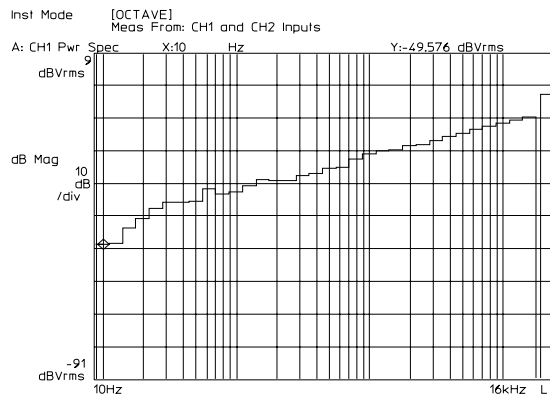
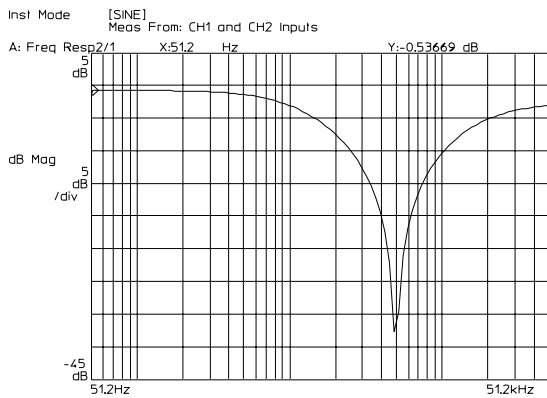

To scale measurement data

- 1 Select the active trace(s) you want to scale. (See “To select the active trace,” the first task in this section.)
- 2 For continuous autoscaling, press [Scale] [AUTOSCALE ON OFF] to highlight ON.
or
For single autoscaling, press [Scale] [AUTOSCALE ON OFF] to highlight ON, then press [AUTOSCALE ON OFF] to highlight OFF.

Autoscaling provides a convenient starting point when you are scaling measurement data. It displays all of the data within the bounds of the active trace box. From this starting point, you can easily reposition and expand the trace by modifying the values of other scaling softkeys.

- Use [CENTER REFERENCE] to expand or compress a trace around the center reference value you specify. You can also anchor the reference to the top of the trace box ([TOP REFERENCE]) or to the bottom of the trace box ([BOTTOM REFERENCE]).
- Use [Y PER DIV] to expand or compress the trace in relation to the Y-axis. You enter a value that defines the height of each vertical division.
- Use [INP RANGE TRACKING] to expand or compress a trace in relation to the level of the input channel supplying the measurement data.

To learn more about the scaling softkeys, use online help.

Matches Scale Menu scales the active trace to any other trace

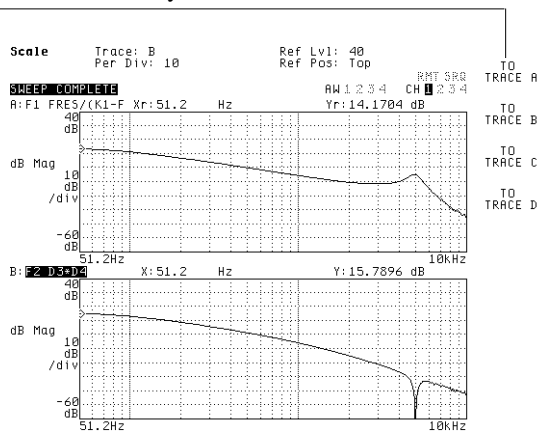

Y Per Div defines the increment between Y-axis divisions

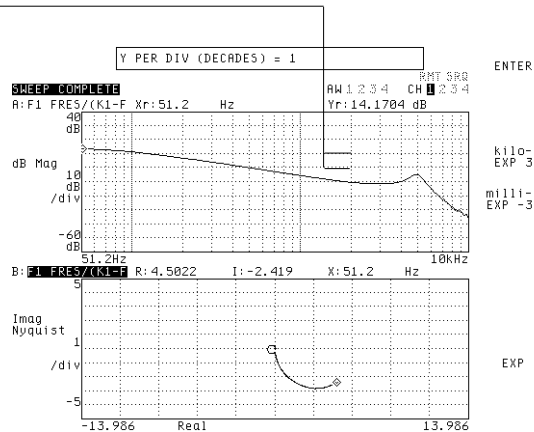

To display the measurement state

- Press [**Disp Format**] [MEASURMNT STATE].

The measurement state is a list that summarizes the current states of important measurement parameters. There are several ways you can use the list. You can:

- quickly check the current setup
- document the setup (The list can be printed or plotted.)
- change the parameters while viewing the setup (See the next task, “To change parameters using the measurement state.”)

When you learn to switch between the analyzer’s instrument modes, you will notice that the contents of the list are different for each mode. This reflects the fact that some parameters are not used for a particular instrument mode.

Swept Sine instrument mode (option 1D2)

Inst Mode [SINE]
Meas From: CH1 and CH2 Inputs

Inst Mode	SINE		Channels 2	
Meas Data	Data A	FRF1	Data B	LIN SPEC2
	Data C	FRF1	Data D	LIN SPEC2
Trac Coord	Coord A	MDB	Coord B	MDB
	Coord C	MDB	Coord D	MDB
Freq	Start	51.2 Hz	Stop	51.2 kHz
	Center	25.6256 kHz	Span	51.149 kHz
	Directon	UP	Resoltn	101 Pnt/3w
Avg	Settle	5 Cycle	Integrat	5 Cycle
	Fast Avg	OFF		
Source	Level	0 Vpk	DC Offst	0 V
	Rmp Rate	0 Vpk/s	Auto Lvl	OFF
	Ref Chan	INPUT2	Ref Lvl	1 Vpk
	Ref Tol	2 dB	Max Inpt	2 Vpk
	Max Src	2 Vpk		
Input	CHANNEL 1	CHANNEL 2	CHANNEL 3	CHANNEL 4
Status	ON	ON	OFF	OFF
Range	3.9858 mVp	3.9858 mVp	3.9858 mVp	3.9858 mVp
Auto Rng	EITHER	EITHER	EITHER	EITHER
Coupling	DC	DC	DC	DC

Realtime Octave analysis instrument mode (option 1D1)

Inst Mode [OCTAVE]
Meas From: CH1 and CH2 Inputs

Inst Mode	OCTAVE		Channels 2	
	Measurement Source		INPUT	
Meas Data	Data A	PWR SPEC1	Data B	PWR SPEC2
	Data C	PWR SPEC1	Data D	PWR SPEC2
Trac Coord	Coord A	MDB	Coord B	MDB
	Coord C	MDB	Coord D	MDB
Freq	Start	12.5 Hz	Stop	16 kHz
	Octave	THIRD		
Avg	Type	RMS	Hold	OFF
	Time	125 ms	Confidnc	0.5 dB
	Impulse	OFF	Rept Avg	REPEAT
Trigger	Type	IMMEDIATE	Dly Time	0 s
	Slope	NEGATIVE		
	Ext lvl	0 V	Time Stp	1 s
	Ext filtr	OFF	RPM Step	20 rpm
	Arm	IMMEDIATE	RPM dir	UP
	Strt RPM	600 rpm		
	Wtrfall	200		
Source	Status	OFF	DC Offst	0 V
	Level	0 Vpk		

Inst Mode [ORDER]
Meas From: CH1 and CH2 Inputs

Inst Mode	ORDER		Channels 2	
	Measurement Source		INPUT	
Meas Data	Data A	PWR SPEC1	Data B	PWR SPEC2
	Data C	TIME1	Data D	TIME2
Trac Coord	Coord A	MDB	Coord B	MDB
	Coord C	REAL	Coord D	REAL
Freq	Min RPM	600 rpm	Max RPM	6 krpm
	Max Ord	10 ord	Delt Ord	100 morad
	Track	OFF		
Window	Type	UNIFORM	BW	100 mHz
Avg	Status	OFF	Type	TIME
	Number	1	Rept Avg	FREEZE
Trigger	Type	IMMEDIATE	Strt RPM	600 rpm
	Slope	NEGATIVE	Time Stp	100 ms
	Ext lvl	0 V	RPM dir	UP
	Ext filtr	OFF		
	Arm	IMMEDIATE		
	RPM Step	20 rpm		
	Wtrfall	20		

Computed Order analysis instrument mode (option 1D0)

To change parameters using the measurement state

- 1 To stop a measurement, press **[Pause-Cont]**.
- 2 Press **[Disp Format]** [MEASURMNT STATE].
- 3 Using the knob, move the cursor to the field you wish to change.
- 4 Use the up-arrow or down-arrow keys to step through the available values for that field.
or
Press <number> <unit>.
- 5 Press **[Pause-Cont]**.
- 6 Press **[Disp Format]** and the appropriate trace-display format softkey.

As you select parameter values, the analyzer may change other parameters to their default value. It is best to start at the top of the list and work your way down.

Pausing the measurement while you change the measurement state, allows the process to go faster.

MARKER

Marker

Marker Potn

7 8 9 ↶

4 5 6 ↷

1 2 3 Mrk Value

0 . +/- Back Space

Turn the knob to select the field

Use the arrow keys to step through values

```

Inst Mode [FFT]
Meas From: CH1 and CH2 Inputs

Inst Mode FFT                               Channels 2
Measurement Source INPUT
Meas Data Data A ORBIT1                      Data B PWR SPEC2
           Data C TIME1                      Data D TIME2
Trac Coord Coord A REAL                      Coord B MDB
           Coord C REAL                      Coord D REAL
Freq      Start 0 Hz                          Stop 51.2 kHz
           Center 25.6 kHz                     Span 51.2 kHz
           Rec Len 7.8125 ms                    Resoltn 400
Window    CH1 Type FLATTOP                     BW 488.88 Hz
           CH2 Type FLATTOP                     BW 488.88 Hz
           CH3 Type FLATTOP                     BW 488.88 Hz
           CH4 Type FLATTOP                     BW 488.88 Hz
Avg       Status OFF                          Type RMS
           Number 10                           Overlap 0 %
           Fast Avg OFF                         Update 5
           Rept Avg FREEZE                       Ovid Rej OFF
Trigger   Type IMMEDIATE                       Level 0 V
           Slope POSITIVE
           Ext Lvl 0 V

```

To display a waterfall

- 1 Press [Scale] [AUTOSCALE ON OFF] to highlight OFF.
- 2 Press [Disp Format] [WATERFALL SETUP].
- 3 Press [WATERFALL ON OFF] to highlight ON.
- 4 Press [SKEW ON OFF] to highlight ON.
- 5 Press [Z AXIS RANGE] <number> <unit>.

The traces scroll down the trace box. The newest trace is at the top. The [Z AXIS RANGE] key specifies the range of complete traces you want displayed on the waterfall. The range varies with the type of data you are displaying.

The waterfall display format is not available for swept sine measurements. For more information, see the *Agilent 35670A Operator's Guide* and online help.

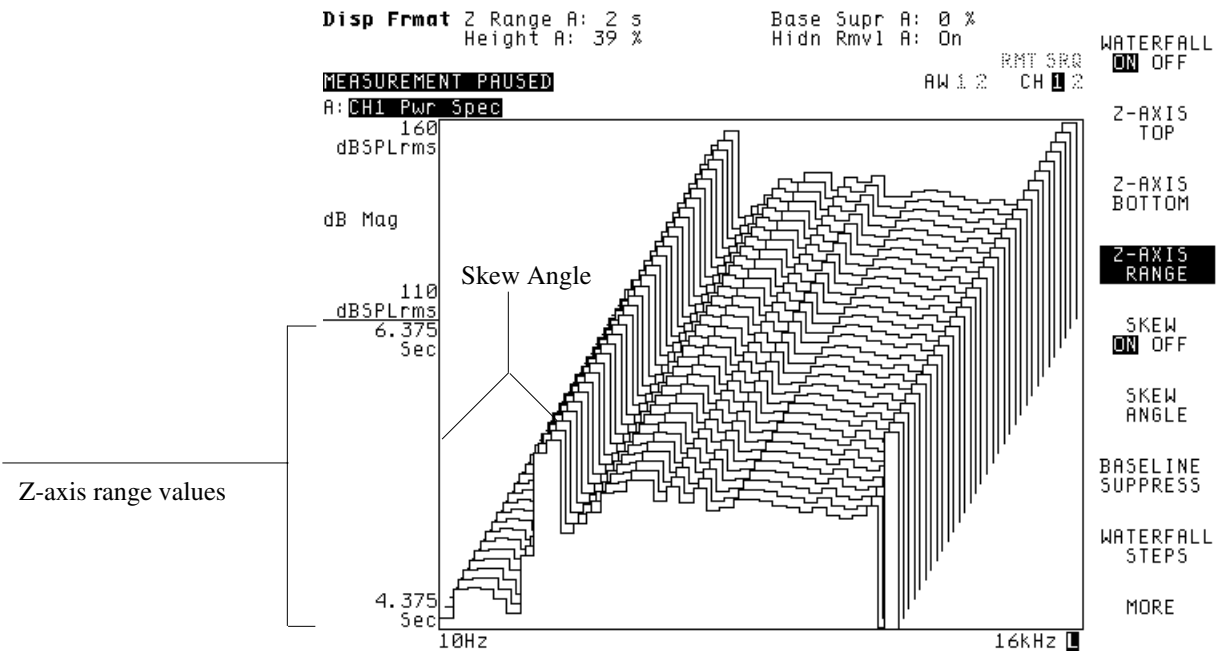

To measure a spectrum

The Agilent 35670A evaluates signals and devices under 102.4 kHz. Dynamic range is 80 dB guaranteed. The analyzer has a 25.6 kHz real-time rate at 400 lines of resolution.

1 Initialize the analyzer.

Press [**Preset**] then press [DO PRESET].

Press [CHANNELS 1 2]

or [CHANNELS 1 2 4] to highlight 1.

2 Connect the signal source as shown in the illustration.

3 Select the measurement parameters.

Press [**Freq**] [START] <number> <unit>, then press [STOP] <number> <unit>.

4 Specify the averaging parameters.

Press [**Avg**] then press [AVERAGE ON OFF] to highlight ON.

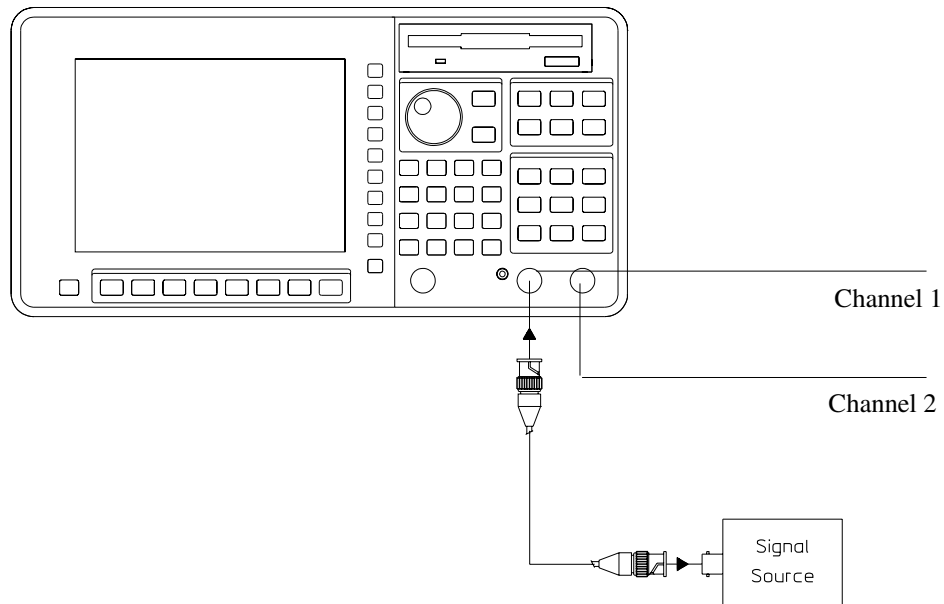

5 Configure the display.

Press [**Scale**], then press[AUTOSCALE ON OFF] to highlight ON.

6 Measure the signal source.

Press [**Start**].

The default number of averages is 10. To specify a different number of averages, press [**Avg**] [NUMBER AVERAGES] <number> [ENTER].

The average count at the bottom of the display is updated after each average.

Resolution can be set to 100, 200, 400 or 800 lines. Press

[**Freq**] [RESOLUTN (LINES)] <number> [ENTER].

The lines of resolution appears at the top of the display.

The analyzer has an input impedance of approximately 1 Megohm. If your signal source needs to be terminated with a lower impedance, use an appropriate feedthrough terminator between the output of the signal source and the Channel 2 input.

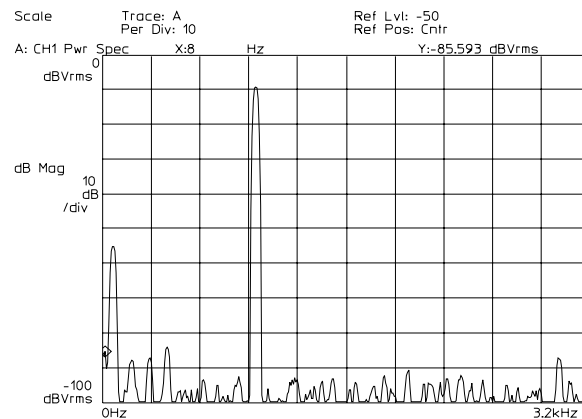

To measure frequency response — FFT

A device's frequency response can be measured using the high-speed FFT analysis. The dynamic range is typically 80 dB. For better dynamic range, use the optional Swept Sine instrument mode.

1 Initialize the analyzer.

Press [**Preset**].

[DO P RESET].

Press [**Meas Data**] [FREQ RESP 2/1].

2 Connect the device-under-test (DUT) as shown in the illustration.

3 Specify the measurement parameters.

Press [**Freq**] [START] <number> <unit>, then press [STOP] <number> <unit>.

Press [**Source**], [PERIODIC CHIRP].

Press [LEVEL] <number> <unit>, then press [SOURCE ON OFF] to highlight ON.

Press [**Window**] [UNIFORM].

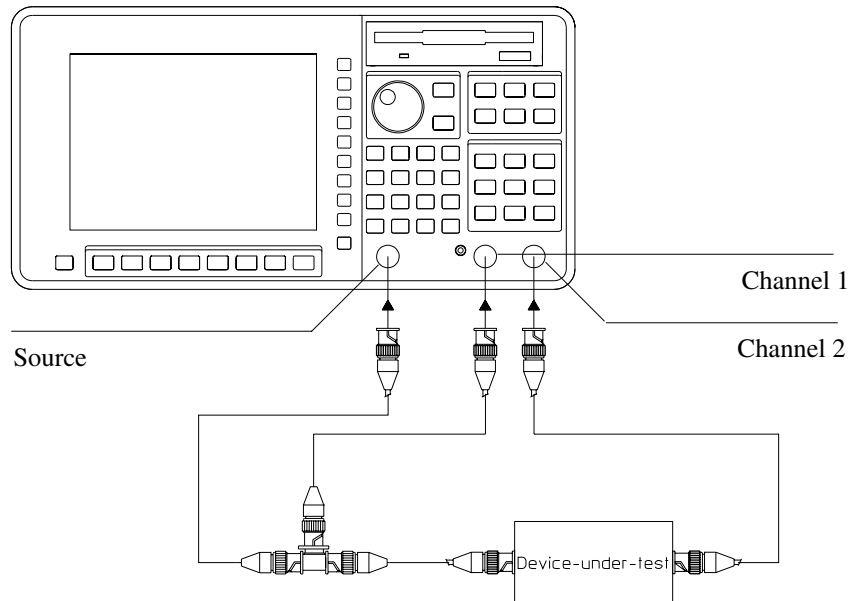

4 Specify the triggering parameters.

Press [**Trigger**] [SOURCE TRIGGER].

5 Configure the display.

Press [**Scale**], then press[AUTOSCALE ON OFF] to highlight ON.

Press [**Disp Format**] [MORE] [BODE DIAGRAM].

6 Measure the DUT.

Press [**Start**].

A triggered measurement and the uniform window selection produces a much more accurate response at the low end of the frequency spectrum. The periodic chirp provides more energy than random noise. It is a self-windowing signal that provides exactly the same stimulus from one measurement average to the next. Consequently, averaging is not required.

The analyzer's source impedance is less than 5 ohms. If your DUT needs a specific source impedance, insert the appropriate resistor in series with the source output.

To display the measurement data on a logarithmic scale press [**Trace Coord**] then press [X-AXIS LIN LOG] to highlight LOG.

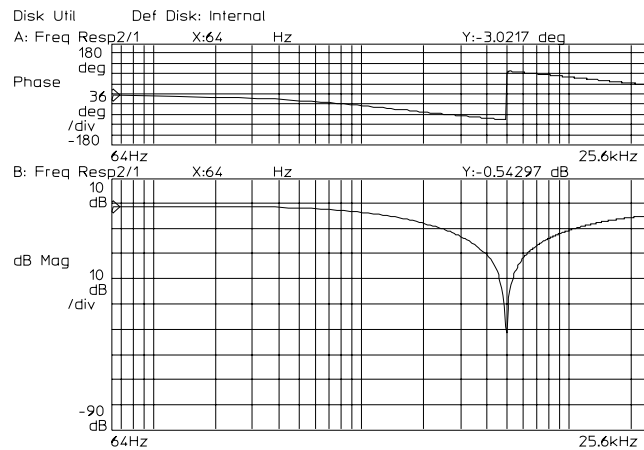

To measure frequency response — Swept Sine (Option 1D2)

Swept Sine measurements are available only with those Agilent 35670A analyzers that are equipped with Option 1D2. The measurement range expands to 130 dB (typical), but measurement time increases as compared to the FFT instrument mode.

1 Initialize the analyzer.

Press [**Preset**] [DO PRESET].
Press [SWEPT SINE].

2 Connect the device-under-test (DUT).

3 Select the measurement parameters.

Press [**Freq**] [START] <number> <unit>, then press [STOP] <number> <unit>.
Press [RESOLUTN SETUP], then press [SWEEP LIN LOG] to highlight LIN for a linear sweep.

Press [**Source**] [LEVEL] <number> <unit>.

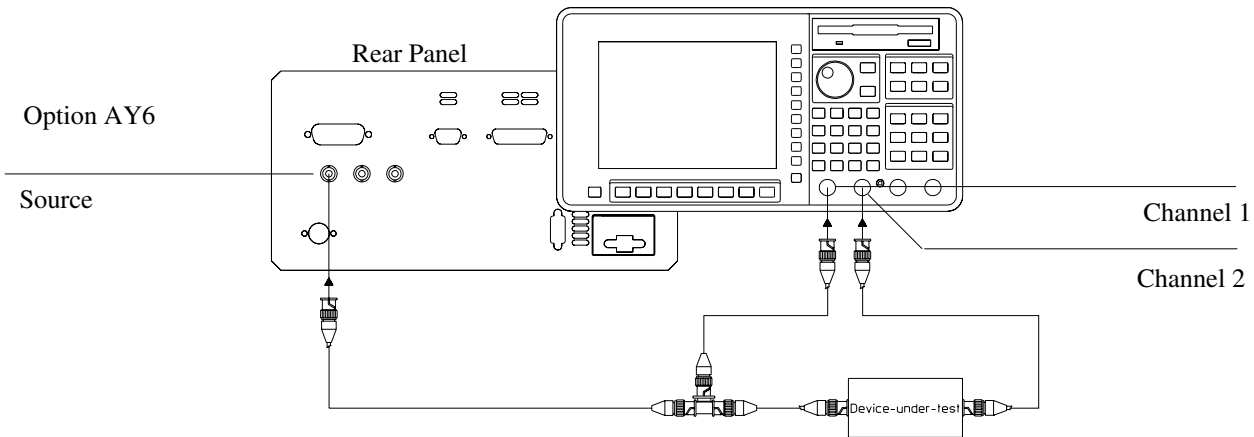
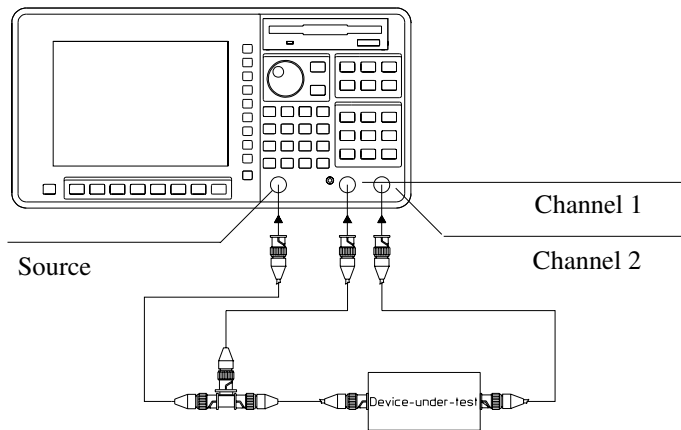

4 Configure the display.

Press [**Scale**], then press[AUTOSCALE ON OFF] to highlight ON.
 Press [Disp Format] [MORE] [BODE DIAGRAM].

5 Measure the DUT.

Press [**Start**].

If you want to use a linear X-axis for the logarithmic sweep:

Press [**Trace Coord**] then press[X-AXIS LIN LOG] to highlight LIN.

If the overload indicator (as shown in the illustration) flashes, the analyzer is autoranging to provide the best signal-to-noise ratio.

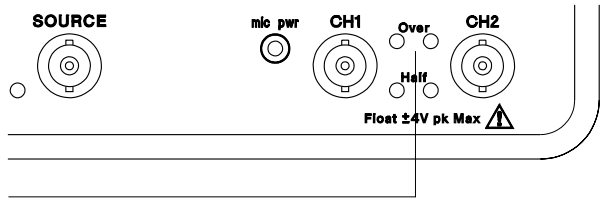
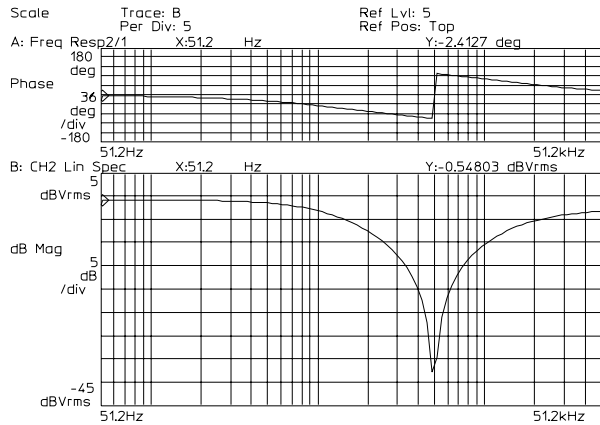

Overload indicator flashes when analyzer is autoranging

To calibrate a microphone — Octave Analysis (Option 1D1)

Octave measurements are available only with those Agilent 35670A analyzers that are equipped with Option 1D1. Signals can be analyzed at frequencies up to 40 kHz in the single-channel mode. This task measures the sound pressure level of the calibrator.

- 1 Initialize the analyzer.
Press [**Preset**] [DO PRESET].
Press [OCTAVE ANALYSIS].
- 2 Connect the microphone input to the analyzer's Channel 1 input as shown in the illustration. Attach a calibrator to the microphone.
- 3 Configure the display.
Press [**Scale**], then press[AUTOSCALE ON OFF] to highlight ON.
- 4 Start the calibration.
Turn on the calibrator.
Press [**Start**].

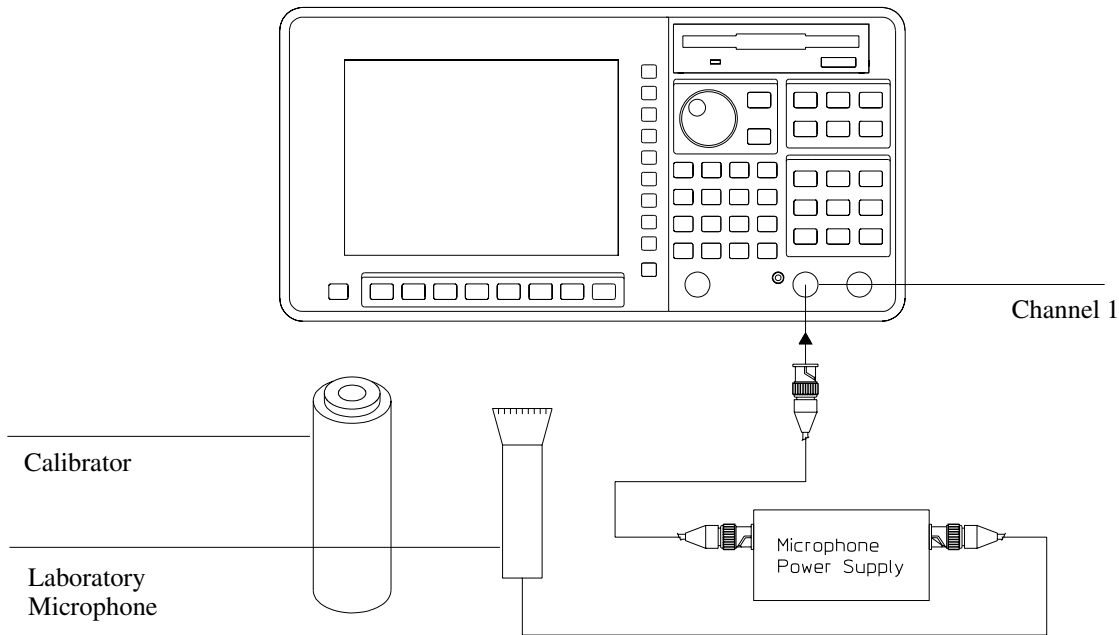

5 Specify the calibration parameters.

- Press [**Input**] [XDCR UNIT CH1 SETUP]
- Press [XDCR UNIT ON OFF] to highlight ON.
- Press [XDCR UNIT LABEL] [PASCAL].
- Press [**Trace Coord**] [Y UNITS], then press [AMPLITUDE PK PP RMS] to highlight RMS.
- Press [dB REF SETUP] [dBSPL (20 uPA)].
- Press [**Marker**], [MARKER TO PEAK].
- Press [**Input**] [XDCR UNIT CH1 SETUP].
- Press [CAL VALUE AT MKR], <number> [ENTER].

Specify the calibration parameters to match the calibrator's specifications.

The values you specify for the transducer units are retained, unless you preset the analyzer or turn it off.

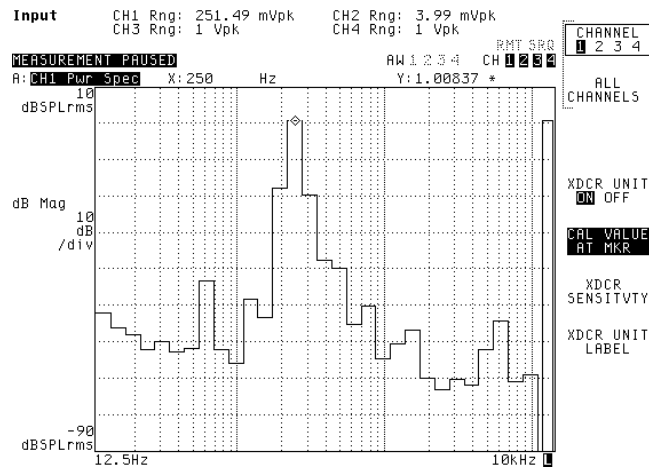

To measure sound pressure level — Octave Analysis (Option 1D1)

Octave measurements are available only with those Agilent 35670A analyzers that are equipped with Option 1D1.

1 Initialize the analyzer.

If you have not already done so, calibrate the microphone.
See the previous measurement, “To calibrate a microphone.”

2 Set the calibrated microphone in front of the sound source.

3 Select the measurement parameters.

Press [**Input**] [FRONT END CH1 SETUP], then press [A WT FLTR ON OFF] to highlight ON.

Press [**Trace Coord**] [Y UNITS] [EU].

Press [dB REF SETUP] [dBSPL (20 uPa)].

Press [**Rtn**].

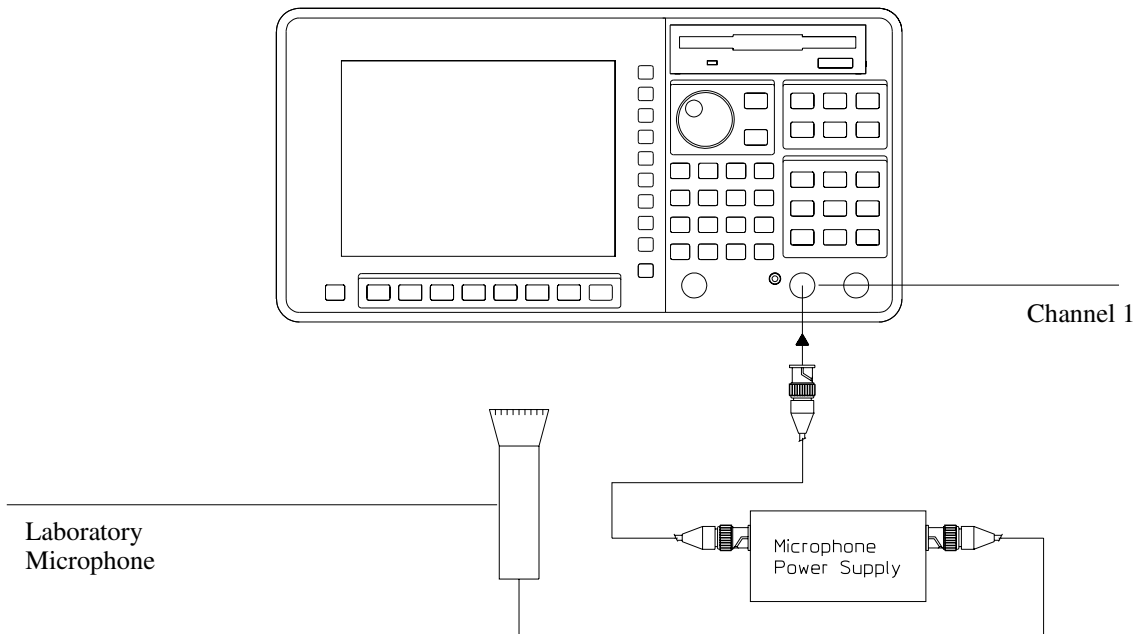

4 Measure the sound source.

Press [**Start**].

Calibration must be done unweighted. If you preset the analyzer, the transducer units you specify in the previous task, “To calibrate a microphone,” are lost.

To compute and display the IEC 65 impulse characteristic in the overall power band, press [IMPULSE ON OFF] to highlight ON in the [A_{vg}] menu. Use the knob to move the main marker to the far right band.

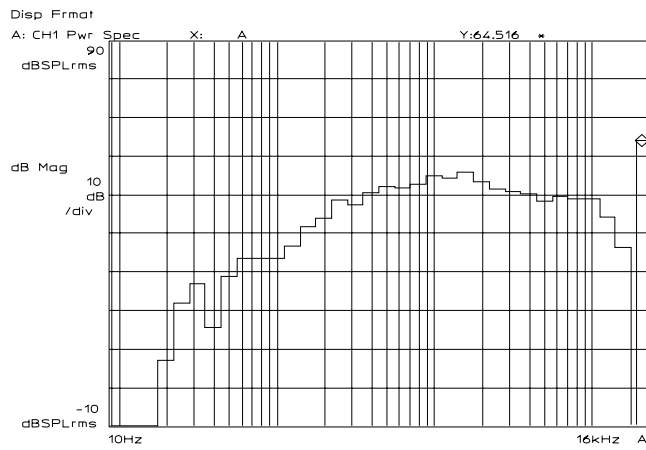

To measure harmonic distortion

In addition to measuring harmonic distortion, this task measures the frequency and amplitude of the fundamental frequency.

- 1 Initialize the analyzer.
Press [**Preset**] [DO PRESET].
- 2 Connect the signal source as shown in the illustration.
- 3 Select the measurement parameters.
Press [**Freq**] [START] <number> <unit>, then
press [STOP] <number> <unit>.
Press [**Window**].
Press [HANN].
or
Press [FLAT TOP].
- 4 Specify the triggering and averaging parameters.
Press [**Trigger**] [CHANNEL 1 2 3 4] to highlight 1, then
press [TRIGGER SETUP] [CHANNEL LEVEL], <number> <unit>.
Press [**Avg**], then press [AVERAGE ON OFF] to highlight ON.

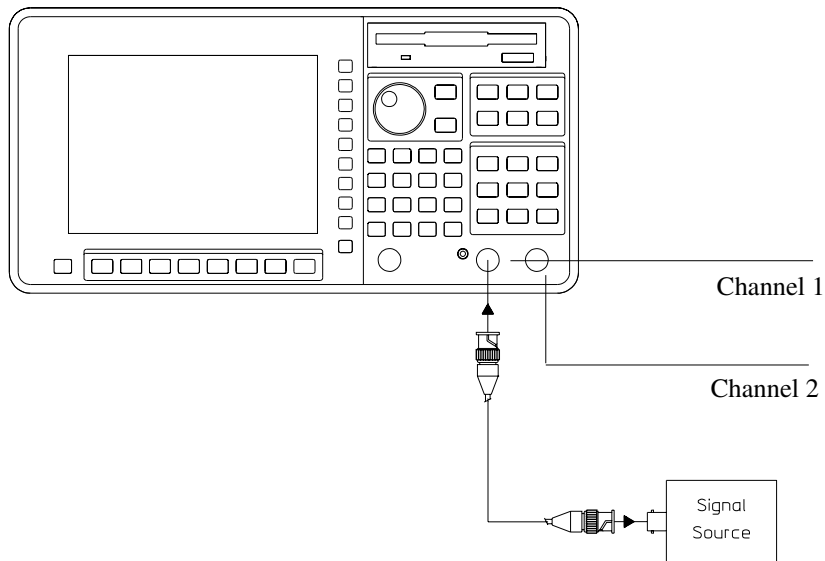

5 Configure the display.

Press [Scale], then press[AUTOSCALE ON OFF] to highlight ON.

6 Measure the signal source.

Press [Start].

Press [Marker], then press [MARKER TO PEAK].

Press [Marker Fctn] [HARMONIC MARKER] [FUNDAMENTL FREQUENCY] [Mkr Value].

Press [THD].

The results of the THD calculation appear at the bottom left of the analyzer’s display. The number of harmonics used to calculate THD appears at the top of the screen. The default is 20 harmonics. (If there are fewer than 20 harmonics, the available number of harmonics are used.) To change the number of harmonics, use the [NUMBER OF HARMONICS] softkey in the [HARMONIC MARKER] menu.

The absolute marker, [MARKER TO PEAK], measures the amplitude of the fundamental frequency. If the harmonic markers do not line up with the harmonics, you will need to adjust the value of the fundamental frequency (The marker falls in the middle of the frequency bin.) Use the arrow keys or the knob to adjust the value of the fundamental frequency until the harmonic markers line up with the harmonics.

Harmonic Markers

Fundamental frequency

Number of harmonics used to calculate THD

THD calculation appears at the lower-left of the upper trace display box

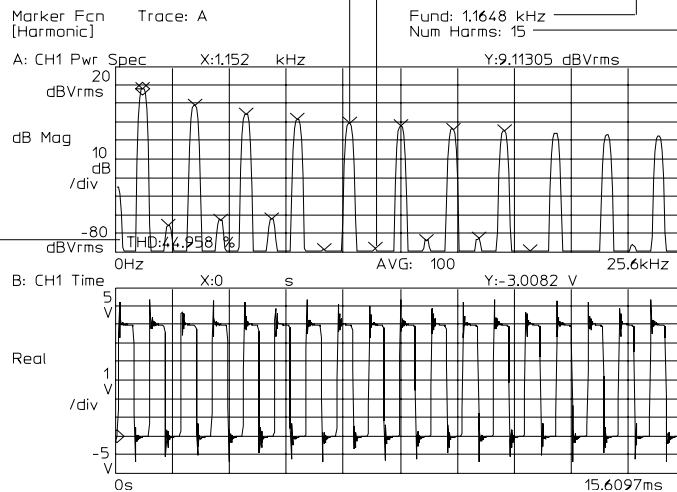

To characterize a tach pulse

To set the input parameters for a tachometer, you must first verify the amplitude of the tachometer pulse and determine the appropriate trigger level. This task is part of the initialization step for several tasks that follow.

1 Initialize the analyzer.

Press [**Preset**] [DO PRESET].

Press [HISTOGRAM/TIME].

Press [**Meas Data**], then press [UNFILTERED TIME CH 1].

2 Connect the tachometer to the analyzer's Channel 1 input and to the tachometer input on the rear panel. See illustration.

3 Configure the display.

Press [**Scale**] [AUTOSCALE ON OFF] to highlight ON.

4 Specify the measurement parameters.

Press [**Freq**] [RECORD TIME].

Use the up arrow hardkey to increase the time record, until there are several tach pulses on the display.

Press [**Trigger**] [CHANNEL 1].

Press [**Pause-Cont**].

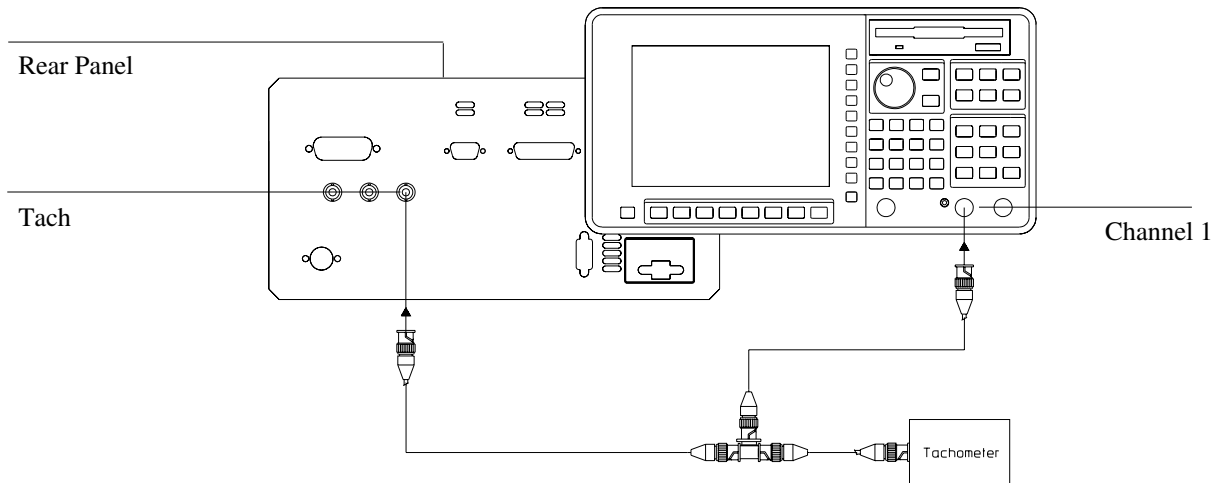

5 Select the tachometer parameters.

Press [**Input**] [TACHOMETR SETUP].

If the peak-to-peak value exceeds 4 volts, press [TACH RANG +/- 20 4] to highlight 20. Press [LEVEL] <number> <unit>. The analyzer detects the tachometer signal at this level.

Press [SLOPE POS NEG] to highlight NEG if you want the analyzer to detect the falling (negative) edge of the signal.

Press [TACH PULS PER REV] <number> [ENTER].

6 Verify tachometer parameters.

Press [TACH DISP ON OFF] to highlight ON. The tachometer indicator appears at the top of the display.

This task uses the Histogram/Time instrument mode. It lets you view the tachometer input signal in the time domain. Unfiltered time channel data is not processed through anti-aliasing filters or bandwidth-limiting filters. For more information see online help.

You may be able to use the relative marker to determine the peak-to-peak value of the signal in Step 5. See “To measure a value relative to a reference” in the first section.

The tachometer indicator displays the number of tachometer transitions. If multiple transitions occur within any one edge of the signal, you will need to “clean it up” by specifying a tachometer delay in seconds. See the next task, “To specify tachometer holdoff time.”

Tach Display

You can use the markers to determine appropriate value for

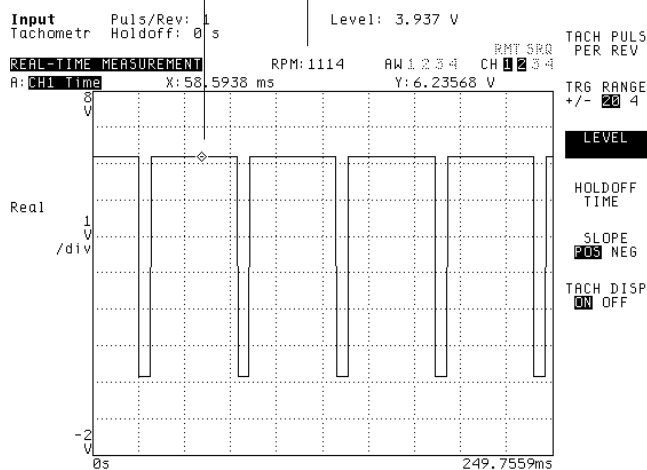

To specify tachometer holdoff time

If the edge of the tachometer input signal is not clean, the analyzer may trigger a measurement at inappropriate times. Holdoff time specifies a delay between valid tachometer transitions. The analyzer waits this amount of time before it accepts another tachometer input.

1 Initialize the analyzer.

See the previous task, “To characterize a tach pulse.”
Press [**Pause-Cont**] to pause the measurement.

2 Configure the display.

Press [**Scale**], then press[AUTOSCALE ON OFF] to highlight **ON**.
Press [AXES SCAL MARKERS] [CHANGE WIDTH]. Using the knob, widen the gap between the markers, then press [MOVE CENTER].
Using the knob, move the axes scale markers to an edge of the tachometer input signal.

Press [SCALE AT MARKERS].

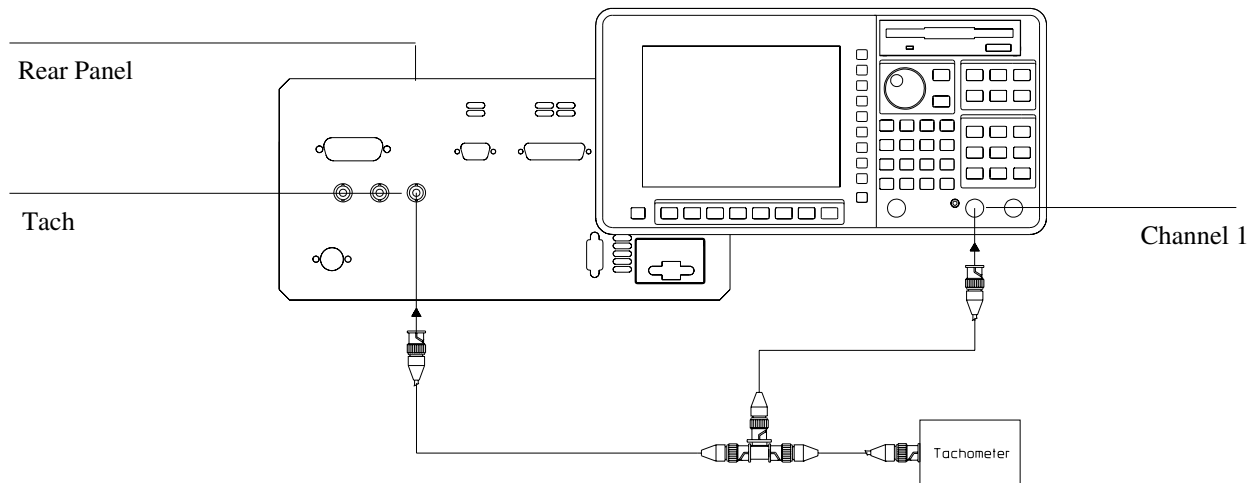

3 Measure the holdoff time.

Press [**Marker**], [REFERENCE SETUP].

Using the knob, move the marker to the start of the first clean edge.

Press [REFERENCE TO MARKER].

Now use the knob to move the marker past any inappropriate transitions on the edge of the signal.

Note the Xr marker value at the top of the grid.

4 Specify the holdoff time.

Press [**Input**], [TACHOMETR SETUP], [HOLDOFF TIME], then press [**Mkr Value**].

5 Verify the tachometer input.

Press [**Scale**], [AXES SCAL MARKERS], then press [FULL SCALE].

Press [**Inst Mode**] [ORDER ANALYSIS].

Press [**Meas Data**] [PWR SPEC CHANNEL 1].

Press [**Start**].

The Xr marker value displayed in Step 3 is specified as the holdoff time in Step 4.

The tachometer indicator at the top of the display is reading the tachometer input signal from the rear panel. The display is showing the tachometer signal from Channel 1.

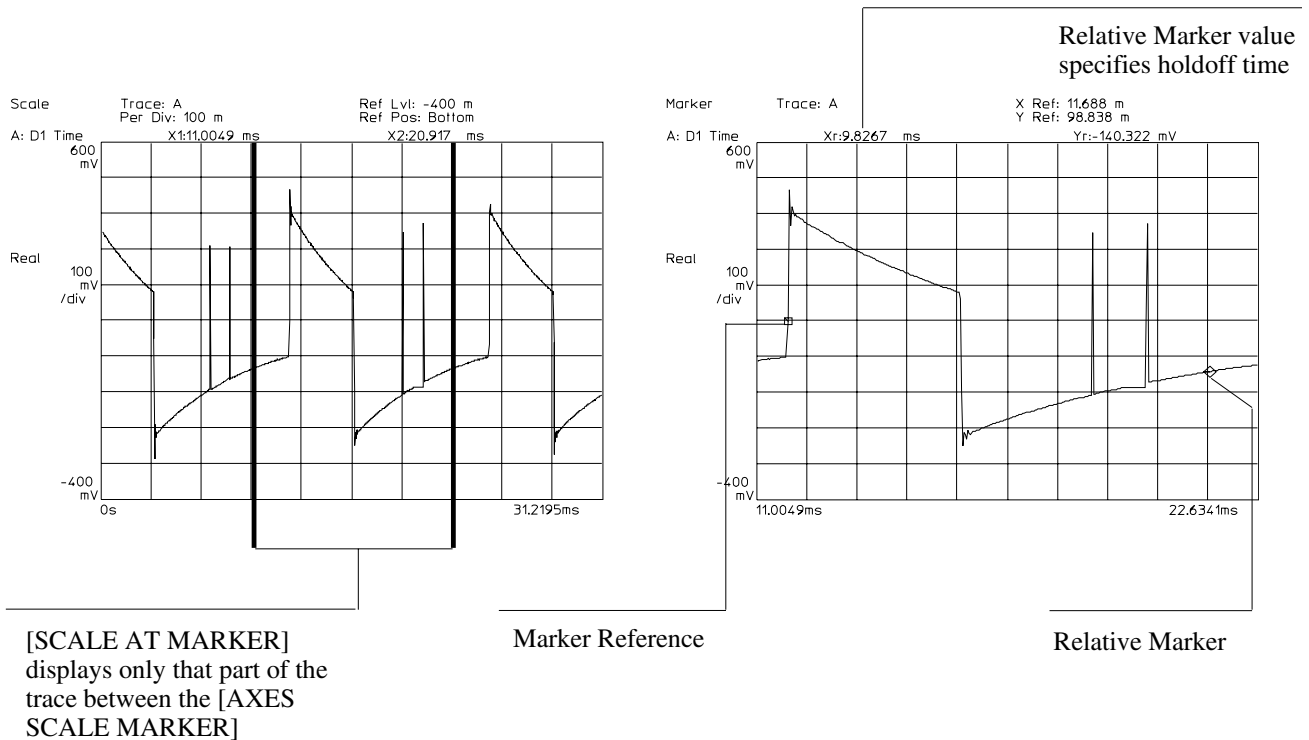

To measure an order spectrum

Order analysis measurements are available only with those Agilent 35670A analyzers that are equipped with Option 1D0.

1 Initialize the analyzer.

Set the input parameters for the tachometer. See the previous tasks, “To characterize a tach pulse” and “To specify tachometer holdoff time.”

Press **[Marker]** [MARKER ON OFF] to highlight OFF.

Press **[Inst Mode]** [ORDER ANALYSIS].

2 Connect your device-under-test (DUT) as shown in the illustration.

If the accelerometer or displacement transducer requires ICP current, press **[Input]** [CH1 AUTO RANGE] and then press [FRNT END CH1 SETUP] [ICP SUPPLY ON OFF] to highlight ON.

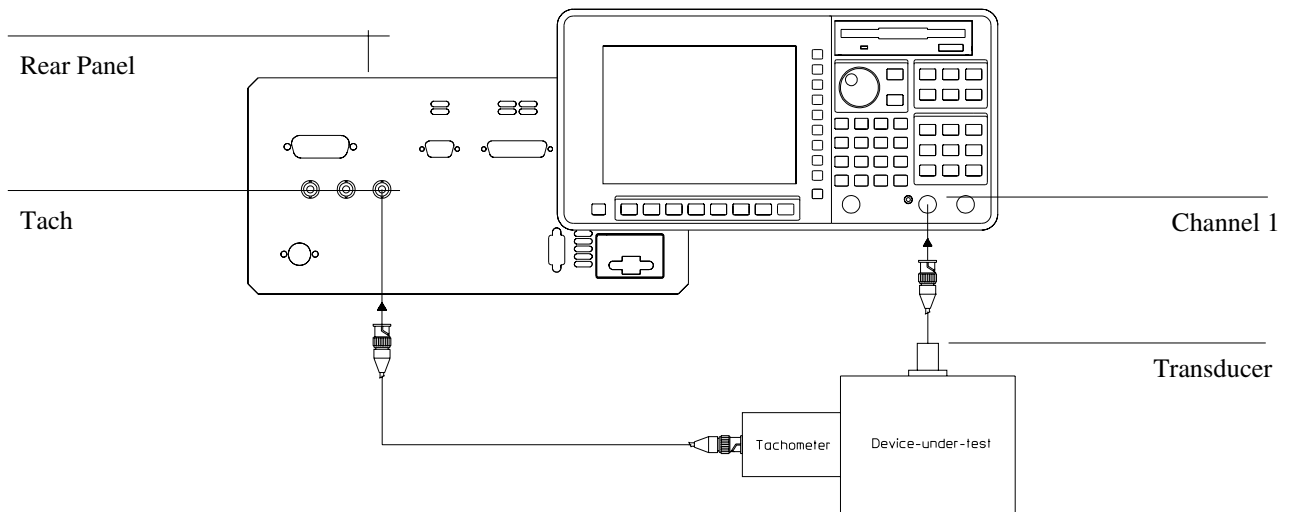

3 Specify the measurement parameters.

Press [**Input**] [XDCR UNIT CH1 SETUP].

Press [XDCR UNIT ON OFF] to highlight ON.

Press [XDCR SENSITVTY] <number> <unit>.

Press [XDCR UNIT LABEL] [g] [**Rtn**].

4 Configure the display.

Press [**Trace Coord**] [LOG MAGNITUDE].

Press [**Scale**], then press[AUTOSCALE ON OFF] to highlight ON, then press it again to highlight OFF.

Press [**Trace Coord**] [Y UNITS].

Press [AMPLITUDE PK PP RMS] to highlight PK.

Press [EU].

Press [**Display Format**] [WATERFALL SETUP], then press [WATERFALL ON OFF] to highlight ON.

Press [SKEW ON OFF] to highlight ON.

5 Measure the DUT.

Press [**Start**].

If you turn on the ICP current source in Step 2, AC coupling is automatically engaged to maximize dynamic range and minimize distortion. Allow approximately 30 seconds for time to charge the AC/DC capacitor and for the input range to stabilize.

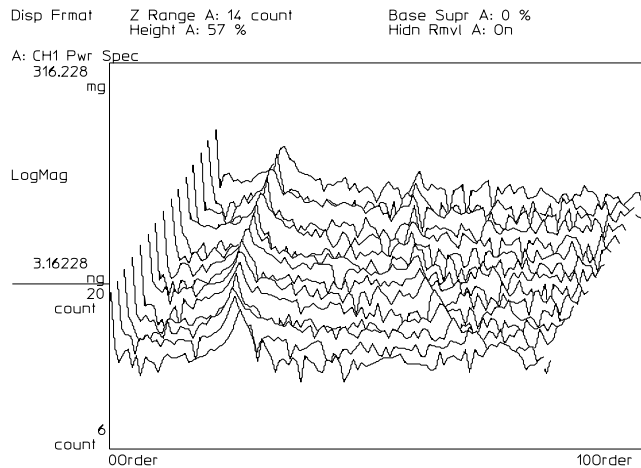

Saving and Plotting Data

Saving and Plotting Data

This section shows you how to perform some basic disk operations and how to plot the contents of the analyzer's screen.

To format a flexible disk

- 1** Insert a 3.5-inch flexible disk into the analyzer's internal disk drive.
- 2** Press **[Disk Utility]** **[DEFAULT DISK]** **[INTERNAL DISK]**.
Press **[Rtn]**.
- 3** Press **[FORMAT DISK]** **[DISK TYPE]**, then press **[LIF DOS]** to highlight **LIF**.
The default is DOS.
- 4** Press **[INTRLEAVE FACTOR]** **[0]** **[ENTER]**. **[0]** is the default.
- 5** Press **[PERFORM FORMAT]** **[ENTER]**.

Caution

You can damage both the disk and the drive if you attempt to eject a disk when the "FORMAT DISK in Progress" message is displayed or when the disk's busy light is on.

You must format a 3.5-inch flexible disk before you can use it to store Agilent 35670A data. Use a double-sided double-density or high-density disk that is *not* write-protected. (See the illustration.) The analyzer takes about two and a half minutes to format a disk and is unavailable for other tasks during that time.

The analyzer offers two types of disk formats—LIF and DOS. Step 3 sets the format. Step 4 defines the sector numbering (interleave factor) to the default value (1 for LIF formatted disks or 3 for DOS formatted disks). For more information on the formatting parameters, use online help.

The Disk-eject button

Do not eject the disk when the "busy" light is on

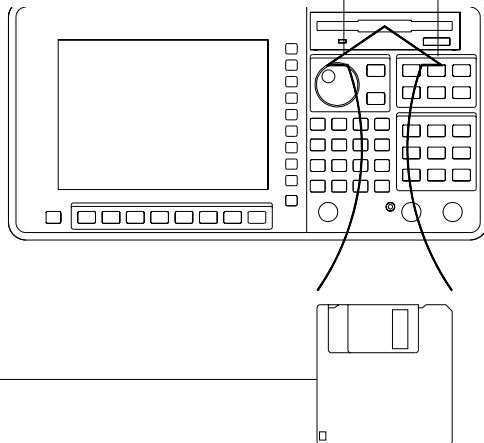

Use a 3.5-inch flexible disk (DS, DD) or (DS, HD)

To save a trace to a file

- 1** Activate the trace if the one you want to save is not currently active. See “To select the active trace” in the Working with the Display section.
- 2** Press [**Save/Recall**] [SAVE DATA] [SAVE TRACE] [INTO FILE].
- 3** Type a file name, then press [ENTER].
or
Use the default name.

After you have entered a file name the analyzer saves the active trace to a file on the default disk. The analyzer automatically increments the default file name during successive save operations. For more information on typing a file name and selecting the default disk, see “To type a text string” and “To select the default disk” earlier in this book.

To save a trace to a data register, repeat step 2 except press one of the data register softkeys, rather than the [INTO FILE] softkey.

To recall a trace from a file

- 1 Press [Save/Recall], then press [CATALOG ON OFF] to highlight ON.
- 2 Turn the knob to highlight the file you want to recall.
- 3 Press [RECALL DATA] [RCL TRACE] [FROM FILE INTO D1] [ENTER].
- 4 Activate the appropriate trace if the one you want to replace is not currently active. See “To activate a trace.”
- 5 Press [Meas Data] [MORE CHOICES] [DATA REGISTER] [D1].

It is generally easier to recall a trace if you display the disk catalog and highlight the trace file first. When you do this, the prompt box that is displayed when you press [FROM FILE INTO D1] already contains the correct file name. You only need to press enter to recall the file. If you do not display the catalog first, you will need to type the correct file name into the prompt box before you press enter.

The analyzer always recalls a trace into a data register. Steps 4 and 5 allow you to view the recalled trace by selecting the contents of that data register for display.

The analyzer recalls the highlighted file

Save/Rec		Def Disk: Internal		RMT SRQ		SAVE DATA
MEASUREMENT PAUSED		AVAILABLE SPACE: 225280		AW 1 2 3 4 CH 1 2 3 4		SAVE STATE
DIRECTORY: \	DOS INT:	SIZE	TYPE	LAST CHANGED		
TEST1.DAT	218720	DOS	06-23-92	04:30:18 PM		SAVE MORE
TEST1.STA	2922	DOS	06-23-92	04:30:21 PM		
TRAC1.DAT	1462	DOS	06-23-92	04:31:07 PM		RECALL DATA
AUTO ST STA	11598	DOS	06-18-92	04:23:04 PM		
TEST2.DAT	218720	DOS	02-13-90	11:24:06 AM		RECALL STATE
SYNTRACE.DAT	4513	DOS	07-08-96	01:49:25 PM		
DISTORT1.DAT	3362	DOS	08-06-92	08:10:10 AM		RECALL MORE
TEST2.STA	2922	DOS	02-13-90	11:19:12 AM		RECALL AUTOSTATE
TRAC10.DAT	3362	DOS	06-23-92	04:38:03 PM		CATALOG OFF
AUTO STA	11598	DOS	06-24-92	11:20:27 AM		DEFAULT DISK
SYNT1.SYN	1402	DOS	07-08-96	01:45:17 PM		
SQUARE.DAT	5406	DOS	08-06-92	08:10:29 AM		
DISTORT.STA	11614	DOS	08-06-92	08:11:20 AM		

To save a trace to a data register

- 1 Activate the trace if the one you want to save is not currently active. See “To select the active trace.”
- 2 Press **[Save/Recall]** **[SAVE DATA]** **[SAVE TRACE]** **[INTO D1]**.

Data registers are cleared each time you turn off the analyzer. The analyzer uses the data registers to store the contents of certain operations.

- D6—is a default data register for the curve fit operation.
- D7—is a default data register for the curve fit operation.
- D8—is the default data register for the synthesis operation.

To recall a trace from a data register, see steps 4 and 5 of “To recall a trace from a file.”

To setup your plotter — GPIB

- 1 Connect the GPIB ports of your plotter and analyzer with an GPIB cable.
- 2 Verify the GPIB address of the analyzer.
See “To set the analyzer’s GPIB address” in the Setting Up section.
- 3 Turn on the plotter.
- 4 Determine the GPIB address of the plotter.
If you need to change the setting on the analyzer, press **[Local/GPIB]**
[PLOTTER ADDRESS] <number> **[ENTER]**.
- 5 Press **[SYSTEM CONTROLLR]**.

The current setting for the plotter’s address appears at the top of the display. Refer to your plotter’s documentation to determine its GPIB address. If you need to change it, substitute the value for <number> in Step 4.

If there is more than one controller on the bus, the analyzer needs to have active control instead of system control to initiate a plot. See “Passing Control” in the *GPIB Programmer’s Guide* for more information.

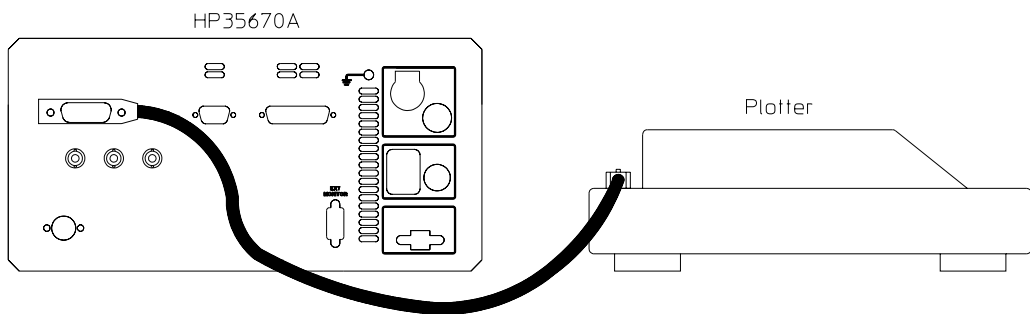

To setup your plotter — Serial

- 1 Connect the serial ports of your plotter and analyzer with a RS-232-C cable.
- 2 Check the plotter's documentation to verify the serial configuration.
- 3 Turn on the plotter.
- 4 To set the plotter's baud rate on the analyzer, press **[Plot/Print]** **[MORE SETUP]** **[SERIAL SETUP]** **[BAUD RATE]**. The softkey steps through the available values.
- 5 In the same menu, set the transmitter's (the analyzer's) handshake pacing type. Press **[XMIT PACE]**. The softkey steps through the available values.
- 6 Set the other parameter values, if you need to change the settings.

The configuration is saved in non-volatile RAM. Refer to your plotter's documentation to determine the required serial configuration. The analyzer is considered the transmitter and the plotter is considered the receiver.

The default values should satisfy the configuration for most plotters. Additional parameters that you can change are:

- **[BITS/CHAR]** — specifies the number bits in each character.
- **[STOP BITS]** — specifies the number of “stop bits” sent with each character.
- **[PARITY]** — sets the parity generated for characters.
- **[PRTY CHK]** — enables parity verification capability.
- **[RCVR PACE]** — sets the receiver handshake pacing type.

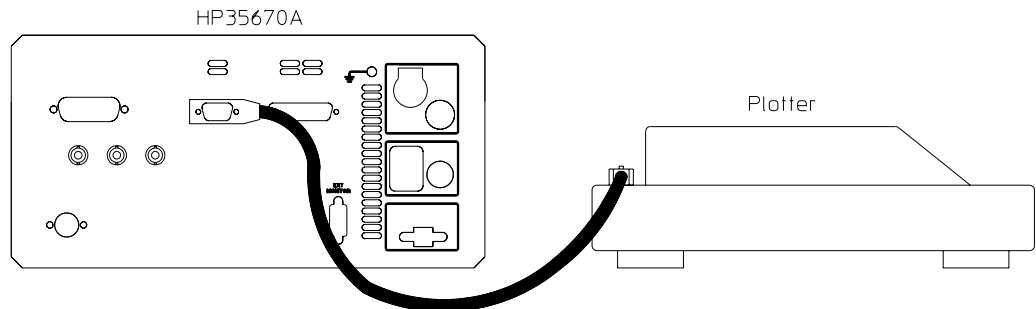

To plot screen contents

- 1** Set up your plotter.
- 2** Press [**Local/GPIB**] [SYSTEM CONTROLLER].
- 3** Press [**Plot/Print**][PLOT/PRINT DEVICE] [HP-GL PLOTTER].
Press [**Rtn**].
- 4** Press [PLOT/PRINT DESTINATION].
Press the [OUTPUT TO GPIB] if your plotter is connected to the GPIB
(see “To setup your plotter—GPIB.”)
or
Press [OUTPUT TO SERIAL] if your plotter is connected to the RS-232-C
(see “To setup your plotter —RS-232-C.”)
or
Press [OUTPUT TO PARALLEL] if your plotter is connected to the parallel port.
or
Press [OUTPUT TO FILE] to plot the contents of the screen to a file
(see “To select the default disk”).
- 5** Press [**Rtn**].
- 6** Press [**Plot/Print**] [START PLOT/PRINT].

The analyzer is only able to initiate plotting if the plotter is connected to the appropriate port *and* if the analyzer is designated as the system controller. All of the contents of the screen, except the softkey labels, are plotted when you complete this task.

To print the contents of the screen, press [PLOT/PRINT DEVICE] [RASTER PRINTER] in Step 3. Be sure a printer is connected to the appropriate interface port.

Automating Measurements

Automating Measurements

This section shows you how to customize your analyzer and introduces the analyzer's keystroke recording feature . Keystroke recording is an optional feature that is available under the [**Basic**] hardkey when you order Option 1C2, Instrument BASIC.

To select the active Instrument BASIC program

- 1 Press **[Basic]** [INSTRUMNT BASIC] [SELECT PROGRAM].
- 2 Press [PROGRAM 1].
or
Press [PROGRAM 2].
or
Press [PROGRAM 3].
or
Press [PROGRAM 4].
or
Press [PROGRAM 5].
- 3 Press **[Rtn]**.

The analyzer has five program buffers. Only one program buffer can be active at any one time. The currently active program appears at the top of the display.

The softkeys may have different labels. Press the softkey corresponding to the program you want to activate.

Active Program

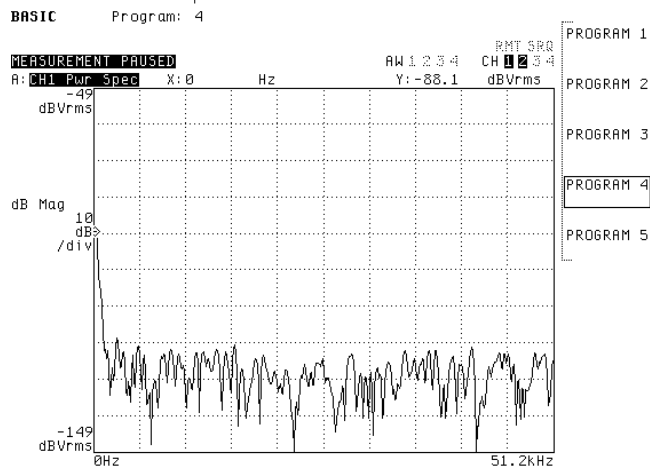

To record a measurement sequence

- 1 Select the active program.
(See the previous task, “To select the active Instrument BASIC program.”)
- 2 Press [**Basic**] [INSTRUMNT BASIC] [UTILITIES] [SCRATCH] [SCRATCH].
Press [PERFORM SCRATCH] [**Rtn**][**Rtn**].
- 3 Press [ENABLE RECORDING].
- 4 Press the keys in your measurement sequence.
- 5 Press [**Basic**] to end recording.

When you record a measurement sequence with Instrument BASIC, the analyzer converts key-presses to equivalent GPIB commands. The commands are then inserted in BASIC program lines in the analyzer’s active program buffer. The second step of this task clears the program buffer so your measurement sequence will not be inserted into an existing program. The remaining steps actually record your key-presses.

To produce consistent results, it is important to make [**Preset**] [DO PRESET] the first keys you press in step 4. [DO PRESET] eliminates many unknowns by returning most analyzer parameters to their default states. To learn more, see *Using Instrument BASIC with the Agilent 35670A*.

GPIB Commands
equivalent to your key
presses are enclosed in
quotes

Recorded BASIC program
is
displayed when you press
[BASIC] [Instrument
BASIC]
[EDIT PROGRAM]

```

1 ASSIGN @Hp35670a TO 800          ENTER
2 OUTPUT @Hp35670a:"SYST: PRES"
3 OUTPUT @Hp35670a:"INST: FFT"
4 OUTPUT @Hp35670a:"CALC1: FEED 'XFR: POW 1': MATH: STAT  INSERT
5 OUTPUT @Hp35670a:"SOUR: FUNC PCH"  SPACE
6
7
8 OUTPUT @Hp35670a:"SOUR: VOLT 0.99975 Vrms"  INSERT
9 OUTPUT @Hp35670a:"OUTP ON"              LINE
10 OUTPUT @Hp35670a:"WIND HANN"
11 OUTPUT @Hp35670a:"AVER ON"             DELETE
12 END                                     LINE
                                           RECALL
                                           LINE
                                           DELETE
                                           CHARACTER
                                           TYPING
                                           UTILITIES
                                           GOTO
                                           LINE
                                           END
                                           EDIT

```

To execute a recorded measurement sequence

- 1 Press [**Basic**].
- 2 Press [RUN PROGRAM 1].
or
Press [RUN PROGRAM 2].
or
Press [RUN PROGRAM 3].
or
Press [RUN PROGRAM 4].
or
Press [RUN PROGRAM 5].

This task runs the program currently loaded in the selected program buffer. To run the program in the *active* program buffer, press [**Basic**] [INSTRUMENT BASIC] [RUN PROGRAM].

If your program is stored on one of the analyzer's disks, you will need to load it into the active program buffer before running it. (You can recall programs with the [RECALL PROGRAM] softkey, located in the [**Save/Recall**] menu.

Once your program is running, you can stop it by pressing one of three keys:

- Press [**Basic**] to PAUSE the program.
- Press [**Local/GPIB**] to ABORT the program.
- Press [**Preset**] to ABORT the program. To preset the analyzer, press [DO PRESET].

See *Using Instrument BASIC with the Agilent 35670A* for more information on pausing and stopping a program.

To customize your analyzer

Creating an AUTO_ST.STA file allows you to automatically specify a specific measurement state when you turn on the analyzer or when you press [**Preset**] [RECALL AUTOSTATE].

- 1** Initialize the analyzer.
Press [**Preset**] [DO PRESET].
- 2** Configure the analyzer to fit your application.
- 3** Select the default disk, either the non-volatile RAM disk or the internal disk.
See “To select the default disk” in the second section, Setting Up.
- 4** Save the measurement state.
If the internal disk drive is the default disk, insert a 3.5 inch floppy disk.
Press [**Save/Recall**] [SAVE MORE] [SAVE AUTOSTATE].
Press [ENTER].

At power-up, the analyzer searches the internal disk drive first and then searches the non-volatile RAM disk for the “AUTO_ST” file. If it is found, the analyzer loads the measurement state immediately.

To save an Instrument BASIC program to disk

- 1 Select the active Instrument BASIC program.
- 2 Select the default disk.
- 3 Press [Save/Recall] [SAVE MORE].
Press [SAVE PROGRAM].
- 4 Type a file name, then press [ENTER].
- 5 If the program had been saved before, press [OVERWRITE FILE].

After you have entered a file name the analyzer saves the active program to a file on the default disk. If the file name ends with a number (for example, PROG1), the analyzer automatically increments the default file name during successive save operations. For more information on typing a file name and selecting the default disk, see “To type a text string” and “To select the default disk” earlier in this book.

To save a program, press [SAVE PROGRAM]

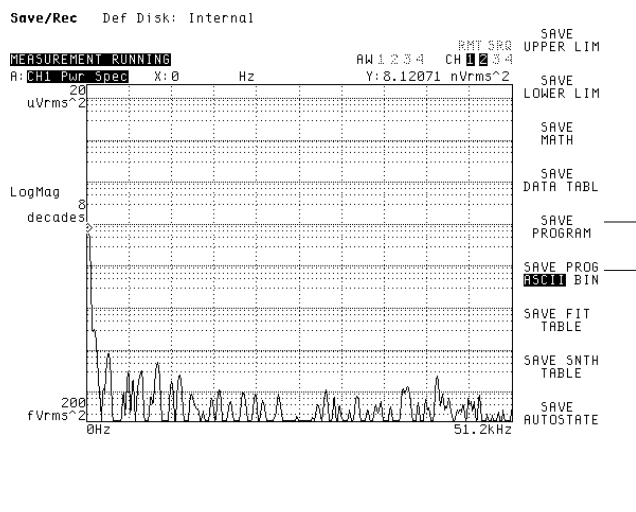

Determines if program is saved as an ASCII file or binary file

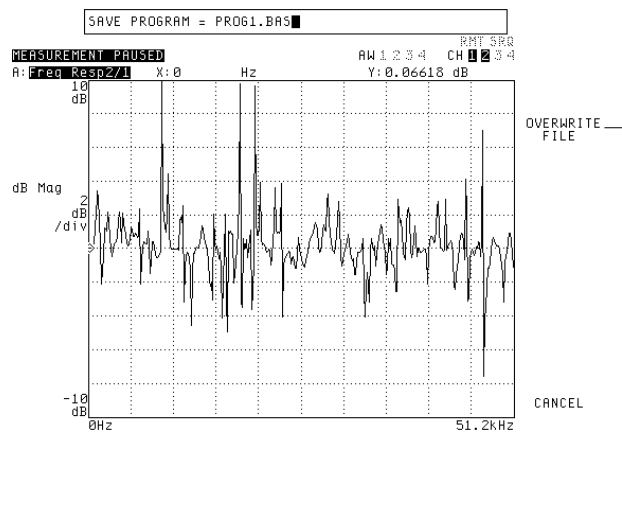

If program already exists, press [OVERWRITE FILE]

Index

Index

A

AC power 2
active trace 18 - 19
address
 analyzer 14
 plotter 52
analyzer
 customizing 59
 HP-IB address 14
 setting the clock 15
AUTO_ST 59
autoscaling 22
autosequence 57
average, specifying 29

B

BASIC
 See Instrument BASIC
battery power 3

C

calibrating, microphone 34
clock, setting 15

D

data register, saving a trace 51
date, setting 15
DC power 3
disk
 default 16
 formatting 48
 saving a program 60
 saving a trace 49
display
 activating a trace 18
 measurement state 23

 plotting contents 54
 scaling 22
 selecting data 20
dynamic range 28

E

entering
 numbers 10
 parameters 24
 text 9

F

FFT, frequency response 30
files
 recalling 50
 saving 49
formatting disks 48
frequency response
 FFT 30
 swept-sine 32
frequency span, setting 28

G

GPIB
 analyzer's address 14
 plotter's address 52
 plotting 54

H

harmonic distortion 38
help, online 4
histogram, unfiltered time 40
holdoff time 42

I

- ICP, turning on 45
- impedance
 - input 29, 31
 - source 31
- inputs
 - activating channels 6 - 7
 - setting reference 6 - 7
- Instrument BASIC
 - active program 56
 - recording a program 57
 - running a program 58
 - saving to a file 60
- instrument modes 8
- instrument state
 - See* measurement state
- internal disk 16

K

- keyboard, using 9
- keystroke recording 57

L

- line power, using 2

M

- map displays 25
- markers
 - absolute 39
 - axes scale 41
 - harmonic 39
 - moving the main 11
 - reference 12
 - relative 12
- mass storage 16
- measurement data
 - scaling 22
 - selecting 20
- measurement state 5
 - at power-up 59
 - displaying 23
 - updating 24
- measuring
 - frequency response 30, 32
 - fundamental frequency 38
 - microphone calibration 34

- order spectrum 45
- sound pressure level 36
- spectrum 28
- tach pulse 40
- THD 38
- time waveform 41

O

- octave analysis
 - microphone calibration 34
 - sound pressure level 36
- online help, using 4
- order analysis 45
- order spectrum 45
- overload indicator 33

P

- parameters, entering 24
- peak-to-peak value, determining 12, 41
- plotter
 - HP-IB address 52
 - serial 53
- plotting, screen 54
- preset 5
- printing, screen 54
- program
 - active 56
 - executing 58
 - recording 57
 - running 58

R

- recalling
 - a trace 50
 - files 50
- recording keystrokes 57
- reference markers 12
- register, saving a trace 51
- relative markers 12
- resolution 29
- RPM indicator 41

RS-232-C
 configuring 53
 plotting 54
 running a program 58

S

saving
 a program 60
 trace data 49
scaling 22
selecting data 20
setting default disk 16
setup state 5
sound pressure level 36
span, setting 28
spectrum
 measuring 28, 45
 peak-to-peak value 12
storage devices 16
swept-sine analysis, frequency response
32

T

tachometer
 characterize 40
 holdoff time 42
text, entering 9
text, typing 9
time stamp 15
trace
 activating 18
 displaying 18 - 19
 scaling 22
trace data
 in waterfall 25
 See also measurement data
 plotting 54
 recalling 50
 saving to a data register 51
 saving to a file 49
 selecting 20
transducer units 35, 45
turning on the analyzer 2 - 3
typing text 9

U

units, transducer 35

V

values, entering 10
volatile RAM disk 16

W

waterfall displays 25

Guide to Agilent 35670A Documentation

If you are thinking about...	And you want to...	Then read...
Unpacking and installing the Agilent 35670A	Install the Agilent 35670A Dynamic Signal Analyzer Do operation verification or performance verification tests	<i>Agilent 35670A Installation and Verification Guide</i> <i>Agilent 35670A Installation and Verification Guide</i>
Getting started	Make your first measurements with your new analyzer Review measurement basics Learn what each key does	<i>Agilent 35670A Quick Start Guide</i> <i>Agilent 35670A Operator's Guide</i> Use the analyzer's [Help] key
Making measurements	Learn how to make typical measurements with the Agilent 35670A Understand each of the analyzer's instrument modes	<i>Agilent 35670A Operator's Guide</i> <i>Agilent 35670A Operator's Guide</i>
Creating automated measurements (Instrument BASIC is Option 1C2)	Learn the Instrument BASIC interface Record keystrokes for a particular measurement Program with Instrument BASIC	<i>Using Instrument BASIC with the Agilent 35670A</i> <i>Agilent 35670A Quick Start Guide</i> <i>Instrument BASIC User's Handbook</i>
Remote operation	Learn about the GPIB Learn how to program with GPIB Find specific GPIB commands	<i>GPIB Programmer's Guide</i> <i>GPIB Programming with the HP 35670A</i> <i>Agilent 35670A GPIB Commands: Quick Reference</i>
Using analyzer data with a PC application	Display or plot analyzer data on or from a Personal Computer Transfer analyzer data to a PC software application format Transfer data from a PC software application format to the analyzer (for example, to load data into a data register)	<i>Standard Data Format Utilities: User's Guide</i>
Servicing the analyzer	Adjust, troubleshoot, or repair the analyzer	<i>Agilent 35670A Service Guide</i>

Need Assistance?

If you need assistance, contact your nearest Agilent Technologies Sales and Service Office listed in the Agilent Catalog. You can also find a list of local service representatives on the Web at:

<http://www.agilent.com/find/assist> or contact your nearest regional office listed below.

If you are contacting Agilent Technologies about a problem with your Agilent 35670 Dynamic Signal Analyzer, please provide the following information:

- Model number: Agilent 35670A
- Serial number:
- Options:
- Date the problem was first encountered:
- Circumstances in which the problem was encountered:
- Can you reproduce the problem?
- What effect does this problem have on you?

You may find the serial number and options from the front panel of your analyzer by executing the following:

Press [**System Utility**], [more], [serial number].

Press [**System Utility**], [options setup].

If you do not have access to the Internet, one of these centers can direct you to your nearest representative:

United States	Test and Measurement Call Center (800) 452-4844 (Toll free in US)
Canada	(905) 206-4725
Europe	(31 20) 547 9900
Japan	Measurement Assistance Center (81) 426 56 7832 (81) 426 56 7840 (FAX)
Latin America	(305) 267 4245 (305) 267 4288 (FAX)
Australia/New Zealand	1 800 629 485 (Australia) 0800 738 378 (New Zealand)
Asia-Pacific	(852) 2599 7777 (FAX) (852) 2506 9285

About t his edition

October 2000: Rebranded to Agilent Technologies

January 1995: In this edition, *Setting Up*, page 13, was corrected to refer to “your *HP 35670A Installation and Verification* guide”.

November 1992: Previous edition.