

ATM and LAN
Operating Manual

HP 37717C
Communications
Performance Analyzer

© Copyright Hewlett-Packard Ltd. 1997

All rights reserved. Reproduction, adaption, or translation without prior written permission is prohibited, except as allowed under the copyright laws.

HP Part No. 37717-90286

First edition, September 97

Printed in U.K.

Warranty

The information contained in this document is subject to change without notice.

Hewlett-Packard makes no warranty of any kind with regard to this material, including, but not limited to, the implied warranties or merchantability and fitness for a particular purpose.

Hewlett-Packard shall not be liable for errors contained herein or for incidental or consequential damages in connection with the furnishing, performance, or use of this material.

WARNING

Warning Symbols Used on the Product



The product is marked with this symbol when the user should refer to the instruction manual in order to protect the apparatus against damage.



EN 60335-1:1997

The product is marked with this symbol to indicate that a laser is fitted. The user should refer to the laser safety information in the Calibration Manual.



The product is marked with this symbol to indicate that hazardous voltages are present

Hewlett-Packard Limited
Communications Measurements Division
South Queensferry
West Lothian, Scotland EH30 9TG

ATM and LAN Operating Manual

HP 37717C Communications
Performance Analyzer

About This Book

The information on ATM and LAN testing in this book covers the following subjects:

- Measurement definitions and explanations
- Principal measurement modes
 - Channel View
 - In-Service Testing
 - Out-of-Service testing

Channel View (available with the services modules option USK, USL and the Broadband Auxiliary module option OYK) gives a real time overview of the traffic on a link and provides an individual analysis of each channel.

The In-Service and Out-of-Service applications are sub-divided into groups which depend on combinations of options fitted to your instrument.

During In-Service testing, the tester is used to monitor what is happening. A wide range of results is produced simultaneously for each test.

In some situations, particularly where live traffic is not available, the use of a test signal for Out-of-Service testing is required. In addition to the monitoring capability of In-Service testing, Out-of-Service testing uses the ability to generate a test stimulus.

LAN testing, although primarily intended for ATM installation, operates irrespective of payload.

For some operations and measurements, information from one of the following associated books may be required:

“The HP 37717C Mainframe Operating Manual” explains how to obtain the required display, how to use the front panel keys, how to interpret the status indicators, how to connect to external equipment and how to perform instrument tasks associated with the HP 37717C irrespective of the option configuration.

“The HP 37717C PDH /DSn Operating Manual” describes the selection of PDH / DSn features and how to perform PDH / DSn tests with the HP 37717C Communications Performance Analyzer.

“The HP 37717C SDH / SONET Operating Manual” describes the selection of SDH / SONET features and how to perform SDH / SONET tests with the HP 37717C Communications Performance Analyzer.

“The HP 37717C Jitter Operating Manual” describes the selection of Jitter features and how to perform Jitter tests with the HP 37717C Communications Performance Analyzer.

Contents

1 Introduction to ATM and LAN Testing

Measurements 2
The Elements of LAN Testing 7
Measurement Definitions and Explanations 8
Traffic Simulation 21
Alarms 24

2 ATM and LAN Testing Modules

ATM Modules 28
LAN Testing Module 32
ATM Module Features 33
Cell Level ATM (Options UKN (USE) and UKZ) 33
ATM Services Modules (Options USK and USL) and Broadband
Auxiliary Module (Option 0YK) 38
LAN Module Features (Option USL) 42

3 Link Traffic Overview

ATM Channel View 48

4 In-Service ATM Testing

Introduction to In-Service Testing 54
Cell Layer Error Measurement 57
Service Policing 61

Contents

Individual Service Performance 63

5 Out-of-Service ATM Testing

ATM Cell Performance Test 66

Cell Routing Test 72

Cell Congestion Test 73

Cell Sync and Header Error Correction Test 75

Measuring Cell Transfer Delay and Cell Delay Variation 77

Constant Bit Rate Service Assessment 79

Alarm Testing 80

6 LAN Testing Examples

Continuity Testing and Discontinuity Location 82

Packet Loss and Response Time 86

Packet Loss and Response Time Under Load 90

Error Correction Level Indication 95

Ethernet Collisions 98

7 Pre-stored Cell Streams

1

Measurements page 2

The Elements of LAN Testing page 7

Measurement Definitions and Explanations page 8

Traffic Simulation page 21

Alarms page 24

Introduction to ATM and LAN Testing

This chapter contains information about ATM and LAN testing together with the facilities available in the HP37717C.

Introduction to ATM and LAN Testing
Measurements

Measurements

Physical Measurements

Physical layer measurements indicate any problems which may give rise to errors on cells present on the physical link. The ATM layer impairments observed while testing a VPI or VCI may have originated on another physical transmission link. Correlation of physical layer results with ATM layer results will help to identify the source of the problem.

If interfacing at the STM-1, OC-3c or STM-4 physical layer generation and measurement of the SDH / SONET overhead is identical to that of normal SDH / SONET operation.

If interfacing at the 34 Mb/s or 140 Mb/s physical layer G.832 transmission convergence framing structure is used. This results in different measurements from those obtained during normal PDH / DS_n operation:

- EM BIP-8 errors
- FEBE errors
- Loss of frame (G.832) detected
- AIS and FERF alarms detected
- TR trail trace is user defined in the transmitter, and is detected and displayed in the receiver.

If interfacing at DS3, there is a choice of direct or PLCP convergence sub-layer. This results in the following additional results being available when PLCP mapping is selected:

- Trailer errors
- PLCP Frame Loss
- PLCP RAI
- PLCP Link Status, this value is captured

If interfacing at the 2 Mb/s or DS1 physical layer there is no additional transmission convergence information and the measurement results obtained are a subset of those obtained during normal PDH / DS_n operation.

Introduction to ATM and LAN Testing
Measurements

ATM Layer measurements - Out-of-Service.

Header Errors

ATM cell delineation (except in the case of DS3 PLCP mapping) and error detection or correction is achieved by using a Header Error Control byte (HEC). The HEC byte is the fifth byte of the ATM cell header. Using the HEC byte, a single header error may be corrected or multiple header errors may be detected. The HP 37717C measures corrected headers and non-corrected headers. If a header value is corrected, the payload is then available for measurement processing. If a non-correctable header error is detected, the event is recorded and the cell is discarded.

Cell Errors

Cell errors are usually due to physical layer transmission impairments. An errored cell will be recorded if one or more bit errors are detected in the ATM payload.

Cell Loss

Cells may be lost due to physical layer transmission errors on the ATM header or due to congestion in ATM switches.

Cell Misinsertion

Physical layer transmission errors on the ATM overhead may cause the VPI/VCI to be changed to another valid value. This will cause a cell to be misinserted into another channel. Other causes include malfunctions of the ATM switch fabric.

Cell Transfer Delays

Delay may be introduced because of physical layer switching and propagation delays. Such delay is predominately fixed delay. Delay may also occur because of traffic shaping. This delay is an aggregate of variable delay and fixed delay.

Cell Delay Variation (CDV)

CDV (or cell jitter) is the variation in cell transfer delay caused by variations in depths of queues in buffers and variations in cell multiplexing delays. This will be accentuated when a virtual circuit is multiplexed with highly variable traffic load or when congestion is approached in ATM switches.

2-point CDV, Mean Cell Transfer Delay and Maximum Cell Delay

These cell delay measurements, including 2-point Cell Delay Variation (2-pt CDV) are out-of-service measurements available when the Test Cell is selected as the ATM payload. Mean Cell Transfer Delay, Max Cell Transfer Delay and 2-pt CDV measurements use information at two points - the transmit end and the receive end.

Introduction to ATM and LAN Testing Measurements

Test cells contain time stamps which are inserted when the test cell is generated in the test equipment. At the test equipment receiver, the time stamps are compared with the time of arrival of the test cells making it possible to measure the cell delay and cell delay variation across a network or network element connected between the transmitter and receiver of the test equipment.

Because timestamps are used, these delay measurements indicate the delay added to the ATM cells by the ATM network and are not a function of the cell transmission rate and distribution used e.g. periodic, burst etc. However, the ATM network may respond differently as the cell rate and distribution are varied.

Because it is not possible to synchronize the timestamps in two different instruments, cell delay measurements other than 1-point CDV must be performed using the same instrument to transmit and receive the test cell signal.

The 2-point CDV measurement conforms to ITU-T Recommendation I.356

Cell delay results are processed to provide the following cumulative (not short term) measurements:

- Mean cell transfer delay - the cell delay averaged over the gating period.
- Maximum cell transfer delay - the maximum cell delay over the gating period.
- Peak to peak 2-point CDV - the maximum cell delay minus the minimum cell delay over the gating period.

1-point CDV

1-point CDV is so called because the Cell Delay Variation is measured at one point i.e. where the signal is being received. It does not require the use of timestamps and so may be performed In-Service or Out-of-Service. 1-point CDV is a combination of the CDV of the source traffic and the CDV added by the network. 1-point CDV is more meaningful than Interarrival Time as it can be directly related to network buffer depths.

For example, the maximum 1-point CDV value represents the minimum buffer depth (in time) which would be required to remove the accumulated CDV at the measurement point. The 1-point CDV algorithm conforms to ITU-T Recommendation I.356. 1-point CDV measurements are available irrespective of cell payload.

Two 1-point CDV measurements are available:

- Maximum 1-point CDV.
- Non-Conforming cell count - the number of cells exceeding a user selectable CDV threshold. This threshold is called the CDV tolerance.

Introduction to ATM and LAN Testing Measurements

A more detailed account of the CDV measurement theory is given on page 17.

VP/VC Rate History.

Provides a graphical record of Maximum, Minimum and Mean cell rate over a period of time. For more information see page 16 and page 61.

Channel View

Provides a pictorial overview of the traffic present on a link by identifying every VPI/VCI and measuring cell count or cell rate on up to 1023 channels. Payload and alarm information is listed with each channel. An individual channel of interest may be selected conveniently from this display for subsequent performance error measurement, for example ATM Adaptation Layer (AAL) errors. For more information see page 5 and page 47.

AAL Error Monitoring

This in-service measurement uses the known structures of the AAL, generated by end equipment, to measure errors introduced by network transmission and switching.

AAL-1. The instrument analyses the sequence numbers in the single byte of the protocol control information (PCI). The only PCI in AAL-1 is the first byte of the 48-byte Segmentation and Reassembly Protocol Data Unit (SAR-PDU) (cell information field). This byte contains a 3-bit sequence number and a 1-bit CSI (convergence sublayer indication) which are protected (and to a limited extent corrected) by an additional 4 bits of sequence number protection. This consists of a 3-bit CRC and a 1-bit parity check. The integrity of the sequence is checked by the instrument to identify error instances caused by misinserted, reordered, and lost cells. There is no differentiation between lost and misinserted cells in the error calculation. The error algorithm merely counts all errors as if they were due to lost cells, and counts what it believes are lost cells. Hence, a pair of reordered cells (although unlikely) will appear as 8 'lost' cells. See page 9 and page 12. See also ITU-T Rec I.356.

AAL-3/4. The instrument measures various types of cell and segment error, counts SAR-PDUs and CS-PDUs. AAL-3/4 includes the possibility of multiplexing up to 1024 concurrent Convergence Sublayer Protocol Data Units (CS-PDUs) on the same virtual channel, with cells of the same stream being identified by their common 10-bit Multiplex IDentification (MID) value. The instrument copes with the resultant interleaved sequence numbers and segment-type sequences, treating them independently even although they are interleaved. However, since MID values are allocated by software in the terminal equipment, the MID values are not normally known to the user or installer. For this reason the error aggregate for all

Introduction to ATM and LAN Testing
Measurements

cells in a channel is displayed regardless of the MID. See also page 9 and page 13. See also ITU-T Rec I.356.

AAL-5. The instrument operates in AAL-5 analysis at a level in the AAL close to the structure of the user-service where the individual Cells are no longer visible. It first performs the receive functions of the Segmentation And Reassembly (SAR) sublayer to reassemble the data and then implements some of the Common Part Convergence Sublayer (CPCS) to check aspects of data integrity at the internal AAL packet level (CPCS-PDUs of up to 65,535 octets, which may already be blocks segmented from longer data). See page 9 and page 14. See also ITU-T Rec I.356.

Introduction to ATM and LAN Testing
The Elements of LAN Testing

The Elements of LAN Testing

The main requirements for LAN testing are:

- Network continuity checking at Installation
- Performance checking at Installation
- Fault Isolation between the LAN and the Communications Network

Normal LAN transmissions use automatic error correction as part of the Transmission Control Protocol (TCP). Error correction causes retransmission of impaired received packets. This feature may mask network problems.

The HP 37717C with the USL LAN testing module provides test signals (pings) which are not subject to error correction. As most addressable devices operating in an IP environment automatically respond to pings, this feature may be used for the isolation of connectivity problems.

As pings are not subject to error correction any errored pings are lost. A measurement of lost pings may indicate network problems which would otherwise have resulted in error detection and retransmission.

Network elements, for example those which contain buffers, may introduce unacceptable delays. Pings contain sequence numbers which allow the measurement of round trip delay.

Performance may be degraded under load conditions and therefore background loading is needed such that the network may be tested under varying load conditions.

The HP 37717C with the USL LAN testing module also provides test signals which are subject to error correction.

The transfer rate of data which is subject to error correction is an indication of the overall performance of the system and gives an indication of the level of error correction being used.

Introduction to ATM and LAN Testing
Measurement Definitions and Explanations

Measurement Definitions and Explanations

Channel View

A graphic overview of the traffic at a point in the network is provided with Channel View which is available with the ATM Services modules, USK and USL and Broadband Auxiliary module 0YK. Channel View is therefore a normal starting point for many investigations.

Although its main use is for the investigation of In-Service conditions, it has applications Out-of-Service, for example in the rapid location of VPs and VCs from simulated data during installation. Channel View is therefore selectable as an alternative to In-Service or Out of-Service operation.

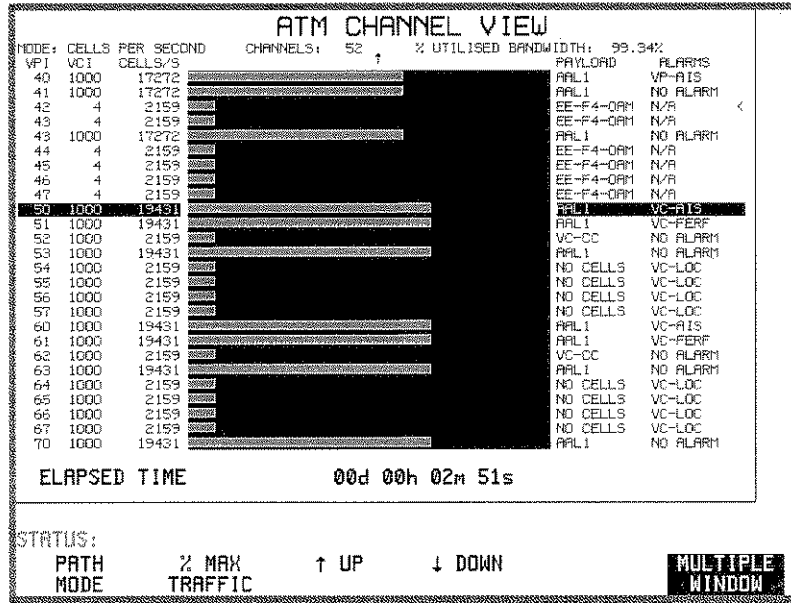

The mean cell load (for example total cell count, cells/s, or % max traffic) is displayed in real time for each VPI / VCI present. Each channel is then analyzed in sequence for the payload and alarm information shown on the rightmost side of the display.

Idle or unassigned cells are also counted but not displayed.

Introduction to ATM and LAN Testing

Measurement Definitions and Explanations

The% overall bandwidth utilized by user and OAM cells is displayed. The idle / unassigned content can be derived by subtracting the% utilized bandwidth from 100%.

The measurement is performed on the first 1023 channels discovered.

Information on obtaining this display, restricting the VPs displayed and selecting the order of display is given on page 48.

Details of the Payload and Alarms information is given on page 51.

PDH / DSn Physical Layer Measurements

The PDH / DSn physical layer measurements are covered in "PDH / DSn Testing with the HP 37717C".

SDH / SONET Physical Layer Measurements

The SDH / SONET physical layer measurements are covered in "SDH / SONET Testing with the HP 37717C".

AAL Sublayer Measurements

AAL sublayer measurements provide a powerful way of assessing quality of service using live data.

The mapping of services into ATM cells is performed by the ATM Adaptation Layer (AAL). Three AALs designed to transport specific types of service have been defined.

AAL-1 has been defined for the transport of constant bit rate (CBR) services. A 3-bit sequence number is used in AAL-1 to detect cell loss and misinsertion so that cells can be discarded or replaced to ensure the data transfer rate is not affected.

AAL- 3/4 has been defined to transport services made up of variable length frames such as those of SMDS and can handle frames from multiple services (data streams) multiplexed, cell by cell, in one virtual channel (VC), each service being identified by its own Message IDentification (MID). These frames are divided into segments called AAL 3/4 SAR-PDUs which additionally contain a 4-bit sequence number, a Message ID, a length indicator, a segment type and a CRC-10 (for error detection).

AAL-5 is a simpler alternative to AAL-3/4 and may be used to carry signalling, frame relay, other data, or video signals. The AAL-5 CPCS-PDU contains a length indicator and a CRC-32.

Introduction to ATM and LAN Testing

Measurement Definitions and Explanations

The effect of cell errors, cell loss and cell misinsertion and therefore the quality of service objectives for these parameters, will depend very much on the service being carried and the AAL being used. For example, if LAN traffic is being carried, cell errors, cell loss and cell misinsertion will be detectable by the AAL or higher layer protocol which can then initiate retransmission of errored frames. At some point depending on the frame length being used, the time taken for retransmission may make the throughput of the data unacceptable and will contribute to congestion.

For video data transfer using MPEG-2, AAL-1 or AAL-5 may be used. Cell loss and misinsertion may be detected by AAL-1 sequence number and lost cells substituted by padded payloads. Also, forward error correction may be used to detect and correct errors.

Cell delay and CDV should not materially affect data transfer applications but will affect audio and video services. For telephony and video conferencing the round-trip delay may make communication difficult. CBR services will require CDV to be controlled to allow clock recovery at the receive end. CDV may also cause problems with audio/video synchronisation in video applications.

For services using standard AALs, such as those which support CBR services, and packet protocols, the instrument provides in-service error examination of the AAL structures described above which support the service data. For AAL-1 and AAL-3/4, the SAR sublayer is examined for errors. For AAL-5, the CPCS sublayer is monitored for errors.

The instrument extracts structural information (protocol control information) created by the respective AALs, and analyses it for errors of various types. These may be transmission and switching errors or, more unusually, protocol faults created by end equipment.

This is an In-Service measurement, and the instrument does not specifically transmit any corresponding AAL structures itself. (For instrument test and demonstration purposes, the Stored Cell Stream may be used as a source.)

When there is no known AAL present, the receiver displays ATM ADAPTATION LAYER, NO AAL MEASUREMENT and prevents inappropriate AAL alarms.

AAL Loss Alarm

For measurement purposes, indication of the absence of an expected AAL is useful. The instrument therefore has an AAL LOSS indicator. The criteria used for declaring and clearing the AAL LOSS alarm are as follows:

For AAL Loss and Regain purposes, an ERRORED PDU is defined as follows:

Introduction to ATM and LAN Testing
Measurement Definitions and Explanations

- | | |
|---|---|
| AAL Loss Criterion. (all AALs) | 7 consecutive ERRORED PDUs |
| Additional AAL Loss Criterion. (AAL-5 only) | Immediately in event of a length over-run (>65535 octets) |
| AAL Regain Criterion: | Receipt of the first PDU without error |
-
- | | |
|---------|---|
| AAL-1 | A SAR-PDU containing a sequence number protection error OR one that is part of an all-zeros sequence. All-zeros is detected after two or more consecutive sequence numbers of value zero. |
| AAL-3/4 | A SAR-PDU containing a CRC-10 error OR one that is part of an all-zeros sequence. All-zeros is detected when the length indicator is zero. |
| AAL-5 | A CPCS-PDU containing a CRC-32 error. |

Introduction to ATM and LAN Testing
Measurement Definitions and Explanations

The Automatic Detection of AAL Type

If the AAL type is not known, automatic examination and selection is provided.

When the receiver ATM ADAPTION LAYER is set to AUTO, the selected AAL is examined to determine whether it is AAL-1, AAL-3/4 or AAL-5. In some cases, for example where there is a lull in packet data, there may be a long delay before the correct type is identified. For this reason the instrument continues searching for an unlimited time.

AAL-1 SAR Sublayer Error Monitoring

Basic AAL-1 measurement information is given in AAL Error Monitoring on page 5.

AAL-1 supports most Constant Bit Rate (CBR) services. The instrument analyses the sequence numbers in the single byte of the protocol control information (PCI).

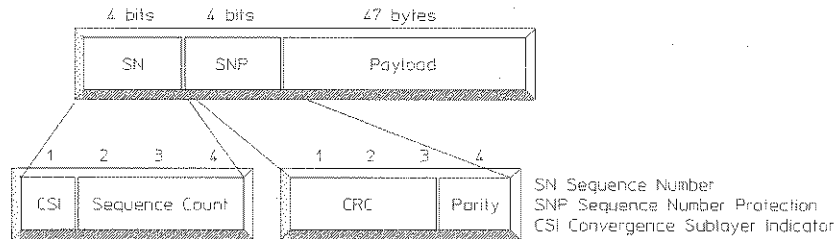

AAL-1 SAR-PDU

The measurements performed on the AAL-1 SAR sublayer are:

SAR-PDU Count.	Count
Corrected Seq. Number Protection:	Count; Ratio
Non-corrected Seq. Number Protection:	Count; Ratio
Lost Cells (based on seq. number):	Count

Corrected Sequence Number Protection refers to the count of SAR-PDUs (the same as count of cells) in which SN error protection has been required to be applied to effect correction, according to ITU-T rec. I.363. Non-corrected Sequence Number Protection refers to the count of SAR-PDUs in which a SN protection error was detected but could not, or would not, be corrected (as defined in I.363). Note that these refer to the sequence number protection, as indicated by the integrity/consistency of the whole PCI byte, not to the sequence numbers themselves. The

Introduction to ATM and LAN Testing
Measurement Definitions and Explanations

denominator for both of these measurements, when expressed as a ratio, is the total of SAR-PDUs received.

The Lost Cells count uses a Sequence Number check algorithm applied to lost cells based on SN errors as validated by the SN protection algorithm defined in I.363.

The derivation of a Sequence Number Error is as follows:

Any deviation from a normally incrementing sequence number is treated as a case of a lost cell(s), of quantity given by: (actual seq. no. - expected seq. no.) mod-8.

ITU-T rec. I.363 detection and correction is used. Sequence numbers are invalidated according to the I.363 specification. No measurements are made on invalid sequence numbers, but the reference is still incremented.

AAL-3/4 SAR Sublayer Error Monitoring

Basic AAL-3/4 measurement information is given in AAL Error Monitoring on page 5.

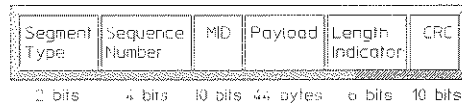

AAL 3-4 SAR-PDU

The measurements performed on the AAL-3/4 SAR sublayer are:

- SAR-PDU Count. Count
- SAR-PDU CRC-10 Errors Count; Ratio (CRC over each separate cell)
- Lost Cells (based on seq. number) Count
- Segment-Type Errors Count
- No.of Abort SAR-PDUs Received Count
- No.of CPCS-PDUs Received Count (as defined by the total number of BOM's and SSM's)

The definition and algorithm for Lost Cells count is as for AAL-1, except that mod-8 is replaced with mod-16.

The denominator for CRC-10 errors, when expressed as a ratio, is the total of SAR-PDUs received.

The derivation of a Segment-Type Error is as follows:

Introduction to ATM and LAN Testing
Measurement Definitions and Explanations

A Segment-Type error is an instance of successive cells having an invalid sequence of Beginning of Message (BOM), Continuation of Message (COM), End of Message (EOM) and Single Segment Message (SSM) coding types. Such an error may occur due to lost or misinserted cells, or possibly by end equipment faults.

The Segment-type error measurement is based on the ITU-T rec. I.363 reassembly algorithm for SAR-PDUs. Segment-type errors are defined by the following logical expression:

$$(CRC-error + abort).((EOM + COM).idle + (SSM + BOM).reass).$$

This is further modified such that only one error is counted if, for example, there is a missing BOM leading to a string of consecutive COMs while in the idle state. In addition, a pair of consecutive BOMs or consecutive EOMs will each register one error. Lost cells are only detected in the reassembly state.

The CRC-10 errors indicate cell payload errors.

AAL-5 CPCS Sublayer Error Monitoring

Basic AAL-5 measurement information is given in AAL Error Monitoring on page 5

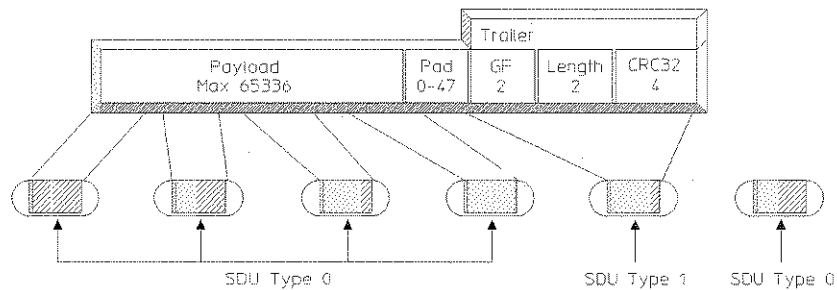

AAL-5 CPCS-PDU

The measurements performed on the AAL-5 CPCS sublayer are:

- Number of CPCS-PDUs Received Count
- CPCS-PDU CRC-32 Errors Count; Ratio (CRC over the whole packet)
- CPCS-PDU Length Errors Count
- CPCS-PDU Length Over-run Count
- Aborted CPCS-SDUs Received Count

Introduction to ATM and LAN Testing

Measurement Definitions and Explanations

A CPCS-PDU Length Error is recorded when the actual number of octets disagrees with the Length field.

A CPCS-PDU Length Over-run is recorded when the ATM layer End-of-SAR-PDU, as indicated by the AUU bit, is not received by the time a maximum length CPCS-PDU (65535 octets), should have been completed.

Up to the level of the CPCS, the AAL is non-service-specific (by definition) and will apply to all services using the AAL-5.

Therefore, irrespective of the application of the packets, the instrument performs the important AAL-level CRC-32 check and verifies the Length (number of octets). This provides a good indication of whether the user or the network is the cause of packet transmission failure. For some user-services, the AAL-5 will not include a Service Specific Convergence Sublayer (SSCS), which otherwise lies above the CPCS, and in this case the checks described are performed directly on packets in exactly the form the user-service understands them.

There is no per-cell AAL level information for AAL-5, and therefore no per-cell SAR measurements.

The CRC-32 is performed over all bits in the CPCS-PDU packet, and will record one packet error irrespective of how many bits are errored or underlying cells are errored, lost, or misinserted. A packet length error occurs whenever the length field disagrees with the number of octets actually counted. Cells lost or misinserted will cause the Length field to disagree by multiples of 48 octets, but any disagreement is regarded as one Length Error count. A Length Error will also give rise to a Packet Error, but a Packet Error may not necessarily produce a Length Error.

Note: Here, the loose term 'packet' means a CPCS-PDU (Protocol Data Unit) within the AAL, and will not always have the same higher level segmentation as that of the data passed to/from the service layers above - except where the SSCS is null.

Introduction to ATM and LAN Testing
Measurement Definitions and Explanations

VP/VC Rate History

This feature may be used to check actual usage of a single VPI / VCI over a period of time for comparison of negotiated mean cell rate with maximum, mean and minimum rates

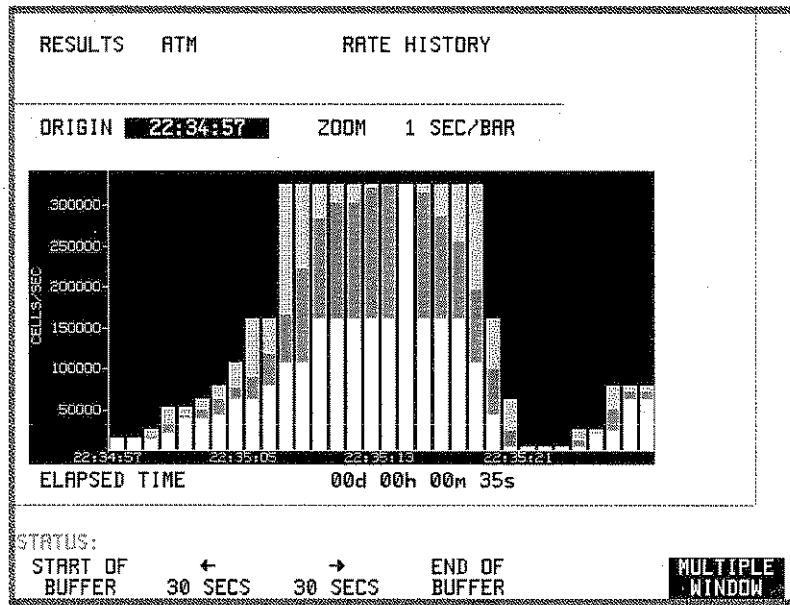

Definitions of the maximum, minimum and mean cell rates are as follows:

- Max Cell Rate Inverse of shortest inter-cell time during measurement.
 In the case of two cells appearing in consecutive positions in the composite stream, the Max Cell Rate measured will be the maximum possible for the link.
- Min Cell Rate Inverse of longest inter-cell time during measurement.
- Mean Cell Rate Average of number of cells received during the measurement interval divided by the interval.

The rates are displayed as superimposed colored bars with the Max Cell Rate at the "back". If some of the rates are approximately equal, one or more of the colors may not be visible. In the case of a near perfect CBR service, all three rates, maximum, minimum and mean would tend to be equal and therefore only one color will tend to be visible.

Introduction to ATM and LAN Testing
Measurement Definitions and Explanations

Cell Delay Variation (CDV) and Non-Conforming Cell Count

CDV detects delay variations which are of concern mainly for constant bit rate services. The closely related Non-conforming Cell Count checks circuit usage for comparison with customer service agreements

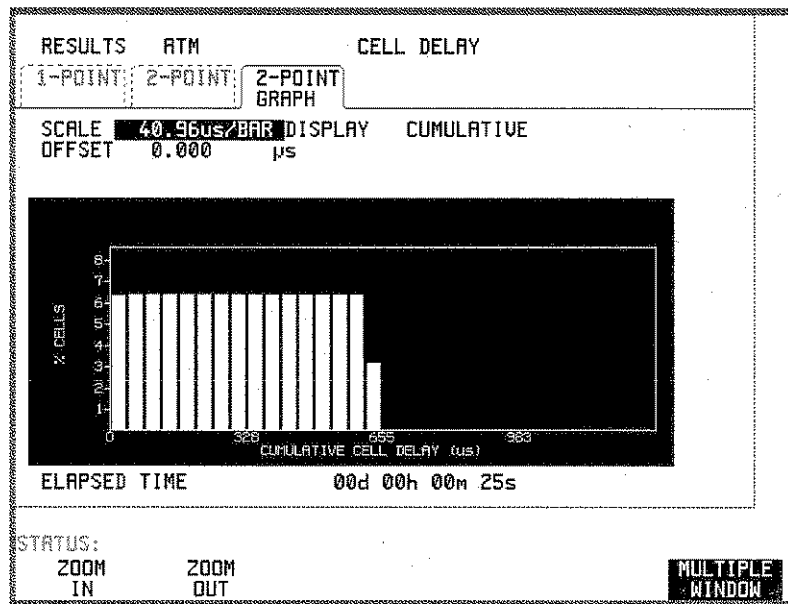

Cell Delay Variation (CDV) occurs whenever the transmission delay of the ATM signal varies from cell to cell. For example, a cell stream that is transmitted with a constant cell rate may arrive at its destination with the cells bunched together. This bunching is caused if several virtual channels require to output a cell from the switch at the same time. Cells must be buffered (and so delayed) until an output opportunity is available. This is known as multiplexing jitter. If a congestion condition is approached in an ATM switch, the delay may increase until eventually cell loss occurs. CDV also arises due to the segmentation process (data must wait until the start of the next cell) and the mapping of ATM cells into the physical layer.

What problems does it cause?

If a large amount of CDV is present in an ATM signal it may cause buffers in an ATM switch to overflow and cause cell loss in the VC. Other VCs using the switch may also be affected.

Introduction to ATM and LAN Testing

Measurement Definitions and Explanations

Excessive CDV causes problems in reconstructing a Constant Bit Rate (CBR) service. When using ATM for circuit emulation, e.g. carrying a 2Mbit/s circuit, CDV must be removed from the signal before the 2Mbit/s can be reconstructed.

How can CDV be controlled?

Each ATM VC may be policed at the input to the network and also at points throughout the network to ensure that traffic is not exceeding the negotiated Peak Cell Rate (PCR) and CDV tolerance. If the signal has too high a rate or too high a CDV value, cells are non-conforming and may be discarded. This is done to avoid buffer overflow in the switches in the link and so protect other channels in the network. The policing function may also be referred to as the UPC (Usage Parameter Control) at the UNI (User network interface) and the NPC (Network Parameter Control) at an NNI (Network Node Interface).

When reconstructing a CBR service at the ATM network termination, buffering must be provided to absorb the CDV. This will however add additional fixed delay to the signal that may also be a problem.

How can CDV be measured?

2-point CDV is a measure of CDV between two points i.e. between the source and the measurement point. This measurement is out-of-service using a special ATM test cell with a timestamp encoded in the payload as defined in ITU-T recommendation O.191. 2-point CDV is the CDV added to the signal by the ATM network, and takes no account of the cell time distribution of the test signal itself.

1-point CDV is a measure of CDV at one point, i.e. the measurement point and involves analysis of cell arrival times with respect to the expected arrival rate. 1-point CDV is a combination of the CDV of the signal source and the CDV added by the ATM network. 1-point CDV measurement may be performed by the GCRA (Generic Cell Rate Algorithm), and this is the technique adopted by the instrument.

What is a GCRA?

The Generic Cell Rate algorithm is standardized in ITU-T Recommendation I.371 and the equivalent ATM Forum Traffic Management Specification. The principal purpose of the GCRA is to perform the policing function and to determine if cells are non-conforming to the negotiated PCR and CDV tolerance.

ITU-T Recommendations and ATM Forum specifications illustrate various equivalent implementations of the GCRA, e.g. the leaky bucket and the virtual scheduling algorithm. The "leaky bucket" is a good analogy for the operation of the algorithm. Cells leak out of the bucket at a constant rate. This is the Peak Cell Rate (PCR). Cells may arrive at a variable rate. If more cells arrive over a given time

Introduction to ATM and LAN Testing

Measurement Definitions and Explanations

period than are leaked out, the bucket fills up. The CDV tolerance is the maximum possible depth of cells in the bucket. If the bucket is going to overflow, cells are discarded (and declared non-conforming) thus preventing overflow. If no cells arrive for a period of time, the bucket will drain at the PCR and remain in the empty state until more cells arrive. For stability of the measurement, the PCR must be greater than or equal to the average cell rate.

The filling up of the bucket illustrates how a FIFO buffer fills up with data. The difference between the input and output pointers is the depth of the buffer. When all data has been read out of the buffer, the buffer is then empty.

Constant Bit Rate Application of the GCRA.

If the Peak Cell Rate is set to equal the average cell rate of the CBR data, the depth of the bucket will fluctuate according to the CDV present. If the depth in the bucket is plotted as a graph, this shows the spread of 1-point CDV. For CBR data, the 1-point CDV measurement will approximate the 2-point CDV value, i.e. the CDV added by the ATM network. Non-conforming cells will distort the shape of the graph a little and clamp the maximum 1-point CDV value. It may therefore be useful to disable the declaration of non-conforming cells to get a complete picture of the CDV characteristic. So, it can be seen that the GCRA can be used to measure CDV as well as non-conforming cells.

Non-Constant Bit Rate Application of the GCRA.

For non-CBR data, cell arrival times depend on the time distribution of transmitted data as well as the CDV added by the network. If the transmitted data is not CBR, then the GCRA cannot usefully measure the network CDV. It can, however, be used to measure the distribution of the received data. The GCRA may be computed with the PCR set to any value (greater than the average value). As the PCR is increased, the maximum 1-point CDV value will decrease. Non-CBR traffic may be analyzed and policed by running the GCRA at more than one such rate.

For non-CBR data, where data occurs in variable length bursts, the Peak Cell Rate is the rate during a burst and the long term average as the Sustainable Cell Rate (SCR). To police this data, a GCRA can operate with the Peak Cell Rate and CDV tolerance as before. Another GCRA operates using the SCR value instead of the PCR. The CDV value of the GCRA is much bigger when using the SCR value and is proportional to the size of the bursts and the gap between bursts. When used with the SCR value, the CDV tolerance is known as the Intrinsic Burst Tolerance.

Introduction to ATM and LAN Testing
Measurement Definitions and Explanations

Using the 1-Point CDV measurement.

ANALYSE THE TRAFFIC CDV PROFILE.

To analyze the CBR CDV characteristic, set the PCR to equal the mean rate of the CBR traffic. The maximum 1-point CDV value (in cell times) is the minimum buffer depth (in cells) required to remove the CDV. In practice, twice this buffer depth is required because the buffer must be reset at an unknown point in the CDV cycle. If a buffer overflow is occurring in CBR "payout buffers", the fault may be sectionalised by performing measurements of 1-point CDV at various points in the network.

Traffic shaping may be used to smooth out the variations in non-CBR traffic and so make the signal more economical to transport across the ATM network. The maximum 1-point CDV value (in cell times) represents the buffer depth (in cells) required to smooth out the data to the selected Peak Cell Rate.

The distribution of the 1-point CDV graph gives further insight into the cause of CDV in the ATM network. By varying the PCR and observing the CDV the traffic distribution may be characterized completely.

VERIFY THE POLICING FUNCTION.

To verify the policing action, set the PCR and CDV tolerance to that used in the network element and compare the non-conforming cell ratio with the cell loss ratio available from the network element or measured using test equipment. If no non-conforming cells occur, the (CDV tolerance - maximum 1-point CDV value) gives the margin left available before reaching a condition of non-conformance.

Introduction to ATM and LAN Testing
Traffic Simulation

Traffic Simulation

NOTE: The numbers of channels given here relate to the HP37717C fitted with the ATM Services option USK, OYK or USL. Instruments with other ATM options allow the configuration of 4 virtual channels, (1 foreground and 3 background channels).

The test set can generate modeled cell traffic which is statistically representative of single and aggregate services present on a single physical link (UNI or NNI), and can be used to provide a number of pre-configured 'Benchmark' traffic loads

Up to 10 virtual channels may be configured, of which one is the Foreground Channel (normally used for out-of-service measurements, e.g. with the Test Cell as payload), and the remaining 9 virtual channels are Background Channels.

The payload of the Foreground Channel is very flexible, but the Background Channels contain just a repeated configurable User Byte for channel identification after ATM routing.

An important feature of all 10 channels is the cell timing distributions which may be selected. Independently for each of the 10 channels, and in any combination, one of three basic cell timing distributions is available:

- | | |
|----------------|--|
| Constant (CBR) | Only one parameter, mean cell rate, requires selection. |
| Random | Only one parameter, mean cell rate, requires selection. |
| Burst | There are three definable parameters
(a) the mean cell rate
(b) the burst size (length of each burst in cells)
(c) the peak rate (the cell rate during each burst). |

The Constant distribution schedules the transmission of cells with timing as close to that of a constant bit rate (CBR) service as possible. Because the selected cell rate is implemented by a series of discrete cell events, for arithmetical reasons there will be some small unavoidable deviation from ideal periodic cell timing. Also, the precise timing of cells will be influenced by interaction with the repeating framing overhead of the physical layer. However, these effects are small.

In Burst distribution, the burst itself repeats with a period dependent arithmetically on the three parameters selected. A typical application of the Burst is in simulation of intermittent data traffic and in testing traffic policing functions where both mean and peak rates must be defined.

The Random distribution is based on a pseudo-random function. The decision to schedule a cell for transmission is dependent on a combination of the random

Introduction to ATM and LAN Testing Traffic Simulation

function and the mean rate selected. Random is a particularly useful distribution for simulating the load which would be offered by the combination of a large number of independent traffic channels.

The 10 streams are all generated by independent sources. However, when the cell streams are combined to form the composite transmitted stream, a degree of cell timing interaction occurs, as in all ATM cell multiplexing. The independent streams scheduled by the generators will frequently contend for a particular cell slot. However, because the Foreground channel stream is intended principally for measurement, its distribution is considered most important and therefore any cell which the Foreground channel wishes to send is always accorded priority over the Background channels. After any Foreground channel cell, cells from the Backgrounds have equal priority amongst themselves and are sent in the order with which they are scheduled for transmission by the independent generators. Idle or Unassigned cells fill remaining slots.

As with usual ATM practice, Background channel cells awaiting transmission are held in a (virtual) buffer in their scheduled order until a slot is available. In extreme cases, particularly where the aggregate selected mean rate is close to 100% of the maximum possible, and two or more long bursts happen to coincide, there could be a large number of scheduled background channel cells awaiting transmission. The instrument allows up to 2048 pending cells. If extreme settings cause this buffer length to be exceeded, then Background channel cells will be lost. (Foreground channel cells are never lost.) When a cell is lost, a real-time warning: "Tx background cells are being discarded" appears momentarily on the status line of the display. In practice, repeated cell loss may show the warning for prolonged periods.

A benefit of the buffer is that mean rates very close to 100% may be tested even when the combined peak rates would considerably exceed 100% for significant periods. However, one consequence is that, in some circumstances, a user change of distribution parameters from a high aggregate rate (close to 100%) to a low rate may result in a significant delay before the visible transmitter output rate changes - due to the buffer emptying gradually. Ordinarily, this effect is not noticeable.

The cell headers, payloads and timing distributions for the Foreground (test) virtual channel and background virtual channels may be selected. Cell capacity not specifically assigned as Foreground channel or Background channel will be filled with Unassigned Cells or Idle Cells, and otherwise their details are treated in the user display like those of a Background channel. Either Unassigned or Idle Cells may be selected, but not both.

Generally any of the cell level receive measurements may be used with simulated traffic.

Introduction to ATM and LAN Testing Traffic Simulation

OAM Cell Generation

OAM cell generation is selected (on or off) from the TEST FUNCTION display. The continuity check OAM code is not included as this is needed only during traffic gaps, and is not a traffic load requirement.

Distribution

Distribution Types

Constant

Near periodic with selectable rate in cells/s. Single cells are transmitted at regular intervals, the separation determined by the selected cell rate.

Burst

Periodic burst with selectable burst length in number of cells and mean cell rate in cells/s. With option USK, OYK and USL modules, the cell rate during the burst is also selectable.

Random

Poisson distribution with selectable mean cell rate. Individual cell opportunities are pseudo-randomly filled with a probability appropriate to provide the chosen mean cell rate.

Introduction to ATM and LAN Testing Alarms

Alarms

PDH / DS_n physical layer alarms are covered in "The HP 37717C PDH / DS_n Operating Manual".

SDH / SONET physical layer alarms are covered in "The HP 37717C SDH / SONET Operating Manual".

ATM Layer Alarms

ATM layer alarms differ from physical layer alarms in that they are transmitted using ATM fault management OAM cells. These are transmitted using different header values from the user data cells and are detected in parallel with the user cell stream selected for test. There are two levels of ATM layer alarms:

F4 or VP alarms

F5 or VC alarms

The HP 37717C can generate and detect VP-AIS, VP-FERF (VP-RDI), VC-AIS or VC-FERF (VC-RDI) alarms.

VP alarms will only be detected if CELL SELECTED FOR TEST is VP or VC.

VC alarms will only be detected if CELL SELECTED FOR TEST is VC.

Any VP or VC alarm detected will illuminate the front panel VP or VC alarm indicator, if selected. However, alarm analysis in Channel View is independent of these selections

Continuity check cells are another type of fault management OAM cell (VP-CC or VC-CC) and may be found as substitutes for the transmitted cell stream during pauses.

VP-CC or VC-CC cells are generated at a rate of one per second. If the transmitted cell distribution is set with a large burst size and low mean cell rate, long periods of silence can be arranged in the transmitted VC. If this period exceeds 3.5 seconds, a loss of continuity defect (VP-LOC or VC-LOC) may be declared in network equipment. This may cause VP-AIS or VC-AIS cells to be generated. Transmission of VC-CC or VP-CC cells by the instrument or network avoid this happening.

By setting up the transmit cell rate and burst size and selecting VP-CC or VC-CC on or off, the VP-LOC and VC-LOC mechanisms in network equipment may be tested. Continuity check cells may be segment or end to end. The HP 37717C transmits only end to end VP-CC or VC-CC cells.

Introduction to ATM and LAN Testing
Alarms

EFCI (explicit forward congestion indication) may be used to control congestion in ATM networks. This is detected in the PTI field of cells in the stream under test and indicated on the HP 37717C as CONGESTION EXPERIENCED alarm.

ATM Alarms and other conditions detected during a test are logged. The following list comprises the conditions which may be logged

ATM Alarm	Additional Information
PLCP Frame Loss	Applies to DS3 PLCP convergence layer
PLCP Remote Alarm	Applies to DS3 PLCP convergence layer
LOSS of CELL SYNC	also known as LOCD, Loss of Cell Delineation
SELECTED CELL NOT RX	
PATTERN LOSS	Loss of the expected test pattern
CONGESTION EXPERIENCED	
VP-AIS	Virtual path - Alarm Indication signal
VP-FERF	Virtual path - Far End Receive Failure (also called VP-RDI)
VP-LOC	Virtual path - Loss Of Continuity
VC-AIS	Virtual channel - Alarm Indication Signal
VC-FERF	Virtual channel - far End Receive Failure (also called VC-RDI)
VC-LOC	Virtual channel - Loss of Continuity
TEST CELL LOSS	
PM OAM LOSS	Performance Management OAM loss
AAL LOSS	Services level, for details see page 10

**Introduction to ATM and LAN Testing
Alarms**

Operation During Alarm Conditions

Error counting in measurements is inhibited during alarm conditions as defined in the following table

NOTE Alarms from the SDH / SONET and PDH / DS_n physical layers are not shown in the following table.

Measurement	Alarm
Received Cells	LOS, LOF, Loss of Cell Sync, PCLP LOF
Corrected HEC	LOS, LOF, AIS, Loss of Cell Sync, PCLP LOF
Non-corrected HEC	LOS, LOF, AIS, Loss of Cell Sync, PCLP LOF
Errored Cells	LOS, LOF, Loss of Cell Sync, Test Cell Loss, Pattern Loss, PCLP LOF
Lost Cells	LOS, LOF, Loss of Cell Sync, Test Cell Loss, PM OAM Loss, PCLP LOF
Misinserted Cells	LOS, LOF, Loss of Cell Sync, Test Cell Loss, PM OAM Loss, PCLP LOF
BEDC BIP-16	LOS, LOF, Loss of Cell Sync, PM OAM Loss, PCLP LOF
Bit Errors	LOS, LOF, Loss of Cell Sync, Pattern Loss, PCLP LOF
Gated MCTD	LOS, LOF, Loss of Cell Sync, Test Cell Loss, PCLP LOF
Max CTD	LOS, LOF, Loss of Cell Sync, Test Cell Loss, PCLP LOF
P-P 2-pt CDV	LOS, LOF, Loss of Cell Sync, Test Cell Loss, PCLP LOF
Max 1-pt CDV	LOS, LOF, Loss of Cell Sync, PCLP LOF
Non-conforming Cells	LOS, LOF, Loss of Cell Sync, PCLP LOF
AAL results except AAL over-run	LOS, LOF, MS-AIS, LOP, Path AIS, Loss of cell sync, AAL loss, PCLP LOF
AAL-5 over-run	LOS, LOF, MS-AIS, LOP, Path AIS, VP-AIS, VC-AIS, AAL loss, PCLP LOF
Channel View	LOS, LOF, MS-AIS, LOP, Path AIS, PCLP LOF

2

ATM Modules page 28

LAN Testing Module page 32

ATM Module Features page 33

Cell Level ATM (Options UKN (USE) and UKZ) page 33

ATM Services Modules (Options USK and USL) and Broadband Auxiliary Module (Option 0YK) page 38

LAN Module Features (Option USL) page 42

ATM and LAN Testing Modules

Information on the optional modules including selection of the features available.

ATM and LAN Testing Modules
ATM Modules

ATM Modules

Cell Level ATM Testing. Option UKN (USE)

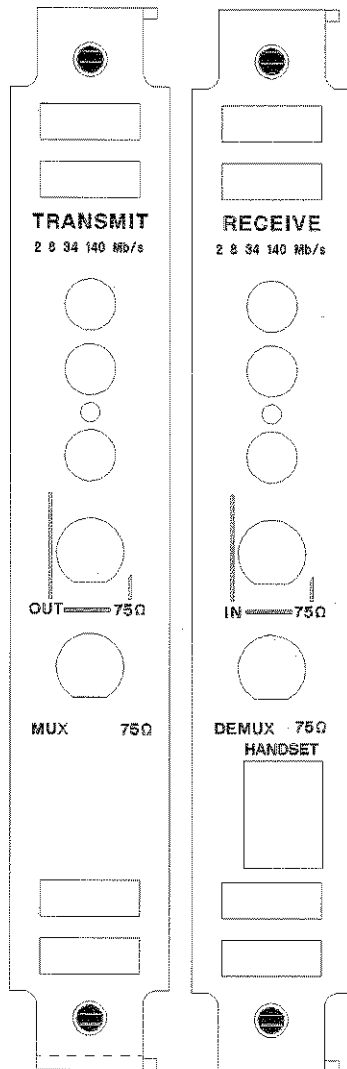

Option UKN (USE) provides generation and measurement of PDH / DS_n signals with ATM payloads at interfaces of 2.048 Mb/s (E1), 34.368 Mb/s (E3), and 139.264 Mb/s (E4).

Frequency Offset can be added at the interface rates

Line rate frequency measurement can be performed.

Provides the following RZ input and output interfaces:

E3 and E4: 75 Ω unbalanced

E1: 75 Ω unbalanced, 120 Ω balanced.

Allows selection of Line Code AMI, HDB3 or CMI

Allows error and alarm injection

Allows the selection of Foreground (F/G) and Background (B/G) distribution, headers and payloads.

Fill Cells may be Idle or Unassigned.

Provides selectable UNI or NNI interface.

Foreground timing distribution may be Constant or Periodic burst.

A Single burst of a selectable number of cells may be added

A Test Cell payload is provided for delay and cell misinsertion and loss measurements.

Single HEC, double HEC or bit errors may be added to the ATM payload. When added to all cells they may be added as a burst.

OAM alarms may be added to the transmitted stream.

ATM and LAN Testing Modules
ATM Modules

Cell Level ATM Testing. Option UKZ

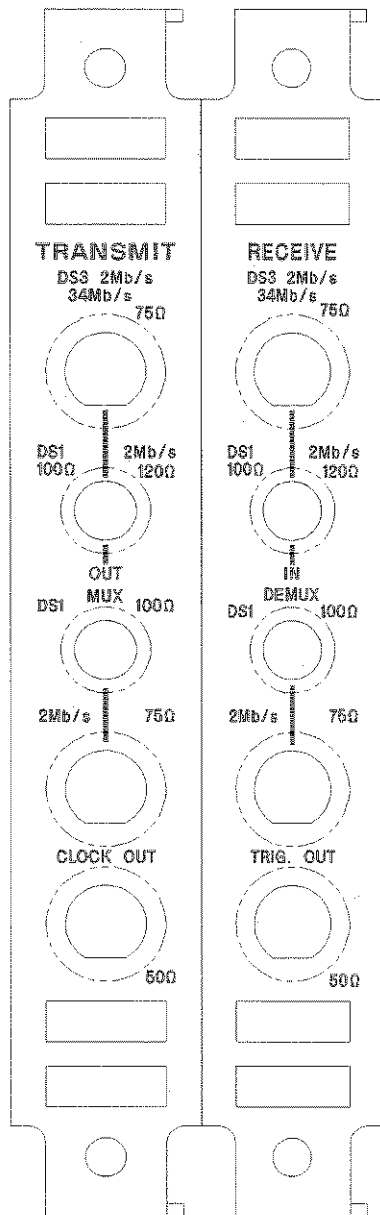

Physical Layer:

Option UKZ provides generation and measurement of PDH / DS_n signals with ATM payloads at interface rates of:

1.544 Mb/s (DS1), 44.736 Mb/s (DS3),
 2.048 Mb/s (E1) and 34.368 Mb/s (E3).

Frequency Offset can be added at the interface rates.

Line rate frequency measurement can be performed.

Provides the following RZ input and output interfaces:

DS3 and E3: 75 Ω unbalanced

E1: 75 Ω unbalanced, 120 Ω balanced.

DS1: 100 Ω balanced.

Allows selection of Line Code AMI, HDB3, B3ZS or B8ZS

Provides Input sensitivity level selection.

Provides output level control for DS1 and DS3.

Allows error and alarm injection

Allows selection of PCLP or Direct mapping for DS3.

ATM Convergence Layer:

Allows selection of DS3 PCLP Growth Octets Z1 to Z6, Line signal status bits and Path Status FEBE, RAI, and LSS.

Provides scrambling on/off selection.

ATM Cell Layer:

Allows the selection of Foreground (F/G) and Background (B/G) distribution, headers and payloads.

Fill Cells may be Idle or Unassigned.

Provides selectable UNI or NNI interface.

Foreground timing distribution may be Constant or Periodic burst.

A Single burst of a selectable number of cells may be added

A Test Cell payload is provided for delay and cell misinsertion and loss measurements.

Single HEC, double HEC or bit errors may be added to the ATM payload. When added to all cells they may be added as a burst. OAM alarms may be added to the transmitted stream.

ATM and LAN Testing Modules
ATM Modules

Broadband Auxiliary Testing. Option 0YK

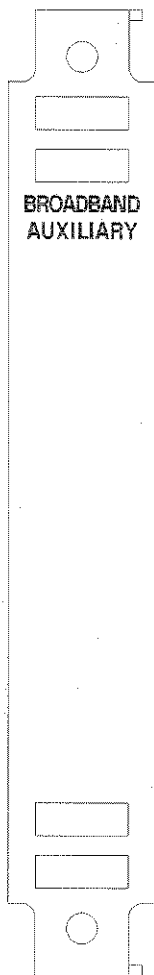

The Broadband Auxiliary module needs one of the cell layer modules: ETSI cell layer option UKN (USE) or ANSI / ETSI cell layer option UKZ. With the ETSI cell layer option UKN (USE), a physical layer interface, for example, Structured PDH / DS_n Option UKJ (USA) is required.

Allows the selection of 1 Foreground (F/G) and up to 9 Background (B/G) distribution, headers and payloads.

Fill Cells may be Idle or Unassigned.

Provides selectable UNI or NNI interface.

Foreground and Background timing distributions are individually selectable and may be Constant, Random or Periodic burst.

A Test Cell payload is provided for delay and cell misinsertion and loss measurements.

Single HEC, double HEC or bit errors may be added to the ATM payload. When added to all cells they may be added as a burst.

OAM alarms may be added to the transmitted stream.

Provides a graphical overview of the traffic at a point in the network with Channel View.

Provides graphical displays of Rate History and 2-Point Cell Delay Variation

Provides AAL Sublayer Measurements

ATM and LAN Testing Modules ATM Modules

Services Layer ATM Testing. Options USK and USL

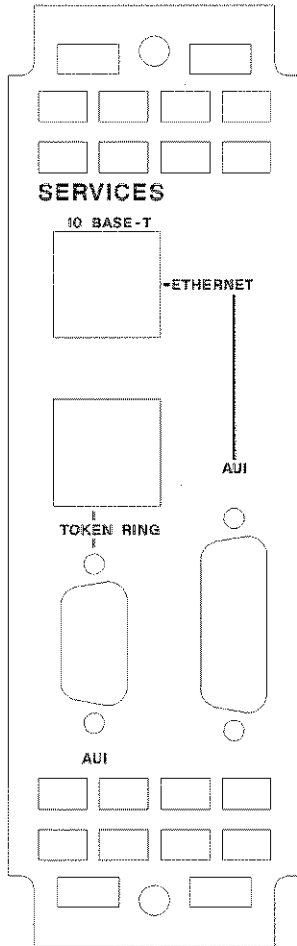

The Services Layer modules need one of the cell layer modules: ETSI cell layer option UKN (USE) or ANSI / ETSI cell layer option UKZ. With the ETSI cell layer option UKN (USE), a physical layer interface, for example, Structured PDH / DS_n Option UKJ (USA) is required.

Allows the selection of 1 Foreground (F/G) and up to 9 Background (B/G) distribution, headers and payloads.

Fill Cells may be Idle or Unassigned.

Provides selectable UNI or NNI interface.

Foreground and Background timing distributions are individually selectable and may be Constant, Random or Periodic burst.

A Test Cell payload is provided for delay and cell misinsertion and loss measurements.

Single HEC, double HEC or bit errors may be added to the ATM payload. When added to all cells they may be added as a burst.

OAM alarms may be added to the transmitted stream.

Provides a graphical overview of the traffic at a point in the network with Channel View.

Provides graphical displays of Rate History and 2-Point Cell Delay Variation

Provides AAL Sublayer Measurements

See LAN Testing Module. Option USL page 32 for the LAN testing features of this module

ATM and LAN Testing Modules
LAN Testing Module

LAN Testing Module

LAN Testing Module. Option USL

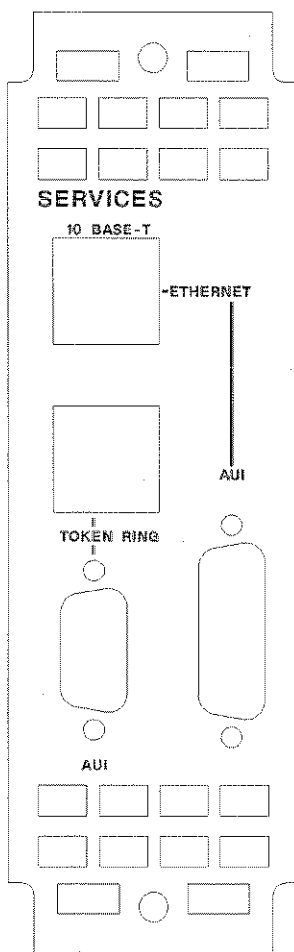

Provides ETHERNET 10base-T and AUI interfaces.

Provides "Ping" network continuity check.

Ping with selectable rate for packet loss testing.

Measures ping loss and delay with and without background loading.

Background loading rate and packet length mix are selectable.

Allows any combination of ping packets, file transfer and background load as test source.

Measures average data rate while sending simulated files.

Measures collisions in Ethernet LANs.

Presents Round Trip Delay history in graphical form with maximum, minimum and mean color coded information.

CAUTION: Connection to the **RJ-45 sockets** should use **Un-shielded Twisted Pair (UTP) cable**. Damage to the instrument may result from the use of Shielded Twisted Pair (STP) cables. A suitable cable, Part Number 8120-6830, is available from Hewlett Packard.

See Services Layer ATM Testing. Options USK and USL page 31 for ATM Services Layer Features of this module.



ATM and LAN Testing Modules
ATM Module Features

ATM Module Features

ATM Cell layer features are enhanced if one of the options 0YK, USK or USL are fitted. To accommodate these enhanced features, there are differences in their presentation on the display.

Cell Level ATM (Options UKN (USE) and UKZ)

Traffic Simulation

Traffic simulation is provided for out-of-service testing where real user traffic is not suitable and user control of cell timing distribution is needed.

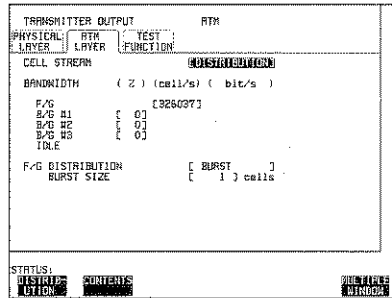

Use the **TRANSMIT** display **ATM** **ATM LAYER** settings to select the cell stream headers, payloads and distribution.

You can select the headers, payloads and distributions of the Foreground (F/G) channel and Background (B/G) channel cells. The Foreground channel cell is used as the subject of the test and the background channel cells are transmitted with it in the same physical link

The test stream comprises: 1 Foreground Channel, 3 Background Channels and the remaining cell opportunities which are filled with unassigned or idle cells selectable from the **CELL STREAM** **CONTENTS** display.

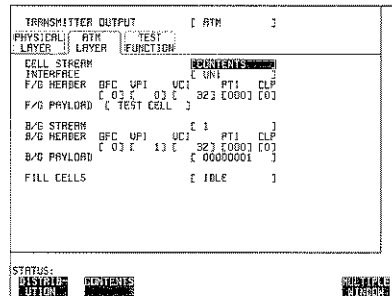

ATM and LAN Testing Modules Cell Level ATM (Options UKN (USE) and UKZ)

Different types of traffic may be simulated by selecting the cell timing distributions.

The four channels can have any of the following two cell timing distributions: Constant or periodic Burst. A number of traffic models may be stored in the instrument as part of complete instrument stored settings

```

TRANSMITTER OUTPUT [ ATM ]
PHYSICAL: ATM TEST
LAYER: LAYER FUNCTION
CELL STREAM [ DISTRIBUTION ]
BANDWIDTH ( 2 ) (cell/s) ( bit/s )
F/B [ 326097 ]
B/B B1 [ 0 ]
B/B B2 [ 0 ]
B/B B3 [ 0 ]
IDLE
F/B DISTRIBUTION [ PERIODIC ]
ADD SINGLE BURST OF [ 1 ] cells
[ OFF ]

STATUS:
BURST PERIODIC MULTIPLE WINDOW
    
```

Type of Service	Useful Equivalent Cell Timing Distribution
Constant Bit Rate	Constant (periodic)
Service Protocol Packet	Burst (Periodic burst)

```

TRANSMITTER OUTPUT [ ATM ]
PHYSICAL: ATM TEST
LAYER: LAYER FUNCTION
CELL STREAM [ DISTRIBUTION ]
BANDWIDTH ( 2 ) (cell/s) ( bit/s )
F/B [ 326097 ]
B/B B1 [ 0 ]
B/B B2 [ 0 ]
B/B B3 [ 0 ]
IDLE
F/B DISTRIBUTION [ PERIODIC ]
ADD SINGLE BURST OF [ 1000 ] cells
[ OFF ]

STATUS:
OFF ADD BURST MULTIPLE WINDOW
    
```

The number of parameters selectable in burst mode depends on the optional modules fitted. All ATM Cell layer, ATM Services and Broadband Auxiliary modules provide the capability to select the burst length in cells and mean cell rate in number of cells per second.

A Single burst of a preset number of cells may be added.

The payload of the foreground and background channels may be selected independently of the distributions by selecting **ATM LAYER CONTENTS**

```

TRANSMITTER OUTPUT [ ATM ]
PHYSICAL: ATM TEST
LAYER: LAYER FUNCTION
CELL STREAM [ DISTRIBUTION ]
INTERFACE [ UNI ]
F/B HEADER BFC UP1 UCI P11 CLP [ 0 ] [ 0 ] [ 02 ] [ 000 ] [ 0 ]
F/B PAYLOAD [ TEST CELL ]
E/B STREAM [ 1 ]
E/B HEADER BFC UP1 UCI P11 CLP [ 0 ] [ 0 ] [ 13 ] [ 02 ] [ 000 ] [ 0 ]
E/B PAYLOAD [ 00000001 ]
FILL CELLS [ IDLE ]

STATUS:
DISTRIBUTION CONTENTS MULTIPLE WINDOW
    
```

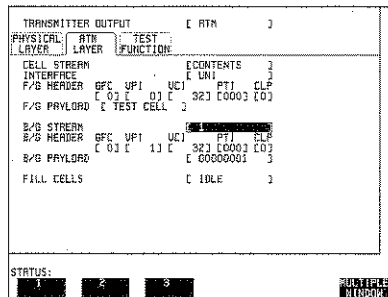

ATM and LAN Testing Modules
Cell Level ATM (Options UKN (USE) and UKZ)

Each background channel header and payload is selected and set-up in turn by using the B/G STREAM selection.

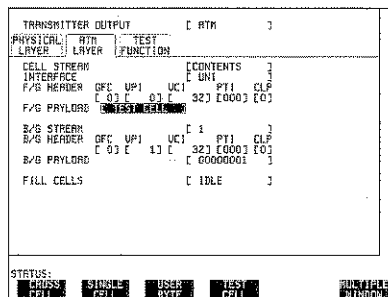

The cross cell PRBS runs continuously from cell to cell. With the cross cell PRBS, error instances of cell misinsertion or cell loss will cause pattern sync loss.

With the single cell PRBS, the PRBS is restarted in every cell. Cell loss will **NOT** cause pattern sync loss but, of course, payload errors will be counted.



The Test Cell

Delay measurements and cell misinsertion and loss measurements use a special test cell. The test cell is that defined in ITU-T O.191. Delay measurements use the time stamp and cell misinsertion and loss measurements use the sequence number. Errored cells are indicated by the EDCs (Error Detection Codes) in the test cell.

The test cell is selectable from the **TRANSMIT** **ATM** **ATM LAYER** display by selecting the test cell in the **CELL STREAM** **CELL PAYLOAD**. The header of the test cell may then be set using **CELL HEADER**.

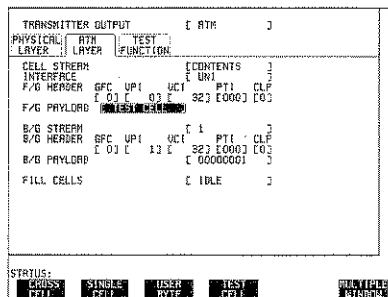

ATM and LAN Testing Modules
Cell Level ATM (Options UKN (USE) and UKZ)

Trail Trace

Use the **TRANSMIT** display **ATM PHYSICAL LAYER** settings to select the trail trace content.

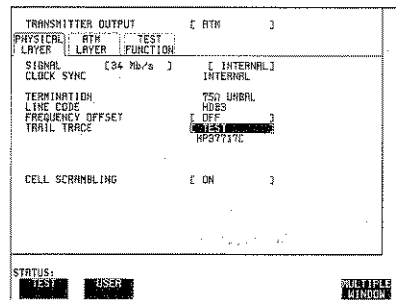

Alarm and Error Generation

Header Errors

Errors may be added to the ATM cell header. Selecting SINGLE HEC adds one error to the ATM header when activated. An isolated single error will be corrected by the HEC mechanism and will result in a measurement of a corrected HEC error.

Selecting DOUBLE HEC adds two errors to the same header. This will cause the HEC check to fail and the cell to be discarded.

A burst error add feature is also available whenever header errors are selected to be added to ALL CELLS. BURST can be used to stress the ATM cell delineation algorithm. You can select a burst of from 1 to 8 consecutive errored cell headers. Usually six header errors can be added before cell delineation is lost. A burst of single header errors will cause only the first error to be corrected because of the detection/correction mode inherent in the header error correction algorithm.

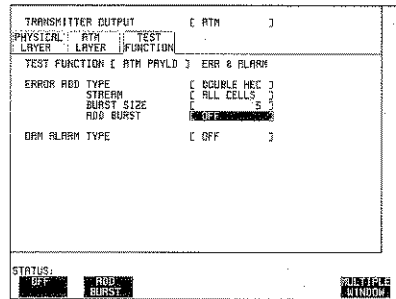

ATM and LAN Testing Modules Cell Level ATM (Options UKN (USE) and UKZ)

HEC Errors

Header error correction may be checked with the introduction of single header errors. The detection and discard operation of devices may be checked with double header errors. Cell delineation may be checked with the introduction of header error sequences.

Payload Errors

Bit errors may be introduced into the ATM payload.

Use the **TRANSMIT** display **ATM TEST FUNCTION** settings to produce ATM errors and OAM alarms in the transmitted stream.

TRANSMITTER OUTPUT [C ATM]	
PHYSICAL LAYER	ATM LAYER [JITTER] TEST FUNCTION
TEST FUNCTION [C ATM PAYLD] ERR & ALARM	
ERROR ADD TYPE	STREAM [726 CELLS]
RATE	[OFF]
OAM CELL ALARMS	[OFF]
STATUS: SINGLE REC. DOUBLE REC. BIT MULTIPLE WINDOW	

ATM and LAN Testing Modules
**ATM Services Modules (Options USK and USL) and Broadband
 Auxiliary Module (Option 0YK)**

**ATM Services Modules (Options USK and USL)
 and Broadband Auxiliary Module (Option 0YK)**

Traffic Simulation

Traffic simulation is provided for out-of-service testing where real user traffic is not suitable and user control of cell timing distribution is needed.

PHYSICAL LAYER	ATM LAYER	TEST FUNCTION	INTERFACE (UNIT)
CELL	STREAM	HEADERS	PAYLOAD
CHN	CFG	OP	UCI
PG	1	0	000
BS	1	0	000
BS	2	0	000
BS	3	0	000
BS	4	0	000
BS	5	0	000
BS	6	0	000
BS	7	0	000
BS	8	0	000
BS	9	0	000
FILL	10.E		

Use the **TRANSMIT** display **ATM ATM LAYER** settings to select the cell stream headers, payloads and distribution.

You can select the headers, payloads and distributions of the Foreground channel and Background channel cells. The Foreground channel cell is used as the subject of the test and the background channel cells are transmitted with it in the same physical link

The number of background channels selectable varies with optional modules. This example uses the ATM services module USK or USL.

The test stream comprises: 1 Foreground Channel, up to 9 Background Channels and the remaining cell opportunities filled with unassigned or idle cells.

Different types of traffic may be simulated by selecting the cell timing distributions.

The ten channels can have any of the following three cell timing distributions: Constant, periodic Burst or Random, see page 21. Particular combinations of settings allow traffic models to be constructed by the user.

A number of traffic models may be stored in the instrument as part of complete instrument stored settings.

CELL	STREAM	HEADERS	PAYLOAD	SIZE	PK RATE
PG	1	0	000	CONSTANT	
BS	1	0	000	CONSTANT	
BS	2	0	000	BURST	38 73296
BS	3	0	000	CONSTANT	
BS	4	0	000	BURST	317 40913
BS	5	0	000	CONSTANT	
BS	6	0	000	BURST	
BS	7	0	000	CONSTANT	
BS	8	0	000	BURST	60 42500
BS	9	0	000	CONSTANT	
FILL	10.E				

ATM and LAN Testing Modules

ATM Services Modules (Options USK and USL) and Broadband Auxiliary Module (Option OYK)

Type of Service	Useful Equivalent Cell Timing Distribution
Constant Bit Rate	Constant (periodic)
Service Protocol Packet	Burst (Periodic burst)
Multiple channels considered together as a composite load	Random (Poisson)

The number of parameters selectable in burst mode depends on the optional modules fitted. All ATM and ATM Services / Broadband Auxiliary modules provide the capability to select the burst length in cells and mean cell rate in number of cells per second. The ATM Services / Broadband Auxiliary modules, options OYK, USK and USL provide the additional capability of selecting a cell rate during the burst which is different to the mean cell rate, and also provide the Random Distribution.

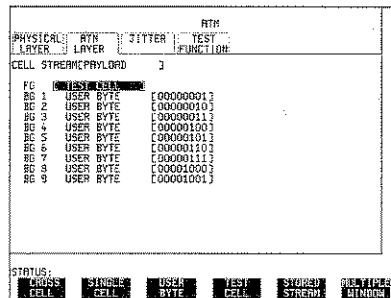

The payload of the foreground and background channels may be selected independently of the distributions

The cross cell PRBS runs continuously from cell to cell. With the cross cell PRBS, error instances of cell mis-insertion or cell loss will cause pattern sync loss.

With the single cell PRBS, the PRBS is restarted in every cell. Cell loss will **NOT** cause pattern sync loss but, of

course, payload errors will be counted.

Instead of normal operation where the Foreground Channel is a single VC, the same cell *positions* may be substituted by one of the composite cell streams stored in the instrument. The stored cell streams contain a *number* of fixed VCs which periodically repeat, some containing deliberate errors. The stored streams are intended for instrument demonstration, test and training purposes. For details see page 99

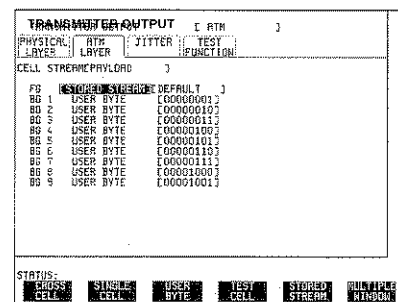

Note that when a stored cell stream is selected, the terms "Foreground" and "Payload" are no longer meaningful.

ATM and LAN Testing Modules

ATM Services Modules (Options USK and USL) and Broadband Auxiliary Module (Option 0YK)

With the cell layer modules options UKN (USE) or UKZ and WITHOUT the modules 0YK, USK or USL, a single burst of contiguous cells may be **added** to the Constant Foreground channel distribution on a single event basis. The burst size is selected from the TEST FUNCTION display.

The Test Cell

Delay measurements and cell misinsertion and loss measurements use a special test cell. The test cell is that defined in ITU-T draft O.191. Delay measurements use the time stamp and cell misinsertion and loss measurements use the sequence number. Errored cells are indicated by the EDCs (Error Detection Codes) in the test cell.

The test cell is selectable from the **TRANSMIT ATM ATM LAYER** display by selecting the test cell in the **CELL STREAM CELL PAYLOAD**. The header of the test cell may then be set using **CELL HEADER**.

TRANSMITTER OUTPUT				ATM
PHYSICAL LAYER	ATM LAYER	JITTER	TEST FUNCTION	
CELL STREAM PAYLOAD				3
FG	TEST CELL			
BG 1	USER BYTE			00000001
BG 2	USER BYTE			00000010
BG 3	USER BYTE			00000011
BG 4	USER BYTE			00000100
BG 5	USER BYTE			00000101
BG 6	USER BYTE			00000110
BG 7	USER BYTE			00000111
BG 8	USER BYTE			00001000
BG 9	USER BYTE			00001001

STATUS: CROSS CELL SINGLE CELL USER BYTE TEST CELL STORED STREAM MULTIPLE WINDOW

TRANSMITTER OUTPUT				ATM
PHYSICAL LAYER	ATM LAYER	JITTER	TEST FUNCTION	
CELL STREAM HEADERS				INTERFACE UNI
CHAN	BFC	OPT	UT	PTI CLP
FG	0	0	32	000 0
BG 1	0	1	32	000 0
BG 2	0	2	32	000 0
BG 3	0	3	32	000 0
BG 4	0	4	32	000 0
BG 5	0	5	32	000 0
BG 6	0	6	32	000 0
BG 7	0	7	32	000 0
BG 8	0	8	32	000 0
BG 9	0	9	32	000 0
FILL	IDLE			

DISTRIB- UTION HEADERS PAYLOAD MULTIPLE WINDOW

Trail Trace

Use the **TRANSMIT** display **ATM PHYSICAL LAYER** settings to select the trail trace content.

TRANSMITTER OUTPUT				ATM
PHYSICAL LAYER	ATM LAYER	JITTER	TEST FUNCTION	
SIGNAL				[34 Mb/s] INTERNAL
CLOCK SYNC				INTERNAL
TERMINATION				TEST UNBAL
LINE CODE				H8B3
FREQUENCY OFFSET				[OFF]
TRAIL TRACE				TEST
				HP37717C
CELL SCRAMBLING				[ON]

STATUS: TEST USER MULTIPLE WINDOW

ATM and LAN Testing Modules

ATM Services Modules (Options USK and USL) and Broadband Auxiliary Module (Option 0YK)

Alarm and Error Generation

Header Errors

Errors may be added to the ATM cell header. Selecting SINGLE HEC adds one error to the ATM header when activated. An isolated single error will be corrected by the HEC mechanism and will result in a measurement of a corrected HEC error.

Selecting DOUBLE HEC adds two errors to the same header. This will cause the HEC check to fail and the cell to be discarded.

A burst error add feature is also available whenever header errors are selected to be added to ALL CELLS. BURST can be used to stress the ATM cell delineation algorithm. You can select a burst of from 1 to 8 consecutive errored cell headers. Usually six header errors can be added before cell delineation is lost. A burst of single header errors will cause only the first error to be corrected because of the detection/correction mode inherent in the header error correction algorithm.

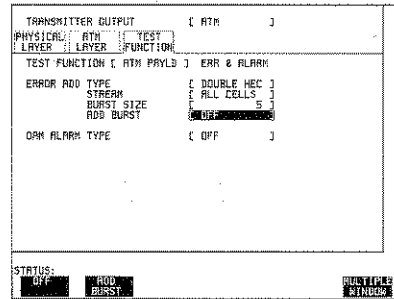

HEC Errors

Header error correction may be checked with the introduction of single header errors. The detection and discard operation of devices may be checked with double header errors. Cell delineation may be checked with the introduction of header error sequences.

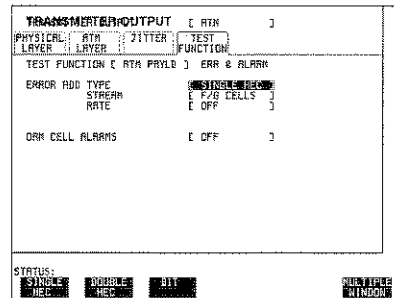

Payload Errors

Bit errors may be introduced into the ATM payload.

Use the **TRANSMIT** display **ATM TEST FUNCTION** settings to produce ATM errors and OAM alarms in the transmitted stream.

ATM and LAN Testing Modules LAN Module Features (Option USL)

LAN Module Features (Option USL)

Physical Layer Selections

The MAC protocol and physical layer **TRANSMIT** interface are set on the **PHYSICAL LAYER** display.

The **PHYSICAL ADDRESS** is unique to each device and is therefore fixed.

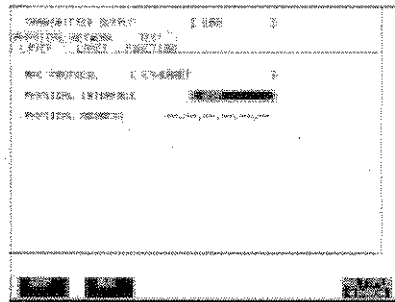

Network Layer Selections

The transmit network details are set on the **TRANSMIT NETWORK LAYER** display. The type of settings required for IP are shown right.

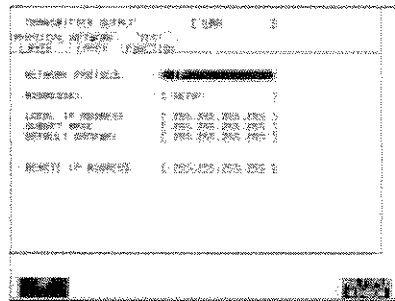

To change the addresses use **ADDRESSES SETUP**. When the addresses have been set, select **ADDRESSES RUN**.

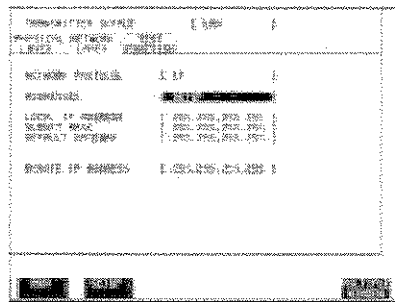

ATM and LAN Testing Modules LAN Module Features (Option USL)

Test Function Selections

Tests are setup from the TEST FUNCTION display. Each test function can be switched on and off independently of the other test functions.

All test functions are set to OFF at the end of gating.

It is possible to use any combination of test functions simultaneously.

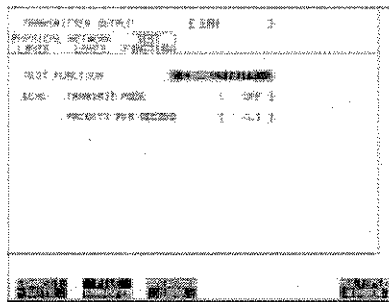

The ECHO TRANSMIT MODE

CONNECTIVITY provides a ping test facility.

Ping testing checks the network without automatic error correction. In this mode a rate of the transmitted ping packets between 0.1 and 10 packets per second may be selected.

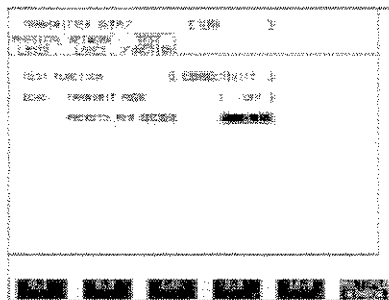

For file transfer testing, the TEST FUNCTION **FILE TRANSFER** may be selected as shown. The file size is selectable from this display.

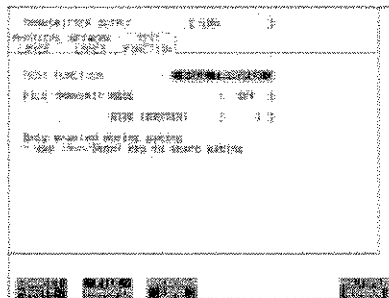

ATM and LAN Testing Modules LAN Module Features (Option USL)

For testing under load conditions a background load may be introduced by selecting TEST FUNCTION **BACKGRND LOAD** and setting the LOAD GENERATOR **ON**.

The PACKET RATE is selectable.

The mix of short and long packets may be varied to simulate different types of loading.

Receive Selections

If the TRANSMITTER OUTPUT and the RECEIVER INPUT are both set to LAN, the **RECEIVE** and **TRANSMIT** PHYSICAL LAYER and NETWORK LAYER settings are automatically coupled. If the TRANSMITTER OUTPUT is **not** set to LAN, for example if it is set to ATM, the LAN **RECEIVE** settings are made in the same way as the **TRANSMIT** features, see page 42. The Physical (MAC) address is automatically read from the interface.

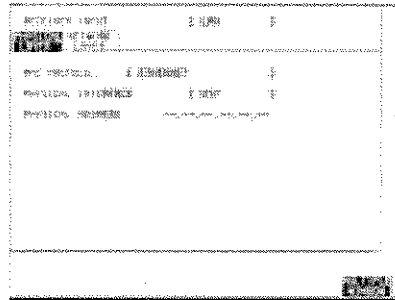
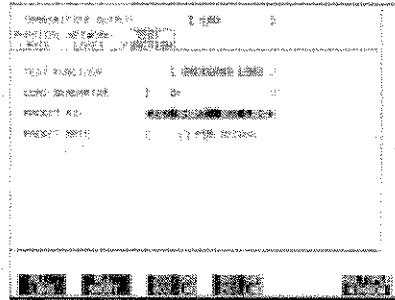

ATM and LAN Testing Modules LAN Module Features (Option USL)

Results Selections

Cumulative and short term results are available for the physical layer, connectivity ping testing and file transfer testing. The far end address is available from **RESULTS**. The following illustrations show the results available

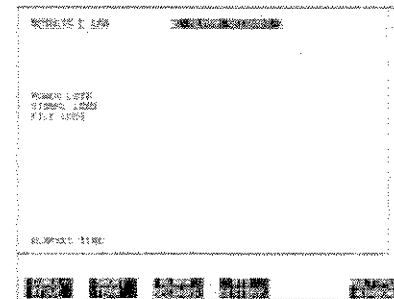
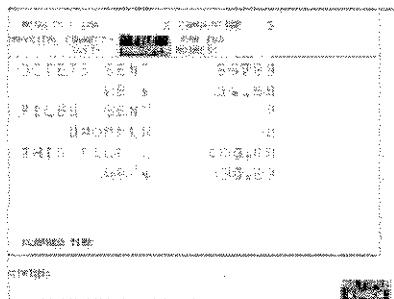
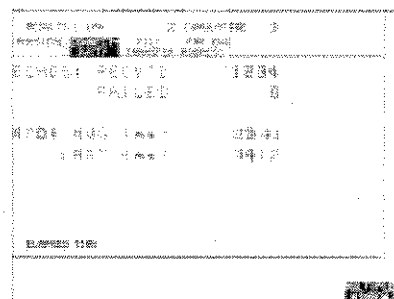
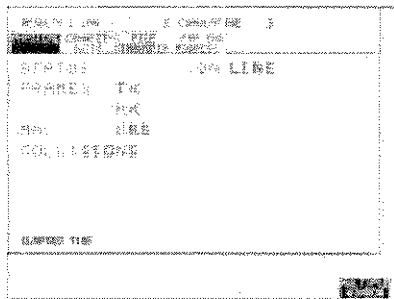

For a graphical display of round trip delay select **RTD HISTORY**.

Certain conditions are required to be met before this result is available. The display opposite shows these conditions, as displayed by the instrument, when they are not being met

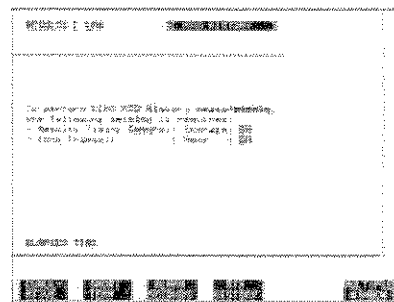

ATM and LAN Testing Modules LAN Module Features (Option USL)

The bar graph shows maximum (red), minimum (blue) and mean (green) delay for each bar period. The delay time scale is automatically set to the maximum delay. When there is little or no variation in round trip delay, the maximum and mean (red and green) bars may be masked by the minimum (blue) bar.

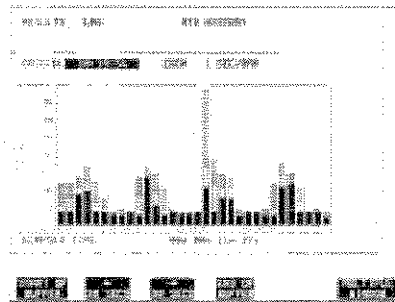

Dropped File and Lost Echo Indications

Dropped File

Each occurrence of a dropped file (a file transfer failure) is indicated by the front panel PATTERN LOSS indicator. A count of these dropped files is shown on the File Transfer Results display.

Lost Echo

The occurrence of a lost echo (a dropped ping) is indicated by the front panel ERRORS indicator. A count of these lost echoes is shown on the Connectivity Results display.

Signal Loss Indication

Signal Loss indication on the front panel indicator, Alarms Results and Alarms Graph displays indicates a quiet state lasting for 20 seconds or more.



3

ATM Channel View	page 48
Measurement Set-Up	page 49
Cell Count Mode	page 49
Channel View Set-up	page 49
Filtering	page 49
Sorting	page 50
Starting the Channel View Measurement	page 50
VPI and VCI Identification	page 50
Load Indication and Bar Graph Display	page 50
Payload Analysis (PAYLOAD Column)	page 51
Continuity Checks	page 51
ATM Alarms Analysis (ALARMS Column)	page 51
Selection of a Channel for Further Analysis	page 52



Link Traffic Overview

The starting point for many applications, Channel View gives you a fast pictorial indication of link activity.



Link Traffic Overview
ATM Channel View

ATM Channel View

Options required 0YK USK or USL (plus UKN (USE) or UKZ)

Channel View allows you to find quickly what is present on the link, identify problem paths / channels and to select them for further analysis. This feature may be used for In-Service and Out-of-Service applications. You can rapidly check routing tables and check for "rogue" cells. Rogue cells are cells which have been translated by error to an incorrect VPI / VCI value, whether that value is already in use or not. When a rogue cell has been translated to a VPI / VCI value in use it is a misinserted cell.

All of the VPs and VCs containing traffic, even down to a single cell, are detected and the mean cell load is displayed in real time. The bars on the display give a pictorial indication of activity.

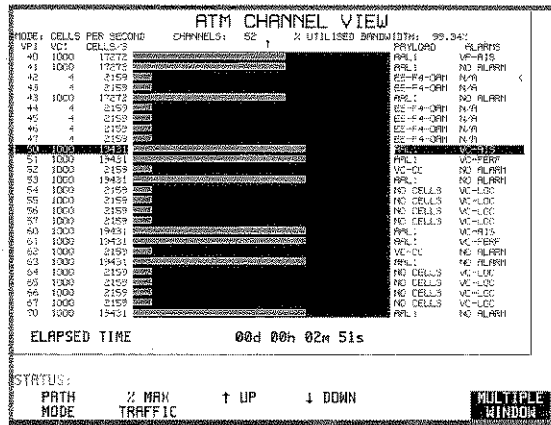

Link Traffic Overview
ATM Channel View

Measurement Set-Up

Cell Count Mode

The cell counts used for the Channel View display may be short term or cumulative. Before selecting Channel View, select the cell count mode.

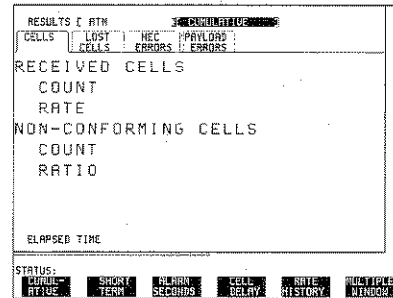

Channel View Set-up

Press **RECEIVE** and select the display shown.

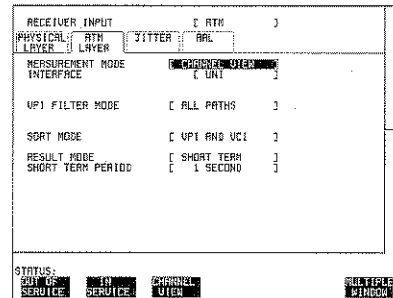

Filtering

Make any filter adjustments required. If more than 1023 channels are expected to be present on the link, it may be desirable to restrict the range by selecting one of the VPI FILTER MODE ranges available otherwise the instrument identifies the first 1023 different VPI / VCI values it finds. This may also be desirable if only a limited range of virtual channels is of interest.

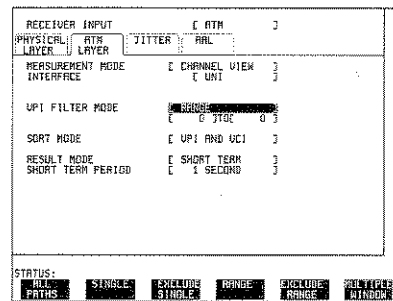



Link Traffic Overview
ATM Channel View

Sorting

With the SORT MODE set to OFF the CHANNEL VIEW display will be presented in the order that cells are detected. The "last page" of the CHANNEL VIEW display will show new or added virtual channels. With the SORT MODE set to VPI and VCI the CHANNEL VIEW display will be presented by VPI (and VCI) in numerical order.

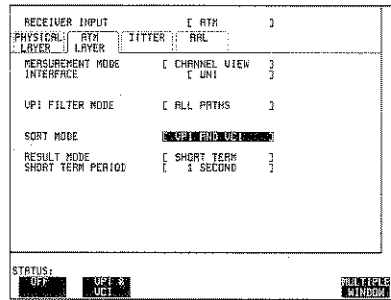

Starting the Channel View Measurement

With the set-up complete, press **RESULTS** to obtain the Channel View display and then press **RUN/STOP** to start the measurement.

VPI and VCI Identification

The leftmost two columns show the VPI and VCI in all modes.

VPI	VCI
40	1000
41	1000
42	4
43	4
43	1000
44	4
45	4
45	4
47	4
50	1000
51	1000
52	1000



Load Indication and Bar Graph Display

The third column shows the value for the mode selected. The current mode selection is shown at the top of the display:



Three modes are available for load indication:

- Cells/second
- % of maximum possible link traffic
- Cell count from the start of the measurement

These modes are selected using the three way toggling softkey at the bottom of the display. The bar graph display is color coded to indicate short term or cumulative cell count selected; see page 49. A green bar graph display indicates short term cell count and a blue bar graph display indicates cumulative cell count.



Link Traffic Overview
ATM Channel View

The bar graph display is auto-scaling and designed to show *relative* levels of results without a scale displayed. The display may re-scale during a measurement, causing a "jump back" effect.

Payload Analysis (PAYLOAD Column)

Each channel is subsequently scanned in turn and the result of this analysis is presented in the PAYLOAD column and, where appropriate, in the ALARMS column to the right of the bar graphs. The analysis is performed first on the page displayed and then on any subsequent hidden pages.

```

PAYLOAD
AAL1
AAL1
EE-F4-OAM
EE-F4-OAM
AAL1
EE-F4-OAM
EE-F4-OAM
EE-F4-OAM
EE-F4-OAM
AAL1
AAL1
VC-CC
AAL1
    
```

The PAYLOAD column shows the AAL-type or OAM stream information. The hierarchy used for this display is as follows:

(AAL-1, AAL-3/4, AAL-5), TEST CELL, UNKNOWN, VP-CC, VC-CC, NO CELL.

Where cells are found in VCI<32, the payload is described by the expected content as specified in ITU-T Rec I.610. The display "No Cell" indicates that a cell was detected in a VC but no cell activity was detected at the time of the previous scan.

Continuity Checks

Virtual Path continuity checks performed by VP-CC OAM cells, are carried in VCI = 3 (segment) and VCI= 4 (End-to-End) of the virtual path concerned.

As part of PAYLOAD analysis, Channel View looks for Virtual Channel continuity check (CC) OAM cells in each channel of VCI > 31. The VC-CC legend displayed is the result of a logical-OR of the presence of segment and end-to-end VC-CC cells.

ATM Alarms Analysis (ALARMS Column)

VP and VC alarms (AIS and FERF) are signaled in fault management OAM cells. Because path alarms override channel alarms in importance, a VP alarm is indicated in the ALARM column against all the subsidiary VCs affected (all VCs in that VP). Any simultaneous VC alarms are then not visible. However, if a VC alarm occurs alone, it will be displayed against the channel bar for that VC

```

ALARMS
VP-AIS
NO ALARM
N/A
N/A
NO ALARM
N/A
N/A
N/A
N/A
VC-AIS
VC-FERF
NO ALARM
    
```

Other information shown in the ALARM column includes channel associated indications such as VC-LOC, VP-LOC and Congestion for any VCI>31. The hierarchy is as follows: VC-AIS, VC-FERF, VC-LOC, VP-AIS, VP-FERF, VP-LOC, CONGESTION (taken from the PTI), NO ALARM.





Link Traffic Overview ATM Channel View

Selection of a Channel for Further Analysis

Having used Channel View to identify the virtual channels present, the cursor bar may be used to select a particular channel for further analysis.

Press **RUN/STOP** to stop the measurement. (green LED goes out)

Use  and  to move the cursor bar to the chosen channel.

Press **SET**. This action will transfer the VPI / VCI value into the instrument receive filter for analysis when using IN-SERVICE or OUT-OF-SERVICE measurements.

RESULTS	PR	DC	CUMULATIVE	3
RACT	0	0	0	
MAIN	0	0	0	

SRR-PEU			COUNT	
CORRECTED SN PROTECTION			EC	
			ER	
NON-CORR SN PROTECTION			EC	
			ER	
LOST CELL			COUNT	
ELAPSED TIME				

STATUS:				



4

Introduction to In-Service Testing page 54

Cell Layer Error Measurement page 57

Service Policing page 61

Individual Service Performance page 63

In-Service ATM Testing

Information on general In-Service measurement techniques and some practical examples of tests.

In-Service ATM Testing
Introduction to In-Service Testing

Introduction to In-Service Testing

PDH / DS_n physical layer testing is covered in "The HP 37717C PDH / DS_n Operating Manual".

SDH /SONET physical layer testing is covered in "The HP 37717C SDH / SONET Operating Manual".

ATM Layer Testing

An effective form of in-service measurement may be performed by monitoring the AAL in use. The AAL may include a sequence number, length count and/or CRC. Measuring errors in these fields will give a feel for the Quality of Service being delivered on the VC being monitored. It is difficult to map the measurements obtained into values for ATM performance parameters to determine compliance with the traffic contract. However, AAL measurements may reflect more accurately than Out-of-Service intrusive tests the effect that degradation of performance parameters is having on the service being transported.

Because of the nature of ATM, the VP or VC under test may be Out-of-Service but the rest of the physical link may still be carrying live traffic. In some situations it may be useful to set up a test VP or VC for measurement purposes in addition to the VP/VC carrying the user data traffic. It may however be difficult to guarantee that the test VC follows the same route, has the same timing distribution, or is given the same priority as the VC carrying live traffic.

To perform improved in-service measurements, it may be possible to periodically insert test cells of the format described above into live traffic. This, however, would not give a very good indication of the performance of the live data cells because measurements could only be performed on a sampled basis. For example cell loss measurements would only indicate lost test cells.

A more powerful technique using performance management OAM flows has been defined in ITU-T Recommendation I.610. Performance management OAM cells are inserted periodically into live traffic and contain information about the user cell stream. Measurements of ATM performance parameters can be made by monitoring both the live traffic and the OAM cells.

ITU-T Rec I.610 defines a forward monitoring cell and a backward reporting cell. A forward monitoring cell is used to measure the performance of the user cell stream flowing in the same direction and a backward reporting cell reports the results back to the VP or VC source.

In-Service ATM Testing

Introduction to In-Service Testing

The format of the forward monitoring performance management OAM cell defined in ITU-T Rec L.610 comprises the following fields:

- OAM type and function type
- MCSN: monitoring cell sequence number.
- TUC 0+1: total user cell number (CLP 0+1 flow)
- EDC 0+1: block error detection code (CLP 0+1 flow)
- TUC 0: total user cell number (CLP 0 flow)
- TSTP: optional timestamp
- reserved for future use (revision indicator)
- CRC-10 error detection code

The sequence number (MCSN) in this case performs a different function from the sequence number used in the out-of-service test cell. It is used to identify discontinuities in the OAM flow so that certain measurements can be suspended.

Measurement of cell loss or misinsertion can be made using the total user cell number field (TUC). The TUC field is a 16-bit counter which increments for every user cell which is transmitted between OAM cells. If this differs from the number of user cells detected at the receiver between OAM cells, the number of lost or misinserted cells can be calculated.

The BEDC field contains the result of a BIP-16 calculated on the transmitted user cells and is used to estimate the error performance of the user cell stream.

An optional timestamp field has been defined. This may be used by end equipment to perform delay and CDV measurements. These can, however, only be sampled measurements and may not reflect the characteristics of the user traffic very well.

The contents of the OAM cell are protected by a CRC-10. No information is processed if the CRC is in error.

Performance management OAM may be activated and deactivated as required on specific VPs or VCs.

For example, if an end-to-end VC OAM flow (F5) is activated by an end user to monitor the Quality of Service being provided by the network operator, it is possible for the network operator to monitor the backward reporting cells to assess the end-to-end performance. Also, forward monitoring cells can be monitored at any point in the network to isolate faults. In addition, the network operator may activate VP end-to-end OAM to verify the performance of virtual paths within the network or also VP or VC segment OAM.

In-Service ATM Testing
Introduction to In-Service Testing

Any OAM flows set up by the end user will have to be included in the service contract and policed as part of the user data. Performance management OAM flows may be monitored by network equipment or test equipment.

The instrument analyzes some of the performance management OAM fields to provide In-Service measurements.

In-Service ATM Testing
Cell Layer Error Measurement

Cell Layer Error Measurement

Options required ATM Cell Layer **UKN (USE)** or **UKZ**
For SDH interfaces **US1 (US5)**
For SDH / SONET interfaces **AIT (AIU)** and **USN**

It can be extremely useful to measure the performance of the ATM service while transporting live traffic. Measurement of physical layer overhead, corrected and non-corrected ATM header errors and 1-point CDV are possible as well as monitoring the received cell count in the VP or VC under test.

In addition, performance management OAM flows generated by network equipment may be used to perform In-Service measurements of cell loss, cell misinsertion and cell errors. In this case the cell error measurement is performed using a BEDC (block error detection code) transmitted in the OAM cells. Performance management OAM cells are inserted periodically into live traffic and contain information about the user cell stream. Measurements of ATM performance parameters can be made by monitoring both the live traffic and the OAM cells.

If a VP has been selected for test, VP segment or end to end performance management OAM cells (F4 flow) are monitored. If a VC has been selected for test, VC segment or end to end Performance management OAM cells (F5 flow) are monitored.

Default (Known State) Settings

It is advisable to set the HP 37717C to a known state before setting up a measurement. This clears all previous settings and provides a clearly defined instrument state. The default settings are set by selecting **OTHER**
STORED SETTINGS STORED SETTING NUMBER 0.

ATM In-Service Test Setup Procedure, SDH Interface Example

This example uses ATM module **UKN** with SDH interface module **US1**.

In this setup an STM-1 optical or electrical cell stream is monitored and Performance Management OAM measurements are made using the HP 37717C in a *Receive only* mode.

In-Service ATM Testing Cell Layer Error Measurement

- 1 Set up the **RECEIVE ATM PHYSICAL LAYER** display for the appropriate interface rate.

```

RECEIVER INPUT [ ATM ]
PHYSICAL: ATM TEST HEADER
LAYER: LAYER FUNCTION MONITOR
SIGNAL [ STM-1 OPT ]

CELL SCRAMBLING [ ON ]

File MULTIPLE WINDOW
    
```

- 2 Set up the **RECEIVE ATM ATM LAYER** display as shown.

LIVE TRAFFIC allows In-Service testing at the ATM layer.

PERFORMANCE MANAGEMENT [END TO END] allows Cell Loss, Cell Misinsertion and BEDC BIP-16 measurements to be made on the performance management OAM.

```

RECEIVER INPUT [ ATM ]
PHYSICAL: ATM TEST HEADER
LAYER: LAYER FUNCTION MONITOR
INTERFACE [ UNI ]
CELL SELECTED FOR TEST [ VC ]
CELL HEADER DFC VPI UCI PTI CLP
[ 0 ] [ 32 ] [ 0 ] [ 0 ]
CELL PAYLOAD [ LIVE TRAFFIC ]
MEASURED AVG. CELL RATE
PEAK CELL RATE [ 100 ]
CPU TOLERANCE [ 10 ]
PERFORMANCE MANAGEMENT [ END-TO-END ]
BLOCK SIZE [ 1024 ]

UC OAM ANALYSIS ENABLED.

File OFF SECURITY END-TO-END MULTIPLE WINDOW
    
```

The OAM block size may be entered. If this is unknown, select 1024 (maximum available). Selecting a block size smaller than that in use may cause PM OAM LOSS. If the OAM cells selected are not present, a status message "PM OAM LOSS alarm" will appear on the display.

- 3 Set up the **RESULTS** display as shown.

BEDC BIP-16 results are displayed. Any other results can be displayed without affecting the measurement.

```

RESULTS [ ATM ] [ CUMULATIVE ]
ERRORS: MISINS BEDC INDICATOR NONE
CELLS: CELLS: CELLS: CELLS
BEDC BIP-16
COUNT
RATIO
ELAPSED TIME

File MULTIPLE WINDOW
    
```

Run the In-service ATM Test

- 1 Press **RUN/STOP** to start the test.

In-Service ATM Testing
Cell Layer Error Measurement

ATM In-Service Test Setup Procedure, SDH / SONET Interface Example

This example uses ATM module UKZ with SDH / SONET interfaces AIT (AIU) and USN.

In this setup an OC-3c cell stream is monitored and Performance Management OAM measurements are made using the HP 37717C in a *Receive only* mode.

- 1 Set up the **RECEIVE ATM PHYSICAL LAYER** display for the appropriate interface rate.

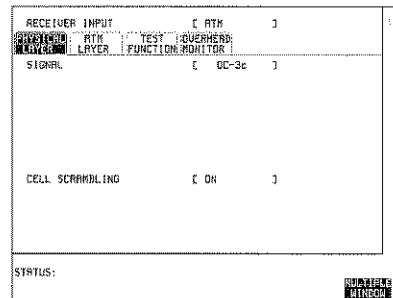

- 2 Set up the **RECEIVE ATM ATM LAYER** display as shown.

MEASUREMENT MODE

IN SERVICE allows LIVE TRAFIC testing at the ATM layer.

PERFORMANCE MANAGEMENT [END TO END] allows Cell Loss, Cell Misinsertion and BEDC BIP-16 measurements to be made on the performance management OAM.

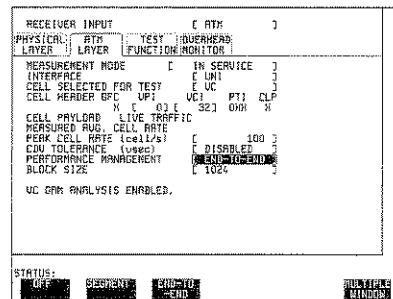

The OAM block size may be entered. If this is unknown, select 1024 (maximum available). Selecting a block size smaller than that in use may cause PM OAM LOSS. If the OAM cells selected are not present, a status message "PM OAM LOSS alarm" will appear on the display.

In-Service ATM Testing Cell Layer Error Measurement

- 3 Set up the **RESULTS** display as shown.

BEDC BIP-16 results are displayed.
Any other results can be displayed
without affecting the measurement.

RESULTS E ATM		IF CUMULATIVE		J	
CELLS	LOST	REC	CELLS	ERRORS	ERRORS
BEDC BIP-16					
COUNT					
RATIO					
ELAPSED TIME					
STATUS:					

Run the In-service ATM Test

Press **RUN/STOP** to start the test.

In-Service ATM Testing
Service Policing

Service Policing

Options required 0YK, USK or USL

An In-service Rate History test to check that a service is operating within agreed rate limits.

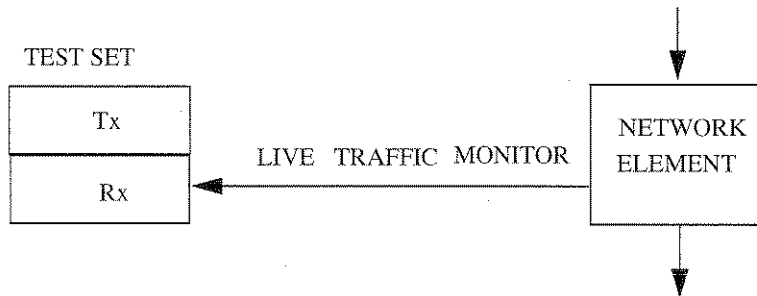

Select the VPI/VCI to be tested.

RECEIVER INPUT	[ATM]
PHYSICAL LAYER	[ATM]
JITTER	[RAL]
MEASUREMENT MODE	[IN SERVICE]
INTERFACE	[UNI]
CELL SELECTED FOR TEST	[UC]
CELL HEADER GFC	[UC]
PI	[32]
CLP	[0]
CELL PAYLOAD	[LIVE TRAFFIC]
MEASURED AVG. CELL RATE	[100]
PERK CELL RATE (cell/s)	[DISABLED]
CDU TOLERANCE (usec)	[DISABLED]
PERFORMANCE MANAGEMENT	[OFF]

UC DM ANALYSIS ENABLED.

STATUS: SUGGESTS USER DEFINED MULTIPLE HINDER

At the interface (physical layer) level, set the results storage to the resolution required for the Rate History display.

RESULTS (TIMING CONTROL)	
SHORT TERM PERIOD	[10 SECONDS]
TEST TYPING	[NORMAL]
STORAGE	[ON WITH RESOLUTION]

STATUS: OFF 1 SEC RESOLN 5 MIN RESOLN 15 MIN RESOLN 1 HR RESOLN MULTIPLE HINDER

In-Service ATM Testing Service Policing

At the ATM level. Press **RESULTS** and select **RATE HISTORY**. This is a simple monitoring function of maximum, mean and minimum cell rates of a specified VP or VP / VC. The received cells selected for test are “VPI value” or “VCI value” with a payload of live traffic.

Note: the setting of the payload to live traffic avoids the instrument making erroneous measurements on non-test data.

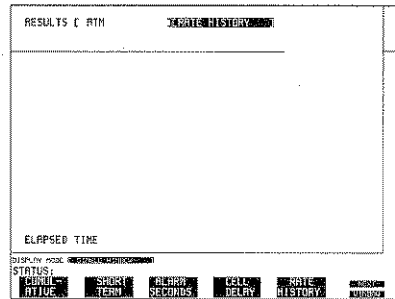

Each bar on the graph represents a time interval as selected for the storage resolution of physical layer results as shown on page 61. The numeric values of cell rate for any single bar on the graph may be displayed by selecting the point of interest with the cursor. The Maximum, Mean and Minimum cell rates for the whole of the test period are always displayed.

Definitions of maximum, mean and minimum cell rates are as follows:

Maximum cell rate: The inverse of the shortest inter-cell time received during the measurement interval.

Minimum cell rate: The inverse of the longest inter-cell time received during the measurement interval.

Mean cell rate: The average number of cells received during the measurement interval, divided by the interval.

In-Service ATM Testing Individual Service Performance

Individual Service Performance

Options required 0YK, USK or USL

In-service AAL Monitoring provides performance monitoring related to individual services.

The receiver must be set for the appropriate AAL service (AAL-1, AAL3-4 or AAL-5). The instrument will automatically search for AAL type when ADAPTATION LAYER is set to

AUTO

```

RECEIVER INPUT [ ATM ]
PHYSICAL: [ ATM ] TEST [ OVERHEAD ] AAL [ ]
LAYER [ ] FUNCTION [ MONITOR ]
ADAPTATION LAYER [ AUTO ]
STATUS:
[ AUTO ] [ AAL ] [ AAL3/4 ] [ AAL5 ] [ HOLD ] [ MULTIPLE WINDOW ]
    
```

The **RESULTS** provides In-Service error examination of the AAL structures supporting the service data.

```

RECEIVER INPUT [ ATM ]
PHYSICAL: [ ATM ] TEST [ OVERHEAD ] AAL [ ]
LAYER [ ] FUNCTION [ MONITOR ]
MEASUREMENT NODE [ IN SERVICE ]
INTERFACE [ UNI ]
CELL SELECTED FOR TEST [ UC ]
CELL HEADER GFC UPI [ UC1 FTI CLF ]
CELL PAYLOAD [ LIVE TRAFFIC ]
MEASURED AVG. CELL RATE [ 100 ]
PEAK CELL RATE (cells/s) [ DISABLED ]
CDB TOLERANCE (usec) [ ]
PERFORMANCE MANAGEMENT [ END-TO-END ]
BLOCK SIZE [ 1024 ]
VC CDM ANALYSIS ENABLED.
STATUS:
[ MULTIPLE WINDOW ]
    
```

```

RESULTS [ AAL ] [ CUMULATIVE ]
AAL [ ]
MAIN [ SUMMARY ]
SRR-PDU COUNT
CORRECTED SN PROTECTION EC ER
NON-CORR SN PROTECTION EC ER
LOST CELL COUNT
ELAPSED TIME
STATUS:
[ MULTIPLE WINDOW ]
    
```



In-Service ATM Testing
Individual Service Performance



5

ATM Cell Performance Test page 66

Cell Routing Test page 72

Cell Congestion Test page 73

Cell Sync and Header Error Correction Test page 75

Measuring Cell Transfer Delay and Cell Delay Variation page 77

Constant Bit Rate Service Assessment page 79

Alarm Testing page 80

Out-of-Service ATM Testing

Information on setting up the stimuli for out of service tests and some practical examples of tests.

Out-of-Service ATM Testing
ATM Cell Performance Test

ATM Cell Performance Test

Options required ATM cell generation and analysis, UKN (USE) or UKZ

NOTE: Displays for the selection of some functions will vary, depending on the optional modules fitted. The following example uses displays from an instrument with options 0YK, USK or USL. The selection procedure will vary slightly for instruments without an ATM Services module see "ATM Module Features" page 33

Application

Services carried on ATM have differing sensitivities to the problems related to ATM. Constant Bit Rate traffic, such as voice and video conferencing, are sensitive to Cell Delay and Cell Delay Variation. Video on Demand and Cable TV are sensitive to Cell Delay Variations.

Some services, such as Compressed Video, are sensitive to Cell Loss. All these parameters must be tested to verify the ATM network will carry the appropriate service error free. Similarly these parameters are used during Quality of Service tariff negotiations with customers and therefore need to be verified.

The HP 37717C can perform these measurements for both Constant Bit Rate and Variable Bit Rate traffic. Constant Bit Rate traffic is simulated using the Foreground Channel (measurement channel) constant distribution. Variable Bit Rate traffic is simulated by adding bursts of cells using the CONSTANT and BURST features of the HP 37717C.

A number of background (non-measurement channels) channels (3 with Cell Layer modules only and 9 with Cell Layer and Services modules) can be independently set to give different traffic profiles for testing the ATM link under real conditions.

Default (Known State) Settings

It is advisable to set the HP 37717C to a known state before setting up a measurement. This clears all previous settings and provides a clearly defined instrument state. For a list of Default Settings and the procedure for accessing them see Stored Settings in the Operating Manual.

ATM Cell Performance Test Setup Procedure

In this setup example, a 34 Mb/s cell stream containing a test cell is transmitted into the network equipment.

Out-of-Service ATM Testing ATM Cell Performance Test

To perform simultaneous measurements of most ATM performance parameters, TEST CELL should be chosen as the payload. Alternatively, if a BER measurement on the cell payload is required then select cross-cell or single-cell PRBS.

A SINGLE test period of 24 HOURS is used and use of a printer for recording of results and alarms is included.

The HP 37717C Communications Performance Analyzer GRAPHICS function is enabled. The graphical results can be viewed on the **GRAPH** display

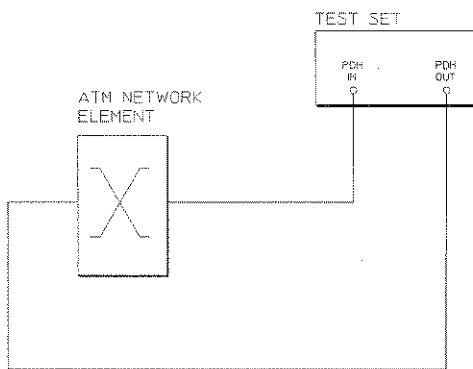

ATM Cell Performance

Out-of-Service ATM Testing ATM Cell Performance Test

- 1 Connect the HP 37717C to the network equipment and set up the **OTHER** **SETTINGS CONTROL** display as shown below.

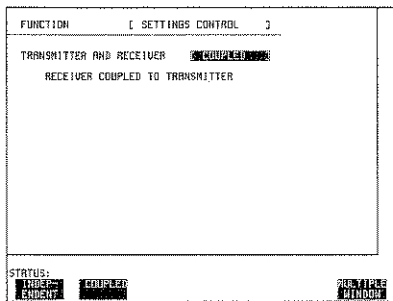

Any settings change made on the **TRANSMIT** or **RECEIVE** displays will automatically occur on the other

- 2 Set up the **TRANSMIT** **ATM PHYSICAL LAYER** display as shown below.

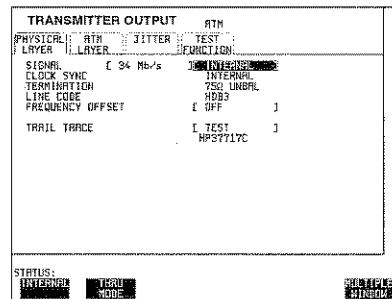

Frequency Offset can be added for stress testing. Trail Trace allows tracing of the test signal.

- 3 Set up the **TRANSMIT** **ATM LAYER DISTRIBUTION** display as shown below.

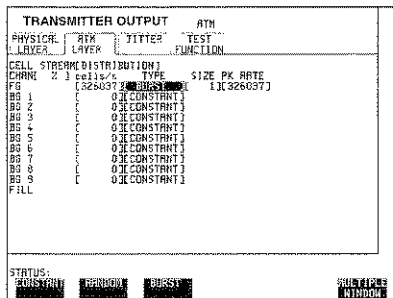

The number of backgrounds available varies with optional modules.

- 4 Set up the **TRANSMIT** **ATM LAYER PAYLOAD** display, as shown below.

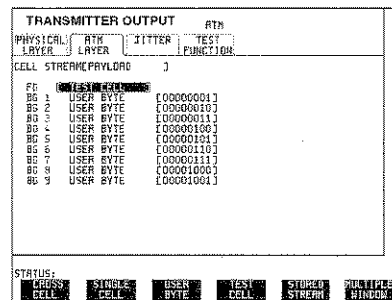

For BER testing select **CROSS CELL** or **SINGLE CELL** and required PRBS.

Out-of-Service ATM Testing ATM Cell Performance Test

5 VPI and VCI settings determine the routing of the cell stream

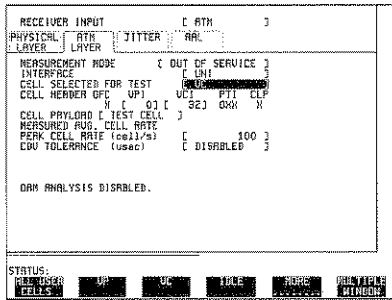

6 Set up the **RECEIVE** **ATM LAYER** display as shown below

If PEAK CELL RATE and CDV TOLERANCE are known; enter these values. The Non Conforming Cell count and ratio results will indicate the number of cells exceeding these parameters. If no non-conforming cells are counted, the max one-point CDV result shows the max CDV present. The margin to non-conformance can then be calculated as (CDV tolerance - max 1-point CDV)

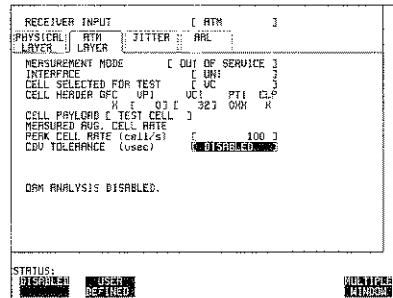

Non-conforming cells can be caused in two ways, with the following effects:

- If the received cell rate exceeds the PCR, the non-conforming cell count will equal (Rx cell count - PCR).
- If the received cell stream contains CDV exceeding the CDV tolerance, non-conforming cells will be counted. For example, if the Rx cell rate = PCR, and a known uniform burst distribution is received, the CDV is related to the burst size. If the CDV tolerance is NOT known, select CDV tolerance DISABLED. The max one-point CDV result then shows the CDV tolerance required to ensure the cells are conforming to the PCR chosen.

If the PEAK CELL RATE is not known, this should be set to at least equal the average cell rate for a Constant Bit Rate service and can be estimated by gating the HP 37717C for a few seconds. This value can then be transferred into the PEAK CELL RATE by selecting **AVERAGE+1** on the display.

Out-of-Service ATM Testing ATM Cell Performance Test

NOTE

The inherent nature of the 1-point CDV algorithm requires that the PEAK CELL RATE selected by the user **must** be no less than the peak cell rate - otherwise the measurement becomes unstable with an ever increasing 1-point CDV value being displayed. In the graphical CDV case (options 0YK, USK or USL), the CDV distribution display rapidly drifts across the screen.

- 7 Select the type of printer you have connected and set up the **OTHER** display, **LOGGING** function, as shown below.

FUNCTION	[LOGGING]]
LOGGING SETUP	[CONTROL]]
LOGGING PERIOD	[ON]]
	[1 HOUR]]
RESULTS LOGGED WHEN	[SELECTED]]
CONTENT	[PERIOD EC>0]]
	[ER & FBAL]]
LOG ERROR SECONDS	[PER & FBAL]]
LOG AT END OF TEST	[OFF]]
	[ALL RESULTS]]
LOG ON DEMAND	RESULTS	

STATUS: ALARMS PERIOD EC>0 MULTIPLE WINDOW

WHEN [PERIOD EC>0] ensures results are not logged on the printer when a print period is error free.

- 8 Set up the **RESULTS** display, as shown below.

RESULTS E ATR	2-POINT DELAY
1-POINT	2-POINT
GRAPH	
MAX: 1-PT	
CDV	1.6
ELAPSED TIME	
STATUS:	
ALARMS	SHORT TERM
ALARM SECONDS	CELL DELAY
RATE HISTORY	MULTIPLE WINDOW

Any of the other results can be viewed without affecting the measurement.

If you do not require stored graphics results select STORAGE [OFF].

Start the ATM Cell Performance Test

- 1 Press **RUN/STOP** to start the measurement.

The measurement results and alarms are available on the **RESULTS** display during the test period.

The graphical measurement results and alarms are stored in non volatile memory for viewing later on the **GRAPH** display.

The test can be halted at any time by pressing **RUN/STOP**.

Out-of-Service ATM Testing
ATM Cell Performance Test

At the End of the Test (ATM Cell Performance)

- The Date and Time the test started and the instrument setup are logged on the printer.
- Results are logged on the printer at 1 hour intervals if the error count is greater than 0.
- Any alarms which occur during the test period will be logged on the internal printer.
- At the end of the test period a complete set of cumulative results is logged on the printer.
- A graphical record of the results during the test period can be viewed on the **GRAPH** display. If Remote Control option 1A8 (HP-IB) or 1CW (RS-232-C) is fitted the graph results can be logged to an external printer, at a later date.
- Results and Alarm summaries can be viewed on the **GRAPH** display.

The total graphics store capacity is normally 20,000 events. If GRAPH STORAGE RESOLUTION [FULL] is selected on the **OTHER MISCELLANEOUS** display the capacity reduces to 10,000 events.

The resolution, determined by the selection made under STORAGE on the **RESULTS** display, affects the ZOOM capability when viewing the bar graphs. If 1 SECOND is selected all resolutions are available under ZOOM. If 1 MIN is selected only 1 MIN/BAR, 15 MINS/BAR and 60 MINS/BAR are available.

If 15 MINS is selected only 15 MINS/BAR and 60 MINS/BAR are available. If 1 HOUR is selected only 60 MINS/BAR is available.

Up to 10 sets of graphical results can be stored. If an attempt is made to store more than 10 sets of results, then a first in first out policy is operated and the oldest set of results will be lost. If graphics are enabled and a test is run which exceeds the remaining storage capacity, then some previously stored graphical results will be lost.

To prevent accidental overwriting of previously stored results the graphics capability should be disabled, when graphical results are not required, by selecting STORAGE [OFF] on the **RESULTS** display.

Out-of-Service ATM Testing
Cell Routing Test

Cell Routing Test

Options required: ATM cell generation and analysis, **UKN (USE) or UKZ**

NOTE: Displays for the selection of some functions will vary, depending on the optional modules fitted. The following example uses displays from an instrument with a Broadband Auxiliary module 0YK or an ATM Services module USK or USL. The selection procedure will vary slightly for instruments without these modules.

This test is designed for installation and troubleshooting devices such as ATM cross-connects and switches which use routing tables. The object of this type of test is to check the implementation of switch routing tables and therefore the VP and VC mapping ability of the switch.

All ten virtual channels can be used for this test. The payload of each channel is set to a different fixed byte (for individual channel identification after routing) and the cell stream is applied to one input of the ATM switch / cross-connect. Initially, Channel View may be used to confirm the output of the ten channels. The receiver may then be used to check that only the appropriate channel is routed to particular outputs.

<p>TRANSMITTER OUTPUT ATM</p> <p>PHYSICAL ATM JITTER TEST LAYER LAYER FUNCTION</p> <p>CELL STREAM PAYLOAD</p> <pre> FG C USER BYTE 00000000 BG 1 USER BYTE 00000001 BG 2 USER BYTE 00000010 BG 3 USER BYTE 00000011 BG 4 USER BYTE 00000100 BG 5 USER BYTE 00000101 BG 6 USER BYTE 00000110 BG 7 USER BYTE 00000111 BG 8 USER BYTE 00001000 BG 9 USER BYTE 00001001 </pre> <p>STATUS: 0 [SET] [LEFT] [RIGHT] MULTIPLE WINDOW</p>	<p>RECEIVER INPUT C ATM</p> <p>PHYSICAL ATM JITTER RAL LAYER LAYER</p> <p>MEASUREMENT MODE I OUT OF SERVICE INTERFACE C UN CELL SELECTED FOR TEST C UC CELL HEADER OPC UP1 UC1 PT1 CLP H I 01 C 323 000 X CELL PAYLOAD C USER BYTE X 00000000 MEASURED AVG. CELL RATE PEAK CELL RATE (cells/s) [100] CNU TOLERANCE (ussec) [DISABLED]</p> <p>GM ANALYSIS DISABLED.</p> <p>STATUS: 0 [SET] [LEFT] [RIGHT] MULTIPLE WINDOW</p>
--	--

Out-of-Service ATM Testing
Cell Congestion Test

Cell Congestion Test

Options required ATM cell generation and analysis, UKN (USE) or UKZ

NOTE: Displays for the selection of some functions will vary, depending on the optional modules fitted. The following example uses displays from an instrument with an ATM Services module USK or USL. The selection procedure will vary slightly for instruments without an ATM Services module.

This test is designed mainly for ATM switch installation and acceptance testing.

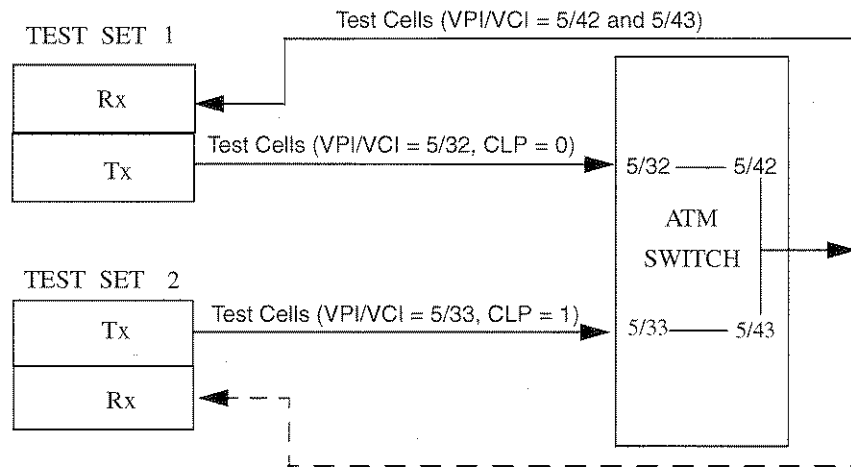

Cell Discard Test

Two test sets are used to generate test cells. The VPI/VCI chosen for each test cell stream is arbitrary but the test cells from Test Set 1 should be sent with CLP = 0 (high priority) and the test cells from Test Set 2 should be sent with CLP = 1 (low priority).

The ATM switch should be configured as shown. The routing table in the switch should be configured to route the cells from the two test sets to the same output port but with different (but known) VPI/VCIs. In this example, Test Cells from Test Set 1 arrive at the switch with VPI/VCI = 5/32 and those from Test Set 2 with VPI/VCI = 5/33. The switch is set to translate the cell routing labels from 5/32 to 5/42 and from

Out-of-Service ATM Testing Cell Congestion Test

5/33 to 5/43. Cells from both test sets now appear on the same output link from the switch.

Assuming that the maximum cell rate of the switch output is less than the sum of the maximum cell input rates, it is possible to arrange that congestion occurs in the switch by suitable loading of the inputs.

Test Set 2 is set to send cells at 50% of the maximum rate.

The output rate of Test Set 1 (with higher priority cells) is slowly increased while the switch output is monitored by Test Set 1.

If Test Set 1 monitors high priority cells (in this example VPI / VCI = 5 / 42), originally from the same test set, no cell loss should be observed, though the STATUS line at the bottom of the display should indicate "congestion experienced" if the switch sets the PTI field appropriately.

If Test Set 1 is reconfigured to monitor the low priority cell stream which originated from Test Set 2 (in this example VPI / VCI = 5 / 43), cell loss should be observed.

If the signal from the switch can be physically split and routed to the receiver of Test Set 2, the measurements for each cell stream can be performed simultaneously.

As an alternative means of monitoring for cell loss (with options OYK, USK or USL), Channel View may be used to monitor both cell stream rates at the switch output. Furthermore, both input cell streams (a Foreground and a Background, say) may be generated by Test Set 1 on a single physical port. Test Set 2 is then not required.

Out-of-Service ATM Testing
Cell Sync and Header Error Correction Test

Cell Sync and Header Error Correction Test

Options required ATM cell generation and analysis, UKN (USE) or UKZ

This test is designed mainly for ATM switch installation and acceptance testing.

The ability of the network element to pass an error free, identifiable stream without sync loss is checked.

Checking Single Header Error Performance

The ability to pass cells with single header errors and generate a valid HEC for the new header is checked. This is achieved as follows:

<p>1 Introducing headers with one error by selecting single HEC errors</p> <div style="border: 1px solid black; padding: 5px; margin: 5px;"> <table style="width: 100%; border-collapse: collapse;"> <tr> <td style="width: 30%; border-bottom: 1px solid black;">PHYSICAL LAYER</td> <td style="width: 30%; border-bottom: 1px solid black;">ATM LAYER</td> <td style="width: 30%; border-bottom: 1px solid black;">JITTER TEST FUNCTION</td> <td style="width: 10%; border-bottom: 1px solid black;">ATM</td> </tr> <tr> <td style="border-bottom: 1px solid black;">TEST FUNCTION (ATM PAYLD)</td> <td style="border-bottom: 1px solid black;">ERR & ALARM</td> <td colspan="2"></td> </tr> <tr> <td style="border-bottom: 1px solid black;">ERROR RD TYPE</td> <td style="border-bottom: 1px solid black;">STREAM</td> <td style="border-bottom: 1px solid black;">[SINGLE HEADER]</td> <td></td> </tr> <tr> <td style="border-bottom: 1px solid black;">RATE</td> <td style="border-bottom: 1px solid black;">[1/20 CELLS]</td> <td colspan="2"></td> </tr> <tr> <td style="border-bottom: 1px solid black;">DAN CELL ALARMS</td> <td style="border-bottom: 1px solid black;">[OFF]</td> <td colspan="2"></td> </tr> </table> <p style="font-size: small; margin-top: 5px;">STATUS: <input type="checkbox"/> SINGLE HEC <input type="checkbox"/> DOUBLE HEC <input type="checkbox"/> BIT MULTIPLE WINDOW</p> </div>	PHYSICAL LAYER	ATM LAYER	JITTER TEST FUNCTION	ATM	TEST FUNCTION (ATM PAYLD)	ERR & ALARM			ERROR RD TYPE	STREAM	[SINGLE HEADER]		RATE	[1/20 CELLS]			DAN CELL ALARMS	[OFF]			<p>2 Checking that the output corrected HEC error rate is zero.</p> <div style="border: 1px solid black; padding: 5px; margin: 5px;"> <table style="width: 100%; border-collapse: collapse;"> <tr> <td style="width: 30%; border-bottom: 1px solid black;">RESULTS (ATM)</td> <td style="width: 30%; border-bottom: 1px solid black;">IC CUMULATIVE</td> <td style="width: 40%;"></td> </tr> <tr> <td style="border-bottom: 1px solid black;">CELLS LOST</td> <td style="border-bottom: 1px solid black;">PAYLOAD ERRORS</td> <td></td> </tr> <tr> <td style="border-bottom: 1px solid black;">CORRECTED HEC ERRORS</td> <td colspan="2"></td> </tr> <tr> <td style="border-bottom: 1px solid black;">COUNT</td> <td colspan="2"></td> </tr> <tr> <td style="border-bottom: 1px solid black;">RATIO</td> <td colspan="2"></td> </tr> <tr> <td style="border-bottom: 1px solid black;">NON CORRECTED HEC</td> <td colspan="2"></td> </tr> <tr> <td style="border-bottom: 1px solid black;">COUNT</td> <td colspan="2"></td> </tr> <tr> <td style="border-bottom: 1px solid black;">RATIO</td> <td colspan="2"></td> </tr> <tr> <td colspan="3" style="border-bottom: 1px solid black;">ELAPSED TIME</td> </tr> <tr> <td colspan="3">STATUS:</td> </tr> </table> <p style="font-size: small; margin-top: 5px; text-align: right;">MULTIPLE WINDOW</p> </div>	RESULTS (ATM)	IC CUMULATIVE		CELLS LOST	PAYLOAD ERRORS		CORRECTED HEC ERRORS			COUNT			RATIO			NON CORRECTED HEC			COUNT			RATIO			ELAPSED TIME			STATUS:		
PHYSICAL LAYER	ATM LAYER	JITTER TEST FUNCTION	ATM																																																
TEST FUNCTION (ATM PAYLD)	ERR & ALARM																																																		
ERROR RD TYPE	STREAM	[SINGLE HEADER]																																																	
RATE	[1/20 CELLS]																																																		
DAN CELL ALARMS	[OFF]																																																		
RESULTS (ATM)	IC CUMULATIVE																																																		
CELLS LOST	PAYLOAD ERRORS																																																		
CORRECTED HEC ERRORS																																																			
COUNT																																																			
RATIO																																																			
NON CORRECTED HEC																																																			
COUNT																																																			
RATIO																																																			
ELAPSED TIME																																																			
STATUS:																																																			

The corrected HEC error rate checks that the HEC is valid for the new header added by the network element under test.

Checking Double Header Error Performance

The ability to discard cells with two or more detected header errors is tested. This is achieved as follows:

Out-of-Service ATM Testing
Cell Sync and Header Error Correction Test

1 Introducing headers with two errors.

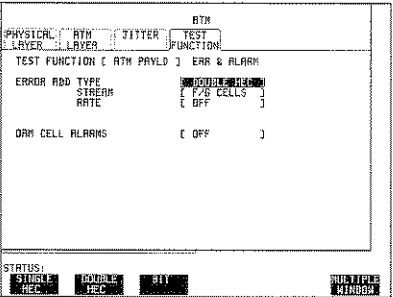

The screenshot shows a terminal window with the following configuration:

```

PHYSICAL: ATM TEST
LAYER: LAYER FUNCTION:
TEST FUNCTION [ ATM PAYLD ] ERR & ALARM
ERROR ADD TYPE [ STREAM ]
RATE [ P/D CELLS ]
DAM CELL ALARMS [ OFF ]
        
```

STATUS: SINGLE REC. DOUBLE REC. BIT MULTIPLE WINDOW

2 Checking that the errored cells are discarded as indicated by cell loss.

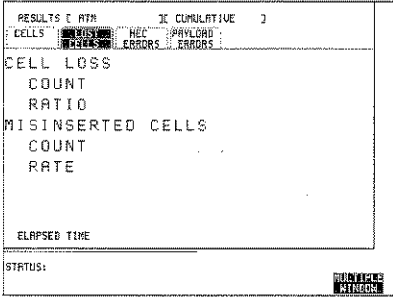

The screenshot shows a terminal window with the following results:

```

RESULTS [ ATM ] [ CUMULATIVE ]
CELLS [ ] [ ] [ ] [ ]
[ ] [ ] [ ] [ ]
CELL LOSS
COUNT
RATIO
MISINSERTED CELLS
COUNT
RATE
ELAPSED TIME
STATUS:
        
```

A sequence of more than 40 errors may be used in order to check that the result is valid for errors occurring in any header bit as the test set is designed to cycle the errored bit through all 40 bit positions of the header on consecutive instances of ERROR ADD (manual or continuous).

Out-of-Service ATM Testing
Measuring Cell Transfer Delay and Cell Delay Variation

Measuring Cell Transfer Delay and Cell Delay Variation

Cell transfer delay may occur because of physical layer switching and propagation delay over long transmission paths. At the ATM layer, queueing and cell multiplexing may cause additional and varying delay (CDV). CDV is accentuated when a virtual circuit is multiplexed with a highly variable traffic load or when congestion is approached in ATM switches. Delay may also be caused by traffic shaping.

Cell transfer delay and CDV should not affect data transfer applications but will affect audio and video services. For telephony and videoconferencing, the round trip delay may make communication difficult. Constant Bit Rate services require the CDV to be controlled to minimize the depth of reconstruction buffers and to minimize jitter in the service clock recovery at the receive end

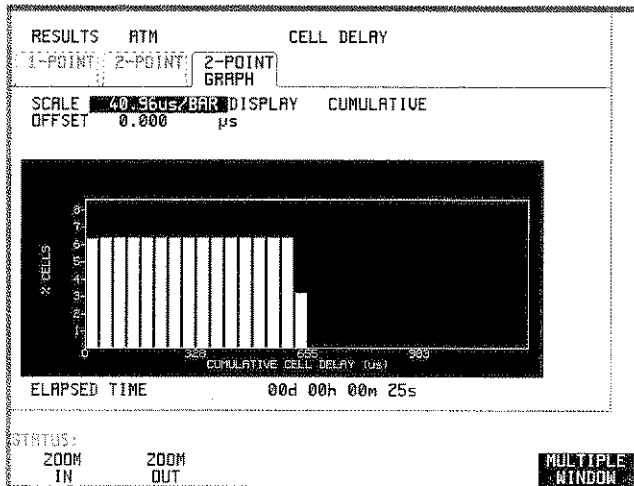

- 1 Set up the **RECEIVE ATM** PHYSICAL LAYER interface.
- 2 Set up the **RECEIVE ATM** ATM LAYER. If you are measuring 2-point CDV the foreground payload must be the test cell.

Out-of-Service ATM Testing

Measuring Cell Transfer Delay and Cell Delay Variation

1pt CDV and 2pt CDV results are available with options UKZ.

1pt CDV and 1pt CDV Graph are available with In Service Measurement (options USK, 0YK, USL).

1pt CDV, 2pt CDV and 2pt CDV Graph are available with Out of Service Measurement (options USK, 0YK, USL).

For 2pt CDV, the CELL PAYLOAD must be the test cell

3 If a graph display with short term results is required, set **RESULTS TIMING CONTROL** SHORT TERM PERIOD.

4 For numerical results, choose **RECEIVE ATM RESULTS CELL DELAY** 1-POINT or 2_POINT and press **RUN/STOP** to start the test.

For the best results, the delay variations should be displayed with a high resolution by giving the graph an offset.

Run a short test as described below, to allow the instrument to determine the offset required.

Set the offset as determined by the instrument (AUTO) and run the test for the highest resolution display.

5 Choose **RECEIVE ATM RESULTS CELL DELAY** 2-POINT GRAPH

6 Press **RUN/STOP** to start a test which will enable the instrument to establish the offset required.

7 When some results are displayed, press **RUN/STOP** to stop the test (the offset can be changed only when the instrument is not gating).

8 Select OFFSET **AUTO**.

9 Set DISPLAY to **SHORT TERM** or **CUMULATIVE**.

10 Press **RUN/STOP** to start a new test with higher resolution displayed.

11 Use SCALE **ZOOM IN** and **ZOOM OUT** to view the time period of interest.

Out-of-Service ATM Testing
Constant Bit Rate Service Assessment

Constant Bit Rate Service Assessment

Options required ATM cell generation and analysis, UKN (USE) or UKZ

The object of this test is to check that a network element is suitable for a constant bit rate service where the regular arrival of cells is essential for the integrity of the service.

Each bar on the results graph represents a time interval as selected for the storage resolution of physical layer results (for selection see page 61). The test timing is as selected for the physical layer results

This test uses the time stamp function of the test cell.

The 2-point Cell Delay Variation measurement is based on absolute delays measured from the Test Cell timestamp. This measurement may be considered as ATM Jitter.

The 2-point CDV relies on the time stamp in the test cell and therefore the Test Set transmitter and receiver must be coupled. The time of cell arrival is monitored and compared with the transmission time extracted from the test cell. The results are presented in the form of Maximum, Peak-to-Peak and Mean Cell Transfer delays. The variation is presented in terms of the peak to peak values recorded. With options USK or USL, more detail of the time distribution of cell delays can be seen by using the graphical display facility.

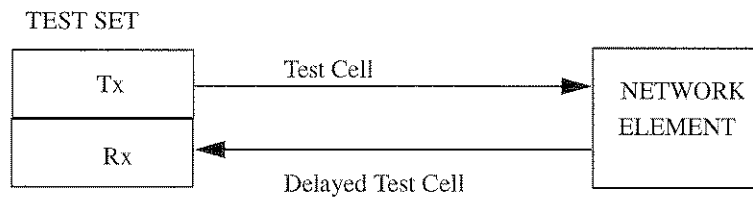

Out-of-Service ATM Testing
Alarm Testing

Alarm Testing

Options required ATM cell generation and analysis, **UKN (USE) or UKZ**

The object of this series of tests is to check the ability of a network element to recognize and respond to AIS and FERF alarms.

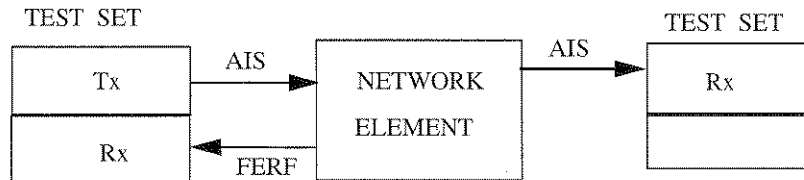

There are two groups of tests: F4 flow tests for the VP OAM and F5 flow for the VC OAM. Each group comprises three parts.

1 Ability to Generate AIS

The network element is stimulated with a stream which will cause it to originate an AIS alarm.

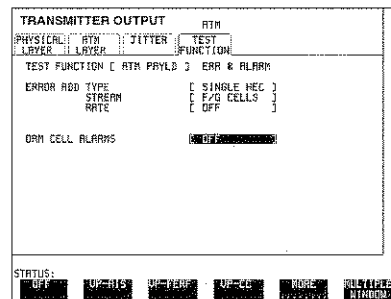

2 Ability to Forward AIS and Return FERF

The network element is stimulated with a stream containing the VP-AIS or VC-AIS alarm. The forward path AIS and the return path FERF are monitored.

3 Ability to Signal Received FERF

The network element is stimulated with a stream containing the OAM cell FERF alarm and the network element FERF indicator, if available, is observed.

I.610 defines the fixed VPI and VCI values which the instrument uses for the OAM cells in these tests

6

“Continuity Testing and Discontinuity Location” page 82

“Packet Loss and Response Time” page 86

“Packet Loss and Response Time Under Load” page 90

“Error Correction Level Indication” page 95

“Ethernet Collisions” page 98

LAN Testing Examples

LAN Testing Examples
Continuity Testing and Discontinuity Location

Continuity Testing and Discontinuity Location

Option Required: USL

The simplest and most general test is a go and return test to a remote device. In this case pings are transmitted to the remote device and the reception of echoes indicates correct connection.

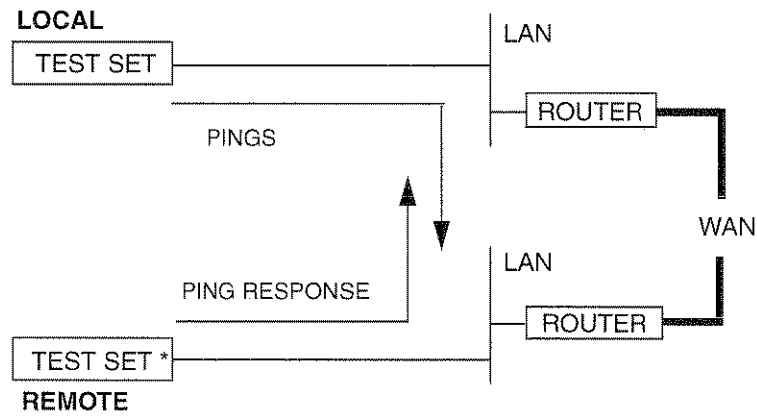

*In Internet Protocol (IP) networks, an automatically responding device may be used as an alternative to the remote test set.

Continuity of networks is checked by transmitting a special packet (ping) to a device which is set to return a response.

In IP Networks, the location of a discontinuity may be determined by "pinging" addressable devices, for example routers, on the path.

LAN Testing Examples Continuity Testing and Discontinuity Location

Remote End Set up

Set up the **RECEIVE** physical layer.

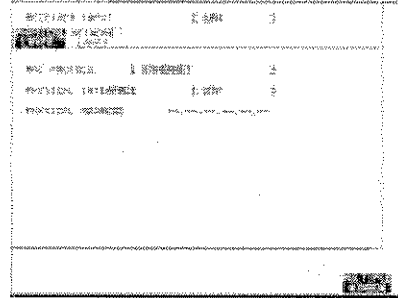

Set up the **RECEIVE** network layer.

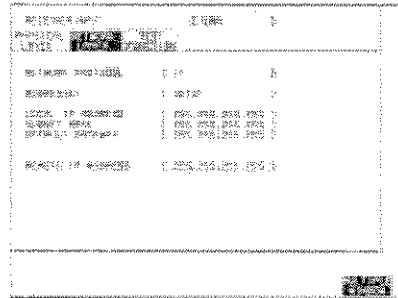

Local End Set up

Set up the **TRANSMIT** physical layer.

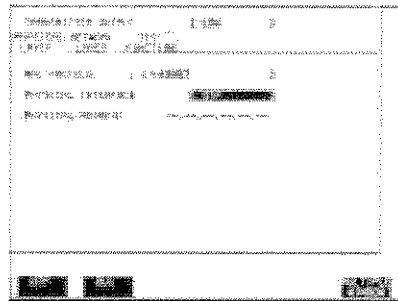

LAN Testing Examples Continuity Testing and Discontinuity Location

Set up the **TRANSMIT** network layer.

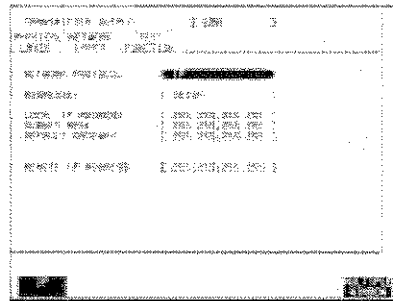

Set the **TRANSMIT** TEST FUNCTION to **CONNECTIVITY** and the **PACKETS PER SECOND** to a low rate, for example **0.3**.

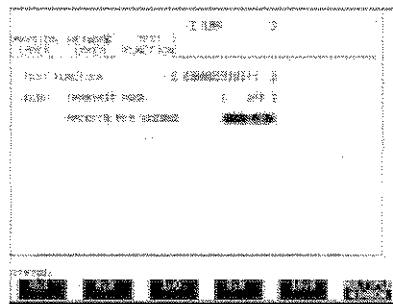

Set the **RECEIVE** RECEIVER INPUT to LAN.

As the TRANSMITTER OUTPUT is set to LAN, the RECEIVER INPUT PHYSICAL LAYER and NETWORK LAYER are set automatically.

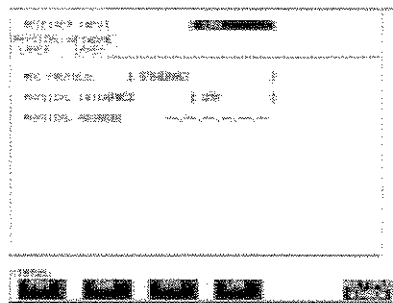

LAN Testing Examples Continuity Testing and Discontinuity Location

Run the Test

Press **RUN/STOP**

Select **TRANSMIT** TEST FUNCTION.

Set TEST FUNCTION to

CONNECTIVITY

Set ECHO TRANSMIT MODE to **ON**

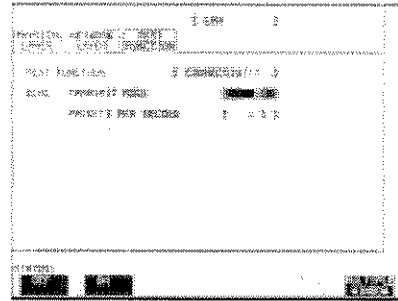

Select the **RESULTS** CONNECTIVITY

Check that echoes are received.

The receipt of echoes indicates correct connection. As there is no error correction, failure does not necessarily indicate no connection. If the test fails in an IP network, address intermediate devices which automatically respond and repeat the test to locate the discontinuity.

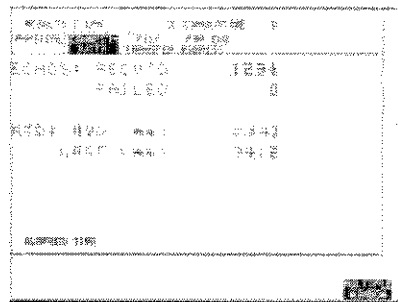

LAN Testing Examples
Packet Loss and Response Time

Packet Loss and Response Time

The packet loss of the circuit without the use of error correction gives an indication of the amount of error correction normally applied. Error correction results in lower file transfer rates and additional transfer of data. These factors make the service more costly and possibly, unacceptably slow.

In the overall data path there may be many network elements, in particular those with buffers, which introduce delay. Contending data from other sources may also be a factor in the introduction of delay. The delay resulting from these factors may result in an unacceptable response time.

The ping packets contain a sequence number which is included in the response. The actual delay of each packet is displayed when the response is received and an average of all delays in the measurement period is also displayed. The delay history is available on a bar graph.

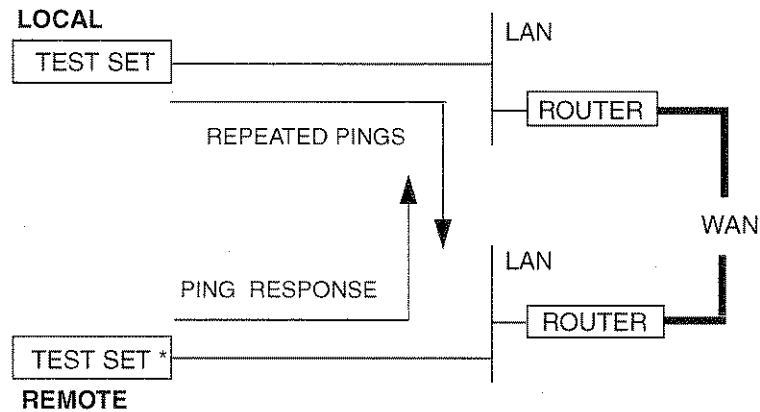

*In Internet Protocol (IP) networks, an automatically responding device may be used as an alternative to the remote test set.

LAN Testing Examples Packet Loss and Response Time

Remote End Set up

Set up the **RECEIVE** physical layer.

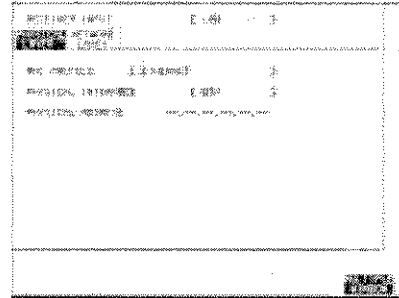

Set up the **RECEIVE** network layer.

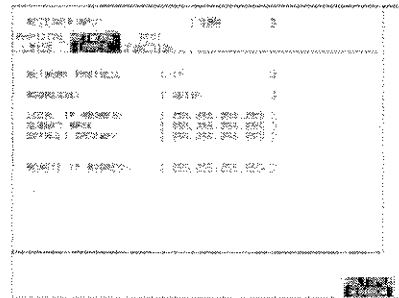

Local End Set up

Set up the **TRANSMIT** physical layer.

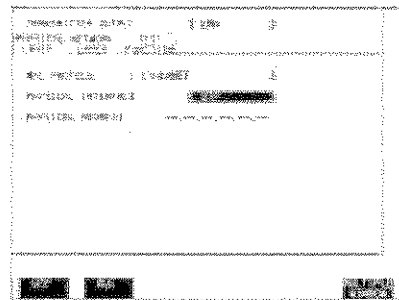

LAN Testing Examples Packet Loss and Response Time

Set up the **TRANSMIT** network layer.

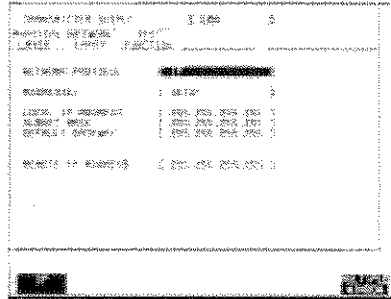

Set the **TRANSMIT** TEST FUNCTION to **CONNECTIVITY**, the **PACKETS PER SECOND** to a high value, for example **3.0**.

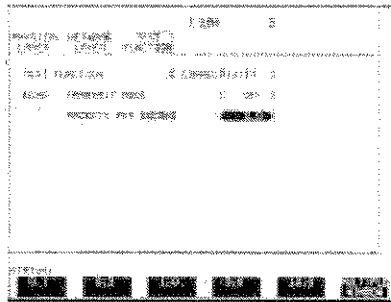

Set the **RECEIVE** RECEIVER INPUT to LAN.

As the TRANSMITTER OUTPUT is set to LAN, the RECEIVER INPUT PHYSICAL LAYER and NETWORK LAYER are set automatically.

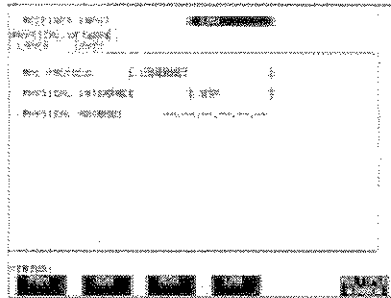

LAN Testing Examples Packet Loss and Response Time

Run the Test

Press **RUN/STOP** to start the test

Select **TRANSMIT** TEST FUNCTION.

Set TEST FUNCTION to

CONNECTIVITY

Set ECHO TRANSMIT MODE to **ON**

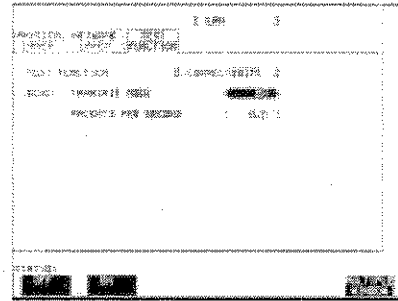

Select the **RESULTS** CONNECTIVITY.

The number of echoes failed gives an indication of the network performance.

The delay results give an indication of delays with the existing loading. The Round Trip delay history display will show the variations which may be expected with the existing loading.

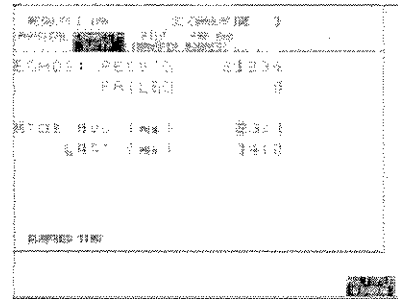

LAN Testing Examples
Packet Loss and Response Time Under Load

Packet Loss and Response Time Under Load

The previous test "Packet Loss and Response Time" is an indication of performance under existing loading. The effect of additional loading on network elements, for example routers" may be examined by adding a background load and observing the effect of load variation on echo failures. As the load does not specify a process known to the remote device, it will be ignored by this device.

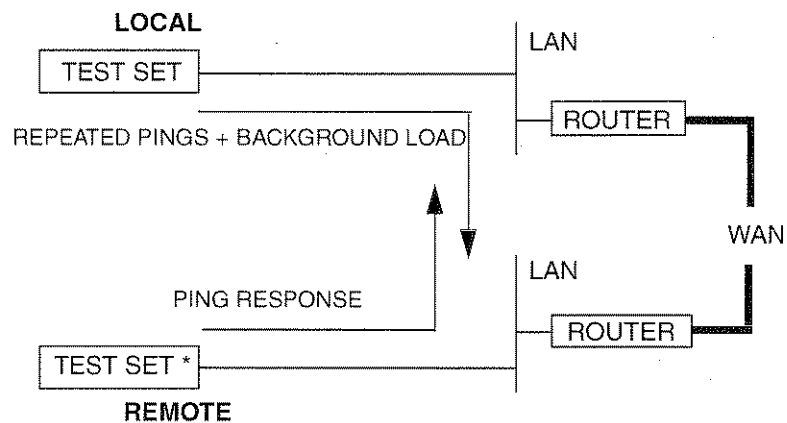

*In Internet Protocol (IP) networks, an automatically responding device may be used as an alternative to the remote test set.

LAN Testing Examples Packet Loss and Response Time Under Load

Remote End Set up

Set up the **RECEIVE** physical layer.

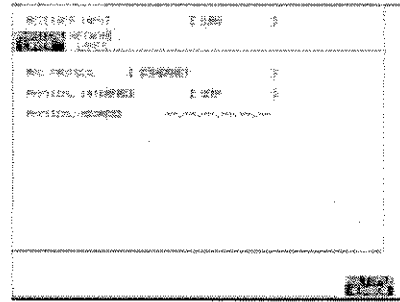

Set up the **RECEIVE** network layer.

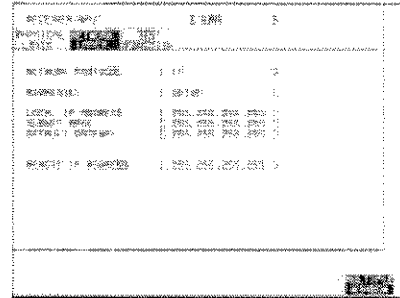

Local End Set up

Set up the **TRANSMIT** physical layer.

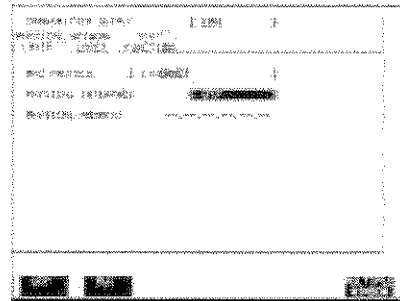

LAN Testing Examples Packet Loss and Response Time Under Load

Set up the **TRANSMIT** network layer.

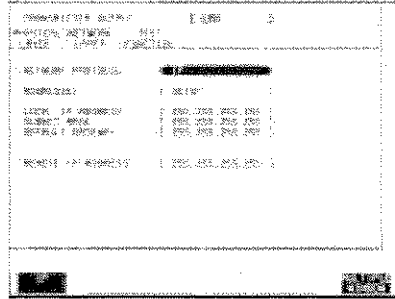

Set the **TRANSMIT** TEST FUNCTION to **CONNECTIVITY**.

Set the **PACKETS PER SECOND** to a high value, for example **3.0**.

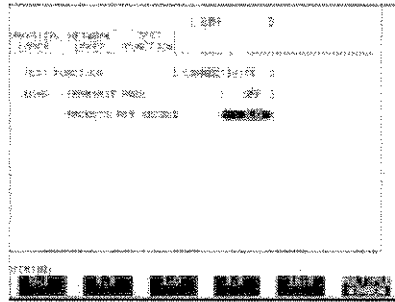

Set the **TRANSMIT** TEST FUNCTION to **BACKGROUND LOAD**.

Set the background packet mix and packet rate.

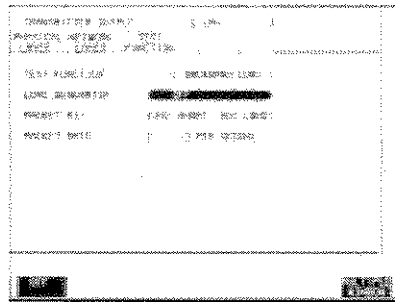

LAN Testing Examples Packet Loss and Response Time Under Load

Set the **RECEIVE** RECEIVER INPUT to LAN.

As the TRANSMITTER OUTPUT is set to LAN, the RECEIVER INPUT PHYSICAL LAYER and NETWORK LAYER are set automatically.

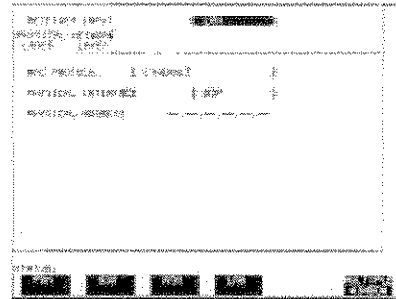

Run the Test

Press **RUN/STOP** to start the test

Select **TRANSMIT** TEST FUNCTION

Set TEST FUNCTION to

CONNECTIVITY

Set ECHO TRANSMIT MODE to **ON**.

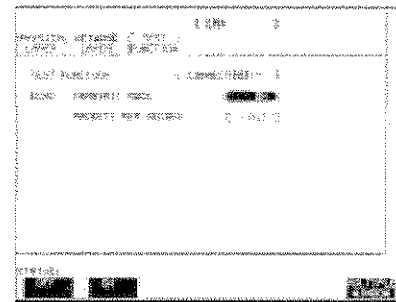

Select **TRANSMIT** TEST FUNCTION

Set TEST FUNCTION to

BACKGROUND LOAD

Set LOAD GENERATOR to **ON**.

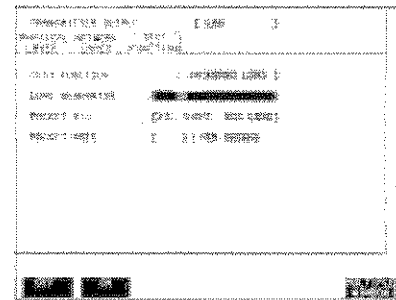

LAN Testing Examples Packet Loss and Response Time Under Load

Select the **RESULTS**
CONNECTIVITY display.

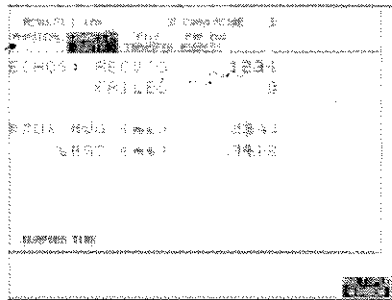

Monitor the local instrument results connectivity display to ensure that packets are not being lost.

To determine the saturation point of the network, increase the packet rate of the background load until packets are being lost.

The network may respond differently to different types of load. It may be advisable to investigate the response of the network to different packet mixes, varying the loading for each type of packet mix.

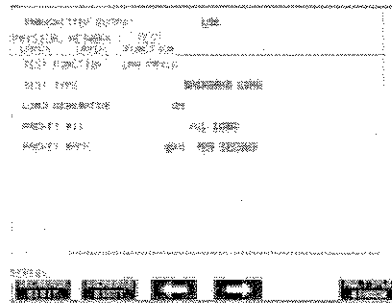

LAN Testing Examples
Error Correction Level Indication

Error Correction Level Indication

This test simulates normal operation of the network nodes by transferring a large file (1Mb/s), in many IP packets, through the network. The transport layer above these packets uses Transmission Control Protocol (TCP) which provides automatic error correction.

When the file transfer is complete, the TCP protocol function terminates the connection.

The Average data rate is then calculated in the local test set.

For this test, complete files are required. The File Transfer cannot be started until the **RUN/STOP** gating is set to RUN.

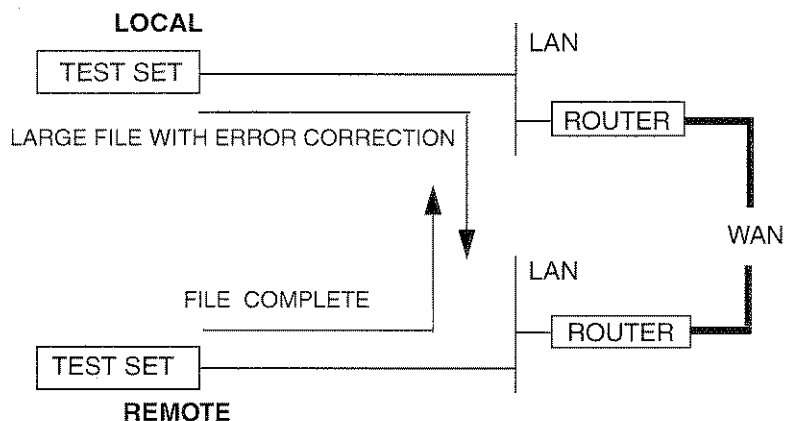



LAN Testing Examples Error Correction Level Indication

Remote End Set up

Set up the **RECEIVE** physical layer.

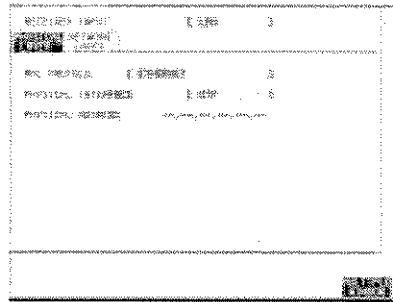

Set up the **RECEIVE** network layer.

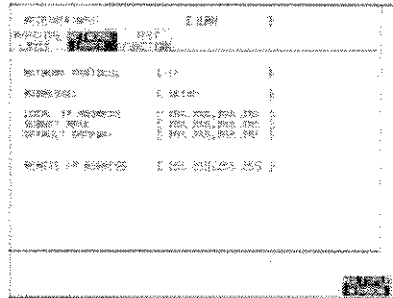

Local End Set up

Set up the **TRANSMIT** physical layer.

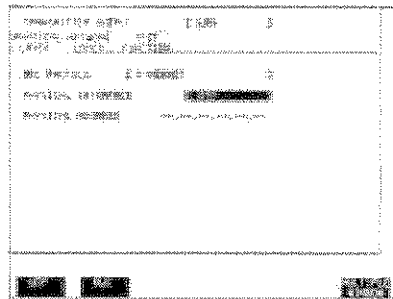

LAN Testing Examples Error Correction Level Indication

Set up the **TRANSMIT** network layer

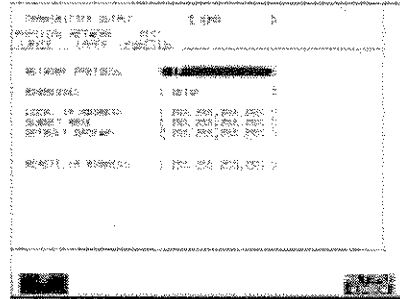

Set the **TRANSMIT** TEST FUNCTION to **FILE TRANSFER** and select the FILE SIZE.

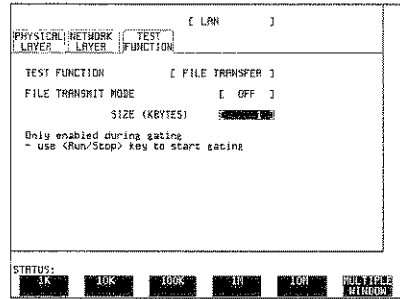

Set the **RECEIVE** RECEIVER INPUT to LAN.

As the TRANSMITTER OUTPUT is set to LAN, the RECEIVER INPUT PHYSICAL LAYER and NETWORK LAYER are set automatically.

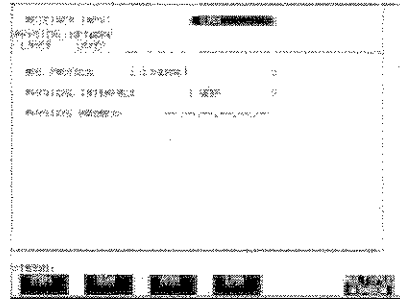

LAN Testing Examples Ethernet Collisions

Select **RESULTS** FILE TRANSFER

RESULTS [LAN]	
PHYSICAL COLLISIONS	CONNECTIVITY
PKTS REC'D	1234
SUCCESS	8
FAILED	0
RATE	20.1Kb/s
CURRENT XFR RATE	82%
ELAPSED TIME	21.4Kb/s

STATUS: CUMULATIVE WINDOW

Run the Test

Press **RUN/STOP**, select **TRANSMIT** TEST FUNCTION and set the FILE TRANSMIT MODE to ON to start the test.

RESULTS [LAN] CUMULATIVE]						
PHYSICAL LAYER	NETWORK LAYER	TEST FUNCTION	PHYSICAL LAYER	CONNECTIVITY	FILE TRANSFER	FILE TRANSFER ADDRESS
TEST FUNCTION [FILE TRANSFER]			OCTETS SENT 123456789			
FILE TRANSMIT MODE ON			KB/s 12345678			
SIZE (KBYTES) [1000]			FILES SENT 12345678			
Only enabled during gating			DROPPED 12345678			
- use <Run/Stop> key to start gating			THIS FILE % 100.000			
			KB/s 123.123			
			ELAPSED TIME			

Ethernet Collisions

The presence of collisions is not, in itself, an indication of a fault condition.

An excessively high rate of collisions could indicate problems on the local LAN. In this case it may be advisable to investigate the local LAN before troubleshooting the WAN.

Collisions are displayed on the **RESULTS** PHYSICAL display.

RESULTS [LAN] CUMULATIVE]	
PHYSICAL LAYER	CONNECTIVITY
STATUS	ON LINE
PARALLEL TX	N
PARALLEL RX	N
COLLISIONS	0
ELAPSED TIME	



Pre-stored Cell Streams



Pre-stored Cell Streams

Pre-stored Cell Streams

At the time of shipping, five cell streams are stored in the HP 37717C when one of the options 0YK, USK or USL is fitted. These stored cell streams were developed for testing features of the instrument and are included as they can be useful for training and demonstration purposes. The first test cell ("Default") is hard coded and cannot be destroyed as it is used during the instrument's self test. The remaining four cell streams are stored in non-volatile memory and may be overwritten by other externally generated cell streams. Note that, as a cell stream is fully defined (i.e. every bit of the header and payload of each cell is programmed) the header VPI/VCI values cannot be altered by the user operating the usual header manipulation facilities.

Details of the five stored cell streams shipped with the instrument are as follows:

DEFAULT

This stored cell stream contains 6 virtual channels (two for each type of AAL). If NNI is selected in the receiver, AAL-1 channels have VPI=100, AAL-3/4 channels have VPI=300, AAL-5 channels have VPI=500. The channels are six selections from the cell stream described in STREAM 1 and consequently one of each AAL is error-free and the other has all possible AAL errors. See the description below under STREAM 1.

STREAM 1 ("AAL-TEST")

This stored cell stream exercises Channel View, AAL monitoring and the cell delay variation (CDV) capability of the instrument. It is suitable as a training or demonstration aid. The information given below describes two aspects of the cell stream: first, the VPI/VCI and AAL details for each of the 27 virtual channels; second, the cell distribution for each channel. Certain virtual channels contain deliberate AAL faults, as indicated. If NNI is selected in the receiver, AAL-1 channels have VPI=100, AAL-3/4 channels have VPI=300, AAL-5 channels have VPI=500

Pre-stored Cell Streams

<i>VPI/VCI</i>	<i>AAL</i>	<i>% of traffic</i>	<i>Channel characteristics</i>	<i>Traffic Type</i>
100/100	1	4	All errors (2 corrected, 3 invalid, 16 sequence errors per 8 cells)	CBR with minor perturbations
100/110	1	10	No errors, high rate (1 in 10 user cells)	Sawtooth Interarrival Function
100/111	1	3.33	No errors, medium rate (1 in 30)	Constant Bit Rate (CBR) with minor perturbations
100/112	1	2	No errors, low rate	Pure CBR
100/120	1	1.04	Misinserted cells (7 sequence errors per 25 cells)	CBR with minor perturbations
100/121	1	0.625	Lost cells (1 sequence error per 15 cells)	CBR with minor perturbations
100/122	1	1	Out-of-sequence cells (8 sequence errors per 24 cells)	CBR with minor perturbations
100/130	1	1	Sporadic CPI errors (1 corrected error per 24)	CBR with minor perturbations
100/131	1	4	Bursty CPI errors (3 corrected, 6 invalid cell errors per 96)	CBR with minor perturbations and a gap of 3 cells
300/100	3	4	All errors (2 CRC, 21 sequence, 4 segment, 2 abort in 96 cells, 24 PDUs)	Random (Poisson)
300/110	3	12	No errors, 288 cell PDUs	Random (Poisson). Exponential Interarrival Function.
300/111	3	4	No errors, 24 cell PDUs	CBR with large gaps
300/112	3	2.79	No errors, single cell PDUs	Random (Uniform) with perturbations and gaps.
300/120	3	2.67	Aborts (1 abort per 6 PDUs)	Bursty, short bursts (6 cells).
300/130	3	2.67	Segment errors (4 errors in 16 cells)	Bursty, medium bursts (10 cells)
300/140	3	2	CRC errors (1 error in 16 cells)	Available bit rate (ABR) bursts.
300/150	3	0.33	Misinserted cells (15 sequence errors in 8 cells)	CBR with minor perturbations
300/151	3	0.33	Lost cells (1 sequence error in 8 cells)	CBR with perturbations
300/152	3	0.33	Out-of-sequence cells (1 sequence error in 8 cells)	CBR with perturbations
300/160	3	0.667	Multiple MIDs	'CBR' with major perturbations

Pre-stored Cell Streams

VPI/VCI	AAL	% of traffic	Channel characteristics	Traffic Type
500/100	5	0.667	All errors except overrun (1 CRC, 1 LE, 1 abort in 5 PDUs, 16 cells)	Small burst (16 cells)
500/110	5	12	No errors, 288 cell PDUs	Highly bursty
500/111	5	1	No errors, 8 cell PDUs	Small Burst (24 cells)
500/112	5	26.54	No errors, single cell PDUs	ABR (fills cell opportunities)
500/120	5	0.33	Aborted PDUs (1 abort in 4 PDUs, 8 cells)	Small burst (8 cells)
500/130	5	0.33	Length errors (1 LE in 5 PDUs, 8 cells)	Small burst (8 cells)
500/140	5	0.33	CRC errors (1 CRC error in 4 PDUs, 8 cells)	Small burst (8 cells)

STREAM 2 (“OAM-TEST”)

This stored cell stream contains several channels and is intended to demonstrate the OAM and reserved channel (VCI= 1 to 31) monitoring features of Channel View. VP OAM cells have reserved VCIs (3 & 4) but any alarm indicated by them is shown against all virtual channels in the virtual path. Note that continuity checks are not alarms, so they are shown in the payload column. Also, NO CELLS indicates no user cells; OAM cells may be still be present and would give rise to indications of bandwidth usage. Examples of the following are given:

VPI= 0, VCI= 0 - 15 (which contain some of the following)

Payloads

- VCI=1 META-SIG (meta-signalling)
- VCI=2 GEN-B’CAST (general broadcast signalling)
- VCI=3 PP-SIG (point-to-point signalling)
- VCI=4 EE-F4-OAM (end-to-end VP OAM)
- VCI=5 SEG-F4-OAM (segment VP OAM)
- VCI=6 RM (VP resource management)
- VP-CC (continuity check, in F4-OAM)
- VCV-CC (continuity check, in F5-OAM)

Pre-stored Cell Streams

Alarms

EE-F4, Seg-F4 (VP) FERF	(shown as VP-FERF against all VCs affected)
EE-F4, Seg-F4 (VP) AIS	(shown as VP-AIS against all VCs affected)
EE-F5, Seg-F5 (VC) FERF	(shown as VC-FERF against all VCs affected)
EE-F5, Seg-F5 (VC) AIS	(shown as VC-AIS against all VCs affected)

STREAM 3 ("VCI_1023")

This cell stream comprises 1023 virtual channels, one less than the maximum capacity of Channel View; by adding two or more background channels of other VPI/VCI values, the status line of the instrument will report a Channel View overflow condition. It is for testing this feature that this cell stream was designed.

STREAM 4 ("REGRESSN")

This cell stream stresses the AAL monitoring capability of the instrument. It was designed for regression testing the instrument.

Pre-stored Cell Streams

Glossary

- 10base-5** Ethernet cabling system also known as ThickLAN. "10" refers to 10Mb/s data rate, "5" refers to 500 metres max cable length.
- 10base-2** Ethernet cabling system also known as ThinLAN. "10" refers to 10Mb/s data rate, "2" refers to 200 metres max cable length.
- AAL** ATM adaptation layer
- ABR** Available bit rate (traffic type)
- ANSI** American national standards institute
- ATM** Asynchronous transfer mode
- AUI** Attachment Unit Interface. A "D" shell connection providing a spur from an end device to the LAN.
- BEDC-BIP16** Block error detection code- Bit interleaved parity
- BG** Display abbreviation for background
- B-ISDN** Broadband integrated services digital network
- B-ISUP** Broadband integrated services user part
- BOM** Beginning of Message
- CBDS** Connectionless broadband data services
- CBR** Constant bit rate (traffic type)
- CTD** Cell transfer delay
- CLOSS** Cell loss
- CLP** Cell loss priority
- COM** Continuation of Message
- CORR HEC** Corrected header error count
- CPCS** Common part convergence sublayer
- CSNP** Corrected sequence number protection
- DQDB** Distributed queue dual bus
- EDC** Error detection code
- EMBIP** Error monitoring byte of the G.832 overhead (34 and 140 Mb/s)?
- EOM** End of Message
- ETSI** European telecommunications standards institute (ex CCITT)
- FERF** .An alarm indicating "far end receive failure" also RDI
- FG** Display abbreviation for foreground
- GFC** Generic flow control
- HDTV** High definition television
- HEC** Header error control

Glossary

- IAM** ISUP initial address message
- IP** Internet Protocol
- ISDN** Integrated services digital network
- ITU-T** International telecommunications union, telecom standards sector (ex CCITT)
- LAN** Local area network
- LAP-D** Link access protocol for D channel
- LOC** Loss of continuity
- MAC** Medium Access Control, the method by which a station gains access to the LAN's common transmission medium.
- MAN** Metropolitan area network
- MAU** Medium Attachment Unit.. Provides a T connection from the LAN.
- MCSN** Error monitoring cell sequence number in performance management OAM cell
- MCTD** Mean cell transfer delay
- MISIN CELLS** Misinserted cells
- MSVC** Metasignalling virtual channel
- MTP** Message transfer part
- NCORR HEC** Non corrected header error check
- NCONF CELLS** Non-conforming cells
- NCSNP** Non-corrected sequence number protection
- NIC** Network Interface Controller
- N-ISDN** Narrowband integrated services digital network
- NNI** Network node interface
- NT** Network termination
- OAM** Operation and Maintenance
- PCLP** Physical Layer Convergence Protocol
- PDH** Plesiochronous digital hierarchy
- PDU** Protocol data unit
- PTI** Payload type indicator
- PTT** Post, telephone and telegraph (A public telecom operator)
- PVC** Permanent virtual connection
- RAI** Remote alarm indication
- RDI** An alarm "remote defect indication" previously FERF (far end receive failure)

Glossary

- SAAL** Signaling ATM adaptation layer
- SAR** Segmentation and reassembly
- SDH** Synchronous digital hierarchy
- SIP** SMDS interface protocol
- SMDS** Switched multimegabit data service
- SONET** Synchronous Optical Network, the U.S. (ANSI) equivalent of SDH
- SOH** Section OverHead, the ETSI equivalent of ANSI term TOH (Transport OverHead)
- SRTS** Synchronous residual time stamp
- SSM** Single segment message
- ST** Segment type error (AAL3)
- SVC** Switched virtual connection
- SVCI** Signaling virtual channel identifier
- TA** Terminal adaptor
- TAXI** FDDI physical layer protocol
- TCP** Transmission Control Protocol
- TE** Terminal equipment
- ThickLAN** See 10base-5
- ThinLAN** See 10base-2
- TOH** Transport OverHead, the ANSI equivalent of ETSI term SOH (Section OverHead)
- UNI** User network interface
- UTP** Unshielded Twisted Pair
- VBR** Variable bit rate (traffic type)
- VC** Virtual channel
- VCC** Virtual channel connection
- VCI** Virtual connection identifiers
- VP** Virtual path
- VPC** Virtual path connection
- VPI** Virtual path identifier
- WAN** Wide area network



Glossary



9

9

9

Index

-
- Numerics**
 1-point CDV, 4
 1-point CDV measurement and cell transfer delay, 78
 Using, 20
 2-point CDV, 3
 2-point CDV measurement and cell transfer delay, 78
- A**
 AAL Loss Alarm, 10
 AAL Monitoring
 Selection, 63
 AAL monitoring in-service, 63
 AAL Sublayer Measurements, 9
 AAL type
 automatic detection, 12
 AAL-1 error monitoring, 12
 AAL-3/4 error monitoring, 13
 AAL-5 error monitoring, 14
 Adding burst to distribution, 40
 Alarm
 and error generation ATM, 36, 41
 Generation, 80
 Monitoring, 80
 Testing, 79
 Alarm Conditions
 Operation under, 26
 Alarms, 24
 ATM Layer Receive Selections
 Option UKN, 58
 Option UKZ, 59
- B**
 Background Channels, 21
 Background load selection LAN, 44
 Background Load Test Function Selections, 92
 Bit errors
 Adding, 37, 41
 Broadband Auxiliary Testing
 Option 0YK Module Information, 30
 Burst
 Add to foreground, 40
 Burst distribution, 21
 Burst error add, 36, 41
- C**
 Cable, Connection, 32
 CDV and transfer delay measurement, 77
 Cell
 Congestion testing, 73
 Content selection, 33, 38
 Delay variation, 77
 Routing test, 72
 Sync testing, 75
 Transfer delay measurement, 77
 Cell Delay Variation (CDV), 3, 17
 Cell error measurement
 In-service, 57
 Cell Errors, 3
 Cell Level ATM Testing
 Option UKN Module Information, 28
 Option UKZ Module Information, 29
 Option USE Module Information, 28
 Cell Loss, 3
 Cell loss measurement
 Use of OAM flow, 55
 Cell Misinsertion, 3
 Cell performance test, 66
 Cell streams pre-stored
 Details, 100
 Selection, 39
 Cell Transfer Delay, 3
 Channel View, 5
 Channel View display, 48
 Congestion testing, 73
 Connection, RJ-45, 32
 Connectivity Test Function
 Selections, 84
 Connectivity test function LAN, 43
 Constant bit rate services
 Assessment of, 79
 Constant distribution, 21
 Continuity Testing, 82
 Cross cell PRBS, 35, 39
- D**
 Delay
 Time stamp for, 35, 36, 40
 Delay measurement, 79
 Discontinuity Location, 82
 Distribution selection, 33, 38
 Distribution Types, 23
 Dropped File Indication, 46
- E**
 End to End performance
 Use of OAM flow, 55
 Error
 and alarm generation, ATM, 36, 41
 Error add, 36, 41
 Error Correction Level Indication, 95
 Error correction testing, 75
 Ethernet Collisions, 98
- F**
 Fault isolation
 Use of OAM flow, 55
 File Transfer Size Selection, 97
 File Transfer Test Function, 97
 File transfer testing selection LAN, 43
 Foreground Channel, 21
- H**
 Header error correction testing, 75
 Header Errors, 3
 Header selection, 33, 38
 HEC error testing, 75
- I**
 In-service AAL monitoring, 63
 In-Service Testing
 Introduction, 54
 Isolating network / customer problems, 63
- L**
 LAN Testing
 Option USL Information, 32
 LAN Testing Introduction, 7
 Link traffic overview, 48
 Live Traffic Selection
 Option UKN, 58
 Option UKZ, 59
 Lost Echo Indication, 46
- M**
 Measurement Mode Selection
 Option UKN, 58
 Option UKZ, 59
 Measurements, 2
 Mis-insertion and loss
 Sequence number for, 35, 40
 Missinsertion measurement
-

Index

-
- Use of OAM flow, 55
- N**
- Network Layer Selections Transmit LAN, 42
 - Non-Conforming Cell Count, 17
- O**
- OAM alarm generation, 36, 41
 - OAM Cell Generation, 23
 - OAM fault management, 80
 - OAM flows
 - Use in in-service testing, 54
 - Option UKN Module Information, 28
 - Option UKZ Module Information, 29
 - Option USL Module Information, 31, 32
 - Overview of link traffic, 48
- P**
- Packet Loss Under Load, 90
 - Packet Loss Without Error Correction, 86
 - Packet Mix Selection, 92
 - PACKET RATE, 44
 - Packet Rate Selection, 92
 - Packets per Second selection, 84
 - Payload selection, 33, 38
 - Physical Layer Selections Transmit LAN, 42
 - Policing of service, 61
 - Pre-stored Cell Streams
 - Details, 100
 - Selection, 39
 - Problem path identification, 48
- Q**
- Quality of service measurement
 - Use of OAM flow, 55
- R**
- Random distribution, 21
 - Rate History
 - Selection, 61
 - Rate history resolution, 62
 - Receive Selections, 44
 - Resolution
 - Rate history, 62
 - Results Selections
 - LAN, 45
- Round trip delay graph, 45
- S**
- Service
 - Individual, performance check, 63
 - Service malfunction source tracing, 63
 - Services Layer ATM Testing
 - Option USK Module Information, 31
 - Option USL Module Information, 31
 - Signal Loss Indication, 46
 - Single cell PRBS, 35, 39
 - Storage of results
 - Selection, 61
 - Stored cell streams
 - Details, 100
 - Selection, 39
 - Stream content selection, 33, 38
- T**
- Test cell, 35, 40
 - Test Function Selections
 - ATM cell level, 36
 - ATM Services, 41
 - LAN, 43
 - Timing distribution selection, 33, 38
 - Traffic Simulation, 21
 - Traffic simulation
 - selection, 38
 - Trail Trace, 36, 40
 - Transfer delay and CDV measurement, 77
 - Transmit Network Layer Selections
 - LAN, 42
 - Transmit Physical Layer Selection
 - LAN, 42
- V**
- VC**
- Mapping ability test, 72
 - Rate history display, 61
- VP and VP mapping ability testing, 72**
- VP**
- Mapping ability test, 72
 - Rate history display, 61
- VP and VC mapping ability testing, 72**
- VP/VC Rate History, 5, 16**

Hewlett-Packard Sales and Service Offices

United States:

Hewlett-Packard Company
2101 Gaither Road
Rockville
MD 20850
(301) 258-2000

Hewlett-Packard Company
5201 Tollview Drive
Rolling Meadows
IL 60008
(708) 255-9800

Hewlett-Packard Company
1421 S. Manhattan Avenue
Fullerton
CA 92631
(714) 999-6700

Hewlett-Packard Company
2000 South Park Place
Atlanta
GA 30339
(404) 955-1500

Canada:

Hewlett-Packard Canada Ltd.
5150 Spectrum Way
Mississauga
Ontario
L4W 5G1
(416) 206-4725

Europe:

Hewlett-Packard
European Marketing Centre
PO Box 999
1180 AZ Amstelveen
The Netherlands

Japan:

Yokogawa-Hewlett-Packard Ltd.
Measurement Assistance Center
9-1, Takakura-Cho
Hachioji-Shi
Tokyo 192
Japan
(81) 426 48 0722

Latin America:

Hewlett-Packard
Latin America Region Headquarters
5200 Blue Lagoon Drive
9th Floor
Miami
Florida 33126
USA
(305) 267 4245/4220

Australia/New Zealand:

Hewlett-Packard Australia Ltd.
31-41 Joseph Street
Blackburn
Victoria 3130
Australia
Melbourne Caller 272 2555
(008) 13 1347

Far East:

Hewlett-Packard Pacific Ltd.
22-30/F Peregrine Tower
Lippo Centre
89 Queensway
Central
Hong Kong
(852) 848 7070

Learning Products Map

All of the learning products which apply to the HP 37717C Communications Performance Analyzer with ATM Services and LAN testing capability are shown below:

The HP 37717C Mainframe Operating Manual - 37717-90282

General operating information irrespective of option.

The HP 37717C PDH / DS_n Operating Manual - 37717-90283

Information about the PDH / DS_n modules, how to select the features available and measurement examples.

The HP 37717C SDH / SONET Operating Manual - 37717-90284

Information about the SDH / SONET modules, how to select the features available and measurement examples. This book also contains a table of ANSI / ETSI equivalent terms.

The HP 37717C Jitter Operating Manual - 37717-90285

Information about the Jitter modules, how to select the features available and measurement examples.

The HP 37717C ATM + LAN Operating Manual - 37717-90286

Information about the ATM and LAN modules, how to select the features available and measurement examples. This book also contains tutorial information on some ATM and LAN measurements, information on pre-stored sequences and a glossary of ATM and LAN terms.

Calibration Manual - 37717-90287:

Provides specifications and methods of testing that the instrument meets its specifications.

Remote Control Manual - 37717-90288:

Provides remote control information for instruments fitted with the RS232 and HP-IB remote control option modules.



About This Edition

This is the 1st edition of the 37717-90286 manual. It documents the product as of September 1997. Edition dates are as follows:

1st Edition, September 1997

© Copyright Hewlett-Packard Ltd. 1997. All rights reserved. Reproduction, adaption, or translation without prior written permission is prohibited, except as allowed under the copyright laws.



In This Book

This book provides measurement definitions and explanations which are associated with the 37717C ATM Cell layer, ATM Services layer, LAN testing and Broadband Auxiliary modules. It also provides applications associated with these modules. The individual applications contain techniques which may be of value for purposes other than those shown.



