

User's Guide  
PDH/SDH  
Operation

**HP 37717C  
Communications  
Performance Analyzer**

---

© Copyright Hewlett-Packard Ltd. 1998

All rights reserved. Reproduction, adaptation, or translation without prior written permission is prohibited, except as allowed under the copyright laws.

HP Part No.  
37717-90402

First edition, 03/98

Printed in U.K.

## Warranty

The information contained in this document is subject to change without notice.

*Hewlett-Packard makes no warranty of any kind with regard to this material, including, but not limited to, the implied warranties or merchantability and fitness for a particular purpose.*

Hewlett-Packard shall not be liable for errors contained herein or for incidental or consequential damages in connection with the furnishing, performance, or use of this material.

## WARNING

Warning Symbols  
Used on the Product



The product is marked with this symbol when the user should refer to the instruction manual in order to protect the apparatus against damage.

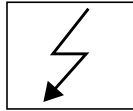

The product is marked with this symbol to indicate that hazardous voltages are present



EN 60825 1991

The product is marked with this symbol to indicate that a laser is fitted. The user should refer to the laser safety information in the Calibration Manual.

---

# HP 37717C Communications Performance Analyzer

---

# About This Book

This book tells you how to select the features that you want to use for your test.

The selections available are presented in the following groups:

- Transmit and receive interfaces
- Test features, for example, the addition of errors and alarms to the test signal
- Measurements including test timing
- Storing, logging and printing results with general printer information
- Using instrument and disk storage
- Using the “Other” features.

**The selections available will depend on the options fitted to your instrument. The examples given in this book cover all options and therefore may include selections which are not available on your instrument.**

---

**NOTE**

If your instrument includes option 120 an additional User’s Guide for Sonet operation is provided (part number 37717-90403). The contents are similar to this manual but with Sonet terminology used in place of SDH terminology.

---

## 1 Setting the Interfaces

- Setting PDH Transmit Interface 2
- Setting PDH Transmit Binary Interface 4
- Setting SDH Transmit Interface 6
- Setting Jitter Transmit Interface 9
- Setting Wander Transmit Interface 11
- Selecting the Physical Transmit Interface for ATM Payloads 13
- Setting SDH THRU Mode 15
- Using Autoseup 17
- Setting PDH Receive Interface 19
- Setting PDH Receive Binary Interface 21
- Setting SDH Receive Interface 22
- Setting Jitter Receive Interface 24
- Selecting the Physical Receive Interface for ATM payloads 26

## 2 Selecting Test Features

- Using Transmit Overhead Setup 28
- Using Receive Overhead Monitor 30
- Setting Overhead Trace Messages 32
- Generating Overhead Sequences 33
- Using Receive Overhead Capture 35
- Adding Frequency Offset to SDH Signal 37
- Adding Frequency Offset to the PDH Signal 39
- Setting up Signaling Bits 40
- Setting Transmit Structured Payload/Test Signal (Options UKJ or 110) 43
- Setting Receive Structured Payload/Test Signal 45
- Connecting A Telephone Handset 47

Setting Transmit N x 64 kb/s  
(N x 56 kb/s) Structured Payload/Test Signal 48  
Setting Receive N x 64 kb/s (N x 56 kb/s) Structured Payload/Test  
Signal 50  
Inserting an External PDH Payload/Test Signal 52  
Dropping an External Payload/Test Signal 55  
Selecting ATM Cell Stream Payload 57  
Selecting ATM Cell Stream Timing Distribution 58  
Selecting ATM Cell Stream Headers and Interface 59  
Adding Errors & Alarms at the SDH Interface 60  
Adding Errors & Alarms to the PDH Interface/PDH Payload 61  
Using FEAC Codes in the HP 37717C 63  
Adding ATM Errors and Alarms 66  
Setting PDH Spare Bits 67  
Adding Pointer Adjustments 68  
G.783 Pointer Sequences Explained 70  
Using Pointer Graph Test Function 76  
Stressing Optical Clock Recovery Circuits 78  
Generating Automatic Protection Switch Messages 79  
Inserting & Dropping Data Communications Channel 80

### **3 Making Measurements**

Using Overhead BER Test Function 82  
Test Timing 83  
Making SDH Analysis Measurements 84  
Making PDH Analysis Measurements 85  
Measuring Jitter 87  
Measuring Wander 89  
Measuring Frequency 91

Measuring Optical Power 92  
Measuring Round Trip Delay 93  
Monitoring Signaling Bits 95  
Measuring Service Disruption Time 97  
Performing an SDH Tributary Scan 99  
Performing an SDH Alarm Scan 101  
Performing a PDH/DSn Alarm Scan 102  
Measuring Jitter Tolerance 103  
Measuring Jitter Transfer 106  
Selecting the ATM Measurement Parameters 111  
Making ATM Measurements 113  
Measuring Cell Transfer Delay and Cell Delay Variation 114  
Measuring ATM Non-Conforming cells and one-point Cell Delay  
Variation. 116  
Monitoring ATM Alarms 117

## **4 Storing, Logging and Printing**

Saving Graphics Results to Instrument Store 120  
Recalling Stored Graph Results 121  
Viewing the Bar Graph Display 123  
Viewing the Graphics Error and Alarm Summaries 125  
Logging Graph Displays 127  
Logging Results 128  
Logging Results to Parallel (Centronics) Printer 131  
Logging Results to HP-IB Printer 132  
Logging Results to Internal Printer 133  
Logging Results to RS-232-C Printer 134  
Printing Results from Disk 135  
Connecting an HP DeskJet Printer to a Parallel Port 136

Logging Jitter Tolerance Results 137  
Logging Jitter Transfer Results 139  
Changing Internal Printer Paper 141  
Cleaning Internal Printer Print Head 144

## **5 Using Instrument and Disk Storage**

Storing Configurations in Instrument Store 146  
Storing Current Configurations on Disk 147  
Setting up a Title for Configurations in Instrument Store 148  
Recalling Configurations from Instrument Store 149  
Formatting a Disk 150  
Labeling a Disk 151  
Managing Files and Directories on Disk 152  
Adding Descriptors to Disk Files 156  
Saving Graphics Results to Disk 157  
Saving Data Logging to Disk 159  
Recalling Configuration from Disk 160  
Recalling Graphics Results from Disk 161  
Copying Configuration from Instrument Store to Disk 162  
Copying Configuration from Disk to Instrument Store 163  
Copying Graphics Results from Instrument Store to Disk 164  
Deleting a File on Disk 166  
Deleting a Directory on Disk 167  
Renaming a File on Disk 168  
Creating a Directory on Disk 169



## **6 Selecting and Using "Other" Features**

Coupling Transmit and Receive Settings 172

Suspending Test on Signal Loss 173

Setting Time & Date 174

Enabling Keyboard Lock 175

Enabling Beep on Received Error 176

Enabling Analysis Control 177

Setting Error Threshold Indication 178

Dumping Display to Disk 179

Setting Screen Brightness and Color 181

Running Self Test 182

## **7 AU-3/TUG-3 Background Patterns**

## **8 ETSI/ANSI Terminology**

ETSI/ANSI Conversion and Equivalent Terms 192

## **Index**



---

## **Setting the Interfaces**

This chapter tells you how to set the instrument interfaces to match the network being tested.

---

# Setting the Interfaces

---

## Setting PDH Transmit Interface

### **Description**

PDH transmit interface settings should match network equipment settings of Rate, Termination and Line Code and determine the Payload to be tested.

### **TIP:**

To set the Transmitter and Receiver to the same interface settings choose **OTHER** **SETTINGS CONTROL** **COUPLED**.

### **Option Differences**

If Option 110 is fitted the following SIGNAL rates and TERMINATION choices apply:

2 Mb/s - Termination 75  $\Omega$  UNBAL or 120 $\Omega$  BAL

34 Mb/s - fixed 75 $\Omega$  UNBAL

DS1 - 100  $\Omega$  BAL; select LINE CODE from AMI or B8ZS, and OUTPUT LEVEL from DSX-1 or DS1-LO.

DS3 - 75 $\Omega$  UNBAL; LINE CODE fixed B3ZS; select OUTPUT LEVEL from DS3-HI, DSX-3 or DS3-900'.

TRANSMITTER OUTPUT		PDH/DSn
<b>MAIN</b>	STRUCT'D	JITTER
SETTINGS	SETTINGS	TEST
SIGNAL		2 Mb/s
CLOCK SYNC	INTERNAL	
TERMINATION		75 $\Omega$ UNBAL
LINE CODE		HDB3
FREQUENCY OFFSET		OFF
PAYLOAD TYPE	UNFRAMED	UNSTRUCTURED
PATTERN		2 <sup>n</sup> 15-1 PRBS
PRBS POLARITY		ITU ITU

STATUS:

**MULTIPLE WINDOW**

## Setting PDH Transmit Interface

### **HOW TO:**

- 1** Choose the required PDH SIGNAL rate.  
If Option 110 is fitted, rates of 34Mb/s, 2Mb/s, DS1 and DS3 are available. If Option UKJ is fitted rates of 2, 8, 34 and 140 Mb/s are available.
- 2** If Option UH3, Binary Interfaces is fitted, choose the INTERFACE required. See "Setting PDH Transmit Binary Interface " page 4.
- 3** Choose the required clock synchronization source (CLOCK SYNC).  
If Option UH3, Binary Interfaces is fitted, the clock can be derived from an external binary input.  
If Option A3K, Jitter and Wander Generator, is fitted and 2 Mb/s Signal rate is chosen the clock can be derived from an external 2 Mb/s signal connected to the 2M REF IN port of the Jitter Generator module.
- 4** If you have chosen 2 Mb/s as the PDH signal rate, choose the required impedance (TERMINATION). At all other rates the impedance is fixed. See Option Differences on previous page.
- 5** If you have chosen 2 Mb/s, DS1 or 8 Mb/s as the PDH signal rate, choose the required coding (Line Code). At 34 Mb/s and 140 Mb/s coding is fixed.  
See Option Differences.
- 6** If required choose the FREQUENCY OFFSET value.  
See "Adding Frequency Offset to SDH Signal" page 37
- 7** Choose the required Payload Type.  
If Structured is chosen the PDH test signal must be set up. See "Setting Transmit Structured Payload/Test Signal (Options UKJ or 110)" page 43.  
If you have chosen 2 Mb/s as the PDH signal rate, the Framed choice is expanded to provide a menu of 2 Mb/s framing types.
- 8** Choose the PATTERN type and PRBS POLARITY.

---

## Setting PDH Transmit Binary Interface

### *Description*

Option UH3, Binary Interfaces, provides binary NRZ interface for PDH measurements. The interfaces can operate at any of the standard rates  $\pm 100$  ppm.

PDH transmit binary interface settings should match the network equipment thresholds and polarity requirements for the binary interfaces

### **Variable Rate Binary Interface**

If your instrument also includes option UKK, variable rate binary interface is available. This allows you to select fixed rates that are different from standard telecom rates, and also to vary frequency over a wide range. Applications include component test, testing satellite and cable networks and testing PDH digital radios. A Product Note is available (part number 5965-4885E) which explains the use of a variable rate binary interface in the testing of PDH digital radios.

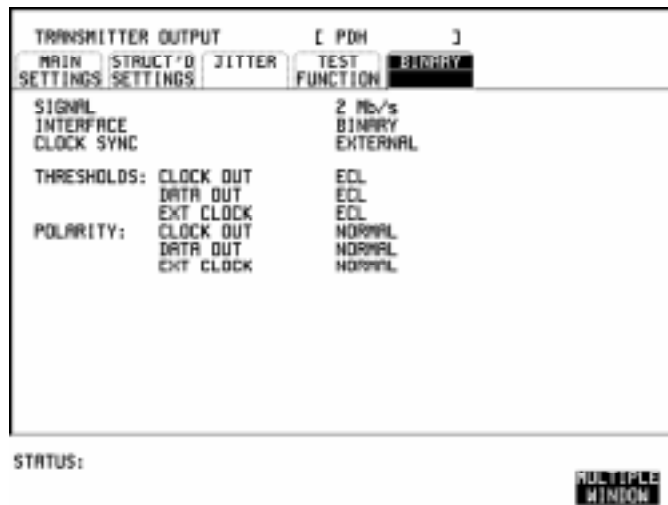

## Setting the Interfaces

### Setting PDH Transmit Binary Interface

#### ***HOW TO:***

- 1 Set up the PDH transmit Interface as required. See "Setting PDH Transmit Interface " page 2.  
If INTERFACE [BINARY] is chosen on the **PDH MAIN SETTINGS** display, threshold and polarity choices are available for Data and Clock.  
If INTERFACE [CODED] is chosen on the **PDH MAIN SETTINGS** display, threshold and polarity choices are available for Clock only.
- 2 Choose the required thresholds.  
EXT CLOCK polarity and threshold choices are only available if CLOCK SYNC [EXT BIN] is chosen on the **PDH MAIN SETTINGS** display.

---

## Setting SDH Transmit Interface

### Description

SDH transmit interface settings should match the network equipment settings of Rate, Wavelength and Mapping, determine the payload to be tested and set background conditions to prevent alarms while testing.

### TIP:

If you wish to set the HP 37717C transmitter and receiver to the same interface settings choose **OTHER** **SETTINGS CONTROL** **COUPLED**.

TRANSMITTER OUTPUT		SDH	
<b>MAIN</b>	STRUCT'D	JITTER	TEST
<b>SETTINGS</b>	PAYLOAD		FUNCTION
			OVERHEAD
			SETUP
SIGNAL	STM-1	INTERNAL	
CLOCK	INTERNAL		
FREQUENCY	OFFSET	OFF	
MAPPING	<input checked="" type="checkbox"/> AU-3	BACKGROUND	
DS1 OFFSET		TU-11	
CHANNEL		ASYN DS1	
TU PAYLOAD	D4	0 PPM	
		TU	
		1	
		1	
		STRUCTURED	
TO SET TEST SIGNAL, FIRST SELECT THE			
'STRUCT'D PAYLOAD' FOLDER ABOVE.			

STATUS:

**MULTIPLE WINDOW**

### HOW TO:

- 1 Make your choice of SIGNAL rate.  
If an optical rate is chosen, choose the required wavelength [1550] or [1310].  
If a BINARY rate is chosen, choose the required clock and data polarity.  
If STM-0 is chosen, choose the required interface level.  
Choose INTERNAL unless THRU MODE is required. If THRU MODE is chosen, see "Setting SDH THRU Mode" page 15.
- 2 Make your choice of CLOCK synchronization source. The RECEIVE clock sync choice depends on the SDH Receive Interface choice.
- 3 If required choose the CLOCK (FREQUENCY) OFFSET value. See "Adding Frequency Offset to SDH Signal" page 37.



## Setting the Interfaces

### Setting SDH Transmit Interface

- 4 Choose FOREGROUND **F/G MAPPING**, BACKGROUND **B/G MAPPING** MAPPING and type of payload. DS1 and DS3 are valid payload type choices if Option UKJ, Structured PDH or Option 110 DSn SPDH is fitted.

Mapping may be selected from a pictorial display by moving the cursor to MAPPING and pressing **SET**.

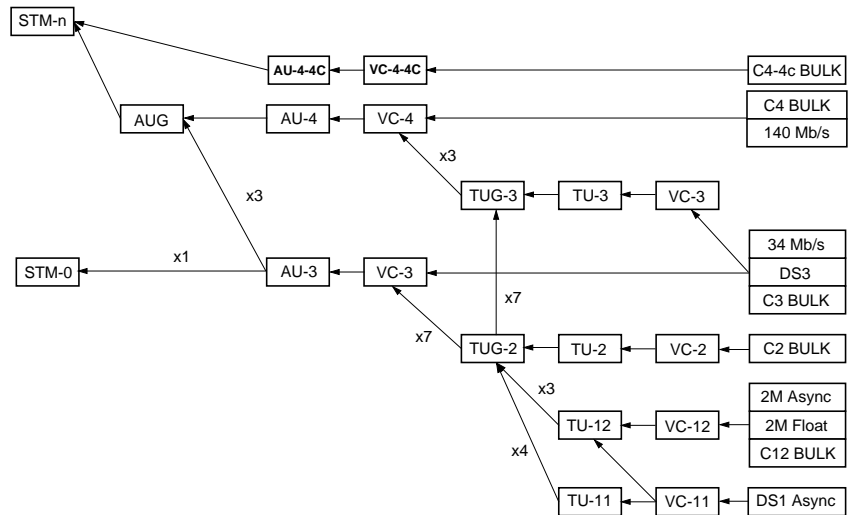

Use **→** and **←** to move between AU Layer Selection, TU Layer Selection and Payload Layer Selection. Use **↑** and **↓** to set the mapping and **SET** to set your selection.

- 5 If TU-2 mapping is chosen, TU CONCATENATION selection is enabled, choose OFF or the tributary at which the concatenation begins, TU2-2C through TU2-6C. The BACKGROUND, PATTERN IN OTHER TU2's is fixed at NUMBERED, that is, each TU-2 contains a unique number to allow identification in case of routing problems.
- 6 If TU-3, TU-2, TU-12 or TU-11 mapping is chosen, choose the test tributary CHANNEL. Including the STM-1 for an STM-4 signal.
- 7 Choose the payload framing under PAYLOAD TYPE or TU PAYLOAD. STRUCTURED and INSERT are available if Option UKJ, Structured PDH or option 110 DSn SPDH is fitted. If STRUCTURED is chosen, the Payload test signal must be set up.

## Setting the Interfaces

### Setting SDH Transmit Interface

See “Setting Transmit Structured Payload/Test Signal (Options UKJ or 110)” page 43.

If INSERT is chosen, see “Inserting an External PDH Payload/Test Signal” page 52.

- 8** Choose the PATTERN type and PRBS polarity.  
If your choice matches ITU-T Recommendation O.150, ITU is displayed alongside your choice.

---

#### NOTE

If interfacing at STM-0 with a user word pattern chosen then a false frame synchronization may occur. This is due to the effect of the standard ITU-T G.707 scrambling used at STM-0 when applied to a fixed payload. The scrambler may produce a false (F628) frame synchronization from the fixed payload. At STM-0 only a single F628 pattern is available for frame synchronization. If the false pattern is detected by the receiver this will result in frame synchronization being indicated but multiple alarms will occur. If this condition is suspected, change the PATTERN choice to PRBS and check that the multiple alarms are cleared when proper frame synchronization is achieved.

- 9** If required, choose DS1/2M/34M/DS3/140M OFFSET value. See “Adding Frequency Offset to SDH Signal” page 37.
- 10** If 2 Mb/s framing PCM30 or PCM30CRC is chosen, set the CAS ABCD bit value. See “Setting up Signaling Bits ” page 40.
- 11** Choose the mapping required in the background (non-test) TUG-3s. Refer to Appendix A for a table of background patterns for AU-3 and TUG-3.
- 12** If TU-12 mapping is chosen for the test TUG-3, choose the PATTERN IN OTHER TU-12s (from 2E9-1, 2E15-1 or 1100).

---

## Setting Jitter Transmit Interface

**Description:**

You can add jitter to the transmitted PDH or SDH signal at all ETSI rates. You can source the jitter modulation internally or from an external source.

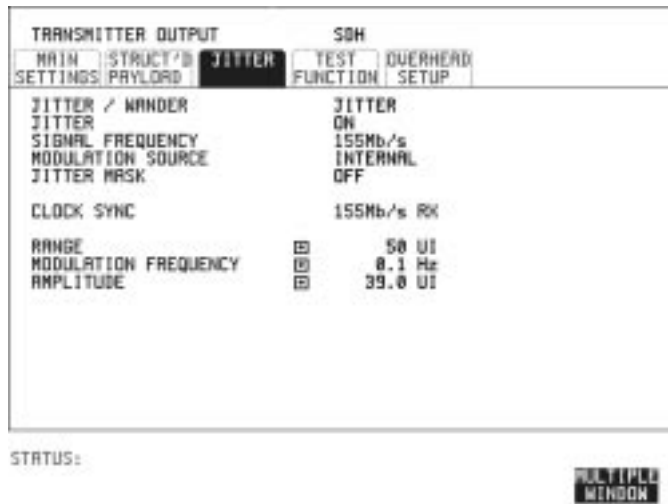

**HOW TO:**

- 1 If you are adding jitter to the PDH signal, set up the PDH transmit interface. See "Setting PDH Transmit Interface" page 2.

If you are adding jitter to the SDH signal, set up the SDH transmit interface. See "Setting SDH Transmit Interface" page 6.

- 2 Choose JITTER/WANDER [JITTER].  
If you wish to add wander to the PDH or SDH signal, see "Setting Wander Transmit Interface" page 11.
- 3 Choose JITTER [ON].  
If you wish to perform a Jitter Tolerance measurement, choose TOLERANCE. See "Measuring Jitter Tolerance" page 103.  
If you wish to perform a Jitter Transfer measurement choose TRANSFER FN. See "Measuring Jitter Transfer" page 106.

## Setting the Interfaces

### Setting Jitter Transmit Interface

- 4 Choose the modulation source.  
If EXTERNAL is chosen, connect the external source to the MOD IN port of the JITTER TX module. Up to 10 UI of external jitter modulation can be added at the MOD IN port.
- 5 Choose the JITTER MASK setting required.  
You can choose the jitter range, jitter modulating frequency and jitter amplitude if OFF is chosen.  
If you choose SWEEP, the HP 37717C will "sweep" through the ITU-T jitter mask (G.823 for PDH or G.958 for SDH) adjusting the jitter amplitude according to the jitter frequency.  
If you choose SPOT, you can choose the "spot" jitter frequency. The jitter amplitude is adjusted and controlled according to your jitter frequency choice.

***TIP:***

If when using the SWEPT MASK capability a problem occurs around a certain frequency, this may require closer examination. Stop the sweep at that point by choosing SPOT. You can then control the "spot" jitter frequency to make closer examination of the problem.

---

## Setting Wander Transmit Interface

**Description:**

You can add Wander to the 2 Mb/s PDH signal and the STM-1 and STM-4 SDH signal. An external 2 Mb/s clock must be connected to the 2M REF IN port of the Jitter TX module.

**HOW TO:**

- 1 Connect an external 2 Mb/s clock to the 2M REF port of the Jitter TX module.
- 2 If you are adding jitter to the 2 Mb/s PDH signal set up the PDH transmit interface and choose CLOCK SOURCE [EXT JITTER]. See "Setting PDH Transmit Interface " page 2.  
If you are adding jitter to the STM-1 or STM-4 SDH signal set up the SDH transmit interface and choose an external CLOCK SOURCE. See "Setting SDH Transmit Interface " page 6.
- 3 Choose JITTER/WANDER [WANDER].  
If you wish to add jitter to the PDH or SDH signal, see "Setting Jitter Transmit Interface " page 9.
- 4 Choose WANDER [ON].

## Setting the Interfaces

### Setting Wander Transmit Interface

- 5 Choose the modulation source.  
If EXTERNAL is chosen, connect the external source to the MOD IN port of the JITTER TX module.  
Up to 10 UI of external wander modulation can be added at the MOD IN port.
- 6 Choose the WANDER MASK setting required.  
You can choose the wander modulating frequency and wander amplitude if OFF is chosen.  
If you choose SPOT, you can choose the "spot" wander frequency. The wander amplitude is adjusted and controlled according to your wander frequency choice.

---

## Selecting the Physical Transmit Interface for ATM Payloads

### *Description*

ATM transmit physical layer settings should match the network equipment settings in the same way as the SDH and PDH transmit interfaces. The Interface selections available are determined by the PDH/DSn and SDH/SONET modules fitted to your instrument.

Your selections are automatically transferred to the other TRANSMIT displays. Selection of STM-4 OPTICAL signal at the ATM PHYSICAL LAYER will cause the transmitter output SDH to change to STM-4 OPTICAL.

### *TIP:*

If you wish to set the HP 37717C transmitter and receiver to the same interface settings choose **OTHER** **SETTINGS CONTROL** **COUPLED**.

TRANSMITTER OUTPUT		ATM	
PHYSICAL LAYER	ATM LAYER	JITTER	TEST FUNCTION OVERHEAD SETUP
SIGNAL	STM-4 OPT	1318	INTERNAL
CLOCK	STM-4 OPT RH	OFFSET	OFF
BACKGROUND STM-1's		FIXED	
CHANNEL	STM-1		
		1	

STATUS:

MULTIPLE WINDOW

### *HOW TO:*

- 1 Make your choice of SIGNAL rate.  
If an optical rate is chosen, choose the required wavelength.  
Choose INTERNAL unless THRU MODE is required. Jitter may be introduced into an STM-1, 140Mb/s, 32Mb/s or 2Mb/s signal with ATM payload if THRU MODE is chosen.
- 2 Make your choice of CLOCK synchronization source. At SDH rates, the RECEIVE clock sync choice is dependent upon the SDH Receive

## Setting the Interfaces

### Selecting the Physical Transmit Interface for ATM Payloads

Interface choice.

- 3 If the 2Mb/s rate is selected, select CRC-4 MULTIFRAME **ON** or **OFF**.
- 4 If the 140Mb/s or 34Mb/s rate is selected, select the TRAIL TRACE message type:

For the standard trail trace message "HP37717C" set TRAIL TRACE to **TEST**.

For a unique 15 character message, set TRAIL TRACE to **USER**

**TIP:**

If **USER** is selected, use **SET** for a pop-up menu to select the message characters.



---

## Setting SDH THRU Mode

### *Description*

THRU mode is used to non-intrusively monitor SDH lines where no protected monitor points are available.

Since THRU mode locks most user settings, you must set AU, rate, mapping and payload before selecting THRU mode.

### **STM-0, STM-1**

You can substitute a new payload, Section overhead (SOH) and Path overhead (POH) in the received STM-0/1 signal for testing.

TRANSMITTER OUTPUT		[ SDH ]		
<b>MAIN</b>	STRUCT'D	JITTER	TEST	OVERHEAD
<b>SETTINGS</b>	PAYLOAD		FUNCTION	SETUP
SIGNAL	[STM-1 OPT]	[ 1310 ]	[THRU MODE]	
CLOCK	STM-1 OPT RX			
AU-4	PAYLOAD OVERWRITE	[ OFF ]		
	SOH+POH CHANNEL OVERWRITE	[ OFF ]		
RX SIGNAL RE-TRANSMITTED UNCHANGED.				
STATUS:				
<b>MULTIPLE WINDOW</b>				

## Setting the Interfaces

### Setting SDH THRU Mode

#### STM-4

With option 130 or 131, the overhead and payload may be overwritten for AU-4 and AU3. SOH overwrite is available for AU-4-4C.

The Transmitter and receiver settings are automatically coupled in THRU MODE. To select AU-4, AU3 or AU-4-4C set the receiver mapping, see "Setting SDH Receive Interface " page 22

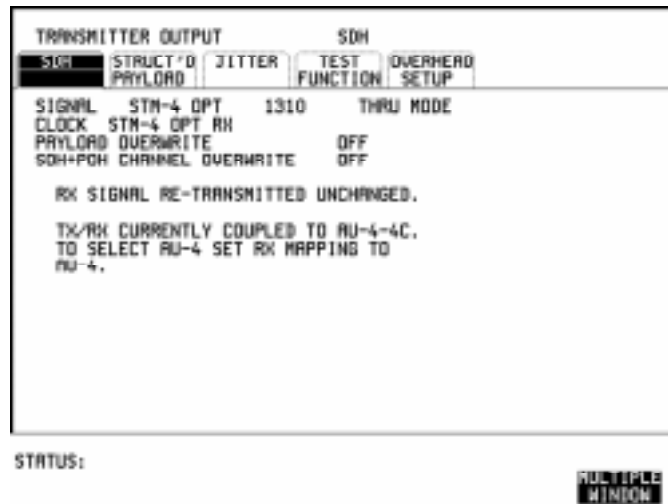

#### HOW TO:

- 1 Make the PAYLOAD OVERWRITE choice required.  
If AU-4, AU-3, TU-3, TU-2 or TU-12 is chosen, the B1, B2 and B3 BIPs are recalculated before transmission and the Mapping, Selected TU, TU Payload, Pattern, Tributary Offset and Pattern in other TU's settings are displayed. To choose the settings in these, see "Setting SDH Transmit Interface " page 6, steps 4 through 10.
- 2 Make the SOH+POH OVERWRITE choice required.  
You can only modify those overhead bytes available under **TRANSMIT** **SDH** **TEST FUNCTION** **SDH** : Errors & Alarms, Sequences, Overhead BER, MSP Messages, DCC Insert and Stress Test.  
The B1, B2 and B3 BIPs are recalculated before transmission.

---

## Using Autoseup

### *Description*

The Autoseup function allows you to speed up the configuration of the instrument when making PDH or SDH measurements.

Autoseup will **search the interface chosen** on the **RECEIVE** display and attempt to configure the instrument to match the received signal. Autoseup will detect ATM or any of the PRBS patterns the transmitter can generate. ATM is considered to be a payload of PDH or SDH.

Both MONITOR and TERMINATE modes are tried in the search for a received signal.



### *HOW TO:*

- 1 Connect the HP 37717C to the network and select the required **RECEIVE** interface on the HP 37717C.
- 2 Press **AUTO SETUP**.  
The **OTHER** display will show an Autoseup HELP page.

### **SDH Input**

If an STM-4 interface is chosen, the search will start on the STM-1 selected for test. All SDH line rates are searched for an electrical, optical or binary signal.

If a signal is found, a search of payloads will start.

## Setting the Interfaces

### Using Autoseup

The payload search starts with VC-4-4C in STM-4 and continues with ATM, TU-3 (AU-4), VC-3 (AU-3), TU-2 (AU-3/AU-4), VC-4 (AU-4), TU-12 (AU-3/AU-4), TU-11 (AU-3/AU-4).

For each payload a search is made to find a framing pattern. If a framing pattern is found, a search for PRBS patterns is made.

#### **TIP:**

If it is known that the signal of interest is in a particular STM-1 e.g. number 3, then the Autoseup search can be speeded up by setting the **RECEIVE** display MAPPING [FOREGROUND] to STM-1 [3]. The search for a signal will then start in STM-1 number 3.

### PDH Input

In PDH there are three framing possibilities for 140 Mb/s, 34 Mb/s, 8 Mb/s and 2 Mb/s, (34Mb/s, DS3, 2M and DS1 for option 110) namely Unframed, Framed and Structured.

---

#### **NOTE**

---

Structured is **not** covered by Autoseup because searching through a PDH framing structure would take an unacceptable amount of time.

All line rates are searched for a signal. If a signal is found, a search for framing pattern is made. All possible framing structures are searched, except for Structured.

If a framing pattern is found, a search for PRBS pattern is made.

---

## Setting PDH Receive Interface

### **Description**

PDH Receive interface settings should match the network equipment settings of Rate, Termination and Line Code and determine the Payload to be tested.

### **TIP:**

If you wish to set the HP 37717C transmitter and receiver to the same interface settings choose **OTHER** **SETTINGS CONTROL** **COUPLED**.

RECEIVER INPUT		PDH/DSn	
MAIN SETTINGS	STRUCT'D SETTINGS	JITTER	TEST FUNCTION
SIGNAL		2 Mb/s	
TERMINATION		75Ω UNBAL	
LINE CODE		HDB3	
LEVEL		MONITOR	
EQUALIZER	ON	GAIN	20 dB
PAYLOAD TYPE	UNFRAMED	UNSTRUCTURED	
PATTERN		2 <sup>15</sup> -1 PRBS	
PRBS POLARITY		1NU 1TU	

STATUS: MULTIPLE WINDOW

### **HOW TO:**

- 1 Choose the required SIGNAL source.
- 2 If Binary Interfaces, Option UH3, is fitted, choose the INTERFACE required. See "Setting PDH Receive Binary Interface " page 21.
- 3 If you have chosen 2 Mb/s as the PDH signal rate, choose the required impedance (TERMINATION). At all other rates the impedance is fixed.
- 4 If you have chosen 2 Mb/s, 8 Mb/s or DS1 (option 110) as the PDH signal rate, choose the required LINE CODE. At 140 Mb/s, 34 Mb/s and DS3 coding is fixed.
- 5 If you are measuring at the network equipment monitor point set the LEVEL field to MONITOR.

## Setting the Interfaces

### Setting PDH Receive Interface

- 6 The received signal will be 20 to 26 dB below the normal level. To return the received signal to normal, choose the required GAIN level. The received signal may also require EQUALIZATION to compensate for cable losses.
- 7 Choose the required Payload Type.  
If Structured is chosen, the PDH test signal must be set up. See “Setting Transmit Structured Payload/Test Signal (Options UKJ or 110)” page 43.  
If you choose 2 Mb/s as the PDH signal rate, the Framed choice is expanded to provide a menu of 2 Mb/s framing types.
- 8 Choose the required PATTERN.
- 9 Choose the required PRBS POLARITY.  
If your PRBS Polarity choice matches ITU-T Recommendation O.150, ITU is displayed alongside your choice.

---

## Setting PDH Receive Binary Interface

### *Description*

PDH Receive binary interface settings should match the network equipment threshold and polarity requirements for the binary interfaces.

RECEIVER INPUT		PDH
MAIN	STRUCT'D	BINARY
SETTINGS	SETTINGS	
SIGNAL INTERFACE		140 Mb/s BINARY
THRESHOLDS: CLOCK IN		ECL
DATA IN		ECL
POLARITY: CLOCK IN		NORMAL
DATA IN		NORMAL

STATUS:

MULTIPLE WINDOW

### *HOW TO:*

- 1 Set up the PDH receive interface required. See "Setting PDH Receive Interface " page 19.  
If INTERFACE [CODED] is chosen, binary interfaces are not available.
- 2 If INTERFACE [BINARY] is chosen, then choose the required THRESHOLDS and POLARITY for Clock and Data.

---

## Setting SDH Receive Interface

### *Description*

SDH Receive interface settings should match the network equipment settings of Rate and Mapping, and determine the payload to be tested.

### *TIP:*

If you wish to set the HP 37717C transmitter and receiver to the same interface settings, choose **OTHER** **SETTINGS CONTROL** **COUPLED**.

RECEIVER INPUT SDH

SDH STRUCT'D TEST OVERHEAD  
PAYLOAD FUNCTION MONITOR

SIGNAL STM-4 OPT

MAPPING AU-4 TU-12  
RSYNC 2Mb/s

CHANNEL STM-1 TUG3 TUG2 TU  
1 1 1 1

TU PAYLOAD UNFRAMED  
PATTERN 2<sup>15</sup>-1 PRBS INVERT ITU

STATUS:

MULTIPLE WINDOW

### *HOW TO:*

- 1 Choose the required SIGNAL source.  
If a BINARY rate is chosen, choose the required clock and data polarity.
- 2 Choose mapping and type of payload.  
Note: If option UKJ is fitted then DS1 and DS3 payloads are unstructured. Option 110 offers fully structured DS1 and DS3 payloads.
- 3 If TU-2 mapping is chosen, and CONCATENATION is enabled, choose the tributary at which the concatenation begins.  
If TU-3, TU-12 or TU11 mapping is chosen, choose the test tributary under CHANNEL.
- 4 Choose the payload framing under PAYLOAD TYPE or TU PAYLOAD.  
If STRUCTURED is chosen the Payload test signal must be set up. See "Setting Receive Structured Payload/Test Signal" page 45.



## Setting the Interfaces

### Setting SDH Receive Interface

If DROP is chosen, see “Dropping an External Payload/Test Signal” page 55.

- 5 Choose the PATTERN type and PRBS polarity.  
If your choice matches ITU-T Recommendation O.150, ITU is displayed alongside your choice.

---

#### NOTE

If interfacing at STM-0 with a user word pattern chosen, then a false frame synchronization may occur. This is due to the effect of the standard ITU-T G.707 scrambling used at STM-0 when applied to a fixed payload. The scrambler may produce a false (F628) frame synchronization from the fixed payload. At STM-0 only a single F628 pattern is available for frame synchronization.

If the false pattern is detected by the receiver this will result in frame synchronization being indicated but multiple alarms will occur. If this condition is suspected, change the PATTERN choice to PRBS and check that the multiple alarms are cleared when proper frame synchronization is achieved.

---

---

## Setting Jitter Receive Interface

**Description:**

PDH Jitter and PDH error measurements are made simultaneously when a PDH jitter measurement option is fitted. The measurements are made on the normal input to the PDH receiver and the interface selections are the normal PDH Receiver selections. The jitter receive interface is selected with **RECEIVE PDH JITTER**.

SDH Jitter and SDH error measurements are isolated individual measurements. The SDH jitter measurement is made on an SDH input to the Jitter module and there is a specific receive interface displayed with **RECEIVE SDH JITTER**.

The choices made on the jitter receive interface determine the jitter measurement range, the threshold level for determining a jitter hit and which filters are used in the jitter measurement.



**HOW TO:**

- 1 Choose the RECEIVER RANGE - the jitter measurement range.
- 2 Choose the HIT THRESHOLD level - if the received jitter exceeds the value chosen a jitter hit is recorded.
- 3 Choose the FILTER you wish to include in the peak to peak and RMS jitter measurement.

## Setting the Interfaces

### Setting Jitter Receive Interface

- 4 If Option A3L, A3V or A3N, Jitter Receiver, is fitted, an ADDITIONAL RMS FILTER choice is provided. You may possibly require different filters to be connected for peak to peak and RMS measurements. The additional RMS filter choice allows you the choice of a 12 kHz (high pass) HP filter for RMS measurement only. If 12 kHz HP is chosen under FILTER, the additional RMS filter choice is not available.

---

## Selecting the Physical Receive Interface for ATM payloads

### **Description**

ATM receive physical layer settings should match the network equipment settings in the same way as the SDH and PDH receive interfaces. The Interface selections available are determined by the PDH/DSn and SDH/SONET modules fitted to your instrument.

Your selections are automatically transferred to the other RECEIVE displays. For example selection of STM-4 OPTICAL signal at the ATM PHYSICAL LAYER will cause the receiver output SDH to change to STM-4 OPTICAL.

### **TIP:**

If you wish to set the HP 37717C transmitter and receiver to the same interface settings choose **OTHER** **SETTINGS CONTROL** **COUPLED**.

RECEIVER INPUT		ATM
<b>PHYSICAL LAYER</b>	ATM LAYER	JITTER
SIGNAL	<input checked="" type="checkbox"/>	2 Mb/s
TERMINATION		75Ω UNBAL
LINE CODE		H0B3
LEVEL		TERMINATE
CRC-4 MULTIFRAME		OFF

STATUS: **MULTIFRAME**  
**INTIMON**

### **HOW TO:**

- 1 Choose the required SIGNAL source.
- 2 For a 2Mb/s rate, select the TERMINATION and LINE CODE.
- 3 For a 2, 34 or 140Mb/s rate, select the TERMINATION.
- 4 For a 2Mb/s rate, select the CRC-4 MULTIFRAME.
- 5 For an STM-4 rate select the STM-1 UNDER TEST.

---

**Selecting Test Features**

---

# Selecting Test Features

---

## Using Transmit Overhead Setup

### *Description*

You can set an overhead byte to a known static state to aid in troubleshooting, for example, to quickly check for "stuck bits" in path overhead bytes. Section Overhead, Path Overhead and Trace Messages can be set using this feature.

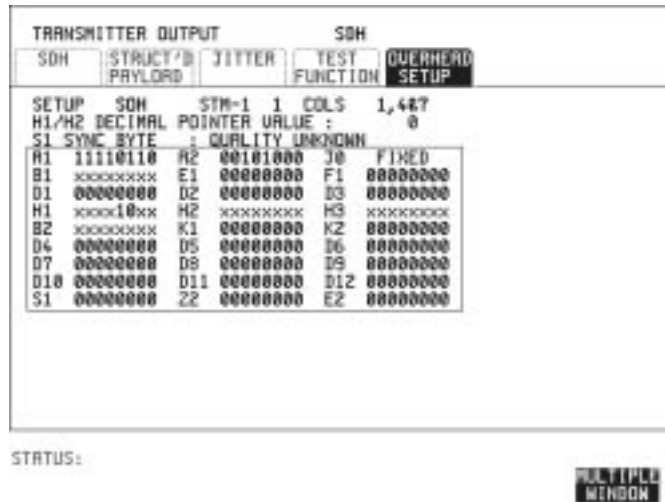

### *HOW TO:*

- 1 Set up the SDH transmit interface and payload required. See "Description" page 6.
- 2 Choose the type of overhead to SETUP.  
If STM-4 is chosen as the SDH interface, choose the STM-1 you wish to set up.  
If TRACE MESSAGES is chosen, see "Setting Overhead Trace Messages" page 32.  
DEFAULT - Use to set all overhead bytes to the standard values defined by ITU-T. If a test function is active then the overhead byte value is determined by the choices made in the Test Function. For example if APS Messages is chosen, the K1K2 value is determined by

## Selecting Test Features

### Using Transmit Overhead Setup

the APS Messages setup.

- 3 If SOH (Section Overhead) is chosen, choose the columns (COLUMN) to be displayed. Many bytes in COLS 2,5,8 and 3,6,9 are unlabeled as the other overhead functions have not yet been defined.  
If ALL COLUMNS is chosen, the hexadecimal value of all 81 bytes of the STM-1 section overhead selected are displayed (all 324 bytes of an STM-4 are displayed by selecting the 4 STM-1s). The values of the bytes can be set using **DECREASE DIGIT** **INCREASE DIGIT**  .  
If BYTE NAMES is chosen, the labels for the ALL COLUMNS overhead bytes are displayed.
- 4 If POH (Path Overhead) is chosen, choose the TYPE of overhead within STM-1 under test to be setup.  
J1 and J2 bytes can be set under Path Overhead or Trace Messages.  
H4 byte has a choice of sequences for TU-12, TU11 and TU-2 mapping:  
**Full Sequence** - 48 byte binary sequence.  
**Reduced Sequence** - Binary count sequence of 0 to 3 i.e. 111111(00 to 11).  
**COC1 Sequence** - Binary count sequence of 0 to 3 i.e. 110000(00 to 11).

---

#### NOTE

---

Any bit of an overhead byte which is displayed as x or s cannot be set at any time. All other bits can be set to 0 or 1.

#### TIP:

You can set all overhead bytes to the default state by selecting **SETUP** **DEFAULT**.

You can set all overhead bytes and test functions to the default state by recalling Stored Settings [0] on the **OTHER** display.

---

## Using Receive Overhead Monitor

### *Description*

When first connecting to a SDH network, a start up confidence check can be made by viewing the behavior of all the overhead bytes. If the SDH network shows alarm indications, some diagnosis of the problem may be gained from viewing all the overhead bytes. The OVERHEAD MONITOR display is updated once per second (once per 8000 frames) approximately.

RECEIVER INPUT		SDH	
SDH	STRUCT'D	TEST	OVERHEAD
PAYLOAD	FUNCTION	MONITOR	
MONITOR SDH STM-1 1 COLS 1,467			
S1 SYNC STATUS : QUALITY UNKNOWN			
A1	11110110	A2	00101000
B1	01010100	E1	00000000
D1	00000000	D2	00000000
H1	01101000	H2	00000000
B2	00111111	K1	00000000
D4	00000000	D5	00000000
D7	00000000	D8	00000000
D10	00000000	D11	00000000
S1	00000000	Z2	00000000
		J0	00000001
		F1	00000000
		D3	00000000
		H3	00000000
		K2	00000000
		D6	00000000
		D9	00000000
		D12	00000000
		E2	00000000

STATUS:

MULTIPLE WINDOW



### *HOW TO:*

- 1 Set up the receive SDH interface and payload as required. See “Setting SDH Receive Interface” page 22.
- 2 Choose the type of overhead to MONITOR.  
If TRACE MESSAGES is chosen, you can monitor a data message to verify portions of the network.  
If the 16 byte CRC7 message structure is detected, the 15 characters within the message are displayed.  
If the CRC7 structure is not detected in J1, the 64 byte message format is assumed and displayed. If the CRC7 structure is not detected for J0 or J2, all 16 bytes are displayed.
- 3 If SOH (Section Overhead) is chosen, choose the columns (COLUMN) to be displayed.  
Many bytes in COLS 2,5,8 and 3,6,9 are unlabeled because the other overhead functions have not yet been defined.



## Selecting Test Features

### Using Receive Overhead Monitor

If ALL COLUMNS is chosen, the hexadecimal value of all 81 bytes of section overhead is displayed and can be set using **DECREASE DIGIT** **INCREASE DIGIT**  .

If BYTE NAMES is chosen, the labels for the ALL COLUMNS overhead bytes is displayed.

- 4 If POH (Path Overhead) is chosen, choose the source of the overhead VC-4, VC-3, VC-2, VC-12 or VC-11.  
J1 and J2 bytes can be monitored under Path Overhead or Trace Messages
- 5 If APS MESSAGES is chosen, choose the TOPOLOGY, **LINEAR** (G.783) or **RING** (G.841). The K1 and K2 bits are monitored.
- 6 If LABELS is chosen, the S1 sync status and HP path label (C2) are monitored.

#### **TIP:**

If any abnormal behavior is observed on a particular path or section overhead byte, or an associated group of bytes (3XA1,3XA2; D1 - D3), the **RECEIVE** **TEST FUNCTION** display of **OVERHEAD CAPTURE** can be used to "Zoom" in on the suspect byte or bytes on a frame by frame basis. See "Using Receive Overhead Capture " page 35.

---

## Setting Overhead Trace Messages

**Description**

You can insert a data message to verify portions of the network:

J0 verifies the regenerator section overhead.

J1 verifies the VC-3 or VC-4 path connection.

J2 verifies the VC-2, VC-12 or VC-11 path connection.

TRANSMITTER OUTPUT		SDH	
SDH	STRUCT'D PAYLOAD	JITTER	TEST FUNCTION
SETUP		TRACE	
J0	FIXED	→	00000001
J1	TEST 64 (UC-4)	→	"HP37717C COMMUNI CATIONS PERFORMA NCE ANALYZER, GB00000715"
J2	TEST (UC-12)	→	"HP:- GB00000715"

STATUS:

MULTIPLE  
WINDOW

---

## Generating Overhead Sequences

### Description

You may insert a pattern into a functional group of overhead bytes for testing or troubleshooting purposes.

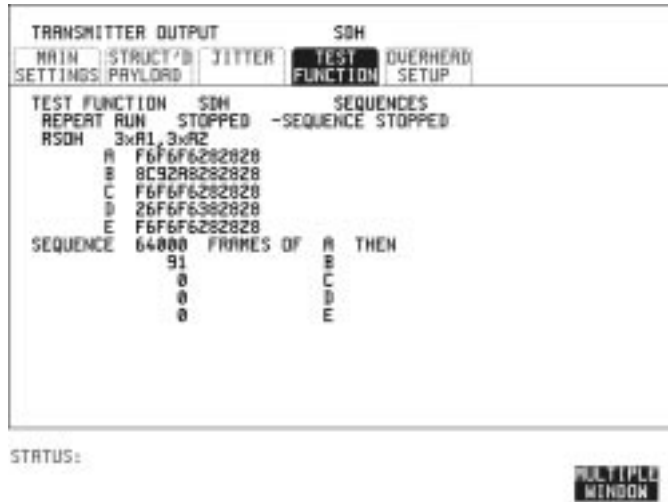

### HOW TO:

- 1 Set up the SDH transmit interface and payload required. See "Description" page 6.
- 2 Choose the type of sequence required.  
SINGLE RUN - runs the sequence once and then stops.  
REPEAT RUN - runs the sequence repeatedly until STOPPED is chosen.
- 3 Choose the overhead type as required.  
RSOH- Regenerator Section Overhead  
MSOH- Multiplexer Section Overhead  
POH - Path Overhead
- 4 Choose the byte or bytes of overhead required.
- 5 Set up the required number of data patterns and the number of frames in which each data pattern should appear.  
Your sequence is derived from up to 5 blocks of hexadecimal data. Each block can be transmitted in up to 64,000 frames.

Selecting Test Features  
**Generating Overhead Sequences**

The data and the number of frames are set using **DECREASE DIGIT**  
**INCREASE DIGIT**  .

- 6 Start the sequence by choosing [STARTED].

---

**NOTE**

---

When you start the sequence illustrated, one Out of Frame alarm and one Loss of Frame alarm should occur every eight seconds.

---

## Using Receive Overhead Capture

### *Description*

Regenerator section, Multiplexer section and Path overhead provide network support functions, responding dynamically to network conditions and needs. It is therefore useful to capture overhead activity on a frame by frame basis.

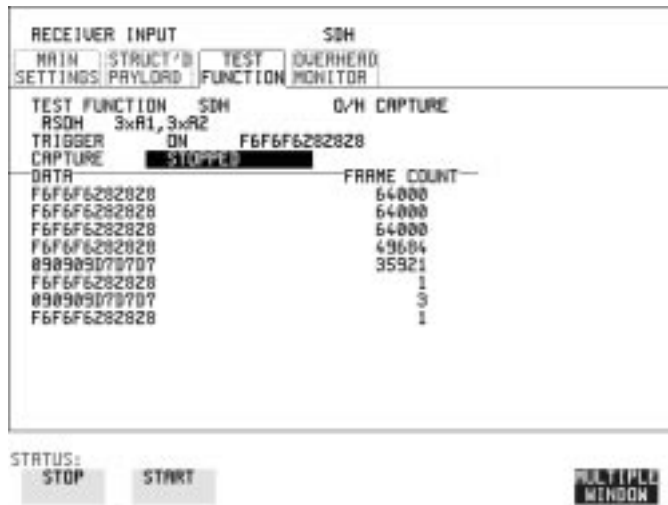

### *HOW TO:*

- 1 Set up the receive SDH interface and payload as required. See “Setting SDH Receive Interface” page 22.
- 2 Choose the overhead type as required.  
RSOH- Regenerator Section Overhead  
MSOH- Multiplexer Section Overhead  
POH- Path Overhead
- 3 Choose the Byte or bytes of overhead to be captured.

Choose the TRIGGER to determine the start point of the capture. **OFF** - starts immediately the capture is initiated. Can be used to provide a frame by frame monitor of the chosen byte or bytes.

**ON** -captures activity after your specified overhead state has occurred. Can be used for transient detection from a specified expected state.

**ON NOT** - captures activity after the first occurrence of a deviation from your specified overhead state. Can be used for transient detection from a specified expected state.

## Selecting Test Features

### Using Receive Overhead Capture

- 4 Up to 16 records of overhead state are provided. Each record will represent between 1 and 64,000 frames. A capture is started by pressing CAPTURE **STARTED** and terminates when up to 16 records have been captured. The capture can be terminated earlier by pressing CAPTURE **STOPPED**.

---

## Adding Frequency Offset to SDH Signal

### *Description*

Frequency offset can be added to the SDH interface rate signal and to the payload signal.

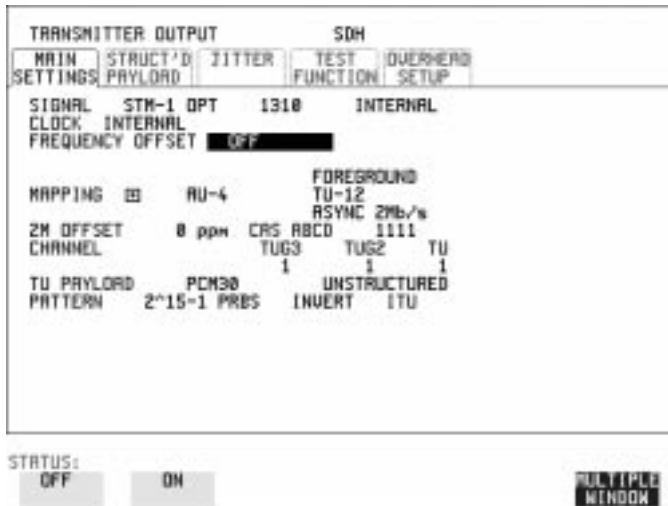

### *HOW TO:*

#### **SDH Line Rate Offset**

Choose the amount of frequency offset required.

You can set the Frequency Offset in the range -999 ppm to +999 ppm in 1 ppm steps using **DECREASE DIGIT** **INCREASE DIGIT**  and .

The amount of applied Frequency Offset can be varied while measurements are taking place.

If the value of the SDH line rate offset chosen is sufficient to cause the maximum stuff rate to be exceeded, the asynchronous payload is offset to prevent bit errors occurring and the maximum stuff rate is maintained. When Floating Byte 2 Mb/s is chosen, in conjunction with SDH line rate offset, the chosen tributary will be offset as the line rate is offset. (No pointer movements).

#### **Tributary Offset ±100 ppm**

Choose the amount of tributary offset required.

You can set the Offset in the range -100 ppm to +100 ppm in 1 ppm steps using **DECREASE DIGIT** **INCREASE DIGIT**  and .

## Selecting Test Features

### **Adding Frequency Offset to SDH Signal**

The amount of applied Frequency Offset can be varied while measurements are taking place.

Tributary offset affects the stuff rate but does not cause pointer movements and can be used to test mapping jitter. If the combined value of SDH line rate offset and tributary offset chosen is sufficient to cause the maximum stuff rate to be exceeded the payload is offset to prevent bit errors occurring and the maximum stuff rate is maintained.



## Adding Frequency Offset to the PDH Signal

### *Description*

You can add Frequency Offset to the interface PDH signal at all rates. Frequency Offset can be added at preset ITU values or as User defined values in the range  $\pm 100$  ppm.

The preset value changes according to the PDH signal rate chosen.:

- 2 Mb/s -  $\pm 50$  ppm
- 8 Mb/s -  $\pm 30$  ppm
- 34 Mb/s -  $\pm 20$  ppm
- 140 Mb/s -  $\pm 15$  ppm

For Option 110 instruments 34 Mb/s, 2Mb/s and DS1 32 ppm and DS3 20 ppm are available.

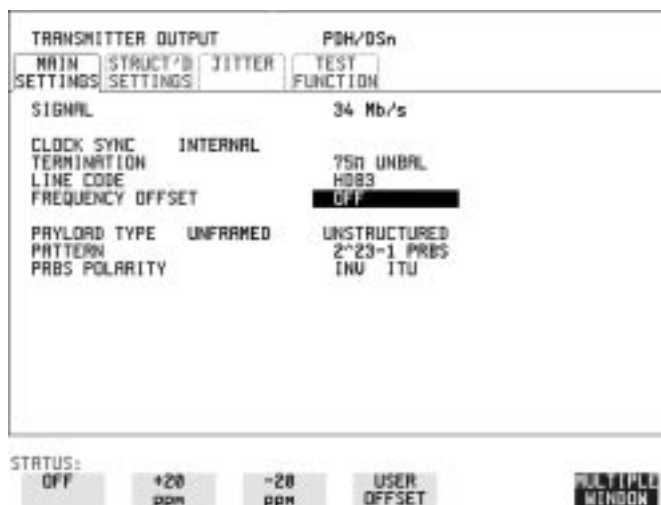

### *HOW TO:*

Choose the amount of frequency offset required.

If USER OFFSET is chosen you can set the Frequency Offset in the range -100 ppm to +100 ppm in 1 ppm steps using **DECREASE DIGIT** **INCREASE DIGIT** **←** and **→**.

The amount of applied Frequency Offset can be varied while measurements are taking place.

## Setting up Signaling Bits

### **Description**

The HP 37717C receiver can be used to monitor the state of signaling bits in received 2 Mb/s signals with timeslot-16 CAS (PCM30 or PCM30CRC) multiframing, structured or unstructured, and also in DS1 framed and structured signals (Option 110 instruments).

The HP 37717C transmitter can be configured to generate these signals and the state of the signaling bits defined by the user, as follows:

**2.048 Mb/s Signal** When transmitting 2.048 Mb/s signals with timeslot-16 CAS (PCM30 or PCM30CRC) multiframing the state of A,B,C,D signaling bits can be set. The signaling bits of all timeslots are set to the user-defined 4 bit value.

### **DS1 Signal (Option 110)**

When transmitting a DS1 framed, structured signal the values of the A,B signaling bits for D4 and SLC-96 payloads, and A,B,C,D signaling bits for ESF payloads can be defined. Signaling is not offered for a 64 kb/s or Nx64 kb/s Test Signal.

### **HOW TO**

## **Transmit a 2 Mb/s signal with user-defined signaling bits**

### **PDH Operation**

When transmitting a 2.048 Mb/s signal, (or a 2.048 Mb/s signal as part of a higher rate structured signal, i.e. 140 Mb/s, 34 Mb/s or 8 Mb/s) the A,B,C,D signaling bits can be set.

- 1 On the HP 37717C press **TRANSMIT** and select a PDH interface.
- 2 On the MAIN SETTINGS page select a 2 Mb/s SIGNAL and set the PAYLOAD TYPE to PCM30 or PCM30CRC (structured or unstructured).
- 3 Set the 2M CAS ABCD bits as required. If you select an unstructured payload the signaling bits are set up on the MAIN SETTINGS page; if structured is selected they are set up on the STRUCT'D SETTINGS page.
- 4 Press **RECEIVE** and set up the HP 37717C receiver interface to match the signal being output from the HP 37717C transmitter.

Selecting Test Features  
**Setting up Signaling Bits**

**SDH Operation**

- 1 On the HP 37717C press **TRANSMIT** and select an SDH interface.
- 2 On the MAIN SETTINGS page set MAPPING to ASYNC 2 Mb/s or FL BYTE 2 Mb/s and set the TU PAYLOAD to PCM30 or PCM30CRC (structured or unstructured).
- 3 Set the CAS ABCD bits as required. If you select an unstructured payload the signaling bits are set up on the MAIN SETTINGS page; if structured is selected they are set up on the STRUCT'D PAYLOAD page.
- 4 Press **RECEIVE** and setup the HP 37717C receiver interface to match the signal being output from the HP 37717C transmitter.

**HOW TO**

**Transmit a DS1 signal with user-defined signaling bits (option 110 instruments)**

**PDH Operation**

When transmitting a DS1 framed, structured signal or a DS3 signal structured down to DS1, the values of A,B signaling bits for D4 and SLC-96 payloads, and the A,B,C,D signaling bits for ESF payloads can be set.

- 1 On the HP 37717C press **TRANSMIT** and select a PDH interface.
- 2 On the MAIN SETTINGS page select a DS1 SIGNAL and set the PAYLOAD TYPE to D4, ESF or SLC-96 and STRUCTURED.
- 3 On the STRUCT'D SETTINGS page set the TEST SIGNAL to 56 kb/s or Nx56 kb/s
- 4 Set the A,B bits (for D4 and SLC-96) and A,B,C,D bits (for ESF) as required. Press **RECEIVE** and set up the HP 37717C receiver interface to match the signal being output from the HP 37717C transmitter.

**SDH Operation**

- 1 On the HP 37717C press **TRANSMIT** and select an SDH interface.
- 2 On the MAIN SETTINGS page set MAPPING to ASYNC DS1 and set the TU PAYLOAD to D4, ESF or SLC-96 and STRUCTURED.

## Selecting Test Features

### Setting up Signaling Bits

- 3 On the STRUCT'D PAYLOAD page set the TEST SIGNAL to 56 kb/s or Nx56 kb/s
- 4 Set the A,B bits (for D4 and SLC-96) and A,B,C,D bits (for ESF) as required. Press **RECEIVE** and set up the HP 37717C receiver interface to match the signal being output from the HP 37717C transmitter.

## Setting Transmit Structured Payload/ Test Signal (Options UKJ or 110)

**Description**

Structured PDH Payload/Test Signal settings determine the SDH payload or the PDH test signal to be tested and set any background (non test) conditions to prevent alarms while testing. Fully structured DS1 or DS3 payloads are only available if Option 110 is fitted.

**TIP:**

If you wish to set the HP 37717C transmitter and receiver to the same Payload settings, choose **OTHER** **SETTINGS CONTROL** **COUPLED**.

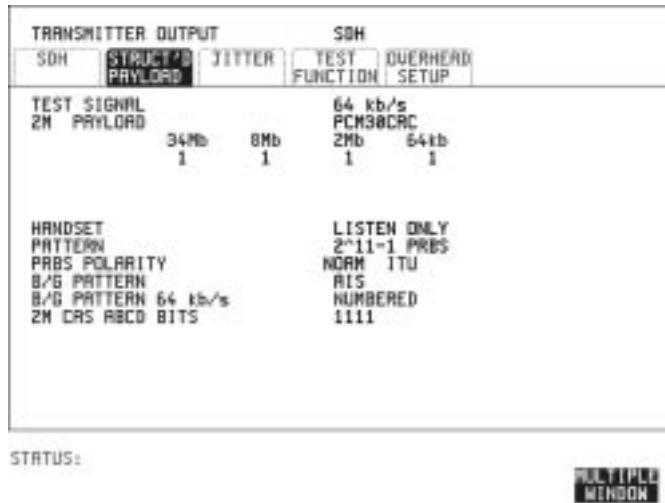

**HOW TO:**

- 1 Choose the required Test Signal rate. If N x 64 kb/s (or NX 56 kb/s Option 110) is chosen, see "Setting Transmit N x 64 kb/s (N x 56 kb/s) Structured Payload/Test Signal " page 48.
- 2 Choose the Framing pattern of the PAYLOAD.  
If 2 Mb/s (or DS1 Option 110 instruments) TEST SIGNAL is chosen, INSERT 2 Mb/s (or INSERT DS1) is added to the menu. See "Inserting an External PDH Payload/Test Signal " page 52
- 3 Choose the test tributary within the structured payload under 34Mb, 8Mb, 2Mb, 64 kb/s (DS2, DS1, 56kb/s for Option 110 instruments).

## Selecting Test Features

### Setting Transmit Structured Payload/Test Signal (Options UKJ or 110)

- 4 If 64 kb/s TEST SIGNAL is chosen, HANDSET is available (this is only available for option UKJ, and is not present in option 110 instruments). See "Connecting A Telephone Handset " page 47.
- 5 Choose the PATTERN type and PRBS polarity.  
If your choice matches ITU-T Recommendation O.150, ITU is displayed alongside your choice.
- 6 Choose the mapping required in the background (non-test) tributaries.  
If 64 kb/s or N x 64 kb/s (or 56 kb/s or Nx 56 kb/s for option 110 instruments) TEST SIGNAL is chosen, the B/G PATTERN in the non test timeslots is fixed as NUMBERED, that is, each timeslot contains a unique number to allow identification in case of routing problems.

### Signaling

- 7 If a 2 Mb/s PAYLOAD is transmitted with timeslot-16 CAS multiframing (PCM30 or PCM30CRC selected), set the CAS, ABCD bit value. If a DS1 PAYLOAD is transmitted, signaling is only offered with 56 kb/s or nx56 kb/s Test Signals.  
Select the values of AB signaling for SF and SLC-96 formats and ABCD signaling for ESF. In SLC-96 mode choices are 0,1 or alternating. In D4 mode AB choices are 0,1. See "Setting up Signaling Bits " page 40.

## Setting Receive Structured Payload/ Test Signal

**Description**

Structured PDH Payload/Test Signal settings determine the SDH payload or the PDH test signal to be tested. Structured payloads are only available if Option UKJ structured PDH or option 110, DS1, DS3, E1, E3 structured PDH is fitted.

**TIP:**

If you wish to set the HP 37717C transmitter and receiver to the same Payload settings, choose **OTHER** **STORED SETTINGS** **COUPLED**.

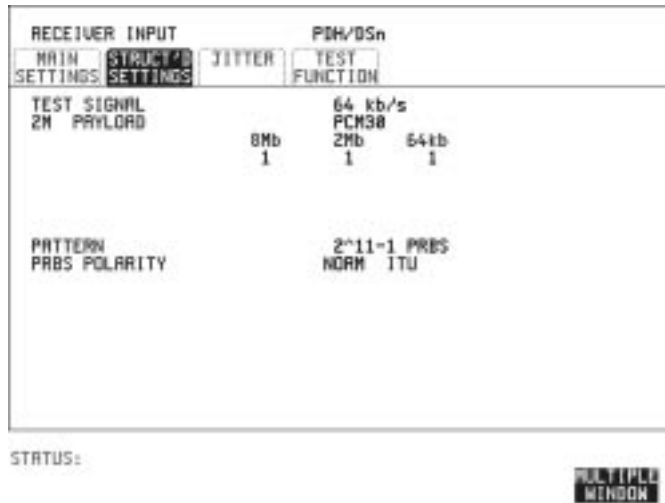

**Option Differences**

If Option 110 is fitted a 2M or DS1 PAYLOAD is available depending on the SIGNAL selection on the Receiver MAIN SETTINGS page.

- 1 Choose the required Test Signal rate. If N x 64 kb/s (or Nx56 kb/s Option 110) is chosen, see "Setting Receive N x 64 kb/s (N x 56 kb/s) Structured Payload/Test Signal " page 50.
- 2 Choose the Framing pattern of the PAYLOAD.  
If 2 Mb/s TEST SIGNAL is chosen, DROP 2 Mb/s is added to the menu. If DS1 TEST SIGNAL (Option 110) is chosen, DROP DS1 is added to the menu.  
See "Dropping an External Payload/Test Signal " page 55.
- 3 Choose the test tributary within the structured payload under 34Mb, 8Mb, 2Mb, 64 kb (DS2, DS1, 56 kb/s for Option 110 instrument).

## Selecting Test Features

### **Setting Receive Structured Payload/Test Signal**

- 4 If 64 kb/s TEST SIGNAL is chosen, the HANDSET facility is available (option UKJ only). See "Connecting A Telephone Handset " page 47.
- 5 Choose the PATTERN type and PRBS polarity.  
If your choice matches ITU-T Recommendation O.150, ITU is displayed beside your choice.



---

## Connecting A Telephone Handset

**Description:**

You can connect a telephone handset to a 64 kb/s voice channel for communication (TALK & LISTEN) or testing (LISTEN ONLY) purposes. You can only connect a telephone handset if Option UKJ, Structured PDH, is fitted.

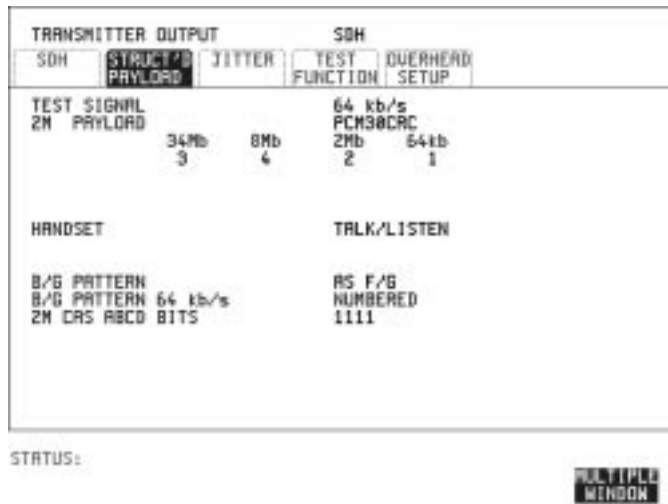

**HOW TO:**

- 1 Connect the telephone handset to the HANDSET port of the Structured PDH module, Option UKJ.
- 2 Choose the voice channel (timeslot) under 34Mb, 8Mb, 2Mb, 64kb or 8Mb, 2Mb, 64kb or 2M, 64kb.
- 3 Choose the HANDSET mode required.  
TALK & LISTEN allows you to communicate with a handset at the other end of the network.  
LISTEN ONLY allows you to listen to the traffic on the voice channel.
- 4 For B/G PATTERN and CAS ABCD BITS, see "Setting Transmit Structured Payload/Test Signal (Options UKJ or 110) " page 43.

**Setting Transmit N x 64 kb/s (N x 56 kb/s) Structured Payload/Test Signal**

**Setting Transmit N x 64 kb/s (N x 56 kb/s) Structured Payload/Test Signal**

**Description**

Wideband services such as high speed data links and LAN interconnection require a bandwidth greater than 64 kb/s but less than 2 Mb/s for example 128 kb/s or 384 kb/s. These wideband signals are sent in a 2 Mb/s frame by sharing the signal between multiple timeslots. N x 64kb/s structured payload allows a test pattern to be inserted across a number of Timeslots even if the chosen Timeslots are non-contiguous. Structured payloads are only available if Option UKJ, Structured PDH, or option 110, DS1, DS3, E1, E3 structured PDH is fitted.

**Option Differences**

Option 110 provides a choice of Nx64 kb/s or Nx56 kb/s Test Signals with a DS1 payload. The Nx56 kb/s selection is similar to Nx64 kb/s except that the last bit in each timeslot is set to 1.

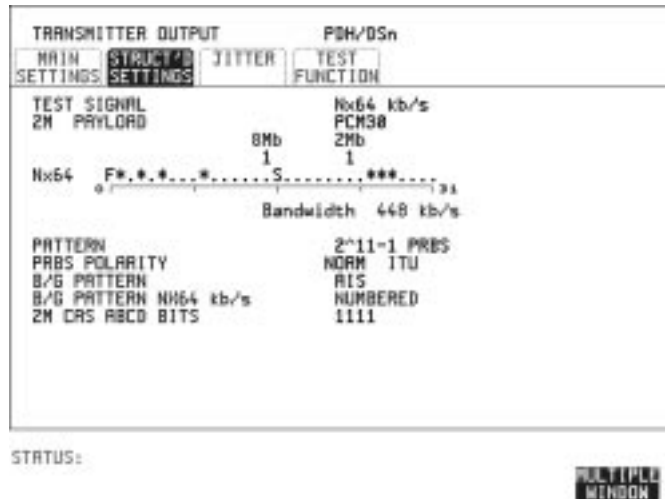

**HOW TO:**

- 1 Choose the required Test Signal rate.
- 2 Choose the Framing pattern of the 2M or DS1 (option 110) PAYLOAD.
- 3 Choose the test timeslots within the structured payload using **DESELECT ALL** **DESELECT** **SELECT** **←** and **→** softkeys. As each timeslot is chosen a \* marks the chosen timeslot. In the example shown Timeslots 3, 5, 9, 25, 26, 27 are chosen for test.

## Selecting Test Features

### **Setting Transmit N x 64 kb/s (N x 56 kb/s) Structured Payload/Test Signal**

- 4 Choose the PATTERN type and PRBS polarity.  
If your choice matches ITU-T Recommendation O.150, ITU is displayed alongside your choice.
- 5 The B/G PATTERN in the non-test timeslots is fixed as NUMBERED, that is, each timeslot contains a unique number to allow identification in case of routing problems.
- 6 If 2 Mb/s framing PCM30 or PCM30CRC is chosen, set the CAS ABCD bit value.

### **Signaling with a DS1 Payload Selected**

- 7 If a DS1 PAYLOAD is transmitted signaling is only offered when a 56kb/s or Nx56kb/s TEST SIGNAL is selected.  
Select the values of DS1 D4 or DS1 SLC-96 AB BITS or DS1 ESF ABCD BITS as required. See "Setting up Signaling Bits " page 40.

## Setting Receive N x 64 kb/s (N x 56 kb/s) Structured Payload/Test Signal

---

### Setting Receive N x 64 kb/s (N x 56 kb/s) Structured Payload/Test Signal

#### *Description*

Wideband services such as high speed data links and LAN interconnection require a bandwidth greater than 64 kb/s but less than 2 Mb/s e.g. 128 kb/s or 384 kb/s. These wideband signals are sent in a 2 Mb/s frame by sharing the signal between multiple timeslots. N x 64kb/s structured payload/test signal allows the test Timeslots to be chosen for error measurement even when the Timeslots are non contiguous.

Structured payloads are only available if Option UKJ, Structured PDH, or option 110 DS1, DS3, E1, E3 structured PDH is fitted.

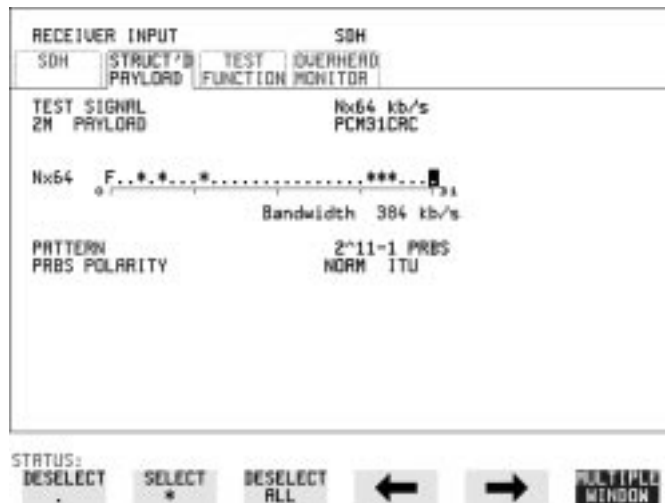

#### *Option Differences*



Option 110 provides a choice of N x 64 kb/s or N x 56 kb/s Test Signals with a DS1 payload. The N x 56 kb/s selection is similar to N x 64 kb/s except that the last bit in each timeslot is set to 1.

#### *HOW TO:*

- 1 Choose the required Test Signal rate.
- 2 Choose the Framing pattern of the 2M PAYLOAD or (DS1 PAYLOAD Option 110 instrument).

## Selecting Test Features

### Setting Receive N x 64 kb/s (N x 56 kb/s) Structured Payload/Test Signal

- 3 Choose the test timeslots within the structured payload using **DESELECT ALL** **DESELECT** **SELECT**  and  softkeys. As each timeslot is chosen a \* marks the chosen timeslot. In the example shown Timeslots 3, 5, 9, 25, 26, 27 are chosen for test.
- 4 Choose the PATTERN type and PRBS polarity. If your choice matches ITU-T Rec. O.150, ITU is displayed alongside your choice.

---

## Inserting an External PDH Payload/ Test Signal

### **Description**

You can insert a PDH signal from external equipment into the SDH signal as the test payload or insert 2 Mb/s or DS1 (option 110 instruments) into the structured PDH signal.

You can only insert an external payload if Option UKJ, Structured PDH, or Option 110, DS1, DS3, E1, E3 structured PDH is fitted.

140 Mb/s or 34 Mb/s (for option UKJ) and DS3 or 34 Mb/s (for option 110) can only be inserted if SDH is chosen as the interface level and the payload is not structured.

2 Mb/s or DS1 can be inserted into a non-structured or structured SDH payload and into a structured PDH signal

### **Option Differences**

Option UKJ you can insert 140 Mb/s, 34 Mb/s and 2 Mb/s payloads.

Option 110 you can insert 34 Mb/s, 2 Mb/s, DS3, and DS1 payloads



### **HOW TO:**

#### **Insert 34 Mb/s, DS3 & 140 Mb/s (SDH Only)**

- 1 Connect the external payload to the 75Ω IN port of the PDH receive module.

## Selecting Test Features

### Inserting an External PDH Payload/Test Signal

- 2 Set up the required transmit SDH interface, and choose INSERT 34Mb/s, 140Mb/s or DS3 as required on the **SDH MAIN SETTINGS** display. See “Description” page 6.

### Insert 2 Mb/s/DS1 (Unstructured SDH Payload)

- 1 Connect the external payload to the MUX port of the PDH Transmit module.
- 2 Set up the required transmit SDH interface, and choose INSERT 2Mb/s (select TU12 mapping), or INSERT DS1 (option 110 - select TU11 or TU12 mapping) on the **SDH MAIN SETTINGS** display. On Option 110 instruments also select a LINE CODE. See “Description” page 6.

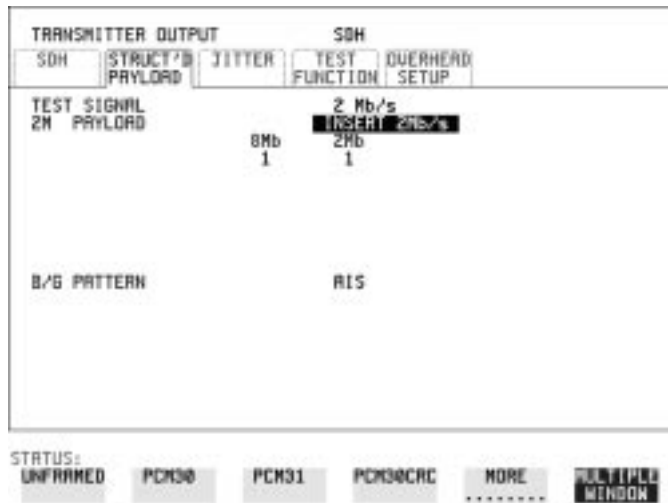

### Insert 2 Mb/s /DS1 (Structured SDH Payload or Structured PDH)

- 1 Connect the external payload to the MUX port of the PDH Tx module.
- 2 If you chose a structured SDH Payload, set up the required transmit SDH interface, set up the required SDH structured payload and choose INSERT 2 Mb/s or INSERT DS1 (Option 110) on the **SDH STRUCT'D PAYLOAD** display. On Option 110 instruments select the LINE CODE.

## Selecting Test Features

### Inserting an External PDH Payload/Test Signal

- 3 If you chose a Structured PDH set up, select the required transmit PDH interface, set up the required PDH Test Signal interface and choose INSERT 2 Mb/s or INSERT DS1 (Option 110 instruments) on the **PDH STRUCTURED SETTINGS** display.  
On Option 110 instruments select the LINE CODE [AMI or HDB3] for 2 Mb/s and [AMI or B8ZS] for DS1 Test Signals.

See "Setting PDH Transmit Interface" page 2 and "Setting Transmit Structured Payload/Test Signal (Options UKJ or 110) " page 43



---

## Dropping an External Payload/Test Signal

### **Description**

You can drop a PDH signal from the received payload or drop 2 Mb/s or DS1 (Option 110) from the structured PDH signal to external equipment for testing purposes.

You can only Drop an external payload if Option UKJ, Structured PDH, or option 110 DS1, DS3, E1, E3 structured PDH is fitted.

140 Mb/s and 34 Mb/s (for option UKJ) and DS3 or 34 Mb/s (for option 110) can only be dropped if SDH is chosen as the receive interface.

2 Mb/s or DS1 can be dropped from a structured or non-structured SDH payload and from a structured PDH signal.



### **HOW TO:**

#### **Drop 34 Mb/s, DS3 & 140 Mb/s**

- 1 Connect the 75Ω OUT port of the PDH Tx module to the external equipment.
- 2 Set up the receive SDH interface, and choose DROP 34Mb/s, DS3 or 140 Mb/s as required on the **SDH MAIN SETTINGS** display. See “Setting SDH Receive Interface” page 22.. If you select DROP DS3, also select the output level from DS3-HI, DSX-3 or DS3-900’.

### **Drop 2 Mb/s /DS1 (Unstructured SDH Payload)**

- 1 Connect the DEMUX port of the PDH module to the external equipment.
- 2 Set up the required transmit SDH interface, and choose DROP 2Mb/s or DS1 (Option 110) on the **SDH MAIN SETTINGS** display. Select a LINE CODE. See “Setting SDH Receive Interface” page 22.

### **Drop 2 Mb/s/DS1 (Structured SDH Payload or Structured PDH)**

- 1 Connect the DEMUX port of the PDH module to the external equipment.
- 2 If you chose a structured SDH payload, set up the required receive SDH interface, set up the required receive SDH structured payload and choose DROP 2 Mb/s (select TU12 Mapping) or DROP DS1 (Option 110 - select TU11 or TU12 Mapping) on the **SDH STRUCT'D PAYLOAD** display. See "Setting Receive Structured Payload/Test Signal " page 45 and “Setting SDH Receive Interface” page 22.
- 3 If you chose a structured PDH, set up the required receive PDH interface, set up the required receive Structured Payload/Test Signal and choose DROP 2 Mb/s or DROP DS1 (Option 110) on the **PDH STRUCT'D SETTINGS** display. See “Setting PDH Receive Interface” page 19 and "Setting Receive Structured Payload/Test Signal " page 45.

---

## Selecting ATM Cell Stream Payload

### *Description*

The test stream comprises: 1 Foreground (F/G) Channel, 3 Background (B/G) Channels and the remaining cell opportunities which are filled with unassigned or idle cells.

The screenshot shows a configuration window titled "TRANSMITTER OUTPUT" with a sub-tab "ATM". The window is divided into several sections:

- PHYSICAL LAYER**: Includes "CELL STREAM INTERFACE" and "CONVENTS UNI".
- F/G PAYLOAD**: Shows "F/G HEADER" with fields DFC (0), UPI (0), UCI (32), PTI (000), and CLP (0). The "F/G PAYLOAD" is set to "TEST CELL".
- B/G STREAM**: Shows "B/G HEADER" with fields DFC (0), UPI (1), UCI (32), PTI (000), and CLP (0). The "B/G PAYLOAD" is set to "00000001".
- FILL CELLS**: Set to "IDLE".

At the bottom of the window, there are three buttons: "STATUS: DISTRIBUTION", "CONTENTS", and "MULTIPLE WINDOW".

### *HOW TO:*

- 1 Select the payload which will be the subject of the test, the foreground payload, in F/G PAYLOAD

For Delay measurements and Cell Misinsertion and Loss measurements you need to select **TEST CELL**

The **CROSS CELL** PRBS runs continuously from cell to cell. With the cross cell PRBS, cell misinsertion or cell loss will cause pattern sync loss. With **SINGLE CELL** PRBS, the PRBS is restarted in every cell. Cell loss will **NOT** cause pattern sync loss but, of course, payload errors will be counted.

The **USER BYTE** selection allows you to select your own fixed byte in the foreground.

- 2 Select a background stream B/G STREAM 1,2 or 3
- 3 Select the byte to be used as a payload in the selected background (B/G PAYLOAD).
- 4 Repeat the procedure for the other B/G STREAMS.
- 5 Select the remaining content of the cell stream FILL CELLS **IDLE** or **UNASSIGNED**

---

## Selecting ATM Cell Stream Timing Distribution

### *Description*

The foreground and background bandwidths and timing distribution are selected to represent the service that you want to simulate.

The screenshot shows a configuration window titled "TRANSMITTER OUTPUT" with a sub-tab "ATM". The window is divided into several sections:

- PHYSICAL LAYER**: Includes buttons for "ATM LAYER", "JITTER", and "TEST FUNCTION".
- CELL STREAM**: A section with a highlighted "DISTRIBUTION" button.
- BANDWIDTH**: A table with columns for "( % )", "( cell/s )", and "( bit/s )".
- F/G DISTRIBUTION**: A section with a highlighted "BURST" button.
- STATUS:**: Includes buttons for "DISTRIBUTION" and "CONTENTS".
- MULTIPLE WINDOW**: A button at the bottom right.

	( % )	( cell/s )	( bit/s )
F/G	100	4528	1919072
B/G #1	0	0	0
B/G #2	0	0	0
B/G #3	0	0	0
IDLE	0	0	0

F/G DISTRIBUTION BURST SIZE: 1 cells

### *HOW TO:*

- 1 Select the foreground F/G bandwidth.
- 2 Select the background B/G #1, #2 and #3 bandwidths.
- 3 Select the foreground F/G DISTRIBUTION. This will depend on the type of service to be simulated. For simulation of a Constant Bit Rate service, choose **PERIODIC**, for simulation of data transfer type services choose **BURST**.
- 4 If F/G DISTRIBUTION **PERIODIC** is selected, an additional burst of up to 2047 cells may be added by setting the ADD SINGLE BURST OF to the number of cells required and toggling **OFF** to **ADD BURST**.

The selection for the remaining bandwidth, IDLE or UNASSIGNED, made on the CELL STREAM **CONTENTS** display is shown here.

## Selecting ATM Cell Stream Headers and Interface

### Description

The components of the ATM cell stream headers and the interface UNI or NNI are selectable. User Network Interface (UNI) is used between a LAN and a switch in the public network, Network Node Interface (NNI) is used between switches in the public network.

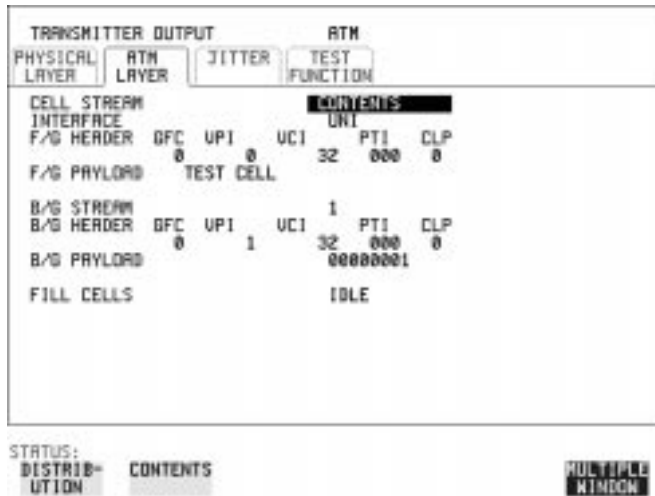

### HOW TO:

- 1 Select the INTERFACE, UNI or NNI.
- 2 Set up the header for the cell which is the subject of the test F/G HEADER:  
 Generic Flow Control (GFC) - Applies to (UNI) only.  
 Virtual Path Indicator(VPI),  
 Virtual Channel Indicator(VCI),  
 Payload Type Indicator (PTI) -  
 Congestion not experienced= 000, Congestion experienced= 010  
 Cell Loss Priority (CLP) - 0=High Priority - 1=Low Priority
- 3 Select a background stream B/G STREAM 1,2 or3.
- 4 Select the header for the selected background (B/G HEADER).
- 5 Repeat the procedure for the other B/G STREAMS.
- 6 Select the content of the fill cells which will make up the remainder of the cell stream. by selecting FILL CELLS - **IDLE** or **UNASSIGNED**.

---

## Adding Errors & Alarms at the SDH Interface

### ***Description***

Errors and alarms can be added to the SDH interface signal during testing.

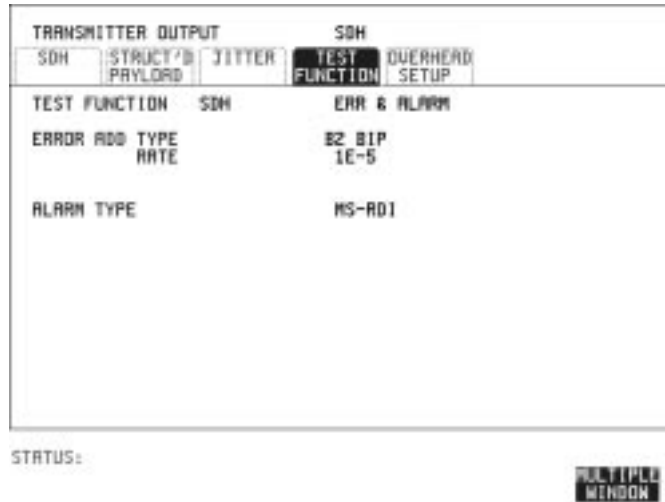

### ***HOW TO:***

- 1 Set up the SDH transmit interface and payload required. See “Description” page 6.
- 2 Choose the ERROR ADD TYPE and RATE required. If B2 BIP errors are added, in addition to ERROR ALL and selectable rates, MSP THRESHOLD may be selected. In this case the MSP timing is selectable, number of errors and time period.
- 3 Choose the ALARM TYPE  
Errors and Alarms can be added at the same time.

## Adding Errors & Alarms to the PDH Interface/PDH Payload

**Description**

Errors and alarms can be added to the PDH payload signal during testing.

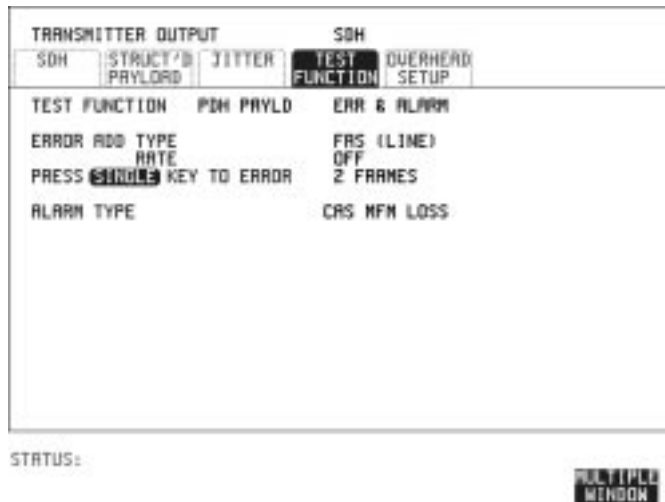

**HOW TO:**

- 1 If SDH interface is chosen, set up the SDH transmit interface and payload required. See “Description” page 6.  
If PDH interface is chosen, set up the PDH interface and payload required. See “Setting PDH Transmit Interface” page 2.
- 2 Choose the ERROR ADD TYPE and RATE required. The RATE can be selected from a fixed value or is user programmable. If you select USER PROGRAM you can select the error rate before enabling the errors. This feature is useful when doing error threshold testing.
- 3 Choose the ALARM TYPE.  
Errors and Alarms can be added at the same time.

**DS1 & DS3 Alarm Generation (Option 110 instruments)**

The following alarms are generated when a PDH Payload is selected on the Transmitter TEST FUNCTION page for DS1 and DS3 signals.

## Selecting Test Features

### Adding Errors & Alarms to the PDH Interface/PDH Payload

#### ***DS1 Signal***

**LOS:** The output signal is turned off (not available when mapped into SONET/SDH).

**DS1 OOF:-** The selected framing is turned off

**DS1 AIS:** - Unfamed all ones is transmitted

**DS1 RAI/YELLOW:**

**ESF:** The 4 kHz data link carries a repetitive 8-zeros/8 ones pattern as defined in Bellcore TA 194.

**D4(SF), SLC-96:** Bit 2 of every timeslot is set to '0'.

#### ***DS3***

**LOS:** - The output signal is turned off (not available when mapped into SONET/SDH)

**DS3 OOF:** - The F framing bits are set to 0

**DS3 AIS:** - Generates a 1010....sequence.

**DS3 IDLE:** - 1100 repeating pattern.

**DS3 RAI/X-BIT:-** The X1, X2 bits are set to 00. Also known as a Remote Defect Indicator (RDI)

**FEAC Codes:** - With **CBIT** Payload Type selected on the Transmitter MAIN SETTINGS page the HP 37717C can transmit DS3 **FEAC** codes. Refer to the following paragraph for an explanation of FEAC codes and how to use them with the HP 37717C.



---

## Using FEAC Codes in the HP 37717C

### *Description*

The third C-Bit in subframe 1 is used as a FEAC channel, where alarm or status information from the far-end terminal can be sent back to the near-end terminal. The channel is also used to initiate DS3 and DS1 line loopbacks at the far-end terminal from the near-end terminal.

The codes are six digits long and are embedded in a 16 bit code word; the format is 0XXXXXX01111111

### To transmit an FEAC code (Option 110 instruments)

- 1 Select a DS3 Signal and C-BIT framing on the Transmitter MAIN SETTINGS page.
- 2 Select the TEST FUNCTION page and set the ALARM TYPE to DS3 FEAC. The following Figure gives an example of the HP 37717C display configured to generate a FEAC message.

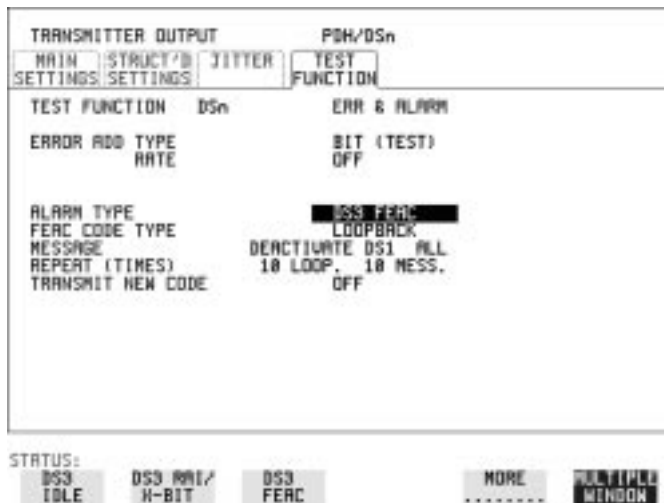

When an FEAC code is not being transmitted the all ones pattern is transmitted.

**Using FEAC Codes in the HP 37717C**

- 3 Choose the FEAC CODE TYPE (LOOPBACK or ALARM STATUS). If you chose LOOPBACK proceed to step 4; if not proceed to step 7.
- 4 Choose the MESSAGE from the choices displayed. If you chose a DS1 message an additional field to the right of the DS1 MESSAGE is displayed. Position the cursor on this field and select ALL or SINGLE CHANNEL. If you choose SINGLE CHANNEL use the EDIT keys to select a channel from 1 to 28. Press **END EDIT** when finished.
- 5 Set the REPEAT (TIMES) fields LOOP and MESS, as required, both can be set in the range 1 to 15.
- 6 Select TRANSMIT NEW CODE and press the **BURST** key to transmit the selected FEAC message.
  
- 7 Continue here if you selected ALM/STATUS, FEAC CODE TYPE. Select a MESSAGE from the choices displayed; use the **MORE** key to access more selections. Select **USER CODE** if you wish to define an FEAC message. The FEAC message comprises a repeating 16 bit codeword consisting of 0xxxxxx01111111 (where x is user-definable, 0 or 1). Use the EDIT keys to define the FEAC codeword.
- 8 Set the BURST LENGTH (TIMES) to CONTINUOUS or BURST. If you select BURST use the EDIT keys to select the BURST LENGTH (selectable from 1 to 15). Press the END EDIT key when finished.
- 9 Position the cursor on TRANSMIT NEW CODE and select ON or BURST (choice depends upon selection in BURST LENGTH field).

See next page for information on how to view transmitted FEAC messages:

Selecting Test Features  
Using FEAC Codes in the HP 37717C

**To View Transmitted FEAC Messages**

The FEAC message you transmit can be viewed on the DS<sub>n</sub> RESULTS display if the Receiver settings match those of the Transmitter (i.e. select DS3 and CBIT Payload on Receiver). The following figure gives an example of a FEAC Message on the Results page.

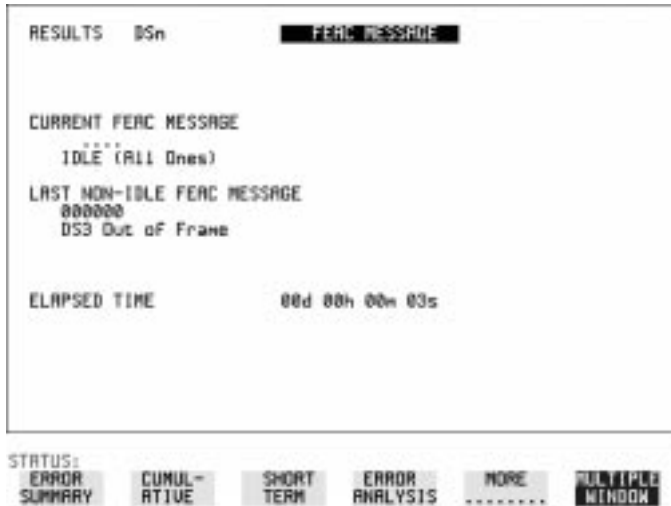

---

## Adding ATM Errors and Alarms

### *Description*

ATM errors and alarms may be introduced into the cell stream.

TRANSMITTER OUTPUT		ATM	
PHYSICAL LAYER	ATM LAYER	JITTER	TEST FUNCTION
TEST FUNCTION	ATM PAYLD	ERR & ALARM	
ERROR ADD TYPE	STREAM RATE	SINGLE HEC F/B CELLS 1E-9	
OAM CELL ALARMS		UC-RIS	

STATUS: UC-RIS alarm

MULTIPLE WINDOW

### *HOW TO:*

- 1 Select TEST FUNCTION **ATM PAYLOAD**
- 2 Select the ERROR ADD TYPE.  
To check header error correction capability, choose **SINGLE HEC** to introduce single Header Error Control errors  
To check the detection and discard operation of devices, choose **DOUBLE HEC** to introduce double Header Error Control errors.  
To introduces bit errors into the atm payload, choose **BIT**.
- 3 For **SINGLE HEC** and **DOUBLE HEC** errors, select the STREAM, foreground **F/G CELLS** or foreground and background **ALL CELLS**.  
When **ALL CELLS** is selected, a burst may be added and used to check the header alignment algorithm.
- 4 Select the error add RATE.
- 5 Select OAM ALARM TYPE.

---

## Setting PDH Spare Bits

### *Description*

Certain Spare Bits will cause the occurrence of a minor alarm when received as a logical "0".:

140 Mb/s - FAS Bit 14

34 Mb/s - FAS Bit 12

8 Mb/s - FAS Bit 12

2 Mb/s - NFAS Timeslot (timeslot 0 of NFAS frame) Bit 0

TRANSMITTER OUTPUT		SDH		
SDH	STRUCT'D PAYLOAD	JITTER	TEST FUNCTION	OVERHEAD SETUP
TEST FUNCTION	PDH PAYLD	SPARE BITS		
140M: FAS BITS 14-16		111		
34M: FAS BIT 12		1		
8M: FAS BIT 12		1		
2M: S1 BITS CRC4 FRAME E-BITS		11		
S2 BITS (NFAS T/S BITS 4-8)		11111		
S2 BIT SEQUENCE 11111111	IN BIT 4	4		
SEND SEQUENCE		OFF		
CBS MFM T/S-16 BITS 5,7,8		111		

STATUS:

MULTIPLE  
WINDOW

### *HOW TO:*

- 1 If SDH interface is chosen, set up the SDH transmit interface and payload required. See "Description" page 6.  
If PDH interface is chosen, set up the PDH transmit interface and payload required. See "Setting PDH Transmit Interface" page 2.
- 2 Set the value of the spare bits required for testing.  
If a BIT SEQUENCE is required, choose SEND SEQUENCE [ON] to transmit the sequence.

---

## Adding Pointer Adjustments

### *Description*

The transmitted AU or TU pointer value can be adjusted for testing purposes.

The screenshot shows a terminal window with the following text:

```
TRANSMITTER OUTPUT          SDH
MAIN STRUCT'D JITTER TEST OVERHEAD
SETTINGS PAYLOAD FUNCTION SETUP
-----
TEST FUNCTION SDH          ADJUST PTR
POINTER TYPE          TU POINTER
                        6,783
ADJUSTMENT TYPE      a) PERIODIC SINGLE
                        POLARITY ALTERNATING
                        INTERVAL 10 ms
POINTER SEQUENCES    STOPPED
```

Below the main menu is a STATUS line:

```
STATUS:
PERIODIC PERIODIC PERIODIC PERIODIC  NONE  MULTIPLE
SINGL a)  ADD  b)  CAN  c)  DOUBL d)  ..... WINDOW
```

### *HOW TO:*

- 1 Set up the SDH transmit interface and payload required. See “Description” page 6.
- 2 Choose the POINTER TYPE.
- 3 Choose the ADJUSTMENT TYPE required.  
**BURST** - You determine the size of the burst by the number of PLACES chosen. If, for example, you choose 5 PLACES the pointer value will be stepped 5 times in unit steps e.g. 0 (start value), 1, 2, 3, 4, 5 (final value). The interval between steps is as follows:  
For AU and TU-3, the minimum spacing between adjustments is 500 us. For TU except TU-3, the minimum spacing between adjustments is 2 ms.  
Choose ADJUST POINTER [ON] to add the chosen burst.  
  
**NEW POINTER** - You can choose a pointer value in the range 0 to 782 with or without a New Data Flag.  
The current pointer value is displayed for information purposes.  
Choose ADJUST POINTER [ON] to transmit the new pointer value.

## Selecting Test Features

### Adding Pointer Adjustments

**OFFSET** - You can frequency offset the line rate or the VC/TU rate, relative to each other, thus producing pointer movements. If you offset the AU pointer, an 87:3 sequence of pointer movements is generated. The available configurations are listed in the following table. If you are currently adding Frequency Offset to the SDH interface or payload, pointer OFFSET is not available.

Pointer Type	Line Rate	AU Payload (VC) Rate	TU Payload (TU) Rate
AU	Constant	Offset	Tracks AU Payload
AU	Offset	Constant	Constant
TU	Constant	Constant	Offset
TU	Offset	Tracks Line Rate	Constant

**G.783** - Provides pointer movements according to ITU-T G.783:

If you are familiar with G.783 pointer sequences proceed to steps 4 and 5; if not refer to the text given in the following pages for explanations of the pointer sequences offered, and the mapping selections required to enable particular pointer sequences.

- 4 Select the G.783 ADJUSTMENT TYPE from the choices given, then select the POLARITY, INTERVAL and PATTERN (where applicable) for the selected sequence.
- 5 Choose POINTER SEQUENCES [START INIT] to generate the selected G.783 sequence and [STOP INIT] to stop the pointer sequences.

---

## G.783 Pointer Sequences Explained

In addition to the BURST, NEW POINTER and OFFSET pointer movements described, the HP 37717C can also generate pointer sequences (pointer movements) according to ITU-T G.783, T1.105.03 and GR-253. Note that T.105.03/GR-253 sequences are explained in the SONET version of this User's Guide.

Before running a pointer sequence you can elect to run an initialization sequence, followed by a cool down period, and then run the chosen sequence. This is selected using the START INIT softkey shown in the display on the previous page. Initialized pointer sequences are made up of three periods: the *Initialization Period*, the *Cool Down Period*, and the *Sequence (Measurement) Period*, illustrated in the following figure:

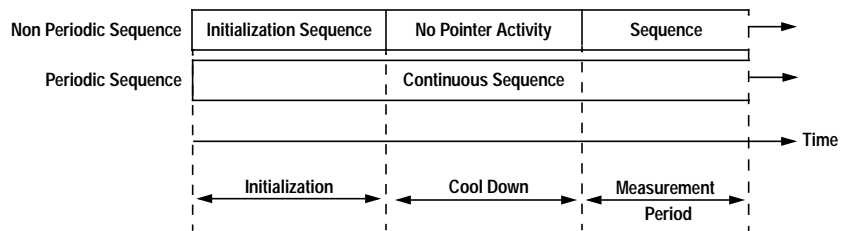

Note: SINGLE (e), BURST (f) and PHASE TRANSIENT are Non Periodic Sequences.

### Initialization Period

For SINGLE (e), BURST (f) and PHASE TRANSIENT sequences the initialization sequence consists of 60 seconds of pointer adjustments applied at a rate of 2 adjustments per second and in the same direction as the specified pointer sequence.

### Cool Down Period

A period following the initialization period which for SINGLE (e), BURST (f) and PHASE TRANSIENT sequences is 30 seconds long when no pointer activity is present.



## G.783 Pointer Sequences Explained

### Sequence (Measurement) Period

The period following the Cool Down period where the specified pointer sequence runs continuously.

### Periodic Test Sequences

For periodic test sequences (for example “PERIODIC ADD g/h”) both the 60 second initialization and 30 second cool down periods consist of the same sequence as used for the subsequent measurement sequence. If the product of the period T and the selected optional background pattern (87+3 or 26+1) exceeds 60 seconds then the longer period is used for the initialization. For example, if T is set for 10 seconds then the initialization period may be extended to 900 seconds.

The HP 37717C displays a message indicating which phase (initialization, cool down or measurement) the transmitter is currently generating.

---

#### NOTE

The following conditions apply for pointer sequence generation:  
The sequences can only be applied to the AU pointer when the AU does not contain a TU structure, otherwise it is applied to the TU pointer.  
Pointer sequence generation is not available when a frequency offset is being applied to the Line Rate.

---

The following figure gives an example of a G.783 (g) 87-3 Pointer Sequence.

### G.783(g) 87-3 Pattern

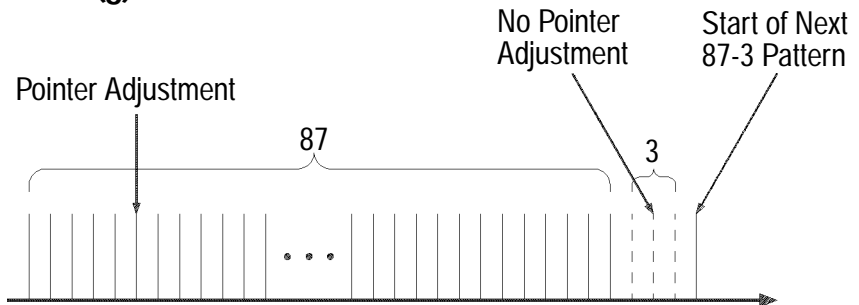

An Example of a Pointer Sequence

Selecting Test Features

**G.783 Pointer Sequences Explained**

Pointer Sequence	Description
<b>G.783(a) PERIODIC SINGLE</b>	Periodic Single adjustments, each with opposite polarity to the preceding adjustment. The interval between pointer adjustments is user selectable (see Note 1 page 74).
<b>G.783 (b) PERIODIC ADD</b>	Periodic Single adjustments, with selectable polarity and added adjustment (1 extra). The spacing between the added adjustment and the previous adjustment is set to the minimum, (see Note 2 page 74). The interval between pointer adjustments is user selectable (see Note 1). Added adjustments occur every 30 seconds.
<b>G.783 (c) PERIODIC CANCEL</b>	Periodic Single adjustments, with selectable polarity and cancelled adjustment (1 less). The interval between pointer adjustments is user selectable (see Note 1 page 74). Cancelled adjustments occur every 30 seconds.
<b>G.783(d) PERIODIC DOUBLE</b>	Periodic Double adjustments (pair of adjustments). The pair alternate in polarity. The spacing between pairs of adjustments, of like polarity is set to the minimum (see Note 2). The interval between pointer adjustments is user selectable (see Note 1).
<b>G.783 (e) SINGLE</b>	Periodic Single adjustments, all of the same polarity which is selectable. Separation between pointer adjustments is fixed at approximately 30 seconds.
<b>G.783 (f) BURST</b>	Periodic bursts of 3 adjustments, all of the same polarity which is selectable. The interval between bursts is fixed at approximately 30 seconds. The interval between adjustments within a burst is set to the minimum (see Note 2 page 74).
<b>PHASE TRANSIENT</b>	Phase transient pointer adjustment burst test sequence. All adjustments are of the same polarity, which is selectable. The interval between bursts is fixed at 30 seconds. Each burst consists of 7 pointer movement. The first 3 in each burst are 0.25 s apart, and the interval between the 3 and 4 movement, and each remaining movement 0.5 seconds.
<b>G.783 (g) PERIODIC NORMAL (87-3 Pattern)</b>	An 87-3 pattern is selected. The sequence pattern is 87 pointer movements followed by 3 missing pointer movements. Pointer polarity is selectable and the time interval between pointer adjustments settable (see Note 1 page 74).

## Selecting Test Features

### G.783 Pointer Sequences Explained

Pointer Sequence	Description
G.783 (g) PERIODIC ADD (87-3 Pattern)	An 87-3 pattern is selected. The sequence pattern is 87 pointer movements followed by 3 missing pointer movements with an added pointer movement after the 43rd pointer. The spacing between the added adjustment and the previous adjustment is set to the minimum, (see Note 2 page 74). Pointer polarity is selectable. The time interval between pointer adjustments can be set (see Note 1). Added adjustments occur every 30 seconds or every repeat of the 87-3 pattern, whichever is longer.
G.783 (g) PERIODIC CANCEL (87-3 pattern)	An 87-3 pattern is selected. The sequence pattern is 87 pointer movements followed by 3 missing pointer movements with a cancelled pointer movement at the 87th pointer. Pointer polarity is selectable, and the time interval between pointer adjustments can be set (see Note 1). Cancelled adjustments occur every 30 seconds or every repeat of the 87-3 pattern, whichever is longer.
G.783 (h) PERIODIC NORMAL (Continuous Pattern)	Provides a continuous sequence of pointer adjustments. The polarity of the adjustments is selectable, and the time interval between adjustments can be set (see Note 1).
G.783 (h) PERIODIC ADD (Continuous Pattern)	Periodic Single adjustments, with selectable polarity and added adjustment (1 extra). The spacing between the added adjustment and the previous adjustment is set to the minimum, (see Note 2). The time interval between pointer adjustments can be set (see Note 1). Added adjustments occur every 30 seconds or every repeat of the 87-3 pattern, whichever is longer.
G.783 (h) PERIODIC CANCEL (Continuous Pattern)	Periodic Single adjustments, with selectable polarity and cancelled adjustment (1 less). The time interval between pointer adjustments can be set (see Note 1). Cancelled adjustments occur every 30 seconds or every repeat of the 87-3 pattern, whichever is longer.
PERIODIC NORMAL (26-1 Pattern)	This selection is only available if you have selected TU11 mapping, or TU12 with ASYNC DS1 selected. The sequence pattern is 26 pointer movements followed by 1 missing pointer movement. Pointer polarity is selectable and the time interval between pointer adjustments programmable to 200 ms, 500 ms, 1 s, 2 s, 5 s or 10 seconds.

Selecting Test Features  
**G.783 Pointer Sequences Explained**

Pointer Sequence	Description
<b>PERIODIC ADD (26-1 Pattern)</b>	<p>This selection is only available if you have selected TU11 mapping, or TU12 with ASYNC DS1 selected. The sequence pattern is 26 pointer movements followed by 1 missing pointer movement. The added adjustment occurs 2 ms after the 13th pointer adjustment. Pointer polarity is selectable and the time interval between pointer adjustments programmable to 200 ms, 500 ms, 1 s, 2 s, 5 s or 10 s. Added adjustments occur every 30 seconds or every repeat of the 26-1 pattern, whichever is longer.</p>
<b>PERIODIC CANCEL (26-1 pattern)</b>	<p>This selection is only available if you have selected TU11 mapping, or TU12 with ASYNC DS1 selected. The sequence pattern is 26 pointer movements followed by 1 missing pointer movement. The cancelled adjustment is the 26th pointer adjustment, that is the one before the regular gap of 1. Pointer polarity is selectable and the time interval between pointer adjustments programmable to 200 ms, 500 ms, 1 s, 2 s, 5 s or 10s. Cancelled adjustments occur every 30 seconds or every repeat of the 26-1 pattern, whichever is longer.</p>

**Pointer Sequence Notes**

**Note 1:** For AU and TU-3, the sequence interval is selectable from:

- 7.5 ms, 10, 20, 30, 34 ms
- 40 to 100 ms in 10 ms steps, 100 to 1000 ms in 100 ms steps
- 1, 2, 5, 10 seconds.

For TU except TU-3, the sequence interval is selectable from:

- 200 ms, 500 ms, 1, 2, 5 and 10 seconds.

**Note 2:** For AU and TU-3, the minimum spacing between adjustments is 500 us.

For TU except TU-3, the minimum spacing between adjustments is 2 ms.

Selecting Test Features  
**G.783 Pointer Sequences Explained**

Table 1

**Pointer Sequences Available with Selected Mapping**

POINTER SEQUENCE	MAPPING			
	AU Only	TU-3	TU-2, TU-12 (not DS1)	TU-12(DS1), TU-11
G.783 SINGLE (a, b, c)	✓	✓	✓	✓
G.783(d) PERIODIC DOUBLE	✓	✓	✓	✓
G.783(e) SINGLE	✓	✓	✓	✓
G.783 (F) BURST	✓	✓	✓	✓
PHASE TRANSIENT	✓	✓	✓	✓
PERIODIC NORMAL (g) 87-3	✓	✓		
PERIODIC ADD (g) 87-3	✓	✓		
PERIODIC CANCEL (g) 87-3	✓	✓		
PERIODIC NORMAL (h)	✓	✓	✓	✓
PERIODIC ADD (h)	✓	✓	✓	✓
PERIODIC CANCEL (h)	✓	✓	✓	✓
PERIODIC NORMAL 26-1				✓
PERIODIC ADD 26-1				✓
PERIODIC CANCEL 26-1				✓

---

## Using Pointer Graph Test Function

Pointer Graph shows the relative offset during the measurement period. This allows the time relationship of AU or TU pointer movements to be observed. Up to 4 days of storage allows long term effects such as Wander to be observed. If an alarm occurs during the measurement period, a new graph starts at the centre of the display (offset zero) after recovery from the alarm.

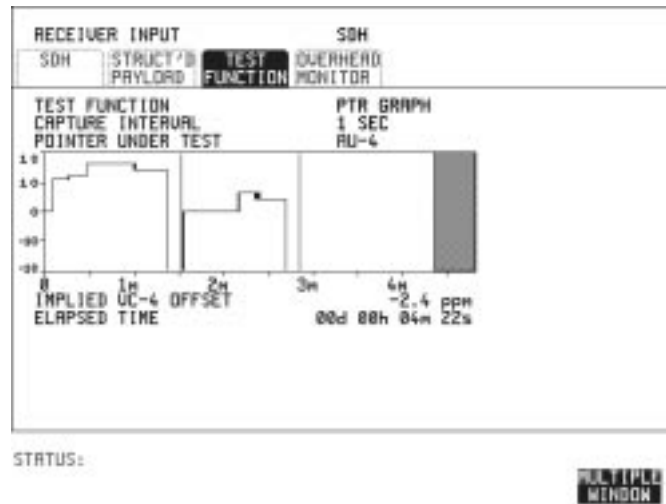

**TIP:** The graph can also be viewed on the **RESULTS** **SDH RESULTS** display at the end of the measurement.

- HOW TO:**
- 1 Set up the receive SDH interface and payload as required. See “Setting SDH Receive Interface” page 22.
  - 2 Choose the CAPTURE INTERVAL required.  
The capture interval determines the time between captures. Low values of capture interval should be chosen when a high degree of pointer movements is expected.  
High values of capture interval should be chosen when a low degree of pointer movements is expected, for example Wander over 1 day, use 5 MINS and Wander over 4 days, use 20 MINS.

## Selecting Test Features

### Using Pointer Graph Test Function

If, during a long term measurement (4 days), an event occurs at a particular time each day, a short term measurement can be made at the identified time to gain more detail of the event.

#### **HOW TO:**

- 3 Choose the POINTER UNDER TEST type AU or TU.
- 4 Press **RUN/STOP** to start the measurement.

#### **TIP:**

If the event occurs outside normal working hours, a Timed Start measurement can be made.

1 SEC - display window of approximately 5 minutes.

5 SECS - display window of approximately 25 minutes.

20 SECS - display window of approximately 1 hour 40 minutes.

1 MIN - display window of approximately 5 hours.

5 MIN - display window of approximately 1 day.

20 MIN - display window of approximately 4 days.

---

## Stressing Optical Clock Recovery Circuits

### *Description*

Ideally clock recovery circuits in the network equipment optical interfaces should recover the clock even in the presence of long strings of 0s. You can check the performance of your optical clock recovery circuits using the STRESS TEST test function.

The stress test is available at STM-4 and STM-4c if Option 130 or 131 is fitted. If options 110/120 are also fitted then the stress test is also available at STS-12BIN and OC-12.

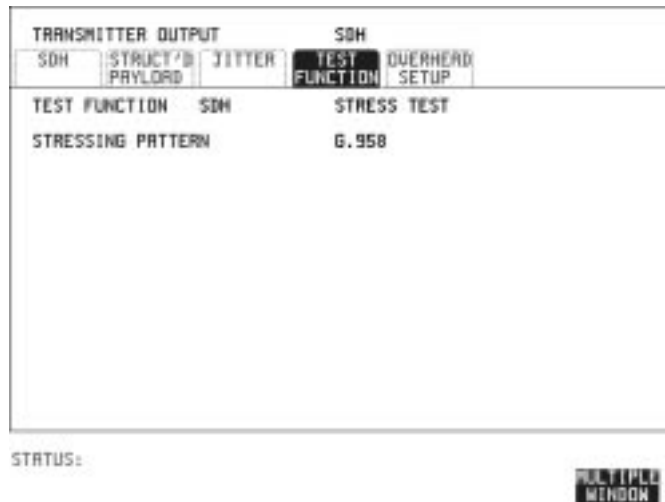

### *HOW TO:*

- 1 Set up the SDH transmit interface and payload required.  
Choose the required STRESSING PATTERN.

The G.958 test pattern consists of 4 consecutive blocks of data as follows:

ALL ONES, a PRBS, ALL ZEROS and the first row of section overhead bytes.

- 2 If you choose ALL ONES or ALL ZEROS as the stressing pattern, choose the number of bytes in the BLOCK LENGTH.



---

## Generating Automatic Protection Switch Messages

### *Description*

You can program the K1 and K2 bytes to exercise the APS functions for Both LINEAR (ITU-T G.783) and RING (ITU-T G.841) topologies.

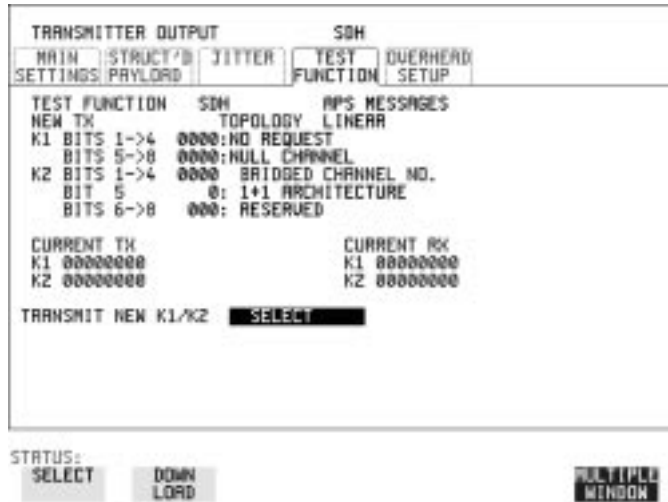

### *HOW TO:*

- 1 Set up the SDH transmit interface and payload required. See "Description" page 6.
- 2 Choose the ITU-T TOPOLOGY required.
- 3 Choose the message to be transmitted.  
If LINEAR topology is chosen, choose the CHANNEL, the BRIDGED CHANNEL NO., the ARCHITECTURE and the RESERVED bits you require.  
If RING topology is chosen, choose the DESTINATION NODE ID, the SOURCE NODE ID, the type of PATH and the status code (K2 Bits 6->8)  
The current TX and RX, K1 and K2, values are displayed for reference only.
- 4 Choose DOWNLOAD to transmit the new K1/K2 values.

## Inserting & Dropping Data Communications Channel

### *Description*

The Data Communications Channel (DCC) of the regenerator and multiplexer section overhead can be verified by protocol testing. The Insert and Drop capability provides access to the DCC via the RS-449 connector on the front panel of the SDH module.

DCC INSERT is available on the **TRANSMIT**, **SDH**, **TEST FUNCTION** display.

DCC DROP is available on the **RECEIVE**, **SDH**, **TEST FUNCTION** display.

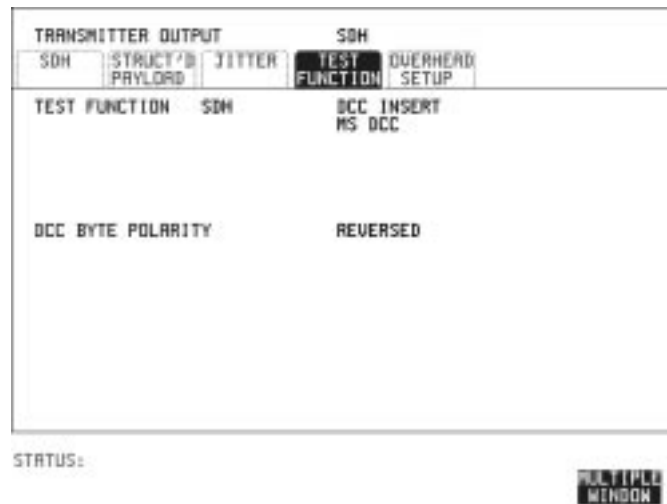

### *HOW TO:*

- 1 Connect the Protocol Analyzer to the RS449 port on the SDH Transmit module.
- 2 Choose the required DCC.  
If you choose DCC BYTE POLARITY [NORMAL], the first bit received in each byte is the first bit dropped (i.e. the most significant).  
Choice of NORMAL or REVERSED on the DCC INSERT or DCC DROP display will take effect on both.

---

**Making Measurements**

---

## Using Overhead BER Test Function

### *Description*

You can perform a Bit Error Rate test on chosen bytes of the regenerator section, multiplexer section and path overhead bytes.

You can access the transmit Overhead BER on the **TRANSMIT** **SDH** **TEST FUNCTION** display.



The screenshot shows a terminal window with the following text:

```
RECEIVER INPUT          SDH
MAIN STRUCT'D          TEST OVERHEAD
SETTINGS PAYLOAD       FUNCTION MONITOR

TEST FUNCTION SDH OVERHEAD BER
MEASURE PRBS FROM O/H BYTE RSOH E1

ERROR COUNT                4
ERROR RATIO                1.953E-06
ERROR FREE SECONDS        28
ZERO ERROR FREE SECONDS   87.500
PATTERN LOSS SECONDS      0

ELAPSED TIME              00d 00h 00m 32s
```

STATUS:

**MULTIPLE  
WINDOW**

### *HOW TO:*

- 1 Set up the SDH transmit interface and payload required.
- 2 Set up the receive SDH interface and payload as required.
- 3 Choose the overhead byte to be tested on the **RECEIVE** **SDH** **TEST FUNCTION** display.
- 4 Choose the overhead byte to be tested on the **TRANSMIT** **SDH** **TEST FUNCTION** display.
- 5 Press **RUN/STOP** to start the test.
- 6 The PRBS pattern can be errored by pressing **SINGLE**.

## Test Timing

### *Description*

There are two aspects to test timing:

Error results may be displayed as short term or cumulative over the measurement period. If short term error measurements are required, the short term period may be selected.

The period of the test may be defined or controlled manually.



### *HOW TO:*

- 1 Select the **[RESULTS]** **TIMING CONTROL** display.
- 2 Set the SHORT TERM PERIOD to the timing required for short term results.
- 3 Select the type of TEST TIMING required:  
 For manual control with **[RUN/STOP]** select **[MANUAL]**.  
 For a single timed measurement period started with **[RUN/STOP]** ,  
 select **[SINGLE]** and select the test duration.  
 For a timed period starting at a specified time, select **TIMED**, select  
 the test duration and the test **START** date and time.

---

## Making SDH Analysis Measurements

### *Description*

G.826 analysis results are provided for all relevant SDH error sources.

In addition the following results are provided:

- Cumulative error count and error ratio
- Short Term error count and error ratio
- Alarm Seconds
- Frequency
- Pointer Values
- Pointer Graph

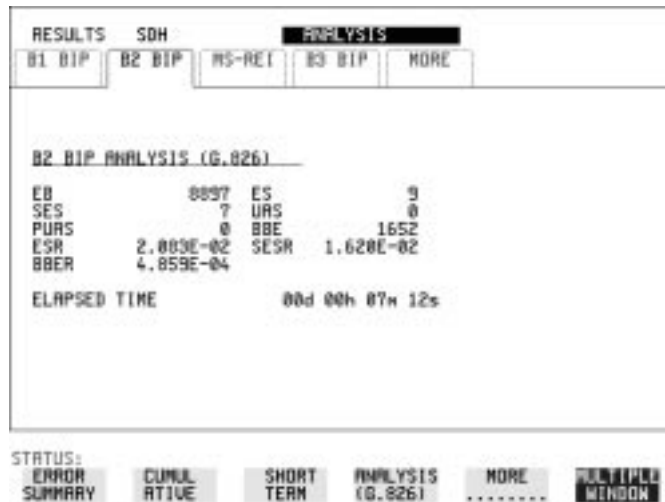

### *HOW TO:*

- 1 Set up the SDH transmit interface and payload required.
- 2 Set up the receive SDH interface and payload required.
- 3 Press **RUN/STOP** to start the measurement.
- 4 You can view the analysis results on the **RESULTS SDH ANALYSIS** display.

### *TIP:*

The measurement will not be affected if you switch between the different results provided.

---

## Making PDH Analysis Measurements

### *Description*

G.821, G.826, M.2100, M.2110 and M.2120 analysis results are provided for all relevant PDH and PDH Payload error sources.

In addition the following results are provided:

Cumulative error count and error ratio

Short Term error count and error ratio

Alarm Seconds

SIG/BIT Monitor refer to "Monitoring Signaling Bits " page 95

---

### **NOTE**

G.826, M.2100, M.2110 and M.2120 are only available if Option UKJ, Structured PDH is fitted.

---

RESULTS	PDH	ERROR ANALYSIS		
G.821	G.826	M.2100	M.2110	M.2120
FRS 140 Mb/s				
EC		0		
ES		9	4.68750%	
EFS	183		95.31250%	
SES		9	4.68750%	
UNAU		0	0.00000%	
DEB MIN		0	0.00000%	
CODE ES		N/A		
ELAPSED TIME		00d 00h 03m 12s		

STATUS:

MULTIPLE  
WINDOW

### **HOW TO:**

- 1 If SDH or SONET (option 120) is chosen as the interface, set up the Transmit Interface and Payload, and also the Receive Interface and Payload required.
- 2 If PDH is chosen as the interface, set up the PDH transmit interface, and the PDH receive interface required.
- 3 Press **RUN/STOP** to start the measurement.

## Making Measurements

### Making PDH Analysis Measurements

- 4 If SDH is chosen as the interface, you can view the analysis results on the **RESULTS** **PDH PAYLOAD** **ERROR ANALYSIS** display.

If PDH is chosen as the interface, you can view the analysis results on the **RESULTS** **PDH** **ERROR ANALYSIS** display.

***TIP:***

The measurement will not be affected if you switch between the different results provided.



## Measuring Jitter

**Description:**

PDH Jitter and PDH error measurements are made simultaneously when a PDH jitter measurement option is fitted. The measurements are made on the normal input to the PDH receiver and the interface selections are the normal PDH Receiver selections.

SDH Jitter and SDH error measurements are isolated individual measurements. The SDH jitter measurement is made on an SDH input to the Jitter module.

Cumulative and Short Term results of Jitter Amplitude and Jitter Hits are provided on the **RESULTS** **JITTER** display.

Graph and Text results for Jitter Transfer and Jitter Tolerance are also provided.

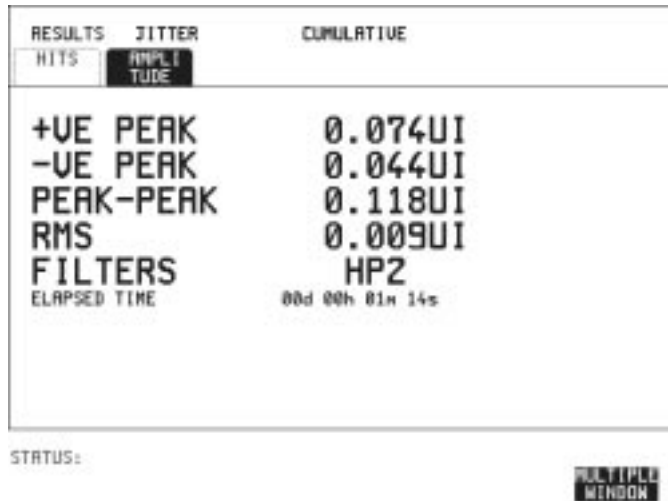

**HOW TO:**

- 1 If measuring Jitter on a PDH signal, set up the receive PDH interface for the error measurements. See “Setting PDH Receive Interface” page 19 and the receive Jitter interface for jitter range threshold and filters, see “Setting Jitter Receive Interface” page 24.
- 2 If measuring Jitter on an SDH signal, set up the receive Jitter interface. See “Setting Jitter Receive Interface” page 24.

**Measuring Jitter**

---

**NOTE**

---

For Jitter measurements on an SDH signal you need to set the Receive interface to SDH Jitter.

- 3 If performing a Jitter Tolerance measurement, see "Measuring Jitter Tolerance " page 103.  
If performing a Jitter Transfer measurement, see "Measuring Jitter Transfer " page 106.
- 4 Press **RUN/STOP** to start the measurement.
- 5 You can view the Jitter hits and Amplitude results on the **RESULTS** **JITTER** display.

---

## Measuring Wander

**Description:**

Wander measurements are possible when the received PDH interface signal is 2 Mb/s. The Wander results are displayed in bits and microseconds. Estimated Bit and Frame slips are also calculated. In addition a Bar Graph shows the cumulative Wander over the measurement period.

RECEIVER INPUT		PDH/DSn
MAIN	STRUCT'D	JITTER
SETTINGS	SETTINGS	TEST
		FUNCTION
SIGNAL FREQUENCY		2 Mb/s
RECEIVER RANGE	1.6 UI	
HIT THRESHOLD	1.00 UI	
FILTER	OFF	
ADDITIONAL RMS FILTER	12 kHz HP	
WANDER	ON	
WANDER REFERENCE	75Ω UNBAL	
WANDER REF. FORMAT	HDB3 DATA	
CONNECT 2Mb/s SOURCE to JITTER RH MODULE		

STATUS:

MULTIPLE  
WINDOW**HOW TO:****Make the Measurement**

- 1 Connect a 2 Mb/s REFERENCE (CLOCK or DATA) to the 2M REF IN port of the Jitter Receiver module.
- 2 Set up a 2 Mb/s PDH receive interface. See “Setting PDH Receive Interface” page 19.
- 3 Choose WANDER [ON].
- 4 Choose the WANDER REFERENCE impedance.  
If the 2 Mb/s Reference is connected to the 2M REF IN 75Ω port, choose 75Ω UNBAL. If connected to the 120Ω port, choose 120Ω BAL.
- 5 Choose the WANDER REF FORMAT.  
If the 2Mb/s Reference connected to the 2M REF IN port is a data signal, choose HDB3 DATA.

## Making Measurements

### Measuring Wander

6 Press **RUN/STOP** to start the measurement.

#### **HOW TO:**

#### **View the Results**

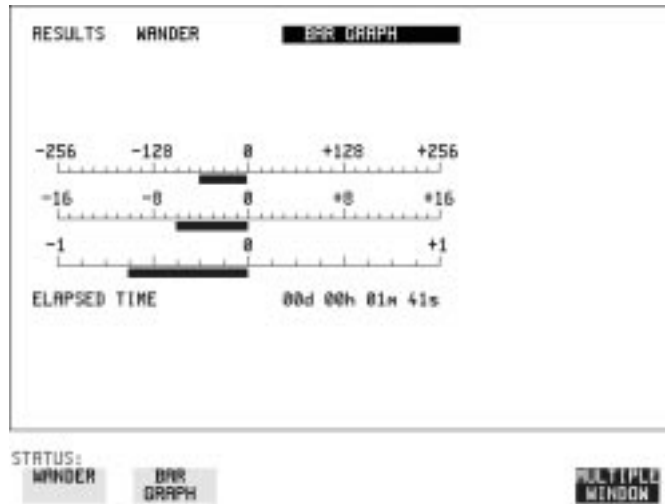

- 1 Choose the results type, WANDER or BAR GRAPH.  
If Bar Graph is chosen the cumulative wander results are displayed in graphical form. The Bar Graphs are additive and in the example shown above the Wander is -70.625 BITS.
- 2 If WANDER is chosen, choose the units in which the results are displayed.  
TIME displays the wander results in microseconds.  
BITS displays the wander results in bits.

---

#### **NOTE**

Estimated Bit Slips signify the slippage from the start of the measurement.  
One Estimated Frame Slip corresponds to 256 Bit Slips.  
Implied Frequency Offset is calculated from the Wander results.

---

---

## Measuring Frequency

### *Description*

The signal frequency and the amount of offset from ITU-T standard rate can be measured to give an indication of probability of errors.



### *HOW TO:*

- 1 Connect the signal to be measured to the IN port of the PDH module (PDH) or IN port of the SDH module (SDH electrical) or the STM-1/ STM-4 IN port of the Optical module (SDH optical).

---

### **NOTE**

The frequency measurement is always available even if the test timing is off.

---

## Measuring Optical Power

### *Description*

Optical power measurement can be performed on the SDH signal connected to the STM-1/STM-4 In port.



### *HOW TO:*

- 1 Connect the SDH optical signal to the STM-1/STM-4 IN port of the Optical module.
- 2 Choose the received input signal rate on the **RECEIVE SDH** display.
- 3 Choose the received wavelength on the **RESULTS SDH** display.

---

### **NOTE**

The optical power measurement is always available even if the test timing is off.

---

---

## Measuring Round Trip Delay

**Description:**

The time taken for voice traffic to pass through the network is very important. Excessive delay can make speech difficult to understand. The Round Trip Delay feature of the HP 37717C measures the delay in a 64 kb/s timeslot.

A test pattern is transmitted in the 64 kb/s timeslot and a timer is set running. A loopback is applied to the network equipment to return the test signal. The received pattern stops the timer and the Round Trip Delay is calculated.



---

**NOTE**

You can only measure Round Trip Delay on a 64 kb/s test signal.

**HOW TO:**

- 1 If measuring on an SDH interface, set up the SDH transmit and receive interfaces and payload required. See “Description” page 6 and “Setting SDH Receive Interface” page 22.
- 2 If measuring on a PDH interface, set up the PDH transmit and receive interfaces and payload required. See “Setting PDH Transmit Interface” page 2 and “Setting PDH Receive Interface” page 19.
- 3 Connect a loopback to the network equipment.

## Making Measurements

### Measuring Round Trip Delay

- 4 Choose ACTION [ON] to start the measurement.  
If measuring on an SDH interface, the results are available on the **RESULTS** **PDH PAYLOAD** display.  
If measuring on a PDH interface, the results are available on the **RESULTS** **PDH** display.

The Round Trip delay measurement range is up to 2 seconds. The resolution varies with the received interface signal rate:

<b>2 Mb/s</b>	1 microsecond
<b>8, 34, 140 Mb/s</b>	10 microseconds
<b>STM-1</b>	0.5 milliseconds



## Monitoring Signaling Bits

**Description**

The HP 37717C receiver can be used to monitor the state of signaling bits in received 2 Mb/s signals with timeslot-16 CAS (PCM30 or PCM30CRC) multiframing, structured or unstructured, and also in DS1 structured signals (Option 110 instruments).

The HP 37717C transmitter can be configured to generate these signals and the state of the signaling bits defined by the user, as follows:

**2.048 Mb/s Signal** When transmitting a 2.048 Mb/s signal, (or a 2.048 Mb/s signal as part of a higher rate structured signal) with timeslot-16 CAS (PCM30 or PCM30CRC) multiframing the state of A,B,C,D signaling bits can be set. The signaling bits of all timeslots are set to the user-defined 4 bit value.

**DS1 Signal (Option 110)**

When transmitting a DS1 framed, structured signal or a DS3 signal structured down to DS1, the values of the A,B signaling bits for D4 and SLC-96 payloads, and A,B,C,D signaling bits for ESF payloads can be defined. In the Transmitter signaling is only offered for a 56 kb/s or Nx56 kb/s Test Signal.

RESULTS    DS<sub>n</sub> PAYLOAD    **SIG/BIT MONITOR**

DS1 ESF ABCD BITS

TS	ABCD	TS	ABCD	TS	ABCD	TS	ABCD
1	1100	7	1111	13	1111	19	1111
2	1111	8	1111	14	1111	20	1111
3	1111	9	1111	15	1111	21	1111
4	1111	10	1111	16	1111	22	1111
5	1111	11	1111	17	1111	23	1111
6	1111	12	1111	18	1111	24	1111

STATUS:    ERROR SUMMARY    CUMUL-ATIVE    SHORT TERM    ERROR ANALYSIS    MORE .....    MULTIPLE WINDOW

## **Results Displayed**

The state of the received signaling information is displayed on the **RESULTS**, **PDH PAYLOAD**, **SIG/BIT MONITOR** page.

**Note:** To display 2 Mb/s signaling information PCM30 or PCM30CRC framing must be selected.

**Note:** To display DS1 signaling information the receiver Test Signal must be set to 64 kb/s, Nx64 kb/s, 56 kb/s or Nx56 kb/s.

### ***2.048 Mb/s Results***

For 2 Mb/s signals with timeslot-16 CAS multiframing a table showing the values of A,B,C,D signaling bits in all 30 channels is given.

### ***DS1 Results (option110)***

#### **D4 and SLC-96 payloads**

A table simultaneously showing the state of the A and B signaling bits in the 6th and 12th frames of a superframe is given. Each frame contains 24 timeslots. In SLC-96 mode A and B choices are 0, 1 or alternating. If you set bit A or B to alternate, the displayed bit changes to an A, to indicate that the bit is alternating from 1 to 0. The same signaling is transmitted in all channels.

#### **ESF Payloads**

A table simultaneously showing the state of the A, B, C and D signaling bits in the 6th, 12th, 18th and 24th frames of a superframe is given. Each frame contains 24 timeslots.

---

## Measuring Service Disruption Time

**Description:**

Protection switching ensures that data integrity is maintained and revenue protected when equipment failure occurs. The speed of operation of the protection switch can be measured.

This measurement is available in instruments with option UKJ, Structured PDH fitted or at STM-4c if option 130 or 131 is fitted, or if option 110 DSn SPDH is fitted.

The sequence of events involved in measuring the switching time is:

- Pattern Synchronization (no errors) is achieved.
- The protection switch is invoked - Pattern Synchronization is lost.
- The standby line is in place - Pattern Synchronization is regained.

The time interval between pattern sync loss and pattern sync gain is a measure of the disruption of service due to protection switching.



## Making Measurements

### Measuring Service Disruption Time

#### ***Option Differences***

Option UKJ: Service Disruption is selected on the **RESULTS** page.

Option 110: Service Disruption is selected on the **RESULTS** page except for the following configurations:

- If you select a PDH or SDH/SONET interface and an ANSI (DS1, DS3) framed, unstructured payload you must select Service Disruption on the Transmitter and Receiver TEST FUNCTION page (option 110 only). Ensure if you are using more than one instrument, that the Transmitter you set up is the one outputting the test signal to the equipment under test. The results can be viewed on the **RESULTS** display.

#### **DS1 and DS3 Operation (Option 110 instruments)**

The service disruption results are only available for Unframed, Framed and Structured configurations (but not for DS1 structured within DS3) and for all rates (including 64 kb/s and Nx 64 kb/s).

The DS-1 and DS-3 Test Pattern is set to 2E9-1 PRBS during Service Disruption measurements.

#### ***Error Burst Definition***

Error bursts start and finish with an error. Bursts of less than 10 us are ignored.

Bursts are assumed to have completed when >2000ms elapses without any errors being received.

The longest burst detected is 2 seconds.

#### ***Accuracy***

300 us for DS1 or 2Mb/s/34Mb/s signals.

60 us for DS3 signals.

#### ***HOW TO:***

- 1 Set up the PDH/SDH transmit interface and payload required.
- 2 Set up the PDH/SDH receive interface and payload as required.
- 3 Press **RUN/STOP** to start the measurement.
- 4 Invoke the protection switch.
- 5 View the results on the **RESULTS** **SRVC DISRUPT** display.

#### **Results Displayed**

**LONGEST** - Longest burst of errors during measurement.

**SHORTEST** - Shortest burst of errors during measurement.

**LAST** - Length of last burst of errors detected during measurement.

---

## Performing an SDH Tributary Scan

### *Description*

Tributary Scan tests each tributary for error free operation and no occurrence of Pattern Loss. A failure is indicated by highlighting the tributary in which the failure occurred. The **TRANSMIT** **SDH** **MAIN SETTINGS** mapping setup determines the tributary structure. The HP 37717C will configure the Transmitter to the Receiver and the PATTERN is forced to the payload it will fill.



### *Option Differences*

#### **HOW TO:**

If your instrument has option 120 fitted you can perform a tributary scan of Sonet tributaries. Use the procedure given here for SDH operation.

- 1 Set up the transmit and receive SDH interfaces and payload as required.
- 2 Choose the required BIT ERROR THRESHOLD.  
This determines the error rate above which a failure is declared.
- 3 Choose the required TEST TIMING.  
The value you choose is the test time for each individual tributary and not the total test time.  
For example, 63 TU-12 tributaries in an AU-4 - the time taken to complete the Tributary Scan will be 63 X TEST TIMING choice.
- 4 The Tributary Scan results can be viewed on the **RESULTS**

## Making Measurements

### Performing an SDH Tributary Scan

**SDH TRIBSCAN** display. The Scan can be started on the **TRANSMIT** **SDH TEST FUNCTION** display or the **RESULTS** display by choosing **START**.

If the Scan is started on the **TRANSMIT** **SDH TEST FUNCTION** display, the HP 37717C changes to the **RESULTS** display.

If a single path, for example, SIGNAL [STM-1] MAPPING AU-4 [VC-4] is chosen, then Tributary Scan is disabled.

---

#### NOTE

---

The keyboard is locked during tributary scan.

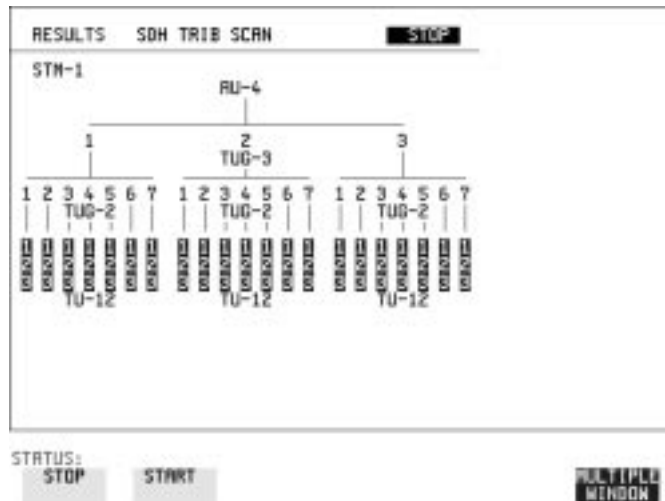

---

## Performing an SDH Alarm Scan

### *Description*

SDH Alarm Scan tests each channel for alarm free operation and identifies and indicates any Unequipped channels. You can configure the Scan to check for the occurrence of any Path layer BIP errors above a chosen threshold.

The channel in which an alarm occurred is highlighted if any of the following alarms occur:

AU-LOP, HP-RDI, AU-AIS, H4 Loss of Multiframe,  
TU-AIS, LP-RDI, TU-LOP

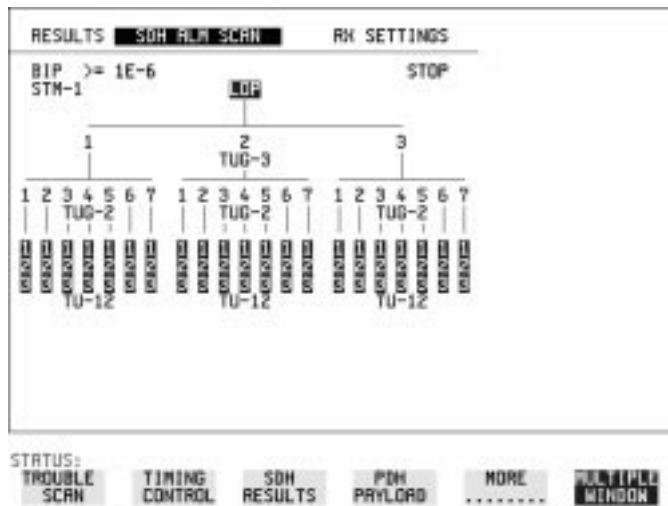

### *HOW TO:*

- 1 Set up the receive SDH interface and payload as required. See “Setting SDH Receive Interface” page 22.
- 2 Press the **RESULTS** key and select **SDH ALM SCAN**.
- 3 Choose AUTO or RX SETTINGS.  
RX SETTINGS: The scan checks the structure set on the **RECEIVE SDH** display.  
AUTO: The scan checks the structure being received. This can be particularly useful when receiving mixed payloads.
- 4 Choose the BIP error threshold.
- 5 Choose START to start the Alarm Scan.

---

## Performing a PDH/DSn Alarm Scan

### *Description*

PDH Alarm Scan tests each channel for the following alarms:  
Frame Loss  
RAI  
AIS

The channel in which an alarm occurs is highlighted.

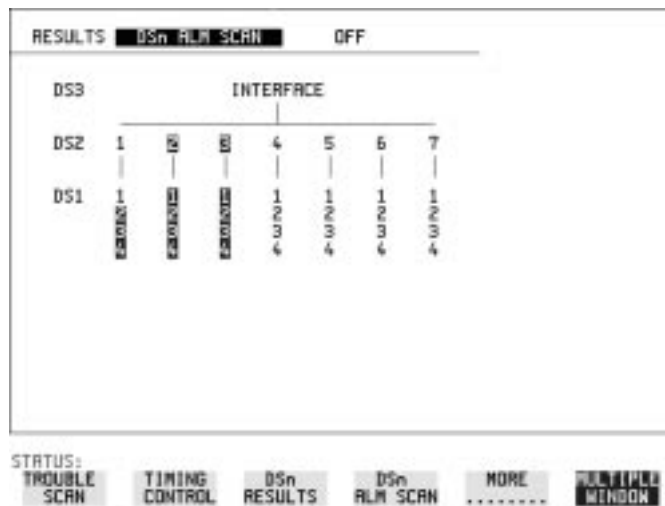

### *HOW TO:*

- 1 Set up the receive PDH interface as required. See “Setting PDH Receive Interface” page 19.
- 2 Choose ON to start the Alarm Scan.



---

## Measuring Jitter Tolerance

**Description:**

The jitter auto tolerance feature provides jitter tolerance measurements within the relevant ITU-T mask, G.823 for PDH and G.958 for SDH.

Jitter is generated at a range of frequencies within the ITU-T mask and an error measurement is made. If no errors occur (PASS), the jitter amplitude at that frequency point is increased until errors occur (FAIL) or the maximum jitter amplitude is reached. The highest jitter amplitude at which PASS occurs is plotted on the graph as the Jitter Tolerance for that jitter frequency.

**TIP:**

The transmitter and receiver can be set to different rates to allow testing across multiplexers, for example transmitter set to STM-1 with embedded 34 Mb/s and receiver set to 34 Mb/s.

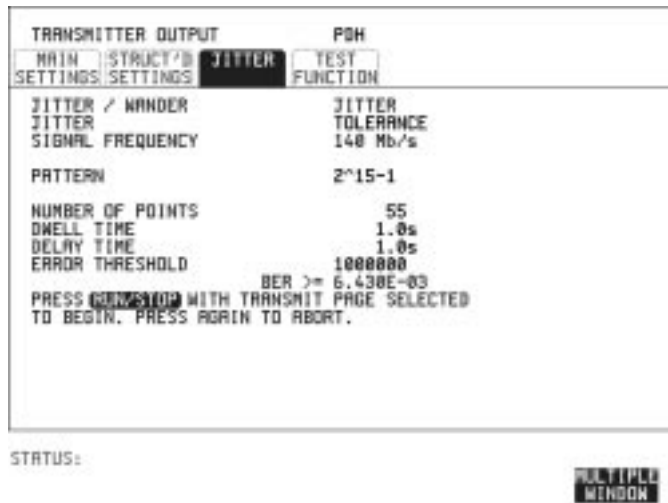

**HOW TO:**

### Make the Measurement

- 1 If you are performing jitter tolerance on the PDH signal, set up the PDH transmit and receive interfaces. See “Setting PDH Transmit Interface” page 2 and “Setting PDH Receive Interface” page 19.
- 2 If you are performing jitter tolerance on the SDH signal, set up the SDH transmit and receive interfaces. See “Description” page 6 and “Setting SDH Receive Interface” page 22.

## Making Measurements

### Measuring Jitter Tolerance

- 3 If SDH is chosen as the interface, choose the SDH MASK.  
TYPE A masks as per ITU-T G.958 have good jitter tolerance and the mask corner points are modified to compensate.  
TYPE B masks as per ITU-T G.958 have poorer jitter tolerance but a narrower jitter transfer function and the mask corner points are modified to compensate.
- 4 Choose the required test PATTERN.
- 5 Choose the NUMBER OF POINTS at which jitter is transmitted (3 to 55)
- 6 Choose the DWELL TIME - the time jitter is generated at each jitter frequency point (1 to 99.9 seconds).
- 7 Choose the DELAY TIME - the time delay between the jitter frequency/amplitude being applied and the error measurement being made. This allows the network equipment to settle as jitter frequency is changed. (0 to 99.9 seconds).
- 8 Choose the ERROR THRESHOLD.  
If ANY ERRORS is chosen, any BIP or BIT error will result in a FAIL.  
If BIT ERRORS is chosen, choose a value between 1 and 1,000,000 to determine the bit error threshold for the jitter tolerance PASS/FAIL decision.  
BER $\geq$  shows the bit error ratio calculated from the bit error threshold choice and the dwell time choice.
- 9 Press **RUN/STOP** to start the jitter auto tolerance measurement. The measurements progress can be monitored on the **TRANSMIT** display. At the end of the test the results can be viewed on the **TRANSMIT** or **RESULTS** displays. The **TRANSMIT** display is cleared when **TRANSMIT** is pressed but the results remain on the **RESULTS** display until the next jitter tolerance measurement is made.

## Making Measurements

### Measuring Jitter Tolerance

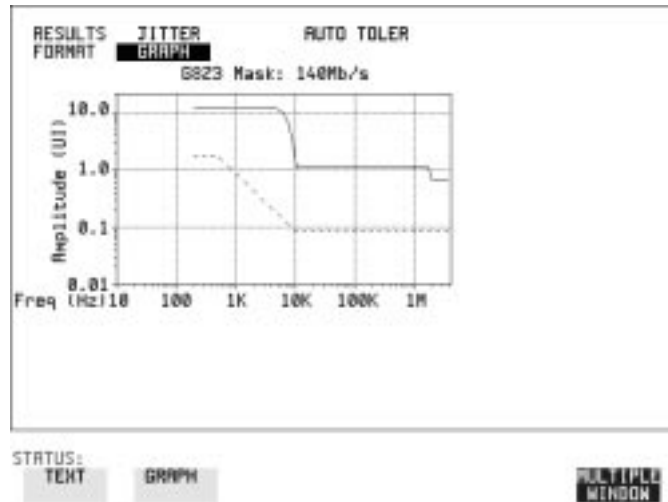

#### **HOW TO:**

#### **View the Results**

- 1 Choose the results FORMAT.

If GRAPH is chosen, a plot of the jitter tolerance results against the ITU-T mask is displayed.

If TEXT is chosen, the results from which the graph is constructed are displayed, Point number, Frequency, Mask amplitude, Tolerance, Result.

If applicable, results 13 through 55 can be viewed on pages 2 through 5.

If you wish to log the jitter tolerance results to a printer, see “Logging Jitter Tolerance Results” page 137.

## **Measuring Jitter Transfer**

***Description:***

You can perform Jitter transfer measurements at each of the four PDH rates, STM-1 and STM-4. The jitter generator provides the stimulus for the jitter transfer measurement.

Narrow band filtering is used in the jitter receiver thus allowing selection and measurement of the relevant jitter components to provide accurate and repeatable results.

The jitter transfer results are presented in graphical and tabular form. Graphical results are plotted as Gain V Frequency.

The relevant ITU-T Pass Mask (G.823 for PDH and G.958 for SDH) is also displayed on the graph.

---

**NOTE**

1. The Transmitter and Receiver must be set to the same interface rate.
2. There is no ITU-T Pass Mask for 140 Mb/s.

---

***HOW TO:***

**Achieve the required accuracy:**

- 1 The HP 37717C must be connected back to back in order to perform a calibration cycle before making a Jitter Transfer measurement.
- 2 The HP 37717C must have been switched on for 1 hour before starting a calibration cycle.
- 3 The climatic conditions must remain stable from switch-on to end of measurement.
- 4 The Jitter Transfer measurement must be started within 10 minutes of completion of the Calibration.
- 5 If maximum Delay time, maximum Dwell time and maximum number of Points is selected, the accuracy specification cannot be guaranteed as the time from start of calibration to end of measurement (test period) will be approximately two hours. It is recommended that the maximum test period does not exceed 90 minutes.  
Test Period = Delay Time + Dwell Time + 5 Seconds X Number of Points X 2 (Calibration + Measurement).

## Making Measurements

### Measuring Jitter Transfer

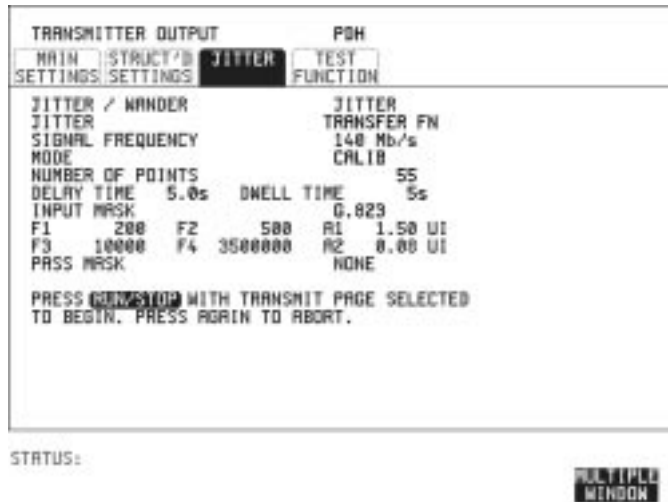

#### **HOW TO:** Perform Jitter Transfer Calibration

#### **NOTE**

The CALIBRATION should always be carried out with LEVEL [TERMINATE] selected on the **RECEIVE** JITTER display.

- 1 If PDH Jitter Transfer is required, set up the PDH transmit and receive interfaces and connect PDH IN to PDH OUT. See “Setting PDH Transmit Interface” page 2 and “Setting Jitter Receive Interface” page 24.
- 2 If STM-1 or STM-4 Optical Jitter Transfer is required, set up the SDH transmit and receive interfaces and connect STM-1/STM-4 OUT of the Optical module to STM-1/STM-4 IN of the Jitter Measurement module Option A3V [A3W] or A3N [A3P]. See “Description” page 6 and “Setting Jitter Receive Interface” page 24.

#### **CAUTION**

If **1550 nm** STM-1/4 SDH Jitter Transfer is required, a 10 dB attenuator must be connected between STM-1/4 OUT of the Optical module and STM-1/STM-4 IN of the Jitter Measurement module Option A3V [A3W] or A3N [A3P].

- 3 If STM-1 Electrical Jitter Transfer is required, set up the SDH transmit and receive interfaces and connect STM-1E OUT of the SDH

## Making Measurements

### Measuring Jitter Transfer

Module to STM-1E IN of the Jitter Measurement module Option A3L [A3M] or A3V [A3W] or A3N [A3P]. See “Description” page 6 and “Setting Jitter Receive Interface” page 24.

- 4 Choose the NUMBER OF POINTS at which jitter is transmitted (3 to 55)
- 5 Choose the DWELL TIME - the time jitter is generated at each jitter frequency point (1 to 99.9 seconds).
- 6 Choose the DELAY TIME - the time delay between the jitter frequency/amplitude being applied and the error measurement being made. This allows the network equipment to settle as jitter frequency is changed (0 to 99.9 seconds).
- 7 Choose the INPUT MASK.  
If SDH is chosen, the ITU-T G.958 mask can be Type A or Type B. TYPE A masks have good jitter tolerance and the mask corner points are modified to compensate.  
TYPE B masks have poorer jitter tolerance but a narrower jitter transfer function and the mask corner points are modified to compensate.  
If 2 Mb/s or 8 Mb/s PDH is chosen, a Q Factor choice is provided. Your Q Factor choice should match the network equipment regenerator Q Factor.  
LOW Q systems have good jitter tolerance and the mask corner points are modified to compensate.  
High Q systems have poorer jitter tolerance but a narrower jitter transfer function and the mask corner points are modified to compensate.  
If G.823 (PDH) or G.958 (SDH) is chosen the mask frequencies and amplitudes are displayed for information purposes.
- 8 If INPUT MASK [USER] is chosen, choose the mask jitter frequencies, F1, F2, F3 and F4, and mask jitter amplitudes A1 and A2.
- 9 Choose MODE [CALIB] and press **RUN/STOP** to start the calibration. The Jitter Transfer display is replaced by an information display for the duration of the Calibration.  
A bar graph showing the progress of the calibration will appear on the display.  
When the Calibration is complete, the display will revert to the **TRANSMIT** JITTER display.

## Making Measurements

### Measuring Jitter Transfer

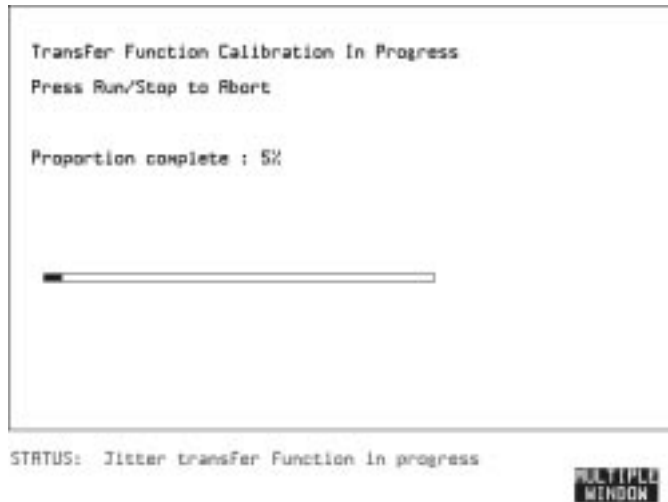

#### ***HOW TO:***

### **Start the Jitter Transfer Measurement**

#### **NOTE**

The Jitter Transfer measurement must be started within 10 minutes of the completion of calibration.

- 1 After the CALIBRATION is completed, remove the back to back connection from the PDH or SDH interfaces.  
If the measurement is to be made at a network equipment monitor point, choose LEVEL [MONITOR] on the PDH or SDH **RECEIVE** display before making the jitter transfer measurement.
- 2 Choose MODE [MEASURE] on the **TRANSMIT** JITTER display and press **RUN/STOP**.  
The measurement's progress can be monitored on the **TRANSMIT** display. At the end of the test the graph can be viewed on the **RESULTS** **JITTER** display.

## Making Measurements

### Measuring Jitter Transfer

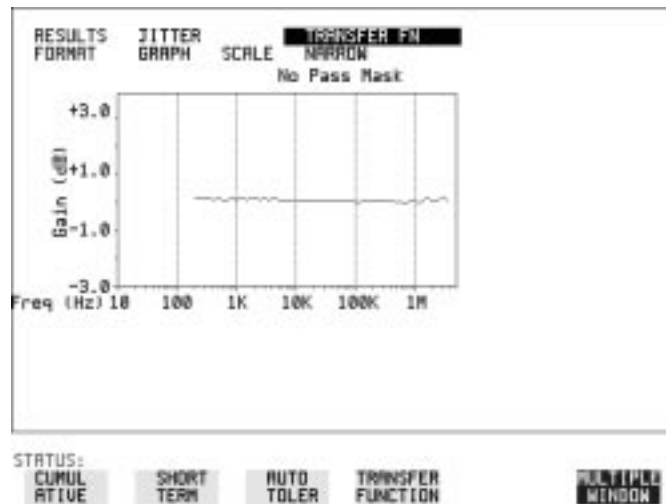

#### **HOW TO:**

#### **View the Results**

- 1** Choose the results **FORMAT**.  
If **GRAPH** is chosen, a plot of the jitter transfer results against the ITU-T mask is displayed.  
If **TEXT** is chosen, the results from which the graph is constructed are displayed: Point number, Frequency, Mask amplitude, Jitter Gain, Result.  
If applicable, results 13 through 55 can be viewed on pages 2 through 5.
- 2** If **GRAPH** is chosen, choose the **SCALE** required.  
**WIDE** provides a vertical axis range of +5 to -60 dB and is recommended for viewing the high frequency portion of the graph. This allows a clearer view of the difference between the actual result and the ITU-T pass mask.  
**NARROW** provides a vertical axis range of +3 to -3 dB and is recommended for viewing the low frequency portion of the graph. This allows a clearer view of the difference between the actual result and the ITU-T pass mask.
- 3** If you wish to log the jitter tolerance results to a printer, see “Logging Jitter Transfer Results” page 139.



---

## Selecting the ATM Measurement Parameters

### **Description**

You need to make a number of selections which define the type of test you want to make and the cell which you want to be subject of the test.

### **TIP:**

If you wish to set the HP 37717C transmitter and Receiver to the same interface settings, choose **OTHER** **SETTINGS CONTROL** **COUPLED**. This will couple common selections, for example, interface and cell payload but will **NOT** couple the cell header.

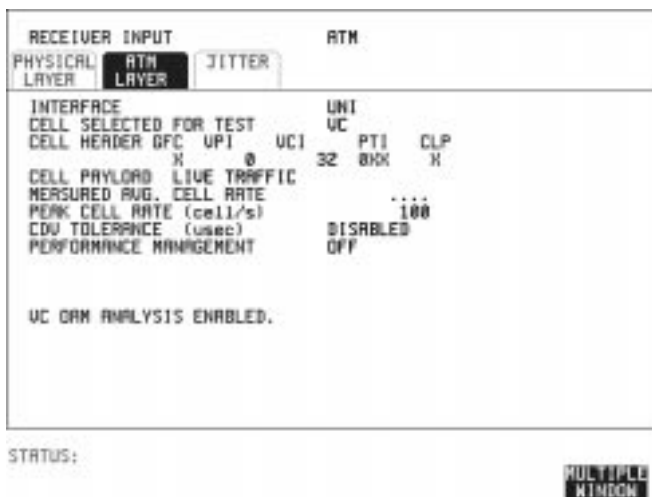

### **HOW TO:**

- 1 Select the signaling INTERFACE: User Network Interface **UNI** Typically used between a user and a switch in the public network, or Network Node Interface **NNI** typically used between switches in the public network.
- 2 Select how the cell stream to be tested is defined by setting CELL SELECTED FOR TEST.  
To specify by header VPI, select **VP**.  
To specify by header VPI and VCI, select **VC**.  
To specify by all of the header, select **EXPERT MODE**.  
In addition to these choices you can select **ALL USER CELLS**, **UNASSIGNED CELLS** or **IDLE CELLS**.  
For OAM analysis, select **VP** for the VP OAM or **VC** for the VC OAM.  
Selection of **SEGMENT** or **END TO END** PERFORMANCE.

## Selecting the ATM Measurement Parameters

MANAGEMENT is available for MEASUREMENT MODE **IN SERVICE** measurements when **VP** or **VC** is chosen.

- 3 Specify the CELL HEADER parameters for the test. The selections available will depend on type of CELL SELECTED FOR TEST.
- 4 Specify the CELL PAYLOAD. If the receiver and transmitter settings are coupled, see “Coupling Transmit and Receive Settings” page 172, the receiver setting will automatically be set to the transmitted setting. **LIVE TRAFFIC** allows In-Service testing at the ATM layer.
- 5 If the CELL SELECTED FOR TEST is set to **VP**, **VC**, **EXPERT MODE** or **ALL USER CELLS**, select the PEAK CELL RATE and CDV TOLERANCE for the test.
- 6 If OAM analysis is required, set PERFORMANCE MANAGEMENT to **SEGMENT** or **END-TO-END** for Cell Loss, Cell Misinsertion and BEDC BIP-16 measurements on the performance management OAM.
- 7 If PERFORMANCE MANAGEMENT is set to **SEGMENT** or **END-TO-END**, enter the OAM block size. If this is unknown, select 1024 (maximum available). Selecting a block size smaller than that in use may cause PM OAM LOSS. If the OAM cells selected are not present, a status message “PM OAM LOSS alarm” will appear on the display.

---

## Making ATM Measurements

### *Description*

Received cells, non conforming cells, HEC errors and 1pt Cell Delay Variation are measured in-service and out-of -service. Lost cells, misinserted cells, payload errors and 2pt Cell Delay Variation are measured out-of -service. If you are measuring 2-point CDV the foreground payload must be the test cell.



- 1 Set up the **RECEIVE** **ATM** PHYSICAL LAYER interface, see.
- 2 Select **RECEIVE** **ATM** ATM LAYER, see page 111.
- 3 If SHORT TERM results are required, use **RESULTS** **TIMING CONTROL** to select the short term period.
- 4 You can view the ATM results on the **RESULTS** **ATM** **CUMULATIVE** or **SHORT TERM** display.

---

### NOTE

The measurement will not be affected if you switch between the different results provided.

---

---

## Measuring Cell Transfer Delay and Cell Delay Variation

### *Description*

Cell transfer delay may occur because of physical layer switching and propagation delay over long transmission paths. At the ATM layer, queuing and cell multiplexing may cause additional and varying delay (CDV). CDV is accentuated when a virtual circuit is multiplexed with a highly variable traffic load or when congestion is approached in ATM switches. Delay may also be caused by traffic shaping.

Cell transfer delay and CDV should not affect data transfer applications but will affect audio and video services. For telephony and videoconferencing, the round trip delay may make communication difficult. Constant Bit Rate services require the CDV to be controlled to minimize the depth of reconstruction buffers and to minimize jitter in the service clock recovery at the receive end

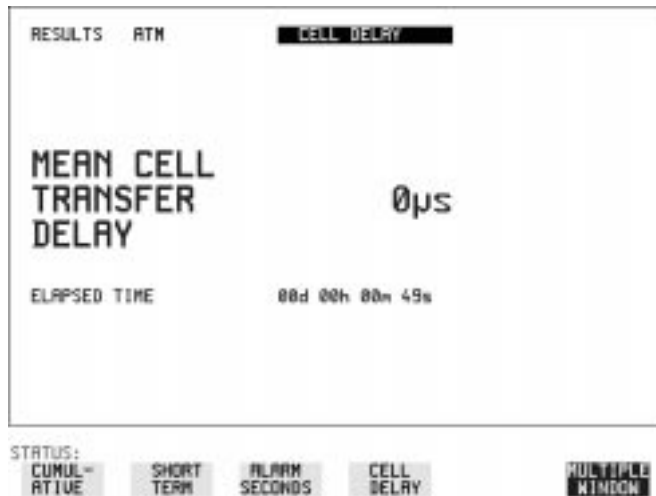

### *HOW TO:*

- 1 Set up the **RECEIVE** **ATM** PHYSICAL LAYER interface, see “Selecting the Physical Receive Interface for ATM payloads” page 26.
- 2 Set up the **RECEIVE** **ATM** ATM LAYER see page 111. The **CELL PAYLOAD** must be the test cell.
- 3 Press **RUN/STOP** to start a test.

## Making Measurements

### Measuring Cell Transfer Delay and Cell Delay Variation

- 4 You can view the CDV results on the **RESULTS** **ATM** **CELL DELAY** display.

## **Measuring ATM Non-Conforming cells and one-point Cell Delay Variation.**

### ***Description***

ATM policing is performed using the Generic Cell Rate Algorithm (GCRA). The HP 37717C can perform a single GCRA policing test using the Peak Cell Rate and CDV tolerance parameters. Any cell received that does not conform to the GCRA test is measured as a non-conforming cell. If no non-conforming cells are measured, the Maximum 1-point Cell delay Variation (CDV) measurement tells you what margin of error there is. When the 1-point CDV equals the CDV tolerance, a non-conforming cell is measured. If you select CDV Tolerance DISABLED, no non-conforming cells are recorded and the maximum 1-point CDV result is the minimum value of CDV Tolerance required to ensure cell conformance.

### ***HOW TO:***

- 1 Configure the receiver for ATM measurements. See "Selecting the ATM Measurement Parameters " page 111.
- 2 Select the PEAK CELL RATE and CDV TOLERANCE for the test.

### ***TIP:***

If you are unsure of the PEAK CELL RATE to choose, run a short test first. The MEASURED AVG. CELL RATE shows the average cell rate during the test. This is the minimum suitable value for the PEAK CELL RATE. If you select AVERAGE as the PEAK CELL RATE, the measured average value is automatically entered. The test must be stopped before the AVERAGE can be entered.

- 3 Press **RUN/STOP** to start a test.
- 4 You can view the NON-CONFORMING CELL COUNT and MAX 1-PT CDV results on the **RESULTS** **ATM** **CUMULATIVE** or **SHORT TERM** display. MAX 1-PT CDV is only available as a CUMULATIVE result.

## Monitoring ATM Alarms

### Description

There are two indications of ATM alarm conditions, The duration of alarms during a test is shown on the alarm seconds results display and any existing alarms are shown by the front panel LED alarm indicators.

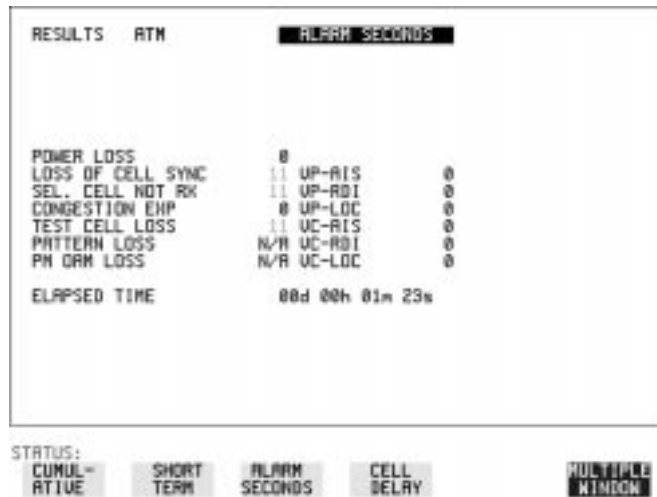

- |  |                                      |     |
|--|--------------------------------------|-----|
| <input type="radio"/> LOS                  | <input type="radio"/> LOF/OOF        | SDH |
| <input type="radio"/> PATTERN LOSS         | <input type="radio"/> AU-LOP/TU-LOP  |     |
| <input type="radio"/> ERRORS               | <input type="radio"/> MS-AIS         |     |
| <input type="radio"/> AIS                  | <input type="radio"/> AU-AIS         | PDH |
| <input type="radio"/> LOF                  | <input type="radio"/> CLOCK LOSS     |     |
| <input type="radio"/> M/F LOSS             | <input type="radio"/> MS-RDI         |     |
| <input type="radio"/> REMOTE ALARM         | <input type="radio"/> HP-RDI         |     |
| <input type="radio"/> REMOTE M/F ALARM     | <input type="radio"/> TU-AIS         |     |
| <input type="radio"/> VP ALARM             | <input type="radio"/> LP-RDI         | ATM |
| <input type="radio"/> VC ALARM             | <input type="radio"/> POINTER ADJUST |     |
| <input type="radio"/> LOSS OF CELL SYNC    |                                      |     |
| <input type="radio"/> SELECTED CELL NOT RX |                                      |     |
| <input type="radio"/> JITTER UNLOCK        |                                      |     |
| <input type="radio"/> JITTER HITS          |                                      |     |

Making Measurements  
**Monitoring ATM Alarms**



---

**Storing, Logging and Printing**

---

## Saving Graphics Results to Instrument Store

### *Description*

Graphical representation of measurement results is very useful particularly during a long measurement period. It provides an overview of the results and can be printed for record keeping.

Graphics results can be stored in instrument graph storage or on floppy disk.

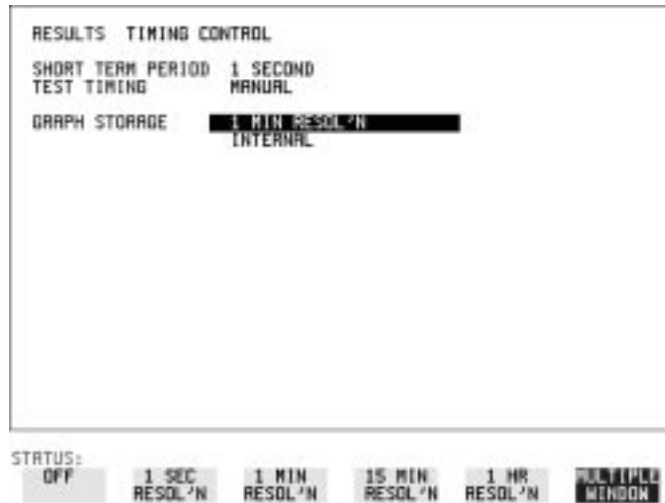

### *HOW TO:*

- 1 Before starting your measurement, choose the GRAPH STORAGE resolution and location.  
The resolution chosen affects the ZOOM capability when viewing the bar graphs. If 1 MIN is selected, 1 MIN/BAR, 15 MINS/BAR and 60 MINS/BAR are available. If 15 MINS is selected, 15 MINS/BAR and 60 MINS/BAR are available. If 1 HOUR is selected, 60 MINS/BAR is available.  
The graphics results can be stored in the instrument - INTERNAL or stored on DISK. Storage to disk will use a default file name unless a file name is specified on the **OTHER FLOPPY DISK** display. See "Saving Graphics Results to Disk" page 157.
- 2 Press **RUN/STOP** to start the measurement. Graphical results will be stored in the chosen location.

---

## Recalling Stored Graph Results

### *Description*

Results stored from a previous measurement can be recalled to the graphics displays for viewing and printing.

STORE	START DATE	START TIME	TEST DURATION	STORE USE
DISK				
-9				
-8				
-7				
-6				
-5				
-4				
-3				
-2	10-JUL-1997	15:28	16h 28m 34s	22
-1	11-JUL-1997	07:50	00h 01m 04s	<12
LAST	12-JUL-1997	07:51	00h 01m 19s	Nil
STORAGE 1 SEC			TOTAL	USED
RESOL'N COMPRESSED			RAM	FREE
FREE STORE 19626 EVENTS				22
				982

STATUS:  
GRAPH RESULTS    TEXT RESULTS    DELETE STORE    DELETE ALL    MULTIPLE WINDOW

### *HOW TO:*



- 1 If currently viewing the bar graph display, select **TEXT RESULTS** then **STORE STATUS**. If currently viewing the error or alarm summary, select **STORE STATUS**.
- 2 Using **↑** and **↓**, move the highlighted cursor to the store location which contains the required results.  
If the required results are stored on Disk, move the highlighted cursor to DISK and choose RECALL GRAPHICS on the FLOPPY DISK display. See "Recalling Graphics Results from Disk" page 161.
- 3 Choose **GRAPH RESULTS** if you wish to view the bar graphs. The display will change to the bar graph display of the highlighted results.
- 4 Choose **TEXT RESULTS** if you wish to view the error and alarm Summaries. The display will change to the text results display of the highlighted results.  
**DELETE STORE** deletes the results in the highlighted store.

## Storing, Logging and Printing

### Recalling Stored Graph Results

If **DELETE ALL** is chosen, a **CONFIRM DELETE** ; **ABORT DELETE** choice is provided to prevent accidental deletion of all the stored results.

The top row of the display comprises five fields:

<b>Store</b>	Memory location in which the displayed bar graph data is stored. Move the highlighted cursor, to the STORE location desired, using  and  .
<b>Start Date</b>	The start date of the test, which produced the stored results.
<b>Start Time</b>	The start time of the test, which produced the stored results.
<b>Test Duration</b>	The duration of the test, which produced the stored results.
<b>Store Use</b>	The percentage (%) of the overall storage capacity occupied by each set of stored results. The TOTAL percentage used and the percentage still FREE is provided at the bottom of the STORE USE column.

---

## Viewing the Bar Graph Display

### *Description*

All the graphic results obtained during the measurement are available for viewing. Identify a period of interest and zoom in for more detailed examination.

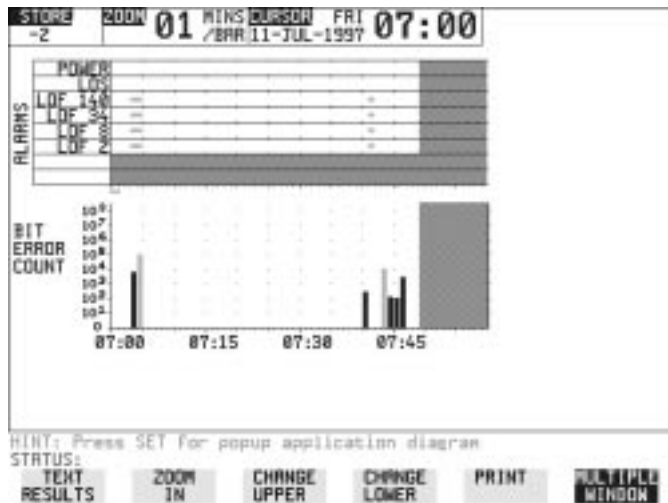



### *HOW TO:*

- 1 To view the current bar graphs, press **GRAPH** and use **CHANGE UPPER** and **CHANGE LOWER** to obtain the bar graphs required.
- 2 To view previously stored graphs, see "Recalling Stored Graph Results " page 121.
- 3 For more detailed inspection of the bar graph, position the cursor centrally within the area of interest using **→**, **←** and select **ZOOM IN** to reduce the time axis to 15 MINS/BAR. This is only possible if the graphics results were stored with a STORAGE resolution of 1 SEC,1 MINS or 15 MINS.  
For further reduction of the time axis to 01 MINS/BAR or 01 SECS/ BAR, position the cursor centrally within the area of interest and select **ZOOM IN** until the required time axis is obtained.

Storing, Logging and Printing  
**Viewing the Bar Graph Display**

The top row of the display comprises three fields:

- Store** Memory location in which the displayed bar graph data is stored. Store can only be changed when the status of stored results is displayed. See "Recalling Stored Graph Results " page 121.
- Zoom** The width, in minutes, of each "bar" in the bar graph, controlled by **ZOOM IN** / **ZOOM OUT**.
- Cursor** The cursor position in terms of time and date, controlled by  and . The cursor position changes in steps of 1 second, 1 minute, 15 minutes or 60 minutes dependent upon the ZOOM setting. The cursor is physically located between the two graphs.

---

## Viewing the Graphics Error and Alarm Summaries

### *Description*

The error and alarm summaries of the measurement chosen are displayed on the **TEXT RESULTS** display. The error summary or alarm summary can be viewed at any time.

	COUNT	RATIO
BIT	546	1.499E-04
CODE	123652	6.381E-05
FAS 140M	N/A	N/A
FAS 34M	1103	8.664E-05
FAS 8M	0	0
FAS 2M	0	0
CRC	N/A	N/A
REBE	N/A	N/A

STATUS: STORE STATUS GRAPH RESULTS PRINT NEXT SUMMARY ALARM SUMMARY MULTIPLE WINDOW

### *HOW TO:*

- 1 To view the error or alarm summary associated with the current bar graphs, press **GRAPH** then **TEXT RESULTS**
- 2 To view the error or alarm summary associated with previously stored bar graphs, see "Recalling Stored Graph Results " page 121.
- 3 To view the Alarms which have occurred during the measurement, select **ALARM SUMMARY**. Use **NEXT SUMMARY** to view the PDH; JITTER; ATM and SDH Alarm Summaries in turn if applicable.
- 4 To view the Errors which have occurred during the measurement select **ERROR SUMMARY**. Use **NEXT SUMMARY** to view the PDH; JITTER; ATM and SDH Error Summaries in turn if applicable.  
The top row of the display comprises three fields:

**Store** Memory location in which the bar graphs, error summary and alarm summary are stored.

**Viewing the Graphics Error and Alarm Summaries**

Store can only be changed when the status of stored results is displayed. See "Recalling Stored Graph Results " page 121.

**Start** The start time and date of the test, that produced the displayed results.

**Stop** The stop time and date of the test, that produced the displayed results.



---

## Logging Graph Displays

### *Description*

If Option A3B or Option A3D, Remote Control, is fitted, the bar graphs and error and alarm summary can be logged to an external HP DeskJet printer at the end of the test period. If a printer is not immediately available, the graphics results remain in memory and can be logged at a later time when a printer becomes available.

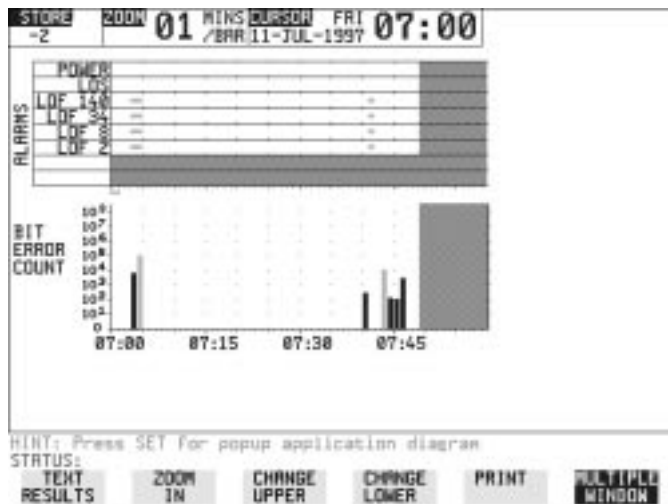

### *HOW TO:*

- 1 Connect an external RS-232-C HP DeskJet printer to the HP 37717C RS232 port. See "Logging Results to RS-232-C Printer" page 134 or connect an external HP-IB HP DeskJet printer to the HP 37717C HP-IB port. See "Logging Results to HP-IB Printer" page 132 or connect a Parallel DeskJet printer to the HP 37717C Parallel port. See "Logging Results to Parallel (Centronics) Printer" page 131.
- 2 Make the required selections on the **OTHER** **LOGGING** display: LOGGING PORT [HPIB] or [RS232] or [PARALLEL] and LOGGING [ON].
- 3 To log the Error and Alarm summaries, the displayed Bar graphs and the Alarm graph to the printer, choose **PRINT** on the bar graph display. To log the selected Error and Alarm summaries to the printer, choose **PRINT** on the Text Results display.

## Logging Results

### *Description*

### **Test Period Logging**

If degradations in system performance can be observed at an early stage, then the appropriate remedial action can be taken to maximize circuit availability and avoid system crashes. Test period logging allows you to monitor the error performance of your circuit. At the end of the test period the selected results are logged. Results can be logged at regular intervals during the test period by selecting a LOGGING PERIOD of shorter duration than the test period. An instant summary of the results can be demanded by pressing **PRINT NOW** without affecting the test in progress.

### **Error Event Logging**

Manual tracing of intermittent faults is time consuming. Error event logging allows you to carry out unattended long term monitoring of the circuit. Each occurrence of the selected error event is logged.

The results obtained during the test are retained in memory until they are overwritten by the next set of results. The results can be logged at any time during the test period and at the end of the test period. The results required are selected using **OTHER LOGGING LOGGING SETUP CONTROL**.

Any Alarm occurrence results in a timed and dated message being logged.

BER and Analysis results can be selected by the user.

Cumulative and Period versions of the results are calculated and can be selected by the user.

**Period**            The results obtained over a set period of time during the test. The Period is defined by the LOGGING PERIOD selection.

**Cumulative**      The results obtained over the time elapsed since the start of the test.

## Logging Results

The results can be logged to the following devices, selectable using **OTHER** **LOGGING** LOGGING SETUP **DEVICE**:

- Optional Internal printer fitted into the instrument front cover (Option UKX)
- External HP-IB printer (options A3B & A3D)
- External RS-232-C printer (options A3B & A3D)
- External Parallel Port printer (options A3B & A3D)
- Disk Drive

FUNCTION	LOGGING
LOGGING SETUP	CONTROL
LOGGING PERIOD	ON
RESULTS LOGGED WHEN CONTENT	USER PROGRAM 10 MINS SELECTED PERIOD EC>0 ER & ANAL PER & CUMUL
LOG ERROR SECONDS	ON
LOG AT END OF TEST	ALL RESULTS
LOG ON DEMAND	RESULTS

STATUS: STORED SETTINGS FLOPPY LOGGING MORE MULTIPLE WINDOW

### **HOW TO:**

- 1 Choose LOGGING [ON] - enables the logging of results and alarms.
- 2 Choose LOGGING PERIOD - determines how regularly the results and alarms are logged.  
USER PROGRAM provides a choice of 1 second to 99 days.
- 3 Choose RESULT LOGGED - allows you to log ALL results to or choose only those results you require.
- 4 Choose WHEN - allows you to choose to only log when the error count for the logging period is greater than 0. If the error count is 0 then the message NO BIT ERRORS is displayed.

## Storing, Logging and Printing

### Logging Results

- 5 Choose CONTENT - allows you a choice of error results to be logged. Error Results, Analysis or Error and Analysis (ER & ANAL) and Period, Cumulative or Period and Cumulative (PER & CUMUL). If LOG ERROR SECONDS [ON] is chosen a timed and dated message is logged.
- 6 Choose LOG ON DEMAND allows you a choice of RESULTS SNAPSHOT, OVERHEAD SNAPSHOT, OVERHEAD CAPTURE, POINTER GRAPH or SDH TRIBUTARY SCAN to be logged when **PRINT NOW** is pressed. If Option UKX, Internal Printer, is fitted, **SCREEN DUMP** is added to the menu. This allows you to log any selected display when **PRINT NOW** is pressed.
- 7 Choose the logging DEVICE.  
If RS232 is chosen, see "Logging Results to RS-232-C Printer " page 134.  
If HPIB is chosen, see "Logging Results to HP-IB Printer " page 132.  
If PARALLEL is chosen, see "Logging Results to Parallel (Centronics) Printer " page 131.  
If DISK is chosen, see "Saving Data Logging to Disk" page 159.  
If Option UKX, Internal Printer, is fitted and INTERNAL is chosen, see "Logging Results to Internal Printer " page 133.

## Logging Results to Parallel (Centronics) Printer

### *Description*

If Option A3B or A3D, Remote Control Interface, is fitted, you can log the results and alarms to an external Parallel printer connected to the PARALLEL port. The Parallel port provides a standard IEEE 1284-A compatible interface.



---

### **CAUTION**

---

Damage to the instrument may result if a serial connection is made to this port.

### **HOW TO:**

- 1 Connect the Parallel printer to the PARALLEL port. See "Connecting an HP DeskJet Printer to a Parallel Port " page 136.
- 2 If a non HP printer is connected choose ALT PRINTER.  
Choose 80 character column width (NORMAL) or 40 character column width (COMPRESS) according to the capabilities of your printer.
- 3 Choose the LOGGING SETUP [CONTROL] settings. See "Logging Results " page 128.

## Logging Results to HP-IB Printer

### *Description*

If Option A3B or A3D, Remote Control Interface, is fitted, you can log the results and alarms to an external HP-IB printer connected to the HP-IB port.



### *HOW TO:*

- 1 Connect an HP-IB printer to the HPIB port.

---

### **NOTE**

---

Choosing HP-IB external printer for logging prevents the use of HP-IB remote control.

- 2 Choose the LOGGING SETUP [CONTROL] settings. See "Logging Results " page 128.

## Logging Results to Internal Printer

### *Description*

If Option UKX, Internal Printer is fitted, you can log the results and alarms to the in-lid printer.

FUNCTION	[ LOGGING ]
LOGGING SETUP	[ DEVICE ]
LOGGING PORT	[ INTERNAL ]
REMOTE CONTROL PORT	HPIB

STATUS:  
INTERNAL   RS232   HPIB   DISK   PARALLEL   MULTIPLE WINDOW

### *HOW TO:*

- 1 Choose the LOGGING SETUP [CONTROL] settings. See "Logging Results " page 128.

---

## Logging Results to RS-232-C Printer

### *Description*

If Option A3B or A3D, Remote Control Interface, is fitted, you can log the results and alarms to an external RS-232-C printer connected to the RS232 port.

FUNCTION	LOGGING
LOGGING SETUP	DEVICE
LOGGING PORT	RS232
REMOTE CONTROL PORT	LAN
PRINTER TYPE	ALT. PRINTER
MODE	NORMAL
SPEED	9600 BAUD
PROTOCOL	ON/OFF

STATUS: RS232 HP1B DISK PARALLEL MULTIPLE WINDOW

### *HOW TO:*

- 1 Connect an RS-232-C printer to the RS232 port.

---

### **NOTE**

Choosing RS232 external printer for logging prevents the use of RS-232-C remote control.

- 2 If a non HP printer is connected choose ALT PRINTER.  
Choose 80 character column width (NORMAL) or 40 character column width (COMPRESS) according to the capabilities of your printer.
- 3 Choose the LOGGING SETUP [CONTROL] settings. See "Logging Results " page 128.



## Printing Results from Disk

***Description***

The results and alarms you logged to Disk can be printed by removing the Disk from the HP 37717C and inserting it into a personal computer (PC).

***HOW TO:***

**Print from DOS Prompt**

*copy/b a:\<filename> <printer name>*

***HOW TO:***

**Print from Windows**

- 1 Choose the required file from Filemanager.
- 2 Choose FILE - COPY FILE TO  
*<printer name>*

## Connecting an HP DeskJet Printer to a Parallel Port

***Description***

If Remote Control Option, A3B or A3D, is fitted, the HP 37717C has the capability of interfacing with an HP DeskJet printer or, an alternative suppliers printer, via the PARALLEL port.

---

**CAUTION**

---

Do not connect a serial printer e.g. RS-232-C or HPIB to the HP 37717C Parallel port as this will damage the interface.

***HOW TO:***

Connect the HP 37717C Parallel port to the HP DeskJet Parallel port using printer cable HP part number 24542D.

---

## Logging Jitter Tolerance Results

### ***Description***

The jitter auto tolerance feature provides jitter tolerance measurements within the relevant ITU-T mask, G.823 for PDH and G.958 for SDH.

You can log the jitter auto tolerance results to a printer for record keeping purposes. If remote control option A3B or A3D is fitted, the GRAPH version or the TEXT version of the jitter tolerance results can be logged to an external printer.

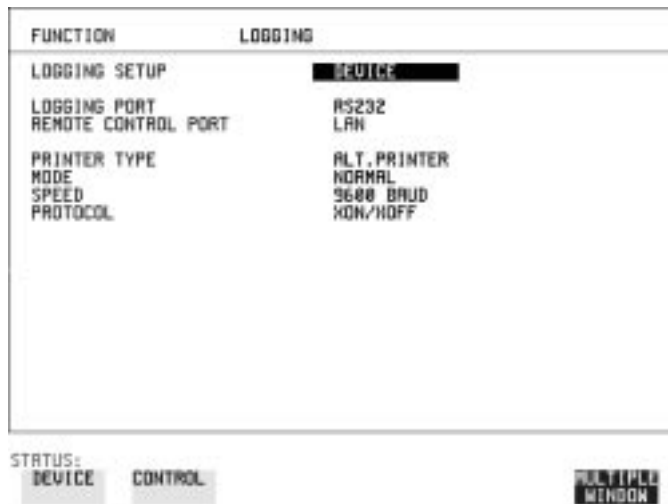

### ***HOW TO:***

- 1 If logging to a Parallel Port (Centronics) printer, connect the printer to the PARALLEL port. See "Connecting an HP DeskJet Printer to a Parallel Port " page 136.
- 2 If a non-HP printer is connected choose ALT PRINTER.
- 3 Choose 80 character column width (NORMAL) or 40 character column width (COMPRESS) according to the capabilities of your printer.
- 4 If logging to an HP-IB printer, connect an HP-IB printer to the HPIB port. See "Logging Results to HP-IB Printer " page 132.
- 5 If logging to an RS-232-C printer, connect an RS-232-C printer to the RS232 port. See "Logging Results to RS-232-C Printer " page 134.
- 6 If a non HP printer is connected, choose ALT PRINTER.

Storing, Logging and Printing  
**Logging Jitter Tolerance Results**

- 7 Choose 80 character column width (NORMAL) or 40 character column width (COMPRESS) according to the capabilities of your printer.
- 8 Choose the same baud SPEED as chosen on your printer.
- 9 Choose the PROTOCOL required for the transfer of logging data.
- 10 Choose LOGGING [ON] on the LOGGING SETUP [CONTROL] display.
- 11 Choose GRAPH on the **RESULTS** **AUTO TOLER** display if you wish to log the graph to the printer.  
Choose TEXT and the PAGE number on the **RESULTS** **AUTO TOLER** display if you wish to log the text results to the printer.
- 12 Press **PRINT NOW** to log the chosen results to the printer.

---

## Logging Jitter Transfer Results

### *Description*

The jitter transfer feature provides jitter transfer measurements within the relevant ITU-T mask, G.823 for SDH and G.958 for SDH.

You can log the jitter transfer results to a printer for record keeping purposes. If remote control option A3B or A3D is fitted, the GRAPH version or the TEXT version of the jitter transfer results can be logged to an external printer.



### *HOW TO:*

- 1 If logging to a Parallel Port (Centronics) printer, connect the printer to the PARALLEL port. See "Connecting an HP DeskJet Printer to a Parallel Port " page 136.
- 2 If a non-HP printer is connected, choose ALT PRINTER.
- 3 Choose 80 character column width (NORMAL) or 40 character column width (COMPRESS) according to the capabilities of your printer.
- 4 If logging to an HP-IB printer, connect an HP-IB printer to the HPIB port. See "Logging Results to HP-IB Printer " page 132.
- 5 If logging to an RS-232-C printer, connect an RS-232-C printer to the RS232 port. See "Logging Results to RS-232-C Printer " page 134.
- 6 If a non HP printer is connected, choose ALT PRINTER.

Storing, Logging and Printing  
**Logging Jitter Transfer Results**

- 7 Choose 80 character column width (NORMAL) or 40 character column width (COMPRESS) according to the capabilities of your printer.
- 8 Choose the same baud SPEED as chosen on your printer.
- 9 Choose the PROTOCOL required for the transfer of logging data.
- 10 Choose LOGGING [ON] on the LOGGING SETUP [CONTROL] display.
- 11 Choose GRAPH and SCALE on the **RESULTS** **JITTER** **TN FUNCTION** display if you wish to log the graph to the printer.  
Choose TEXT and the PAGE number on the **RESULTS** **JITTER** **TN FUNCTION** display if you wish to log the text results to the printer.
- 12 Press **PRINT NOW** to log the chosen results to the printer.

---

## Changing Internal Printer Paper

### *Description*

The printer accepts rolls of thermal paper with the following dimensions:

**Width:** 216 mm (8.5 in) or 210 mm (8.27 in)  
(A4) tolerance +2.0 mm - 1.0 mm

**Maximum Outside Diameter:** 40 mm

**Inside Core Diameter:** Between 12.5 mm and 13.2 mm

Suitable rolls of paper are available from Hewlett Packard, Part Number 9270-1360.

---

### **WARNING**

**The paper tear-off edge is SHARP. This edge is exposed when the printer cover is raised. Note the  CAUTION SHARP EDGE label on the cover.**

---

### **HOW TO:**

- 1 Raise the two locking tabs on the sides of the printer cover and then raise the cover.
- 2 Raise the printer mechanism front cover. This releases the paper drive. Remove any remaining paper from the front (in the normal direction of operation).

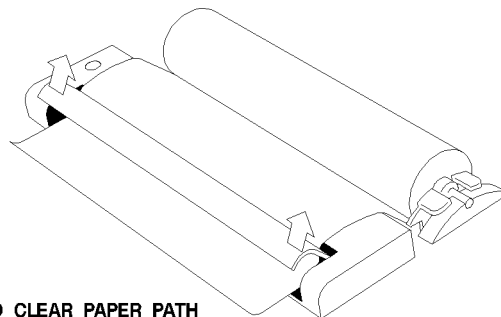

- 3 Lift out the spindle. Adjust the paper width adaptor to the width of the paper being used.

Storing, Logging and Printing  
**Changing Internal Printer Paper**

- Put the paper roll on the spindle such that the sensitive side will be on the underside of the print mechanism. Ensure that the relocation of the spindle locks the blue width adaptor in position.

---

**NOTE**

The paper must be installed such that when it is in the print mechanism, the sensitive side (slightly shiny) is the underside. The illustrations here show the correct fitting for HP 9270-1360 paper which has the sensitive side on the outside of the roll.

---

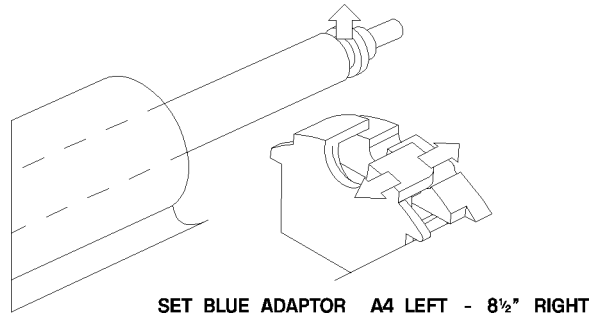

- Feed the paper into the upper entry of the print mechanism. When the front cover of the print mechanism is closed, the printer should automatically feed the paper through until there is approximately 2.5 cm (1 in) clear at the front of the print mechanism.

Align paper with the leftmost edge of the printer mechanism slot

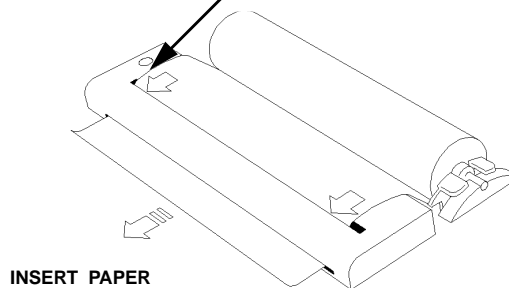

---

**CAUTION**

Do not close the outer cover until the automatic paper feed is complete.

---



Storing, Logging and Printing  
**Changing Internal Printer Paper**

- 6 If the printer paper is incorrectly aligned, raise the printer mechanism front cover to releases the paper drive and realign the paper.

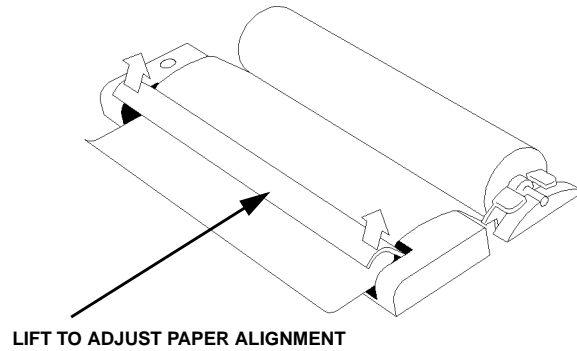

## Cleaning Internal Printer Print Head

### *Description*

The print head should be cleaned when broken or light characters occur in a vertical line on the page. To maintain a high quality print, clean the print head after 200 to 300 prints.

The print head is cleaned with a special cleaning paper which is supplied with the instrument.

---

### **WARNING**

**The paper tear-off edge is SHARP. This edge is exposed when the printer cover is raised. Note the  CAUTION SHARP EDGE label on the cover.**

---

### **HOW TO:**

- 1 Open the printer as for changing the paper. See "Changing Internal Printer Paper " page 141.  
If printer paper is fitted, remove it from the printer.
- 2 Feed the cleaning paper into the top entry of the print mechanism with the rough black side, which contains the cleaning material, towards the rear of the printer.
- 3 When the automatic feed is complete and the paper stops moving use the instrument front panel key **PAPER FEED** to move the cleaning paper through the print mechanism.
- 4 Remove the cleaning paper and replace the normal printer paper. See "Changing Internal Printer Paper " page 141.

---

### **NOTE**

Retain the cleaning paper. It is designed to last for the life of the printer.

---

**Using Instrument and Disk Storage**

---

## Storing Configurations in Instrument Store

### *Description*

You can store measurement settings which are used regularly and recall them with a single operation.

One preset store is provided which cannot be overwritten, STORED SETTING NUMBER [0]. This store is used to set the instrument to a known state, the FACTORY DEFAULT SETTINGS.

FUNCTION		STORED SETTINGS	
STORED SETTING NUMBER	1	LOCK	OFF
		ACTION	OFF
SETTING	FACTORY DEFAULT SETTINGS		
0	.....		
1	.....		
2	.....		
3	.....		
4	.....		

STATUS: OFF    RECALL    SAVE    MULTIPLE WINDOW

### *HOW TO:*

- 1 Set the instrument to the configuration you wish to store. (**TRANSMIT**, **RECEIVE**, **OTHER**, **RESULTS** displays)
- 2 Choose the STORED SETTING NUMBER to receive the configuration.
- 3 Choose LOCK [OFF].
- 4 To add a descriptive title see "Setting up a Title for Configurations in Instrument Store " page 148.
- 5 Choose SAVE to store the configuration in the chosen store.

---

## Storing Current Configurations on Disk

### *Description*

You can store a large number of measurement settings which are used regularly and recall them when required.

Configurations can be stored to a file on the floppy disk. The floppy disk can be used in other instruments.

FUNCTION	FLOPPY DISK
DISK OPERATION	SAVE
FILE TYPE NAME	CONFIGURATION SDMMNL.CNF
Select OK to perform operation	OFF
A:\ LABEL: no label      FREE: 1148928 Bytes	

STATUS: CONFIGURATION    GRAPHICS    DATA LOGGING    SCREEN BUMP    MULTIPLE WINDOW

### *HOW TO:*

- 1 Set the HP 37717C to the configuration you wish to store. (**TRANSMIT**), (**RECEIVE**), (**OTHER**), (**RESULTS**) displays)
- 2 Choose DISK OPERATION [SAVE], FILE TYPE [CONFIGURATION] and enter the filename. See "Managing Files and Directories on Disk " page 152.  
The filename extension is fixed as.CNF.  
The filename can contain up to 8 alphanumeric characters.
- 3 Choose **OK** to save the current configuration to disk.  
If you have entered a filename which already exists, a warning "File exists - are you sure you wish to continue" is displayed.  
If YES is selected, the configuration will be saved.  
To cancel, change OK to OFF and enter new filename. See "Managing Files and Directories on Disk " page 152.

---

## Setting up a Title for Configurations in Instrument Store

### *Description*

When storing configurations, you can give them an easily remembered title for identification at a later date.

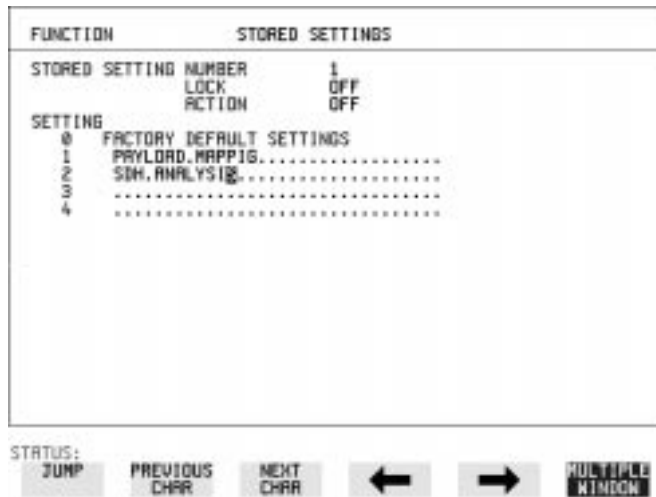

### *HOW TO:*

- 1 Choose the STORED SETTING NUMBER which contains the stored configuration.
- 2 Choose LOCK [OFF].
- 3 The easiest method of titling is to use the pop-up menu available with **SET**.  
Alternatively use **JUMP**; **NEXT CHAR**; **PREVIOUS CHAR**; **→** and **←** to title the settings.

---

## Recalling Configurations from Instrument Store

### *Description*

Having stored a configuration for future use, you must be able to recall that configuration in the future.



### *HOW TO:*

- 1 Choose the STORED SETTING NUMBER which contains the stored configuration.
- 2 Choose ACTION **RECALL** to recall the stored configuration. The recall operation can be verified by checking the relevant display settings.

---

### **NOTE**

LOCK can be set to [ON] or [OFF].

## Formatting a Disk

---

### Formatting a Disk

#### *Description*

Only 1.44M, MS-DOS compatible disks can be used in the HP 37717C. Any other format or capacity will result in a disk access error being displayed.



---

#### **NOTE**

Disks can be formatted in an IBM compatible PC (1.44M, MS-DOS only) but it is recommended that the disk is formatted in the HP 37717C as this will ensure full compatibility with the Floppy Disk power fail recovery included in the HP 37717C.

---

#### **HOW TO:**

- 1 Choose DISK OPERATION [DISK] [FORMAT].
- 2 Insert the Disk into the Disk drive.
- 3 Choose **OK** to Format the disk.  
A warning that this operation will erase all data is displayed and asks "do you wish to continue".  
If YES is selected, all the data on the Disk will be erased and the disk will be formatted.  
If NO is selected, the operation is aborted. This allows you to view the data on the Disk and verify that it is no longer needed.



---

## Labeling a Disk

**Description**

You can label your disks for ease of identification.

FUNCTION	[ FLOPPY DISK	]
DISK OPERATION	[ DISK	]
	[ LABEL	]
LABEL	[ MY DISK	]
Select OK to perform operation	<input type="checkbox"/>	OFF
A:\		
LABEL: MY DISK	FREE:	Bytes

STATUS:

 OFF OKMULTIPLE  
WINDOW**HOW TO:**

- 1 Choose DISK OPERATION [DISK] [LABEL].
- 2 Enter the label. The easiest method of labeling is to use the pop-up menu available with **SET**. See "Managing Files and Directories on Disk " page 152.  
Alternatively use **JUMP**; **NEXT CHAR**; **PREVIOUS CHAR**; **→** and **←** to label the Disk.
- 3 Choose **OK** to confirm the label is correct.  
The label is displayed at the bottom of the display to confirm the operation has taken place.

## **Managing Files and Directories on Disk**

### ***Description***

File and Directory structures can be important in speeding up the transfer of data between the instrument and the disk drive.

It is recommended that you create different directories for the different applications, for example:

A:\GRAPHICS

A:\LOGGING

A:\CONFIG

---

### **NOTE**

As the number of files in a directory increases, filename access via the pop-up menu becomes progressively slower.

---

**File and Directory names, File descriptors, Instrument Store Descriptors and Disk labels**, can be entered in two ways:

- Pop-Up File List and File Name Menus
- By Softkey Entry

Using Instrument and Disk Storage  
Managing Files and Directories on Disk

**HOW TO:**

**Enter Using Pop-Up File List and File Name Menus**

To view a directory:

- 1 Set DISK OPERATION to **SAVE** or **RECALL**.
- 2 Set FILE TYPE to the type of directory, **CONFIGURATION**, **GRAPHICS**, **DATA LOGGING** or **SCREEN DUMP**.
- 3 move the cursor to the NAME field and press **SET**.

```
Stored Measurement Graphics Files - A:  
GRAPHICS *.SMG  
NEW.. (Press SET to enter new file name)  
.\          \      0 JUL-04-1996 09:51:58  
..         \      0 JUL-04-1996 09:51:58  
PDH1.SMG   13564 JUL-04-1996 10:00:56  
PDH3.SMG   13564 JUL-04-1996 10:15:24  
MEAS001.SMG 13466 JUL-19-1996 08:07:54  
MEAS002.SMG 13466 JUL-19-1996 08:08:40  
SDH1.SMG   13466 JUL-19-1996 08:12:50  
SDH2.SMG   13466 JUL-19-1996 08:13:36  
SDH3.SMG   13466 JUL-19-1996 08:14:00  
MEAS003.SMG 13466 JUL-19-1996 08:14:54  
MEAS004.SMG 13466 JUL-19-1996 08:15:20  
SDH4.SMG   13466 JUL-19-1996 08:15:44  
NEXT PAGE ->
```

Move the highlighted cursor up and down the display using **↑** and **↓**.

- **Title Bar** - File types displayed and current directory. (cannot be highlighted).
- **.** \ - Current Directory.
- **..** \ - Parent directory. Move highlighted cursor to this line and press **SET** to move to parent directory.
- **PDH1.SMG** - File (with named extension) in current directory. Move highlighted cursor to this line and press **SET** to select the file. The display will return to the FLOPPY DISK display and the selected file name will appear in the FILE NAME field.
- **NEXT** - Move highlighted cursor to this line and press **SET** to access the next page of file names.
- **PREV** - Move highlighted cursor to this line and press **SET** to access the previous page of file names.
- **NEW.** - Allows entry of new file name using pop-up keypad. Press **SET** to obtain the pop-up keypad display.

Using Instrument and Disk Storage  
**Managing Files and Directories on Disk**

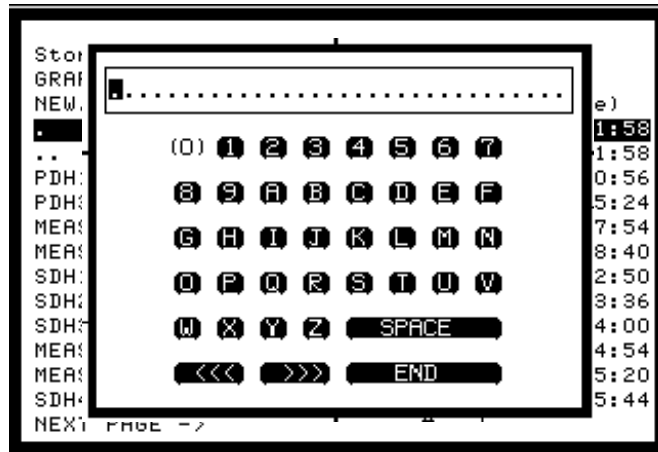

- 4 Use   to move across the rows and   to move up and down the columns.
- 5 Choose the character required and press . Repeat until the filename is entered.
- 6 Choose END and press  to return to the file manager display.
- 7 Press  to return to the SAVE display.  
 The filename entered via the keypad appears on the SAVE display.  
 The file extension.SMG has been added automatically.  
 The Directory name and the disk Label appear at the bottom of the display.

The Pop-Up keypad display can also be used to enter file and directory names, File descriptors, Instrument Store Descriptors and Disk labels.

## Using Instrument and Disk Storage

### Managing Files and Directories on Disk

Move the highlighted cursor to the enter field and press **SET** to obtain the pop-up keypad display

FUNCTION	[ FLOPPY DISK ]
DISK OPERATION	[ SAVE ]
FILE TYPE NAME	[ GRAPHICS ] [ FILENAME.SMG ]
A:\ GRAPHICS LABEL: MY DISK	FREE: Bytes

STATUS:  
SAVE    RECALL    FILE    DISK    MULTIPLE WINDOW

#### HOW TO:

### Enter Using Softkey

- 1 Use the **PREVIOUS CHAR** **NEXT CHAR** **→** **←** softkeys. This method is limited to entering Disk labels, file descriptors, file names, or a directory name when creating a directory. It cannot be used to navigate through the directory structure. This provides a quick method if the new filename is similar to the filename currently displayed, for example:  
Filename displayed PDH1 and new filename required is PDH2 - use **→** to move the cursor to the 1 and press **NEXT CHAR**

FUNCTION	[ FLOPPY DISK ]
DISK OPERATION	[ SAVE ]
FILE TYPE NAME	[ CONFIGURATION ] [ FILENAME.CNF ]
Select OK to perform operation	[ OFF ]
A:\ LABEL:	FREE: Bytes

STATUS:  
CONFIGURATION    GRAPHICS    DATA LOGGING    MULTIPLE WINDOW

---

## Adding Descriptors to Disk Files

### *Description*

When storing configurations or graphics on disk, you can give them an easily remembered descriptor for identification at a later date.

Descriptors can be added to .CNF and .SMG files.

FUNCTION	[ FLOPPY DISK ]
DISK OPERATION	[ FILE ]
	[ PROPERTIES ]
DISPLAY OPTION	[ FILE DESCRIPTOR ]
FILE NAME	FILENAME.CNF
DESCRIPTOR	.....
Press SET to select Filename popup	
Select OK to perform operation	[ OFF ]
A:\	
LABEL:	FREE: Bytes

STATUS:

TIME  
& DATE

FILE  
DESC

MULTIPLE  
WINDOW

### *HOW TO:*

- 1 Choose DISK OPERATION [FILE] [PROPERTIES] and DISPLAY OPTION [FILE DESCRIPTOR].
- 2 Move the highlighted cursor to the FILE NAME DESCRIPTOR field. Enter the file descriptor using the Pop-Up or Softkey methods. See "Managing Files and Directories on Disk " page 152. The "File List" pop-up will show the descriptor instead of the TIME and DATE information as long as FILE DESCRIPTOR is selected.

---

### **NOTE**

This slows down the updating of the display.

---

## Saving Graphics Results to Disk

### *Description*

Graphics results can be saved to a file on disk. Two methods of naming the file, which is created when the measurement is started, are available:

**Automatic** A filename in the form meas001 is created automatically without any action from you.

**Your Choice** You can input a filename of your choice which will override the automatically generated filename. This must be entered before the measurement is started. If the filename you enter already exists, graphics results will be saved to the automatically generated filename. This prevents existing files from being overwritten each time the measurement is started.

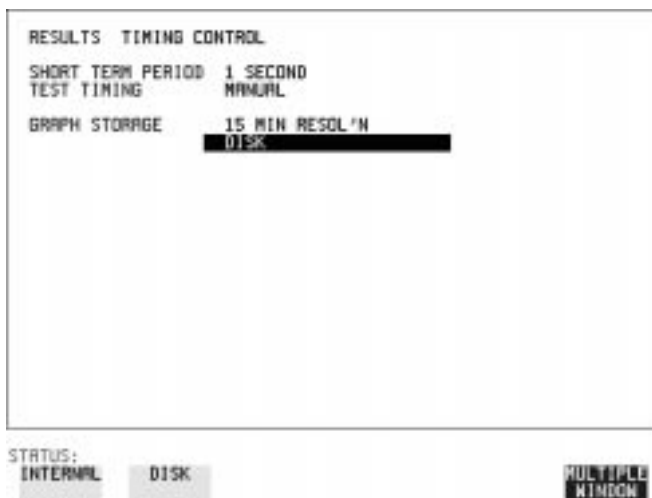

### *HOW TO:*

- 1 Choose GRAPH STORAGE [DISK] and the Graph Storage resolution required on the **RESULTS** display. See "Saving Graphics Results to Instrument Store" page 120.  
If you wish to use the automatically generated filename no further action is required and the graphics results will be saved on Disk when the measurement is started.

## Using Instrument and Disk Storage

### Saving Graphics Results to Disk

FUNCTION	[ FLOPPY DISK ]
DISK OPERATION	[ SAVE ]
FILE TYPE	[ GRAPHICS ]
NAME	[ FILENAME.SMG ]
A:\ LABEL:	FREE: Bytes

STATUS:

CONFIG-  
URATION

GRAPHICS

DATA  
LOGGING

MULTIPLE  
WINDOW

- 2 If you wish to enter your own choice of filename, choose DISK OPERATION [SAVE], FILE TYPE [GRAPHICS] on the **OTHER FLOPPY DISK** display.
- 3 Move the highlighted cursor to NAME and enter the filename (up to 8 alphanumeric characters) using the Pop-Up or softkey methods. The filename extension is fixed as .SMG. See "Managing Files and Directories on Disk " page 152.  
The graphics results will be saved on Disk while the measurement is in progress.



---

## Saving Data Logging to Disk

### *Description*

Data Logging can be saved to a file on disk. The disk can be transferred to a personal computer (PC) and the logging investigated at a later date.

FUNCTION	[ FLOPPY DISK ]
DISK OPERATION	[ SAVE ]
FILE TYPE	[ DATA LOGGING ]
NAME	[ FILENAME.PRN ]
	[ APPEND TO FILE ]
A:\	
LABEL:	FREE: Bytes

STATUS:

OVER-  
WRITEAPPEND  
TO FILEMULTIPLE  
WINDOW

### *HOW TO:*

- 1 Choose **OTHER** **FLOPPY DISK** DISK OPERATION [SAVE] FILE TYPE [DATA LOGGING] and enter your choice of filename. See "Managing Files and Directories on Disk " page 152.  
The filename can contain up to 8 alphanumeric characters.  
The filename extension is fixed as .PRN.
- 2 If you wish to add the data logging to a file which already exists, choose APPEND TO FILE. The data logging is added to the named file on Disk in the available free space.  
If you wish to overwrite the contents of the named file with the data logging, choose OVERWRITE.
- 3 Set up the **OTHER** **LOGGING** display. See "Logging Results" page 128.

When the named file is opened, data logging is saved on the disk:

- As each logging output occurs during the measurement or
- **PRINT NOW** is pressed.

---

## Recalling Configuration from Disk

### *Description*

If a configuration has been stored on disk, you will need to recall it at some time in the future to configure the instrument.

FUNCTION	[ FLOPPY DISK ]
DISK OPERATION	[ RECALL ]
FILE TYPE	[ CONFIGURATION ]
NAME	[ FILENAME.CNF ]
Select OK to perform operation	[ OFF ]
A:\ LABEL:	FREE: Bytes

STATUS:

CONFIG-  
URATION

GRAPHICS

MULTIPLE  
WINDOW

### *HOW TO:*

- 1 Choose **OTHER** **FLOPPY DISK** DISK OPERATION [RECALL] FILE TYPE [CONFIGURATION] and enter your choice of filename. See "Managing Files and Directories on Disk " page 152.  
The filename can contain up to 8 alphanumeric characters.  
The filename extension is fixed as .CNF.
- 2 To recall the configuration from disk to instrument, choose **OK**.  
The recall operation can be verified by checking the relevant display settings.

---

## Recalling Graphics Results from Disk

### *Description*

If graphic results have been stored on disk, you will need to recall them in able to view the results on the **[GRAPH]** display.

FUNCTION	[ FLOPPY DISK ]
DISK OPERATION	[ RECALL ]
FILE TYPE NAME	[ GRAPHICS ] [ FILENAME.SMG ]
Select OK to perform operation	<input type="checkbox"/> OFF
A:\ LABEL:	FREE: Bytes

STATUS:

OFF

OK

MULTIPLE  
WINDOW

### *HOW TO:*

- 1 Choose **[OTHER]** **FLOPPY DISK** DISK OPERATION [RECALL] FILE TYPE [GRAPHICS] and enter your choice of filename. See "Managing Files and Directories on Disk " page 152.  
The filename can contain up to 8 alphanumeric characters.  
The filename extension is fixed as .SMG.
- 2 To recall the graphics results from disk to instrument, choose **OK**
- 3 To view the graphics results, see "Recalling Stored Graph Results" page 121.

---

## Copying Configuration from Instrument Store to Disk

### *Description*

If you have a configuration stored in the instrument store that you wish to use on another instrument, you can copy it to disk. The configuration can then be downloaded from the disk in to another HP 37717C **with the same options as the original instrument.**

FUNCTION	[ FLOPPY DISK	]	
DISK OPERATION	[ FILE	]	
	[ COPY	]	
[FROM:]	[ CONFIGURATION	]	
	[1][ATM2?.....]		
TO:	NAME	[ FILENAME.CNF	]
Select OK to perform operation			<input type="checkbox"/> OFF
A:\	FREE:	Bytes	
LABEL:			

STATUS:

OFF

OK

MULTIPLE WINDOW

### *HOW TO:*

- 1 Choose  OTHER  FLOPPY DISK DISK OPERATION [FILE] [COPY] [CONFIGURATION] and enter the Instrument Store number. The description which was displayed on the  OTHER  STORED SETTINGS display appears alongside the store number. If required the description can be modified using  JUMP  NEXT CHAR  PREVIOUS CHAR  ←  → softkeys.
- 2 Enter the filename the configuration is to be copied to. See "Managing Files and Directories on Disk " page 152. The file name can contain up to 8 alphanumeric characters. The filename extension is fixed as.CNF.
- 3 To copy the configuration from instrument to Disk choose  OK . If you have entered a filename which already exists, a warning "File exists - are you sure" you wish to continue is displayed. If YES is selected, the data on the Disk will be overwritten. If NO is selected, the operation is aborted.

---

## Copying Configuration from Disk to Instrument Store

### *Description*

If you have a configuration stored in the instrument store that you wish to use on another instrument, you can copy it to Disk. The configuration can then be downloaded from the disk in another HP 37717C **with the same options as the original instrument.**

FUNCTION	[ FLOPPY DISK ]
DISK OPERATION	[ FILE ]
	[ COPY ]
	[ CONFIGURATION ]
[ TO: ]	[ ]
	[ 4 ] [ ATMTTEST..... ]
FROM:	
NAME	[ FILENAME.CNF ]
Select OK to perform operation	<input type="checkbox"/> OFF
A:\	
LABEL:	FREE: Bytes

STATUS:

OFF

OK

MULTIPLE WINDOW

### *HOW TO:*

- 1 Choose  OTHER  FLOPPY DISK DISK OPERATION [FILE] [COPY] [CONFIGURATION] and enter the Instrument Store number. If you wish you can enter a description of the configuration. See "Managing Files and Directories on Disk " page 152. The description can contain up to 24 alphanumeric characters.
- 2 Enter the filename the configuration is to be copied from. See "Managing Files and Directories on Disk " page 152. The file name can contain up to 8 alphanumeric characters. The filename extension is fixed as .CNF.
- 3 To copy the configuration from Disk to instrument, choose  OK . If you have entered a instrument store number which already contains a configuration, a warning "Are you sure you wish to continue" is displayed. If YES is selected, the data in the instrument store will be overwritten. If NO is selected, the operation is aborted.

---

## Copying Graphics Results from Instrument Store to Disk

### *Description*

You can copy Graphics Results from the instrument store to the Disk. This is useful under the following conditions:

- If you have graphics results stored in the instrument that you wish to prevent from being overwritten by a future measurement (only 10 store locations in the instrument)
- If you wish to retrieve the graphics results for viewing via a spreadsheet.

FUNCTION	[ FLOPPY DISK ]
DISK OPERATION	[ FILE ]
	[ COPY ]
FROM:	[ GRAPHICS ]
STORE	[ -9 ]
TO:	
NAME	[ FILENAME.SMG ]
FORMAT	[ NORMAL ]
Select OK to perform operation	<input type="checkbox"/> OFF
A:\ LABEL:	FREE: Bytes

STATUS:

OFF

OK

MULTIPLE WINDOW

### *HOW TO:*

- 1 Choose **OTHER** **FLOPPY DISK** DISK OPERATION [FILE] [COPY] [GRAPHICS] and enter the Instrument Store number.
- 2 Enter the filename the graphic results are to be copied from. See "Managing Files and Directories on Disk " page 152. The file name can contain up to 8 alphanumeric characters. The filename extension is fixed as .SMG.
- 3 If you wish to view the graphic results at a later date via a spreadsheet, choose FORMAT [CSV]. CSV is Comma Separated Variable.

**Copying Graphics Results from Instrument Store to Disk**

- 4 If you wish to view the graphic results at a later date on an HP 3771C, choose FORMAT [NORMAL] .
- 5 To copy the configuration from instrument to Disk, choose **OK** .  
If you have entered a filename which already exists, a warning "File exists - are you sure you wish to continue" is displayed.  
If YES is selected, the data on the Disk will be overwritten.  
If NO is selected, the operation is aborted.  
This allows you the opportunity to view the data on the Disk and verify that it is no longer needed.

---

## Deleting a File on Disk

### *Description*

Obsolete files can be deleted as an aid to efficient file management.

FUNCTION	[ FLOPPY DISK	]
DISK OPERATION	[ FILE	]
	[ DELETE	]
	[ DELETE FILE	]
NAME	[ FILENAME.EXT	]
Select OK to perform operation	<input type="checkbox"/>	OFF
A:\	FREE:	Bytes
LABEL:		

STATUS:

OFF

OK

MULTIPLE WINDOW

### *HOW TO:*

- 1 Choose  OTHER  FLOPPY DISK DISK OPERATION [FILE] [DELETE] [DELETE FILE] and enter the filename to be deleted. See "Managing Files and Directories on Disk " page 152.  
The file name can contain up to 12 alphanumeric characters, including the filename extension.
- 2 To delete the file choose  OK .  
A warning "Are you sure you wish to continue" is displayed.  
If YES is selected, the file is deleted.  
If NO is selected, the operation is aborted.  
This prevents accidental deletion of a wanted file.



---

## Deleting a Directory on Disk

### *Description*

Obsolete Directories can be deleted as an aid to efficient file management.

FUNCTION	[ FLOPPY DISK	]
DISK OPERATION	[ FILE	]
	[ DELETE	]
	[ DELETE DIRECTORY	]
Select OK to perform operation	<input type="checkbox"/>	OFF
A:\	FREE:	Bytes
LABEL:		

STATUS:

OFF

OK

MULTIPLE WINDOW

---

### NOTE

A directory cannot be deleted until all the files within the directory have been deleted.

---

### HOW TO:

- 1 Choose  OTHER  FLOPPY DISK DISK OPERATION [FILE] [DELETE] [DELETE DIRECTORY] .
- 2 If files need to be deleted to prepare the directory for deletion, see "Deleting a File on Disk " page 166.
- 3 Choose the directory you wish to delete (it will appear on the display). See "Managing Files and Directories on Disk " page 152.
- 4 To delete the directory choose  OK .  
A warning "Are you sure you wish to continue" is displayed.  
If YES is selected, the directory is deleted.  
If NO is selected, the operation is aborted.  
This prevents accidental deletion of a wanted directory.

---

## Renaming a File on Disk

### *Description*

Files can be renamed as an aid to efficient file management.

FUNCTION	[ FLOPPY DISK	]
DISK OPERATION	[ FILE	]
	[ RENAME	]
FROM:NAME	[ FILENAME.CNF	]
TO: DIRECTORY	A:\	
NAME	[ FILENAME.CNF	]
Select OK to perform operation	<input type="checkbox"/>	OFF
A:\		
LABEL:	FREE:	Bytes

STATUS:

OFF

OK

MULTIPLE WINDOW

### *HOW TO:*

- 1 Choose  OTHER  FLOPPY DISK DISK OPERATION [FILE] [RENAME] and enter the FROM filename. See "Managing Files and Directories on Disk " page 152.  
The filename, with extension, can contain up to 12 alphanumeric characters.
- 2 Choose the directory in which to locate the renamed file (it will appear on the display). See "Managing Files and Directories on Disk " page 152.
- 3 Enter the TO filename. See "Managing Files and Directories on Disk " page 152.  
The filename can contain up to 8 alphanumeric characters.  
The file extension is fixed to the FROM filename extension.
- 4 To rename the file choose  OK .  
If you have entered a filename which already exists, a warning "File exists - are you sure" you wish to continue is displayed.  
If YES is selected, the data in the file will be overwritten. If NO is selected, the operation is aborted.  
This allows you the opportunity to verify before renaming.

## Creating a Directory on Disk

### *Description*

Directories can be created as an aid to efficient file management.

FUNCTION	[ FLOPPY DISK ]
DISK OPERATION	[ FILE ] [ CREATE DIRECTORY ]
NAME	[ ATM ]
Select OK to perform operation	<input type="checkbox"/> OFF
A:\ CONFIG LABEL:	FREE: Bytes

STATUS:

OFF

OK

MULTIPLE WINDOW

### *HOW TO:*

- 1 Choose  OTHER  FLOPPY DISK DISK OPERATION [FILE] [CREATE DIRECTORY] and enter the directory name. See "Managing Files and Directories on Disk " page 152.  
The directory name can contain up to 8 alphanumeric characters.
- 2 To create the directory choose  OK .  
This will create a sub directory of the directory displayed at the bottom of the display. In this example A:\CONFIG\ATM will be created.

Using Instrument and Disk Storage  
**Creating a Directory on Disk**

---

**Selecting and Using "Other" Features**

## **Coupling Transmit and Receive Settings**

### ***Description***

When generating and measuring at the same interface level, you can have the transmit and receive settings coupled together. Any settings change made on the transmit display will automatically occur on the receive display. Any settings change made on the receive display will automatically occur on the transmit display.

This function is available on the **OTHER SETTINGS CONTROL** display.

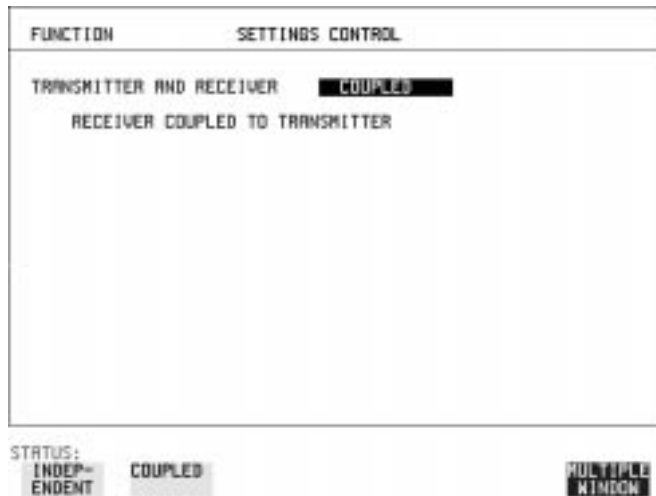

---

## Suspending Test on Signal Loss

When running a test, you can choose to suspend the test during periods of signal loss.

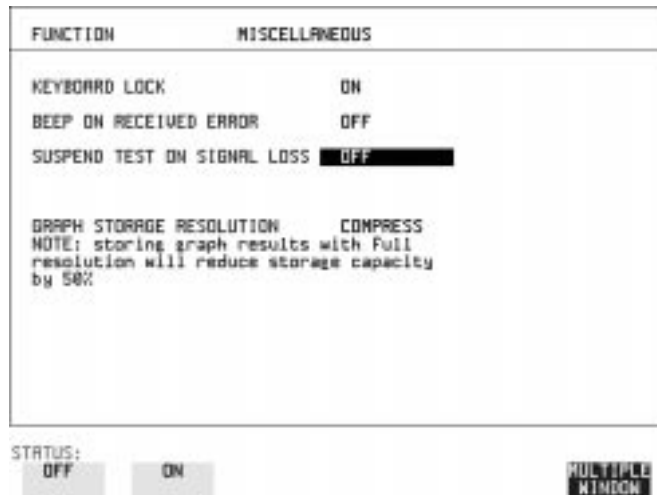

- 1 Select SUSPEND TEST ON SIGNAL LOSS [ON].

**Setting Time & Date**

**Setting Time & Date**

**Description**

When making Bit error measurements and recording results you can have certain events timed chronologically, for example, Alarms; Error Seconds.

The capability to set the Time and Date is provided on the **OTHER** display under the TIME & DATE function.

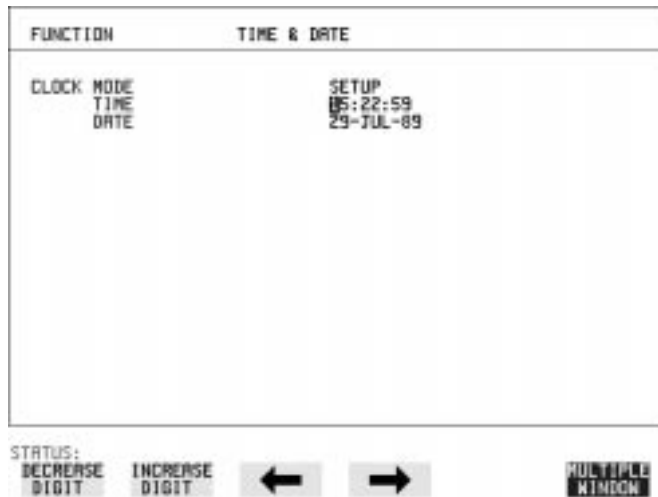

**HOW TO:**

- 1 Choose CLOCK MODE [SETUP] and set the Time and Date using the pop-up menu displayed with **SET** or the softkey method using **↑**; **↓**; **←**; **→**; **INCREASE DIGIT** and **DECREASE DIGIT**
- 2 Choose CLOCK MODE [RUN] to complete the setting of Time and Date.



---

## Enabling Keyboard Lock

### *Description*

You can protect the measurement settings from interference during a test. This facility is provided in the HP 37717C on the **OTHER** **MISCELLANEOUS** display.

The following keys are not affected by Keyboard Lock:

- Display keys **TRANSMIT**; **RECEIVE**; **RESULTS**; **GRAPH**; **OTHER**
- cursor keys **←** **↑** **↓** and **→**
- **SHOW HISTORY**
- **PAPER FEED**

The following display functions are not affected by Keyboard Lock:

- RESULTS type on the **RESULTS** display
- KEYBOARD LOCK on the **OTHER** display

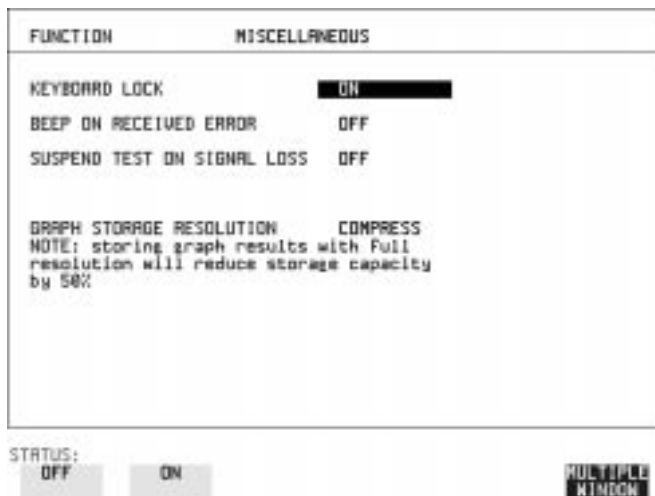

---

## Enabling Beep on Received Error

### *Description*

You can have an audible indication of an error which is particularly useful when the display on the test set is hidden from view. This function is provided in the HP 37717C on the **OTHER** **MISCELLANEOUS** display.

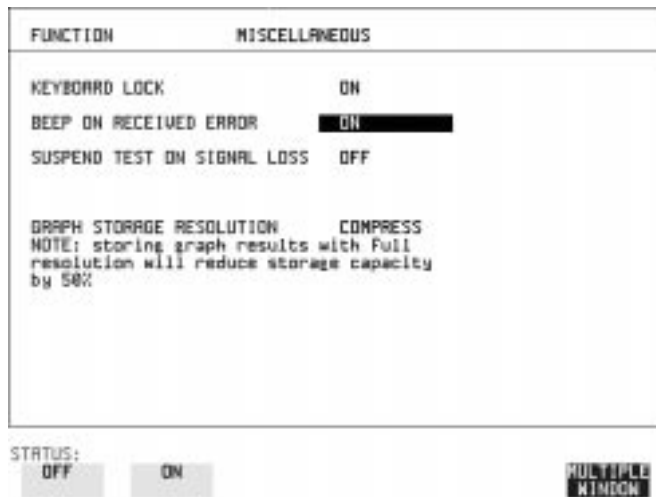

## Enabling Analysis Control

---

# Enabling Analysis Control

### *Description*

When Option UKK, Unstructured PDH, is fitted, the HP 37717C allows a choice of Analysis results when testing and this choice is selected under ANALYSIS DISPLAY MODE.

This function is provided on the **OTHER** **MISCELLANEOUS** display.

FUNCTION	[ MISCELLANEOUS ]
KEYBOARD LOCK	[ OFF ]
BEEP ON RECEIVED ERROR	[ OFF ]
SUSPEND TEST ON SIGNAL LOSS	[ OFF ]
UPDH ANALYSIS DISPLAY MODE	[ G.821 ]
GRAPH STORAGE RESOLUTION	[ COMPRESS ]
NOTE: storing graph results with full resolution will reduce storage capacity by 50%	

STATUS:

G.821

M.2100

MULTIPLE  
WINDOW

## Setting Error Threshold Indication

### *Description*

When making error measurements, you can have an indication of when an error count or error ratio threshold has been exceeded. You can set the HP 37717C to indicate this by a color change of the bar on the **GRAPH** display and the result on the **RESULTS** display.

You can choose the thresholds at which the color change (from yellow to red) occurs on the **OTHER COLOR CONTROL** display. The Count and Ratio selections are independent.

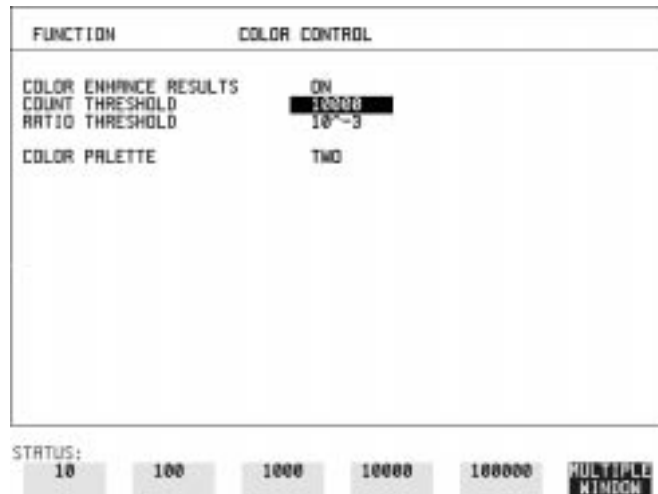

### *HOW TO:*

- 1 Choose COLOR ENHANCE RESULTS [ON].
- 2 Choose the COUNT THRESHOLD and RATIO THRESHOLD.

---

## Dumping Display to Disk

### *Description*

The display may be “dumped” to a disk file using the “SCREEN DUMP” feature. When the logging control and floppy disk are set up for screen dump, the current display is dumped to disk with **PRINT NOW**.



- 1 Select **OTHER**, **LOGGING** and set LOGGING SETUP to [CONTROL].
- 2 Set LOG ON DEMAND to [SCREEN DUMP].
- 3 If compression is required to save disk space, select BITMAP COMPRESSION (RLE) [ON] .



- 4 Select **OTHER**, **FLOPPY DISK** and set DISK OPERATION to [SAVE]

## Selecting and Using "Other" Features

### Dumping Display to Disk

- 5 Set FILE TYPE to [SCREEN DUMP].
- 6 Enter the file name of your choice in NAME.

---

#### NOTE

Note that a screen dump file name can have a maximum of 8 characters with a fixed.BMP suffix, indicating a bitmap format. The file name must satisfy DOS requirements, that is, there must be no spaces or other illegal characters. If you do not provide a file name for the screen dump, it will result in a filename being auto generated. The auto generated file name format is:

‘SDUMPxxx.BMP’

where ‘xxx’ is a numeric value in the range ‘001’ to ‘999’.

- 7 Select the display you want to dump to disk.
- 8 To start the screen dump press the **PRINT NOW** key.

---

## Setting Screen Brightness and Color

### *Description*

The HP 37717C screen can be set to single or two color using the COLOR PALETTE selection on the **OTHER**, **COLOR CONTROL** display.

The screen brightness can be set to full or half brightness. This allows the half brightness setting to be used either to prolong the life of the screen or when the room brightness is such that half brightness is more desirable.

If the brightness is set to FULL and there have been no key presses in the last hour, then the screen automatically dims to the half brightness level and the status message "Display set to half brightness" is shown. Any key press will return the screen to full brightness.

FUNCTION	COLOR CONTROL
COLOR ENHANCE RESULTS	ON
COUNT THRESHOLD	10000
RATIO THRESHOLD	10 <sup>-3</sup>
COLOR PALETTE	<b>TWO</b>

STATUS: **ONE** **TWO** **MULTIPLE WINDOW**

---

## Running Self Test

### *Description*

Before using the HP 37717C to make measurements, you can run Self Test ALL TESTS to ascertain the integrity of the HP 37717C. These tests take between 15 minutes and 1 hour to complete depending on the options fitted.

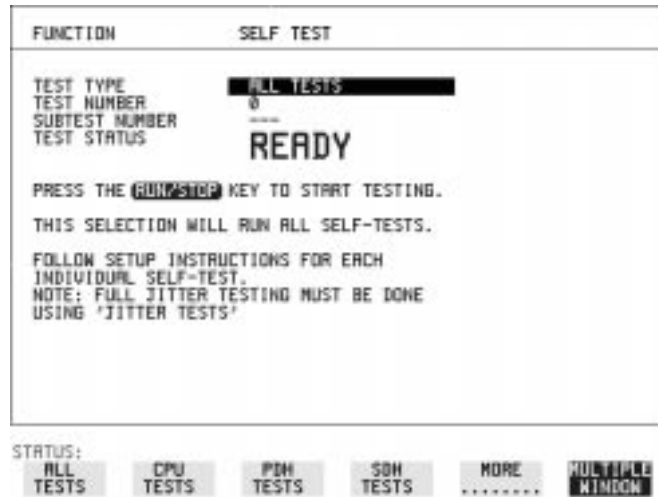

### *HOW TO:*

- 1 Set up the [OTHER] display as shown above using [OTHER], [MORE] and [SELF TEST]
- 2 Insert a formatted disk into the instrument disk drive.
- 3 Make the required loopback connections.  
The loopback connections required depend on the TEST TYPE selection.  
The following loopback connections are for the ALL TESTS selection.

### **PDH Loopbacks:**

Connect 75  $\Omega$  Signal In to 75  $\Omega$  Signal Out.

Connect 120  $\Omega$  Signal In to 120  $\Omega$  Signal Out.

If Option UKJ or 110 is fitted, connect MUX port to DEMUX port.



## Selecting and Using "Other" Features

### Running Self Test

If Option UH3 is fitted, connect Clock Out to Clock In and Data Out to Data In.

### SDH Loopbacks:

Connect the STM-1 IN port to the STM-1 OUT port.

### Optical Interface Loopbacks:

Connect the IN port to the OUT Port.

---

**CAUTION**

---

If Option URU, STM-1/STM-4 Optical Interface, is fitted, connect an Optical attenuator, set to 10 dB, between the IN and OUT Ports. **Failure to attenuate the optical signal from option URU could result in damage to the optical receiver.**

---

**NOTE**

---

If Option USN, UKT or 130, Dual Wavelength Optical Interface, is fitted, connect the **1310 nm** OUT port to the IN port. Do not connect the **1550 nm** OUT port to the IN port.

---

**NOTE**

---

If any or all of these connections are not made the HP 37717C will FAIL Self Test.

- 4 Press **RUN/STOP** to activate the Self Test. TEST STATUS [RUNNING] will be displayed. The information pertaining to TEST TYPE, TEST NUMBER and SUBTEST NUMBER will change as the Self Test progresses.

If the HP 37717C is functioning correctly, after a time of between 15 minutes and 1 hour, TEST STATUS [PASSED] is displayed. If TEST STATUS [FAIL nnn] is displayed, the HP 37717C should be returned to a service office for repair. FAIL Error Numbers are listed and defined in the Self Test Error Codes manual (part number 37717-90412).

## Running Self Test

### Additional Tests

Some options require additional tests to be carried out to completely verify the option integrity. These require different connections and the tests run individually.

#### RS-232-C Tests:

If Option A3B or A3D is fitted, the RS-232-C interface is not fully tested.

To fully test RS-232-C:

- 1 Choose CPU TESTS.
- 2 Fit a special RS-232 connector with looping links as shown:

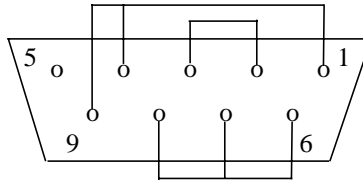

- 3 Run the CPU TESTS.

#### Line Jitter Tests:

If Option A3L, A3V, A3N, A1M, A1N or A1P, SDH Line Jitter, is fitted, the full set of jitter tests are not included under ALL TESTS.

To fully test SDH Line Jitter:

- 1 Choose JITTER TESTS.
- 2 Connect STM-1 OUT from the SDH module to STM-1E IN on the RX Jitter module.
- 3 For Options A1N and A1P only connect STM-1/STM-4 OUT on the Optical Module to STM-1/STM-4 IN on the RX Jitter module.
- 4 Run the JITTER TESTS.

#### 1550 nm Dual Wavelength Tests:

If Option USN, Dual Wavelength Optical Interface, is fitted, the 1550 nm tests are not included under ALL TESTS.

To complete the 1550 nm tests:

- 1 Choose STM-1/STM-4 OPTICS TESTS.

## Selecting and Using "Other" Features

### Running Self Test

- 2 Connect STM-1/STM-4 1550 nm OUT to STM-1/STM-4 1550 nm IN via an Optical Attenuator set to 10 dB.
- 3 Run the STM-1/STM-4 OPTICS TESTS.

#### Datacomm Tests:

If Option A1T[A1U] or A3R [A3S], SDH Module, is fitted, the Datacomm RS449 port is not tested under ALL TESTS

To test the Datacomm port:

- 1 Choose SDH TESTS.
- 2 Make the following connections on the Datacomm port.

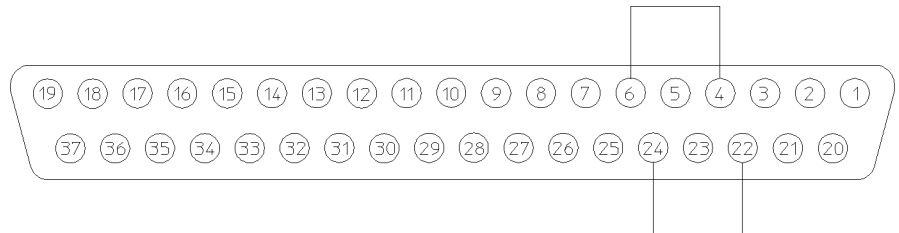

- 3 Run the SDH TESTS.

### Self Test Error Codes

Please refer to the Self Test Error Codes Reference Manual for a list of error codes (part number 37717-90412).

Selecting and Using "Other" Features  
**Running Self Test**

---

# Appendix A

---

## AU-3/TUG-3 Background Patterns

The following tables list the background patterns available when selecting specific foregrounds.

## AU-3/TUG-3 Background Patterns

**Table 2 AU-3 Background Patterns**

Foreground	Background choice in Foreground AU-3	Background choice in other AU-3s
AU-3	-----	TU-11, TU-12 Mapping or AU-3 Word (8 bit user programmable word).
TU-2	Pattern in other TU-2s is numbered. They contain the word 11NNNNNx, where NNNNN is the binary number of the TU.	TU-11, TU-12 Mapping or AU-3 Word (8 bit user programmable word).
TU-12 (2 Mb/s) Unframed	TU-12 structure, unframed with 2E15-1, 2E9-1 PRBS or 1100 word pattern in all information bits.	TU-12, TU-11 Mapping or AU-3 Word (8 bit user programmable word).
TU-12 (2 Mb/s) Framed	TU-12 structure, framed with 2E15-1, 2E9-1 PRBS, NUMBERED or 1100 word pattern. In Numbered mode, each timeslot contains the pattern 0NNNNNNX where NNNNNN is the binary number of the TU. The least significant digit (X) is alternated between 0 and 1 in successive frames.	TU-12, TU-11 Mapping or AU-3 Word (8 bit user programmable word).
TU-11 (DS1) Unframed	TU-11 structure, D4 framed with 2E15-1, 2E9-1 PRBS or 1100 Word pattern in other TU-11s.	TU-12, TU-11 Mapping or AU-3 Word (8 bit user programmable word).
TU-11 (DS1) Framed	TU-11 structure, DS1, D4 framed with 2E15-1, 2E9-1 PRBS, NUMBERED or 1100 word pattern in other TU-11s. In Numbered mode, each timeslot contains the pattern 1NNNNNN1 where NNNNNN is the binary number of the TU. Framing type will be the same as the foreground except when SLC96 is selected. In this case, D4 framing is inserted in the background	TU-12, TU-11 Mapping or AU-3 Word (8 bit user programmable word).

AU-3/TUG-3 Background Patterns

**Table 3 TUG-3 Background Patterns**

Foreground	Background choice in Foreground TUG-3	Background choice in other TUG-3s
TUG-3	-----	TU-11, TU-12 Mapping or TU-3 Word (8 bit user programmable word).
TU-2	Pattern in other TU-2s is numbered. They contain the word 11NNNNNx, where NNNNN is the binary number of the TU.	
TU-12 (2 Mb/s) Unframed	TU-12 structure, unframed with 2E15-1, 2E9-1 PRBS or 1100 word pattern in all information bits.	TU-12, TU-11 Mapping or TU-3 Word (8 bit user programmable word).
TU-12 (2 Mb/s) Framed	TU-12 structure, framed with 2E15-1, 2E9-1 PRBS, NUMBERED or 1100 word pattern. In Numbered mode, each timeslot contains the pattern 0NNNNNX where NNNNN is the binary number of the TU. The least significant digit (X) is alternated between 0 and 1 in successive frames.	TU-12, TU-11 Mapping or TU-3 Word (8 bit user programmable word).
TU-11 (DS1) Unframed	TU-11 structure, D4 framed DS1 with 2E15-1, 2E9-1 PRBS or 1100 Word pattern in other TU-11s.	TU-12, TU-11 Mapping or TU-3 Word (8 bit user programmable word).
TU-11 (DS1) Framed	TU-11 structure, framed with 2E15-1, 2E9-1 PRBS, NUMBERED or 1100 word pattern in other TU-11s. In Numbered mode, each timeslot contains the pattern 1NNNNN1 where NNNNN is the binary number of the TU. Framing type will be the same as the foreground except when SLC96 is selected. In this case, D4 framing is inserted in the background	TU-12, TU-11 Mapping or TU-3 Word (8 bit user programmable word).

AU-3/TUG-3 Background Patterns



---

# Appendix B

---

## ETSI/ANSI Terminology

A table of ETSI terms with their ANSI equivalents.



ETSI/ANSI Terminology  
**ETSI/ANSI Conversion and Equivalent Terms**

**Table 4** **ETSI / ANSI Terminology , continued**

ETSI Term	ANSI Term
MS-REI	Line FEBE / REI-L
MS-RDI	Line FERF / RDI-L
Multiplexer Section Overhead	Line Overhead
Network Node Interface	Line Interface
OOF	SEF (severely errored frame defect)
Path AIS / AU-AIS	AIS-P
Path REI / HP REI	REI-P
Path FERF / HP RDI	RDI-P
Path IEC / AU-IEC	IEC-P
Path Overhead	Path Overhead
Regenerator	Repeater
Regenerator Section (RS)	Section
Regenerator Section Overhead	Section Overhead
Remote Alarm Indicator	RAI
RS-DCC	Section DCC (DCC-S)
Section Overhead (SOH)	Transport Overhead (TOH)
S-n.1 or S-n.2 short haul	Short Reach (SR)
SOH	TOH
STM-m	OC-n / STS-n (where $m = n + 3$ for $m \geq 1$ )
STM-0	STS-1
STM-1	OC3c / STS-3c
STM-4	OC-12 / STS-12
STM-16	OC-48 / STS-48

**Table 4** **ETSI / ANSI Terminology , continued**

<b>ETSI Term</b>	<b>ANSI Term</b>
Tributary Unit (TU)	Virtual Tributary (VT)
TU	VT
TU-11	VT 1.5
TU-12	VT 2
TU-2	VT 6
TU-3	NONE
TU BIP	VT BIP (CV-V)
TU RDI / LP-RDI	RDI-V
TUG	VT Group
TUG2	VT Group (12 columns)
TUG3	VT Group (86 columns)
TU multiframe	VT superframe
TU PATH AIS	VT AIS (AIS-V)
VC	SPE
VC4	STS3C SPE
Virtual Container (VC)	Synchronous Payload Envelope (SPE)

**NOTE:** VC is an ETSI abbreviation for Virtual Container and an ETSI / ANSI abbreviation for (ATM) Virtual Channel. The context of VC must therefore be taken into account when converting between standards.

---

# Index

---

## A

Alarm monitoring, ATM, 117  
Alarm scan  
  PDH, 102  
  SDH, 101  
Alarms & errors  
  ATM add, 66  
  PDH add, 61  
  PDH payload add, 61  
  SDH add, 60  
Analysis  
  control, 177  
  display mode, 177  
  measurement PDH, 85  
  measurement PDH payload, 85  
  measurement SDH, 84  
Analysis UPDH type selection, 177  
APS messages, 79  
  generation, 79  
  monitoring, 31  
  test function, 79  
ATM alarm monitoring, 117  
ATM Cell Delay Variation, 116  
ATM measurements, making, 113  
ATM Non-Conforming cells, 116  
ATM payloads  
  physical receive interface selection, 26  
  physical transmit interface selection, 13  
  receive selection, 112  
  transmit selection, 57  
AU-3 Background Patterns, 188  
Automatic protection switch  
  message generation, 79  
Autosetup, 17  
Autotolerance, 103

## B

B/G mapping selection SDH, 7  
B/G payload selection ATM transmit, 57  
Background mapping selection SDH, 7  
Background Patterns, 188  
Background payload selection  
  ATM transmit, 57  
Beep on received error, 176  
Binary interface  
  receive PDH, 21  
  receive SDH, 22  
  transmit PDH, 4

transmit SDH, 6

## C

Capture overhead, 35  
Cell delay variation measurement, ATM,  
  114  
Cell misinsertion and loss  
  payload selection, 57  
Cell transfer delay measurement, ATM,  
  114  
Centronics printer, 131  
Color control for error threshold indica-  
  tion, 178  
Configuration  
  copy from disk to instrument, 163  
  copy from instrument to disk, 162  
  recall from disk, 160  
  recall from instrument, 149  
  store in instrument, 146  
  store on disk, 147  
  title in instrument, 148  
Copy configuration  
  from disk to instrument, 163  
  from instrument to disk, 162  
Coupling, 172  
Create directory, 169  
Cross cell  
  ATM Transmit, selection and use, 57

## D

Date & time, 174  
DCC  
  drop, 80  
  insert, 80  
DCC Insert test function, 80  
Delay measurement  
  payload selection, 57  
Delay time, jitter tolerance, 104  
Delete  
  directory, 167  
  file, 166  
Directory  
  create, 169  
  delete, 167  
  management, 152  
Disk  
  adding descriptors to files, 156  
  copy configuration from instrument, 162

copy configuration to instrument, 163  
copy graphics results from instrument,  
  164  
create directory, 169  
data entry using pop-up file list, 153  
data entry using softkeys, 155  
delete directory, 167  
delete file, 166  
format a disk, 150  
label a disk, 151  
managing directories, 152  
managing files, 152  
recall configuration, 160  
recall graphics results, 161  
rename a file, 168  
save data logging, 159  
save graphics results, 157

## Drop

DCC, 80  
  external payload/test signal, 55  
Dumping Display to Disk, 179  
Dwell time, jitter tolerance, 104

## E

Error Burst Definition  
  Service Disruption, 98  
Error Indication  
  Audio setting, 176  
Error threshold indication  
  setting, 178  
Error threshold, jitter tolerance, 104  
Errors & alarms  
  ATM add, 66  
  PDH add, 61  
  PDH payload add, 61  
  SDH add, 60  
Errors and alarms ATM test function, 66  
Errors and alarms PDH test function, 61  
Errors and alarms SDH test function, 60  
Expert mode ATM header selection, 111  
External  
  payload/test signal drop, 55  
  payload/test signal insert, 52  
External printer  
  connecting to parallel port, 136

## F

F/G mapping selection SDH, 7

---

# Index

---

- F/G payload selection ATM, 57
- File
  - delete, 166
  - descriptors, 156
  - management, 152
  - rename, 168
- Foreground mapping selection SDH, 7
- Foreground selection
  - ATM, 57
- Format a disk, 150
- Frequency measurement, 91
- Frequency offset
  - PDH, 39
  - SDH, 37
  - SDH line rate, 37
  - SDH tributary, 37
- G**
  - G.821 analysis measurement, 85
  - G.821/M.2100 analysis selection, 177
  - G.826 analysis measurement, 85
- Graphics
  - copy results from instrument to disk, 164
  - logging displays, 127
  - recall results from disk, 161
  - recall stored results, 121
  - saving results to disk, 157
  - saving to instrument, 120
  - storage resolution, 120
  - viewing error & alarm summaries, 125
  - viewing the bar graphs, 123
- H**
  - HP path label monitoring, 31
  - HP-IB printer, 132
- I**
  - Insert
    - DCC, 80
    - external payload/test signal, 52
  - Interface selection UNI/NNi, 111
  - Internal printer
    - change paper, 141
    - logging, 133
    - print head cleaning, 144
- J**
  - J1, J2 and H4 overhead byte setting, 29
- Jitter
  - measurement, 87
  - receive interface, 24
  - transmit interface, 9
- Jitter tolerance
  - delay time, 104
  - dwelt time, 104
  - error threshold, 104
  - graph result, 105
  - logging results, 137
  - measurement, 103
  - number of points, 104
  - text result, 105
- Jitter transfer
  - accuracy, 106
  - calibration, 107
  - delay time, 108
  - dwelt time, 108
  - graph results, 110
  - input mask, 108
  - logging results, 139
  - measurement, 106
  - number of points, 108
  - Q factor, 108
  - text results, 110
- K**
  - Keyboard lock, 175
- L**
  - Labeling a disk, 151
- Labels, overhead monitoring, 31
- Lock keyboard, 175
- Logging
  - content, 130
  - control, 129
  - device, 130
  - error event, 128
  - graph displays, 127
  - jitter tolerance results, 137
  - jitter transfer results, 139
  - log on demand, 130
  - result logged, 129
  - results, 128
  - test period, 128
  - to Centronics printer, 131
  - to disk, 159
  - to HP-IB printer, 132
  - to internal printer, 133
  - to RS-232-C printer, 134
  - when, 129
- M**
  - M.2100 /G.821 analysis selection, 177
  - M2100 analysis measurement, 85
  - M2110 analysis measurement, 85
  - M2120 analysis measurement, 85
- Managing
  - disk directories, 152
  - disk files, 152
- Measuring
  - frequency, 91
  - jitter, 87
  - jitter tolerance, 103
  - jitter transfer, 106
  - optical power, 92
  - overhead BER, 82
  - PDH analysis, 85
  - round trip delay, 93
  - SDH analysis, 84
  - service disruption, 97
  - wander, 89
- Monitor
  - equalizer, 20
  - indicator, 20
  - receive overhead, 30
- MSOH
  - capture and display, 35
  - insertion, 33
- MSP messages, 79
  - test function, 79
- Multiplexer section overhead
  - capture and display, 35
  - insertion, 33
- N**
  - NNI interface selection, 111
- O**
  - Optical
    - clock stress, 78
    - power measurement, 92
- Overhead
  - all data, 29
  - all labels, 29
  - APS messages monitoring, 31

---

# Index

---

- BER test, 82
- capture, 35
- default transmit, 28
- H4 byte sequences, 29
- Labels monitoring, 31
- monitor receive, 30
- path monitor, 31
- path transmit, 29
- sequence generation, 33
- SOH monitor, 30
- SOH transmit, 29
- trace messages, 32
- transmit, 28
- Overhead capture
  - trigger, 35
- Overhead capture test function, 35
- Overhead sequence
  - repeat run, 33
  - single run, 33
- P**
- Paper change
  - internal printer, 141
- Parallel port
  - connecting Centronics printer, 136
- Path overhead
  - capture and display, 35
  - insertion, 33
- Payload
  - analysis measurement, 85
  - ATM receive, 112
  - ATM transmit, 57
  - errors & alarms, 61
  - framing SDH transmit, 7
  - framing, SDH receive, 22
  - insert external, 52
  - N X 64 kb/s receive, 50
  - N X 64 kb/s transmit, 48
  - PDH receive, 20
  - PDH transmit, 3
  - SDH receive, 22, 45
  - SDH transmit, 7, 43
  - spare bits, 67
- PDH
  - alarm scan, 102
  - analysis measurement, 85
  - autosetup, 18
  - binary interface receive, 21
  - binary interface transmit, 4
  - errors & alarms, 61
  - external test signal drop, 55
  - external test signal insert, 52
  - frequency measurement, 91
  - frequency offset, 39
  - N X 64 kb/s test signal receive, 50
  - N X 64 kb/s test signal transmit, 48
  - payload, receive, 20
  - payload, transmit, 3
  - receive interface, 19
  - spare bits, 67
  - structured test signal receive, 45
  - structured test signal transmit, 43
  - telephone handset, 47
  - transmit interface, 2
- POH
  - capture and display, 35
  - insertion, 33
  - monitor, 31
  - setting, 29
- Pointer adjustments
  - burst, 68
  - G.783, 69
  - new pointer, 68
  - offset, 69
- Pointer adjustments test function, 68
- Pointer graph, 76
- Print head cleaning, 144
- Printer
  - Centronics, 131
  - Centronics, connecting to parallel port, 136
  - Centronics, logging to, 131
  - HP-IB, 132
  - HP-IB, logging to, 132
  - internal, changing paper, 141
  - internal, cleaning print head, 144
  - internal, logging to, 133
  - RS-232-C, logging to, 134
- Printing results from disk, 135
- R**
- Recall
  - configuration from disk, 160
  - configuration from instrument, 149
  - graphics results from disk, 161
  - stored graph results, 121
- Receive interface
  - binary PDH, 21
  - binary SDH, 22
  - jitter, 24
  - PDH, 19
  - physical for ATM payloads, 26
  - SDH, 22
- Receive settings
  - Coupled to transmit, 172
- Regenerator section overhead
  - capture and display, 35
  - insertion, 33
- Rename a file, 168
- Round trip delay, 93
- RS-232-C
  - logging to printer, 134
- RSOH
  - capture and display, 35
  - insertion, 33
- S**
- S1 sync status monitoring, 31
- Save
  - data logging to disk, 159
  - graphics results to disk, 157
  - graphics results to instrument, 120
- Screen dump to disk, 179
- SDH
  - alarm scan, 101
  - analysis measurement, 84
  - APS messages, 79
  - autosetup, 17
  - binary interface receive, 22
  - binary interface transmit, 6
  - DCC insert, 80
  - errors & alarms add, 60
  - external payload drop, 55
  - external payload insert, 52
  - frequency measurement, 91
  - frequency offset, 37
  - line rate offset, 37
  - Mapping selection, 7
  - MSP messages, 79
  - N X 64 kb/s payload receive, 50
  - N X 64 kb/s payload transmit, 48
  - optical clock stress, 78
  - optical power measurement, 92
  - overhead BER test, 82

---

# Index

---

overhead capture, 35  
overhead monitor, 30  
overhead sequences, 33  
overhead trace messages, 32  
overhead transmit, 28  
payload, receive, 22  
payload, transmit, 7  
pointer adjustments, 68  
pointer graph, 76  
receive interface, 22  
service disruption measurement, 97  
structured payload receive, 45  
structured payload transmit, 43  
thru mode, 15  
transmit interface, 6  
tributary rate offset, 37  
tributary scan, 99  
Self test, 182  
Sequences  
  Overhead generation, 33  
service disruption  
  DS1 and DS3, 98  
Service disruption measurement, 97  
Setting up Signaling Bits, 40  
Short term period selection, 83  
Signal Loss  
  suspending test on, 173  
Signaling Bits  
  D4 and SLC-96 payloads, 96  
  ESF Payload, 96  
  Monitoring, 95  
Single cell  
  ATM transmit, selection and use, 57  
Single cell PRBS, 57  
SOH  
  Monitoring, 30  
  Setting, 29  
Spare bits, 67  
Spare bits test function, 67  
Store  
  configuration in instrument, 146  
  configuration on disk, 147  
Stress test test function, 78  
Suspending Test on Signal Loss, 173  
Suspending test on signal loss, 173

**T**  
Telephone handset, 47

Test cell  
  ATM transmit, selection and use, 57  
Test function  
  APS messages, 79  
  DCC insert, 80  
  errors & alarms ATM, 66  
  errors & alarms PDH, 61  
  errors & alarms SDH, 60  
  MSP messages, 79  
  overhead BER test, 82  
  overhead capture, 35  
  pointer adjustments, 68  
  pointer graphPointer graph test function,  
    76  
  sequence generationSequence genera-  
    tion test function, 33  
  spare bits, 67  
  stress test, 78  
  tributary scan, 99  
Test period selection, 83  
Test signal  
  drop external, 55  
  insert external, 52  
  N X 64kb/s receive, 50  
  N X 64kb/s transmit, 48  
Test Timing, 83  
Threshold indication setting, 178  
Thru mode SDH, 15  
Time & date, 174  
Title for configuration, 148  
Trace messages, 32  
Transmit interface  
  binary PDH, 4  
  binary SDH, 6  
  jitter, 9  
  PDH, 2  
  physical for ATM payloads, 13  
  SDH, 6  
  wander, 11  
Transmit settings  
  Coupled to Receive, 172  
Tributary scan, 99  
TUG-3 Background Patterns, 189

**U**  
UNI interface selection, 111

**V**  
Viewing  
  bar graphs, 123  
  graphics error & alarm summaries, 125  
Voice channel  
  round trip delay, 93  
  telephone handset, 47

**W**  
Wander  
  bar graph, 90  
  measurement, 89  
  transmit interface, 11



# Hewlett-Packard Sales and Service Offices

If you need technical assistance with a Hewlett-Packard test and measurement product or application please contact the Hewlett-Packard office or distributor in your country.

## **Asia Pacific:**

### ***Hong Kong:***

Tel: (852) 2599 7889

### ***India:***

Tel: (91-11) 682-6000

### ***Japan:***

Hewlett-Packard Japan Ltd.  
Measurement Assistance Center  
9-1, Takakura-Cho, Hachioji-Shi,  
Tokyo 192-8510, Japan

Tel: (81) 426-56-7832

Fax: (81) 426-56-7840

### ***Korea:***

Tel: (82-2) 769 0800

### ***Malaysia:***

Tel: (60-3) 291 0213

### ***Philippines:***

Tel: (63-2) 894 1451

### ***People's Republic of China:***

Tel: (86-10) 6505 0149

### ***Singapore:***

Tel: (1800) 292 8100

### ***Taiwan:***

Tel: (886-3) 492 9666

### ***Thailand:***

Tel: (66-2) 661 3900

## ***For countries in Asia Pacific not listed, contact:***

Hewlett-Packard Asia Pacific Ltd  
17-21/F Shell Tower, Times Square,  
1 Matheson Street  
Causeway Bay  
Hong Kong  
Tel: (852) 2599 7777  
Fax: (852) 2506 9285

## **Australia/New Zealand:**

Hewlett-Packard Australia Ltd.  
31-41 Joseph Street  
Blackburn, Victoria 3130  
Australia  
Tel: 1 800 629 485

## **Canada:**

Hewlett-Packard Canada Ltd.  
5150 Spectrum Way  
Mississauga, Ontario  
L4W 5G1  
Tel: (905) 206 4725

## **Europe, Africa and Middle East:**

### ***Austria:***

Tel: (0)1 25000-0

### ***Belgium and Luxembourg:***

Tel: (02) 778 3417

### ***Baltic Countries:***

Tel: (358) 08872 2100

### ***Czech Republic:***

Tel: 420-2-4743111

### ***Denmark:***

Tel: 45 99 10 00

## **Hewlett-Packard Sales and Service Offices (cont'd)**

### ***Finland:***

Tel: (90) 88 721

### ***France:***

Tel: (0)1 69.82.60.60

### ***Germany:***

Tel: (0180) 532 62-33

### ***Greece:***

Tel: 30-1-7264045

### ***Hungary:***

Tel: 36-1-4618219

### ***Ireland:***

Tel: (01) 284 4633

### ***Israel:***

Tel: 972-3-5380333

### ***Italy:***

Tel: 02 - 92 122 241

### ***Netherlands:***

Tel: (020) 547 6669

### ***Norway:***

Tel: (22) 73 57 50

### ***Poland:***

Tel: 48-22-6087700

### ***Portugal:***

Tel: (11) 482 85 00

### ***Russia:***

Tel: (7/095) 928 6885

Fax: (7/095) 916 9844

### ***South Africa:***

Tel: 27-22-8061000

### ***Spain:***

Tel: (34) 1 631 1323

### ***Sweden:***

Tel: (08) 444 22 77

### ***Switzerland:***

Tel: (01) 735 7111

### ***Turkey:***

Tel: 90-212-2245925

### ***United Kingdom:***

Tel: (01344) 366 666

### ***For countries in Europe/Middle East and Africa not listed, contact:***

Hewlett-Packard  
International Sales Europe  
Geneva, Switzerland  
Tel: +41-22-780-4111  
Fax: +41-22-780-4770

### ***Latin America:***

Hewlett-Packard  
Latin American Region Headquarters  
5200 Blue Lagoon Drive  
9th Floor  
Miami, Florida 33126  
U.S.A.  
Tel: (305) 267-4245  
Tel: (305) 267-4220  
Fax: (305) 267-4288

### ***United States:***

Hewlett-Packard Company  
Test and Measurement Organization  
5301 Stevens Creek Blvd.  
Bldg. 51L-SC  
Santa Clara, CA 95052-8059  
Tel: 1 800 452 4844

---

## **About This Edition**

This is the 1st edition of the 37717-90402 manual. It documents the product as of March 1998. Edition dates are as follows:

1st Edition, March 1998

© Copyright Hewlett-Packard Ltd. 1998. All rights reserved. Reproduction, adaption, or translation without prior written permission is prohibited, except as allowed under the copyright laws.

**In This Book**

This book tells you how to select and use the various instrument functions available.

