



OPERATION MANUAL

**HP 4145B**  
**SEMICONDUCTOR**  
**PARAMETER ANALYZER**

SERIAL NUMBERS

This manual applies directly to instruments with serial number 2830J- and above.

With changes described in Section VII, Service Manual also applies to instruments with serial numbers prefixed 2608J-.

For additional important information about serial numbers, see INSTRUMENTS COVERED BY MANUAL in Section I, this manual.

Copyright © Hewlett-Packard Co. 1986, 1989  
All Rights Reserved. Reproduction, adaptation, or  
translation without prior written permission  
is prohibited, except as allowed  
under the copyright laws.

Manual Part No. 04145-90310  
Microfiche Part No. 04145-90360

Printed: April 1989

## Manual Organization

The *Operation Manual* and *Service Manual* are supplied with the HP 4145B. These manuals are organized as follows:

### HP 4145B *Operation Manual*

Section 1	General Information
Section 2	Installation
Section 3	Operation

### HP 4145B *Service Manual*

Section 4	Performance Tests
Section 5	Adjustment
Section 6	Replaceable Parts
Section 7	Manual Changes
Section 8	Service

The *Operation Manual* and *Service Manual* are necessary for servicing the HP 4145B.

GERÄUSCHEMISSION

Lpa < 70 dB  
am Arbeitsplatz  
normaler Betrieb  
nach DIN 45635 T. 19

ACOUSTIC NOISE EMISSION

Lpa < 70 dB  
operator position  
normal operation  
per ISO 7779

## **CERTIFICATION**

Hewlett-Packard Company certifies that this product met its published specifications at the time of shipment from the factory. Hewlett-Packard further certifies that its calibration measurements are traceable to the United States National Bureau of Standards, to the extent allowed by the Bureau's calibration facility, and to the calibration facilities of other International Standards Organization members.

## **WARRANTY**

This Hewlett-Packard instrument product is warranted against defects in material and workmanship for a period of one year from date of shipment, except that in the case of certain components listed in Section 1 of this manual, the warranty shall be for the specified period. During the warranty period, Hewlett-Packard Company will, at its option, either repair or replace products which prove to be defective.

For warranty service or repair, this product must be returned to a service facility designated by HP. Buyer shall prepay shipping charges to HP and HP shall pay shipping charges to return the product to Buyer. However, Buyer shall pay all shipping charges, duties, and taxes for products returned to HP from another country.

HP warrants that its software and firmware designated by HP for use with an instrument will execute its programming instructions when properly installed on that instrument. HP does not warrant that the operation of the instrument, or software, or firmware will be uninterrupted or error free.

## **LIMITATION OF WARRANTY**

The foregoing warranty shall not apply to defects resulting from improper or inadequate maintenance by Buyer, Buyer-supplied software or interfacing, unauthorized modification or misuse, operation outside of the environment specifications for the product, or improper site preparation or maintenance.

NO OTHER WARRANTY IS EXPRESSED OR IMPLIED. HP SPECIFICALLY DISCLAIMS THE IMPLIED WARRANTIES OF MERCHANTABILITY AND FITNESS FOR A PARTICULAR PURPOSE.

## **EXCLUSIVE REMEDIES**

THE REMEDIES PROVIDED HEREIN ARE BUYER'S SOLE AND EXCLUSIVE REMEDIES. HP SHALL NOT BE LIABLE FOR ANY DIRECT, INDIRECT, SPECIAL, INCIDENTAL, OR CONSEQUENTIAL DAMAGES, WHETHER BASED ON CONTRACT, TORT, OR ANY OTHER LEGAL THEORY.

## **ASSISTANCE**

Product maintenance agreements and other customer assistance agreements are available for Hewlett-Packard products.

For any assistance, contact your nearest Hewlett-Packard Sales and Service Office. Addresses are provided at the back of this manual.

## **Herstellerbescheinigung**

Hiermit wird bescheinigt, daß das Gerät HP 4145B (Semiconductor Parameter Analyzer) in Übereinstimmung mit den Bestimmungen von Postverfügung 1046/84 funkentstört ist.

Der Deutschen Bundespost wurde das Inverkehrbringen dieses Gerätes angezeigt und die Berechtigung zur Überprüfung der Serie auf Einhaltung der Bestimmungen eingeräumt.

Anm: Werden Meß- und Testgeräte mit ungeschirmten Kabeln und/oder in offenen Meßaufbauten verwendet, so ist vom Betreiber sicherzustellen, daß die Funk-Entstörbestimmungen unter Betriebsbedingungen an seiner Grundstücksgrenze eingehalten werden.

## **Manufacturer's Declaration**

This is to certify that this product, the HP 4145B Semiconductor Parameter Analyzer, meets the radio frequency interference requirements of directive 1046/84. The German Bundespost has been notified that this equipment was put into circulation and was granted the right to check the product type for compliance with these requirements.

Note: If test and measurement equipment is operated with unshielded cables and/or used for measurements on open setups, the user must insure that under these operating conditions, the radio frequency interference limits are met at the border of his premises.

## **SAFETY SUMMARY**

The following general safety precautions must be observed during all phases of operation, service, and repair of this instrument. Failure to comply with these precautions or with specific warnings given elsewhere in this manual violates safety standards of design, manufacture, and intended use of the instrument. Hewlett-Packard Company assumes no liability for the customer's failure to comply with these requirements.

### **GROUND THE INSTRUMENT**

To minimize shock hazard, the instrument chassis and cabinet must be connected to an electrical ground. The instrument is equipped with a three-conductor ac power cable. The power cable must either be plugged into an approved three-contact electrical outlet or used with a three-contact to two-contact adapter with the grounding wire (green) firmly connected to an electrical ground (safety ground) at the power outlet. The power jack and the mating plug of the power cable meet International Electrotechnical Commission (IEC) safety standards.

### **DO NOT OPERATE IN AN EXPLOSIVE ATMOSPHERE**

Do not operate the instrument in the presence of flammable gases or fumes. Operation of any electrical instrument in such an environment constitutes a definite safety hazard.

### **KEEP AWAY FROM LIVE CIRCUITS**

Operating personnel must not remove instrument covers. Component replacement and internal adjustments must be made by qualified maintenance personnel. Do not replace components with power cable connected. Under certain conditions, dangerous voltages may exist even with the power cable removed. To avoid injuries, always disconnect power and discharge circuits before touching them.

### **DO NOT SERVICE OR ADJUST ALONE**

Do not attempt internal service or adjustment unless another person, capable of rendering first aid and resuscitation, is present.

### **USE CAUTION WHEN EXPOSING OR HANDLING THE CRT**

Breakage of the cathode-ray tube (CRT) causes a high velocity scattering of glass fragments (implosion). To prevent CRT implosion, avoid rough handling or jarring of the instrument. Handling of the CRT shall be done only by qualified maintenance personnel using approved safety mask and gloves.

### **DO NOT SUBSTITUTE PARTS OR MODIFY INSTRUMENT**

Because of the danger of introducing additional hazards, do not install substitute parts or perform any unauthorized modification to the instrument. Return the instrument to a Hewlett-Packard Sales and Service Office for service and repair to ensure that safety features are maintained.

### **DANGEROUS PROCEDURE WARNINGS**

Warnings, such as the example below, precede potentially dangerous procedures throughout this manual. Instructions contained in the warnings must be followed.

#### **WARNING**

Dangerous voltages, capable of causing death, are present in this instrument. Use extreme caution when handling, testing, and adjusting.

## SAFETY SYMBOLS

### General Definitions of Safety Symbols Used On Equipment or In Manuals.



Instruction manual symbol: the product will be marked with this symbol when it is necessary for the user to refer to the instruction manual in order to protect against damage to the instrument.



Indicates dangerous voltage (terminals fed from the interior by voltage exceeding 1000 volts must be so marked).

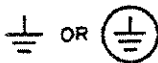

Protective conductor terminal. For protection against electrical shock in case of a fault. Used with field wiring terminals to indicate the terminal which must be connected to ground before operating equipment.



Low-noise or noiseless, clean ground (earth) terminal. Used for a signal common, as well as providing protection against electrical shock in case of fault. A terminal marked with this symbol must be connected to ground in the manner described in the installation (operating) manual, and before operating the equipment.

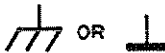

Frame or chassis terminal. A connection to the frame (chassis) of the equipment which normally includes all exposed metal structures.



Alternating current (power line).



Direct current (power line).



Alternating or direct current (power line).

### WARNING

A **WARNING** denotes a hazard. It calls attention to a procedure, practice, condition or the like, which, if not correctly performed or adhered to, could result in injury or death to personnel.

### CAUTION

The **CAUTION** sign denotes a hazard. It calls attention to an operating procedure, practice, condition or the like, which, if not correctly performed or adhered to, could result in damage to or destruction of part or all of the product.

### Note

A **Note** denotes important information. It calls attention to a procedure, practice, condition or the like, which is essential to highlight.

**TABLE OF CONTENTS**

Section	Title	Page	Section	Title	Page
<b>I GENERAL INFORMATION</b>					
1-1.	Introduction .....	1-1	3-28.	Measurement Ranges and Resolution .....	3-22
1-4.	Description .....	1-2	3-30.	Resolution and Format for Displayed Data and Data Output .....	3-26
1-11.	Specifications .....	1-3	3-32.	Compliance .....	3-28
1-13.	Safety Considerations ....	1-3	3-34.	Sweep Measurement .....	3-29
1-16.	Instruments Covered by Manual .....	1-3	3-38.	Time Domain Measurement ..	3-31
1-21.	Options .....	1-4	3-40.	Integration Time .....	3-32
1-23.	Accessories Supplied .....	1-4	3-42.	Auto-Calibration .....	3-32
1-25.	Accessories Available ....	1-4	3-45.	Display Pages .....	3-33
1-27.	Warranty Limitation for Accessories .....	1-4	3-47.	Page Control .....	3-33
<b>II INSTALLATION</b>					
2-1.	Introduction .....	2-1	3-50.	MENU PAGE .....	3-35
2-3.	Initial Inspection .....	2-1	3-52.	CHANNEL DEFINITION PAGE ..	3-35
2-5.	Preparation for Use .....	2-1	3-54.	SOURCE SETUP PAGE .....	3-35
2-6.	Power Requirements .....	2-1	3-56.	MEAS & DISP MODE SETUP PAGE .....	3-35
2-8.	Line Voltage and Fuse Selection .....	2-1	3-58.	GRAPHICS PAGE .....	3-35
2-10.	Line Frequency Filter ....	2-1	3-60.	LIST DISPLAY PAGE .....	3-35
2-12.	Power Cable .....	2-2	3-62.	MATRIX DISPLAY PAGE .....	3-35
2-16.	Operating Environment ....	2-2	3-64.	SCHMOO PLOT PAGE .....	3-35
2-19.	Installation Instructions.	2-2	3-66.	AUTO-SEQUENCE SETUP PAGE .	3-36
2-21.	Installation of Options 907, 908 and 909 .....	2-2	3-68.	OUTPUT SEQUENCE SETUP PAGE	3-36
2-23.	Storage and Shipment .....	2-4	3-70.	USER FILE CATALOG PAGE ...	3-36
2-24.	Environment .....	2-4	3-72.	OPERATION GUIDE PAGE .....	3-36
2-26.	Packaging .....	2-4	3-74.	DIAGNOSTICS PAGE .....	3-36
<b>III OPERATION</b>					
3-1.	Introduction .....	3-1	3-76.	SOFTKEY PROMPTS (SKP) ....	3-36
3-3.	Panel Features .....	3-2	3-78.	SYSTEM MESSAGES .....	3-36
3-5.	Micro Flexible Disc Handling .....	3-10	3-80.	TIME DOMAIN MEASUREMENT SETUP .....	3-80
3-7.	CRT Display .....	3-10	3-82.	DUT CONNECTION .....	3-82
3-9.	Self Test .....	3-12	3-84.	DUT Connection Using the 16058A .....	3-82
3-11.	Error Messages/Error Codes	3-12	3-86.	DUT connection Using the Connector Plate .....	3-86
3-13.	Initial Control Setting ..	3-18	3-88.	SMU OSCILLATION .....	3-88
3-15.	User-Area Filing Operations .....	3-18	3-90.	FLOATING MEASUREMENT .....	3-90
3-17.	Arithmetic Capabilities ..	3-19	3-92.	GUARDING .....	3-90
3-20.	Source and Measurement Channels .....	3-21	3-94.	PLOT .....	3-91
3-22.	Protection against Hazardous Voltage Exceeding 42V .....	3-21	3-96.	PRINT .....	3-94
3-24.	Source/Monitor Units (SMU) .....	3-22	3-98.	APPLICATIONS PACKAGE ....	3-95
3-26.	Voltage Sources (Vs) and Voltage Monitors (Vm) .	3-22	3-100.	MEASUREMENT EXAMPLE .....	3-98
			3-110.	HP-IB INTERFACE .....	3-101
			3-112.	CONNECTION TO HP-IB .....	3-101
			3-114.	HP-IB STATUS INDICATORS .	3-101
			3-116.	LOCAL KEY .....	3-101
			3-118.	HP-IB CONTROL SWITCH ....	3-101
			3-120.	HP-IB INTERFACE CAPABILITIES .....	3-102
			3-122.	HP-IB CONTROL MODES .....	3-102
			3-124.	Remote Program Codes and Parameter Setting ....	3-103
			3-126.	HP-GL CONTROL OF THE CRT ....	3-112



**TABLE OF CONTENTS**

Section	Title	Page
3-128.	HP-GL COMMANDS .....	3-112
3-130.	DEVICE CLEAR .....	3-116
3-132.	DATA OUTPUT .....	3-116
3-134.	IDENTIFICATION OUTPUT ...	3-116
3-136.	SERVICE REQUEST STATUS BYTE .....	3-118
3-138.	Programming Guide for 4145B .....	3-120
3-140.	PLOT/PRING Operation Using HP-IB Controller	3-125
3-142.	External Display .....	3-126
3-144.	Disc Initializing .....	3-127
3-146.	Operating System Copy ...	3-128
3-148.	DISC COPY .....	3-129
3-150.	FILE TRANSFER .....	3-130
3-152.	Data File Structure .....	3-132
3-155.	BDAT System Sector .....	3-132
3-157.	File Comment Sector .....	3-132
3-159.	Setup Data Sector .....	3-132
3-161.	Measurement Data Sector .	3-133
3-163.	Reading Data Files .....	3-133

## SECTION I GENERAL INFORMATION

### 1-1. INTRODUCTION

1-2. This manual contains the information required to install and operate the Hewlett-Packard Model 4145B Semiconductor Parameter Analyzer. Figure 1-1 shows the instrument and supplied accessories. This section covers specifications, instrument identification, description, options, accessories, and other basic information.

1-3. Listed on the title page of this manual is a microfiche part number that can be used to order 4 x 6 inch microfilm transparencies of the manual. Each microfiche contains up to 60 photo-duplicates of the manual pages. The microfiche package also includes the latest manual changes supplement as well as all pertinent service notes. To order an additional manual, use the part number listed on the title page of this manual.

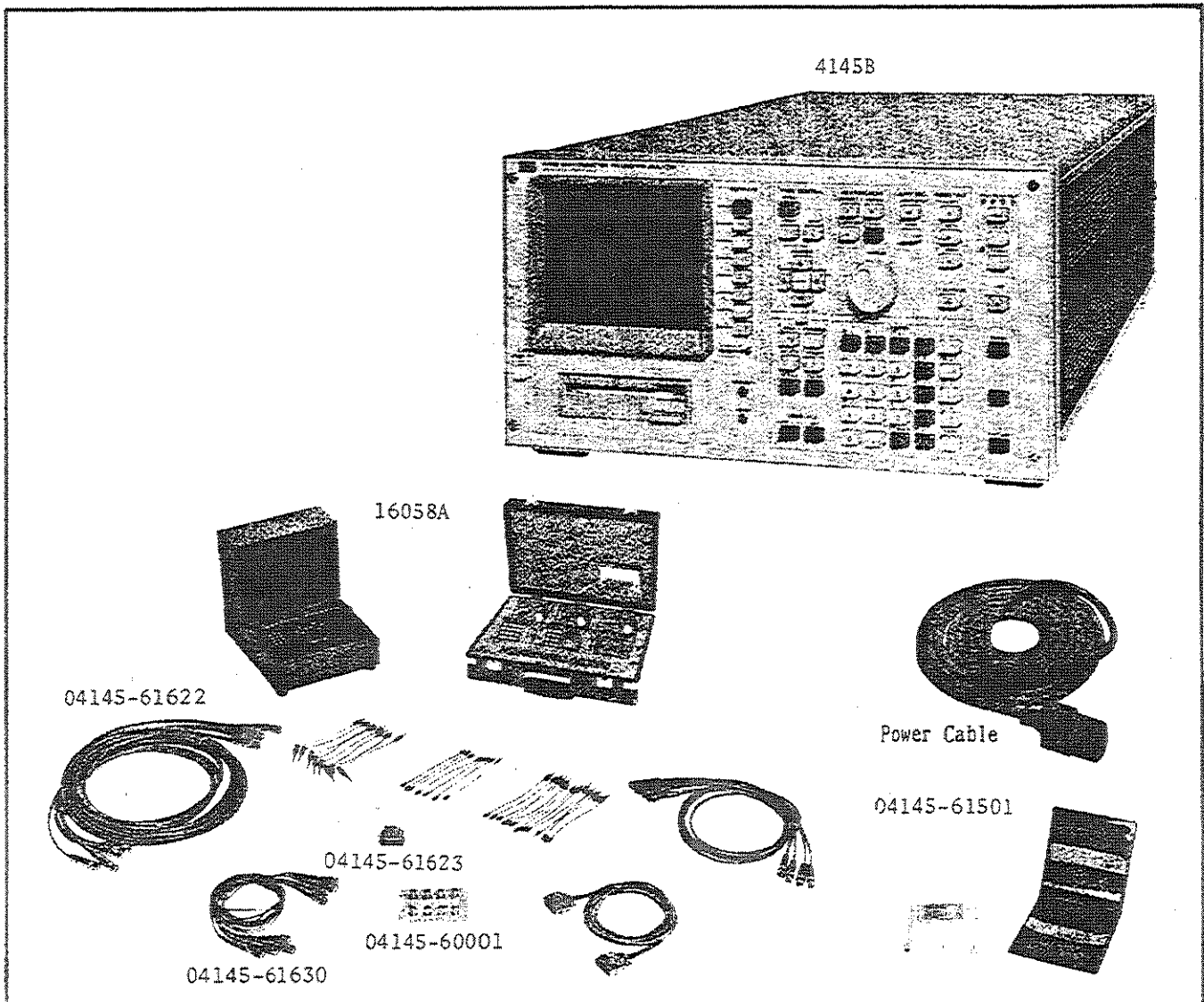

Figure 1-1. Model 4145B and Accessories

## 1-4. DESCRIPTION

1-5. The Hewlett-Packard Model 4145B Semiconductor Parameter Analyzer is a fully automatic, high performance, programmable test instrument designed to measure, analyze, and graphically display the DC characteristics of a wide range of semiconductor devices, such as diodes, bipolar transistors, field-effect transistors, wafers, ICs, etc. Main applications include computer-aided design (CAD) of ICs, new device evaluation, materials evaluation, component selection for circuit design, incoming/outgoing inspection, semiconductor process control, quality control, and quality assurance. It is equipped with four programmable Source/Monitor units (SMU), two programmable voltage source units (Vs), two voltage monitor units (Vm), a fully interactive graphics display, removable flexible-disc storage, softkeys, full arithmetic keyboard, and HP-IB. And it can be used on the bench or as part of a complete measurement system in the laboratory or on the production line.

1-6. For device stimulation and characteristics measurement, the 4145B has eight channels. Channels 1 through 4 are Source/Monitor units (SMU); channels 5 and 6 are voltage source units (Vs); and channels 7 and 8 are voltage monitor units (Vm).

Each SMU channel has three modes of operation: voltage source/current monitor (V), current source/voltage monitor (I), and common (COM). Source voltage and source current can be held constant or swept linearly or logarithmically. When used as a voltage source/current monitor (V mode), each SMU can be programmed to output DC voltages from 0V to  $\pm 100V$  over three ranges—0V to  $\pm 19.999V$ ,  $\pm 20V$  to  $\pm 39.998V$ , and  $\pm 40V$  to  $\pm 100V$ —with a resolution of 1mV, 2mV, and 5mV, respectively. When used as a current source/voltage monitor (I mode), each SMU can be programmed to output currents from  $\pm 1\mu A$  to  $\pm 100mA$  over nine ranges, with a resolution of 1pA max. (current measurement resolution is 50fA max.), depending on the current range. Current through the sample in V mode and voltage across the sample in I mode can be limited to prevent damage to the sample.

The two Vs channels are programmable voltage sources. Output voltage can be held constant or linearly or logarithmically swept from 0V to  $\pm 20V$  with 1mV resolution. The voltage sources are used when many bias and voltage sources are required.

Of the six source channels (four SMUs, two Vs), any combination of three can be automatically swept in a linear or logarithmic staircase manner within the range of each channel. Hold times from 0 to 650 seconds and delay times from 0 to 6.5 seconds can be programmed. In a multi-channel sweep setup, one channel functions as the main sweep channel. One of the other channels can be swept synchronously with the main channel, while one other channel can be swept subordinately to the main channel. SMUs not swept can be used as constant current or constant voltage sources.

The two Vm channels are used to measure voltages up to  $\pm 20V$ .

1-7. Measurement results, measurement setups, operator prompts, error messages, and diagnostics are displayed on a fully interactive, microprocessor based graphics display. Measurement results can be displayed in one of four modes: graphic, list, matrix, and schmo. Front Panel softkeys provide a wide range of automatic display control functions, such as AUTO SCALE, STORE, RECALL, CURSOR, MARKER, vertical and horizontal ZOOM, LINE (two), GRAD, 1/GRAD, X intercept, Y intercept, and INTERPOLATE. Softkeys are used in all phases of instrument operation—from measurement setup to measurement analysis—and make overall instrument operation quick and easy.

By pressing the PLOT key or PRINT key, the presently displayed screen, whether a measurement result or measurement setup, can be dumped directly onto an HP-IB compatible printer/plotter, providing clear, inexpensive hard copies. The plot area is user selectable within the limits of the printer/plotter, and if a multi-pen plotter is used, multi-color plots can be made automatically. All PLOT and PRINT operations are done automatically, without a controller. Also, the 4145B's display is equipped with X-Y-Z outputs to allow connection of a large-screen graphics display.

The 4145B is fluent in HP-GL (Hewlett-Packard Graphics Language), permitting external control of its display via the HP-IB.

Cursor and marker positioning is user controllable via the front panel, and X-Y1-Y2 coordinates are digitally displayed on the CRT.

1-8. The 4145B is equipped with a micro flexible-disc drive unit that accommodates a double-sided, double-density, 3.5 in., 630K byte disc. One system disc which contains the necessary operating system software, four general purpose measurement programs, and 573k byte of user area is furnished with the 4145B. The 4145B features an initializing function as well as an operating system copy function. After initialization, the disc can be used for storing measurement results, setup programs, or Auto Sequence Program programs. For archival purposes, the 4145B operating system can be copied onto an initialized disc using either the 4145B or an HP series 200/300 Desktop Computer (initialized format should be LIF). Up to 240 measurement setup programs, 94 sets of measurement results or 240 Auto Sequence Programs can be stored in the user area of the System Disc by executing a SAVE or RE-SAVE and can be recalled later by executing a GET.

1-9. All instrument functions are handled by a high speed microprocessor, under the control of the operating system software stored on each furnished micro flexible disc. Measurement setup, display mode selection, graphic scaling, diagnostics, operation guide, menu, and catalog are arranged as individual display pages. The MENU, PREV, and NEXT keys control movement through the individual display pages. Instructions, softkey labels, and error messages and codes are displayed on each page. Also, the 4145B is remotely controllable via the HP-IB and the 4145B's display can be used as an independent display via the HP-IB.

1-10. Furnished with the 4145B is the 16058A, a specially designed shielded test fixture which connects to the 4145B's rear panel. Eight different interchangeable DUT boards are provided, allowing measurement of diodes; 3-terminal and 4-terminal transistors; 8-pin, 10-pin, and 12-pin devices; and 18-pin and 28-pin DIP ICs. The 16058A is equipped with a light-shielded lid to allow stable measurement of light-sensitive devices, such as photo diodes, photo transistors, and photo resistors. Also, to insure operator safety when potentially dangerous voltages are applied to a sample, a warning will be displayed on the 4145B if the test fixture lid is open and measurement will not be made until the lid is closed. For user-fabricated test fixtures and jigs, a special connector, four 3-meter triaxial cables, and four 3-meter coaxial cables are also furnished.

## 1-11. SPECIFICATIONS

1-12. Complete specifications of the Model 4145B Semiconductor Parameter Analyzer are given in Table 1-1. These specifications are the performance standards or limits against which the instrument is tested. The test procedures for the specifications are covered in Section IV, Performance Tests. Table 1-2 lists Reference Data. Reference Data are not specifications but are typical characteristics included as additional information for the operator. When the 4145B Semiconductor Parameter Analyzer is shipped from the factory, it meets the specifications listed in Table 1-1.

## 1-13. SAFETY CONSIDERATIONS

1-14. The Model 4145B Semiconductor Parameter Analyzer has been designed to conform to the safety requirements of an IEC (International Electromechanical Committee) Safety Class I instrument and is shipped from the factory in a safe condition.

1-15. This operation contains information, cautions, and warnings which must be followed by the user to ensure safe operation in a safe condition.

## 1-16. INSTRUMENTS COVERED BY MANUAL

1-17. Hewlett-Packard uses a two-section nine character serial number which is stamped on the serial number plate (Figure 1-2) attached to the instrument's rear-panel. The first four digits and the letter are the serial prefix and the last five digits are the suffix. The letter placed between the two sections identifies the country where the instrument was manufactured. The prefix is the same for all identical instruments; it changes only when a change is made to the instrument. The suffix, however, is assigned sequentially and is different for each instrument. The contents of this manual apply to instruments with the serial number prefix(es) listed under SERIAL NUMBERS on the title page.

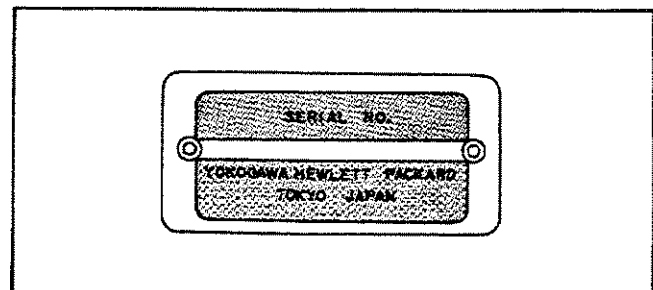

Figure 1-2. Serial Number Plate.

1-18. An instrument manufactured after the printing of this manual may have a serial number prefix that is not listed on the title page. This unlisted serial number prefix indicates the instrument is different from those described in this manual. The manual for this new instrument may be accompanied by a yellow Manual Changes supplement or have a different manual part number. This supplement contains "change information" that explains how to adapt the manual to the newer instrument.

1-19. In addition to change information, the supplement may contain information for correcting errors (called Errata) in the manual. To keep this manual as current and accurate as possible, Hewlett-Packard recommends that you periodically request the latest Manual Changes supplement. The supplement for this manual is identified with the manual print date and part number, both of which appear on the manual's title page. Complimentary copies of the supplement are available from Hewlett-Packard. If the serial prefix or number of an instrument is lower than on the title page of this manual, see Section VII, Manual Change.

1-20. For information concerning a serial number prefix that is not listed on the title page or in the Manual Change supplement, contact the nearest Hewlett-Packard office.

#### 1-21. OPTIONS

1-22. Options are modifications to the standard instrument that implement the user's special requirements for minor functional changes. The 4145B has following Options:

- Option 050 : For 50 Hz Line Frequency
- Option 060 : For 60 Hz Line Frequency
- Option 907 : Front Handle Kit.
- Option 908 : Rack Flange Kit.
- Option 909 : Rack Flange and Front Handle Kit.
- Option 910 : An extra copy of the Operation and Service Manual.

Installation procedures for option 907, 908 and 909 are given in Section II.

#### 1-23. ACCESSORIES SUPPLIED

1-24. The Model 4145B Semiconductor Parameter Analyzer, along with its furnished accessories, is shown in Figure 1-1. In addition, an Operation and Service Manual is furnished with the 4145B.

#### 1-25. ACCESSORIES AVAILABLE

1-26. HP 16267A File Transfer Software, HP 16268A BS&DM File Creation Software and HP 92192A Double-sided Micro Flexible Discs are available. The File Transfer Software enables you to transfer files from the 4145A to the 4145B. The BS&DM File Creation Software enables you to create the BS&DM data format from the 4145B's unique data format. The HP 92192A Double-sided Micro Flexible Disc can be used for data storage or operating system copy.

#### 1-27. Warranty Limitation for Accessories

1-28. The Personality Board (P/N: 16058-60003) and eight Boards (P/N: 16058-60004 through 16058-60005, 16058-60007 through 16058-60011, and 16147-60002) furnished with the 16058A Test Fixture are warranted against defects in material and workmanship for a period of three months from the date of delivery. During the warranty period, Hewlett-Packard Company will, at its option, either repair or replace components which prove to be defective. This warranty does not apply to defects resulting from improper use or inadequate maintenance.

Table 1-1. Specifications (Sheet 1 of 8)

\* Specifications listed below are for the 4145B only. For 16058A specifications, refer to the 16058A Operation Note.

GENERAL INFORMATION

**Basic Functions:** Measures the DC current through voltage-biased devices and the DC voltage across current-biased devices; Arithmetic calculation; Displays measurement results and calculation results on a built-in CRT display; graphics analysis capabilities; storage and recall of measurement setups, measurement data, and auto-sequence programs.

**Source and Measurement Units:**

**Source/Monitor Units (SMU):** Four SMU channels. Each SMU can be programmed to function as a variable or constant DC voltage source/current monitor or as a variable or constant DC current source/voltage monitor.

**Voltage Sources (Vs):** Two Vs channels. Each Vs can be programmed to function as a variable or constant DC voltage source.

**Voltage Monitors (Vm):** Two Vm channels. Each Vm can measure DC voltages up to ±20V.

SOURCE/MONITOR FUNCTIONS

Measurement and output accuracies are specified at 23 ° ±5 °C after the instrument has been allowed to warm up for at least 40 minutes, with AUTO CAL set to ON, INTEG TIME set to SHORT and referenced to SMU common. Specified accuracy doubles for operation between 10 °C and 40 °C.

**Source/Monitor Units (SMU):** Four SMU channels. Each SMU measures current when operating as a voltage source, or measures voltage when operating as a current source. Source and measurement ranges, resolution, and accuracy specifications are given in the tables below.

Accuracy specifications in the below tables are given as ±n% of specified output or measured value, ±n% of range value. Io is output current (I), Vo is output voltage (V).

Voltage Range	Resolution	Accuracy	Max. Current
±20V	1mV	±(0.1%+10mV+0.4Ω*Io)	100mA
±40V	2mV	±(0.1%+20mV+0.4Ω*Io)	50mA
±100V	5mV	±(0.1%+50mV+0.4Ω*Io)	20mA

Table 1-1. Specifications (Sheet 2 of 8)

Current Range	Resolution	Accuracy	Max. Voltage
±100mA	100μA	±(0.3%+100μA+2μA*Vo)	20V (>50mA)
			40V (>20mA)
±10mA	10μA	±(0.3%+10μA+200nA*Vo)	100V (≤20mA)
±1000μA	1μA	±(0.3%+1μA+20nA*Vo)	
±100μA	100nA	±(0.3%+100nA+2nA*Vo)	
±10μA	10nA	±(0.3%+10nA+200pA*Vo)	
±1000nA	1nA	±(0.5%+1nA+20pA*Vo)	
±100nA	100pA	±(0.5%+100pA+2pA*Vo)	
±10nA	10pA	±(1%+15pA+200fA*Vo)	
±1000pA	1pA	±(1%+6pA+20fA*Vo)	

Setting Resolution : Voltage, 4·1/2 digits (1mV max.);  
Current, 4 digits (1pA max.).

Measurement Resolution : Voltage, 4·1/2 digits (1mV max.);  
Current, 4 digits (50fA max.).

Ranging : Automatic.

Current/Voltage Limiting (Compliance) : Current output from an SMU operating as a voltage source and voltage output from an SMU operating as a current source can be limited.

Compliance Range : Current, 50pA to maximum allowable output current of each voltage range; Voltage, 0V to maximum allowable output voltage of each current range.

Accuracy: Current compliance, accuracy of current source+1% of range +10pA;  
Voltage compliance, accuracy of voltage source.

Residual Resistance (Voltage Source/Current Measurement Mode) : 0.4Ω.

Input Resistance (Current Source/Voltage Measurement Mode) : ≥10<sup>12</sup>Ω.

Capacitive Load : ≤1000pF.

Table 1-1. Specifications (Sheet 3 of 8)

Voltage Sources (Vs) : Two Vs channels. Each Vs can be programmed to function as a variable or constant DC voltage source. Output ranges, resolution, and accuracy specifications are given in the table below.

Output Voltage Range	Resolution	Accuracy	Max. Output Current
±20V	1mV	0.5% of setting +10mV	10mA

Output Impedance : Less than  $0.2\Omega$

Capacitive Load :  $\leq 1000\text{pF}$

Voltage Monitors (Vm) : Two Vm channels. Output ranges, resolution, and accuracy specifications are given in the table below.

Measurement Voltage Range	Resolution	Accuracy
±2V	100 $\mu\text{V}$	0.5% of reading + 10mV
±20V	1mV	0.2% of reading + 10mV

Input Impedance :  $1\text{M}\Omega \pm 1\%$

Capacitance in Parallel with Output :  $150\text{pF} \pm 10\%$



Table 1-1. Specifications (Sheet 4 of 8)

SPECIFICATIONS COMMON TO ALL CHANNELS

Maximum Withstand Voltage : 100V (SMU, guard terminal, Vs, and Vm)

Maximum Voltage Between Common and GND : Less than  $\pm 42V$ .

Source Modes (SMUs Only) : V (voltage source/current monitor),  
I (current source/voltage monitor), and COM\*.

Source Functions (SMUs Only) : VAR1, staircase sweep;  
VAR1', synchronous (VAR1) staircase sweep;  
VAR2, subordinate (VAR1) staircase sweep;  
CONST, constant source (voltage or current).

\*: In COM mode, output voltage is 0V and compliance is 105mA.

Voltage/Current Sweep : Output from each SMU (voltage or current) and each Vs (voltage) can be swept by assigning source function VAR1, VAR1', or VAR2.

Max. Number of Steps : 512 in single-sweep measurements, up to 575 in multi-sweep measurements.

VAR1 : Main sweep. Linear or logarithmic sweep is selectable.

Linear Sweep : Staircase sweep in accordance with the user specified START, STOP, and STEP values.

Log Sweep : Staircase sweep in accordance with the user specified START and STOP values and selected LOG step (10, 25, or 50 points per decade).

VAR2 : Subordinate linear staircase sweep in accordance with the user specified START, STEP, an NO. OF STEPS values. VAR2 source channel output is incremented one STEP each time the VAR1 source channel completes one sweep.

VAR1' : Staircase sweep synchronized with the VAR1 sweep. Sweep is made with a user specified, fixed ratio or offset value. VAR1' output is calculated as :

$$\begin{aligned} \text{VAR1}' &= a \times \text{VAR1} \text{ (fixed ratio)} \\ \text{VAR1}' &= b + \text{VAR1} \text{ (fixed offset)} \end{aligned}$$

where "a" is the user-specified ratio (from  $\pm 0.01$  to  $\pm 10$ ) and "b" is the user-specified offset value. Ratio and offset must be such that the VAR1' source channel does not exceed its maximum output limit.

HOLD TIME : 0 to 650 seconds, 10ms resolution (max.). Accuracy is  $\pm 0.5\% + 9\text{ms}$ .

DELAY TIME : 0 to 6.5 seconds, 1ms resolution. Accuracy is  $\pm 0.1\% + 5xN$  for GRAPHICS and SCHMOO plots and  $\pm 0.1\% + 10xN$  for LIST and MATRIX displays. Where N is the number of measurement channels used in the measurement.

Output Sequence : The order in which the source channels begin output is fully programmable.

Measurement Modes : SINGLE, REPEAT, APPEND

Integration Time (at each measurement point) : SHORT, 3.6ms; MED, 20ms at 50Hz line frequency, 16.7ms at 60Hz line frequency; LONG, 16 times MED.

Table 1-1. Specifications (Sheet 5 of 8)

DISPLAY FUNCTIONS

Display : CRT. Electrostatic focus and deflection, post accelerated. Aluminized P-31 phosphor.

Screen Size : 16cm (6.25in) diagonal.

Screen Resolution : 2048 x 2048 points.

Display Characters and Symbols : Upper-case alphabetic characters, numerics, comma, ( , ), @,  $\Omega$ ,  $^{\circ}$  (deg), ", %, #, g, k, e, m,  $\mu$ , n, p, +, -, \*, /,  $\sqrt{\quad}$ ,  $\Delta$ . All are entered from the front panel.

Display Modes : GRAPHICS, LIST, MATRIX, SCHMOO, and TIME DOMAIN.

GRAPHICS Display : Two-axes (X-Y) or three-axes (Y-Y<sub>1</sub>-Y<sub>2</sub>) plot of measured parameters and USER FUNCTION calculations.

LIST Display : Used in conjunction with VAR1 sweep. Up to six measurement parameters and USER FUNCTION results can be displayed for each step of the VAR1 source channel.

MATRIX Display : Used in conjunction with VAR1 and VAR2 sweeps. Up to six columns of sweep-dependent measurement results or USER FUNCTION results can be displayed.

SCHMOO Display : Used in conjunction with VAR1 and VAR2 sweeps. Sweep-dependent measurement results or calculation results are displayed on an X-Y-Z graph.

TIME DOMAIN Display : Measurement and calculation results are displayed on a two-axes (X-Y) or three-axes (X-Y<sub>1</sub>-Y<sub>2</sub>) graph as a function of time. VAR1 sweep is replaced by time.

Parameters: Initial Wait Time, 0 to 100 seconds (10ms resolution); Measurement Interval, 10ms to 10 seconds (10ms resolution); Number of Readings, 1024.

Table 1-1. Specifications (Sheet 6 of 8)

ARITHMETIC AND ANALYSIS FUNCTIONS

**Arithmetic Functions :** Arithmetic expressions can be entered and executed directly from the front panel. Results are displayed on the CRT.

**Arithmetic Operators :** +, -, \*, /,  $\sqrt{\quad}$ , EXP (Napierian constant), LOG (common log), LN (natural log), \*\* (exponentiation), ABS (absolute), EEX (scientific notation), and  $\Delta$  (differential calculation).

**Keyboard Operation :** Arithmetic expressions are executed by pressing the EXECUTE key. Results are displayed on the CRT.

**USER FUNCTION :** Up to two USER FUNCTION can be defined as arithmetic expressions. USER FUNCTIONS are executed during measurement and the results are displayed with measurement results.

**Physical Constants :** Three commonly used physical constants are permanently stored in memory. The stored value of each constant has seven-digit accuracy but only the five most significant digits are displayed.

q: Electron Charge,  $1.602189 \times 10^{-19}$  C  
 k: Boltzmann's Constant,  $1.380662 \times 10^{-23}$  J/°K  
 e: Dielectric Constant of vacuum,  $8.854185 \times 10^{-12}$  F/m.

**Engineering Units :** m ( $10^{-3}$ ),  $\mu$  ( $10^{-6}$ ), n ( $10^{-9}$ ), p ( $10^{-12}$ )

**Analysis Functions :**

**Overlay Graph Comparison :** A GRAPHIC plot can be stored and later recalled to obtain an overlay comparison of two measurements. A SCHMOO plot can also be stored, but when the RECALL key is pressed, only the stored plot is displayed. Pressing RECALL a second time redisplay the previous plot. Only one set of data can be stored and scaling information is not included.

**Auto Retrieve Function :** Measurement data obtained in any display mode is automatically redisplayed whenever the display mode is changed. However, when the value of a measurement setup parameter is changed, all measurement data is cleared.

**MARKER :** On a GRAPHICS plot, the MARKER can be moved along a plotted curve or line. The X,  $Y_1$ , and  $Y_2$  coordinates at the MARKER location are digitally displayed on the CRT.

**INTERPOLATE :** Allows positioning of the MARKER between two measurement points. The X,  $Y_1$ , and  $Y_2$  coordinates at the MARKER location are estimated and digitally displayed on the CRT.

**CURSOR :** On a GRAPHICS plot, the CURSOR is two intersecting and perpendicular lines which can be positioned at any point on the graph. There are two GRAPHICS cursors : LONG and SHORT. The X,  $Y_1$ , and  $Y_2$  coordinates at the CURSOR location are digitally displayed on the CRT.

On a SCHMOO plot the CURSOR highlights the symbol at a measurement point and only the Z-axis value is digitally displayed on the CRT.

On LIST and MATRIX displays the CURSOR is a moveable pointer ( $\blacktriangleright$ ).

Table 1-1. Specifications (Sheet 7 of 8)

**AUTO SCALE:** GRAPHIC plots can be automatically rescaled after measurement, providing optimum display of measurement results.

**ZOOM** Function ( $\leftrightarrow$ ,  $\rightarrow$ ,  $\updownarrow$ ,  $\updownarrow$ ) : Used in conjunction with the CURSOR on GRAPHIC plots. Expands ( $\leftrightarrow$ ,  $\updownarrow$ ) or contracts ( $\rightarrow$ ,  $\updownarrow$ ) the graph in the indicated direction and in reference to the CURSOR location.

**MOVE WINDOW:** Repositions the LONG or SHORT CURSOR to the exact center of the plot area and moves displayed plots in reference to the CURSOR.

**LINE:** Draws a straight line between two moveable cursors. X and Y axes intercepts are digitally displayed, as are the line gradient (GRAD) and gradient reciprocal (1/GRAD) values.

#### MASUREMENT/DISPLAY SETUP AND STORAGE FUNCTIONS

**Measurement/Display Setup:** Interactive fill-in-the-blank programming of channel definitions, source outputs, and measurement/display modes.

**Measurement Setup Storage:** The existing measurement setup can be stored in the user-area on the micro flexible disc and recalled later by using the SAVE, RE-SAVE and GET keys.

**Measurement Data Storage:** The existing measurement results can be stored in the user-area on the micro flexible disc and recalled later by using the SAVE, RE-SAVE and GET key.

**Auto-Sequence Program:** A series of different measurements can be programmed for automatic execution. The maximum number of program steps is 50, and useable commands are GET P, SINGLE, SAVE D, RAVED, PLOT, CPLOT, PRINT, PAUSE, WAIT, and PAGE.

**Storage Medium:** 3.5 in. double-sided, double-density, micro flexible disc.

User area: 622k bytes

Number of user records: 2432 records

Max number of recorded files: up to 240 files

**Record Allocation:** Measurement setup (file type P), 5 records;  
Measurement data (file type D), 23 records;  
Auto-sequence program (file type S), 4 records;  
Operating System, 254 records.

**Initialization function for the storage medium:**

**Initialization:** Used to generate the directory.

**Format type:** LIF (Logical Interface Format)

**Operating System Copy:** Used to copy the operating system onto the initialized disc.

Table 1-1. Specifications (Sheet 8 of 8)

GENERAL SPECIFICATIONS

## Data Input/Output :

External CRT Analog Output : From 0 to +1 Vdc, X and Y outputs (in series with approx. 330 $\Omega$ ) Z output (in series with approx. 240 $\Omega$ ), via rear panel BNC connectors. Frequency Bandwidth, DC - 2MHz.

External Plotter/Printer Output : Measurement data and all data appearing on the CRT may be output via the HP-IB to an HP plotter/printer operated in the LISTEN ONLY Mode. Output is initiated using the PLOT or PRINT key.

HP-GL Control : The CRT of the 4145B may be program controlled in the Graphics Display Mode via an HP-IB compatible Controller.

HP-IB and Remote-Control Functions : The 4145B may be interfaced to any HP controller or other instrument having HP-IB interface capability. (HP-IB is Hewlett-Packard's implementation of IEEE-488 and ANSI-MC.1.1 standards.)

Self-Test Function : At power ON, the 4145B automatically verifies its own operational status. HP-IB and DIAGNOSTICS page allow Self-Test to be performed at any time.

Operating Temperature Range: 10 °C to +40 °C;  $\leq$  70% RH (40 °C)  
Permissible Temperature Change:  $\leq$  1 °C/5 min.;  
Maximum Wet-bulb temperature: 29 °C

Power Requirements : 100/120/220V $\pm$ 10% : 240V -10% + 5%;  
48 - 66Hz; Max. 270VA

Dimensions : 426W x 235H x 612D (mm) (approx.)

Weight : Approx. 27kg  
Approx. 33kg (including accessories)

Table 1-2. Reference Data (Sheet 1 of 3)

REFERENCE DATA

(The following information is reference data only. It is not guaranteed specifications, nor does it include Test Fixture specifications.)

Measurement Time: (Setting time + ranging time + integration time)/1 point measurement

Settling Time: The following calculation is applicable where current range does not change (settling and set-up time + SMU wait time).

Current Range	Settling and Set-Up Time	SMU Wait Time
100nA - 100mA	2.7ms	0.2ms
1nA - 10nA		47.5ms

Ranging Time: 4ms - 74ms (depending on range)

Measurement Time: (Ranging time must be added.)

Settling and Set-Up Time	Delay Time	SMU Wait Time	Ranging Time	Integration Time
← 2.7ms →	Setting Value	0.2ms or 47.5ms	4ms ? 74ms	3.6ms ? 320ms

Example: Minimum measurement time = 2.7ms + 0.2ms + 3.6ms = 6.5ms. In the Graphics Display Mode, write time ( 5.6ms) must be added.

Table 1-2. Reference Data (Sheet 2 of 3)

SOURCE/MONITOR UNIT (SMU)

Offset Current when operated as a Voltmeter :  $6\text{pA} + 2\text{pA} \times V_o/100$

Offset Voltage when operated as a Current Meter :  $10\text{mV} + 0.4\Omega \times I_o$

Noise Characteristics : (all values typical)

Voltage Source Noise : 0.01% of range (RMS)

Current Source Noise : 0.1% of range +  $3\text{pA} + 0.01\text{pA} \times C_g$  (RMS)

( $C_g$  : Guard capacitance in pF)

Voltage Monitor : 0.02% of range (peak-to-peak)

Current Monitor : 0.3% of range +  $10\text{pA}$

(peak-to-peak)

Output Overshoot : (all values typical)

Voltage Source Overshoot :  $5\text{mV}$

Current Source Overshoot : 1% or less

Current Range Switching Transient Noise : (All values typical)

Range Increment : 0.01% of voltage range +  $10\text{mV}$

Range Decrement : When switching into  $10\text{nA}$  or  $1\text{nA}$  range,  $10\text{mV} + 100/(10 + C_x)\text{mV}$  where  $C_x$  = load capacitance (pF); when switching into all other ranges,  $10\text{mV}$ .

Guard Capacitance :  $\leq 700\text{pF}$

Guard Potential Offset :  $1\text{mV}$  (typical)

Guard Current Induced Potential Error :  $100\Omega \times I_g$  ( $I_g$  = guard current)

Voltage Sources ( $V_s$ )

Output Noise :  $6\text{mV}_{\text{rms}}$  (typical)

Voltage Monitors ( $V_m$ )

Noise Level :  $0.3\text{mV}_{\text{p-p}}$  at  $2\text{V}$ -range (when Integration time is set to MED or LONG),  $3\text{mV}_{\text{p-p}}$  at  $20\text{V}$  range.

REFERENCE DATA COMMON TO ALL UNITS

Noise Rejection : (Integration time set to MED or LONG.)

Normal Mode Rejection :  $\geq 60\text{dB}$  (typical)

Common Mode Rejection : (all values typical)

Current Source/Measurement :  $\leq 1\text{pA}/1\text{V}$

Table 1-2. Reference Data (Sheet 3 of 3)

ACCESSORIES FURNISHED WITH 4145B

16058A Test Fixture (includes the following subcomponents)

16058-60003	Personality Board --
16058-60004	Teflon Blank Board --
16058-60005	Socket Board (Transistor) --
16147-60002	Socket Board (28-pin DIP) --
16058-60007	Socket Board (18-pin DIP) --
16058-60008	Socket Board (Diode) --
16058-60009	Socket Board (8-pin package) --
16058-60010	Socket Board (10-pin package) --
16058-60011	Socket Board (12-pin package) --
16058-61600	Connection Cable (large-to-small), (Twelve 16058-61600s are furnished.)
16058-61601	Connection Cable (small-to-small), (Eight 16058-61601s are furnished.)
16058-61602	Miniature Clip Lead, (Eight 16058-61602s are furnished.)
16058-61603	1.5m Triaxial Cable, (Four 16058-61603s are furnished.)
16058-61604	Fixture System Cable
16058-60100	Accessory Case

04145-60001	Connector Plate
04145-61622	<u>3m Triaxial Cable</u> , (Four 04145-61622s are furnished.)
04145-61630	<u>3m BNC Cable</u> , (Four 04145-61630s are furnished.)
04145-61623	Shorting Connector
04145-61501	System Disc

OPTIONS

Option 050:	For 50Hz Line Frequency
Option 060:	For 60Hz Line Frequency
Option 907:	Front Handle Kit
Option 908:	Rack Flange Kit
Option 909:	Rack and Handle Kit
Option 910:	Extra Operation and Service Manual

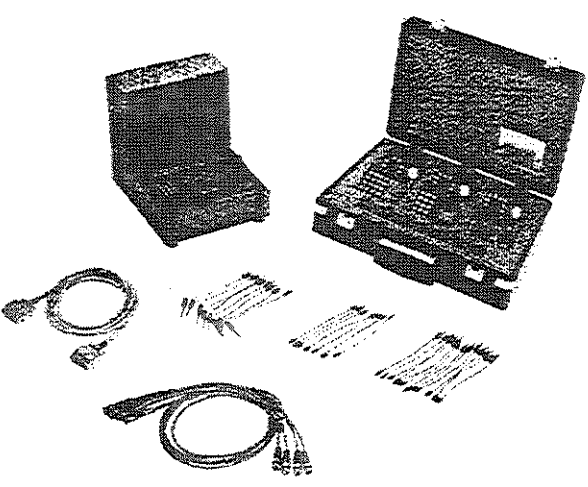

Table 1-3. Accessories Supplied (Sheet 1 of 5)

Configuration	Description
	<p>16058A Test Fixture</p> <p>Shielded Test Fixture for measurement of discrete components. Equipped with safety lid.</p> <p>Following subcomponents are furnished with the 16058A.</p> <p>Personality Board (16058-60003)                      Triaxial Cable (16058-61603), 4ea.                      System Cable (16058-61604)</p> <p>Socket Board/Connection Cable Set*                      (Contents are shown below.)</p>

\* Socket Board/Connection Cable Set (included in the 16058A)

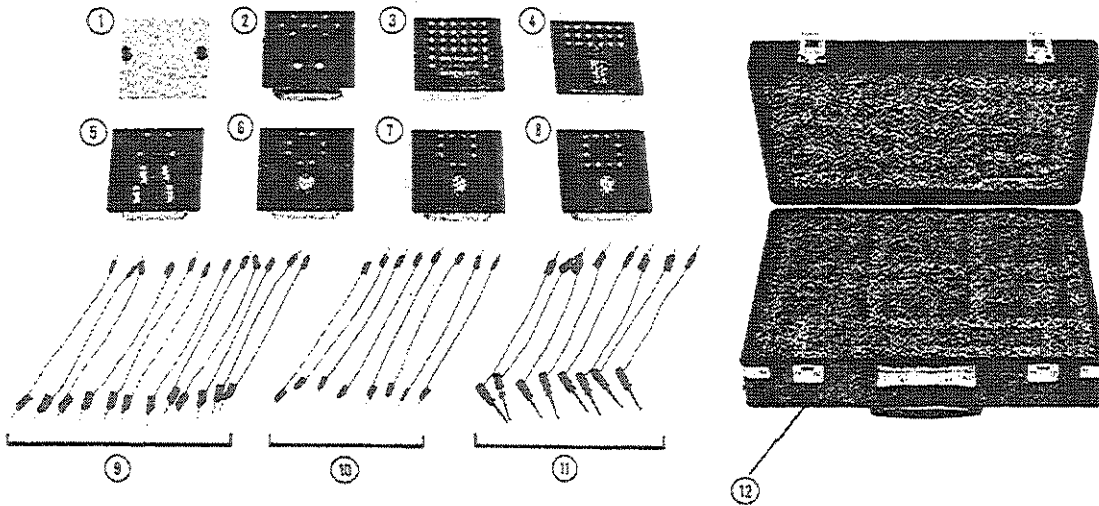

No.	Dimension of Socket (Unit in mm)	HP P/N and Description
①		16058-60004: Blank teflon board for measurement of high resistance devices.
②		16058-60005: Socket Board with two sockets. For measurement of four-pin devices, such as transistors.

Table 1-3. Accessories Supplied (Sheet 2 of 5)

No.	Dimension of Socket (Unit in mm)	HP P/N and Description
③		<p>16147-60002: Socket Board for 28 pin DIP ICs.</p>
④		<p>16058-60007: Socket Board for 18 pin DIP ICs.</p>
⑤		<p>16058-60008: Socket Board with two pairs of sockets for measurement of axial lead devices such as diodes.</p>
⑥		<p>16058-60009: Socket Board with an 8-pin socket.</p>
⑦		<p>16058-60010: Socket Board with a 10-pin socket.</p>
⑧		<p>16058-60011: Socket Board with a 12-pin socket.</p>

Table 1-3. Accessories Supplied (Sheet 3 of 5)

No.	Dimension of Socket (Unit in mm)	HP P/N and Description
⑨	Cable length: Approx. 115	16058-61600: Connection Cable (large-to-small) used for interconnecting the Personality Board to the Socket Board. Twelve 16058-61600s are furnished.
⑩	Cable length: Approx. 115	16058-61601: Connection Cable (small-to-small) used for interconnecting the Connection Switch to the Socket Board. Eight 16058-61601s are furnished.
⑪	Cable length: Approx. 115	16058-61602: Miniature Clip Lead used for direct connection to DUT. Eight 16058-61602s are furnished.
⑫		16058-60100: Carrying-case for all 16058A accessories.
Configuration		Description
		<p>Connector Plate (04145-60001):</p> <p>Connector Plate for measurements made without the 16058A. For example, direct connection for a wafer probe. Dimensions are given below.</p> 

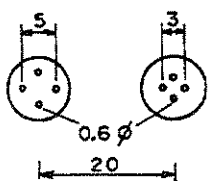
Table 1-3. Accessories Supplied (Sheet 4 of 5)

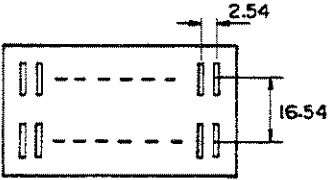
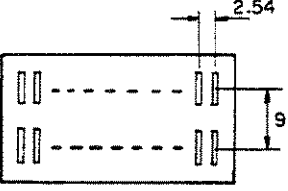
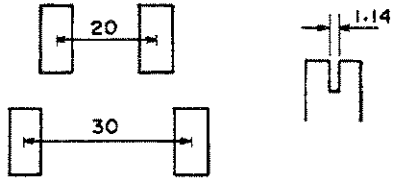
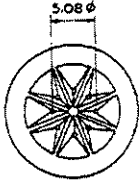
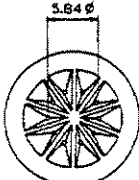
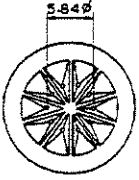

Configuration	Description
	<p>3m Triaxial Cable (04145-61622):</p> <p>Triaxial (m) cable for connection between the 4145B's SMU terminal and the Connector Plate. Cable length is 3m. Four 04145-61622s are furnished. Refer to Figure 3-37 for the usage.</p>
	<p>3m BNC Cable (04145-61630):</p> <p>BNC (m) cable for connection between the 4145B's Vs or Vm terminal and the Connector Plate. Cable length is 3m. Four 04145-61630s are furnished.</p>
	<p>Shorting Connector (04145-61623):</p> <p>When measurement is made without the 16058A, this Connector should be connected to the terminal on the rear panel.</p> <p style="text-align: center;"><b>WARNING</b></p> <p>A POTENTIAL SHOCK HAZARD EXISTS WHEN THE SHORTING CONNECTOR IS CONNECTED TO THE 4145B. DO NOT TOUCH THE OUTPUT TERMINAL OR INNER CONDUCTOR OF SMU DURING MEASUREMENT.</p>

Table 1-3. Accessories Supplied (Sheet 5 of 5)

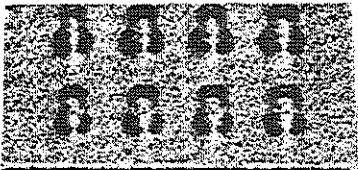
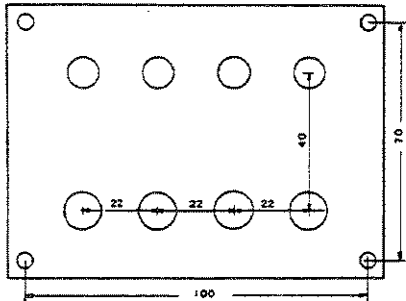
Configuration	Description
	System Disc Set (04145-61501):

## SECTION II INSTALLATION

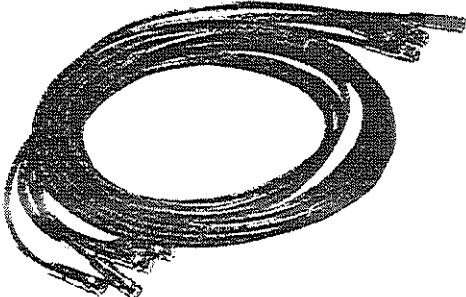
### 2-1. INTRODUCTION

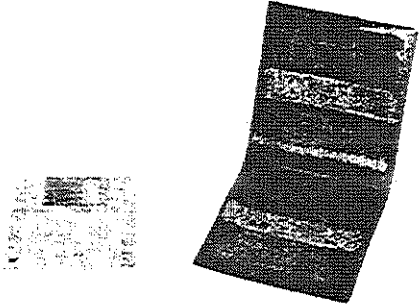
2-2. This section provides installation instructions for the Model 4145B Semiconductor Parameter Analyzer. This section also includes information on initial inspection and damage claims, preparation for using the 4145B, and packaging, storage, and shipment.

### 2-3. INITIAL INSPECTION

2-4. The 4145B Semiconductor Parameter Analyzer, as shipped from the factory, meets all the specifications listed in Table 1-1. Upon receipt, inspect the shipping container for damage. If the shipping container or cushioning material is damaged, it should be kept until the contents of the shipment have been checked for completeness and the instrument has been checked mechanically and electrically. The contents of the shipment should be as shown in Figure 1-1. The procedures for checking the general electrical operation are given in Section III (Paragraph 3-9 SELF TEST) and the procedures for checking the 4145B Semiconductor Parameter Analyzer against its specifications are given in Section IV. First, do the self test. If the 4145B is electrically questionable, then do the Performance Tests to determine whether the 4145B has failed or not.

If the contents are incomplete, if there is mechanical damage or defects (scratches, dents, broken switches, etc.), or if the performance does not meet the self test or performance tests, notify the nearest Hewlett-Packard office (see list at back of this manual). The HP office will arrange for repair or replacement without waiting for claim settlement.

### 2-5. PREPARATION FOR USE

### 2-6. POWER REQUIREMENTS

2-7. The 4145B requires a power source of 100, 120, 220 Volts ac  $\pm 10\%$ , or 240 Volts ac  $+5\%$ - $10\%$ , 48 to 66Hz single phase; power consumption is 270VA maximum.

### WARNING

IF THE INSTRUMENT IS TO BE ENERGIZED VIA AN EXTERNAL AUTOTRANSFORMER UNIT FOR VOLTAGE REDUCTION, BE SURE THAT THE COMMON TERMINAL IS CONNECTED TO THE NEUTRAL POLE OF THE POWER SUPPLY.

### 2-8. Line Voltage and Fuse Selection

#### CAUTION

BEFORE TURNING THE 4145B LINE SWITCH TO ON, VERIFY THAT THE INSTRUMENT IS SET TO THE VOLTAGE OF THE POWER TO BE SUPPLIED.

2-9. Figure 2-1 provides instructions for line voltage and fuse selection. The 4145B is shipped from the factory with the fuse and line voltage selection switch setting appropriate for the geographic area in which the instrument will be used.

#### CAUTION

USE PROPER FUSE FOR LINE VOLTAGE SELECTED.

#### CAUTION

MAKE SURE THAT ONLY FUSES FOR THE REQUIRED RATED CURRENT AND OF THE SPECIFIED TYPE ARE USED FOR REPLACEMENT. THE USE OF MENDED FUSES AND THE SHORT-CIRCUITING OF FUSE-HOLDERS MUST BE AVOIDED.

### 2-10. LINE FREQUENCY FILTER

2-11. To reject the effects of line-frequency noise, set the FILTER switch on the rear panel to the frequency of the ac power source.

2-12. POWER CABLE

2-13. To protect operating personnel, the National Electrical Manufacturer's Association (NEMA) recommends that the instrument panel and cabinet be grounded. The Model 4145B is equipped with a three-conductor power cable which, when plugged into an appropriate receptacle, grounds the instrument. The offset pin on the power cable is the ground wire.

2-14. To preserve the protection feature when operating the instrument from a two contact outlet, use a three prong to two prong adapter (For Japan: Part No. 5080-3149, for other countries: Part No. 1251-8196) and connect the grounding tab on the adapter to power line ground.

CAUTION

THE MAIN PLUG MUST ONLY BE INSERTED IN A SOCKET OUTLET PROVIDED WITH A PROTECTIVE EARTH CONTACT. THE PROTECTIVE ACTION MUST NOT BE NEGATED BY THE USE OF AN EXTENSION CORD (POWER CABLE) WITHOUT PROTECTIVE CONDUCTOR (GROUNDING).

2-15. Figure 2-2 shows the available power cords, which may be used in various countries including the standard power cord furnished with the instrument. HP Part number, applicable standards for power plug, power cord color, electrical characteristics and countries using each power cord are listed in the figure. If

assistance is needed for selecting the correct power cable, contact the nearest Hewlett-Packard office.

2-16. OPERATING ENVIRONMENT

2-17. Temperature. The instrument including the mass storage medium may be operated in temperatures from +10 C to +40 C.

2-18. Humidity. The instrument including the mass storage medium may be operated in environments with relative humidities from 8% to 70% and maximum Wet-bulb temperature 29 °C. However, the instrument should be protected from temperature extremes which cause condensation within the instrument.

2-19. INSTALLATION INSTRUCTIONS

2-20. The HP Model 4145B can be operated on the bench or in a rack mount. The 4145B is ready for bench operation as shipped from the factory. For bench operation a two-leg instrument stand is used. For use, the instrument stands are designed to be pulled towards the front of instrument.

2-21. Installation of Options 907, 908 and 909.

2-22. The 4145B can be installed in a rack and be operated as a component of a measurement system. Rack mounting information for the 4145B is presented in Figure 2-3.

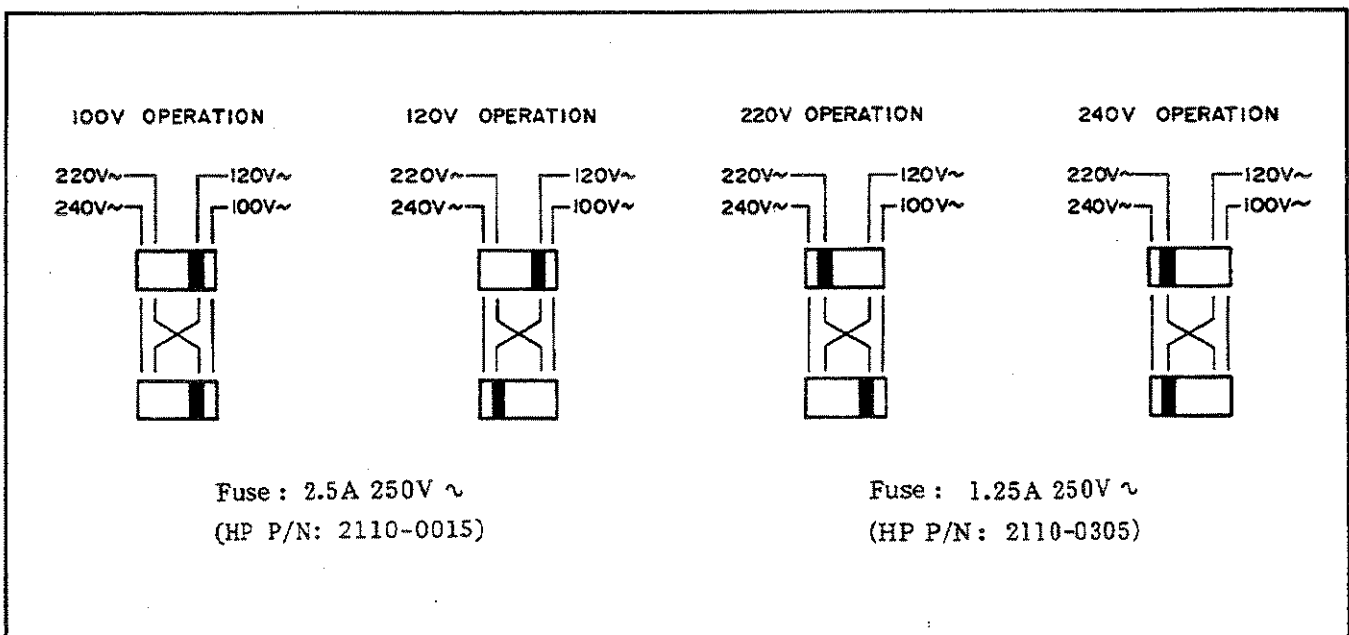
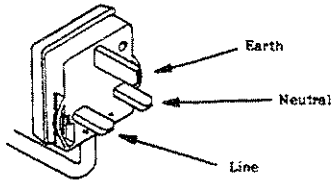
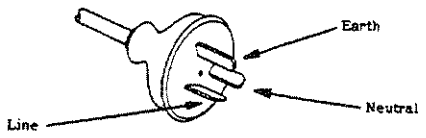
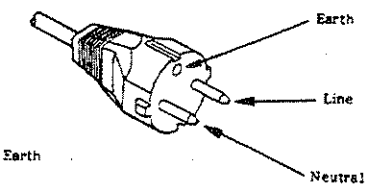
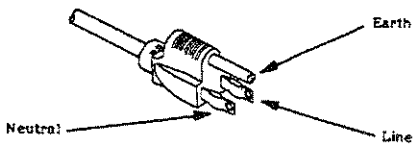
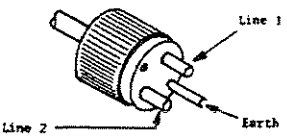
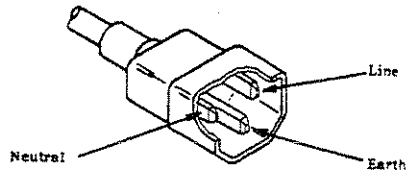
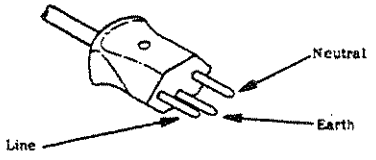
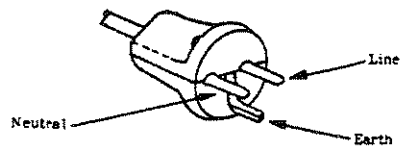
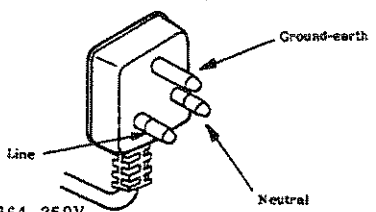
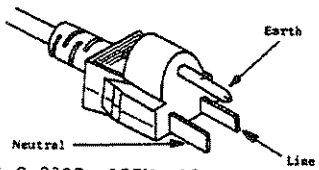

Figure 2-1. Voltage and Fuse Selection

<p>OPTION 900 United Kingdom</p>  <p>Plug: BS 1363A, 250V Cable: HP 8120-1351</p>	<p>OPTION 901 Australia/New Zealand</p>  <p>Plug: NZSS 198/AS C112, 250V Cable: HP 8120-1369</p>
<p>OPTION 902 European Continent</p>  <p>Plug: CEE-VII, 250V Cable: HP 8120-1689</p>	<p>OPTION 903 U.S./Canada</p>  <p>Plug: NEMA 5-15P, 125V, 15A Cable: HP 8120-1378</p>
<p>OPTION 904 U.S./Canada</p>  <p>Plug: NEMA 6-15P, 250V, 15A Cable: HP 8120-0698</p>	<p>OPTION 905* Any country</p>  <p>Plug: CEE 22-VI, 250V Cable: HP 8120-1396</p>
<p>OPTION 906 Switzerland</p>  <p>Plug: SEV 1011.1959-24507 Type 12, 250V Cable: HP 8120-2104</p>	<p>OPTION 912 Denmark</p>  <p>Plug: DHCR 107, 220V Cable: HP 8120-2956</p>
<p>OPTION 917 India/Republic of S.Africa</p>  <p>Plug: SABS 164, 250V Cable: HP 8120-4211</p>	<p>OPTION 918 Japan</p>  <p>Plug: JIS C 8303, 125V, 15A Cable: HP 8120-4753</p>

NOTE: Each option number includes a 'family' of cords and connectors of various materials and plug body configurations (straight, 90° etc.).

\* Plug option 905 is frequently used for interconnecting system components and peripherals.

Figure 2-2. Power Cables Supplied



## 2-23. STORAGE AND SHIPMENT

## 2-24. ENVIRONMENT

2-25. The instrument may be stored or shipped in environments within the following limits:

## Storage :

Not including the mass storage medium  
 Temperature -22 ° C to +55 ° C  
 Humidity 8% to 80% (RH)

Including the mass storage medium  
 Temperature 4 ° C to 53 ° C  
 Humidity 8% to 80% (RH)

## Shipment :

Not including the mass storage medium  
 Temperature -40 ° C to +62 ° C  
 Humidity 8% to 80% (RH)

Including the mass storage medium  
 Temperature -40 ° C to +60 ° C  
 Humidity 8% to 80% (RH)

The instrument should be protected from temperature extremes which cause condensation inside the instrument.

## 2-26. PACKAGING

2-27. Original Packaging. Containers and materials identical to those used in factory packaging are available from Hewlett-Packard. If the instrument is being returned to Hewlett-Packard for servicing, attach a tag indicating the type of service required, return address, model number, and full serial number. Also mark the container FRAGILE to assure careful handling. In any correspondence, refer to the instrument by model number and full serial number.

2-28. Other Packaging. The following general instructions should be used for re-packing with commercially available materials:

- a. Wrap instrument in heavy paper or plastic. If shipping to Hewlett-Packard office or service center, attach tag indicating type of service required, return address, model number, and full serial number.

- b. Use strong shipping container. A double-wall carton made of 350 pound test material is adequate.
- c. Use enough shock absorbing material (3 to 4 inch layer) around all sides of instrument to provide firm cushion and prevent movement inside container. Protect control panel with cardboard.
- d. Seal shipping container securely.
- e. Mark shipping container FRAGILE to ensure careful handling.
- f. In any correspondence, refer to instrument by model number and full serial number.

Option	Kit Part Number	Parts Included	Q'ty
907	Handle Kit 5062-3991	Front Handle Trim Strip Screw	2 2 6
908	Rack Flange Kit 5062-3979	Rack Mount Flange Screw	2 6
909	Rack Flange & Handle Kit 5062-3985	Front handle Rack Mount Flange Screw	2 2 6

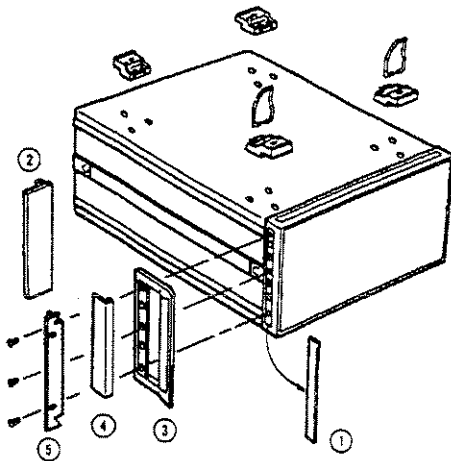

1. Remove adhesive-backed trim strips ① from side at right and left front of instrument.
2. HANDLE INSTALLATION : Attach front handle ③ to sides at right and left front of instrument with screws provided and attach trim ④ to handle.
3. RACK MOUNTING : Attach rack mount flange ② to sides at right and left front of instrument with screws provided.
4. HANDLE AND RACK MOUNTING : Attach front handle ③ and rack mount flange ⑤ together to sides at right and left front of instrument with screws provided.
5. When rack mounting (3 and 4 above), remove all four feet (lift bar at inner side of foot, and slide foot toward the bar).

Figure 2-3. Rack Mount Kit.

## SECTION III OPERATION

### 3-1. INTRODUCTION

3-2. This section provides all the information necessary to operate the Model 4145B Semiconductor Parameter Analyzer. Included are descriptions of the front and rear panels, graphics display, lamps, and connectors; discussions on operating procedures and measuring techniques for typical applications; and instructions on the instruments self-test function and HP-IB capabilities. A breakdown of the contents of this section is given in Figure 3-1. Warnings and cautions are given throughout; they must be observed to insure operator safety and continued instrument serviceability.

TO A PROTECTIVE EARTH-GROUNDED SOCKET. ANY INTERRUPTION OF THE PROTECTIVE EARTH GROUNDING WILL CAUSE A POTENTIAL SHOCK HAZARD THAT COULD RESULT IN SERIOUS PERSONAL INJURY.

ONLY FUSES OF THE REQUIRED RATED CURRENT AND OF THE SPECIFIED TYPE SHOULD BE USED. DO NOT USE REPAIRED FUSES OR SHORTED FUSEHOLDERS. TO DO SO CAN CAUSE A SHOCK OR FIRE HAZARD.

#### WARNING

BEFORE THE INSTRUMENT IS TURNED ON, ALL PROTECTIVE EARTH TERMINALS, EXTENSION CORDS, AUTO-TRANSFORMERS AND DEVICES CONNECTED TO THE INSTRUMENT MUST BE CONNECTED

#### CAUTION

BEFORE THE INSTRUMENT IS TURNED ON, IT MUST BE SET TO THE VOLTAGE OF THE POWER SOURCE (MAINS), OR DAMAGE TO THE INSTRUMENT MAY RESULT.

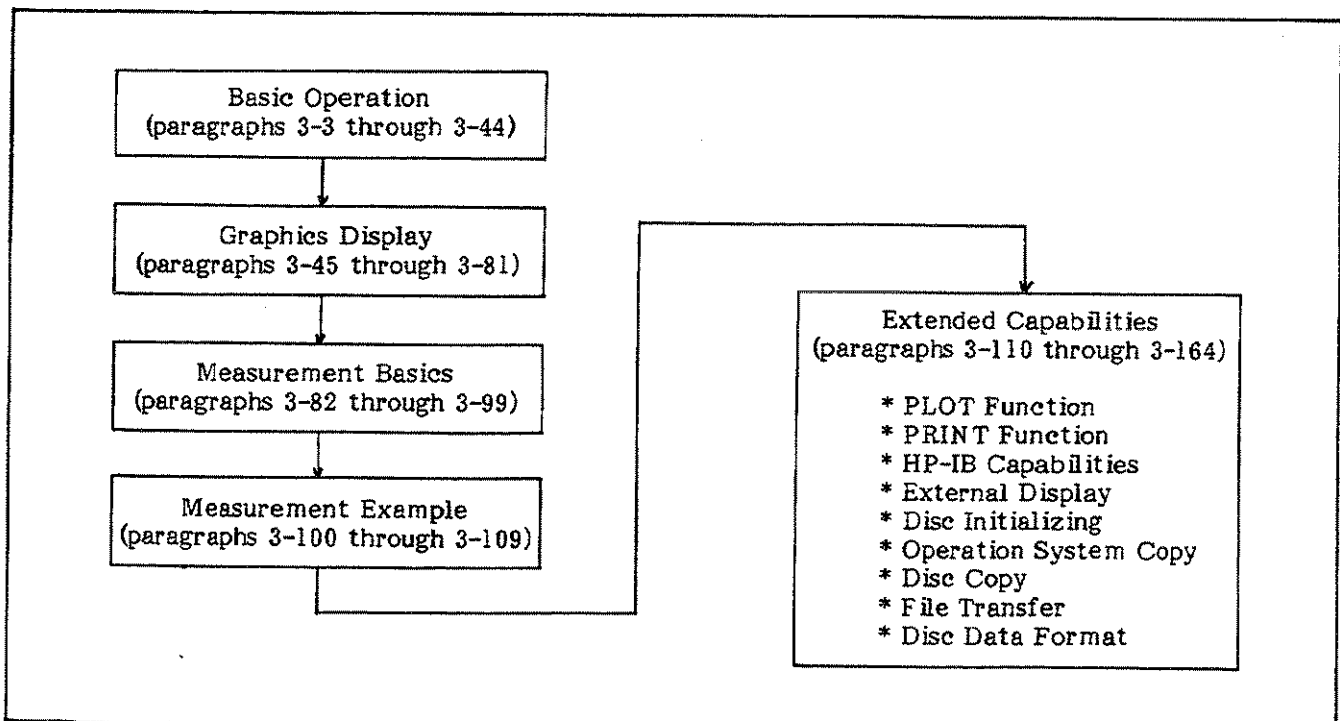
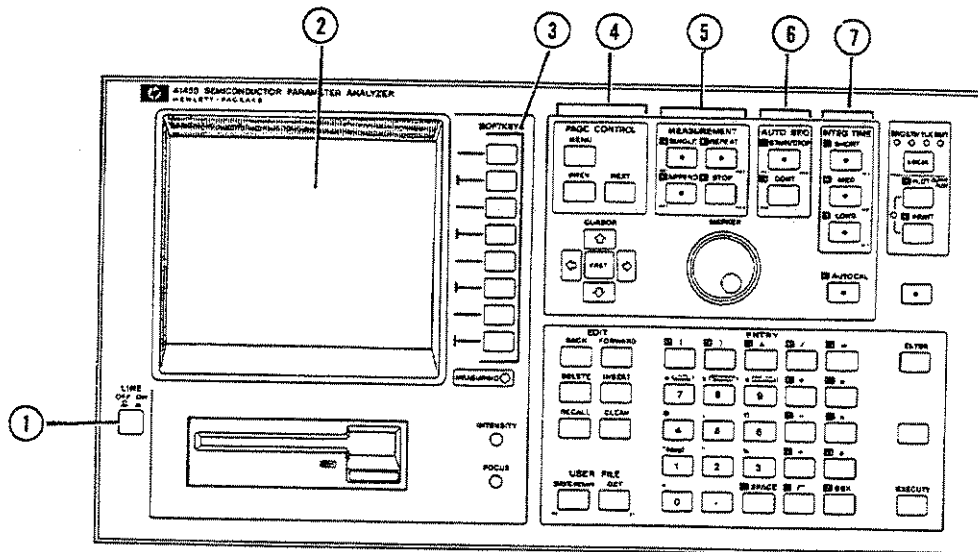

Figure 3-1. Contents of Section III

## 3-3. PANEL FEATURES

3-4. The front and rear panels of the 4145B are briefly described in Figures 3-2 and 3-3, respectively. Detailed information is given starting in paragraph 3-5.



## ① LINE ON/OFF:

Applies ac line power to the instrument when set to the ON (■) position. Removes ac line power when set to the OFF (□) position. SELF TEST is performed each time the instrument is turned on. After SELF TEST is performed, the start-up MENU is displayed.

## ② CRT DISPLAY:

Displays all measurement setups, measurement results, softkey labels, special user functions, operator messages, error codes and messages, and warnings. All displays can be dumped directly onto an HP-IB plotter, without a controller, by pressing the PLOT key (9). If an HP-IB controller, fluent in HP-GL (Hewlett-Packard Graphics Language), is connected, the CRT can be used as an independent graphics display. Refer to paragraph 3-126 and 3-128 for details.

## ③ SOFTKEYS:

These eight keys are used for measurement setup, parameter selection, and function selection. The function of each softkey is defined by the operating system software and changes depending on the page displayed. Softkeys labels are displayed on the CRT (2) in the form of a "softkey prompt" (SKP). Each time the SKP changes, the functions of the corresponding softkey changes. Pressing the EXTN (extended) displays additional softkey functions. A description for each softkey function is provided in the description of the page on which it appears.

## ④ PAGE CONTROL Keys:

These three keys control paging on the CRT (2). Refer to paragraph 3-45 for a description of the PAGE concept.

**MENU:** When pressed, returns the display to the start-up menu. Can be used anytime except during measurement or auto-calibration or other functioning.

Figure 3-2. Front Panel Features (Sheets 1 of 6)

**NEXT:** Advances the display to the next page. Each time this key is pressed, the instrument checks the presently displayed page for any illegal settings, and if it detects any errors, it displays the corresponding error code or error message and does not advance to the next page, or automatically changes the settings.

**PREV:** Returns the display to the previous page. Each time this key is pressed, the instrument checks the presently displayed page for any illegal settings.

### ⑤ MEASUREMENT Keys:

These keys start and stop the measurement. After all measurement conditions have been set and the GRAPHICS PLOT page, LIST DISPLAY page, MATRIX DISPLAY page, or SCHMOO PLOT page is displayed, measurement is started by pressing SINGLE, REPEAT, or APPEND. Measurement can be stopped by pressing STOP. Measurement is a sequential operation consisting of voltage or current sweep, measurement, and storage of the measurement result.

**SINGLE:** When this key is pressed, results of the previous measurement are erased from memory, the new measurement is made, and the results are stored in memory.

**REPEAT:** When this key is pressed, measurement is repeatedly made until STOP is pressed. Results of the previous measurement are updated during each new measurement.

**APPEND:** Functions similarly to the SINGLE key except that results of the previous measurement are not erased from memory of the CRT. Results of a measurement made using this key are stored in the remaining unused portion of memory and are displayed over (overlay plot) the previous plot. Measurement can be made using this key until "Buffer full" is displayed.

**STOP:** Immediately stops the measurements.

### ⑥ AUTO SEQ Key:

These keys start and stop the ASP (Auto Sequence Program) listed on the SETUP AUTO SEQUENCE page. Refer to paragraph 3-66 for details on Auto Sequence Programs.

**START/STOP:** Starts the ASP from line 1. If pressed during the ASP, the ASP stops immediately. Once stopped, the ASP cannot be continued from the stop point.

**CONT:** If the ASP contains a PAUSE statement, this key continues the program from the line immediately following the PAUSE statement.

### ⑦ INTEG TIME Keys:

These keys are used to select the digital integration time. When MED or LONG integration is selected, the integration time is an integral number of the line frequency period, eliminating line frequency noise. SHORT is the initial control setting. The integration time can be changed at any time, even during measurement.

**SHORT:** Measurement data is stored directly into memory without integration.

**MED:** Integration time is set to one line frequency period. Sixteen samples are taken at each measurement point.

**LONG:** Integration time is set to sixteen line frequency periods. A total of 256 samples are taken at each measurement point.

Figure 3-2. Front Panel Features (Sheets 2 of 6)

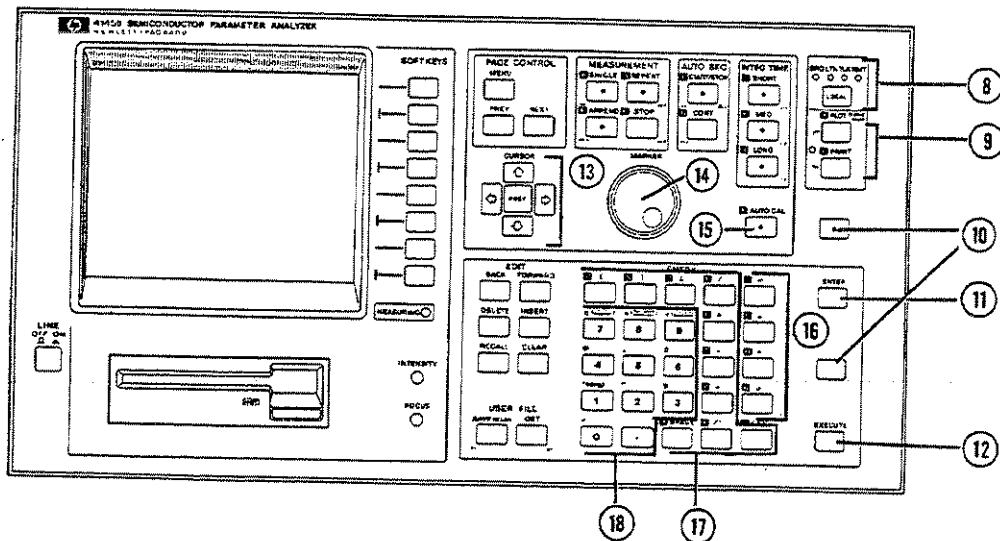

**8** HP-IB Status Indicators and LOCAL Key:

These four LED lamps—SRQ, LISTEN, TALK, and REMOTE—indicate the status of the 4145B when interfaced with a controller via the HP-IB, or connected directly to a printer/plotter. The LOCAL key, when pressed, releases the 4145B from remote (HP-IB) control and enables control from the front panel. The LOCAL key does not function when the instrument is set to local lockout by the controller or in the GL mode.

**9** PLOT and PRINT Keys

The PLOT key is used to dump whatever is displayed on the CRT directly onto an HP-IB graphics plotter (e.g., HP7440A), without a controller. A measurement curve can be plotted from the GRAPHIC PLOT page by pressing the green key before pressing the PLOT key. Plot area can be set from the 4145B's front panel. Plotting starts when EXECUTE is pressed. Pressing PLOT a second time stops the plot immediately. Refer to paragraph 3-94 for more information on the PLOT function. The PRINT key functions similarly to the PLOT key except that a printer is used instead of a plotter and only alphanumeric data is output. If the PRINT key is used to output the results of a graphic plot, for example, only the numeric value of each measurement point is printed. Refer to paragraph 3-96 for more information on the PRINT function.

**10** BLUE Key and GREEN Key:

These keys are used to access additional key functions. Additional key functions are labeled in blue and green.

**BLUE Key:** This key is used when entering comments, variables, and program names. Once this key is pressed (key indicator lamp on), it remains on until pressed again. When the CHANNEL DEFINITION page is displayed or when a SAVE/GET operation, COMMENT operation or PURGE operation is being performed, the BLUE key is automatically set to ON (key indicator lamp on).

**GREEN Key:** This key is used when entering physical constants, certain special symbols and when two special functions, CURVE PLOT and RE-SAVE, are executed. It must be pressed each time a function which requires pressing the green key is executed.

Figure 3-2. Front Panel Features (Sheets 3 of 6)

**⑪ ENTER Key:**

This key is used to enter parameter values, alphanumeric characters, special characters, and unit indicators displayed on the Keyboard Input Line (see Figure 3-5) into the internal display buffer. When this key is pressed, data displayed on the Keyboard Input Line is moved to the display field indicated by the field pointer ( ) and stored in the display buffer. Data stored in the display buffer by the ENTER key can be recalled (re-displayed on the Keyboard Input Line) by pressing the RECALL Key ⑲. Up to 60 characters can be entered into the buffer, but only 27 characters can be displayed at one time. To display the rest of the buffer contents, use the BACK key or FORWARD key.

**⑫ EXECUTE Key:**

This key executes GET, SAVE, RE-SAVE, PRINT, PLOT, CURVE-PLOT, and PURGE commands, and arithmetic expressions displayed on the Keyboard Input Line.

Note: The PURGE command is available only when the USER FILE CATALOG is displayed.

**⑬ CURSOR Control Keys:**

These keys control the positioning of the field pointer (▶) and the long and short cursors. (They do not control the cursor on the Keyboard Input Line.)

**Field Pointer Control:**

Pressing the ↑, ↓, ←, or → key moves the field pointer (▶) in the indicated direction. The FAST key cannot be used for field pointer control.

**Long/Short Cursor Control:**

Pressing the ↑, ↓, ←, or → key moves the cursor in the indicated direction. Movement continues until the key is released. Two direction-keys can be pressed simultaneously to move the cursor diagonally. Pressing the FAST key in conjunction with one or two of the direction keys, causes the cursor to move more rapidly.

**⑭ MARKER Control Dial:**

This dial controls the marker (⊙ or \*) on the GRAPHICS PLOT page. Rotating the dial clockwise moves the marker from the sweep start point to the sweep stop point.

**⑮ AUTO CAL KEY:**

This key enables continuous auto-calibration of the 4145B. The AUTO CAL function is set to ON (key indicator lamp on) when the instrument is turned on. Refer to paragraph 3-42 for details.

**⑯, ⑰, ⑱ DATA ENTRY Keys:**

These keys are used to enter numeric values, arithmetic operators, and engineering units. Data entered with these keys is displayed on the CRT's Keyboard Input Line and entered into the display buffer by pressing the ENTER key ⑪. An arithmetic expression entered with these keys is executed by pressing the EXECUTE key.

**⑲ Engineering Unit Keys:**

Four engineering units are available—m (milli,  $10^{-3}$ ),  $\mu$  (micro,  $10^{-6}$ ), n (nano,  $10^{-9}$ ), and p (pico,  $10^{-12}$ )—for use with the numeric keys ⑱.

**⑳ Arithmetic Operator and Function Keys:**

Nine arithmetic operators and functions are available—+, -, \*, /,  $\sqrt{\quad}$ ,  $\Delta$ , EEX (scientific notation)—for use in arithmetic calculations. Five additional operator and functions are available with the alphabetic (blue) keys: \*\* (exponentiation), LOG, LN (natural log), EXP (natural base), and ABS (absolute). The SPACE key is also included in this key group.

**㉑ Numeric Keys:**

These keys—0 through 9 and decimal point—are used for entering measurement parameter values and for making quick arithmetic calculations.

Figure 3-2. Front Panel Features (Sheets 4 of 6)

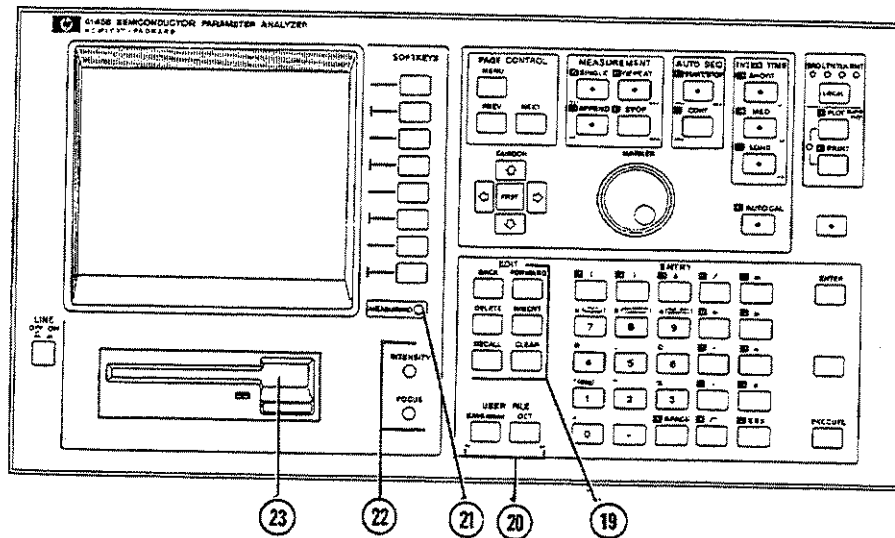

19 EDIT Keys :

These keys are used to edit data displayed on the Keyboard Input Line.

**BACK :** Moves the Keyboard Input Line cursor (—) left one position. If this key is pressed while the cursor is at the left-most position, the displayed text will move to the right.

**FORWARD :** Moves the Keyboard Input Line cursor (—) right one position. If this key is pressed while the cursor is at the right-most position, the displayed text will move to the left.

**DELETE :** Causes the character at the position of the cursor to be deleted. The cursor remains at the same position and all text to the right of the deleted character moves one position to the left as each character is deleted.

**INSERT :** Causes the character at the position of the cursor and all text to the right of the cursor to move right one position, leaving a space at the position of the cursor and allowing insertion of additional characters. To exit from this mode, press INSERT a second time.

**RECALL :** Causes previous entries or executions to be re-displayed on the Keyboard Input Line.

**CLEAR :** Clears all text from the Keyboard Input Line and returns the cursor to the home (left-most) position.

Figure 3-2. Front Panel Features (Sheet 5 of 6).



⑳ USER FILE Keys:

These keys are used to store program or data files onto the disc or to recall them.

**SAVE:** Used to store the existing measurement setup, measurement result, or auto-sequence program onto the flexible disc. Press SAVE, enter the file type (P for a measurement setup, D for a measurement result, S for an auto-sequence program), file name, and comment (if necessary), and then press EXECUTE 12.

**RE-SAVE:** Used to store, by the file names that have been used already on the micro flexible disc, the existing measurement setup measurement results, or auto-sequence program onto the disc. Press the GREEN key, then press the SAVE key, enter the file name, and comment (if necessary) then press EXECUTE ⑫.

**GET:** Used to recall a measurement setup, measurement result, or auto-sequence program from the flexible disc. Press GET, enter the file type (P for a measurement setup, D for a measurement result, S for an auto-sequence program), and file name, and then press EXECUTE ⑫.

㉑ MEASURING Lamp:

This lamp comes on when the 4145B is measuring. When measurement is completed or when the STOP key is pressed, this lamp goes off immediately.

㉒ CRT Adjustment:

INTENSITY determines the brightness of traces displayed on the CRT. FOCUS adjusts the writing beam for sharp, well-defined traces.

㉓ MICRO FLEXIBLE DISC DRIVE:

Accommodates a 630K byte, double-sided, double-density, 3.5 inch micro flexible disc, and functions as the 4145B's mass storage unit (MSU). The yellow lamp, located on the left side of the flexible disc eject button, comes on when the 4145B is storing data on the disc or retrieving data from the disc. Refer to paragraph 3-5 for information on proper handling of the micro flexible disc.

Figure 3-2. Front Panel Features (Sheets 6 of 6)

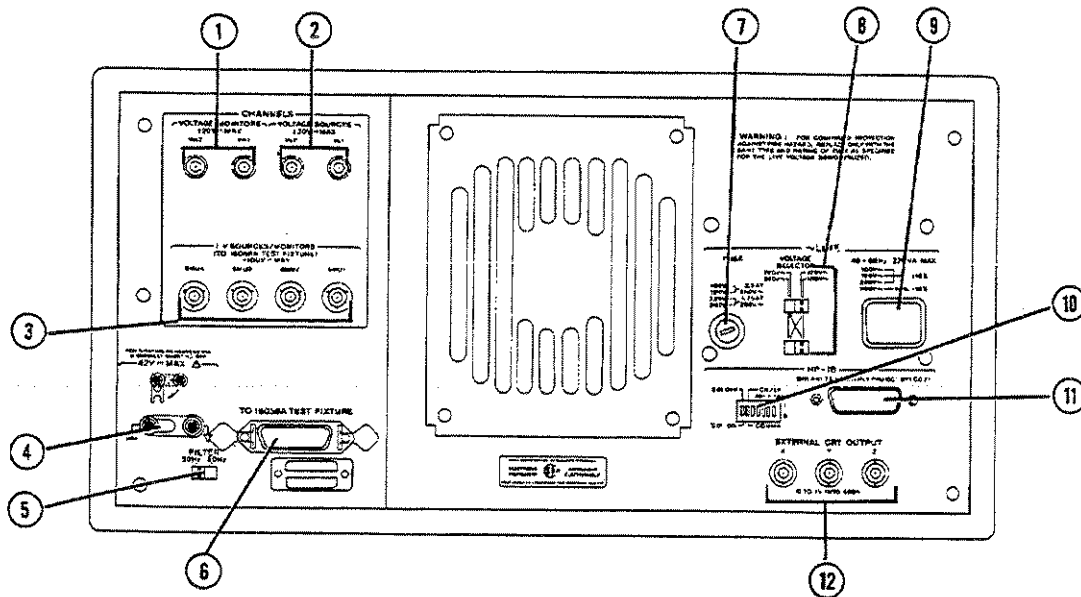

① Voltage Monitor (Vm) Input Connectors:

Two female BNC connectors for input to Vm1 and Vm2. Used in applications in which a user-fabricated test fixture is used. These connectors cannot be connected to the 16058A Test Fixture. Maximum allowable input voltage is  $\pm 20V$  dc.

② Voltage Source (Vs) Output Connectors:

Two female BNC connectors for Vs1 and Vs2. Used in applications in which a user-fabricated test fixture is used. These connectors cannot be connected to the 16058A Test Fixture. Maximum output voltage is  $\pm 20V$  dc.

③ SMU Output Connectors:

Four triaxial connectors for SMU1 through 4. Can be connected to the 16058A Test Fixture or to a user-fabricated test fixture. Each connector outputs or measures up to  $\pm 100V$  or  $\pm 100mA$ .

④ COM (COMMON)-GROUND Terminals:

Common ( $\nabla$ ) and Ground ( $\perp$ ) for floating and grounded measurements. The common terminal is tied directly to the outer-conductor of the Vm ①, Vs ②, and SMU ③ connectors; the ground terminal is tied directly to the instrument chassis. For grounded measurements, these terminals must be interconnected using the shorting-bar. For floating measurements, disconnect the shorting-bar.

WARNING

A POTENTIAL SHOCK HAZARD MAY EXIST WHEN COMMON IS NOT CONNECTED TO GROUND (SHORTING-BAR DISCONNECTED). DO NOT, REGARDLESS OF THE OUTPUT VOLTAGE, TOUCH THE COMMON TERMINAL OR OUTER CONDUCTOR OF THE SMU, Vs, OR Vm CONNECTORS DURING A FLOATING MEASUREMENT (SHORTING-BAR DISCONNECTED).

Figure 3-3. Rear Panel Features (Sheet 1 of 2)

**⑤ FILTER Switch:**

This switch determines the measurement integration time, to reduce the effects of line-frequency noise. Set this switch to the frequency of the ac power source.

**⑥ System Cable Connector:**

Twenty-four pin connector for inter-connection between the 16058A Test Fixture and the 4145B. Vs1, Vs2, Vm1, Vm2, and the fixture-lid-open detector are connected to this connector. When the 16058A is not used, this connector should be terminated with the furnished shorting-termination if voltages exceeding  $\pm 42V$  are to be output.

**WARNING**

WHEN THE SHORTING-TERMINATION IS CONNECTED TO THE SYSTEM CABLE CONNECTOR, THE 4145B'S PROTECTIVE CIRCUIT IS DISABLED. VOLTAGES AT THE SMU AND Vs OUTPUTS CAN REACH  $\pm 100V$  AND  $\pm 20V$ , RESPECTIVELY. DO NOT TOUCH THE POINT OR POINTS AT WHICH THE SMU'S OR VOLTAGE SOURCES ARE CONNECTED.

**⑦ LINE FUSE Holder:**

The 4145B's power-line fuse is installed in this holder.

100V/120V operation:  
2.5AT, 250V (HP P/N: 2110-0015)

200V/240V operation:  
1.25AT, 250V (HP P/N: 2110-0305)

**⑧ LINE VOLTAGE SELECTOR Switches**

These switches select the appropriate ac operating voltage. Selectable voltages are 100V/120V $\pm 10\%$  and 220V $\pm 10\%$  / 240V $\pm 5\%$  -10% (48 - 66Hz). Refer to paragraph 2-5.

**⑨ LINE Input Receptacle:**

AC power cable is connected to this receptacle. Refer to paragraph 2-5.

**⑩ HP-IB Control Switch:**

This switch sets the 4145B's HP-IB address (0 - 30), data output format (COMMA or CR/LF), and interface capability (EOI ON or OFF). Specific information on this switch is given in paragraph 3-118.

**⑪ HP-IB Connector:**

Twenty-four pin connector; connects the 4145B to the HP-IB for remote operations. Also used to connect a printer/plotter.

**⑫ External CRT Output Connectors:**

Three BNC (f) connectors for connection to an external X-Y-Z display. Refer to paragraph 3-142.

Figure 3-3. Rear Panel Features (Sheet 2 of 2)

## 3-5. MICRO FLEXIBLE DISC HANDLING

3-6. One system disc is furnished with the 4145B. The system disc contains the 4145B, and 573k bytes of user area. Precautions on handling and storing the Micro Flexible Discs are given below.

1. Make sure the shutter is closed when the disc is not in use.
2. Store discs in a clean, dry, fireproof cabinet. Do not expose to direct sunlight, extremes of temperature or humidity, or magnetic field.
3. Do not touch the exposed surface of the disc.
4. Use a soft felt tip pen to label your disc, and be careful to write only in the label area.
5. Do not try to clean the disc.

## Note

There is always a chance of losing disc data. The best protection against data loss or system data loss is frequent back up of your files. Refer to paragraph 3-144 Initializing Disc, 3-146 Operating System Copy

Precaution on inserting and removing the Micro Flexible Discs are given below.

6. Insert the disc with the metal shutter toward the drive and the metal centering hub down. Carefully slide the disc into the drive until you feel it contact the rear of the drive. Continue pressing the disc until it is pulled down into the drive.
7. Remove the disc by depressing the disc eject button that is located at under right of the disc drive and pulling the disc straight out. Make sure the shutter is closed before storing the disc.

The procedure to follow when write-protecting the disc is shown in Figure 3-4.

## 3-7. CRT DISPLAY

## 3-8.

The 4145B is equipped with the HP Model 1345A Digital Display. Useable display area on the CRT is shown in Figure 3-5. Operator adjustments are given in Figure 3-6.

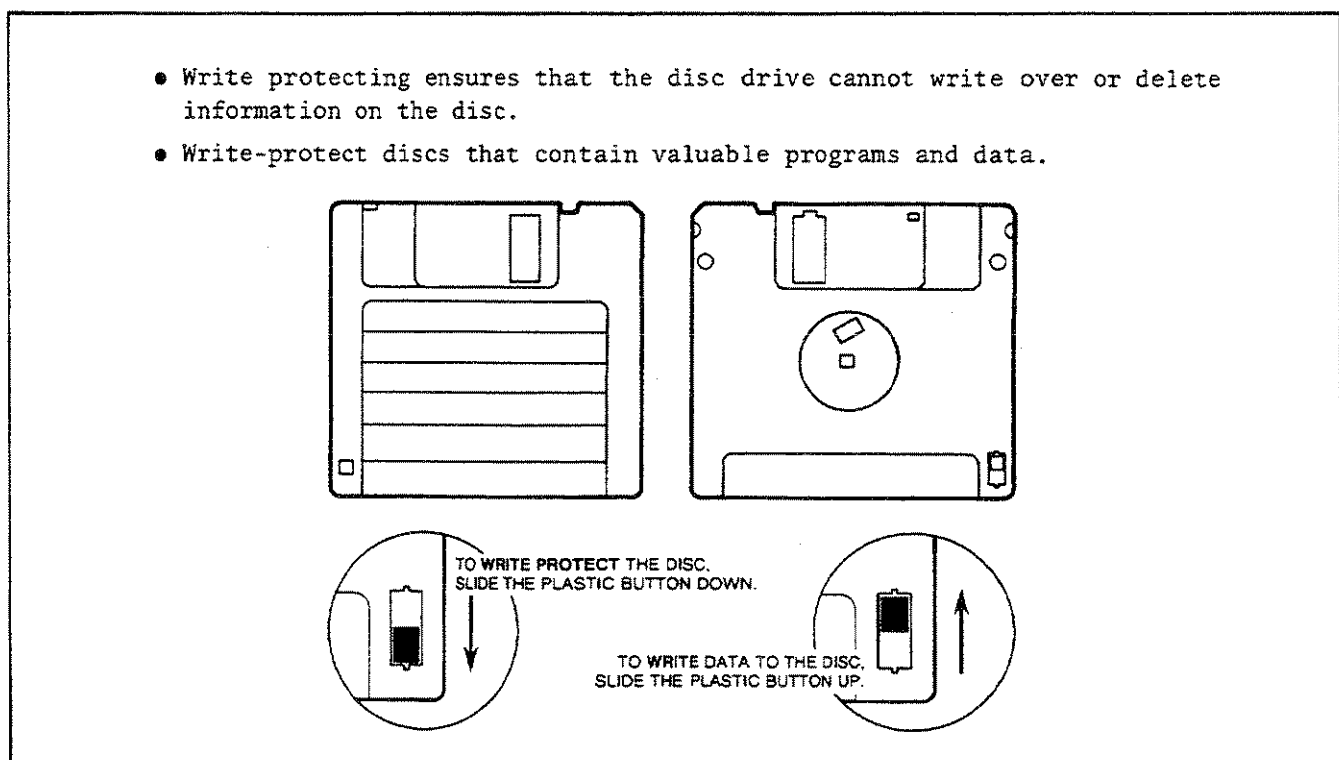
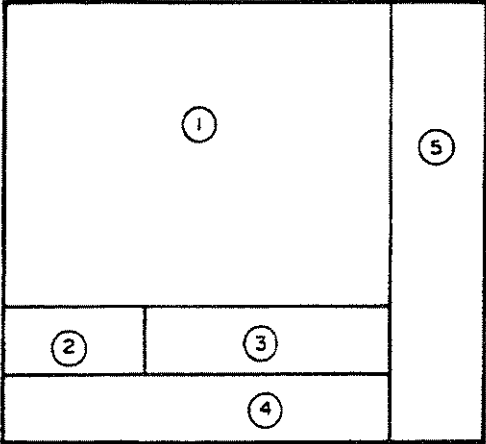

Figure 3-4. Write Protecting



The CRT is sectioned into five areas, as shown in the figure. Description for each area is as follows:

- ① **Page Display Area:**  
The instrument's various pages are displayed in this area. When the PLOT key is pressed, only this area is output to the plotter.
- ② **Command Display Area:**  
The SAVE, RSAVE, GET, PLOT, CPLOT, PRINT and PURGE commands are displayed in this area.
- ③ **Keyboard Input Line:**  
All keyboard (front panel) entries are displayed in this area. Up to 60 characters can be entered but only 27 can be displayed. To edit the displayed characters, use the BACK, FORWARD, DELETE and INSERT keys. When the RECALL key is pressed, the previous entry is re-displayed.
- ④ **System Message Line:**  
Displays instructions, error messages, and error codes. When the instrument is turned on, instrument status is displayed.
- ⑤ **Softkey Prompt Display Area:**  
Displays Softkey Prompts (SKP).

Note

2 3 and 4 are erased by pressing the CLEAR key.

Figure 3-5. Useable Display Area

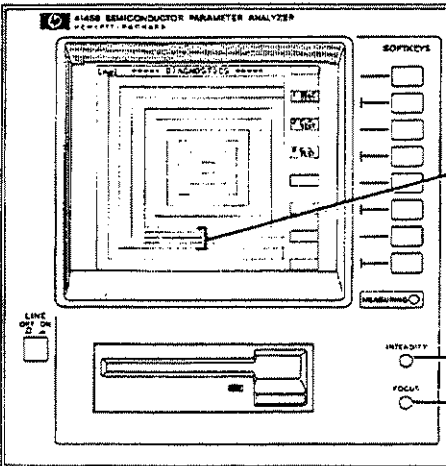

CRT intensity and focus adjustment. (Requires a small flat-tip screwdriver.)

- (1) Turn on the 4145B. The MENU page will be displayed on the CRT.
- (2) Press the EXTN softkey and the DIAG softkey.
- (3) Press the GDU TEST softkey. Display will be as shown in the figure.
- (4) Adjust INTENSITY ② until all three lines (each line has a different intensity) are visible. (①)
- (5) Adjust FOCUS ③ until the corners of the displayed trace are sharp.
- (6) Press the MENU key.

Figure 3-6. Operator Adjustment

## 3-9. SELF TEST

3-10. The 4145B is equipped with an automatic self-diagnostic function that is initiated each time the instrument is turned on to confirm normal operation of the instrument's basic functions. The SELF TEST can also be initiated from the DIAGNOSTICS page or via the HP-IB. When SELF TEST is performed at instrument turn-on, the five tests listed in Table 3-1 are automatically performed. If the instrument is operating normally, the MENU page will be displayed when the SELF TEST is completed. If an error is detected, an error code will be displayed on the CRT. When SELF TEST is initiated from the DIAGNOSTICS page or via the HP-IB, only two tests are performed (MPU test and SMU test). If the instrument fails the SELF TEST, contact the nearest Hewlett-Packard Service Office (see list at back of this manual).

## 3-11. ERROR MESSAGES/ERROR CODES

3-12. Error messages and error codes are displayed on the System Message Line of the CRT whenever an illegal operation or out-of-range measurement is made, or whenever an internal circuit fails. Error messages and error codes related to operator errors (not instrument failure) are listed in Table 3-2 and 3-3, respectively. Error codes related to instrument failure are listed in Table 3-4. If the instrument displays one of the error codes listed in Table 3-4, contact the nearest Hewlett-Packard Sales/Service Office.

## Note

One of the error codes listed in Table 3-4 may be displayed if the instrument is turned on after experiencing an extreme change of ambient temperature. In this case, allow the instrument to fully warm up (ignore the displayed error code), and then turn it off and on one time.

Table 3-1. 4145B SELF TEST

Test Name	Description
MPU test	Checks the basic functions of the MPU (Microprocessor Unit) by checking four ROMs (Read-Only Memory) and sixteen RAMs (Random-Access Memory).
GDU test	Checks the functions of the GDU (Graphics Display Unit).
MSU test	Checks the MSU (Mass Storage Unit: Micro Flexible Disc Drive and Disc).
HP-IB test	Checks all HP-IB interface capabilities.
SMU test	Checks the basic functions of the four SMUs.

Table 3-2. Error Messages (Sheet 1 of 2)

Error Message	Meaning	Corrective Action
No source name	An SMU that has been assigned a source mode (COM, V, or I) has not been assigned a corresponding V or I source name.	If the source mode is COM or V, enter a source name in the V column; if the source mode is I, enter a source name in the I column.
Duplicate name	Two or more channels have the same name.	Re-assign the channel names.
Illegal function	VAR1, VAR1', or VAR2 is specified more than once.	Specify VAR1, VAR1', and VAR2 only once.
	VAR1 and VAR1' are not in the same source mode.	Set VAR1 and VAR1' to the same source mode.
Overflow	Number of steps for VAR1 exceeds 1024.	Change the value of START/STOP or STEP.
	An attempt was made to input a value that is outside specified limits.	Enter a value that is within specified limits.
No name	No name is entered in the NAME field on the MEAS/DISP MODE SETUP page.	Select a name from those displayed in the softkey prompt area.
No monitor channel	No monitor channel name is entered in the NAME field on the MEAS/DISP MODE SETUP page, or the name entered in the NAME field cannot be used as a monitor channel name.	Select a monitor channel name from those displayed in the softkey prompt area.
Illegal set up	LOG Sweep: START and STOP (MIN and MAX) values have different signs.	Change one of the signs.
	Current value is too high because source mode has been changed from V to I.	Change the current (I) value setting.
	INTERVAL or NO. OF RDNGS for a time domain measurement is set to 0.	Enter correct value: Up to 10s for INTERVAL and from 1 to 1024 for NO. OF RDNGS.
	Duplications on the OUTPUT SEQUENCE SETUP page.	Rearrange the output sequence.
Buffer full	Measurement data exceeds the capacity of the data buffer.	Data buffer capacity is 1024 measurement points for a single sweep, or up to 1150 (depends on the number of monitor channels used, VAR2 steps and the number of times APPEND is used) in other cases.

Table 3-2. Error Messages (Sheet 2 of 2)

Error Message	Meaning	Corrective Action
Syntax error	An illegal name was entered in a GET, SAVE or RE-SAVE command.	The first character of a file name must be alphabetic, and all succeeding characters must be alphanumeric.
	PLOT area is not specified, contains one or more alphabetic characters, or is missing coordinate delimiters (comma or space).	Re-enter the PLOT area correctly.
	Illegal file type.	Use P, D, or S for the file type.
Busy	Auto calibration is being performed.	Auto calibration is performed every 5 minutes.
No data	PRINT Key was pressed with no measurement data in the data buffer.	Perform a measurement.
Printer/ Plotter is not connected	No printer or plotter is connected to the instrument, or the printer or plotter is not set to LISTEN.	Connect the printer or plotter.
Not compatible	The discs used in the copy operation have different system labels, or one of the discs is not a 4145B useable disc.	Copy the Operating System onto the the illegal disc or turn into the Data Disc.
Close the fixture lid	The fixture lid is open at the start of a measurement exceed $\pm 42V$ or lid is open during the User Mode (See Fig. 52).	Close the lid or change the setup. Make sure the system cable is properly connected.
Output disabled, close the fixture lid	The fixture lid was opened during a measurement in which the output voltage may exceed $\pm 42V$ .	Close the fixture lid and make the measurement again. Do not open the fixture lid during measurement. Make sure the system cable is properly connected.
Emergency	Output was shut down to prevent SMU damage.	Make sure the setup and all connections are correct.
Recovered from power down	Indicates that there was a momentary power loss.	When a power loss occurs during measurement, output is shut down. Press MEASUREMENT key to continue the measurement.
Step overflow	NO OF STEPS for VAR1 exceeds 1024.	Change START value, STOP value, or STEP value.
Disabled function	A disabled softkey was pressed.	The softkey cannot be used in the existing measurement setup.



Table 3-3. Operational Error-Codes (Sheet 1 of 2)

Display	Meaning
Error E01	Arithmetic operator (-, +, /, *) or parenthesis is required.
Error E02	EXECUTE was pressed with no executable text on the Keyboard Input Line.
Error E03	Object buffer overflow.
Error E04	Improper $\Delta$ (delta) operation.
Error E05	User function is used in the expression. (User function cannot be used in an arithmetic expression.)
Error E06	No variable or constant following an arithmetic operator.
Error E07	Arithmetic expression contains an undefined variable.
Error E08	Too many signs or parentheses.
Error E09	Constant value is too large.
Error I01	Stack Register overflow.
Error I02	Improper calculation was attempted. For example, the divisor is zero.
Error I03	Insufficient data.
Error M02	Disc is not inserted or is not correctly inserted.
Error M03	The disc is write protected.
Error M04	Illegal file name or file type.
Error M05	The file name specified in the SAVE command has already been reserved for the specified file type.
Error M06	Number of total files exceeds.
Error M07	Number of total records exceeds.
Error M08	User area may be lost. Copy immediately onto another disc.
Error M19	The disc was not initialized for the 4145B.
Error M20	INITIALIZE failed. Too much bad tracks found. The disc is defective, damage, or dirty.
Error M22	The disc is not System Disc. Insert the System Disc.
Error Z01	The program specified by the GET command in the auto-sequence program contains an error. Press CONT to perform the next step of the auto-sequence program.
Error Z02	The SINGLE command can be executed from the GRAPHICS, MATRIX, LIST, or SCHMOO page only. Press CONT to perform the next step of the auto-sequence program.

Table 3-3. Operational Error-Codes (Sheet 2 of 2)

Display	Meaning																								
Error Z03	PLOT or PRINT was performed by the auto-sequence program but no printer/plotter is connected to the 4145B or the printer/plotter is not set to LISTEN. Press CONT to perform the next step of the auto-sequence program.																								
Error Z04	The test fixture lid is open during an auto-sequence program in which the output voltage may exceed $\pm 42V$ . Press CONT to perform the next step of the auto-sequence program.																								
Data Errors	<p>Depending on the number of channels used in the measurement, up to six 2-digit numbers are displayed, in the format shown below, whenever the measurement cannot be performed correctly.</p> <p style="text-align: center;">Error DXX XX XX XX XX XX</p> <p>Here, XX is a 2-digit number which represents channel status. The left-to-right order in which the 2-digit error codes appear corresponds to the order in which the channels are assigned on the MEAS/DISP MODE SETUP page. Also, the number of 2-digit error codes that appear is identical to the number of channels used in the measurement. The left digit of XX is hexadecimal and must be converted into a 4-digit binary number, as described below. The right digit is decimal and requires no conversion. Also, zero means no error.</p> <p><u>XX</u></p> <ul style="list-style-type: none"> <li>1: Stack register overflow</li> <li>2: Calculation error</li> <li>3: Insufficient data for <math>\Delta</math> measurement</li> <li>7: Undefined user-function</li> <li>8: INTERVAL in a time domain measurement is too short. Complete measurement data cannot be stored before the next measurement begins.</li> </ul> <p>Convert hexadecimal number into binary.</p>  <p>Channel correspondence is shown below:</p> <p>GRAPHICS PLOT:</p> <table style="margin-left: auto; margin-right: auto;"> <tr> <td>Error</td> <td>DXX</td> <td>XX</td> <td>XX</td> </tr> <tr> <td></td> <td>X axis</td> <td>Y1 axis</td> <td>Y2 axis</td> </tr> </table> <p>LIST DISPLAY:</p> <table style="margin-left: auto; margin-right: auto;"> <tr> <td>Error</td> <td>DXX</td> <td>XX</td> <td>XX</td> <td>XX</td> <td>XX</td> <td>XX</td> </tr> <tr> <td></td> <td>1st</td> <td>2nd</td> <td>3rd</td> <td>4th</td> <td>5th</td> <td>6th</td> </tr> </table> <p>MATRIX DISPLAY, SCHMOO PLOT:</p> <table style="margin-left: auto; margin-right: auto;"> <tr> <td>Error</td> <td>DXX</td> </tr> </table>	Error	DXX	XX	XX		X axis	Y1 axis	Y2 axis	Error	DXX	XX	XX	XX	XX	XX		1st	2nd	3rd	4th	5th	6th	Error	DXX
Error	DXX	XX	XX																						
	X axis	Y1 axis	Y2 axis																						
Error	DXX	XX	XX	XX	XX	XX																			
	1st	2nd	3rd	4th	5th	6th																			
Error	DXX																								

Table 3-4. Hardware-Related Error-Codes

Display	Meaning
Error P06	The ROM (Read Only Memory) is not functioning properly.
Error P01 - P05 Error P07 - P11	One of the ten RAMs (Random Access Memory) is not functioning properly.
Error P21 and P22	MPU's (Microprocessor Unit) peripheral circuit is not functioning properly.
Error M08 - M22	MSU (Mass Storage Unit : Flexible Disc and drive) is not functioning properly. Try another disc.
Error A01 CHAN (!!!DOWN!!!)	SMU controller is not functioning properly.
CHAN (XX,XX,XX,XX)	SMU itself is not functioning properly. (XX shows SMU number and error code. Refer to Fig. 3-22.)

Note

If a momentary power loss occurs, the 4145B's display may go blank. To recover, turn off the instrument, wait a few seconds, and then turn on the instrument.

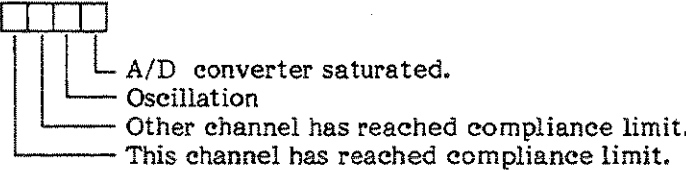
Note

The 4145B will function properly even though error M13 or M14 is displayed.

## 3-13. INITIAL CONTROL SETTINGS

3-14. To facilitate operation, the instrument is automatically set to the following initial control settings each time it is turned on :

## Front Panel Controls :

MEASUREMENT keys .....	OFF
AUTO SEQ key.....	OFF
INTEG TIME keys .....	SHORT
PLOT/PRINT keys .....	OFF
AUTO CAL key .....	ON
BLUE key .....	OFF

## Internal Setup :

CRT Display .....	MENU
	Page
Measurement Program .....	GENL
	(see note)
PLOT Area .....	Lower left
(for external plotter)	(200,200)
	Upper
	right
	(7400,4800)

## Note

The system disc contains four different application programs, of which GENL is one. Refer to paragraph 3-98 for details on the furnished applications programs.

All data stored on the disc is retained; that is, the disc is not erased when the instrument is turned off.

## 3-15. USER-AREA FILING OPERATIONS

3-16. The 4145B uses a 3.5 inch, double-sided, double-density micro flexible disc as the storage medium for its MSU (mass storage unit). The system disc furnished with the 4145B contains the necessary operating system software, four general purpose measurement programs, and enough user area for 2178 records. Up to 240 files can be stored in the user-area.

## Note

A record is the minimum unit for storage on the disc. A file consists of 4, 5, or 23 records, depending on the file type.

Three types of files can be stored in the user-area :

1. Measurement program files—file type P :  
Specifying file type P in the SAVE or RE-SAVE command reserves 5 records on the disc and stores the existing measurement setup (channel assignments, parameter settings, graphic scaling, output sequence, etc.) at the reserved 5-record location.
2. Measurement data files—file type D :  
Specifying file type D in the SAVE or RE-SAVE command reserves 23 records on the disc and stores the measurement setup and measurement results (GRAPHICS, LIST, MATRIX, or SCHMOO) at the reserved 23-record location.
3. Auto-sequence program files—file type S :  
Specifying file type S in the SAVE or RE-SAVE command reserves 4 records on the disc and stores the existing auto-sequence program at the reserved 4-record location.

For more information on file types, number of records used, etc., refer to Figure 3-32, 4145B FILE CATALOG Page.

Four filing operations—SAVE, RE-SAVE, GET PURGE and PURGE ALL—can be performed from the front panel. Each is described below :

## SAVE :

Used to store the existing measurement setup (except INTEG TIME, AUTO CAL, and softkey functions), the existing auto-sequence program, output sequence setup, or the measurement results. SAVE cannot be used when the disc is write-protected. Before saving a measurement setup, a page check must be performed (refer to paragraph. 3-49). To SAVE a file, press the SAVE key (SAVE will appear on the Keyboard Input Line of the CRT) and input the file type (P, D, or S) and file name. The file name can contain up to six characters, of which the first must be alphabetic and the last five must be alphanumeric.

## RE-SAVE :

Used to store the measurement setup, the auto-sequence program, output sequence setup or measurement results by the file name that already exists on the disc. Follow the same procedure described for the SAVE operation.

The delta ( $\Delta$ ) function can be used in user-function definitions or for keyboard calculations on the GRAPHICS, LIST, MATRIX, or SCHMOO page. In the latter case the value returned by executing  $\Delta A$  (where A is the name of one of the source or monitor channels depends on the location of the marker (GRAPHICS page) or cursor (MATRIX, LIST, and SCHMOO pages). Here,  $\Delta A$  is calculated as half the difference between the values of A above and below the cursor (marker) location. In equation form

$$\Delta A = \frac{A_1 - A_2}{2}$$

where  $A_1$  is the value of A at the measurement step following the cursor (marker) position and  $A_2$  is the value of A at the measurement step preceding the cursor (marker) position.

When A is the first or last position of the marker (GRAPHIC page) or cursor MATRIX, LIST, and SCHMOO pages),  $\Delta A$  is calculated as follows.

- $\Delta A = A_1 - A$  for the first position A, where  $A_1$  is the value of A at the measurement step following the marker (cursor) position.
- $\Delta A = A - A_2$  for the last position A, where  $A_2$  is the value of A at the measurement step preceding the marker (cursor) position.

#### Note

Delta ( $\Delta$ ) is not available for an arithmetic operations listed in Table 3-5.

The result of the arithmetic function may include a rounding error.

### 3-20. Source and Measurement Channels

3-21. The 4145B is equipped with eight channels for device stimulus and measurement. Channels 1 through 4 are Source/Monitor units (SMUs), channels 5 and 6 are voltage sources (VS1 and VS2), and channels 7 and 8 are voltage monitors (Vm1 and Vm2). Refer to Figure 3-8. By correctly combining and setting up the source and measurement channels, a wide range of semiconductor devices can be measured. The SMUs are described in paragraph 3-24; the voltage sources and voltage monitors, in paragraph 3-26.

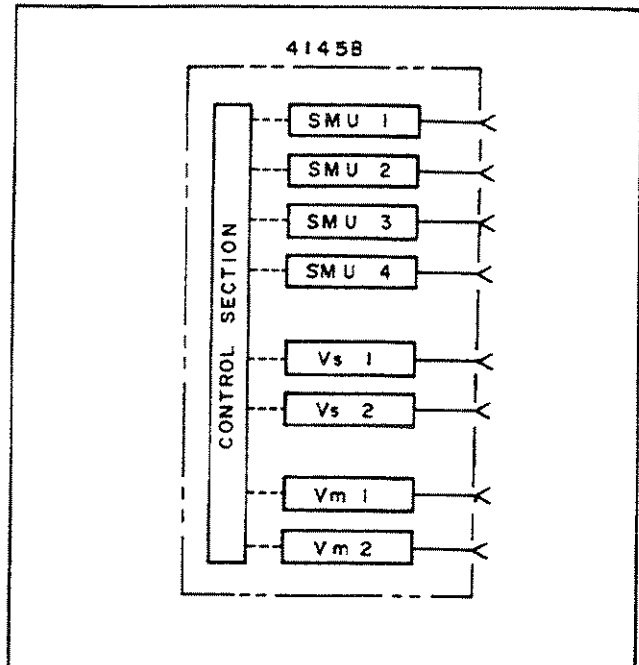

Figure 3-8. Source and Measurement Channels of the 4145B.

### 3-22. Protection against Hazardous Voltage Exceeding 42V

3-23. To insure operator safety, the 4145B is equipped with a high voltage detect circuit that shuts down the SMUs and voltage sources when a potentially dangerous condition exists. If the lid of the 16058A Test Fixture is not closed at the start of a measurement in which there is a possibility that the voltage output from at least one SMU will equal or exceed  $\pm 42V$ , or if the lid is opened during such a measurement, the measurement will be aborted as if the STOP key had been pressed.

A switch inside the 16058A Test Fixture detects whether the fixture lid is open or closed. When the lid is closed, the switch connects the OPEN/CLOSE line of the system cable to ground, allowing the output voltage from any or all of the SMUs to exceed  $\pm 42V$ . When the lid is open, however the OPEN/CLOSE line is open circuited, limiting output voltage to  $\pm 42V$ .

When the 4145B is used for an application that does not require the 16058A Test Fixture, the Shorting Connector (P/N 04145-61623, furnished with 4145B) should be connected to the system cable connector on the 4145B's rear panel. The Shorting Connector grounds the OPEN/CLOSE to allow maximum output from the SMUs.

## 3-24. Source/Monitor Units (SMU)

3-25. A simplified circuit diagram of one of the four SMUs is illustrated in Figure 3-9. Each SMU can be set up to function as a voltage source/current monitor, current source/voltage monitor, or source common by specifying source mode V, I, or COM, respectively, in the SOURCE MODE field on the CHANNEL DEFINITION page (see Figure 3-23). Output voltage (SOURCE MODE V) and output current (SOURCE MODE I) can be held constant or can be swept (linearly or logarithmically) by specifying source function CONST or VAR1, VAR1', VAR2, respectively, in the SOURCE FCTN field on the CHANNEL DEFINITION page. When the source mode is COM, source function is automatically set to CONST. Refer to paragraph 3-34 for details on swept measurements.

Output in either SOURCE MODE is internally limited to 2 watts on each output range. Refer to Table 3-6 for range limits, range resolution, and output limits. Figure 3-10 graphically illustrates the specifiable voltage/current output. Voltages and currents enclosed by the bold line can be specified.

Output voltage and current, sweep mode (linear or log), START, STOP, STEP, and COMPLIANCE for each SMU are specified on the SOURCE SETUP page (see Figure 3-24).

## Note

- 1) Range change is performed automatically.
- 2) If the Current Source can't output specified current, output voltage increases up to its voltage compliance.
- 3) If a voltage exceeding 100V is applied to the SMU, 199.99V may be displayed as the measurement result.

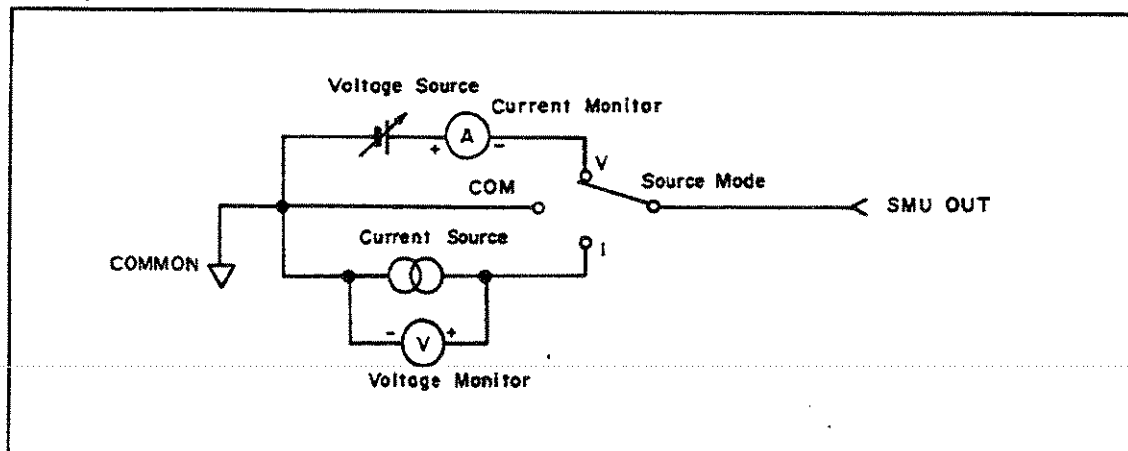

Figure 3-9. Simplified Circuit Diagram of One of the Four SMUs.

## 3-26. Voltage Sources (Vs) and Voltage Monitors (Vm)

3-27. Simplified circuit diagrams of the voltage sources (Vs) and the voltage monitors (Vm) are shown in Figures 3-11 and 3-12, respectively. Output voltage from each Vs can be held constant or can be swept (linearly or logarithmically) by specifying source function CONST or VAR1, VAR1', VAR2, respectively, in the SOURCE FUNCTION field on the CHANNEL DEFINITION page (see Figure 3-23). Refer to paragraph 3-34 for details on swept measurements. Maximum output voltage is  $\pm 20V$  with 1mV resolution.

Up to  $\pm 20V$  can be measured by the voltage monitors. There are two measurement ranges: 20V and 2V. Resolution for each range is 1mV and  $100\mu V$ , respectively.

## 3-28. Measurement Ranges and Resolution

3-29. The 4145B measures dc voltage and current with the voltage monitor function of each SMU, the current monitor function of each SMU, and the voltage monitors (Vm). The measurement ranges and resolution for the SMUs and voltage monitors are shown in Figure 3-13.

## Note

VAR1 outputs all sweep steps at the lowest range that includes START and STOP, except for I log sweeps. VAR1 for I log sweeps and VAR2 output each sweep step at the lowest range that includes each sweep step value. CONST outputs at the lowest range that includes the specified value.

Table 3-6. SMU Source Ranges

Source Mode	Range	Resolution	Maximum Output	
V	±20V	1mV	100mA	
	±40V	2mV	50mA	
	±100V	5mV	20mA	
I	±1nA	1pA	100V	
	±10nA	10pA		
	±100nA	100pA		
	±1µA	1nA		
	±10µA	10nA		
	±100µA	100nA		
	±1mA	1µA		
	±10mA	10µA		
	±100mA*	20mA	100µA	40V
		50mA		20V
100mA				

\*: The 100mA range consists of three subranges.

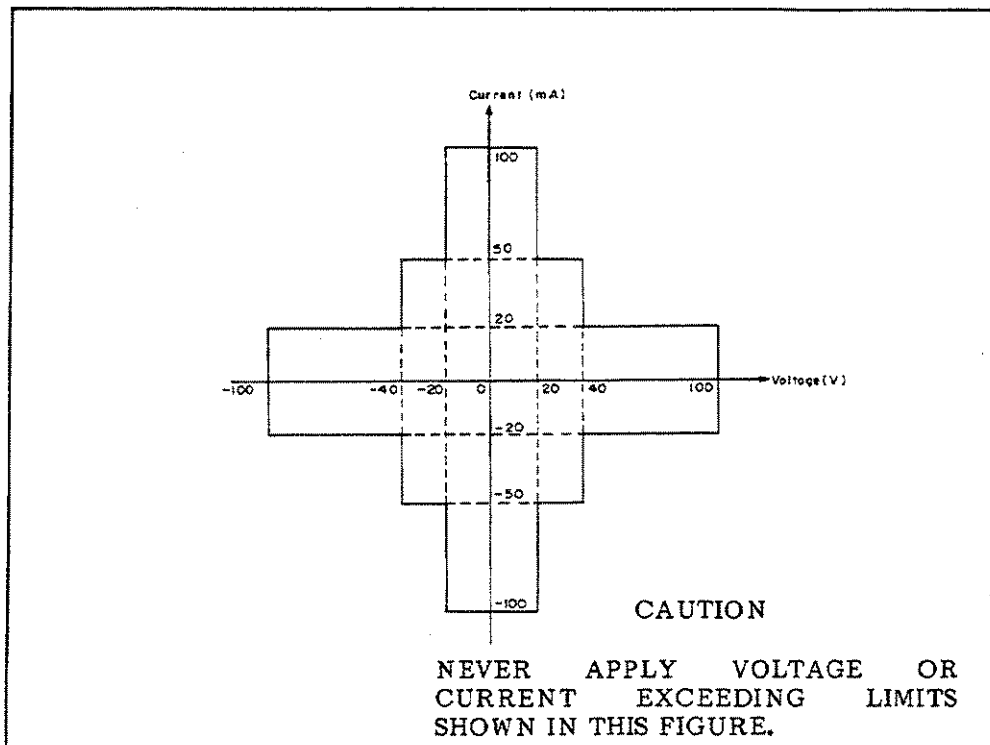

Figure 3-10. Specifiable Voltage/Current Output.

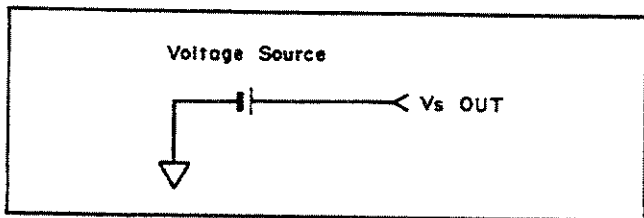

Figure 3-11. Simplified Circuit Diagram of Vs.

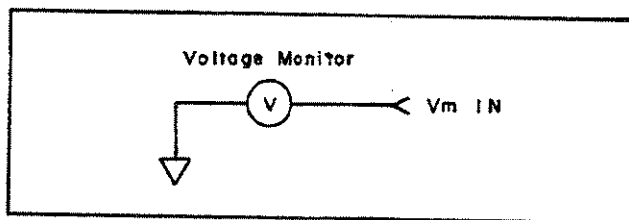

Figure 3-12. Simplified Circuit Diagram of Vm.

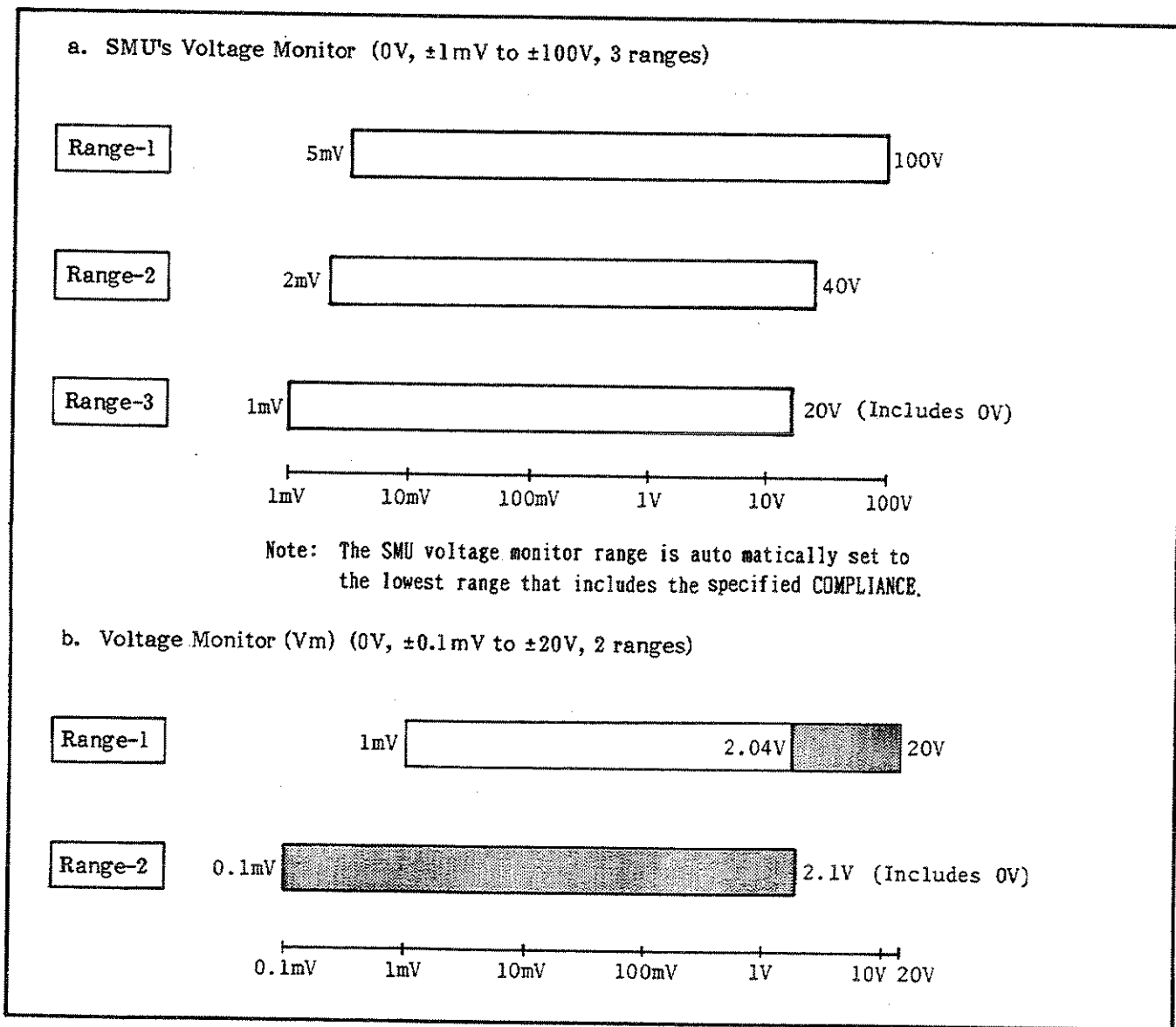
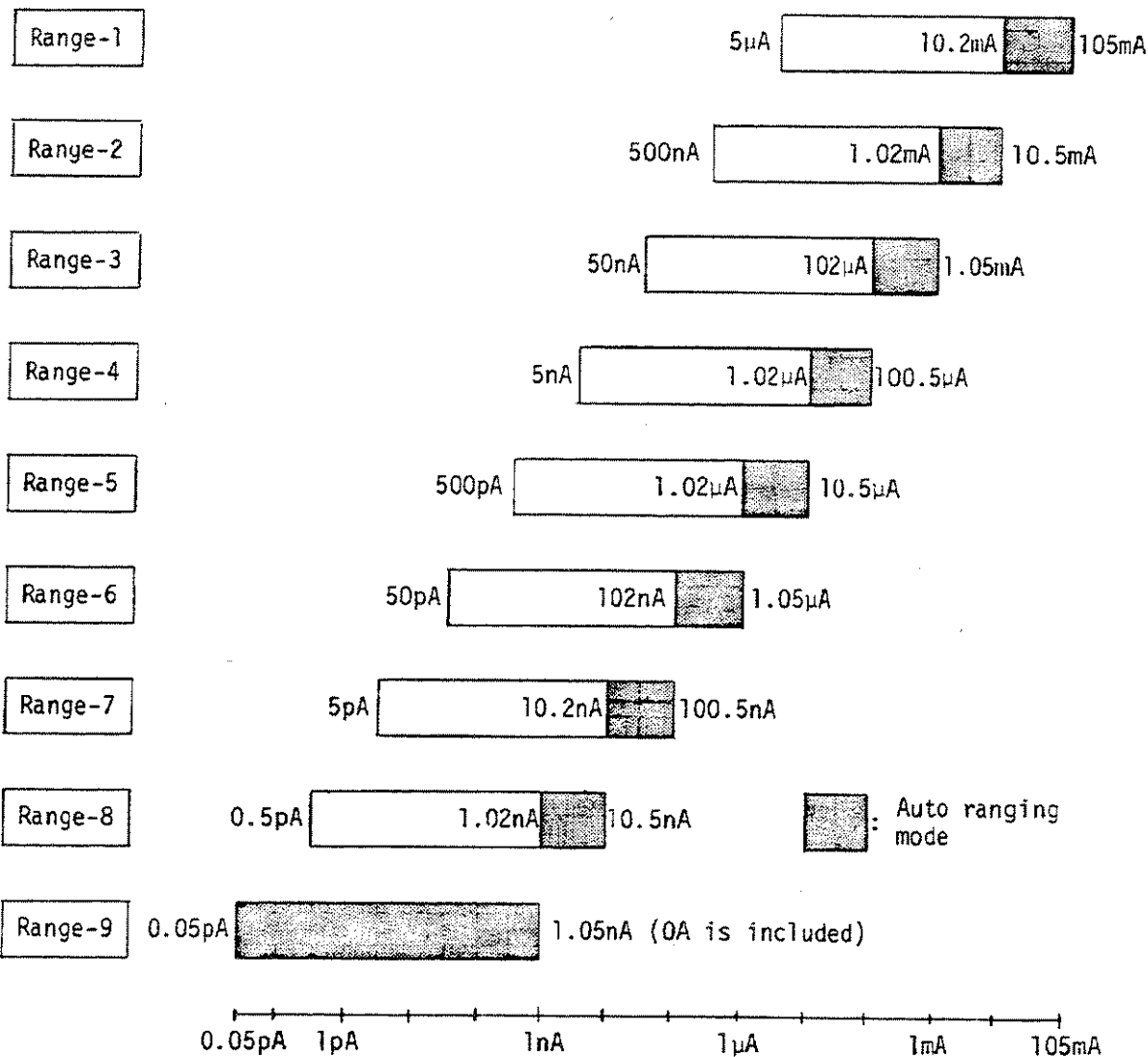

Figure 3-13. Measurement Ranges and Resolution.



c. SMU's Current Monitor (0A,  $\pm 0.05\text{pA}$  to  $\pm 105\text{mA}$ , 9 ranges)



Note: The maximum range in auto ranging mode is the lowest range that includes the specified COMPLIANCE.

Figure 3-13. Measurement Ranges and Resolution.

### 3-30. Resolution and Format for Displayed Data and Data Output

3-31. The 4145B manipulates the raw data with user functions (to calculate HFE or GM, for example) or analysis functions, such as; Marker, Cursor, and Line.

Display resolution may differ depending on the measurement resolution because of errors inherent in the digital data manipulations. The data is stored using a 3-byte 2's complement format (one byte has 8 bits; the first byte is for the exponent, the second and third bytes are for the mantissa). Therefore, the display resolution may be higher than that given in the specifications because of the conversion from 2's complement to decimal format. The number of output/display digits and the display format are listed in Tables 3-7 and Figure 3-14.

Table 3-7. Number of Output/Display Digits

Output/Display Functions	Display Digits and Format					
	Voltage		Current		User Function	
	Digits	Format	Digits	Format	Digits	Format
Marker/Cursor in GRAPHICS Display	5	a	4	b	3	c
LIST Display						
MATRIX Display						
Cursor in SCHMOO Display						
PRINT Function	4	d	4	d	not available	
HP-IB Data Output						
Keyboard Execution	4	d	4	d	not available	
Line in GRAPHICS Display	3 Digits, Format: c					

a. Voltage Display Format (5 digits, Min. = 0.1mV)

$ V  < 10V$	s n . n n n n V
$10V \leq  V  < 100V$	s n n . n n n V
$ V  = 100V$	s n n n . n n V
s: Polarity (blank or "-") n: Numeric (0 to 9) .: Decimal point V: Unit (volt)	

b. Current Display Format (4 digits, Min. = 0.05pA)

All current values	s d d d d u A
s: Polarity (blank or "-") d: Numeric (0 to 9) or decimal point u: Engineering unit ("m", "μ", "n", or "p") A: Unit (Ampere)	

c. User Function Display Format (3 digits)

$1.00 \leq  Mantissa  < 99.9$	s d d d n E ± mm
$100 \leq  Mantissa  < 999$	s n n n E ± mm
s: Polarity (blank or "-") d: Numeric ("0" to "9") or decimal point n: Numeric ("0" to "9") E: Exponent ±mm: 2-digit exponent (Engineering notation, multiples of 3, from -39 to +36)	

d. Display Format for Keyboard-Executed Calculations

All variable values	s d d d d n E ± mm
Designations are the same as those of format c.	

e. HP-IB Data Output Format (5 digits)

All variable values	s n d d d n n E ± mm
Designations are the same as those of format c.	

Figure 3-14. Display/Output Format.

## 3-32. COMPLIANCE

3-33. To prevent over-voltage or over-current damage to the device under test, several levels of output protection, termed COMPLIANCE, have been incorporated into the 4145B. The maximum output current from an SMU operating in SOURCE MODE V (voltage source/current monitor) can be specified by entering the desired limit in the COMPLIANCE field of each source channel on the SOURCE SETUP page. Similarly, the maximum output voltage from an SMU operating in SOURCE MODE I (current source/voltage monitor) can be specified. Maximum specifiable compliance depends on the voltage or current range at which the source channel is operating. Refer to the Maximum Output column in Table 3-6. Setting resolution for current and voltage compliance is 50pA and 1mV, respectively. When an SMU is operating in SOURCE MODE COM, its current compliance is automatically set to 105mA and cannot be changed.

If a source channel reaches compliance during measurement, an error code (see Table 3-3) will appear on the CRT. Measurement data obtained prior to this point is valid, but measurement data obtained after compliance is reached may not be valid. The reason for this is that once a source channel reaches compliance, it tends to act as a constant source. Consider, for example, an SMU that is set to SOURCE MODE V (voltage source/current monitor) and SOURCE FCTN VARI (variable voltage source). START voltage, STOP voltage, and COMPLIANCE are 0V, +20V, and 10mA, respectively. Also, assume that the device under test has a resistance of 1000 ohms. When the measurement is started, the SMU will begin sweeping its output voltage toward +20V. But when the output voltage reaches +10V, the current through the device under test is 10mA. Compliance has been reached. The SMU will continue to try to sweep toward the +20V STOP voltage, but because the current through the device under test is now constant at 10mA, the voltage across it must be constant at +10V.

The specified compliance is valid for positive and negative values, regardless of the polarity specified in the COMPLIANCE field; that is, specifying a current compliance of, say, 40mA, as in Figure 3-15, is valid for +40mA and -40mA. Output currents greater than  $\pm 40$ mA (shaded areas in Figure 3-15) are not possible.

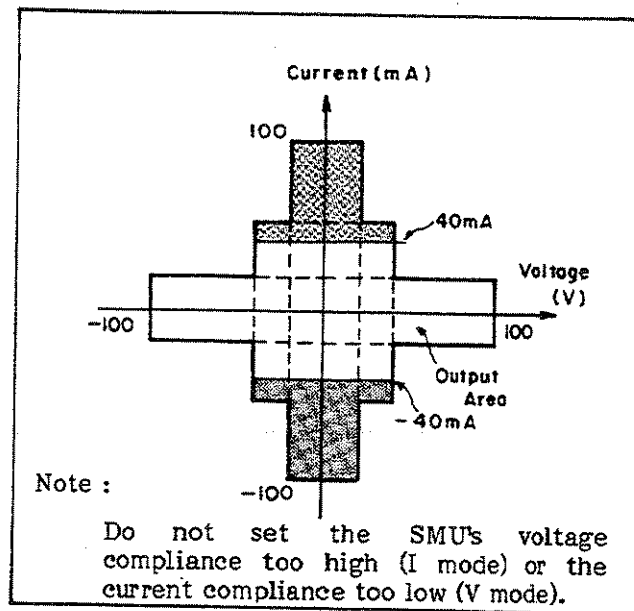

Figure 3-15. Voltage/Current Output Specified by the COMPLIANCE

3-34. SWEEP MEASUREMENT

3-35. Output from the SMUs and voltage sources (Vs) can be swept in a staircase manner, as shown in Figure 3-16, by specifying VAR1, VAR1', or VAR2 in the SOURCE FCTN field on the CHANNEL DEFINITION page. The maximum number of source channels that can be swept is three. VAR1, VAR1', and VAR2 can be specified only once on the CHANNEL DEFINITION page and VAR1' cannot be specified without VAR1. VAR1, VAR1', and VAR2 are described in paragraph 3-36.

Sweep setup is made on the SOURCE SETUP page by selecting the SWEEP MODE and entering the desired START, STOP, STEP, DELAY, and HOLD values. Each sweep parameter is described below:

- START: Voltage or current value at which sweep begins
- STOP: Voltage or current value at which sweep stops
- STEP: Sweep incremental or decremental value. Can be specified in LINEAR SWEEP MODE only.

DELAY: Wait time before measurement is made at each step (softkey function).

HOLD: Wait time before sweep begins (softkey function).

SWEEP MODE:

LINEAR or LOG. In LINEAR mode, output is swept linearly in accordance with the specified STEP value. In LOG mode, output is swept logarithmically at 10 steps, 25 steps or 50 steps (selectable with softkeys) per decade. LOG cannot be specified for VAR2. Refer to paragraph 3-37 for further details on LOG sweeps.

The above sweep parameters are for VAR1 only. Sweep parameters available for VAR2 are START, STEP, and NO. OF STEPS. Sweep parameters available for VAR1' are OFFSET (specifiable in linear sweep mode only) and RATIO, both of which are softkey functions. Also, when displaying measurement results on the GRAPHICS page, either LINEAR or LOG scaling can be specified on the MEAS/DISP MODE SETUP page, regardless of the SWEEP MODE of VAR1.

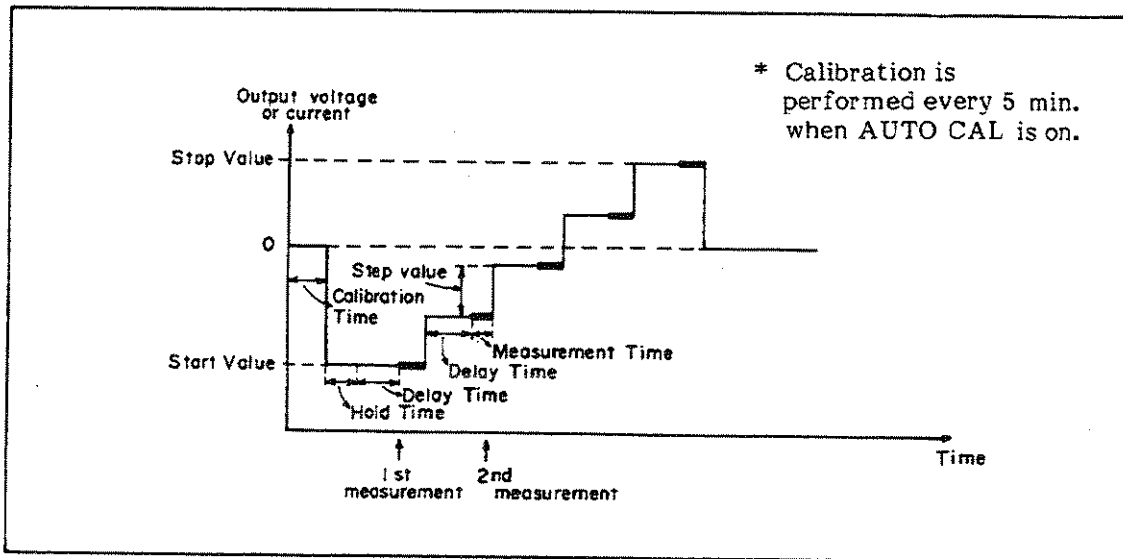

Figure 3-16. Staircase Sweep Output

3-36. Of the six source channels (four SMUs, two voltage sources), three can be swept by specifying VAR1, VAR1', or VAR2 in the SOURCE FCTN field on the CHANNEL DEFINITION page. The remaining three source channels are either "not used" or are set to CONST source function. The VAR1 source channel is the main sweep channel and VAR2 and VAR1' are VAR1 dependent, as shown in Figures 3-17 and 3-18, respectively, and as described below :

**VAR2 (subordinate sweep):**

At the completion of the VAR1 sweep, VAR2 is incremented or decremented by the specified STEP value (4) in Figure 3-17) and VAR1 is swept again. The total number of VAR1 sweeps is determined by the NO. OF STEPS (5) in

Figure 3-17) specified for VAR2. VAR2 cannot be swept logarithmically. Also, VAR1 and VAR2 can have different source functions. START, STEP, and NO. OF STEPS must be specified.

**VAR1' (synchronous sweep):**

VAR1' can be used only when VAR1 is used and it must have the same source mode (V or I) as that specified for VAR1. VAR1' is swept in synchronism with VAR1 at either a constant offset value or constant ratio. VAR1' offset and ratio values are entered with the corresponding softkey. The offset value and ratio must be such that the VAR1' source channel does not exceed its maximum output limits.

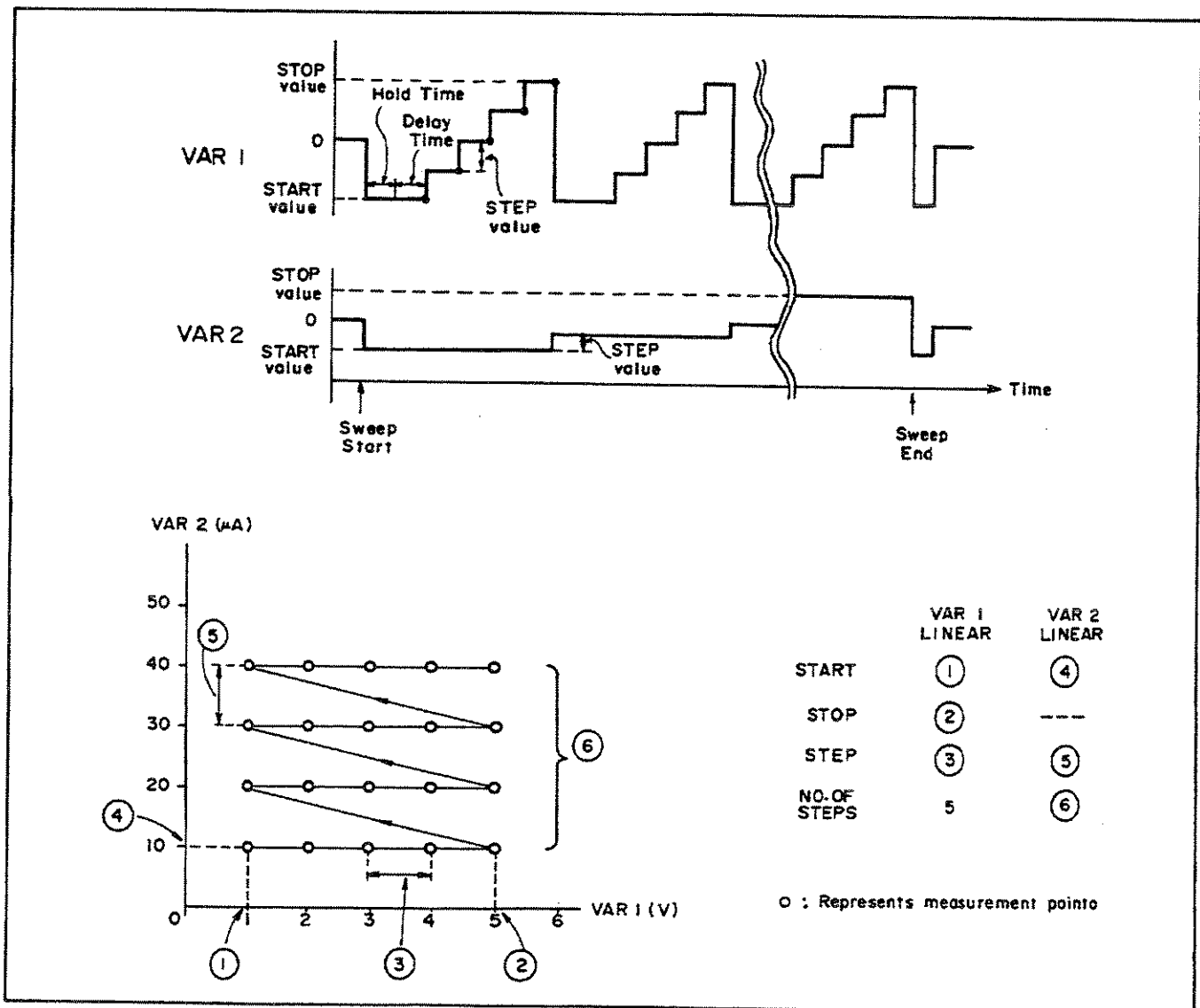

Figure 3-17. Relationship Between VAR1 and VAR2.

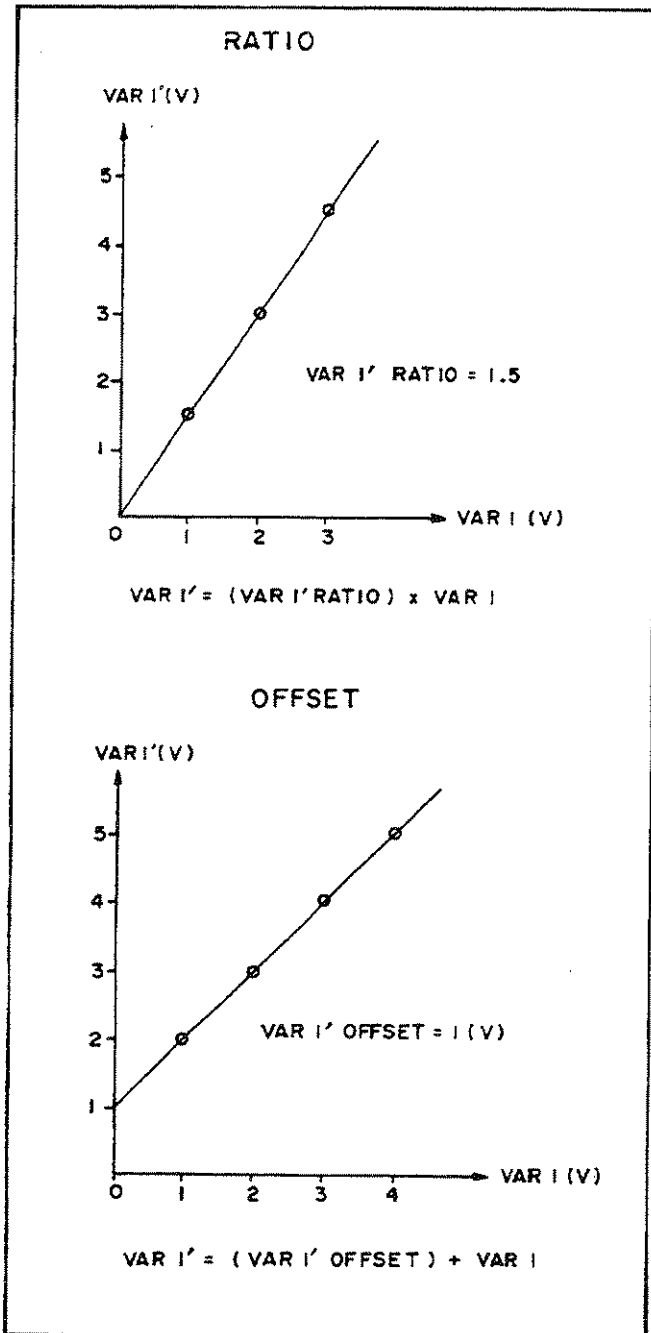

Figure 3-18. Relationship Between VAR1 and VAR1'

3-37. The number of measurement points per decade in LOG sweep is selectable at 10, 25, or 50. The output at each point is determined by the number of measurement points per decade and the sweep START value. The output at the nth measurement point is calculated as:

$$\text{Output at nth point} = \text{START value} \times 10^{\frac{n-1}{\alpha}} \quad (3-1)$$

where  $\alpha$  is the number of measurement points per decade (10, 25, 50).

### 3-38. TIME DOMAIN MEASUREMENT

3-39. A time domain measurement is one in which the voltages and/or currents applied to the device under test are held constant and the desired device parameter is measured as a function of time. Only one source channel can be swept and only with the VAR2 source function. All other channels are either "not used" or must be set to CONST source function. Selectable TIME DOMAIN parameters are WAIT TIME, INTERVAL, and NO. OF RDNGS (number of readings). Each is described below:

#### WAIT TIME:

Identical to the HOLD TIME of a VAR1 sweep measurement. Setting range is from 0 to 100 seconds and resolution is 10 milliseconds.

#### INTERVAL:

Time between each measurement point. Setting range is from 10 milliseconds to 10 seconds and resolution is 10 milliseconds.

#### NO. OF RDNGS:

Total number of measurement points. If VAR2 is used, NO. OF RDNGS per each step of VAR2. Up to 1024 measurement points can be specified, depending on the number of VAR2 steps.

To make a TIME DOMAIN measurement, do not assign VAR1 to any of the source channels on the CHANNEL DEFINITION page. (Assigning VAR2 is optional.) Output values for all CONST sources must still be entered on the SOURCE SETUP page. If VAR2 is used, its START, STEP, and NO. OF STEPS must also be entered. Also, HOLD TIME and DELAY TIME are not used in a TIME DOMAIN measurement.

TIME DOMAIN parameters—WAIT TIME, INTERVAL, and NO. OF RDNGS—must be entered on the MEAS/DISP MODE SETUP page. Refer to Figure 3-35. Integration time during TIME DOMAIN measurement is automatically set to SHORT and cannot be changed.

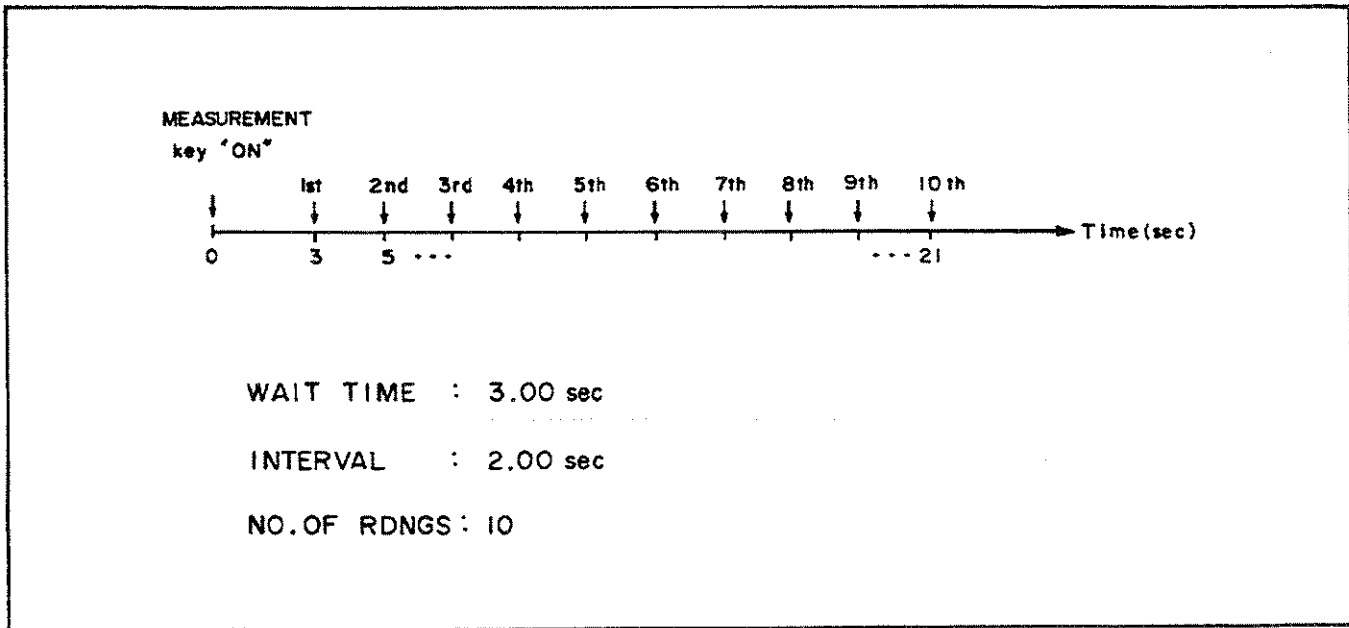

Figure 3-19. Time Domain Measurement.

**3-40. INTEGRATION TIME**

3-41. To prevent line frequency noise and other noise sources from affecting the accuracy of measurements, the 4145B is equipped with three digital integration times, which are selectable from the front panel. Each is described below:

**SHORT:** Digital integration is not performed.

**MEDIUM:** Measurement result is the average value of 16 samples taken during one line frequency period.

**LONG:** Measurement result is the average value of 256 samples taken during sixteen line frequency periods.

Integration time can be changed during measurement, but cannot be changed while the 4145B is in TALK mode (PLOT or PRINT), when the disc drive's read/write lamp first comes on, or during auto scaling. In time domain measurements only SHORT integration time is available.

**3-42. AUTO-CALIBRATION**

3-43. To both monitor and compensate for transient changes in output voltage and current caused by ambient temperature changes, each SMU is equipped with an auto-calibration function. This function allows each SMU to periodically monitor its own output and, if necessary, provide appropriate compensation.

3-44. The auto-calibration function of the SMUs is controlled by the AUTO CAL key on the front panel. With AUTO CAL turned on (key indicator lamp on), calibration is automatically performed every five minutes for about six seconds. If one of the MEASUREMENT keys or the AUTO CAL key is pressed during auto-calibration, "Busy" will be displayed on the CRT until auto-calibration is completed.



## 3-45. DISPLAY PAGES

3-46. The 4145B displays thirteen different screens. Each screen is called a page and each has a different purpose in relation to instrument operation. By changing from one page to another, different functions and capabilities, such as measurement set up, measurement, diagnostics, certain filing functions, etc., are made available. PAGE control is described in paragraph 3-47. Detailed explanations of each page are given Figures 3-22 through 3-34.

## 3-47. PAGE CONTROL

3-48. Display paging is controlled by the PAGE CONTROL keys—MENU, NEXT, and PREV—or the softkeys, as shown in Figure 3-20. (Softkeys for PAGE control are available only when the MENU is displayed.) Page-flow and the relationship between pages are shown in Figure 3-21. The solid lines (—) show page changes that are possible with the NEXT key or PREV key; the dashed lines (---) show page changes that are possible with the softkeys. To go to the GRAPHICS, LIST, MATRIX, or SCHMOO page from the MEAS/DISP MODE SETUP page, it is first necessary to select the desired display mode with the softkeys and then press the NEXT key.

All pages except the GRAPHICS, LIST, MATRIX, and SCHMOO pages can be displayed directly from the MENU page by pressing the appropriate softkey. For example, pressing softkey 3 while the MENU page is displayed automatically displays the MEAS/DISP MODE SETUP page. Pressing the MENU key automatically returns the display to the MENU page, regardless of the present display page. To change from the GRAPHICS page to, say, the LIST page, press the PREV key to display the MEAS/DISP MODE SETUP page, select LIST with the softkeys, and then press the NEXT key. Paging cannot be performed during measurement, printing, or plotting.

3-49. When the NEXT key or PREV key is pressed while the CHANNEL DEFINITION page, SOURCE SETUP page, MEAS/DISP MODE SETUP, or OUTPUT SEQUENCE SETUP page is displayed, the page is checked for completeness and correctness. If an illegal setup is detected, an error message will be displayed and no page change will occur. In this case you must either correct the setup or press the MENU key. Changes made on the CHANNEL DEFINITION, SOURCE SETUP, MEAS/DISP MODE SETUP and OUTPUT SEQUENCE SETUP pages are not valid for SAVE or RE-SAVE until the PREV or NEXT key is pressed.

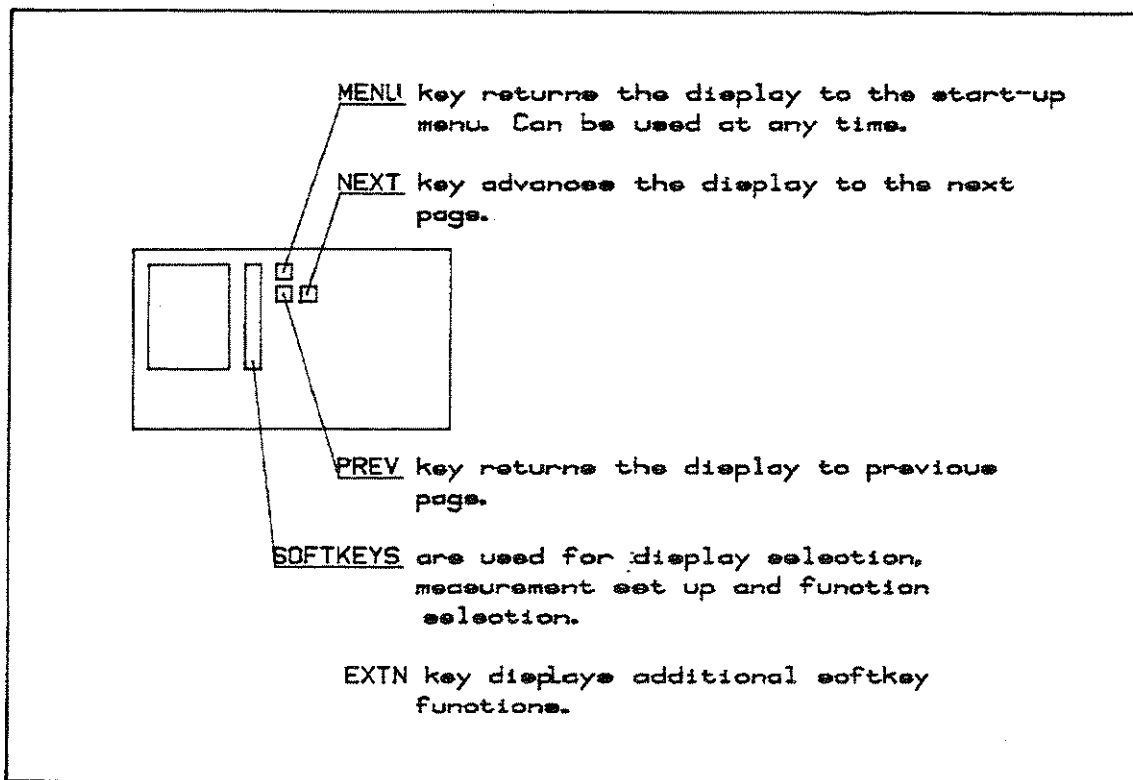
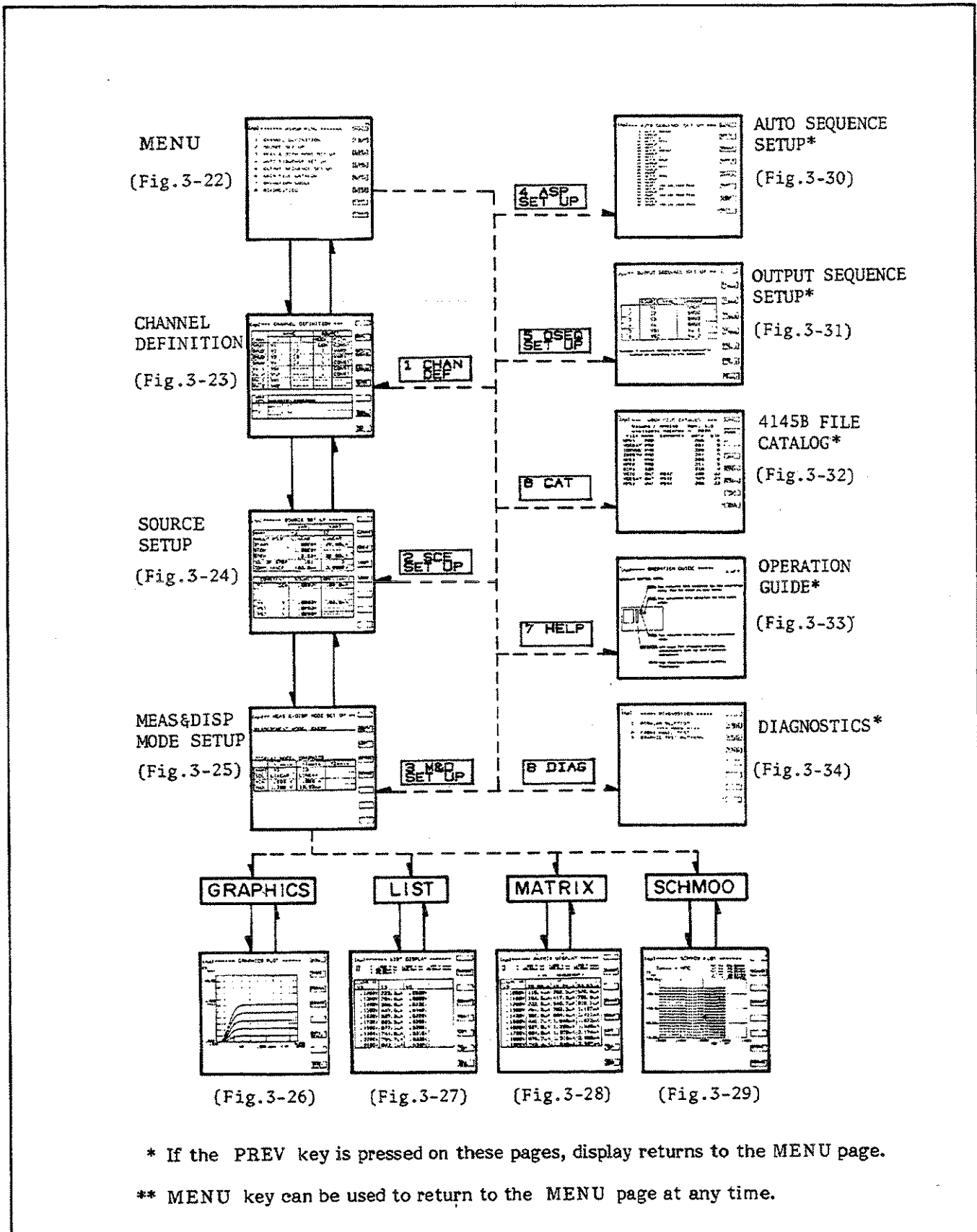

Figure 3-20. Page Control Keys.



\* If the PREV key is pressed on these pages, display returns to the MENU page.  
 \*\* MENU key can be used to return to the MENU page at any time.

Figure 3-21. Page Flow and the Relationship.

### 3-50. MENU PAGE

3-51. The start-up menu is displayed when the instrument is turned on and each time the MENU key is pressed. Displayed on the MENU page are the accessible pages, corresponding softkey prompts (SKP), the instrument's present HP-IB status, line frequency filter setting, and the status of each SMU. A detailed description of the MENU page is given in Figure 3-22.

### 3-52. CHANNEL DEFINITION PAGE

3-53. The CHANNEL DEFINITION page is displayed when softkey 1 or the NEXT key is pressed while the MENU page is displayed. On this page the operator must define the name, mode, and function of each channel that is to be used in the measurement. User functions are also defined on this page. A detailed description of the CHANNEL DEFINITION page is given in Figure 3-23.

### 3-54. SOURCE SETUP PAGE

3-55. The SOURCE SETUP page is displayed when softkey 2 is pressed on the MENU page or when the NEXT key is pressed on the CHANNEL DEFINITION page. On this page the operator must enter the output parameters (START, STOP, STEP, COMPLIANCE, etc.) for the source channels (SMUs and voltage sources) defined on the CHANNEL DEFINITION page. A detailed description of the SOURCE SETUP page is given in Figure 3-24.

### 3-56. MEAS/DISP MODE SETUP PAGE

3-57. The MEAS/DISP MODE SETUP page is displayed when softkey 3 is pressed on the MENU page or when the NEXT key is pressed on the SOURCE SETUP page. On this page the operator must select the desired display mode (GRAPHICS, LIST, MATRIX, SCHMOO), enter the appropriate source and monitor names, and enter the desired scaling factors. A detailed description of the MEAS/DISP MODE SETUP page is given in Figure 3-25.

### 3-58. GRAPHICS PLOT PAGE

3-59. The GRAPHICS PLOT page is displayed when the MEAS/DISP MODE SETUP page has been set up for GRAPHICS MODE DISPLAY and the NEXT key is pressed. On this page the operator can make the measurement by pressing the SINGLE, REPEAT, or APPEND key and can analyze the measurement results with the softkeys. A detailed description of the GRAPHICS PLOT page is given in Figure 3-26.

### 3-60. LIST DISPLAY PAGE

3-61. The LIST DISPLAY page is displayed when the MEAS/DISP MODE SETUP page has been set up for LIST mode display and the NEXT key is pressed. On this page the operator can make the measurement by pressing the SINGLE, REPEAT, or APPEND key and can analyze the measurement results with the softkeys. A detailed description of the LIST DISPLAY page is given in Figure 3-27.

### 3-62. MATRIX DISPLAY PAGE

3-63. The MATRIX DISPLAY page is displayed when the MEAS/DISP MODE SETUP page has been set up for MATRIX mode display and the NEXT key is pressed. On this page the operator can make the measurement by pressing the SINGLE, REPEAT, or APPEND key and can analyze the measurement results with the softkeys. A detailed description of the MATRIX DISPLAY page is given in Figure 3-28.

### 3-64. SCHMOO PLOT PAGE

3-65. The SCHMOO PLOT page is displayed when the MEAS/DISP MODE SETUP page has been set up for SCHMOO mode display and the NEXT key is pressed. On this page the operator can make the measurement by pressing the SINGLE or REPEAT key and can analyze measurement results with the softkeys. A detailed description of the SCHMOO PLOT page is given in Figure 3-29.

**3-66. AUTO SEQUENCE SETUP PAGE**

3-67. The AUTO SEQUENCE SETUP page is displayed when softkey 4 is pressed on the MENU page. On this page the operator can set up an auto-sequence program (ASP). A detailed description of the AUTO SEQUENCE SETUP page is given in Figure 3-30.

**3-68. OUTPUT SEQUENCE SETUP PAGE**

3-69. The OUTPUT SEQUENCE SETUP page is displayed when softkey 5 is pressed on the MENU page. On this page the operator can specify the order in which the SMUs and voltage sources begin output. A detailed description of the OUTPUT SEQUENCE SETUP page is given in Figure 3-31.

**3-70. USER FILE CATALOG PAGE**

3-71. The USER FILE CATALOG page is displayed when softkey 6 is pressed on the MENU page. On this page the operator can initialize the blank disc, copy the operating system, purge a file or all files on the disc, and transfer the all files from the 4145A's disc or another 4145B's disc to the 4145B's disc. The number of records available, stored files, file type, comments, file addresses, number of records reserved for each file, and number of records actually used by each file are displayed. A detailed description of the USER FILE CATALOG page is given in Figure 3-32.

**3-72. OPERATION GUIDE PAGE**

3-73. The OPERATION GUIDE page is displayed when softkey 7 is pressed on the MENU page. This page provides brief paging information and brief descriptions of error messages and error codes. A detailed description of the OPERATION GUIDE page is given in Figure 3-33.

**3-74. DIAGNOSTICS PAGE**

3-75. The DIAGNOSTICS page is displayed when softkey 8 (press EXTN softkey to display softkey 8) is pressed on the MENU page. On this page the operator can perform SELF TEST, front panel test, graphics display test, disc cleaning, and disc copy (user-area only). A detailed description of the DIAGNOSTICS page is given in Figure 3-34.

**3-76. SOFTKEY PROMPTS (SKP)**

3-77. Softkey prompts (the function of each softkey) are displayed along the right side of the CRT display. There are eight softkeys, and the softkey prompts for the lower seven keys change depending on the page being displayed and the position of the Field Pointer (▶) on the CHANNEL DEFINITION, SOURCE SETUP, and MEAS/DISP MODE SETUP pages. The softkey prompt of the top softkey is always EXTN (extended), regardless of the page being displayed or the position of the Field Pointer. EXTN is displayed only when additional softkey functions exist.

**3-78. SYSTEM MESSAGES**

3-79. System messages are instructions to the operator and are displayed on the System Message Line (refer to Figure 3-5), which is located at the bottom of the CRT display. System messages guide the operator through all phases of instrument operation, and make measurement setup a simple matter of filling in blanks on the CHANNEL DEFINITION, SOURCE SETUP, and MEAS/DISP MODE SETUP pages.

# MENU PAGE

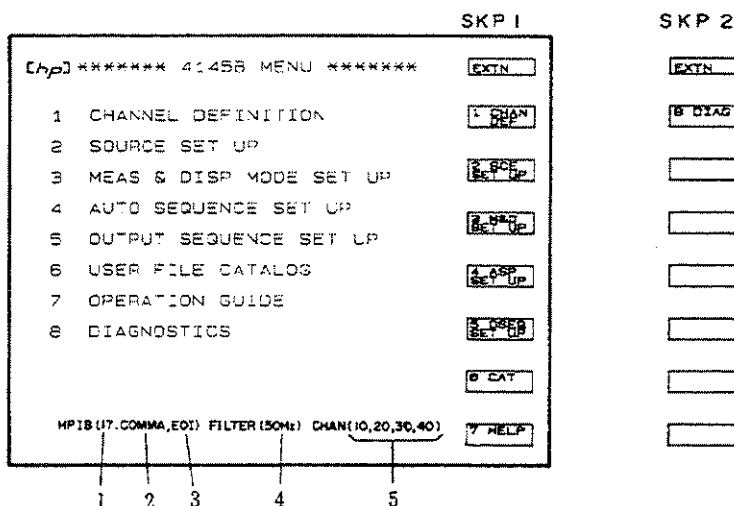

Figure A

**Initial Condition :**

When the 4145B is turned on, the display will be blank while SELF TEST is being performed. When SELF TEST has been completed and no fatal error have been detected, the MENU page will be displayed as shown in Figure A. The status of the instrument, as detected by the SELF TEST, is displayed at the bottom of the CRT.

- 1: HP-IB Address (0 - 30): Shows the setting of the HP-IB Control Switch (located on the rear panel). To change the address, turn the instrument off, set the desired address, and turn the instrument on again.
- 2: Output data delimiter: COMMA or CR/LF is displayed depending on the setting of the HP-IB Control Switch.
- 3: EOI (End or Identify): EOI is displayed when bit 7 of the HP-IB Control Switch is set to EOI ON.
- 4: Line Filter setting: Indicates the setting of the Line Filter Switch on the rear panel. (50Hz) indicates that the instrument is set for operation from a 50Hz AC source. The LINE FILTER switch on the rear panel should be set to the frequency of the AC source if accurate measurements are to be obtained.

Figure 3-22. MENU Page (Sheet 1 of 2)



# CHANNEL DEFINITION PAGE

SKP 3

[Chp]\*\*\* CHANNEL DEFINITION \*\*\*

CHAN	NAME		SOURCE		
	V	I	MODE	FCTN	
SMU1	V1	I1	COM	CONST	GENL
SMU2	V2	I2	I	VAR2	USER FCTN
SMU3	V3	I3	V	VAR1	USER FCTN
SMU4	V4	I4	V	CONST	USER FCTN
V <sub>s</sub> 1	VS1	-----	V	CONST	USER FCTN
V <sub>s</sub> 2	VS2	-----	V	CONST	USER FCTN
V <sub>m</sub> 1	VM1	-----	-----	-----	USER FCTN
V <sub>m</sub> 2	VM2	-----	-----	-----	USER FCTN

USER FCTN	NAME	UNIT	EXPRESSION	
1				
2				

Figure A

Purpose and function of this Page :

1. To assign voltage (V) and current (I) names to each channel that will be used in the measurement.
2. To set the source mode of each SMU. (Determines whether the SMU will be used as a V source or I source.)
3. To set the source function of each SMU. (Determines whether the SMU will be used as a constant source or variable source.)
4. To define User Functions.

Initial Condition :

When the 4145B is turned on, the CHANNEL DEFINITION page is automatically setup as shown in Figure A and the field-pointer (▶) will be located in the V column of SMU1. (This setup is the GENL measurement setup stored on each disc. Refer to paragraph 3-98.)

Field-Pointer (▶) :

Changing or entering a V NAME, I NAME, SOURCE MODE, SOURCE FUNCTION, or USER FUNCTION can be accomplished only by positioning the field-pointer at the field to be changed. New information can then be entered with the appropriate front panel keys or softkeys. Positioning of the field-pointer is controlled by the CURSOR keys (FAST cannot be used on this page). When one of these keys is pressed the field-pointer will move one field in the direction of the arrow labelled on the key. Also, each time new information is entered into a field, the field-pointer will automatically move to the next field, as shown in Figure B.

[Chp] \*\*\* CHANNEL DEFINITION \*\*\*

CHAN	NAME		SOURCE	
	V	I	MODE	FCTN
SMU1				
SMU2				
SMU3				
SMU4			V	
V 1			V	
V 2			V	
Vm 1				
Vm 2				

USER FCTN	NAME (UNIT) = EXPRESSION
	1
2	

Figure B

## NAME and USER FUNCTION Entry :

- (1) Position the field-pointer at the desired field.
- (2) Key in the desired name or user-function expression (it will appear on the Keyboard Input Line on the CRT as you do so).
- (3) Press ENTER. The name or expression will be moved from the Keyboard Input Line to the field at which the field-pointer is positioned and the field-pointer will move to the next field.

## Note

V NAME, I NAME, and USER FCTN NAME can be up to six characters long, of which the first character must be alphabetic and the remaining characters must be alphanumeric. A NAME can be used only once on this page. USER FCTN expressions can be up to sixty characters long and can contain channel names (V or I), numerics, and arithmetic operators.

## SOURCE MODE and SOURCE FCTN Entry :

- (1) Position the field-pointer at the desired field.
- (2) Select the desired mode or function from those listed on the softkey prompts. (The softkey prompts will change depending on the location of the field-pointer.)
- (3) When the softkey is pressed, the selected mode or function will appear in the field and the field-pointer will move to the next field.

## Note

SOURCE MODE and SOURCE FCTN can be entered only with the softkeys.



**V NAME and I NAME :**

These are unique names used to identify each channel that is to be used in the measurement. Each SMU has two names : one for its source function and one for its monitor function. Both must be entered if the SMU has been assigned a SOURCE MODE. If no V NAME is entered for a voltage source (Vs) or voltage monitor (Vm), the channel is considered as not used. The NOT USE softkey can be used to delete the NAMES, SOURCE MODE, and SOURCE FCTN of a channel and effectively turn it off. The NOT USE softkey is available only when the field-pointer is in the V NAME column.

**SOURCE MODE :**

Each SMU used in the measurement must be assigned a SOURCE MODE. Three SOURCE MODEs are available : V (voltage source/current monitor), I (current source/voltage monitor), and COM (common). A COM source is regarded as a voltage source whose output is 0V and compliance is 105mA. SOURCE MODE selection can be made only with the softkeys and only when the field-pointer is in the SOURCE MODE column.

**SOURCE FCTN :**

Each SMU and each Vs used in the measurement must be assigned a SOURCE FCTN. Four SOURCE FCTNs are available: VAR1 (main sweep), VAR1' (synchronous sweep), VAR2 (subordinate sweep), and CONST (constant source). SOURCE FCTN selection can be made only with the softkeys and only when the field-pointer is in the SOURCE FCTN column. Refer to paragraph 3-34 for details on VAR1, VAR1', and VAR2.

**Note**

If the SOURCE MODE of an SMU is COM, SOURCE FCTN is automatically set to CONST.

**USER FCTN :**

The user function is an extremely versatile, useful analysis aid. It is a user-defined arithmetic expression consisting of variables (V NAMES and I NAMES only) and constants and is executed at each measurement point during measurement. The results can be displayed (GRAPHICS PLOT, LIST, MATRIX, SCHMOO) along with measurement results. Any of the arithmetic operators listed in Table 3-5, plus  $\Delta$  and parentheses, can be used in USER FCTN expressions. The only variables that can be used in a USER FCTN expression are the names listed in the V NAME and I NAME columns on the CHANNEL DEFINITION page. Two USER FCTNs can be defined and each can be up to 60 characters long.

**SOFTKEY PROMPTS and SOFTKEYS FUNCTIONS :**

The softkey prompts (SKP) displayed on the CRT automatically change as the field-pointer is moved to different areas of the page. The relationship between field-pointer location and the softkey prompts is shown in Figures C and D. For example, when the field-pointer is at (4) in Figure C, SKP 6 in Figure D, will be displayed on the CRT. SKP 8 and SKP 9 are displayed only after the CHAN ASSIGN softkey has been pressed on SKP3.

[Chp] \*\*\* CHANNEL DEFINITION \*\*\*

CHAN	NAME	I	MODE	SOURCE	FCTN
SMU1	V ①	I1	COM	CONST	
SMU2	V2	I2	③	V/ ④	
SMU3	V3	I3	V	CONST	
SMU4	V4	I4	V	CONST	
Vm 1	VS ⑤	-----	-----	-----	-----
Vm 2	VS2	-----	V	CONST	-----
Vm 1	VM1	-----	-----	-----	-----
Vm 2	VM2	-----	-----	-----	-----

USER	NAME (UNIT) =	EXPRESSION
1	⑥	⑦
2	⑧	⑧

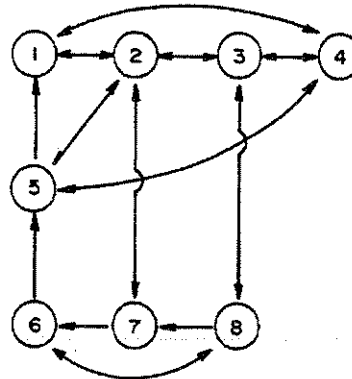

Figure C

①	⑤ ⑥	③	④	② ⑦ ⑧	SKP 8	SKP 9
SKP 3	SKP 4	SKP 5	SKP 6	SKP 7	SKP 8	SKP 9
<input type="text"/>	<input type="text"/>	<input type="text"/>	<input type="text"/>	<input type="text"/>	<input type="text"/>	<input type="text"/>
GENL	<input type="text"/>	V	VAR1	<input type="text"/>	SMU1	Vm 1
VCECFC	<input type="text"/>	I	VAR2	<input type="text"/>	SMU2	Vm 2
VCE-ID	<input type="text"/>	COM	CONET	<input type="text"/>	SMU3	<input type="text"/>
PLDVE	<input type="text"/>	<input type="text"/>	VAR1	<input type="text"/>	SMU4	<input type="text"/>
<input type="text"/>	<input type="text"/>	<input type="text"/>	<input type="text"/>	<input type="text"/>	<input type="text"/>	<input type="text"/>
CHAN ASSIGN	<input type="text"/>	<input type="text"/>	<input type="text"/>	<input type="text"/>	CHAN ASSIGN	CHAN ASSIGN
DEL	DEL	<input type="text"/>	<input type="text"/>	<input type="text"/>	<input type="text"/>	<input type="text"/>

Figure D

**CHAN ASSIGN** (Channel Assignment) :

This softkey allows you to quickly rearrange the SMU and Vs channel assignments, without having to reassign channel names (V and I), SOURCE MODES, and SOURCE FCTNs. It is extremely helpful when DUT connections have been made or when measuring devices which require the same measurement setup but which have different pin-outs. The procedure is given below.

- (1) Move the field-pointer to area ① in Figure C. SKP 3 in Figure D, will be displayed.
- (2) Press the CHAN ASSIGN softkey. The field-pointer will automatically move to the first row in the CHAN column, rows 1 through 6 in the CHAN column will be blank, and SKP8 will be displayed.
- (3) Assign the channel numbers in the desired order. The field-pointer will move down the CHAN column as you do so. When the field-pointer reaches the fifth row, SKP9 will be displayed.
- (4) Press the CHAN ASSIGN softkey again to enter the new channel assignments. The field-pointer will move back to area ① in Figure C.

# SOURCE SETUP PAGE

SKPI0

[hp] \*\*\*\*\* SOURCE SET UP \*\*\*\*\*

	VAR1	VAR2	
NAME	V3	I2	LINEAR
SWEEP MODE	LINEAR	LINEAR	
START	.0000V	20.00uA	LOG10
STOP	1.0000V	-----	LOG25
STEP	.0100V	20.00uA	
NO. OF STEP	101	5	
COMPLIANCE	100.0mA	2.0000V	
CONSTANT	SOURCE	COMPLIANCE	
V1	COM	.0000V	100.0mA
V4	V	.0000V	100.0mA
VS1	V	.0000V	-----
VS2	V	.0000V	-----

Figure A

Purpose and function of this page :

1. Select the sweep mode (linear or log) for the VAR1 source channel.
2. Set the START, STOP, and STEP values for the VAR1 source channel.
3. Set the START and STEP values and NO. OF STEP for the VAR2 source channel.
4. Set the RATIO and OFFSET values for the VAR1' source channel.
5. Set the HOLD TIME and DELAY TIME.
6. Set the source (output) value for the CONST channels.
7. Set the COMPLIANCE value for each source channel.

Setup :

To change or enter source channel parameters on this page, move the field-pointer (▶) to the desired field and enter the parameter value with the ENTRY keys. Each time an entry is made the field-pointer will automatically move to the next field, as shown in Figure B. Except for SWEEP MODE, only numeric values and engineering units (m, μ, n, p) can be entered on this page. The source name assigned to each source channel on the CHANNEL DEFINITION page is automatically entered on this page.

Note

Entered value may be automatically changed to acceptable value when the ENTER key is pressed or the page is changed.

Figure 3-24. SOURCE SETUP Page (Sheet 1 of 4)

[hp] \*\*\*\*\* SOURCE SET UP \*\*\*\*\*

	VAR1	VAR2
NAME	V3	I2
SWEEP MODE		LINEAR
START		
STOP		
STEP		
NO. OF STEP		
COMPLIANCE		

	CONSTANT	SOURCE	COMPLIANCE
V1	COM		
V4	V		
VS1	V		
VS2	V		

Figure B

Parameter Entry :

When entering numeric values on this page, it is not necessary to enter the value unit. The unit for voltage values is V (volt); for current values, A (ampere); and for time values, s (seconds). For example, the key strokes required to enter a current value of 10.5mA are

1 0 . 5 m ENTER

This value, 10.5m, will be displayed on the Keyboard Input Line. When the ENTER key is pressed the entered value will be moved to the field at which the field-pointer is located and the unit A will be automatically entered. Voltage and current limits for the SMUs and voltage sources (Vs) are listed below. Refer to Table 3-6 for specifiable voltage and current.

SMU	Voltage Range	0 to ±100V
	Current Range	0 to ±100mA
Vs	Voltage Range	0 to ±20V

Note

Values can be entered in fixed decimal format or floating decimal format (scientific notation).

SWEEP MODE Selection :

SWEEP MODE can be selected only with the softkeys and only when the field-pointer is in the SWEEP MODE row of the VAR1 column.

LINEAR : Linear staircase sweep at the specified STEP value

LOG 10 : }  
 LOG 25 : } Logarithmic staircase sweep at 10, 25, or 50 measurements per decade  
 LOG 50 : }

Figure 3-24. SOURCE SETUP Page (Sheet 2 of 4)

**START, STOP, STEP Values for VAR1 :**

START and STOP determine the sweep range for the VAR1 source channel. START value can be less than, equal to, or greater than the STOP value. If LOG has been selected as the SWEEP MODE, START and STOP must have the same signs. If the specified START and STOP values are identical, no sweep is performed and measurement is made at one point only. STEP determines the number of measurement points for LINEAR sweep. If LOG has been selected as the SWEEP MODE, the instrument's operating system software automatically calculates and enters the appropriate STEP value. In LINEAR SWEEP MODE, if the STEP value is greater than the START/STOP range ( $STEP > |STOP - START|$ ), no sweep is performed and measurement is made at the START value only. NO. OF STEP (number of steps) for VAR1 is automatically calculated by the instrument as

$$\text{NO. OF STEP} = \left\lfloor \frac{STOP - START}{STEP} \right\rfloor + 1 \quad (3-2)$$

The START, STOP, and STEP values must be such that NO. OF STEP does not exceed 1024. Also, both the START and STOP values for LOG sweep must be greater than zero. Even if zero is entered, it is automatically changed to 1mV or 1pA.

**START, STEP, and NO. OF STEP for VAR2 :**

START, STEP, and NO. OF STEP (number of steps) determine the sweep range for the VAR2 source channel. VAR2 sweeps are VAR1 dependent; that is, VAR2 is swept one STEP for each complete sweep of VAR1. The maximum NO. OF STEP for VAR2 is 32. When only one monitor channel (SMU or Vm) is used the maximum number of measurement points is

$$\text{Measurement Points} = (\text{NO. OF STEP VAR1}) \times (\text{NO. OF STEP VAR2}) \quad (3-3)$$

If the number of measurement points exceeds 1140, "Buffer full" will be displayed on the CRT.

**RATIO and OFFSET Values for VAR1' :**

VAR1' can be swept in unison with VAR1 at a constant RATIO or OFFSET. The output from the VAR1' source channel is calculated as

$$\text{VAR1}' = (\text{RATIO}) \times \text{VAR1} \quad (3-4)$$

$$\text{VAR1}' = \text{VAR1} + (\text{OFFSET}) \quad (3-5)$$

To enter RATIO and OFFSET, move the field-pointer to area ② or ③ in Figure C, press the VAR1' RATIO or VAR1' OFFSET softkey, enter the desired value, and press EXECUTE. The entered value will be displayed on the CRT, between the two tables. Both RATIO and OFFSET can be entered, but only the one displayed on this page is valid during measurement.

**Note**

The specified RATIO or OFFSET values must be such that the VAR1' source channel does not exceed its maximum output (SMU,  $\pm 100V$ ; Vs,  $\pm 20V$ ). Also, output from VAR1' may lead or lag the VAR1 output by 1ms in V mode and from 4ms to 50ms in I mode. For log sweep measurements, only VAR1' RATIO can be specified.

**HOLD TIME and DELAY TIME :**

HOLD TIME is the initial wait time and the wait time after a VAR2 step change. DELAY TIME is the wait time after VAR1 step change. To enter HOLD TIME and DELAY TIME, move the field-pointer to area ② or ③ in Figure C, press the HOLD TIME or DELAY TIME softkey, enter the desired value, and press EXECUTE.

**SOURCE Value for CONSTANT Channels :**

The NAME and SOURCE MODE of all source channels that were assigned the CONST SOURCE FCTN on the CHANNEL DEFINITION page are listed in the CONSTANT column on this page. The order in which they are listed is identical to the order on the CHANNEL DEFINITION page. To enter the SOURCE value, move the field-pointer to the desired field, key in the value, and press ENTER. The SOURCE value for a COM source channel is set to 0V by the instrument and cannot be changed.

**COMPLIANCE Value :**

COMPLIANCE is a special feature for protecting samples against over-voltage or over-current damage. Refer to paragraph 3-32. It limits the current output from a voltage source or the voltage output from a current source. COMPLIANCE for a COM source is set to 105mA by the instrument. The COMPLIANCE for a CONSTANT Vs is 10mA but is not displayed on this page.

**Softkey Prompts (SKP) :**

Depending on the position of the field-pointer, the softkey prompts automatically change. Figure C shows the relationship between the position of field-pointer and softkey prompts.

[/p]\*\*\*\*\* SOURCE SET UP \*\*\*\*\*

	VAR1	VAR2
NAME	V3	I2
SWEEP MODE	LIN ①	LINFAR
START	.0000V	20.0 ④
STOP	1.000V ②	---
STEP	.0100V	20.000A
NO. OF STEP	101	5 ⑤
COMPLIANCE	10.0 ③	2.0000V

CONSTANT	SOURCE	COMPLIANCE
V1	COM	.0000V
		105.0mA
		⑦
V4	V	.100V ⑥
VS1	V	.0000V
VS2	V	.0000V

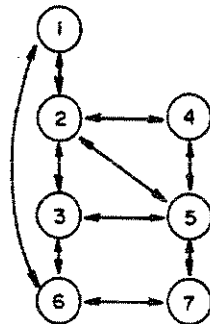

①	② ③	④ ⑤ ⑥ ⑦
SKP10	SKP11	SKP12
[ ]	[ ]	[ ]
LYREAR	[ ]	[ ]
LOG10	[ ]	[ ]
LOG5	[ ]	[ ]
LOGMS	VARI	[ ]
[ ]	VAR2	[ ]
[ ]	STEP	[ ]
[ ]	HOLD	[ ]
[ ]	DELAY	[ ]

Figure C

Figure 3-24. SOURCE SETUP Page (Sheet 4 of 4)

# MEAS & DISP MODE SETUP PAGE

SKP13

[hp] \*\* MEAS & DISP MODE SET UP \*\*

MEASUREMENT MODE, SWEEP \_\_\_\_\_

GRAPH  
YES

LIST

DISPLAY MODE, GRAPHICS \_\_\_\_\_

	X axis	Y1axis	Y2axis
NAME	V3	I3	
SCL	LINEAR	LINEAR	
MIN	.0000V	.000 A	
MAX	1.0000V	10.000mA	

MATRIX

SCHMOO

SKP14

LINEAR

LOG

SKP15

I1

V2

I3

I4

VM1

VM2

SKP16

EXTN

EXTN

EXTN

EXTN

EXTN

EXTN

EXTN

SKP17

EXTN

EXTN

EXTN

EXTN

EXTN

EXTN

EXTN

Figure A

Purpose and function of this page :

1. Select the Display Mode for the measurement.
2. Select the monitor channels.
3. Set up the display parameters.

**MEASUREMENT MODE :**

The existing MEASUREMENT MODE — SWEEP or TIME DOMAIN — is displayed on this page but cannot be changed on this page. MEASUREMENT MODE depends on whether or not VAR1 is assigned to a source channel (SMU or Vs) on the CHANNEL DEFINITION page. If VAR1 is assigned, MEASUREMENT MODE is SWEEP; if not, MEASUREMENT MODE is TIME DOMAIN. Refer to paragraph 3-80 for details on TIME DOMAIN measurements.

**DISPLAY MODE Selection :**

When this page is initially displayed, the field-pointer (▶) will be located on the DISPLAY MODE line and the display modes — GRAPHICS, LIST, MATRIX, SCHMOO — will be listed in the softkey prompt area of the CRT. The table below the DISPLAY MODE line will change depending on which display mode is selected. The field-pointer will automatically move as names are selected and values are input and the softkey prompts will change depending on the location of the field-pointer.

DISPLAY MODE can be selected only when the field-pointer is on the DISPLAY MODE line. To select the DISPLAY MODE, press the desired softkey. The field-pointer will automatically move to the NAME field of the DISPLAY MODE table.

Figure 3-25. MEAS & DISP MODE SETUP Page (Sheet 1 of 6)

3-47

### GRAPHICS PLOT Setup :

Pressing the NEXT key when this page is as shown in Figure A will display the GRAPHICS PLOT page, as shown in Figure B. The name and scaling of each axis is determined by the NAME, SCL, MIN, and MAX information appearing on the MEAS/DISP MODE SETUP page.

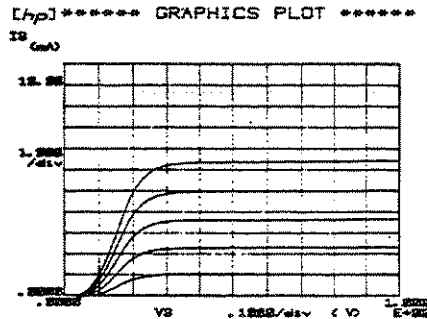

Figure B

- NAME :** Can be entered only with the softkeys. Determines the channels that will be used in the measurement. Only those channels whose names are listed in the softkey prompt area can be selected. The channel names or user-function names (press EXTN) selected on this page will be X, Y<sub>1</sub>, and, if used, Y<sub>2</sub> axes on the GRAPHICS PLOT page.
- SCL (Scale) :** Determines the grid scaling on the GRAPHICS PLOT page. LINEAR or LOG can be selected with the softkeys. Not related to the SWEEP MODE selected on the SOURCE SETUP page.
- MIN/MAX :** Determines the minimum and maximum values of each axis. Value units (V or A) are automatically entered by the instrument.

#### Note

MIN and MAX must have the same sign for an axis that is to be displayed with LOG scaling. Also, if 0 is entered for MIN or MAX in LOG scale, 0.1mV, 0.01pA, or 1E-35 is assumed.

### GRAPHICS DISPLAY Scaling :

Scaling on the GRAPHICS PLOT page depends on the selected SCL and the MIN and MAX values.

1. When LINEAR has been selected and 0 is not within the MIN/MAX range (i.e.,  $0 \leq \text{MIN}$  or  $\text{MAX} \geq 0$ ), MIN and MAX will be located as shown in Figure C.



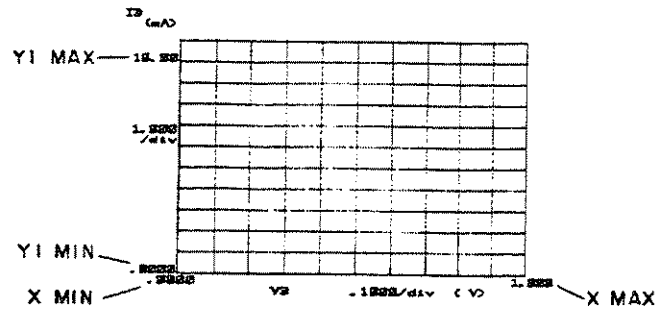

Figure C

When setup for LINEAR scaling, the X axis has 10 divisions and the Y axes, 11. The value per division is calculated as

$$\text{Value/div.} = \frac{|\text{Max}-\text{Min}|}{10} \quad (3-6)$$

2. When LINEAR has been selected and 0 is within the MIN/MAX range (i.e.,  $\text{MIN} < 0 < \text{MAX}$ ), the MIN and MAX values specified on the MEAS/DISP MODE SETUP may be different from those displayed on the GRAPHICS PLOT page. This occurs when the MIN or MAX value is not a multiple of Value/div. in equation 3-6. Division scaling is always in reference to 0. For example if the MIN and MAX values on the MEAS/DISP MODE SETUP page are -2 and 1, respectively, the MIN and MAX values displayed on the GRAPHICS PLOT page are -.12 and .96, respectively.
3. When LOG has been selected, the number of divisions depends on the number of decades between the MIN and MAX values. For example, when the MIN and MAX values are 1 and 9, respectively, only one division is displayed and the displayed MIN and MAX values are 1E00 and 1E+01; when the MIN and MAX values are 0.9 and 10, respectively, two divisions are displayed and the displayed MIN and MAX values are 1E-01 and 1E+01.

- Notes:
- 1) If Y<sub>1</sub> and Y<sub>2</sub> have different scale modes (SCL), the division lines displayed on the GRAPHICS PLOT page are for Y<sub>1</sub>, and Y<sub>2</sub> will have a separate set of tick marks.
  - 2) In LOG scale, an extra decade may be displayed because of the quantum error, and also if the MIN/MAX range is very large, part of the graph will not have division lines.
  - 3) If MIN and MAX are close, their displayed value may include quantum error, and if they are so close that the difference between them is smaller than best resolution, the maximum allowable resolution is used.

1mV (voltage)  
 50pA (current)  
 100ms (time)  
 1E-34 (user function units)

Also, 1 division can not be less than 0.1 in LOG scale :

Figure 3-25. MEAS &amp; DISP MODE SETUP Page (Sheet 3 of 6)

**LIST DISPLAY Setup :**

When LIST is selected on the DISPLAY MODE line, the MEAS/DISP MODE SETUP page will be as shown below.

[hp]\*\* MEAS & DISP MODE SET UP \*\*

MEASUREMENT MODE: SWEEP

DISPLAY MODE: LIST

NAMES	IC

Figure D

The field-pointer will be in the top row of the NAMES table. Up to six of the names listed in the softkey prompt area can be entered. Measurement results of each name listed here will be digitally listed on the LIST DISPLAY page. The measurement results are those obtained at each VAR1 step.

**MATRIX DISPLAY Setup :**

When MATRIX is selected on the DISPLAY MODE line, the MEAS/DISP MODE SETUP page will be as shown below.

[hp]\*\* MEAS & DISP MODE SET UP \*\*

MEASUREMENT MODE: SWEEP

DISPLAY MODE: MATRIX

NAME	IC

Figure E

The field-pointer will be in the top row of the NAMES table. Only one of the names listed in the softkey prompt area can be entered. Measurement results of the name listed here will be digitally listed on the MATRIX DISPLAY page. The measurement results are those obtained at each VAR1 and VAR2 step.

**Note**

If VAR2 is not assigned on the CHANNEL DEFINITION page, only one sweep will be made and thus only one set of measurement results will be listed.

SCHMOO PLOT Setup :

When SCHMOO is selected on the DISPLAY MODE line, the MEAS/DISP MODE SETUP page will be as shown below.

[hp] \*\* MEAS & DISP MODE SET UP \*\*

MEASUREMENT MODE: SWEEP

DISPLAY MODE: SCHMOO

NAME	HFE
M	150. E+00
Δ	140. E+00
+	130. E+00
:	120. E+00

Figure F

A SCHMOO PLOT is a three dimensional display, where VAR1 is the X-axis, VAR2 is the Y-axis, and the channel whose name is listed in the NAME field is the Z-axis. When measurement is made, the results are distinguished by the symbols listed in the SCHMOO table. X-axis and Y-axis scaling is determined by the VAR1 and VAR2 sweep parameters. The LIMIT for each symbol is the lower limit. For example, if the LIMITs for M and Δ are .500 and .100, respectively, M represents measurement results greater than .500 and Δ represents measurement results between .100 and .500. For measurement results less than the LIMIT for :, - is used. To enter a LIMIT, move the field-pointer to the M, Δ, +, or : field, enter the value with the ENTRY keys, and press ENTER.

SCHMOO PLOT Scaling :

X and Y axes scaling is determined by the VAR1 and VAR2 sweep parameters. The X-axis can have up to 41 points and the Y axis, up to 21 points. MIN and MAX values for each axis are calculated as follows :

1. SWEEP MODE of VAR1 is LINEAR :

$$\left. \begin{aligned} \text{X-axis (VAR1): MIN} &= a, \text{ MAX} = a+40xb \\ \text{Y-axis (VAR2): MIN} &= c, \text{ MAX} = c+20xd \end{aligned} \right\} (3-7)$$

where a = START value of VAR1  
 b = STEP value of VAR1  
 c = START value of VAR2  
 d = STEP value of VAR2

when STEP = 0, MIN and MAX = START.

2. SWEEP MODE of VAR1 is LOG :

$$\left. \begin{array}{l} \text{X-axis (VAR1): MIN = a, MAX = } ax10^{\frac{40}{\alpha}} \\ \text{Y-axis (VAR2): MIN = c, MAX = c+20xd} \end{array} \right\} (3-8)$$

where

a = START value of VAR1  
 $\alpha$  = Number of steps per decade (10, 25, 50)  
 c = START value of VAR2  
 d = STEP value of VAR2

Note

Equation 3-8 applies only when  $\text{START} \leq \text{STOP}$ . When  $\text{START} > \text{STOP}$ , X-axis MAX value is calculated as

$$\text{X-axis: MAX} = ax10^{-\frac{40}{\alpha}} \quad (3-9)$$

# GRAPHICS PLOT PAGE

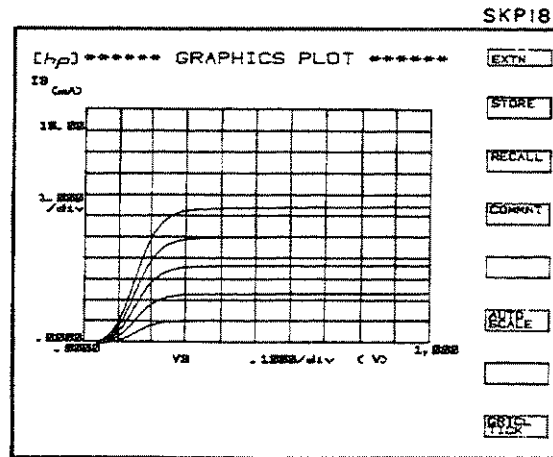

Figure A

Function of this page :

1. Graphically display measurement results.
2. Allow analysis of measurement results with the softkeys and arithmetic capabilities.

**MEASUREMENT :**

Each time this page is displayed, the results of the previous measurement are automatically re-displayed, regardless of the display mode used in the previous measurement. If any change is made on the CHANNEL DEFINITION page or SOURCE SETUP page or if a NAME on the MEAS/DISP MODE SETUP page is changed, the results of the previous measurement are erased from the data buffer and a new measurement must be made. To make a new measurement, press the SINGLE, REPEAT, or APPEND key. Measurement results will be displayed as the measurement progresses.

- Notes :
- 1) If the X axis value or Y axis value of a measurement point is outside the plot area, no trace will be drawn between it and the previous and succeeding measurement points.
  - 2) In LOG scale, if the measurement data has two polarities, result is not correctly displayed.
  - 3) Max 1151 measurement points can be displayed.

**Softkey Prompts (SKP) :**

Softkey prompts displayed on the GRAPHICS PLOT page are shown in Figure B.

SKP 18 is displayed when this page is first displayed. The other SKPs (19 through 23) can be displayed by pressing the EXTN softkey. When EXTN is pressed on SKP23, SKP18 is displayed. SKP23 (blank) can be used when taking photographs of the CRT.

Figure 3-26. GRAPHICS PLOT Page (Sheet 1 of 6)

SKP 18	SKP 19	SKP 20	SKP 21	SKP 22	SKP 23
EXTN	EXTN	EXTN	EXTN	EXTN	
STORE	MARKER	LONG CURSOR	CURSOR	START	
RECALL		← →	LINE ON	STOP	
COMMNT	NOTES PLATE	→ ←	LINE1	STEP	
		:	LINE2	START	
SCALE	MARKER	:	MODE	STEP	
		MOVE WINDOW	GRAB VALUE	MODE	
EXIT		RESET	PRINT	MENU	

Figure B

Softkey Functions :

- STORE** : Stores displayed measurement results.
- RECALL** : Recalls (re-displays) stored measurement results.

These two softkeys provide overlay comparisons of two measurement results. To store the results of a measurement, press the STORE softkey. The frame around the STORE softkey prompt will be highlighted until the data is completely stored, after which it will return to normal intensity. Measurement results are stored in the display buffer as background data, and when recalled, will be of slightly less intensity than normal. Two important points to remember are (1) scaling information is not stored and (2) rescaling is not performed on recalled measurement results, even if the AUTO SCALE function is used. Thus, if the plot to be overlaid is scaled differently from the stored plot, any comparison between the two is meaningless. To recall a stored plot, press the RECALL softkey. The frame around the softkey prompt will be highlighted and will remain so until the softkey is pressed again.

**COMMNT** :

User-entered comments of up to 30 characters can be displayed on the CRT. The procedure is as follows :

1. Press the COMMNT softkey. The frame around the softkey prompt will be highlighted and the BLUE key will be set to on.
2. Key in the comment (up to 30 characters). There is no restriction on character type.
3. Press the ENTER key. The comment will be displayed directly below the page title and the frame around the COMMNT softkey prompt will be de-highlighted (normal intensity).

With the comment function set to on (COMMNT softkey prompt highlighted), anything displayed on the Keyboard Input Line will be entered and displayed as a comment if the ENTER key is pressed, even if a comment is already displayed below the page title. This allows you to change or delete an existing comment. For example, to delete a comment, press the COMMNT softkey, CLEAR the Keyboard Input Line, and press ENTER.

Figure 3-26. GRAPHICS PLOT Page (Sheet 2 of 6)

**AUTO SCALE** :

Re-scales the plot area to provide optimum display of the existing measurement results. When auto-scaling is performed, the minimum and maximum measured values are used as the plot-area scaling factors. The MIN and MAX values specified on the MEAS/DISP MODE SETUP page, however, are not changed and the new scaling factors are cancelled when the PREV or MENU key is pressed. To re-scale the existing plot, press the AUTO SCALE softkey. The frame around the softkey prompt will be highlighted and will remain so until auto-scaling is completed, about 5 seconds.

**GRICL TICK** :

Graticule or tick mode control. When this softkey is pressed, grid lines are replaced by tick-marks along each axis. To return to graticule mode, press this softkey again.

**MARKER** :

Displays a marker (⊙) which can be moved along plotted curves by rotating the MARKER dial. X, Y<sub>1</sub>, and Y<sub>2</sub> coordinates of the marker location are digitally displayed above the plot area. When the Y<sub>2</sub> axis is used, two markers (⊙,\*) are displayed. Both have the same X-axis coordinates and move in unison. The marker can be used for keyboard calculations. Instead of entering the numeric value of a measurement result, the channel name can be entered.

## Note

When a log sweep is made, marker location displayed may include quantum error.

**INTERPOLATE** :

Used for higher resolution marker positioning. Normally the marker moves from one measurement point to the next and cannot be positioned between two measurement points. With the INTERPOLATE function, however, the marker can be positioned at any point between two measurement points.

**MARKER SKIP** :

Moves the marker or markers to the next VAR2 step. VAR1 does not change. If this softkey is pressed when the marker is at the last VAR2 step, the marker will return to the first VAR2 step. Also, INTERPOLATE is turned off when MARKER SKIP is performed.

**LONG  
CURSOR** :

Displays the LONG CURSOR. When this softkey is pressed, the frame around the softkey prompt will be highlighted and the LONG CURSOR will be displayed at the center of the plot area. The LONG CURSOR can be moved to any point in the plot-area by pressing the appropriate CURSOR keys. Pressing the FAST CURSOR key while pressing one of the directional CURSOR keys moves the cursor faster. The X, Y<sub>1</sub>, and Y<sub>2</sub> coordinates of the cursor location are digitally displayed above the plot area. The LONG CURSOR is turned off by pressing this softkey again, by turning on the SHORT CURSOR, or by pressing the PREV or MENU key.

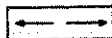
 : Horizontal zoom-in (x2).

 : Horizontal zoom-out (x2).

 : Vertical zoom-in (x2).

 : Vertical zoom-out (x2).

These softkeys are used in conjunction with the LONG and SHORT cursors to zoom-in on or zoom-out from the cursor location. When one of these keys is pressed, the cursor will be repositioned at the center of the plot-area and the whole plot-area, including the plotted curves, will be enlarged or reduced in the indicated direction. The relative position of the cursor and plotted curves remains the same. That is, when the cursor is centered by the zoom function, the plotted curves are moved in reference to the cursor. Vertical zooming is performed on the Y<sub>1</sub>-axis only.

**MOVE  
WINDOW** :

Moves the LONG CURSOR or SHORT CURSOR to the center of the plot area, maintaining the relative position of the cursor and plotted curves.

**SHORT  
CURSOR** :

Displays the SHORT CURSOR. When this softkey is pressed, the frame around the softkey prompt will be highlighted and the SHORT CURSOR will be displayed at the center of the plot-area. The CURSOR can be moved to any point in the plot-area by pressing the appropriate CURSOR keys. Pressing the FAST CURSOR key while pressing one of the directional keys moves the cursor faster. The X, Y<sub>1</sub>, and Y<sub>2</sub> coordinates of the cursor location are digitally displayed above the plot area. The SHORT CURSOR is turned off by pressing this softkey again, by turning on the LONG CURSOR, or by pressing the PREV or MENU key.

## Note

When the LINE is displayed and either SHORT or LONG CURSOR is on, the location of the CURSOR may change if AUTO-SCALE, ZOOM or MOVE WINDOW is performed.

Figure 3-26. GRAPHICS PLOT Page (Sheet 4 of 6)



**CURSOR** :

Moves the LONG CURSOR or SHORT CURSOR to the position of the MARKER. MARKER must be turned on.

**LINE** :

Turns on the instrument's graphics analysis functions — LINE 1, LINE 2, GRAD MODE, GRAD VALUE, and CHANGE POINT. When this softkey is pressed, LINE 1 (solid line) and two SHORT CURSORS are displayed. The GRAD, 1/GRAD, X-intercept, and Y-intercept values are also displayed, below the plot area. The graphics analysis functions are available only when this softkey is turned on (frame highlighted).

**LINE1** : Displays LINE 1 (solid line)**LINE2** : Displays LINE 2 (dashed line)

Each line has two SHORT CURSORS. One cursor is moveable and the other is fixed. The gradient, or slope, of each line can be changed by moving the moveable cursor with the CURSOR keys. Both lines can be displayed at the same time, but only one (frame highlighted) can be moved. The gradient (GRAD), gradient reciprocal (1/GRAD), X-intercept, and Y-intercept values for both lines are displayed below the plot area. The moveable cursor and fixed cursor can be interchanged by pressing the CHANGE POINT softkey.

**GRAD MODE** :

Fixed gradient value. When this key is pressed, the fixed cursor is turned off (only the moveable cursor remains), and the line moves at a constant gradient value.

**GRAD VALUE** :

Line gradient entry. The desired line gradient can be entered from the front panel. When this softkey is pressed, the existing gradient value will be displayed on the Keyboard Input Line. To enter a new value, press the CLEAR key, key in the desired value, and press ENTER. The line will automatically adjust to the new gradient.

**CHANGE POINT** :

Interchanges the moveable and fixed cursors of the line.

#### Note

GRAD value and 1/GRAD value display 170E+39 and 5.88E-39 instead of overflow and zero, respectively.

- VAR1 START** : Changes the START value for VAR1.
- VAR1 STOP** : Changes the STOP value for VAR1.
- VAR1 STEP** : Changes the STEP value for VAR1.
- VAR2 START** : Changes the START value for VAR2.
- VAR2 STEP** : Changes the STEP value for VAR2.
- HOLD TIME** : Changes the HOLD TIME (0 - 655.35 sec).
- DELAY TIME** : Changes the DELAY TIME (0 - 6.500 sec).

These softkeys allow the operator to check or change the existing measurement parameters, without having to return to the SOURCE SETUP page. The new values are automatically entered on the SOURCE SETUP page. Measurement parameter values can be changed during measurement but only DELAY TIME is valid immediately; HOLD TIME is valid for the next VAR2 step; VAR1 and VAR2 parameters are valid for the next measurement.

#### Notes

- 1: Range and resolution are the same as those on the SOURCE SETUP page.
- 2: Error message "Step overflow" will be displayed when an attempt is made to enter a value that causes the number of steps for VAR1 to exceed 1024.
- 3: VAR1 START, STOP, and STEP softkeys are disabled when VAR1 has not been assigned (e.g., Time Domain measurement), and when VAR1 is assigned VAR2 START and STEP softkeys are disabled when VAR2 has not been assigned. VAR1 STEP is disabled in log sweeps. Also, HOLD TIME and DELAY TIME are disabled in Time Domain measurement.

Figure 3-26. GRAPHICS PLOT Page (Sheet 6 of 6)

# LIST DISPLAY PAGE

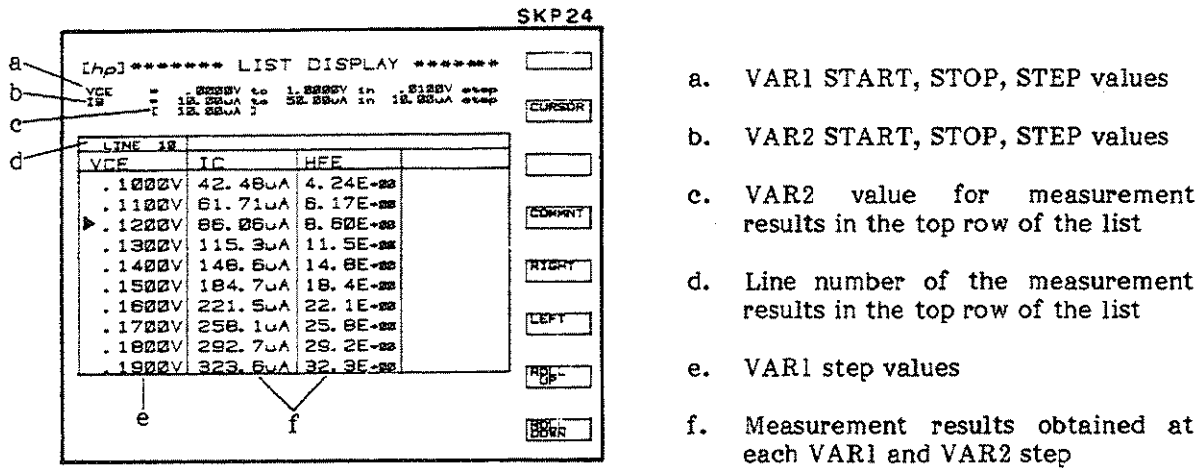

Figure A

Function of this page :

1. Display the measurement results obtained at each VAR1 and VAR2 (if used) step for all monitor channels selected on the MEAS/DISP MODE SETUP page.
2. Allow analysis of measurement results with the softkeys and arithmetic capabilities.

**MEASUREMENT :**

Each time this page is displayed, the results of the previous measurement are automatically re-displayed, regardless of the display mode used in the previous measurement. If any change is made on the CHANNEL DEFINITION page or SOURCE SETUP page or if a NAME on the MEAS/DISP MODE SETUP page is changed, the results of the previous measurement are erased from the data buffer and a new measurement must be made. To make a new measurement, press the SINGLE, REPEAT, or APPEND key. Measurement results of the first three monitor channels selected on the MEAS/DISP MODE SETUP page will be displayed as the measurement progresses. The list contains four columns. Each VAR1 step is listed in the left-most column. The VAR2 STEP corresponding to the top line VAR1 STEP is displayed in brackets above the list (c in Figure A). The remaining three columns list the measurement results of the first three monitor channels selected on the MEAS/DISP MODE SETUP page. If more than three monitor channels are selected on the MEAS/DISP MODE SETUP page, measurement results for the fourth, fifth, and sixth monitor channels can be displayed by pressing the LEFT softkey. Only ten lines can be displayed. To display additional lines, use the ROLL UP or ROLL DOWN softkeys.

Figure 3-27. LIST DISPLAY Page (Sheet 1 of 3)

**DISPLAY :**

Measurement results are displayed in a 3x10 "window", as shown in Figure B. The "field" can be moved left, right, up, or down by pressing the LEFT, RIGHT, ROLL UP, or ROLL DOWN softkey to view other measurement results.

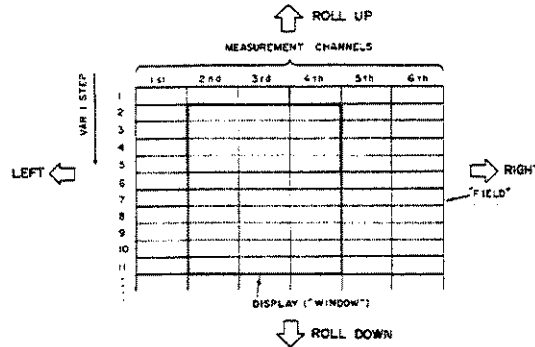

Figure B

**Softkey Functions :**

This page has only one softkey prompt (shown in Figure A). The function of each softkey is described below.

**CURSOR :**

Turns on the line cursor (▶). When this softkey is pressed, the cursor will be displayed in the VAR1 column and it can be moved up or down with the CURSOR keys. The cursor is used when making keyboard calculations. Instead of entering the numeric value of a measurement result or VAR1 or VAR2 step, the channel name can be used in arithmetic expressions. Using the values listed in Figure A, suppose you want to calculate the square root of IC when VCE is .1200V. Simply move the cursor down the VCE column and stop at VCE = .1200V, then key in

EXECUTE

The square root of 86.06  $\mu$ A will then be displayed on the Keyboard Input Line.

**COMMNT** :

User-entered comments of up to 30 characters can be displayed on the CRT. The procedure is as follows :

1. Press the COMMNT softkey. The frame around the softkey prompt will be highlighted and the BLUE key will be set to on.
2. Key in the comment (up to 30 characters). There is no restriction on character type.
3. Press the ENTER key. The comment will be displayed directly below the page title and the frame around the COMMNT softkey prompt will be de-highlighted (normal intensity).

With the comment function set to on (COMMNT softkey prompt highlighted), anything displayed on the Keyboard Input Line will be entered and displayed as a comment if the ENTER key is pressed, even if a comment is already displayed below the page title. This allows you to change or delete an existing comment. For example, to delete a comment, press the COMMNT softkey, CLEAR the Keyboard Input Line, and press ENTER.

**RIGHT** : Shifts the monitor channel columns to the right.

**LEFT** : Shifts the monitor channel columns to the left.

**ROLL  
UP** : Rolls the list up.

**ROLL  
DOWN** : Rolls the list down.

These softkeys allow the operator to view all measurement results. (Refer to Figure B.) When the ROLL UP or ROLL DOWN softkey is pressed and held, line movement is continuous.

#### Note

When ROLL UP/DOWN is performed during measurement which has more than 100 steps, displayed values may include rounding errors.



DISPLAY :

Measurement results are displayed in a 3 x 10 "window," as shown in Figure B. The "field" can be moved left, right, up, or down by pressing the LEFT, RIGHT, ROLL UP, or ROLL DOWN softkeys to view other measurement results.

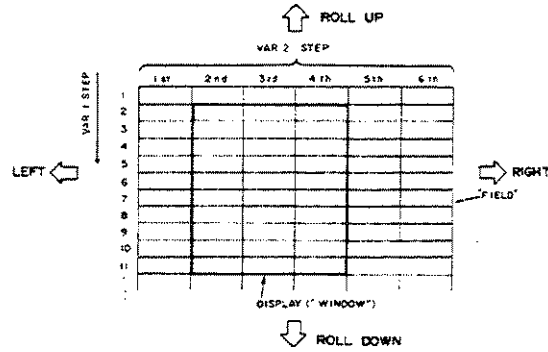
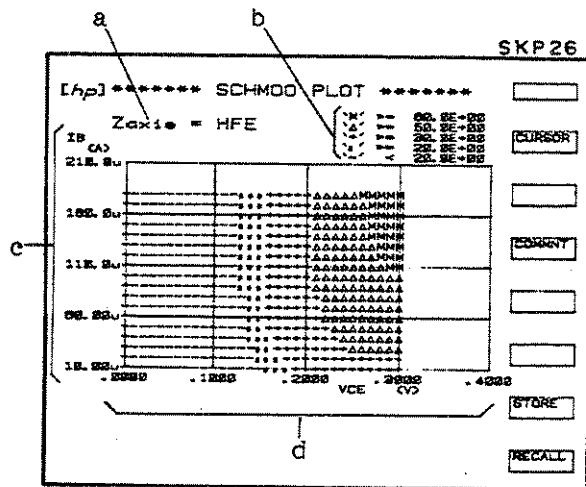

Figure B

Softkey Prompts :

This page has only one softkey prompt (shown in Figure A). Refer to the Softkey Functions description given in Figure 3-29 for the function of each softkey.

## SCHMOO PLOT PAGE



- a. Monitor channel name selected on the MEAS/DISP MODE SETUP.
- b. Limits specified on the MEAS/DISP MODE SETUP page.
- c. VAR2 source name
- d. VAR1 source name

Figure A

Function of this page :

1. Plot measurement results on an X-Y-Z graph.
2. Allow analysis of measurement results with the softkeys and arithmetic capabilities.

## MEASUREMENT:

To make a measurement, press the SINGLE or REPEAT key (APPEND can not be used). Measurement results will be displayed as the measurement progresses.



### X-Axis and Y-Axis Scaling :

Scaling for the X and Y axes is determined by the START and STEP values of VAR1 and VAR2 and by the VAR1 SWEEP MODE. The maximum number of measurement points along the X-axis is 41; along the Y-axis, 21.

#### 1. Linear VAR1 Sweep :

X-axis (VAR1): Min. = a, Max. = a + 40 x b  
 Y-axis (VAR2): Min. = c, Max. = c + 20 x d

where            a = VAR1 START value  
                   b = VAR1 STEP value  
                   c = VAR2 START value  
                   d = VAR2 STEP value

#### Note

STOP value is not used in determining axes scaling. Also, if the VAR1 STEP value or VAR2 STEP value is 0, the minimum and maximum scale values for the respective axis are set to the START value.

#### 2. Logarithmic VAR1 Sweep :

X-axis (VAR1): Min. = a, Max. = a x 10 <sup>$\frac{40}{\alpha}$</sup>   
 Y-axis (VAR2): Min. = c, Max. = c + 20 x d

where            a = VAR1 START value  
                    $\alpha$  = Number of step per decade (10, 25, or 50)  
                   c = VAR2 START value  
                   d = VAR2 STEP value

#### Note

If VAR1 START > STOP, the exponent in the equation for X-axis Max. becomes as follows.

$$\text{X-axis Max.} = a \times 10^{-\frac{40}{\alpha}}$$

Figure 3-29. SCHMOO PLOT Page (Sheet 2 of 3)

**Softkey Functions :**

This page has only one softkey prompt (shown in Figure A). The function of each softkey is described below.

**CURSOR :**

Similar to the CURSOR on the GRAPHICS PLOT page. The cursor highlights the symbol at a measurement point. To move the cursor, use the CURSOR keys. The cursor can be used to simplify keyboard calculations.

**Note**

When the cursor is moved to a part of the plot area where there are no symbols, \* is displayed and no Z-axis value is displayed.

**COMMNT :**

Same as the COMMNT softkey on the other display pages.

**STORE** : Stores displayed measurement results.

**RECALL** : Replaces displayed measurement results with stored measurement results.

These softkeys are similar to the STORE and RECALL softkeys on the GRAPHICS PLOT page (Figure 3-26). The only difference is that recalled measurement results are not displayed over the existing measurement results; that is, only one set of measurement results is displayed. When the frame around the RECALL softkey prompt is highlighted, only stored measurement results are displayed. Conversely, when the frame is not highlighted only the results of the last measurement are displayed. STORE and RECALL operations on this page are unrelated to those on the GRAPHICS PLOT page. For example, measurement results stored on the GRAPHICS PLOT page cannot be recalled on this page.

Figure 3-29. SCHMOO PLOT Page (Sheet 3 of 3)

# AUTO SEQUENCE SETUP PAGE

SKP 27		SKP 28
[hp] *** AUTO SEQUENCE SET UP ***	[EXTN]	[EXTN]
7 GET P ICBVBE		
8 SINGLE	[GET P]	[PRINT]
9 WAIT 3		
10 GET P HFE1	[SINGLE]	[PAUSE]
11 SINGLE		
12 WAIT 3		
13 GET P VCESAT	[SAVE D]	[PAGE]
14 SINGLE		
15 WAIT 3	[REC SAVE D]	[ASS CLEAR]
16 GET P CDLR		
17 SINGLE	[PLOT]	[ ]
18 GET P HFE1		
19 SINGLE	[SAVE PLOT]	[LINE DELETE]
20 PAUSE		
21 GET P NPN1	[WAIT]	[LINE INSERT]
22 SINGLE		
23 PAUSE		
24 PLOT 100, 100, 7000, 7000		
25 GET P BV		
26 SINGLE		
27 PLOT 100, 100, 7000, 7000		
28 PAUSE		
29 SINGLE		
30 CPLOT 100, 100, 7000, 7000		

Figure A

Function of this page :

Set up or edit an auto-sequence program.

Auto-Sequence Program :

An auto-sequence program is setup (written) by the operator and can perform a series of instrument operations, without operator assistance. An auto-sequence program can

1. call pre-stored measurement setups from the disc (GET P command),
2. perform a SINGLE measurement (SINGLE command),
3. store measurement results onto the disc (SAVE D command),
4. store measurement results onto the disc under an existing filename (RSAVED command),
5. dump measurement results onto an HP-IB plotter (PLOT command),
6. dump only measurement curves onto an HP-IB plotter (CPLOT command),
7. print out measurement results onto an HP-IB printer (PRINT command),
8. half execution until CONT is pressed (PAUSE command),
9. wait a specified time (WAIT command), and
10. advance the page on an HP-IB plotter (PAGE command).

Figure 3-30. AUTO SEQUENCE SETUP Page (Sheet 1 of 4)

**Programming:**

Setting up the auto-sequence programs requires no special programming knowledge. When this page is first displayed, the field-pointer will be on line 1 and the auto-sequence commands will be listed in the softkey prompt area of the CRT. To enter a command, simply press the desired softkey. The selected command will be displayed on the line and if the command requires no parameters, the field-pointer will automatically move to the next line. If the command requires parameters (plot area, file name, wait time), the field-pointer will not move, indicating that the operator must enter parameters from the front panel. After the parameters have been keyed in and the ENTER key pressed, the field-pointer will move to the next line. Up to 50 lines can be entered, however up to 24 lines can be displayed at once. The rollover and rolldown of the lines can be effective by the arrow key of the front panel. Blank lines are allowed but are ignored during auto-sequence program execution.

**Program Commands:**

There are eight program commands — GET P, SINGLE, SAVE D, RE-SAVE D, PLOT, CURVE-PLOT, PRINT, PAUSE, WAIT, PAGE. They are available with the softkeys only. Each is described below.

**GET P** : GET P file name

This command calls the specified (file name) measurement setup from the disc and displays the display page (GRAPHICS, LIST, MATRIX, or SCHMOO) specified in the measurement setup. To enter this command, press the GET P softkey, key in the desired file name, and press ENTER.

**SINGLE** :

This command executes one measurement and is, equivalent to pressing the SINGLE key on the front panel. If SINGLE is entered on line 1 of an auto-sequence program, the program can be executed only on the GRAPHICS PLOT, LIST, MATRIX, or SCHMOO PLOT page. Execution on any other page will result in error Z02. To enter this command, press the SINGLE softkey.

**SAVE D** : SAVE D file name

This command stores measurement results into the specified (file name) data file on the disc. The file name specified in this command must be unique; that is, the file name of an existing data file cannot be used. To enter this command, press the SAVE D softkey, key in the desired file name, and press ENTER.

**RE-SAVE D** : RE-SAVE D (displayed "RSAVED") file name

This command stores measurement results into the specified (file name) data file on the disc. The file name specified in this command must be the file name of an existing data file. To enter this command, press the RE-SAVE D softkey, "RSAVED" is displayed on the program line, key in the desired file name, and press ENTER.

**PLOT** : PLOT Xmin, Ymin, Xmax, Ymax

This command dumps the existing display (GRAPHICS PLOT, LIST, MATRIX, or SCHMOO PLOT) onto an HP-IB plotter. Scaling parameters (Xmin, Ymin, Xmax, Ymax) must be delimited by a comma or a space. To enter this command, press the PLOT softkey, key in the scaling parameters, and press ENTER.

Figure 3-30. AUTO SEQUENCE SETUP Page (Sheet 2 of 4)

**CURVE PLOT** : CURVE-PLOT (displayed "CPLOT") Xmin, Ymin, Xmax, Ymax

This command dumps only the measurement results of GRAPHICS PLOT onto an HP-IB plotter. Scaling parameters (Xmin, Ymin, Xmax, Ymax) must be delimited with commas, or by leaving spaces. To enter this command, press the CURVE PLOT softkey, "CPLOT" is displayed on the program line, key in the scaling parameters, and press ENTER.

**PRINT** :

This command outputs measurement results to an HP-IB printer. To enter this command press the PRINT softkey.

**PAUSE** :

This command halts program execution until the CONT key is pressed. While the program is halted, the operator can change paper on the plotter, change test samples, etc. To enter this command, press the PAUSE softkey.

**WAIT** : WAIT time

This command stops program execution for the specified time. Specifiable time is from 0 to 65535 seconds. Fractional values are rounded to the nearest whole number. To enter this command, press the WAIT softkey, key in the desired wait time, and press ENTER.

**PAGE** :

This command advances the plotter paper to the top of the next page. The plotter used must be equipped with automatic paper advance.

#### Program Edit Functions :

There are three program edit functions — ASP CLEAR, LINE DELETE, LINE INSERT. They are available with the softkeys only. Each is described below.

**ASP CLEAR** :

Clears the entire auto-sequence program and returns the field-pointer to line 1.

**LINE DELETE** :

Deletes the program line indicated by the field-pointer.

**LINE INSERT** :

Inserts one blank line between the line at which the field-pointer is located and the preceding line. The field-pointer remains at the blank line and a new command can be entered. If a line is inserted into a 50-line program, the last line is deleted.

**Program Execution :**

To execute an auto-sequence program, press the AUTO SEQ START/STOP key. The program will begin and the AUTO SEQ START/STOP indicator lamp will come on. The line number and the command being executed are displayed on the Keyboard Input Line during program execution. The program continues execution until it comes to a PAUSE command or until all lines have been executed. When the program is halted by the PAUSE command, press the AUTO SEQ CONT key to continue the program. To stop the program, press AUTO SEQ START/STOP key again. The indicator lamp will go off and the program will stop at the present line.

**Note**

An auto-sequence program cannot be executed when the instrument is measuring, plotting, printing, or in GL1 mode (under HP-GL control). The AUTO SEQ STOP key cannot be pressed when the auto-sequence program is executing a GET P, SAVE D or RE-SAVE D command.

**Note**

Once an auto-sequence program containing a SAVE D command is executed, it can not be executed again. If it is executed again, error M05 (file name already reserved) will be displayed on the CRT. To run the auto-sequence program again, use the RE-SAVE command or change the file name specified in the SAVE D command.

**Note**

If an error-code ZXX is displayed, the auto-sequence program stops and waits as if a PAUSE command was executed. Refer to Table 3-3 for meaning of the error-code. To continue the program, press the CONT key. The program continues from the next line.

**Note**

If the length of PLOT command exceeds 26 characters, line number is not displayed when the ASP is executed.

# OUTPUT SEQUENCE SETUP PAGE

SKP 29

[HP] → OUTPUT SEQUENCE SET UP →

	SOURCE NAME	CHANNEL
1	V1	SMU1
2	I2	SMU2
3	V3	SMU3
4	V4	SMU4
5	VS1	V = 1
6	VS2	V = 2

Voltage & current sources are automatically turned on according to the sequence.

V1 SMU1  
 V2 SMU2  
 V3 SMU3  
 V4 SMU4  
 VS1 V = 1  
 VS2 V = 2  
 DEF. FAULT

Figure A

**Function of this page :**

Specify the order in which source channels begin output. When measurement begins, the source channels used in the measurement are turned on in the order specified on this page. The source channels' output sequence is important when measuring devices such as MOSFET transistors or operational amplifier ICs that have FET inputs.

**Setup :**

When the instrument is turned on, the output sequence setup is as shown above. To change the setup use the CURSOR keys (to move the field-pointer) and the softkeys.

**Note**

To include the OUTPUT SEQUENCE SETUP when storing a measurement setup onto the disc, you must return to the MENU after setting up this page. Only then will the new OUTPUT SEQUENCE SETUP be valid for a SAVE P operation.

Figure 3-31. OUTPUT SEQUENCE SETUP Page.

# USER FILE CATALOG PAGE

SKP 30

```

*** USER FILE CATALOG ***
Volume : HP4145 Rev. 1.0
available records = 2075
file name      comments      adrs      blk
NPN1  PRO      286      5
VCESAT PRO      291      5
ICBVE  PRO      296      5
IGSSTM PRO      301      5
HFE1  PRO      306      5
HFE2  PRO      311      5
BIP1  SEQ      316      4
VCIC  DAT      #512     23
VCESAT DAT      #512     23
HFE1  DAT      #514     23
    
```

SKP 31

a. Available records  
 b. File name  
 c. File type  
 d. File comments  
 e. File address  
 f. Number of records used  
 g. User-area files

**Functions of this Page:**

1. Display information pertaining to files stored on the disc.
2. PURGE (delete) files from the user-area.
3. Initialize the blank disc.
4. Copy the Operating System Software (Operating System Copy) to the initialized disc.
5. Transfer the all files from the 4145A's mass storage media or another 4145B's mass storage media to that on the 4145B.

The system disc furnished with the 4145B has a user-area in which up to 2178 records or 240 files can be stored. The initialized disc has a user-area in which up to 2432 records or 240 files can be stored. The number of records per file depends on the file type, as listed below.

Program files (measurement setups)	5rcd/file
Data files (measurement results with setups)	23rcd/file
ASP files (auto-sequence program files)	4rcd/file

Information for up to 11 files can be displayed on this page. To display information on other files, press the ROLL UP or ROLL DOWN softkey, or press the NEXT SCREEN or PREV SCREEN Softkeys. When the ROLL UP or ROLL DOWN softkey is pressed and held, movement through the displayed files is continuous. Each item — a through g — in Figure A is described below.

Figure 3-32. 4145B FILE CATALOG Page (Sheet 1 of 4)



## a. Available records :

Shows the number of available records.

## b. File name :

Lists the names of all files stored on the disc.  
And lists the file-type of each file stored on the disc.

Sys: System file

Pro: Program file (measurement setups), file type P

Dat: Data file (measurement results), file type D

Seq: ASP file (auto-sequence program), file type S

When storing or recalling a file, the file type — P, D, or S — must be specified in the SAVE, RE-SAVE or GET command. System files can be recalled only when the CHANNEL DEFINITION page is displayed and only with the softkeys.

## d. File comments :

Lists any comments that were specified in the SAVE or RE-SAVE command when the file was stored. When specifying a comment in the SAVE or RE-SAVE command, it must be entered after the file name, must be preceded by a space, and must not be more than eight characters long.

## e. File address :

Shows the address of the first record of each file. The first user-area address of the system disc is 286. Addresses below 286 are used for operating system software and system files.

## f. Number of records used :

Shows the number of records reserved for each file. Normally, the number of records reserved is equal to the number of records used, but there are cases when this is not true. For example, if a program file (5 records) is stored after a data file (23 records) has been purged, the new file will have 23 records but will use only 5. The 18 unused records are wasted. They cannot be used for storage of additional files.

**Softkeys :**

This page has two softkey prompts (shown in Figure A). The function of each softkey is described below.

**SKP 30**

**PURGE** :

This softkey is for deleting files from the disc. To purge a file, press the PURGE softkey, key in the file type and file name, and press EXECUTE. If the CLEAR key is pressed before EXECUTE, the PURGE operation is cancelled.

**CAT** :

If the disc is changed while the FILE CATALOG page is displayed, this softkey displays the FILE CATALOG of the new disc.

**NEXT  
SCREEN** :

This softkey rolls-up the file page.

**PREV  
SCREEN** :

This softkey rolls-down the file page.

**ROLL  
UP** :

This softkey rolls-up the file list. If this softkey is pressed and held, continuous roll-up is performed.

**ROLL  
DOWN** :

This softkey rolls-down the file list. If this softkey is pressed and held, continuous roll-down is performed.

**SKP 31**

**COPY  
DISC** :

This softkey is used for copying the user-area files and operating system onto the another system disc or initialized disc. The procedure is given in paragraph 3-148.

**COPY  
SYS** :

This softkey is used for copying the operating system onto the initialized disc. The procedure is given in paragraph 3-146.

**INIT  
DISC** :

This softkey is used for initializing the blank disc. The procedure is given in paragraph 3-144.

Figure 3-32. 4145B FILE CATALOG Page (Sheet 3 of 4)

**RCV  
DATA** :

This softkey is used for transferring all of the files from the 4145A's disc or 4145B's disc onto the 4145B's disc. When the files are transferred from 4145A, HP 16267A File Transfer Software Disc for the 4145A (not furnished) is needed. The procedures are given in paragraph 3-150.

**SEND  
DATA** :

This softkey is used for transferring all of the files from the 4145B's disc onto another 4145B's disc. The procedures are given in paragraph 3-150.

**PURGE  
ALL** :

This softkey is used for deleting all files from the disc. To purge all files, press the PURGE ALL softkey, and press the EXEC softkey. If the QUIT softkey is pressed before EXEC softkey, the PURGE ALL operation is cancelled.

# OPERATION GUIDE PAGE

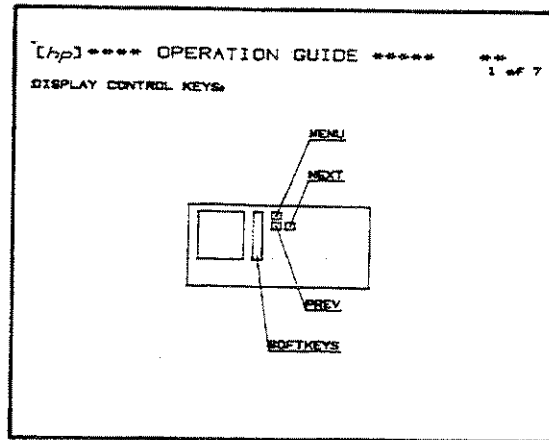

Figure A

Function of this page :

Provide basic operating instructions. Included are descriptions of the display control keys, display relationships, and a list of error messages and error codes. This page has seven screens. To view screens 2 through 7, use the NEXT or PREV key.

Construction :

Screen flow is as shown below. The MENU key can be pressed at any time.

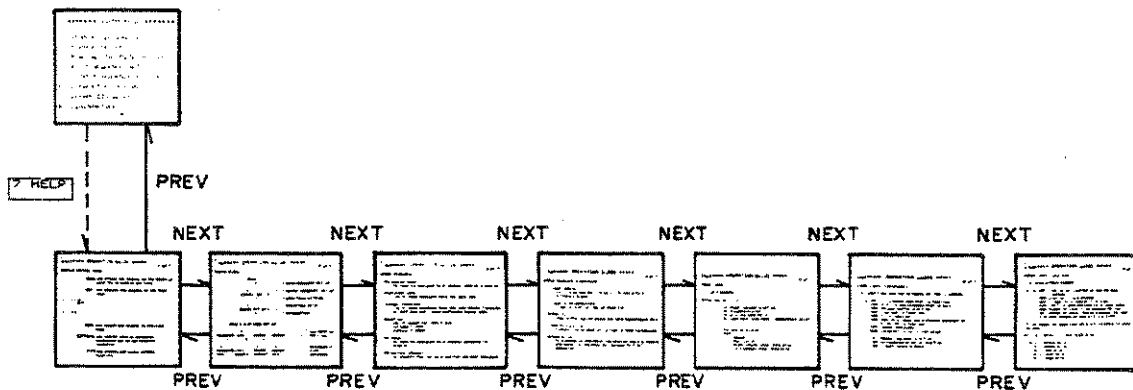

Figure B

Figure 3-33. OPERATION GUIDE Page

# DIAGNOSTICS PAGE

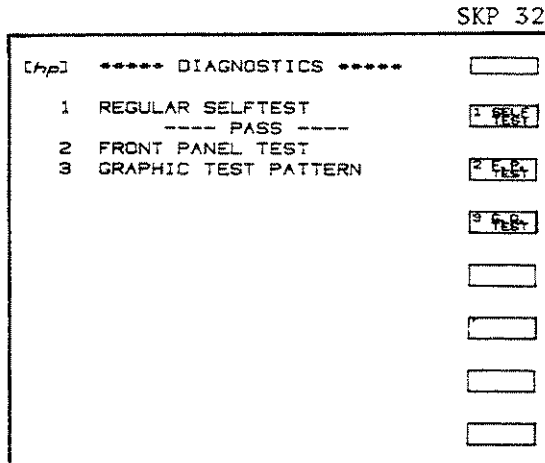

Figure A

Functions of this page :

1. Perform Self-Test.
2. Perform Front Panel Test.
3. Perform Graphic Display Test.

Softkey functions :

One Softkey Prompt (SKP32) is displayed on this page.

: Self Test

Two Self-Tests are performed when this softkey is pressed. They are as follows :

1. MPU Test : Checks the ROMs and RAMs. If an abnormality is detected, an error-code will be displayed in the center of CRT.
2. SMU Test : Checks SMUs 1 through 4 and their control circuit. If an abnormality is detected, CHAN ( !!! DOWN !!! ) or CHAN (10, 20, 31, 40) will be displayed. In the latter, SMU3 is down.

If the SELF TEST detects an abnormality, contact the nearest Hewlett-Packard Sales or Service Office.

Figure 3-34. DIAGNOSTICS Page (Sheet 1 of 3)

**2 F.P. TEST** : Front Panel Test

This softkey is used for testing the operation of the front panel controls. When this key is pressed, the display will change to that shown in Figure B and the front panel lamp test will begin. In the lamp test, all lamps on the front panel are momentarily turned on and then turned on one at that time. During the lamp test no keyboard operations can be performed. When the lamp test is completed, the rotary dial test and key test can be performed. To perform the rotary dial (MARKER) test, rotate the dial and observe the COUNT display on the CRT. Rotating the dial clockwise 360 degrees increases COUNT by 120; rotating the dial counterclockwise 360 degrees decreases COUNT by 120. COUNT can be reset to zero by pressing the CLEAR key. In the key test, NEXT KEY shows number of the key that should be pressed next; LAST KEY shows the number of the key that was just pressed. Key numbers are shown in Figure C. To perform this test, press key 1; LAST KEY should change to 1 and NEXT KEY, to 2. Continue in this manner until all the keys have been checked. When key 66 (EXECUTE) is pressed, NEXT KEY and LAST KEY will both be 66, and when key 66 is released, the display will change back to that shown in Figure A.

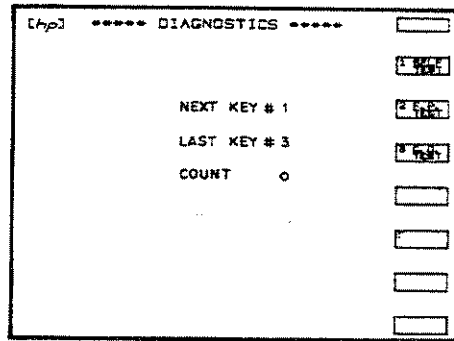

Figure B

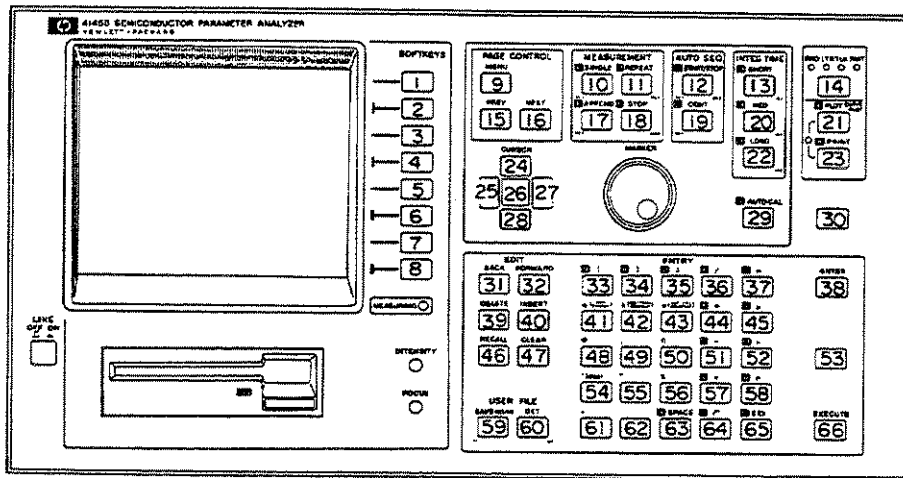



Figure C

Figure 3-34. DIAGNOSTICS Page (Sheet 2 of 3)

: Graphic Display Test

This softkey is used for INTENSITY and FOCUS adjustments. Adjustment procedure is given in Figure 3-6.

3-80. TIME DOMAIN MEASUREMENT SETUP

3-81. The 4145B can measure voltage or current as a function of time. This is called a time domain measurement and is made possible by replacing the main sweep, VAR1, with time. Measurement is made at constant, user-specified time intervals and results can be displayed on the GRAPHICS PLOT, LIST DISPLAY, MATRIX DISPLAY, or SCHMOO PLOT page, just as in a normal VAR1 sweep measurement. (If results are to be displayed on a SCHMOO PLOT, VAR2 must be used.) The page-by-page setup for a typical time domain measurement, along with measurement results, is shown in Figure 3-35.

**CHANNEL DEFINITION**

CHAN	NAME	SOURCE
SMU1	V1	CON
SMU2	V2	CONST
SMU3	V3	V
SMU4	V4	V

**SOURCE SET UP**

NAME	VAR1	VAR2
SWEEP MODE	LINEAR	
START		
STOP		
STEP		
NO. OF STEP		
COMPLIANCE		

CONSTANT	SOURCE	COMPLIANCE
V1	CON	100.000V
V2	V	1.0000A
V3	V	2.0000V
V4	V	1.0000V
V5	V	1.0000V
V6	V	1.0000V

**MEAS & DISP MODE SET UP**

MEASUREMENT MODE: TIME DOMAIN

WAIT TIME: 0.50

INTERVAL: 50

NO. OF RDNGS: 250

DISPLAY MODE: GRAPHICS

NAME	TIME	FUNCTION	YSCALE
SC1	LINEAR	LINEAR	
MIN	0.00	0.00 A	
MAX	250.00	1.0000A	

- ① Do not select VAR1 as the source function for any of the source channels. VAR2, however, can be selected, if desired. VAR1 can not be used.
- ② Because VAR1 is not assigned on the CHANNEL DEFINITION page, the VAR1 column on the SOURCE SETUP page is blank.
- ③ Enter the SOURCE and COMPLIANCE values for each CONSTANT source. If VAR2 is to be used, enter the sweep parameters.
- ④ WAIT TIME : Identical to the HOLD TIME of a VAR1 sweep measurement. Settable range is 0 to 100 seconds with 10 millisecond resolution.
- ⑤ INTERVAL : The time between measurements. Settable range is .01 to 10 seconds with 10 millisecond resolution.
- ⑥ NO. OF RDNGS : The number of measurements to be made. If VAR2 is used, this is the number of measurements to be made at each VAR2 step. Settable range is 1 to 1024. However, if VAR2 NO. OF STEP x NO. OF RDNGS 1140, "buffer full" will be displayed when measurement is made.

Figure 3-35. Time Domain Measurement Setup (Sheet 1 of 2)



Example Measurement

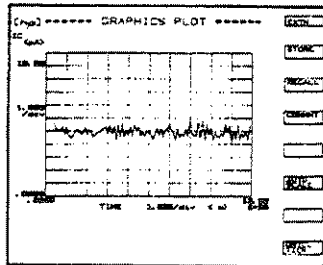

TIME	Icp
1.00e-06	8.850pA
2.00e-06	5.840pA
3.00e-06	4.900pA
4.00e-06	4.840pA
5.00e-06	4.540pA
6.00e-06	4.050pA
7.00e-06	3.550pA
8.00e-06	3.150pA
9.00e-06	2.690pA

Note

If INTERVAL is too short, error-code (e.g. Error D08) will be displayed. In this case, data is meaningless because the next measurement begins before the present measurement is completed. This meaningless data is not displayed.

Figure 3-35. Time Domain Measurement Setup (Sheet 2 of 2)

## 3-82 DUT CONNECTION

3-83. DUTs can be connected to the 4145B through the 16058A Test Fixture or through the furnished connector plate (P/N : 04145-60001). Connection using the 16058A is described in paragraph 3-84 and connection using the furnished connector plate, in paragraph 3-86.

## 3-84. DUT Connection Using the 16058A

3-85. The 16058A Test Fixture is designed to connect packaged devices, such as transistors, diodes and ICs, to the SMUs, voltage sources, and voltage monitors on the 4145B. Eight different, interchangeable DUT Socket Boards are furnished with the 16058A. Connection between the 4145B and 16058A is shown in Figure 3-36. Also shown are examples using four of the furnished DUT Socket Boards.

The procedure for connecting the 16058A is as follows:

1. Turn off the 4145B. If the 24-pin Shorting Connector (P/N: 04145-61623) is connected to the System Cable connector on the rear panel, remove it.
2. Connect the 16058A to the 4145B as shown below. Use the furnished System Cable (P/N: 16058-61604) and triaxial cables (P/N: 16058-61603). The System Cable contains the  $V_s$  lines,  $V_m$  lines, and the fixture-lid-open detection line.

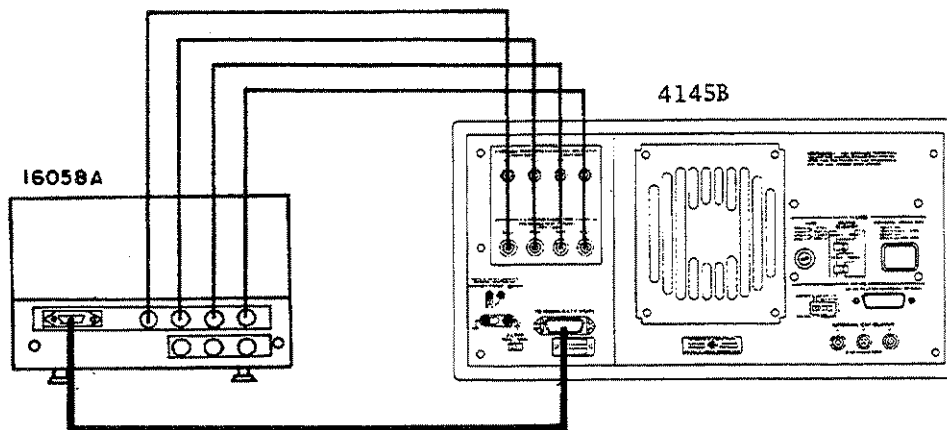

## CAUTION

THE SYSTEM CABLE CONNECTOR AND THE HP-IB CONNECTOR, BOTH OF WHICH ARE LOCATED ON THE 4145B'S REAR PANEL, ARE IDENTICAL. DO NOT CONNECT THE 16058A TO THE HP-IB CONNECTOR OR THE HP-IB CABLE TO THE 4145B'S SYSTEM CABLE CONNECTOR.

3. Select a DUT Socket Board suitable for the device to be measured, and insert it into the 16058A's Personality Board. To insert the board, pull out the two black fasteners, place the socket board on the Personality Board so that it covers the opening, and press the two black fasteners.

Figure 3-36. DUT Connection Using the 16058A (Sheet 1 of 4)

- To connect the SMU, Vs, and Vm terminals on the Personality Board to the terminals on the DUT Socket Board, use the furnished connection leads (P/N's : 16058-61600, 16058-61601, and 16058-61602). Examples are given below.

**Example 1 : Transistor Socket Board**

Connect SMUs 1 through 4 directly to terminals 1 through 4, respectively, as shown below.

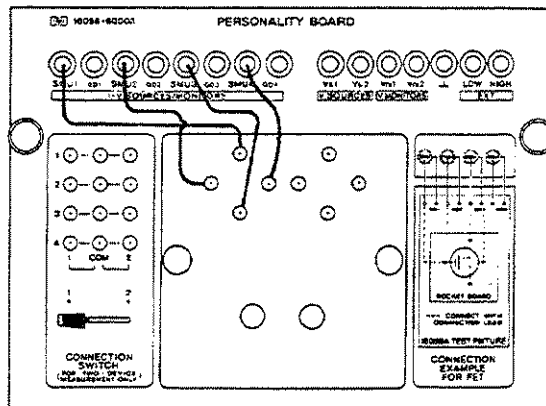

terminal 1 to SMU1  
 terminal 2 to SMU2  
 terminal 3 to SMU3  
 terminal 4 to SMU4

**Example 2 : 8-pin Socket Board**

Connect SMUs 1 through 4 directly to terminals 1, 3, 5, and 7, respectively, as shown below.

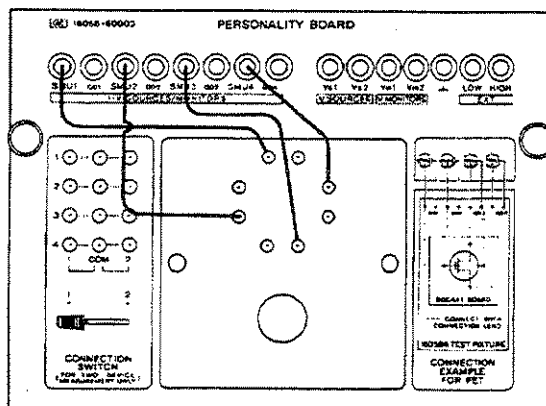

terminal 1 to SMU1  
 terminal 3 to SMU2  
 terminal 5 to SMU3  
 terminal 7 to SMU4

Figure 3-36. DUT Connection Using the 16058A (Sheet 2 of 4)

**Example 3: Using the CONNECTION SWITCH**

Connect the Socket Board terminals and SMUs 1 and 2 to the CONNECTION SWITCH, as shown below. When the switch is set to position 1, the SMUs are connected to the top two terminals (NARROW) of the Socket Board and when it sets to position 2, the SMUs are connected to the lower two terminals. When the switch is set to the center position, the Socket Board is not connected to the SMUs.

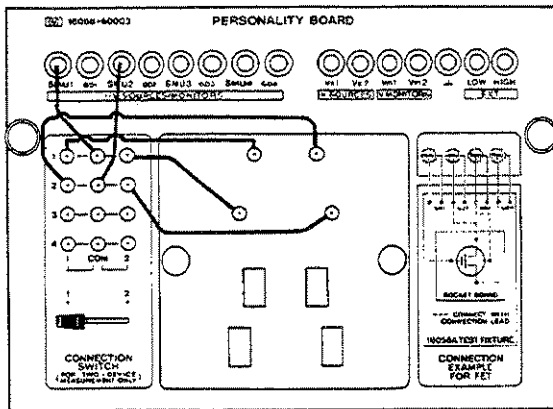

The Connection Switch is as shown below :

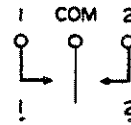

**Example 4: Blank Teflon Board**

This board is used when measuring high resistance components or components that can not be measured with the other Socket Boards. To connect the component, use the miniature-clip leads (P/N : 16058-61602).

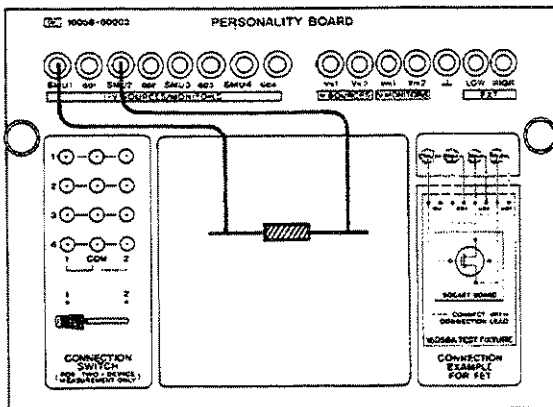

Figure 3-36. DUT Connection Using the 16058A (Sheet 3 of 4)

5. Turn on the 4145B and set up the measurement as required.
6. Close the test fixture lid and press SINGLE, REPEAT, or APPEND to start the measurement.

Note

If the output voltage from an SMU or Vs will exceed  $\pm 42V$  during the measurement, the test fixture lid must be closed to start the measurement. If an attempt is made to start the measurement while the test fixture lid is open, "Close the fixture lid" will be displayed on the CRT and measurement will not begin.

Note

If the test fixture lid is opened during a measurement in which the output voltage exceeds  $\pm 42V$ , measurement will stop immediately and all sources will be turned off (0V) as if the STOP key had been pressed.

7. The figure below shows the connections between the 4145B and the 16058A.

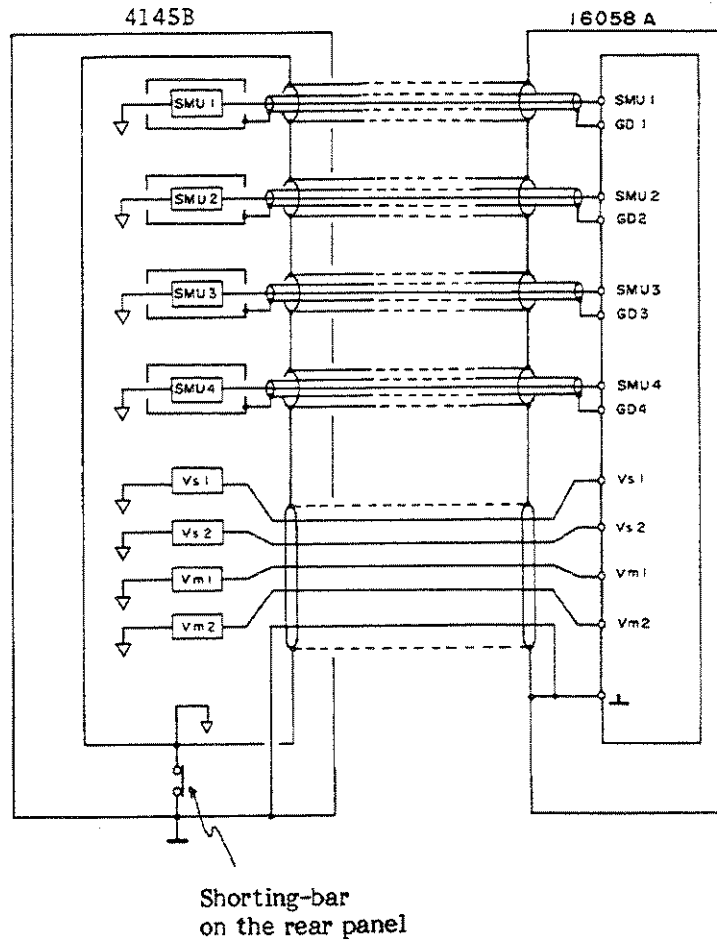

Figure 3-36. DUT Connection Using the 16058A (Sheet 4 of 4)

### 3-86. DUT Connection Using the Connector Plate

3-87. The furnished connector plate (P/N : 04145-60001) has four BNC connectors and four triaxial connectors. It is intended for use with user-fabricated or user-furnished test fixtures. For best measurement results, the test fixture should be enclosed in a shielding-box and the connector plate should be mounted on the box, as shown in Figure 3-37. This significantly reduces the effects of RFI and EMI, and is especially important when making low-current measurements on wafers at the probe station. The procedure for connecting the connector plate, shielding-box and 4145B is given in Figure 3-37.

#### Mounting the Connector Plate and Connecting the 4145B:

1. Drill the holes required to mount the connector plate onto the shielding-box. Hole spacing is given in Table 1-3.
2. Mount the connector plate on the shielding-box. Make sure there is good electrical contact between the plate and the box.
3. Turn off the 4145B.
4. Connect the furnished 24-pin Shorting Connector (P/N: 04145-61623) to the System Cable connector (labelled TO 16058A TEST FIXTURE) on the rear panel.

#### Note

If the Shorting Connector is connected, output from the SMUs is not limited to  $\pm 42V$ ; that is, the 4145B assumes a fixture-lid-closed condition.

5. Connect the 4145B to the connector plate with the four furnished 3-meter triaxial cables (P/N: 04145-61622) and the four furnished 3-meter BNC cables (P/N: 04145-61630), as shown below.

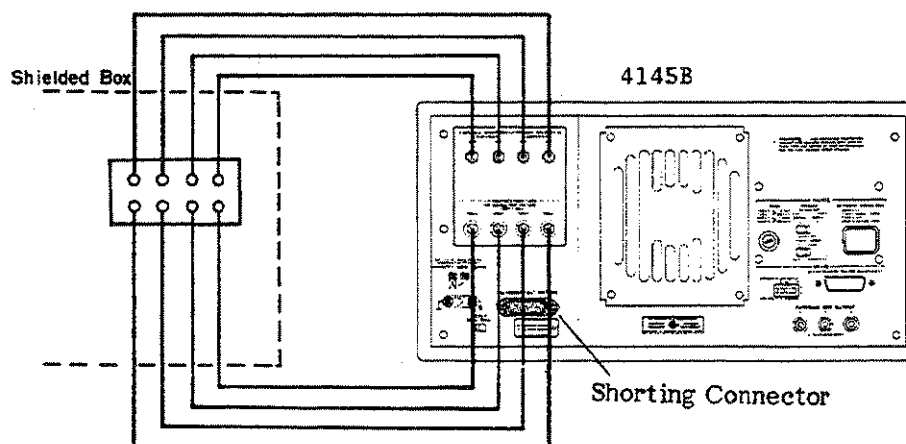
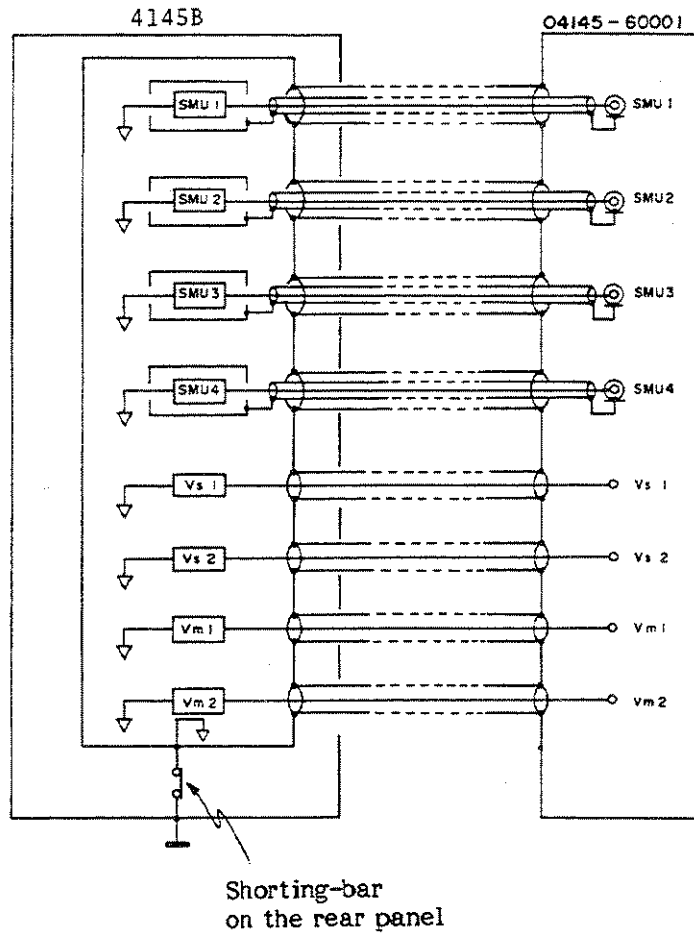

Figure 3-37. DUT Connection Using the Connector Plate (Sheet 1 of 2)

6. Turn on the 4145B and make the necessary measurement setup.
7. The figure below shows the connections between the 4145B and the connector plate.



**WARNING**

A POTENTIAL SHOCK HAZARD EXISTS WHEN THE SHORTING CONNECTOR IS CONNECTED TO THE 4145B. DO NOT TOUCH THE OUTPUT TERMINAL OR INNER CONDUCTOR OF SMU DURING MEASUREMENT.

Note

Do not connect the inner shield (guard) of an SMU to ground (⊥) or common (↕).

Figure 3-37. DUT Connection Using the Connector Plate (Sheet 2 of 2)

## 3-88. SMU OSCILLATION

3-89. The SMUs of the 4145B are high-speed amplifiers, and as such, may oscillate under certain load conditions. Devices that exhibit negative resistance characteristics, such as tunnel diodes and unijunction transistors, are especially troublesome in this regard, since they are almost certain to cause an SMU to oscillate. When measuring such devices, you must take certain precautions to prevent oscillation. Figure 3-38 shows two methods of preventing SMU oscillation when measuring negative resistance devices.

Oscillations are not limited to the SMUs; the test sample itself may also oscillate due to the residual inductances and stray capacitances of the connection cables and test fixture or probe card. Bipolar transistors that have high hFE and wide bandwidth are especially susceptible to oscillation. Test device oscillation cannot be detected by the SMU's internal detection circuits. So it's important to guard against test sample oscillation. For transistors, the best way to do this is by using ferrite beads as shown in Figure 3-39.

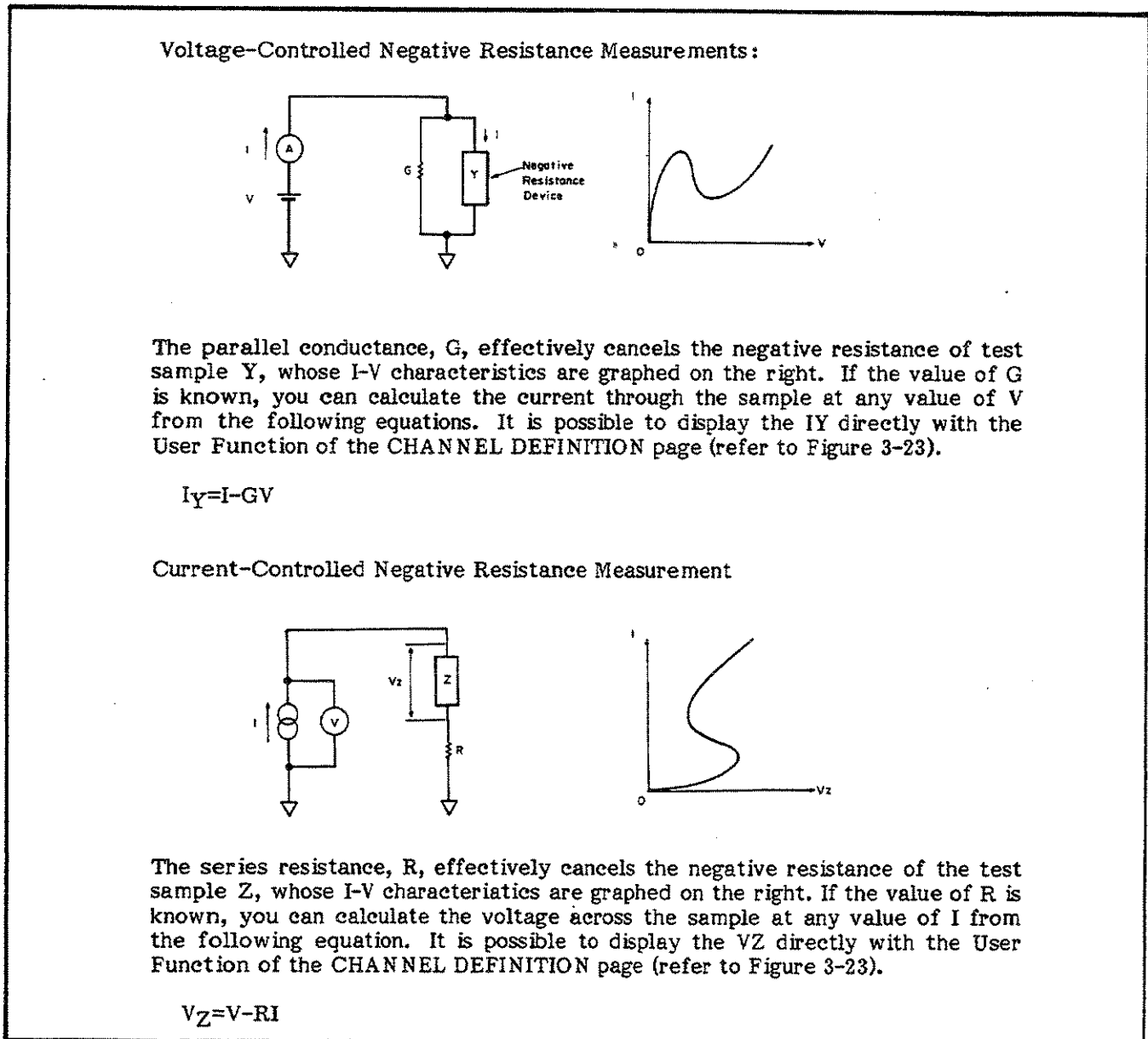
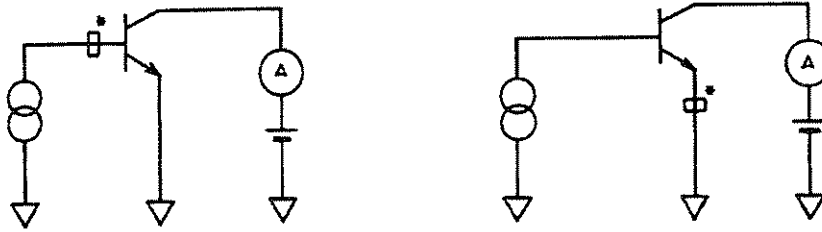

Figure 3-38. Negative Resistance Measurements





\*Ferrite Beads (available from Hewlett-Packard; order PN 9170-0029)

Position the ferrite beads as close as possible to the device under test. In some instances it may be necessary to use two ferrite beads to stop oscillation. Also, if the ferrite beads on adjacent leads come in contact with each other, or if a ferrite bead touches the device's case or another lead, leakage current will increase, reducing the accuracy of measurement results.

Figure 3-39. Preventing Transistor Oscillation

## 3-90. FLOATING MEASUREMENT

3-91. When the DUT is grounded or when the external voltage source or shield case for DUT is connected to ground, measurement can not be performed or measurement results may be affected by ground loops. The 4145B can be used for floating measurements by disconnecting the shorting-bar on the rear-panel. In this condition, the measurement and source circuit is floating above chassis ground, and voltages over  $\pm 42V$  may be present on the COM terminal.

## WARNING

A POTENTIAL SHOCK HAZARD MAY EXIST WHEN COMMON IS NOT CONNECTED TO GROUND (SHORTING-BAR DISCONNECTED). DO NOT, REGARDLESS OF THE OUTPUT VOLTAGE, TOUCH THE COMMON TERMINAL OR OUTER CONDUCTOR OF THE SMU,  $V_s$ , OR  $V_m$  CONNECTORS DURING A FLOATING MEASUREMENT (SHORTING-BAR DISCONNECTED).

## CAUTION

DO NOT FLOAT THE INSTRUMENT AT VOLTAGES EXCEEDING 42V.

## Note

When the 16058A Test Fixture is used, floating measurements can not be made, because source common is connected to chassis ground inside the test fixture.

## 3-92. GUARDING

3-93. When low-current measurements are made (SMU's set to I monitor), guarding can be used to reduce the effects of leakage current. Voltage at the guard terminal is held at the same potential as the SMU output voltage. Connect the guard terminal (GD1 through 4 terminals on the Personality Board) of the SMU used for I monitor to the outer shield of the DUT. Figure 3-40 shows an example of guarding.

## WARNING

GUARD POTENTIAL IS THE SAME AS SMU OUTPUT. DO NOT TOUCH THE GUARD TERMINAL DURING MEASUREMENT.

## Note

Do not connect the guard terminal to the common terminal.

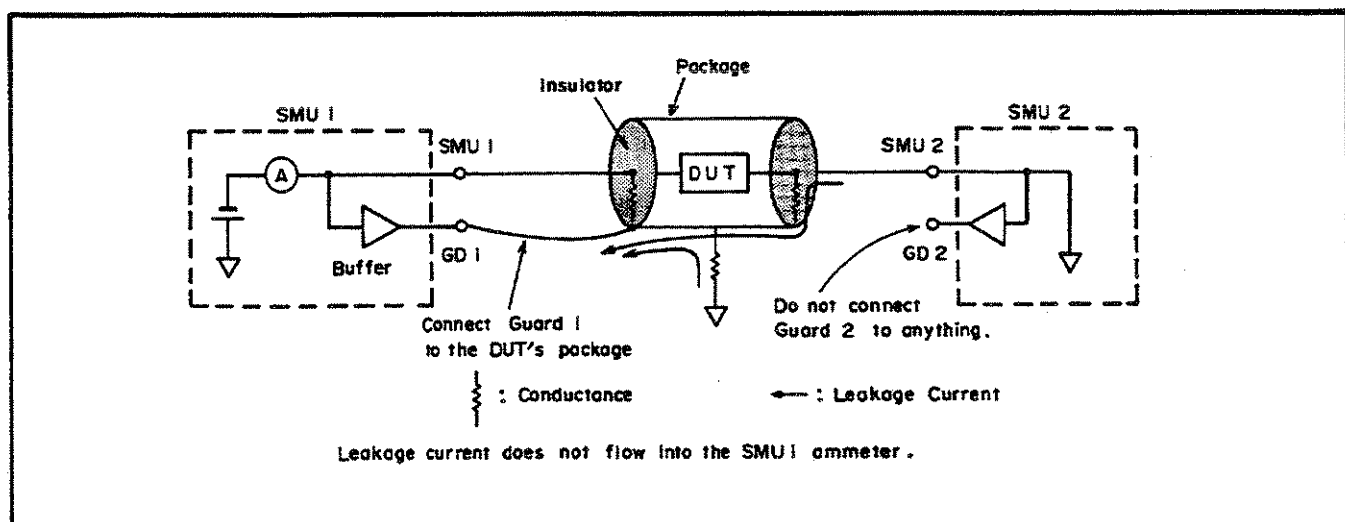

Figure 3-40. Example of Guarding

3-94. PLOT

3-95. The 4145B can directly dump an existing display onto an HP-IB plotter, without the aid of a controller. A list of recommended plotters is given in Table 3-8.

Note

Other plotters can be used, but they must have a LISTEN ONLY mode. Also, on some older type plotters, it may not be possible to precisely position alphabetic or numeric strings, such as labels, within a specified plot area.

Table 3-8. Recommended HP-IB Plotters

HP7090A*	Measurement Graphics System
HP7440A	Graphics Plotter
HP7470A	Graphics Plotter
HP7475A	Graphics Plotter
HP7550A**	Graphics Plotter

\* ; 7090A cannot plot  $\sqrt{\quad}$ ,  $\Delta$ ,  $\Omega$  and  $^{\circ}$ .  
 \*\* ; Set the 7550A to Standard mode.

Operating instructions for the PLOT function are given in Figure 3-41.

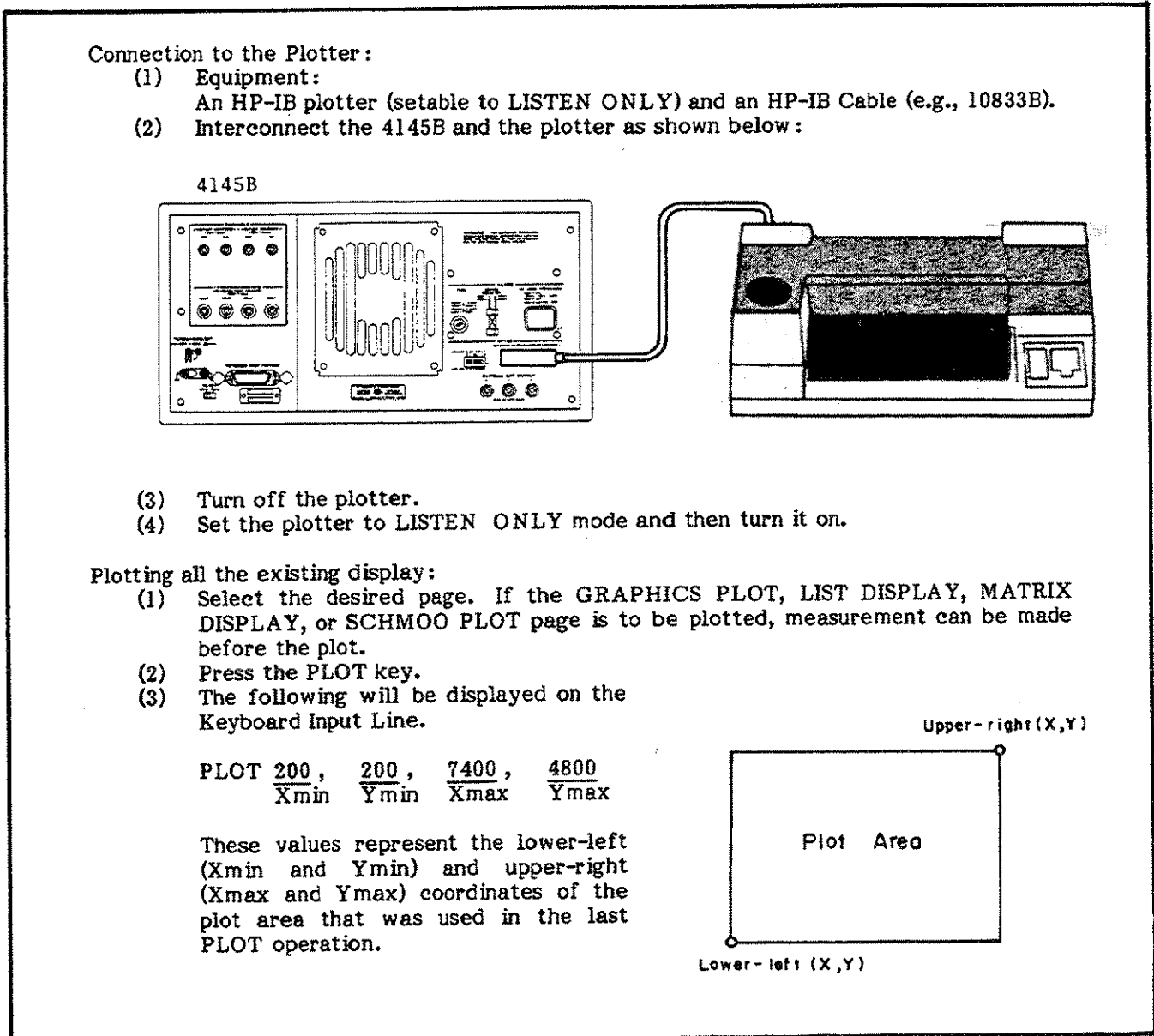

Figure 3-41. Plot Function (Sheet 1 of 3)

#### Note

The values displayed on the Keyboard Input Line when the PLOT key is pressed are in .025mm units. Note that the maximum value of the X coordinate and Y coordinate for the recommended plotters are different. Refer to the plotter's manual.

- (4) If necessary, change the displayed values with the EDIT Keys. ENTER key is not required.) The following limitations must be observed :
  - A. Xmin, Ymin, Xmax, and Ymax must not exceed 32767.
  - B. The specified plot area must be within the limits of the plotter.
  - C. Each value must be delimited by a comma (,) or space.
- (5) Press the EXECUTE Key to start plotting. "Plotting" will be displayed on the CRT's System Message Line. During plotting, the 4145B is in TALK ONLY mode, and the TLK lamp (HP-IB status indicators) will be lit. In this condition, only the PLOT or PRINT Key is available. Also, the Xmin, Ymin, Xmax, and Ymax values in effect when the EXECUTE key is pressed are stored on the disc, except when the disc is write-protected.
- (6) When the plot is completed, the instrument automatically returns to normal operation mode.

#### Note

To stop the PLOT, press the PLOT key or PRINT key. If the CLEAR key is pressed before the EXECUTE key is pressed, the PLOT operation will be cancelled. Plotting can not be temporarily stopped.

#### PLOT Contents:

- (1) Following are not plotted.
  - A. Softkey Prompts
  - B. Data on the Keyboard Input Area
  - C. Data on the System Message Line
- (2) Following are plotted when the CRT is displaying the GRAPHICS PLOT, LIST DISPLAY, MATRIX DISPLAY, or SCHMOO PLOT page.
  - A. Setup conditions for VAR1, VAR2, and CONSTANT Sources.
  - B. User Function expressions

Plotting the only measurement curve on the GRAPHICS PLOT page:

- (1) Select the GRAPHICS PLOT page. The measurement should be made before the curve plot.
- (2) Press the GREEN key, then press the PLOT key.
- (3) The following will be displayed on the Keyboard Input Line.

Later procedures are same as Plotting the all existing display procedures from (4) to (6).

Figure 3-41. Plot Function (Sheet 2 of 3)

**Pen Selection:**

When a multi-color plotter is used, pen selection is as follows:

Pen #	Used for:
1	Grid Lines
2	Recalled and Curve Plot Traces
3	Existing Traces
4	Plot Area Frame, Marker, Cursors, Lines

**Note**

Refer to paragraph 3-140 for instructions covering HP-IB controlled plot operation.

Figure 3-41. Plot Function (Sheet 3 of 3)

## 3-96. PRINT

3-97. The 4145B can directly print out measurement data on an HP-IB printer, without the aid of a controller.

Note

The printer must have a LISTEN ONLY (ALWAYS) mode.

Operating instructions for the PRINT function are given in Figure 3-42.

Connection to the Printer:

Refer to steps (1) through (4) of "Connection to the Plotter" in Figure 3-41.

Printing:

- (1) Press the PRINT key. "PRINT" will be displayed on the Keyboard Input Line.
- (2) Press the EXECUTE key to start printing. "Printing" will be displayed on the CRT's System Message Line. During printing, the 4145B is in TALK ONLY mode, and TLK lamp (HP-IB status indicators) will be lit. In this condition, only the PLOT or PRINT key is available.
- (3) All measurement data stored in the Data Buffer is printed out.

Note

If no data is in the data buffer, nothing will be printed.

- (4) When printing is completed, the instrument automatically returns to normal operation mode.

Note

To stop the PRINT, press the PRINT key or PLOT key. If the CLEAR key is pressed before the EXECUTE key is pressed, the PRINT operation is cancelled. Printing can not be temporarily stopped.

Print Contents:

1. Setup conditions for VAR1, VAR2 and CONSTANT Sources.
2. Measurement data

Note

User functions are not printed out.

Note

Refer to paragraph 3-140 for instructions covering HP-IB controlled print operations.

Figure 3-42. Print Function

3-98. APPLICATIONS PACKAGE

3-99. Each disc furnished with the 4145B contains the following four setups for frequently made measurements:

1. GENL
2. B-Tr VCE-IC
3. FET VDS-ID
4. DIODE VF-IF

When the 4145B is turned on, GENL is automatically loaded. The other furnished measurement setups can be loaded by pressing the appropriate softkey on the CHANNEL DEFINITION page. These furnished setups can not be loaded with the GET command, nor can they be purged from the disc. The contents (channels used, sweep parameters, etc.) of each furnished measurement setup are listed in Table 3-9. Connection examples for each setup are given in Figure 3-43.

Table 3-9. Application Package Setups (Sheet 1 of 2)

	GENL	B-Tr VCE-IC	FET VDS-ID	DIODE VF-IF
SMU1 (V NAME / I NAME) MODE / FCTN	V1 / I1 COM / CONST	VE / IE COM / CONST	VS / IS COM / CONST	VF / IF V / VAR1
SMU2 (V NAME / I NAME) MODE / FCTN	V2 / I2 I / VAR2	VB / IB I / VAR2	VDS / ID V / VAR1	—
SMU3 (V NAME / I NAME) MODE / FCTN	V3 / I3 V / VAR1	VCE / IC V / VAR1	VG / IG V / VAR2	V / I COM / CONST
SMU4 (V NAME / I NAME) MODE / FCTN	V4 / I4 V / CONST	—	—	—
Vs 1 (NAME / FCTN) Vs 2 (NAME / FCTN)	VS1 / CONST VS2 / CONST	—	—	—
Vm 1 NAME / Vm 2 NAME	VM1 / VM2	—	—	—
USER FUNCTION	—	HFE = IC / IB	—	—

Table 3-9. Application Package Setups (Sheet 2 of 2)

VAR1	SWEEP MODE	LINEAR	LINEAR	LINEAR	LINEAR
	START	.000V	.000V	-2.5000V	-.5000V
	STOP	1.000V	1.000V	2.5000V	2.0000V
	STEP	.010V	.010V	.0500V	.0100V
	COMPLIANCE	100.0mA	100.0mA	20.00mA	40.0mA
VAR2	START	20.00 $\mu$ A	10.00 $\mu$ A	.0000V	---
	STEP	20.00 $\mu$ A	10.00 $\mu$ A	-1.0000V	---
	NO OF STEP	5	5	5	---
	COMPLIANCE	2.0000V	2.0000V	1.000mA	---
CONST	NAME	V1	VE	VS	V
	SOURCE/COMPLI	0V/105mA	0V/105mA	0V/105mA	0V/105mA
	NAME	V4	---	---	---
	SOURCE/COMPLI	0V/100mA	---	---	---
CONST	NAME	VS1	---	---	---
	SOURCE/COMPLI	0V/---	---	---	---
CONST	NAME	VS2	---	---	---
	SOURCE/COMPLI	0V/---	---	---	---
DISPLAY MODE		GRAPHICS			
X axis	NAME	V3	VCE	VDS	VF
	SCALE	LINEAR	LINEAR	LINEAR	LINEAR
	MIN	.0000V	.0000V	-2.5000V	-.5000V
	MAX	1.0000V	1.0000V	2.5000V	2.0000V
Y axis	NAME	I3	IC	IG	IF
	SCALE	LINEAR	LINEAR	LINEAR	LINEAR
	MIN	.000A	.000A	.000A	-10.00mA
	MAX	10.00mA	10.00mA	1.000A	40.00mA



A. GENL:

General setup assigning all V names and I names.

B. B-Tr VCE-IC:

Setup for measurement of NPN bipolar transistors. When the transistor is connected to the 16058A test fixture, as shown below,  $V_{CE-IC}$  (collector/emitter voltage — collector current) characteristics common emitter Bipolar Transistor can be measured. Also, HFE (=  $I_C/I_B$ ) is assigned as the User Function.

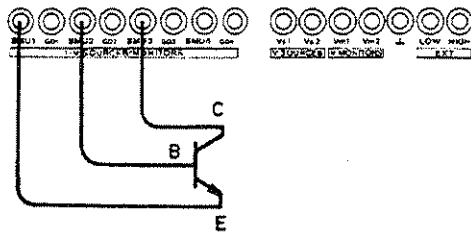

C. FET VDS-ID:

Setup for measurement of N-channel junction FETs (Field-Effect Transistor). When the FET is connected to the 16058A test fixture, as shown below,  $V_{DS-I_D}$  (drain/source voltage — drain current) characteristics of a common drain FET can be measured.

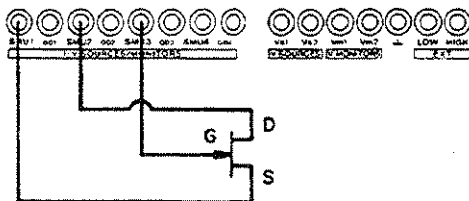

D. DIODE VF-IF:

Setup for measurement of general PN junction diodes. When the diode is connected as shown below,  $V_F-I_F$  (forward bias voltage — forward current) characteristics can be measured.

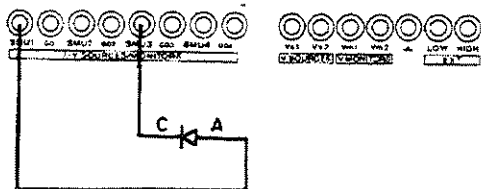

Figure 3-43. Connection Examples for Application Package

3-100. MEASUREMENT EXAMPLE

3-101. In the following example the characteristics of an NPN transistor connected for common emitter operation are measured and graphically displayed. Base-emitter voltage is swept and the resultant base and collector currents are measured.

3-102. Turn off the 4145B. Set up the 16058A's Personality Board as shown in Figure 3-44, and insert a transistor into the DUT socket. Insert the furnished System Disc into the 4145B, then turn the 4145B on.

3-103. When the 4145B is turned on, it will first read a portion of the operating system software stored on the disc and will then perform a brief self-test, after which it will display the MENU page shown in Figure 3-45. For this measurement example, the CHANNEL DEFINITION page, SOURCE SET UP page, and MEAS & DISP MODE SET UP page are used. Press the **CHAN DEF** softkey or the **NEXT** key.

3-104. On the CHANNEL DEFINITION page the channels (SMUs, voltage source, and voltage monitor) to be used in the measurement are selected, assign source and monitor names, and specify source modes and functions. To use the Application Package (refer to paragraph 3-98.), move the field-pointer (▶) to the NAME V field of SMU1 and then press the **MODE-IC** softkey. This automatically changes the measurement setup to one that is more appropriate for measurement of bipolar transistors. A few simple changes remain to be made, however. To make these changes, first make sure that the field-pointer is in the NAME V field of SMU1, then perform the following key sequence:

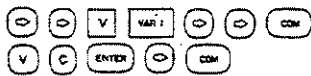

The CHANNEL DEFINITION page should now look as that shown in Figure 3-46. Press the **NEXT** key.

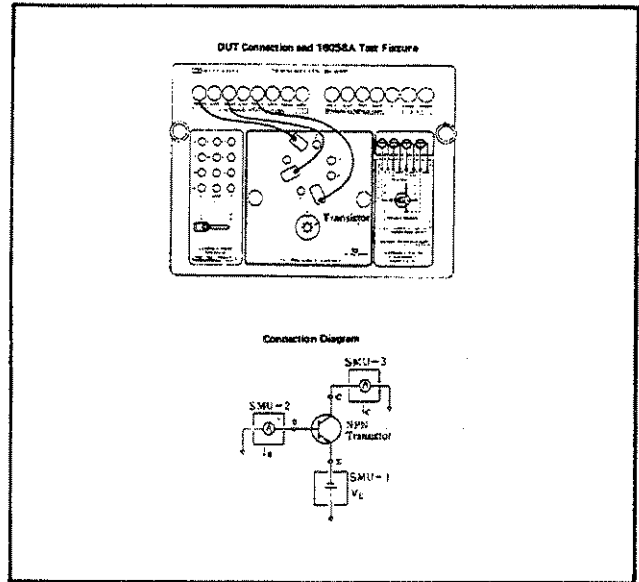

Figure 3-44. Setup the 16058A's Personality Board of Measurement Example

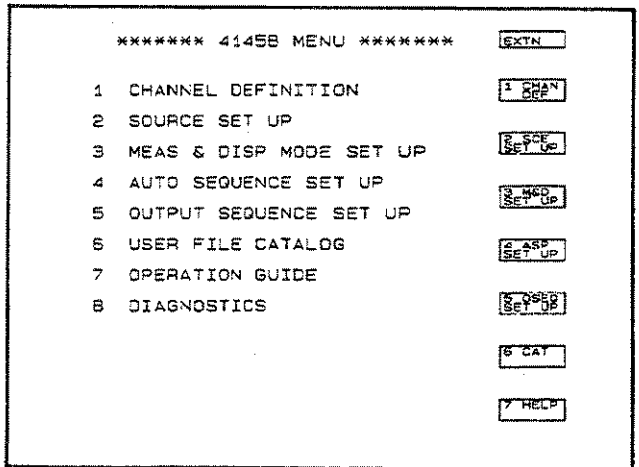

Figure 3-45. MENU Page of Measurement Example

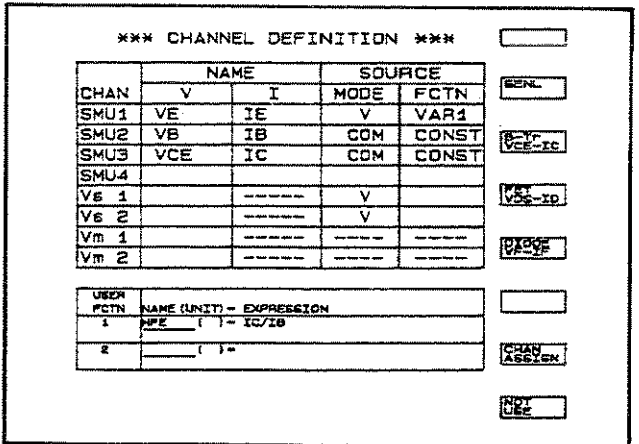

Figure 3-46. Channel Definition Example

3-105. On this SOURCE SETUP page the output parameters for each SMU selected on the CHANNEL DEFINITION page are set. VE is entered in the VAR1 NAME field because it is the V name of a voltage source (V MODE) whose function is VAR1. Similarly, VB and VC are listed under CONSTANT. For this measurement, this page must be set up as shown in Figure 3-47. To do this, move the field-pointer to the VAR1 SWEEP MODE field and then perform the following key sequence:

LINEAR 0 ENTER - 0 9 ENTER -  
 0 - 0 1 ENTER 1 0 0 m ENTER

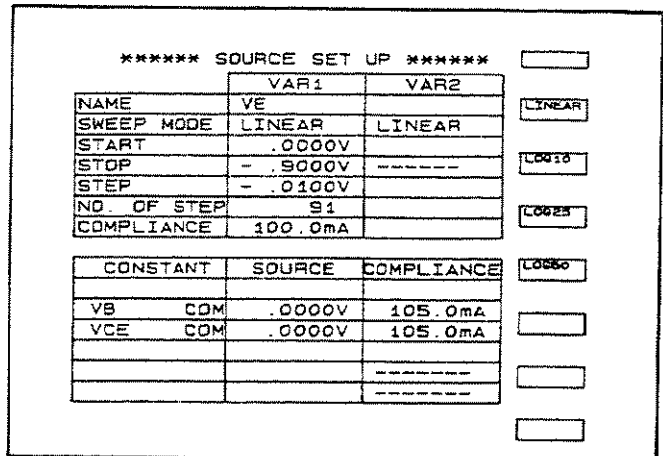

Figure 3-47. Source Setup Example

When measurement is made, the base-emitter voltage, VE, will be linearly swept from 0V to -0.9V in -10mV steps. Press the **NEXT** key.

3-106. On this MEAS & DISP MODE SET UP page the mode for displaying the measurement results are selected. Four mode are available GRAPHICS, LIST, MATRIX, and SHMOO. For this measurement, the GRAPHICS display mode is used. To set up this page as shown in Figure 3-48, perform the following key sequence:

GRAPHICS VE LINEAR 0 ENTER - 1 ENTER  
 IC LOG 1 0 ENTER 1 0 0 m  
 ENTER  
 IB LOG 1 0 ENTER 1 0 0 m  
 ENTER

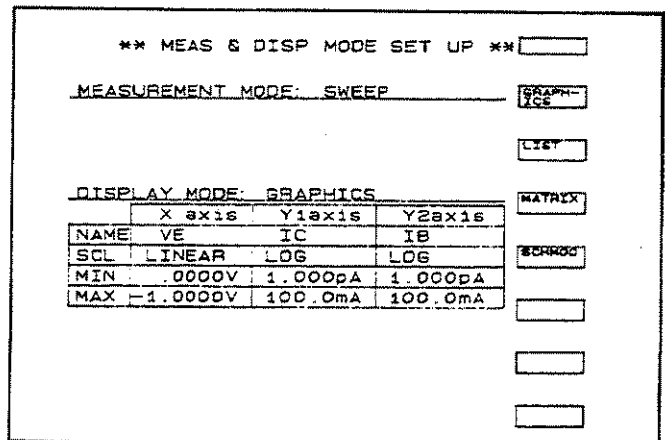

Figure 3-48. Meas & Disp Mode Setup Example

Press the **NEXT** key.

3-107. All measurement conditions have been set and the 4145B is now ready to make the measurement. Close the test fixture lid (shields the DUT from RFI AND EMI sources) and press the **SINGLE** key. The 4145B will begin sweeping the base-emitter voltage, VE, from 0V to -0.9V in -10mV steps. The resultant collector current, IC, and base current, IB, will be measured at each VE step and plotted on the CRT as shown in Figure 3-49. The curve with the more acute slope is collector current, and the other curve is base current.

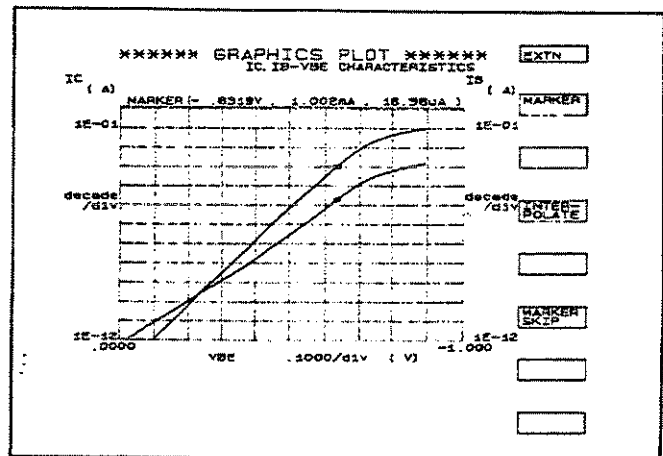

Figure 3-49. Measurement and Display Example

3-108. Measurement results at each measurement step can be digitally displayed by pressing the **MARKER** softkey. When the MARKER dial is rotated, the marker will move along the plotted curve and the X, Y1 and Y2 coordinates will be displayed above the plot area. The marker can be used to simplify keyboard calculations. For example, to calculate  $h_{FE}$  at the marker position in Figure 3-49, key in **( ) C / ( ) B EXECUTE**. It is not necessary to input the numeric values.

3-109. Pressing the **LINE ON** softkey displays a solid straight line (LINE 1) or a dashed straight line (LINE 2) between two short cursors, as shown in Figure 3-50. Both lines can be displayed at the same time but only one can be moved. The gradient (GRAD), inverse gradient (1/GRAD), X-axis intercept, and Y-axis intercept of each line are displayed below the plot area. Of the two cursors displayed with each line, one will be highlighted and can be moved (line also moves) by the CURSOR keys (**←**, **↑**, **→**, **↓** and **FAST**). To move the other cursor, press the **CHANGE POINT** softkey. The line gradient can be input directly from the keyboard by first pressing the **GRAD VALUE** softkey. For example, to display a line whose gradient is e, perform the following key sequence:

**LINE ON GRAD VALUE CLEAR Bw E X P Bw ( ) 2 ( ) EXECUTE ENTER**

Another helpful function is the **CURSOR - 0** softkey. When pressed (marker must be on), the cursor will automatically move to the marker position.

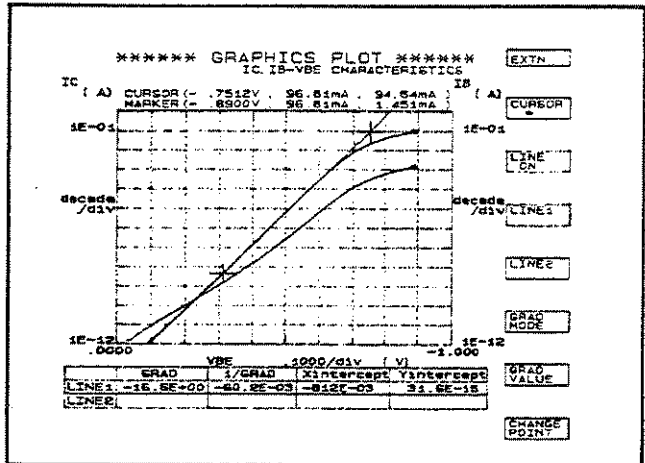

Figure 3-50. Using Example of the Line and Cursor Functions

3-110. HP-IB INTERFACE

3-111. The 4145B can be remotely controlled via the HP-IB, a carefully defined instrument interface which simplifies integration of instruments and a calculator or computer into a system.

Note

HP-IB is Hewlett-Packard's implementation of IEEE Std. 488, Standard Digital Interface for Programmable Instrumentation.

3-112. CONNECTION TO HP-IB

3-113. The 4145B can be connected into an HP-IB bus configuration with or without a controller (i.e., with or without an HP calculator). In an HP-IB system without a controller, the instrument functions as a "talk only" device (refer to paragraph 3-94 and 3-96)

3-114. HP-IB STATUS INDICATORS

3-115. The HP-IB Status Indicators are four LED lamps located on the front panel. When lit, these lamps show the existing status of the 4145B in the HP-IB system as follows:

SRQ : SRQ signal from the 4145B to the controller is on the HP-IB line. Refer to paragraph 3-136.

LISTEN : The 4145B is set to listen.

TALK : The 4145B is set to talk.

REMOTE : The 4145B is under remote control.

3-116. LOCAL KEY

3-117. The LOCAL key releases the 4145B from HP-IB remote control and allows measurement conditions to be set from the front-panel. The REMOTE lamp will go off when this key is pressed. LOCAL control is not available when the 4145B is set to "local lockout" status by the controller.

Note

The 4145B is set to "local lockout" when the 4145B is in GLI mode.

3-118. HP-IB CONTROL SWITCH

3-119. The HP-IB Control Switch, located on the rear panel, has seven bit switches as shown in Figure 3-51. Each bit has two settings: logical 0 (down position) and logical 1 (up position). The switch has three functions as follows:

- (1) Bit switches 1 through 5 (Address Bits) are used to set the HP-IB address (in binary) of the 4145B. Any address between 0 (00000) and 30 (11110) can be set.
- (2) Bit switch 6 (Data Form Bit) determines the output data delimiter. When the bit switch is set to 0, the delimiter is a comma ( , ); when set to 1, the delimiter is a carriage return and line feed (CR/LF).
- (3) Bit switch 7 (EOI; End or Identify) determines whether or not the 4145B sends the EOI signal when data transfer ends.

The HP-IB Control Switch settings are displayed when the 4145B is turned on. Refer to Figure 3-22.

Note

The HP-IB Control Switch, as set at the factory, is shown in Figure 3-51.

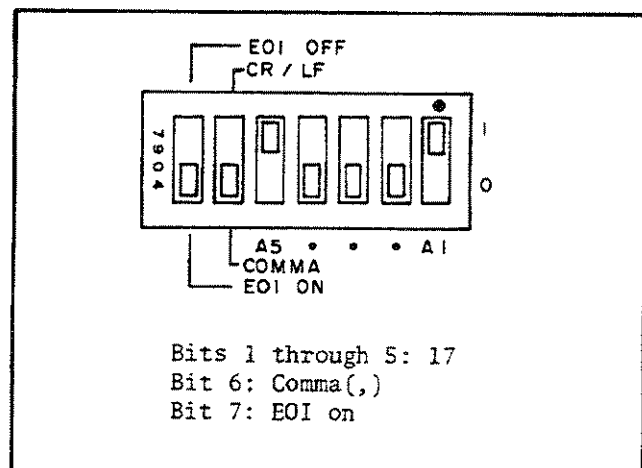

Figure 3-51. HP-IB Control Switch

3-120. HP-IB INTERFACE CAPABILITIES

3-121. The 4145B has eight HP-IB interface functions. Refer to Table 3-10.

Table 3-10 HP-IB Interface Capabilities

Code	Interface Function* (HP-IB Capabilities)
SH1**	Source Handshake
AH1	Acceptor Handshake
T5	Talker (basic talker, serial poll, talk only mode, unaddress to talk if addressed to listen)
L4	Listener (basic listener, unaddress to listen if addressed to talk)
SR1	Service Request
RL1	Remote/local (with local lockout)
DC1	Device Clear
DT1	Device Trigger
E1	End Message Sending
<p>* Interface functions provide the means for a device to receive, process, and transmit messages over the bus.</p> <p>** The suffix number of the interface code indicates the limitation of the function capability as defined in Appendix C of IEEE Std. 488.</p>	

(2) User Mode:

Direct control of the CRT and each SMU, Vs, and Vm via the HP-IB. The instrument is set to this mode when program code "US" is sent. Output from each SMU or Vs can be set, and measurement can be made by triggering the desired SMU or Vm. The CRT is blank in this mode, but can be used as a programmable graphics display by sending program code "GL2". To exit from this User Mode (return to System Mode), send a device CLEAR command or a paging command (DE, SS, SM, or MD).

3-122. HP-IB CONTROL MODES

3-123. When controlled via the HP-IB, the 4145B has two modes:

(1) System Mode:

Setup and measurement is made by a controller via the HP-IB. This is much like manual setup and measurement operation.

### 3-124. Remote Program Codes and Parameter Setting

3-125. Figure 3-52 shows the remote available program codes and parameter settings. Program codes are divided into three categories: (1) System Mode program codes, (2) User Mode program codes, and (3) program codes common to both modes. User functions, OUTPUT SEQUENCE, PURGE and DISC COPY can not be programmed.

#### Programming notes:

1. Numeric values can be entered in fixed decimal format or floating decimal format. (max. 12 char and max. 2 digits exponent.)

Example: Fixed decimal: 25.32  
 Floating decimal: 2.532E+01

2. Voltage (V), current (A), and time (s) units are not required when entering numeric values.
3. Terminator (; or CR or LF) is required at the end of each parameter setting on a program line. In the examples given below, (TERM) represents the terminator.
4. Channel names must be enclosed in apostrophes ( ' ').

#### SYSTEM MODE PROGRAM CODES

Following program codes are used when the 4145B is set to System Mode.

Direct Paging (to change page):

DE: CHANNEL DEFINITION Page  
 SS: SOURCE SETUP Page  
 SM: MEAS & DISP MODE SETUP Page  
 MD: Display Page (page selected for DISPLAY MODE)  
 US: User Mode

#### Notes

1. When the 4145B receives a Direct Paging command, it checks the setup on the displayed page before proceeding to the specified page. If an illegal setup is detected, an error message will be displayed, the SRQ bit will be turned on, and the page will not be changed.
2. Display returns to the MENU page when the 4145B receives a Device Clear command.

Figure 3-52. Remote Program Codes and Parameter Setting (Sheet 1 of 9)

## CHANNEL DEFINITION Page (program code "DE")

## Setup for SMUs 1 through 4

$$\text{CH } \underline{N^*} \text{ , } \frac{\text{'XXXXXX' }}{\underline{(2)}} \text{ , } \frac{\text{'XXXXXX' }}{\underline{(3)}} \text{ , } \frac{N}{\underline{(4)}} \text{ , } \frac{N(\text{TERM})}{\underline{(5)}}$$

- (1) SMU channel number (1 - 4)
- (2) V NAME (up to 6 characters)
- (3) I NAME (up to 6 characters)
- (4) SOURCE MODE (1 - 3)
  - 1: V
  - 2: I
  - 3: COM\*\*
- (5) SOURCE FUNCTION (1 - 4)
  - 1: VAR1
  - 2: VAR2
  - 3: CONST
  - 4: VARI'

\* If nothing is specified after the channel number, the channel is turned off (NOT USE).

\*\* When SOURCE MODE is set to 3 (COM), SOURCE FUNCTION must be set to 3 (CONST).

## Setup for Vs1 and Vs2

$$\text{VS } \underline{N^*} \text{ , } \frac{\text{'XXXXXX' }}{\underline{(2)}} \text{ , } \frac{N(\text{TERM})}{\underline{(3)}}$$

- (1) Vs channel number (1 or 2)
- (2) V NAME (up to 6 characters)
- (3) SOURCE FUNCTION (1 - 4)
  - 1: VAR1
  - 2: VAR2
  - 3: CONST
  - 4: VARI'

\* If nothing is specified after the channel number, the channel is turned off (NOT USE).

## Setup for Vm1 and Vm2

$$\text{VM } \underline{N^*} \text{ , } \frac{\text{'XXXXXX' }}{\underline{(2)}} \text{ (TERM)}$$

- (1) Vm channel number (1 or 2)
- (2) V NAME (up to 6 characters)

\* If nothing is specified after the channel number, the channel is turned off (NOT USE).

Figure 3-52. Remote Program Codes and Parameter Setting (Sheet 2 of 9)



## SOURCE SETUP Page (program code "SS")

## Setup for VAR1

$$\frac{XX}{(1)} \frac{N}{(2)}, \frac{\pm NN.NNN}{(3)}, \frac{\pm N.NNNN}{(4)}, \frac{N.NNNN}{(5)}, \frac{N.NNN(TERM)}{(6)}$$

- (1) SOURCE MODE of VAR1 (VR or IR)  
 VR: Voltage Source  
 IR: Current Source
- (2) SWEEP MODE (1 - 4)  
 1: LINEAR  
 2: LOG 10  
 3: LOG 25  
 4: LOG 50
- (3) START value  
 (4) STOP value  
 (5) STEP value\*  
 (6) COMPLIANCE value

\* If SWEEP MODE (2) is set to 2, 3, or 4, omit STEP (5).

## Setup for VAR2

$$\frac{XX}{(1)} \frac{\pm N.NNNN}{(2)}, \frac{\pm N.NNNN}{(5)}, \frac{NN}{(4)}, \frac{N.NNN(TERM)}{(5)}$$

- (1) SOURCE MODE or the VAR2 (VP or IP)  
 VP: Voltage Source  
 IP: Current Source
- (2) START value  
 (3) STEP value  
 (4) Number of steps  
 (5) COMPLIANCE value

## Setup for CONSTANT SMUs

$$\frac{XX}{(1)} \frac{N}{(2)}, \frac{\pm N.NNNN}{(3)}, \frac{N.NNNN(TERM)}{(4)}$$

- (1) SOURCE MODE of the channel (VC or IC)  
 VC: Voltage Source  
 IC: Current Source
- (2) SMU channel number (1 - 4)  
 (3) Output value  
 (4) COMPLIANCE value

## Setup for CONSTANT Vs

$$SC \frac{N}{(1)}, \frac{\pm N.NNNN(TERM)}{(2)}$$

- (1) Vs channel number (1 or 2)  
 (2) Output value

Figure 3-52. Remote Program Codes and Parameter Setting (Sheet 3 of 9)

HOLD TIME Setting

HT  $\frac{N.NN}{(1)}$ (TERM)

- (1) HOLD TIME

DELAY TIME Setting

DT  $\frac{N.NN}{(1)}$ (TERM)

- (1) DELAY TIME

VARI' RATIO/OFFSET Setting

XX  $\frac{\pm N.NN}{(1) (2)}$ (TERM)

- (1) RATIO/OFFSET (RT or FS)  
RT: RATIO  
FS: OFFSET
- (2) Value

MEAS & DISP MODE SETUP Page (program code "SM")

Time Domain Measurement Setup (only when VARI is not selected on the CHANNEL DEFINITION page)

WAIT TIME Setting

WT  $\frac{N.NNN}{(1)}$ (TERM)

- (1) WAIT TIME

INTERVAL Setting

IN  $\frac{N.NN}{(1)}$ (TERM)

- (1) INTERVAL Time

NO. OF RDNGS Setting

NR  $\frac{NNN}{(1)}$ (TERM)

- (1) No. of Readings

DISPLAY MODE Selection

- DM1: GRAPHICS
- DM2: LIST
- DM3: MATRIX
- DM4: SCHMOO

Figure 3-52. Remote Program Codes and Parameter Setting (Sheet 4 of 9)

Setup for GRAPHICS mode ("DM1")

$\frac{XX}{(1)} \frac{'XXXXXX'}{(2)}, \frac{N}{(3)}, \frac{\pm N.NNN}{(4)}, \frac{\pm N.NNN}{(5)} (TERM)$

(1) AXES

XN: X axis

YA: Y1 axis

YB: Y2 axis\*

XT: X axis for time domain measurement\*\*

(2) Monitor channel NAME for the specified axis (must be one of the monitor channel names specified on the CHANNEL DEFINITION page).

(3) SCALE 1: LINEAR 2: LOG

(4) MIN value

(5) MAX value

\* Y2 axis is optional.

\*\* Systax is:  $XT \frac{\pm N.NNN}{(4)}, \frac{\pm N.NNN}{(5)} (TERM)$

Setup for LIST mode ("DM2")

$LI \frac{'XXXXXX'}{(1)}, \frac{'XXXXXX'}{(2)}, \frac{'XXXXXX'}{(3)}, \frac{'XXXXXX'}{(4)}, \frac{'XXXXXX'}{(5)}, \frac{'XXXXXX'}{(6)} (TERM)$

(1)~(6) Monitor channel NAMES. At least one NAME must be specified (must be the monitor channel names specified on the CHANNEL DEFINITION page).

Setup for MATRIX mode ("DM3")

$MX \frac{'XXXXXX'}{(1)} (TERM)$

(1) Monitor channel NAME (must be one of the monitor channel names specified on the CHANNEL DEFINITION page).

Setup for SCHMOO mode ("DM4")

$SH \frac{'XXXXXX'}{(1)}, \frac{\pm NN.NN}{(2)}, \frac{\pm NN.NNN}{(3)}, \frac{\pm N.NNNN}{(4)}, \frac{\pm N.NNNN}{(5)} (TERM)$

(1) Monitor channel NAME (must be one of the monitor channel names specified on the CHANNEL DEFINITION page).

(2) Minimum value for "M"

(3) Minimum value for "Δ"

(4) Minimum value for "+"

(5) Minimum value for ":"

\* If no minimum value is specified for (2), (3), (4), or (5), the corresponding symbol will not be used in the SCHMOO PLOT. A comma ( , ) must be entered, however.

MEASUREMENT Codes (program code "MD")

ME1: SINGLE\*

ME2: REPEAT

ME3: APPEND

ME4: STOP

\* The GET (Group Execute Trigger) command can be used in place of the ME1 program code. An example of the GET command is the TRIGGER command on the 85A or 9845A.

Following program codes are valid on any page.

**AUTO SEQ codes**

AS1: START  
AS2: CONTINUE  
AS3: STOP

**SAVE Function**

SV 'X        XXXX XXXXXX' (TERM)  
      (1) (2) (3) (4) (5)

- (1) File type  
    P: Program file  
    D: Program/Data file  
    S: ASP file
- (2) Space
- (3) File name (up to 6 characters)
- (4) Space
- (5) Comment (up to 8 characters)

\* (4) and (5) are optional.

**GET Function**

GT 'X        XXXX' (TERM)  
      (1) (2) (3)

- (1) File type
- (2) Space
- (3) File name

**Assignment of Data Output Channel**

DO 'XXXXX'  
      (1)

- (1) Monitor channel NAME (must be one of the monitor channel names specified on the MEAS & DISP MODE SETUP page).

**PRINT Function**

PR: PRINT function ON\*  
PF: PRINT function OFF

\* After PF is sent, send the following statement to set the ATN line to Inactive.

"SEND 7;UNT UNL TALK 17 LISTEN 1 DATA"

Address of the 4145B; 17  
Address of the printer; 1

**Graphics Language (GL1) Mode (only on the GRAPHICS PLOT Page)**

GL1: Graphics Display mode ON  
GL0: Graphics Display mode OFF

Figure 3-52. Remote Program Codes and Parameter Setting (Sheet 6 of 9)

USER MODE PROGRAM CODES

Following program codes are used when the 4145B is set to User Mode.

## User Mode

US: User mode ON\*

\* To release the 4145B from this mode, send a page command ("DE", "SS", "SM", or "MD") or a device clear command.

## Output command for SMUs

$$\frac{XX}{(1)} \frac{N^*}{(2)}, \frac{N}{(3)}, \frac{\pm N.NNN}{(4)}, \frac{N.NNN(TERM)}{(5)}$$

- (1) SOURCE MODE (DV or DI)
  - DV: Voltage Source
  - DI: Current Source
- (2) SMU channel number (1 - 4)
- (3) Output Range
  - For voltage source (0 - 3)
    - 0: AUTO
    - 1: 20V
    - 2: 40V
    - 3: 100V
  - For current source (0 - 9)
    - 0: AUTO
    - 1: 1nA
    - 2: 10nA
    - 3: 100nA
    - 4: 1μA
    - 5: 10μA
    - 6: 100μA
    - 7: 1mA
    - 8: 10mA
    - 9: 100mA
- (4) Output value
- (5) COMPLIANCE value

\* If nothing is specified after the channel number, the channel is turned off (NOT USE).

Figure 3-52. Remote Program Codes and Parameter Setting (Sheet 7 of 9)

## Output command for Vs

$$DS \frac{N}{(1)}, \frac{\pm N.NNNN(TERM)}{(2)}$$

- (1) Vs channel number (1 or 2)
- (2) Output value

## Triggering (Measurement)

$$\frac{XX}{(1)} \frac{N}{(2)}$$

- (1) Measurement mode of the channel to be triggered
  - TV: Voltage Monitor
  - TI: Current Monitor
- (2) Channel number
  - 1: SMU1
  - 2: SMU2
  - 3: SMU3
  - 4: SMU4
  - 5: Vm1
  - 6: Vm2

## Graphics Language (GL2) Mode

GL2: Graphic Display mode ON  
 GL0: Graphic Display mode OFF

## Note

In User Mode, measurement cannot be performed with the fixture lid open because of the protective function. To perform the measurement without closing the fixture lid, use the Shorting Connector as shown in Figure 3-37.

Figure 3-52. Remote Program Codes and Parameter Setting (Sheet 8 of 9)

COMMON PROGRAM CODES

Following program codes are available in the System Mode or in the User Mode.

## INTEGRATION TIME

IT1: SHORT  
IT2: MEDIUM  
IT3: LONG

## SELF TEST: SF

## Data Ready Service Request

If "DR1" is sent (Data Ready Service Request ON), bit 1 (Data Ready) and bit 7 (RQS) of the 4145B's STATUS BYTE are set to 1 when measurement data is valid.

DR0: OFF  
DR1: ON

## HP-IB Data Buffer Clear

To clear the HP-IB data output buffer and bit 1 (Data Ready) of the Status Byte. Buffer Clear must be performed before data output from the 4145B.

## BC

## Auto Calibration

CA0: OFF  
CA1: ON\*

\* Auto calibration in the User Mode is performed only once when "CA1" is sent. Also, if the mode is changed, Auto Calibration is set to OFF.

## PLOT function

PL  $\frac{NNN}{(1)}$ ,  $\frac{NNN}{(2)}$ ,  $\frac{NNNN}{(3)}$ ,  $\frac{NNNN}{(4)}$ (TERM)

- (1) Xmin
- (2) Ymin
- (3) Xmax
- (4) Ymax

PF: PLOT function OFF (Refer to paragraph 3-140 for instruction covering HP-IB controlled plot operations.)

## Note

After PF ..... is sent, send the following statement to set the ATN line to Inactive.

"SEND 7; UNT UNL TALK 17 LISTEN 5 DATA"

Address of the 4145B; 17  
Address of the plotter; 5

ID: Identification output (Refer to paragraph 3-134.)

Figure 3-52. Remote Program Codes and Parameter Setting (Sheet 9 of 9)

## 3-126. HP-GL CONTROL OF THE CRT

3-127. The 4145B's CRT can be controlled via the HP-IB by using HP-GL (Hewlett-Packard Graphics Language) commands. There are two HP-GL modes: GL1, which can be used only when the 4145B is operating in System Mode; and GL2, which can be used only in User Mode. Each HP-GL mode is described below.

## 1. GL1 Mode (Overlay Write):

This mode is set by sending program code "GL1." It is available only in the System Mode and only on the GRAPHICS PLOT page. In GL1 mode, additional information, such as labels, comments, lines, and curves, can be displayed on graphs plotted by the 4145B. Also, in GL1 mode the 4145B is set to "local lockout."

## 2. GL2 Mode (Blank):

This mode is set by sending program code "GL2." It is available only in the User Mode (programming code "US"). In GL2 mode, the CRT is completely independent from the 4145B's CRT control circuit and can be operated as a stand-alone graphics display.

If the display RAM contains too much display data, the 1345A may not be able to complete the display process within one refresh cycle. The display will be incomplete. To exit from the GL1 mode or GL2 mode, send program code "GL0."

To exit from the GL1 mode or GL2 mode, send program code "GL0."

## 3-128. HP-GL COMMANDS

3-129. HP-GL commands that can be used when the 4145B is set to User Mode (refer to paragraph 3-122) are listed in Table 3-11.

For more detailed information on HP-GL, refer to the operation manual of any HP-IB compatible plotter.



Table 3-11. HP-GL Commands (Sheet 1 of 3)

Code	Name	Meaning	Coding Example *1
<b>VECTOR Group</b>			
PU	Pen Up	Turns off the beam.	PU
PD	Pen Down	Turns on the beam.	PD
PA	Plot Absolute	Moves the beam to the point specified by the X- and Y-coordinates.	PA X -coordinate, Y -coordinate, ... X -coordinate, Y -coordinate
PR	Plot Relative	Moves the beam the specified units.	PR X -increment, Y -increment, ... X -increment, Y -increment
<b>CHARACTER Group</b>			
CS	Designates Standard Character Set	Selects the character set. *2	CS Character Set#
LB	Label	Writes characters using the assigned character set.	LB(Character) [ETX] *3
DR	Relative Direction	Selects the writing direction. *4 ( $-128 \leq \frac{\text{Run}}{\text{Rise}} \leq 127$ )	DR run, rise
SR	Relative Character Size	Selects the character size. *5	SR width, height.
CP	Character Plot	Moves the beam the specified of characters. ( $-128 \leq \text{number} \leq 127$ )	CP horizontal, vertical
<b>LINE TYPE Group</b>			
LT	Line Type	Selects the line type.	LT pattern number *6
SP	Pen Select	Selects the beam intensity.	SP intensity number *7
VS	Velocity Select	Selects the beam writing speed.	VS velocity *8, beam intensity number.
<b>AXES Group *9</b>			
XT	X Tick	Writes an X-axis tick mark at the present beam position	XT
YT	Y Tick	Writes a Y-axis tick mark at the present beam position.	YT
<b>SETUP Group *10</b>			
IP	Input P1 and P2	Sets up the scaling points, P1 and P2.	IP P1x, P1y, P2x, P2y
OP	Output P1 and P2	Outputs the scaling points.	OP
IW	Input Window	Limits the plot area.	IW X <sub>LL</sub> , Y <sub>LL</sub> , X <sub>UR</sub> , Y <sub>UR</sub>
<b>CONFIGURATION and STATUS Group</b>			
DF	Default	Returns the CRT setup to the default condition. *11	DF
IN	Initialize	Returns to the default condition and clears the display.	IN
IM	Input Mask	Selects mask value of the error number *12 which can cause an SRQ.	IM mask value
OE	Output Error	Outputs the error number *12 that caused an SRQ.	OE
OS	Output Status	Outputs the CRT's status byte. *13	OS

Table 3-11. HP-GL Commands (Sheet 2 of 3)

Code	Name	Meaning	Coding Example *1
ORIGINAL INSTRUCTION Group *14			
MA	Memory Address	Sets the memory pointer to the specified address.	MA address number
MJ	Memory Jump	Sets the "Memory Jump" command to the address.	MJ jump address
MC	Memory Count	Outputs the memory count to which the memory pointer points.	MC
MK	Memory Clear	Clears the user memory and resets the memory pointer.	MK
PG	Page	= MK(Memory Clear)	PG
AF	Advance Full Page	= MK(Memory Clear)	AF
*1	Terminator (; or LF) is required at the end of each command.		
*2	Only one Character set is available on the 4145B.		
*3	Indicated Label Terminator (use ASCII CODE ETX). Example for LB command sent by HP85 (displays 4145B) OUTPUT 717; "LB 4145B" & CHR \$ (3)		
*4	All run and rise values are converted into 0°, 90°, 180° or 270° as follows:		
		-45° ≤ direction ≤ 45° → 0°	
		45° < direction < 135° → 90°	
		135° ≤ direction ≤ 225° → 180°	
		225° < direction < 315° → 270°	
*5	Four character sizes (x1.0, x1.5, x2.0, and x2.5) are selectable according to larger value of width or height as follows:		
	0 ≤ larger value < 3 → x1.0 size		
	3 ≤ larger value < 4 → x1.5 size		
	4 ≤ larger value < 5 → x2.0 size		
	5 ≤ larger value ≤ 127 → x2.5 size		
*6	Four line types are selectable as follows:		
	0: Line with dot at the last point		
	1 or 2: Short dashed line		
	3 ~ 6: Long dashed line		
	7: Solid line		
*7	Four beam intensities are selectable as follows:		
	0: Blank		
	1: Dim		
	2: Half brightness		
	3: Full brightness		
*8	Four beam speeds are selectable as follows:		
	5: 0.05 inch/μsec		
	10: 0.10 inch/μsec		
	15: 0.15 inch/μsec		
	20: 0.20 inch/μsec		
*9	Tick length is fixed at 0.8% of  P2x - P1x  or  P2y - P1y .		

Table 3-11. HP-GL Commands (Sheet 3 of 3)

- \*10 IP, OP, and IW are fixed at P1 = (0,0), P2 = (2047, 2047). Also, the limits of the GRAPHICS PLOT page is LL = (220, 493), UR = (1570, 1725)
- \*11 Default condition is as follows:
- |    |                         |   |                 |
|----|-------------------------|---|-----------------|
| DR | Relative Direction      | : | 0°              |
| SR | Relative Character Size | : | X1 size         |
| LT | Line Type               | : | Solid line      |
| SP | Pen Select              | : | Full brightness |
| VS | Velocity Select         | : | 0.20 inch/μsec  |
| IM | Input Mask              | : | 225             |
- \*12 Error number that occurs first is output. Error meanings are as follows:
- 1: Instruction is not recognized (mask value=1)
  - 2: Wrong number of parameter (mask value=2)
  - 3: Bad parameter (mask value=4)
  - 4: Illegal character (mask value=8)
  - 7: All of the display memory has been used (mask value=64)
- \*13 Status values output from the CRT status byte have the following meanings (more than one may exist):
- 1: Beam is ON
  - 8: Initialized
  - 32: Error
- \*14 ORIGINAL INSTRUCTION Group controls the vector memory using the memory pointer. The vector memory outputs (to the CRT) the display data at the address designated by the memory pointer. The memory pointer scans the vector memory. Using "MA", "MJ", "MC", and "MK", the display can be controlled.

## 3-130. DEVICE CLEAR

3-131. The 4145B's control settings return to the initial control settings described in paragraph 3-13 when it receives a Selected Device Clear or Group Device Clear.

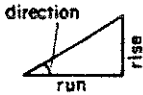
## 3-132. DATA OUTPUT

3-133. The 4145B outputs measurement and status data to external devices via the HP-IB. The data output format depends on whether the 4145B is set to System Mode or User Mode. In System Mode, all measurement and status data stored in the data buffer are output when the 4145B receives program code "DO". In user mode, measurement and status data for the triggered channel are output when the 4145B receives program code "DO". The output formats are shown in Figure 3-53.

## 3-134. IDENTIFICATION OUTPUT

3-135. The 4145B outputs the identification to external devices via the HP-IB. The identification is output when the 4145B receives program code "ID". The output formats are shown in Figure 3-54.

## 1. Data Output Format for the System Mode

When the remote program code "DO" is sent, the 4145B outputs data in following format\*<sup>1</sup>.

$$\frac{X}{(1)} \pm \frac{NN.NNN}{(2)} \frac{E \pm NN}{(3)}, \frac{X \pm NN.NNNE \pm NN}{(4)}, \dots \frac{X \pm NN.NNNE \pm NN}{(5)} \frac{(CR)}{(5)} \frac{(LF)}{(5)}$$

- (1) Data Status\*<sup>2</sup>
- (2) Measurement Data
- (3) Exponent\*<sup>3</sup>
- (4) Comma (data delimiter)\*<sup>4</sup>
- (5) Data Terminator

## 2. Data Output Format for the User Mode

When the remote program code "TI 'CH#" or "TV 'CH#" is sent, the SMU makes a measurement and the 4145B outputs data in the following format.

$$\frac{X}{(1)} \frac{X}{(2)} \frac{X \pm NN.NNN}{(3)} \frac{E \pm NN}{(4)} \frac{(CR)}{(5)} \frac{(LF)}{(6)}$$

- (1) Data Status\*<sup>2</sup>
- (2) Monitor Channel
  - A: SMU1
  - B: SMU2
  - C: SMU3
  - D: SMU4
  - E: Vm1
  - F: Vm2
- (3) Measurement mode (V or I)
- (4) Measurement data
- (5) Exponent\*<sup>3</sup>
- (6) Data Terminator

Figure 3-53. Data Output Format (Sheet 1 of 2)

- \*1 The order of data output is the same as the displayed order.
- \*2 Data Status indicates the condition of the monitor channel and is output in code, as listed below.
  - N: Normal
  - L: INTERVAL is too short.
  - V: A-D converter saturation
  - X: Oscillation
  - C: This channel compliance error
  - T: Other channel compliance error

Priority is as follows:  
L>V>X>C>T>N
- \*3 Scientific notation is used.
 

10 <sup>0</sup>	.....	E+00
10 <sup>-3</sup> (m)	.....	E-03
10 <sup>-6</sup> (μ)	.....	E-06
10 <sup>-9</sup> (n)	.....	E-09
10 <sup>-12</sup> (p)	.....	E-12
- \*4 The delimiter, bit switch 6 on the HP-IB Control Switch (Figure 3-50), is set at the factory to comma (.). This causes the 4145B in the System Mode to output all data as a continuous string. When the data delimiter is set to CR/LF, a carriage return and line feed signal is output after each field. This is useful when outputting data to certain peripherals, such as a strip-printer.

Figure 3-53. Data Output Format (Sheet 2 of 2)

**Identification Output Format**  
 When the remote program code "ID" is sent, the 4145B outputs data in following format.

ID 4145B  $\frac{X.X}{(1)}$ ,  $\frac{X.X}{(2)}$

- (1) The revision number of the ROM
- (2) The revision number of the Operating System

Figure 3-54. Identification Output Format

## 3-136. SERVICE REQUEST STATUS BYTE

3-137. The 4145B outputs an RQS (Request Service) signal whenever bit 1, 2, 3, 4, 6, or 8 of the Service Request Status Byte is set. The make-up of the Status Byte is shown in Figure 3-55.

Bit 8	Bit 7	Bit 6	Bit 5	Bit 4	Bit 3	Bit 2	Bit 1
Emergency	RQS	Self-Test Fail	Busy	Illegal Program	END Status	Syntax Error	Data Ready

Bit 7 (RQS) indicates whether or not a service request exists. Following are the service request states of the 4145B.

- Bit 1: **Data Ready**  
This bit is set when complete measurement data is ready for output onto the HP-IB. It is reset when data transfer starts or when the 4145B receives program code "BC" (Buffer Clear).
- Bit 2: **Syntax Error**  
This bit is set when the 4145B receives an erroneous remote program code. If this bit is set while bit 8 is set, it has another meaning. Refer to the description for bit 8.
- Bit 3: **End Status**  
This bit is set when Self-Test, PLOT, or PRINT is completed.
- Bit 4: **Illegal Program**  
This bit is set when the 4145B receives an invalid program. If this bit is set while bit 8 is set, it has another meaning. Refer to the description for bit 8.
- Bit 5: **Busy**  
This bit is set when measurement or auto calibration is being performed. It is automatically reset when measurement or calibration ends. This bit does not set the RQS bit.
- Bit 6: **Self-Test Fail**  
This bit is set when Self-Test fails. It is reset when Self-Test is performed again and the result is pass. If this bit is set while bit 8 is set, it has another meaning. Refer to the description for bit 8.

Figure 3-55. Status Byte for the 4145B (Sheet 1 of 2)

- Bit 7: RQS (Request Service)  
This bit is set whenever bit 2, 3, 4, 6, or 8 is set. Also set when bit 1 is set if program code "DRI" (Data Ready ON) has been sent.
- Bit 8: Emergency  
This bit is set when a potentially dangerous condition exists. The meaning of this bit depends on whether bit 2, bit 4 or bit 6 is set. Each is described below.
- Bit 2: Fixture lid open  
This bit and bit 8 are set when the fixture lid is opened during or at the start of a measurement in which the output voltage will exceed  $\pm 42V$ . In user mode, regardless the output voltage, this bit is set if the fixture lid is open or shorting connector is not connected.
- Bit 4: SMU shut down  
This bit and bit 8 are set when SMU output is shut down by the instrument to prevent damage to SMU.
- Bit 6: Power Failure  
This bit and bit 8 are set when the SMU output was reset by a momentary power loss.

Note

All bits except bit 5 are reset by a Serial Poll, and all bits except bit 1 and 5 are reset by a Device Clear.

Figure 3-55. Status Byte for the 4145B (Sheet 2 of 2)

3-138. Programming Guide for 4145B

3-139. Sample programs for the HP series 200/300 Desktop Computer are provided in Figures 3-56, 3-57 and 3-58 respectively.

Note

1. Specific information for HP-IB programming with the HP series 200/300 is provided in the HP series 200/300 programming manual.
2. Equipment required for these sample programs includes :  
  
HP series 200/300 Computer with Basic 2.0 , 3.0 or 4.0 system.
3. Before executing sample program 2, close the fixture lid or connect the Shorting Connector.



## Sample Program 1

### Description:

This program is an example of remote control, data output for a Bi-polar Transistor measurement made in the System Mode. The program has three capabilities:

- (1) Control of the 4145B via the HP-IB
- (2) Measurement via the HP-IB
- (3) Data output from the 4145B via the HP-IB

Set the HP-IB control switch as follows:

Address: 17  
Delimiter: comma

### HP series 200/300 Program:

```

10 DIM A$(1100)
20 OUTPUT 717; "IT1 CA1 DR0 BC"
30 OUTPUT 717; "DE CH1,'VE','IE',3,3; CH2,'VB','IB',2,2; CH3,'VC','IC',1,1;CH4"
40 OUTPUT 717; "VS1; VS2; VM1; VM2"
50 OUTPUT 717; "SS VR1,0,1,.05,50E-3;IP 10E-6,10E-6,4,3"
60 OUTPUT 717; "SM DM1 XN 'VC',1,0,1;YA 'IC',1,0,10E-3"
70 OUTPUT 717; "MD ME1"
80 A=SPOLL(717)
90 IF BIT(A,0)=0 THEN 80
100 OUTPUT 717; "DO 'IC'"
110 ENTER 717; A$
120 DISP A$
130 END

```

This program performs the following:

Line	Description
10	Define a string variable, A\$, to store measurement data.
20	Set measurement integration time (IT1), auto calibration (CA1), data ready (DR0), and data buffer clear (BC).
30/40	Setup the CHANNEL DEFINITION Page (DE).
50	Setup the SOURCE SETUP Page (SS).
60	Setup the MEAS & DISP MODE SETUP Page (SM).
70	Proceed to the GRAPHICS PLOT Page (MD) and perform one measurement (ME1).
80	Read the 4145B's Status Byte and assign the result to variable A.
90	Wait until bit 0 of variable A set to 1 (Data Ready).
100	Send a data output (DO) command to obtain the measurement data from the 'IC' monitor channel.
110	Enter the measurement data into the string variable, A\$.
120	Display the string variable A\$.

Figure 3-56. Sample Program 1 (Sheet 1 of 2)

The proceeding program can be modified, as follows, to make overlay plots on the GRAPHICS PLOT Page.

```

.
.
.
100 DIM G$ [20]
110 OUTPUT 717;"GL1;IN"
120 OUTPUT 717;"PA1570, 493; PD; PA220, 1725; PU"
130 OUTPUT 717;"PA1000, 1000; PD; SR0,3"
140 G$ = "4145B"
150 OUTPUT 717;"LB" & G$ & CHR$(3)
160 OUTPUT 717;"GL0"
170 END

```

These program modifications perform the following.

Line	Description
110	Set the 4145B to GL1 mode (GL1), and initialize the CRT (IN).
120	Draw a line from lower right corner to upper left corner of the plot area.
130	Move the beam (PA), and select the character size (SR).
140	Enter the data to be displayed into the string variable G\$.
150	PLOT"4145B" (LB).
160	Release the 4145B from GL1 mode.

This program modification makes overlay plots as shown below.

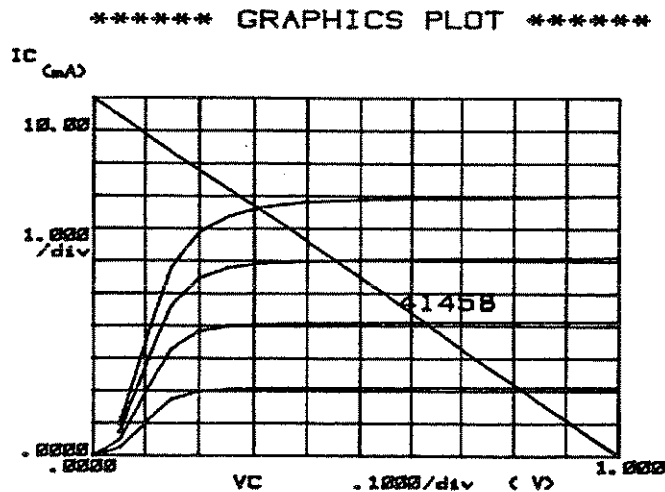

Figure 3-56. Sample Program 1 (Sheet 2 of 2)

## Sample Program 2

### Description

This program is an example of remote control, data output in the User Mode. The program has three capabilities:

- (1) Control of an SMU via the HP-IB
- (2) Trigger of the SMU via the HP-IB
- (3) Data output from the SMU via the HP-IB

### HP series 200/300 Program:

```

10 DIM A$(30)
20 OUTPUT 717; "US"
30 OUTPUT 717; "IT1 CA1 BC"
40 I = 1.5
50 OUTPUT 717; "DV1, 1, "; I; ", 1E-3"
60 OUTPUT 717; "DV2, 1, 0, 1E-3"
70 OUTPUT 717; "TII"
80 ENTER 717; A$
90 DISP A$
100 OUTPUT 717; "DV1; DV2"
110 END

```

This program performs the following:

Line	Description
10	Define a string variable, A\$, to store measurement data.
20	Set the 4145B to User Mode (US).
30	Set measurement integration time (IT1), auto calibration (CA1), and data buffer clear (BC).
40/50	Set up SMU1 (DV1).
60	Set up SMU2 (DV2).
70	Trigger for I measurement of SMU1 (TII).
80	Enter measurement data into the string variable, A\$.
90	Display the string variable A\$.
100	STOP the output for SMU1 and SMU2.

Also, CRT Display can be used as a Graphic Display when program code "GL2" is sent and HP-GL program codes are used, as shown in Figure 3-57.

Figure 3-57. Sample Program 2

## Sample Program 3

### Description

This program is an example of moving measurement results from the 4145B's internal micro floppy disc to a Desktop Computer while the 4145B is in the System mode. This function has the following capabilities.

- (1) Control of the 4145B via the HP-IB
- (2) Data output from the data buffer via the HP-IB

Set the HP-IB control switch as follows:

Address: 17

Delimiter: CR/LF

### HP series 200/300 Program

```

10  OPTION BASE 1
20  DIM A(575)
30  Points=505
40  OUTPUT 717; "GT 'D VDID'"
50  OUTPUT 717; "DO 'ID'"
60  FOR I=1 to Points
70  ENTER 717; A(I)
80  PRINT A(I)
90  NEXT I
100 END

```

This program performs the following:

Line	Description
10/20	Define a string variable, A(575), to store buffer data.
30	Define the number of data.
40	Send a get data (GT) command to get the data with the file name is 'VDID'.
50	Send a data output (DO) command to obtain the buffer data from the 'ID' channel.
70	Enter the buffer data into the string variable, A(575).
80	Print the string variable.

Figure 3-58. Sample Program 3

3-140. PLOT/PRINT Operation Using HP-IB Controller

Note

3-141. When performing a PLOT or PRINT operation using an HP-IB controller, use the following procedure.

- (1) Set the plotter or printer to "addressable".
- (2) Interconnect the 4145B, HP-IB plotter or printer, and controller with HP-IB cables.
- (3) Send the PLOT or PRINT command to the 4145B.
- (4) Set the 4145B to TALKER and set the plotter or printer to LISTENER. And set the ATN (Attention) Line to "Inactive" to start the plot or print operation.
- (5) End of plot or print can be detected by monitoring the EOI Line or SRQ Line.

If the controller attempts an HP-IB operation during a plot or print operation, an error may result or data may be incorrectly plotted or printed. Therefore, you cannot detect the end of a plot or print operation by reading the status byte of the 4145B.

Figure 3-59 shows programming example of HP-IB controlled plot operations with the HP series 200/300 Desktop Computer.

HP series 200/300 Program

```

10  ON INTR 7 GOTO 70
20  ENABLE INTR 7;2
30  OUTPUT 717;"PL100,100,5000,3000"
40  SEND 7;UNT UNL TALK 17 LISTEN 5 DATA
50  REMOTE 7
60  GOTO 60
70  A=SPOLL(717)
80  IF BIT(A,2) THEN PRINT "END"
90  BEEP
100 END
    
```

These programs perform the following:

Line	Description
10	Interrupt (PLOT END) handling instructions.
20	Enables controller to respond an SRQ
30	PLOT command
40	Assigns TALKER and LISTENER, and sets ATN line to "Inactive".

Figure 3-59. Program for HP-IB controlled PLOT Operations

## 3-142. External Display

3-143. The 4145B's CRT is equipped with X-Y-Z analog outputs which can be connected directly to a large screen graphics display. With the X, Y, and Z EXTERNAL CRT OUTPUT (located on the rear panel) connected to an external display, the displays on the 4145B's CRT will be displayed on the external display also. Recommended external displays are listed in Table 3-12.

## Note

The bandwidth of the external display must be at least 2MHz.

## Note

Output impedance of the EXTERNAL CRT OUTPUTS is  $330\Omega$  (X and Y) and  $240\Omega$  (Z). Thus, the input impedance of the external display must be sufficiently higher to obtain satisfactory display results.

Table 3-12. Recommended External Displays

Model NO.	Screen Size (HxW)
HP1304A	20cmx25cm
HP1310B	28cmx38cm
HP1311B	22cmx28cm
HP1317B	26cmx35cm
HP1321B	30cmx35cm

Figure 3-60 shows the interconnections between the 4145B and the external display.

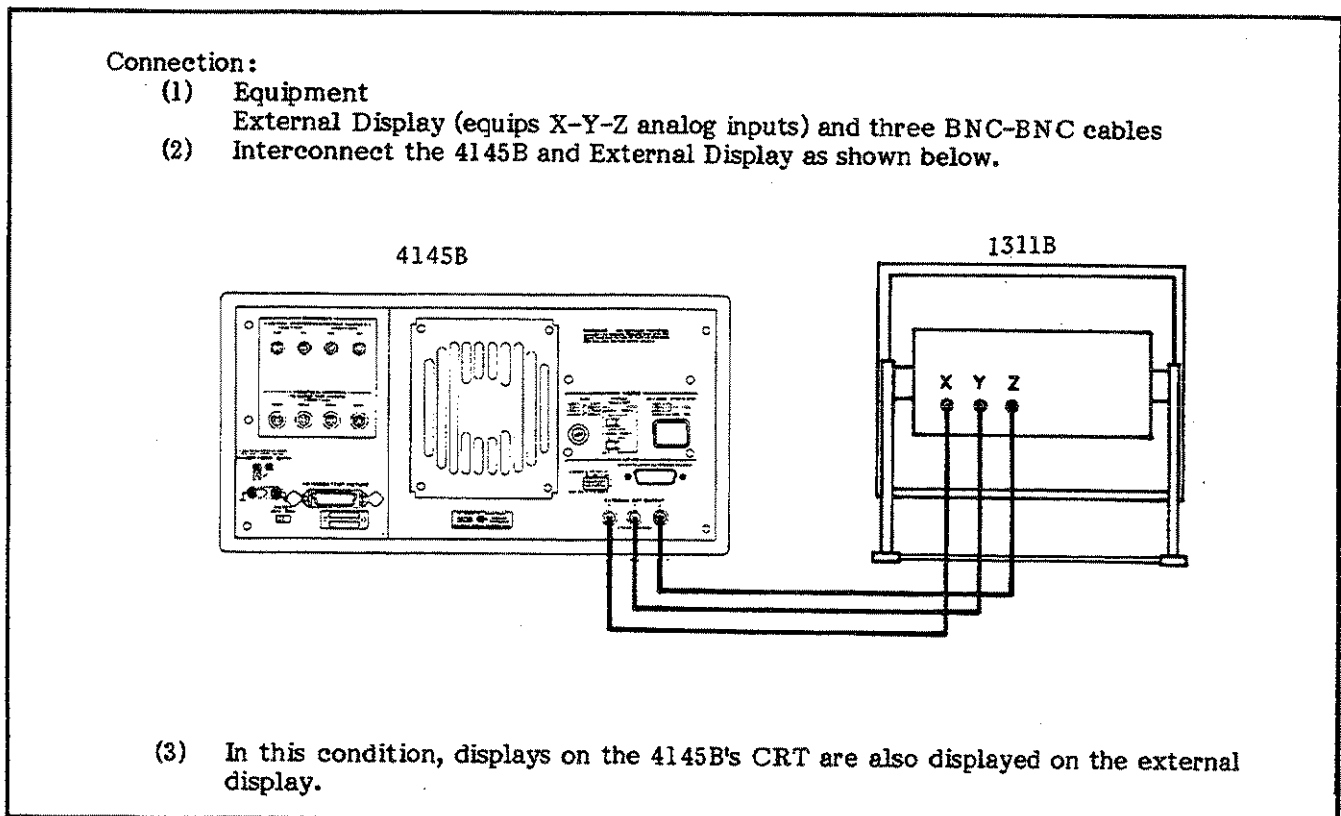

Figure 3-60. External Display

3-144. Disc Initializing

3-145. The purpose of disc initialization is to generate a directory onto the disc, which enables you to use the disc for the 4145B. Measurement Setups, Auto Sequence Programs, and measurement results from the 4145B can be stored on the initialized disc. Also, for archival purposes, the 4145B's operating system can be copied to the initialized disc, by using the operating system copy function (Refer to paragraph 3-146). The procedure to initialize a disc is described in Figure 3-61. The recommended disc is the HP 92192A, Micro Floppy Disc (double sided, double density).

Disc Initializing Procedure

- (1) Turn on the 4145B
- (2) Press the CATALOG softkey on the MENU Page. Display will be as shown below.

SKP31

<pre> [hp] *** USER FILE CATALOG *** Volume : HP4145 Rev. 1.0 available records = 2075 file name comments adrs blk                 </pre>	<table style="width: 100%; border-collapse: collapse;"> <tr><td style="border: 1px solid black; padding: 2px;">EXTN</td><td style="border: 1px solid black; padding: 2px;">EXTN</td></tr> <tr><td style="border: 1px solid black; padding: 2px;">PURGE</td><td style="border: 1px solid black; padding: 2px;">COPY DISC</td></tr> <tr><td style="border: 1px solid black; padding: 2px;"> </td><td style="border: 1px solid black; padding: 2px;">COPY SYS</td></tr> <tr><td style="border: 1px solid black; padding: 2px;">CAT</td><td style="border: 1px solid black; padding: 2px;">INIT DISC</td></tr> <tr><td style="border: 1px solid black; padding: 2px;">NEXT SCREEN</td><td style="border: 1px solid black; padding: 2px;">REV DATA</td></tr> <tr><td style="border: 1px solid black; padding: 2px;">PREV SCREEN</td><td style="border: 1px solid black; padding: 2px;">SAVE DATA</td></tr> <tr><td style="border: 1px solid black; padding: 2px;">ROLL UP</td><td style="border: 1px solid black; padding: 2px;">PURGE ALL</td></tr> <tr><td style="border: 1px solid black; padding: 2px;">ROLL DOWN</td><td style="border: 1px solid black; padding: 2px;"> </td></tr> </table>	EXTN	EXTN	PURGE	COPY DISC		COPY SYS	CAT	INIT DISC	NEXT SCREEN	REV DATA	PREV SCREEN	SAVE DATA	ROLL UP	PURGE ALL	ROLL DOWN	
EXTN	EXTN																
PURGE	COPY DISC																
	COPY SYS																
CAT	INIT DISC																
NEXT SCREEN	REV DATA																
PREV SCREEN	SAVE DATA																
ROLL UP	PURGE ALL																
ROLL DOWN																	

- (3) Press the EXTN softkey, then softkey prompt will be SKP 31.
- (4) Remove the disc and insert the blank disc.
- (5) Press the INIT DISC softkey.
- (6) "Initialize OK ?" will be displayed in the system message area. Press the EXEC softkey. If the QUIT softkey is pressed before pressing the EXEC softkey, the FORMAT operation is cancelled.
- (7) Disc initialization takes only a few minutes.

Note

By executing the Disc Initializing, all the programs and datas that are existing on the disc are purged.

Figure 3-61. Disc Initializing Procedures

## 3-146. Operating System Copy

## Note

3-147. For archival purposes, the 4145B can copy the Operating System Software onto discs that are initialized by the 4145B or HP series 200/300 Desktop Computers. The procedure is described in Figure 3-62.

The Operating System Copy function cannot copy the files of the user area onto the disc.

## CAUTION

The Operating System Copy function erase all files of the user area on the disc.

## Note

Copying the 4145B's Operating System Software for any means, except for archival purposes, without the prior written consent of Hewlett-Packard Company is prohibited. If extra system discs are required for purposes other than archival purposes, order P/N 04145-61501.

## Operating System Software Copy:

- (1) Turn on the 4145B.
- (2) Same procedure as that is step (2) of Figure 3-61.
- (3) Same procedure as that is step (3) of Figure 3-61.
- (4) Press the COPY SYS softkey.
- (5) When "Copy system OK ?" is displayed, press the EXEC softkey. If the QUIT softkey is pressed before pressing the EXEC softkey, the Operating System Software Copy operation is cancelled.

## Note

The System Disc must be in the 4145B's disc drive, if the QUIT softkey is pressed in the cancel procedure.

- (6) Insert the Master Disc (disc to be copied) that contains the Operating System and press the EXEC softkey.
- (7) After the disc has been accessed, "Insert the copy disc." is displayed. Remove the Master Disc and insert the initialized disc (target disc), then press the EXEC softkey.
- (8) "Copy completed" is displayed when Copy is finished. To copy additional discs, press the EXEC softkey and repeat steps (6) to (7). To return to the MENU page, press the QUIT softkey, insert the System Disc and press the EXEC or QUIT softkey.

Figure 3-62. Operating System Copy Procedures



## 3-148. DISC COPY

3-149. All files in the user area of a 4145B disc can be copied onto another disc. The procedure is given in Figure 3-63. The operating system software and the system files can also be copied with this function.

**User Area and Operating System Copy:**

- (1) Same procedures as that are steps (1) to (3) of Figure 3-61.
- (2) Press the COPY DISC softkey.
- (3) When "Copy disc OK?" is displayed, press the EXEC softkey. If the QUIT softkey is pressed before pressing the EXEC softkey, the Disc Copy operation is cancelled.

**Note**

The System Disc must be in the 4145B's disc drive, if the QUIT softkey is pressed in the cancel procedure.

- (4) Insert the Master Disc (disc to be copied) and press the EXEC softkey. A portion of the user area files will be loaded into the 4145B's RAM. This takes a few seconds.
- (5) Insert the Copy Disc (target disc) and press the EXEC softkey. The files loaded into the 4145B's RAM in step (3) will be copied onto the target disc.

**Note**

Write protect the Master Disc to protect the files from operational errors.

- (6) Repeat steps (4) and (5) if instructed to do so.
- (7) Copy is finished. To copy additional discs, press the EXEC softkey and repeat steps (4) and (5). To return to the MENU page, press the QUIT softkey, insert the System Disc and press the EXEC or QUIT key.

**Note**

Do not use the Disc that cannot complete the Disc Copy operation for the 4145B.

**Note**

If you want to copy one file, the procedure is given below.

**Copy One File:**

- (1) Turn on the 4145B.
- (2) Load a desired file using the GET function.
- (3) Change discs and store the file by using the SAVE function.

## 3-150. FILE TRANSFER

3-151. The 4145B can transfer all of the files (Program file, Data file and ASP file) from the HP 4145A's or another 4145B's disc without the aid of a controller. When the files are transferred from 4145A, HP 16267A File Transfer Software Disc for the 4145A (not furnished) is needed. Operating instructions for the FILE TRANSFER function are given in Figure 3-64.

From the HP 4145A

Connection:

- (1) Equipment  
HP 16267A File Transfer Software Disc for the 4145A and HP-IB cable.
- (2) Interconnect the 4145B and 4145A as shown below.

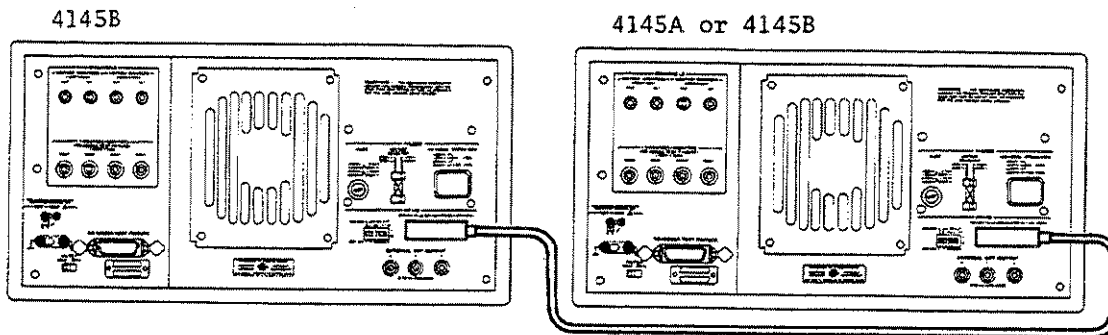

Note

Except for the 4145A and 4145B, nothing is with the HP-IB cable.

Transfer:

- (3) Insert the HP 16267A File Transfer Software Disc to the 4145A's built-in disc drive.
- (4) Turn the 4145A on.
- (5) Insert the System Disc and turn the 4145B on.
- (6) For the 4145A, press the CATALOG softkey. For the 4145B, press the CATALOG softkey on the MENU page and press the EXTN softkey.
- (7) For the 4145A, remove the File Transfer Software Disc and insert the disc containing the setup programs, Auto Sequence Programs and measurement results to be copied to the 4145B's Disc. For the 4145B, insert the copy disc (target disc).
- (8) For the 4145A, press the SEND DATA softkey and for the 4145B, press the RCV DATA softkey.
- (9) The filename of the file being transferred will be displayed. If the ABORT softkey on the 4145A or 4145B is pressed before the transfer is complete, the File Transfer operation is aborted. After pressing the ABORT softkey, the catalog of the existing files on the disc is displayed.
- (10) "Transfer completed." is displayed when the File Transfer operation is finished.

Figure 3-64. File Transfer Procedures (Sheet 1 of 2)

## From another 4145B:

## Connection:

- (1) Equipment:  
Another 4145B and an HP-IB cable.
- (2) Interconnect the 4145B's with the HP-IB cable as shown in the above figure.

## Transfer:

- (3) Turn both 4145B's on and press the CATALOG softkey on the MENU page. When the CATALOG page is displayed, press the EXTN softkey.
- (4) Insert the disc containing files to be copied into one 4145B and insert the copy disc (target disc) into the other 4145B.
- (5) Press the SEND DATA softkey on the 4145B from which the files will be copied, Press the REC DATA softkey on the 4145B that will be receiving the files.
- (6) The filename of the file being transferred will be displayed. If the ABORT Softkey is pressed on either 4145B before the transfer is complete, the File Transfer operation will be aborted.
- (7) "Transfer completed" is displayed when the File Transfer operation is finished.

## 3-152. Data File Structure

3-153. Data files stored on discs can be read on HP9000 Series 200 and 300 computers running BASIC 3.0 or 4.0. Paragraphs 3-154 through 3-162 explain the structure of data files: paragraphs 3-163 and 3-164 describe how to read measurement data from a disc. These paragraphs were written for users familiar with 4145B operation and BASIC 3.0 or 4.0 data storage and retrieval techniques. If this is not the case, however, this section and Chapter 7 (Data Storage and Retrieval) of the BASIC 3.0 or 4.0 Programming Techniques Manual will help you understand data file structure.

3-154. The 4145B's data files are divided into four main sectors, as follows.

1) BDAT System sector	256 bytes
2) File Comment sector	256 bytes
3) Setup Data sector	768 bytes
4) Measurement Data sector	4608 bytes

## 3-155. BDAT System Sector

3-156. This sector contains an End-of-File pointer and the number of defined records in the file. You cannot directly access the system sector. For more information, refer to Reading and Writing BDAT Files in Chapter 7 of the BASIC 3.0 or 4.0 Programming Techniques Manual.

## 3-157. File Comment Sector

3-158. This sector contains the file comment displayed on the catalog page. Figure 3-65 shows the structure of the File Comment Sector.

## 3-159. Setup Data Sector

3-160. This sector contains CHANNEL DEFINITION, SOURCE SETUP, MEAS & DISP SETUP, and OUTPUT SEQUENCE SETUP page data. Figure 3-66 shows the structure of the Setup Data sector. A brief explanation of each block in this sector is as follows.

- 1) ID TABLE [bytes 16 through 169]  
This block contains symbolic name, status, function, and channel data for each SMU, VS, VM, and User Function. Data for each item is contained in an 11-byte long data group, and all groups have the same structure. Figure 3-67 shows the 4145B's CHANNEL DEFINITION page and provides more detailed information on ID TABLE data groups.

- 2) SVCBV (Source Value Control Block for Variables) [bytes 171 through 264]  
The SVCBV contains setup, Hold Time, and Delay Time data for variables VAR1, VAR2, and VAR3. Data for each variable is contained in a 26-byte long data group, and all variable data groups have the same structure. Hold and Delay Times are written using the 4145B's 4 byte floating point data format as shown and explained in Figure 3-68. Figure 3-69 shows the 4145B's SOURCE SET UP page and provides more detailed information on SVCBV data groups.
- 3) SVCBC (Source Value Control Block for Constants) [bytes 265 through 330]  
The SVCBC contains setup data for each constant (SMU 1, 4, VS1, and VS2). Data for each constant is contained in an 11-byte long data group, and all groups have the same structure. Figure 3-70 shows SVCBC data group structure and provides more detailed information.
- 4) DACB (Data Array Control Block) [bytes 331 through 390]  
The DACB contains Data Area data for each channel (SMUs 1, 4, VM1, and VM2). Data for each channel is contained in a 10-byte long data group, and all groups have the same structure. Figure 3-71 shows DACB data group structure and provides more detailed information.
- 5) DCB (Display Control Block) [bytes 401 and 402]  
This block contains display mode data. Figure 3-72 shows DCB structure and provides more detailed information.
- 6) GRAPHIC PLOT DCB [bytes 403 through 463]  
This block contains data on the ID TABLES to be displayed on the GRAPHIC PLOT page, and on the X, Y1, and Y2 axes. ID TABLE data and data for each axis is contained in a 20-byte long data group, and all groups have the same structure. Figure 3-73 shows GRAPHIC PLOT DCB structure and provides more detailed information. If the first byte in a data group is a space, that axis is not used.

- 7) LIST DCB [bytes 463 through 528]  
The LIST DCB contains data on the ID TABLES to be displayed on the LIST page. Data for each Measurement Channel is contained in an 11-byte long data group, and all groups have the same structure as the ID TABLE structure shown in Figure 3-67. If the first byte in a data group is a space, that Measurement Channel is not used.
- 8) MATRIX DCB [bytes 529 through 539]  
This block contains data on the ID TABLE to be displayed on the MATRIX page. MATRIX DCB data is contained in an 11-byte data group that has the same structure as the ID TABLE structure shown in Figure 3-67.
- 9) SCHMOO DCB [bytes 540 through 570]  
This block contains data on the ID TABLE to be displayed on the SCHMOO PLOT page, and on the Z axis limits as defined on the MEAS & DISP MODE SETUP page. SCHMOO DCB data is contained in an 11-byte data group that has the same structure as the ID TABLE structure shown in Figure 3-67. Z axis limits are written using the 4145B's 4 byte floating point data format shown in Figure 3-68.
- 10) TBCB (Time Base Control Block) [bytes 571 through 582]  
The TBCB contains Wait, Interval, and Number of Steps data. Each data group is written using the 4145B's 4 byte floating point data format shown in Figure 3-68. Figure 3-74 shows TBCB structure and provides more information.
- 11) MCCB (Measurement Channel Control Block) [bytes 615 through 623]  
This block contains measurement mode, measure, not use, and measurement range data. Data is contained in a 9-byte data group. Figure 3-75 shows MCCB structure and provides more detailed information.
- 12) OSEQ (OUTPUT SEQUENCE) [bytes 625 through 630]  
This block contains channel (SMUs 1 ~ 4, VS1, and VS2) output sequence data. Figure 3-76 shows OSEQ structure and provides more detailed information.
- 13) DATA ST (DATA STORE) [byte 760]  
This byte shows whether the Measurement Data sector contains measurement data or not.
- 00H = no data  
01H = data
- 3-161. Measurement Data Sector
- 3-162. This sector contains Measurement data and data header information. The measurement data portion contains SMU status and channel number data in addition to the measurement data. The data header portion contains the measurement data's measurement append number and the VAR2 step number. Figure 3-77 shows the Measurement Data Sector's structure and provides more detailed information.
- The Measurement Data Sector begins with record number 2,432 and finishes with record number 4,735. This sector is divided into equal measurement data areas, depending on the number of measurement channels used. For example, if two channels are used, the first measurement data area will cover records 2,432 through 3,583, while the second measurement data area will cover records 3,584 through 4,735.
- 3-163. Reading Data Files
- 3-164. The procedure for reading a data file is as follows.
- 1) Confirm the presence of measurement data by reading the DATA ST byte (byte 760) in the Setup Data sector.
  - 2) Confirm which measurement channels were used by reading the MCCB (bytes 615 through 623) of the Setup Data sector.
  - 3) Retrieve the number of the measurement data record by reading the DACB (bytes 331 through 390) of the Setup Data sector.
  - 4) Read the desired measurement data record (retrieved in step 3) from the Measurement Data sector. Returned measurement data includes the VAR1 and VAR2 step numbers, and the measurement append number.

Figure 3-78 shows a sample program for reading a data file from a disc in accordance with the preceding procedure, and for plotting the data on the computer's CRT. The X axis corresponds to the VAR1 setting (linear) and the Y axis corresponds to the Y1 axis setting on the GRAPHIC PLOT page.

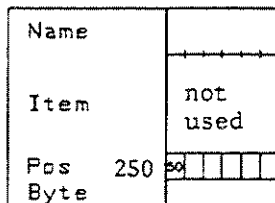
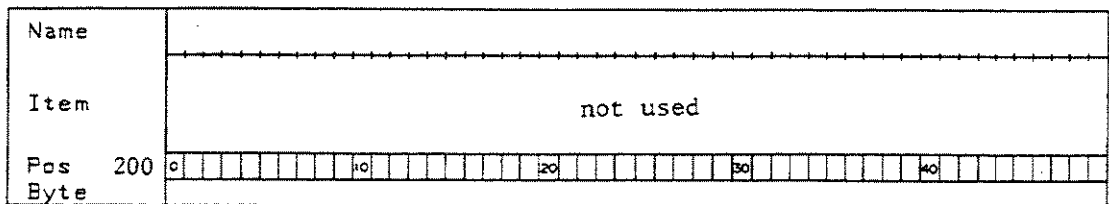
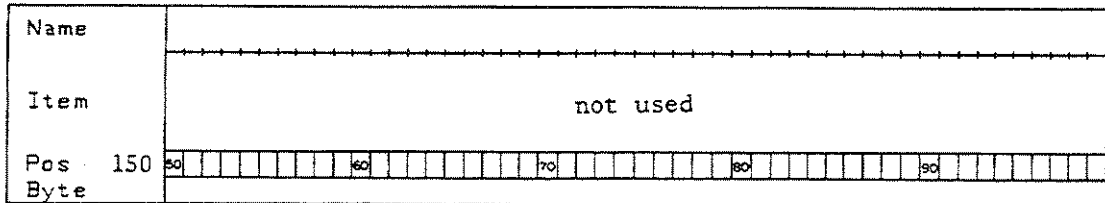
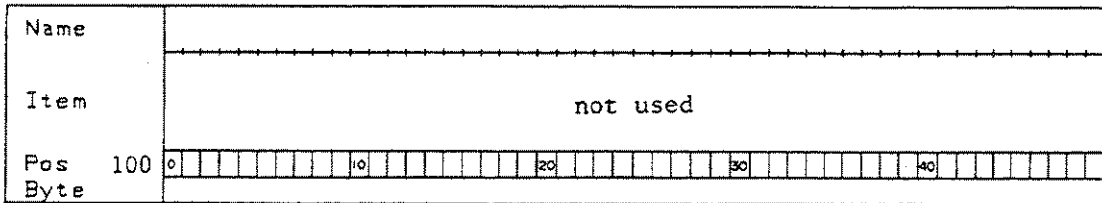
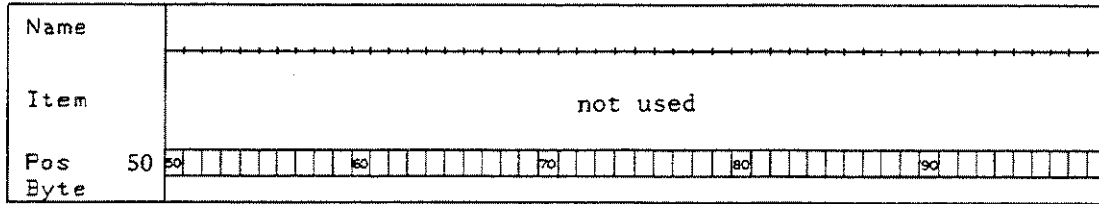
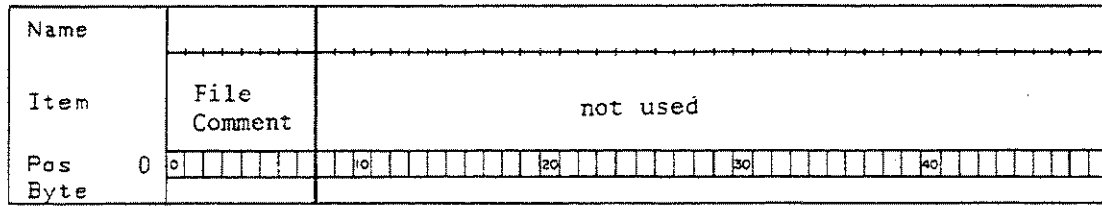

Figure 3-65. Structure of the File Comment Sector

Name	ID TABLE			
Item	not used	SMU 1 V	SMU 1 I	SMU 2 V
Pos	0	20	30	40
Byte	16	11	11	11

Name	ID TABLE				
Item	SMU 2 I	SMU 3 V	SMU 3 I	SMU 4 V	SMU 4 I
Pos	50	60	70	80	90
Byte	11	11	11	11	11

Name	ID TABLE				
Item	Vs 1	Vm 1	Vs 2	Vm 2	
Pos	100	110	120	130	140
Byte	11	11	11	11	

Name	ID TABLE		SVCBV		
Item	User Function 1	User Function 2	Var 1		
Pos	150	160	170	180	190
Byte	11	11	26		

Not used

Name	SVCBV				
Item	Var 2	HOLD TIME	DELAY TIME	Not used	Var 1'
Pos	200	210	220	230	240
Byte	26	4	4	8	

Name	SVCBV	SVCBC		
Item	Var 1'	SMU 1	SMU 2	SMU 3
Pos	250	260	270	280
Byte	26	11	11	11

Figure 3-66. Data File Structure of the Setup Data Sector (1 of 3)



Name	SVCBC			DACB	
Item	SMU 4	Vs 1	Vs 2	SMU 1	SMU 2
Pos 300	0	10	20	30	40
Byte	11	11	11	10	10

Name	DACB				
Item	SMU 3	SMU 4	Vm 1	Vm 2	not used
Pos 350	50	60	70	80	90
Byte	10	10	10	10	10

DCB

Name	GRAPHIC PLOT DCB		
Item	X axis	Y1 axis	
Pos 400	0	10	20
Byte	11	20	20

DISP MODE  
MEAS MODE

Name	GRAPHIC PLOT DCB	LIST DCB			
Item	Y2 axis	1st MEAS. CHAN.	2nd MEAS. CHAN.	3rd MEAS. CHAN.	4th
Pos 450	50	60	70	80	90
Byte	20	11	11	11	11

Name	LIST DCB			MATRIX DCB	SCHMOO DCB
Item	MEAS. CHAN	5th MEAS. CHAN.	6th MEAS. CHAN.		ID
Pos 500	0	10	20	30	40
Byte		11	11	11	11

Name	SCHMOO DCB				TBCB	CMTBUF
Item	1st limit	2nd limit	3rd limit	4th limit	Time Base	Comment
Pos 550	50	60	70	80	90	
Byte	20				12	32

Figure 3-66. Data File Structure of the Setup Data Sector (2 of 3)

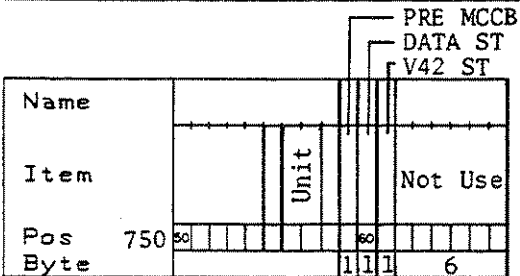
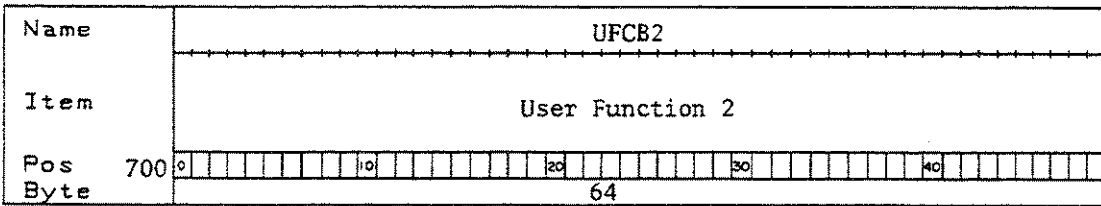
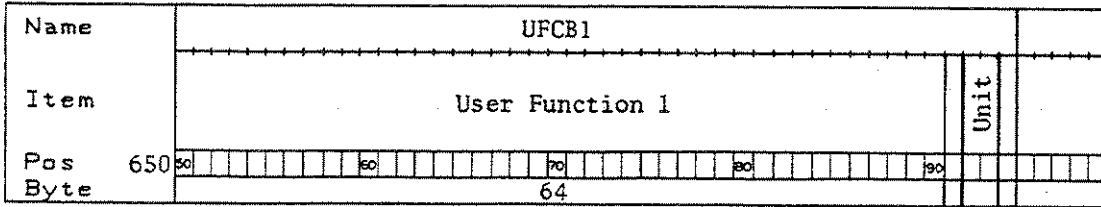
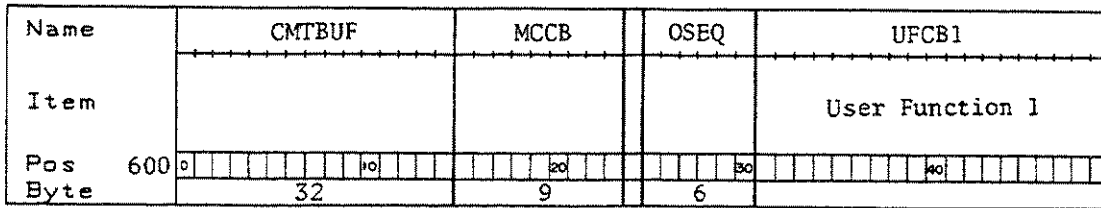
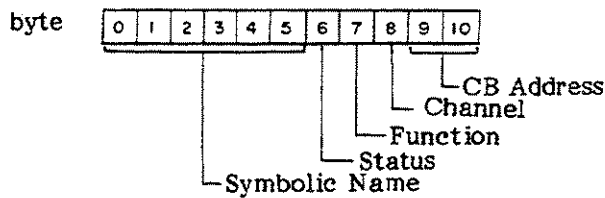

Figure 3-66. Data File Structure of the Setup Data Sector (3 of 3)



1) Symbolic Name

The Symbolic Name bytes contain the user-specified SMU, Vs, Vm, or User Function name that is assigned on the 4145B's CHANNEL DEFINITION page. This name can be up to 6 ASCII characters long.

2) Status

The Status byte containsur channel's source mode setting that is assigned on the CHANNEL DEFINITION page. Each bit is defined as follows.

bit 0	_____	0: Normal	1: Common
bit 1 ~ 4	_____	Always 0	
bit 5	_____	0: Source	1: Monitor
bit 6	_____	0: V mode	1: I mode
bit 7	_____	0: SMU, Vm, Vs	1: User Function

Example

- 00H\*: V source
- 01H: Common
- 20H: V monitor, Vs or User Function not used
- 40H: I source
- 60H: I monitor
- 80H: User Function

\*Hexadecimal notation.

3) Function

The Function byte contains the channels source function setting that is assigned on the CHANNEL DEFINITION page. Several examples are as follows.

- 00H: Monitor, User Function not used
- 40H: User Function 1
- 41H: User Function 2
- 80H: Constant
- 81H: Var 1
- 82H: Var 2
- 84H: Var 1'

4) Channel

The channel byte contains one of the following settings.

- 00H: SMU1, User Function
- 01H: SMU2
- 02H: SMU3
- 03H: SMU4
- 04H: Vs1, Vm1
- 05H: Vs2, Vm2

Figure 3-67. ID TABLE Structure (1 of 2)

## 5) CB Address

The CB Address bytes contain detailed channel address information, as follows.

If Var1, Var2 or Var1' is used, these bytes contain the SVCBV's address.

If a constant is used, these bytes contains SVCBC's address.

If a channel is set to Monitor, these bytes contains DACB's address.

If a channel is set to User Function, these bytes contain the UFCB's address.

Figure 3-67. ID TABLE Structure (2 of 2)

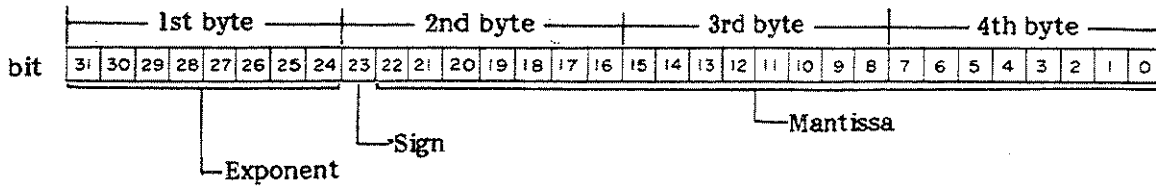

Exponent : 2's complement binary  $-128 \leq \text{Exponent} \leq 127$

Sign : "1" is -, "0" is +

Mantissa : Normalized 2's complement binary  
 $0.5 \times 2^{23} \leq \text{Mantissa} < 1 \times 2^{23}$

Real Value:  $\text{REAL Value} = (1 - 2 \times \text{Sign}) \times \text{Mantissa} \times 2^{\text{Exponent} - 23}$   
 \*"-23" means that the decimal point of the mantissa is set at bit 23.  
 $2^{-129} \leq |\text{REAL Value}| < 2^{127}$

Following is a sample program to transform 4byte Floating Point Data Format values to REAL values.

```

10    INTEGER Byte1,Byte2,Byte3,Byte4
20    REAL Mantissa,Exponent,Real1
30    !
40    Exponent=FNSigned(Byte1)-23
50    Mantissa=(FNSigned(Byte2)*256.+Byte3)*256.+Byte4
60    Real1=Mantissa*2^Exponent
70    DISP Real1
80    END
90    !
100   DEF FNSigned(INTEGER Byte)
110   !
120   IF BIT(Byte,7) THEN
130     RETURN (Byte-256)
140   ELSE
150     RETURN (Byte)
160   END IF
170   !
180   FNEND
    
```

Figure 3-68. HP 4145B 4byte Floating Point Data Format

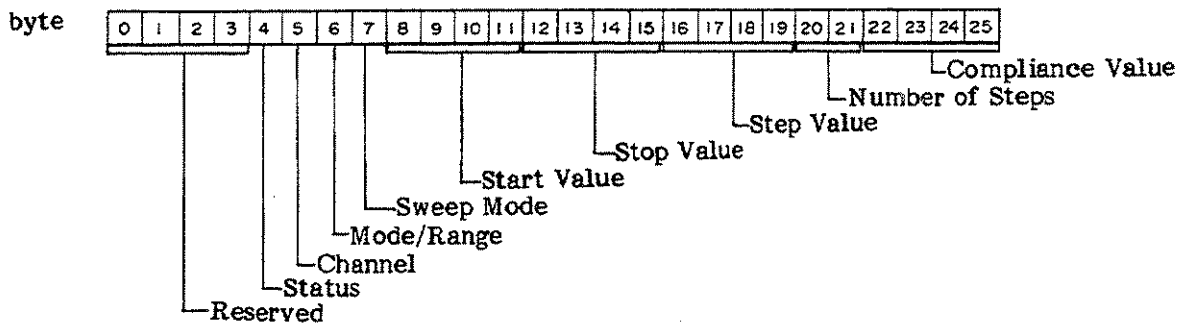

1) Status

The Status byte contains a variable's used or not used setting.

- 00H : Not used
- 80H : Used

2) Channel

The Channel byte contains the channel setting that corresponds to the variable used.

- 00H : SMU1
- 01H : SMU2
- 02H : SMU3
- 03H : SMU4
- 04H : Vs1
- 05H : Vs2

3) Mode/Range

The Mode/Range byte contains a variable's V source, I source, and source range setting.

- bit 0 through 4 — transform binary to decimal number
  - 7 : 100V range
  - 8 : 40V range
  - 9 : 20V range
  - 10 : 100mA range
  - 11 : 10mA range
  - 12 : 1mA range
  - 13 : 100 $\mu$  A range
  - 14 : 10 $\mu$  A range
  - 15 : 1 $\mu$  A range
  - 16 : 100nA range
  - 17 : 10nA range
  - 18 : 1nA range
- bit 5 and 6 — always 0
- bit 7 — 0: V mode    1: I mode

Figure 3-69. VAR1, VAR2, and VAR1' Structure (1 of 2)

## 4) Sweep Mode

The Sweep Mode byte contains a variable's linear sweep or log sweep setting that is assigned on the SOURCE SETUP page. If a variable is set to log sweep, this byte shows the number of the steps for one decade. (Transform a 2's complement binary to a REAL value.)

00H	:	Linear Sweep
0AH	:	Log10 increasing (10 steps for one decade)
04H	:	Log25 increasing (4 steps for one decade)
02H	:	Log50 increasing (2 steps for one decade)
F6H	:	Log10 decreasing
FCH	:	Log25 decreasing
FEH	:	Log50 decreasing

Refer to Figure 3-68, sample program lines 120 through 160 to transform a 2's complement binary value to a REAL value.

## 5) Start Value, Stop Value, Step Value and Compliance Value

These bytes contain values that are assigned on the SOURCE SET UP page. These values are written using 4145B 4byte Floating Point Data Format. Refer to Figure 3-68.

## 6) No. of Steps

The No. of Steps bytes contain the number of steps that are assigned on the SOURCE SET UP page. This value is written using the 2byte Integer format.

Figure 3-69. VAR1, VAR2, and VAR1' Structure (2 of 2)

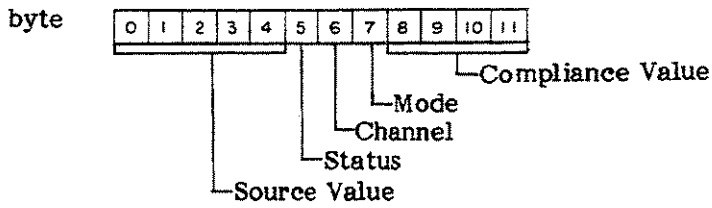

- 1) Source Value and Compliance Value  
These bytes contain constant source values and compliance values that are assigned on the SOURCE SET UP page. The values are written using the 4145B 4byte Floating Point Data Format. Refer to Figure 3-68.
- 2) Status  
The Status byte contains a channel's used or not used setting.  
  
00H : Not used  
80H : Used
- 3) Channel  
The Channel byte contains the channel setting.  
  
00H : SMU1  
01H : SMU2  
02H : SMU3  
03H : SMU4  
04H : Vs1  
05H : Vs2
- 4) Mode  
The Mode byte contains the source mode setting that is assigned on the SOURCE SET UP page.  
  
01H : Common  
80H : I mode

Figure 3-70. SVCBC Structure



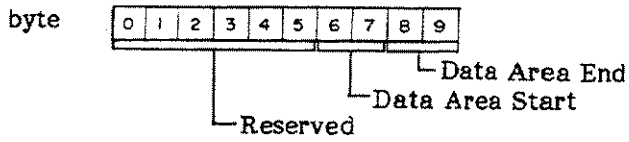

- 1) Data Area Start  
The Data Area Start bytes contain the starting address of a channel's measurement data in the Measurement Data Sector.
- 2) Data Area End  
The Data Area End bytes contain the last address of a channel's measurement data in the Measurement Data Sector.

Note

Data Area Addresses are 1300H through 24FFH.

Figure 3-71. DACB Structure

byte

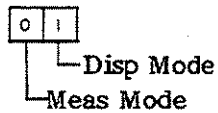
**1) Meas Mode**

The Meas Mode byte contains the measurement mode's sweep or time domain measurement setting.

- 00H: Sweep Measurement
- 01H: Time Domain Measurement

**2) Disp Mode**

The Disp Mode byte contains the display mode setting that is assigned on the MEAS & DISP MODE SET UP page.

- 01H: Graphic Plot
- 02H: List
- 04H: Matrix
- 08H: Schmo Plot

Figure 3-72. DCB Structure

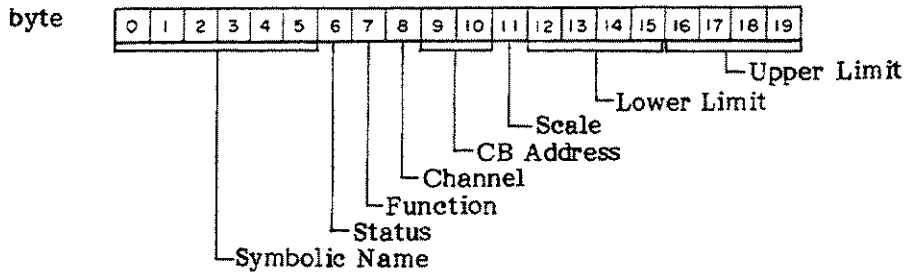

- 1) **Symbolic Name, Status, Function, Channel and CB address**  
 These bytes contain the ID TABLE data that is to be displayed on the GRAPHIC PLOT page as X, Y<sub>1</sub> or Y<sub>2</sub> axes.
  
- 2) **Scale**  
 This Scale byte contains the scale setting for The GRAPHIC PLOT page.
  - 00H: Linear
  - 01H: Log increasing
  - FFH: Log decreasing
  
- 3) **Lower Limit, Upper Limit**  
 These bytes contain the Lower (Left) and Upper (Right) Limits of the X, Y<sub>1</sub>, or Y<sub>2</sub> axis. These bytes are written using the 4145B 4byte Floating Point Data Format as shown Figure 3-68.

Figure 3-73. GRAPHIC PLOT DCB Structure

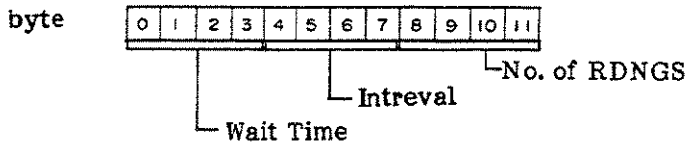

1) Wait Time, Interval, No. of RDNGS

These bytes contain wait time, interval time, and number of RDNGS data for a time domain measurement. These bytes are written using the 4145B's 4 byte floating point data format as shown Figure 3-68.

Figure 3-74. TBCB Structure

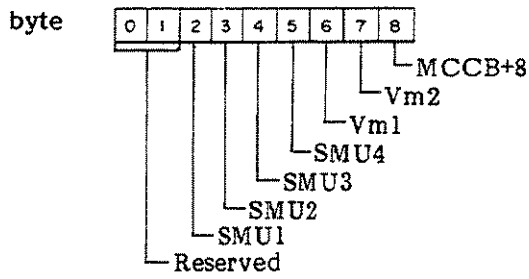

1) SMUs 1 4, Vm1, Vm2

These bytes contain channel setting data (Whether the channel is set to or not, V measurement, or I measurement). Each bit (for each byte) is as follows.

- bit 0~3 ——— Always 1 (means auto range)
- bit 4 and 5 ——— Always 0
- bit 6 ——— 0: Not measure      1: Measure
- bit 7 ——— 0: V measure      1: I measure

2) MCCB+8

This byte also contains channel setting data (whether measure or not measure is set). Each bit is defined as follows.

- bit 0 ——— SMU1    0: Not measure      1: Measure
- bit 1 ——— SMU2    0: Not measure      1: Measure
- bit 2 ——— SMU3    0: Not measure      1: Measure
- bit 3 ——— SMU4    0: Not measure      1: Measure
- bit 4 ——— Vm1     0: Not measure      1: Measure
- bit 5 ——— Vm2     0: Not measure      1: Measure
- bit 6 and 7 ——— Always 0

Figure 3-75. MCCB Structure

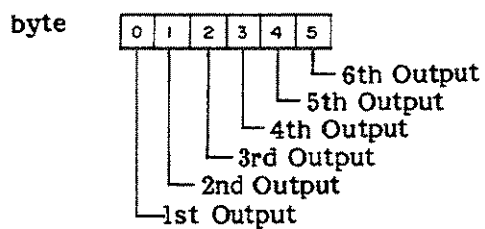

- 1) 1st through 6th Output  
Each byte contains channel number setting data as follows.

00H: SMU1  
01H: SMU2  
02H: SMU3  
03H: SMU4  
04H: Vs1  
05H: Vs2

Figure 3-76. OSEQ Structure

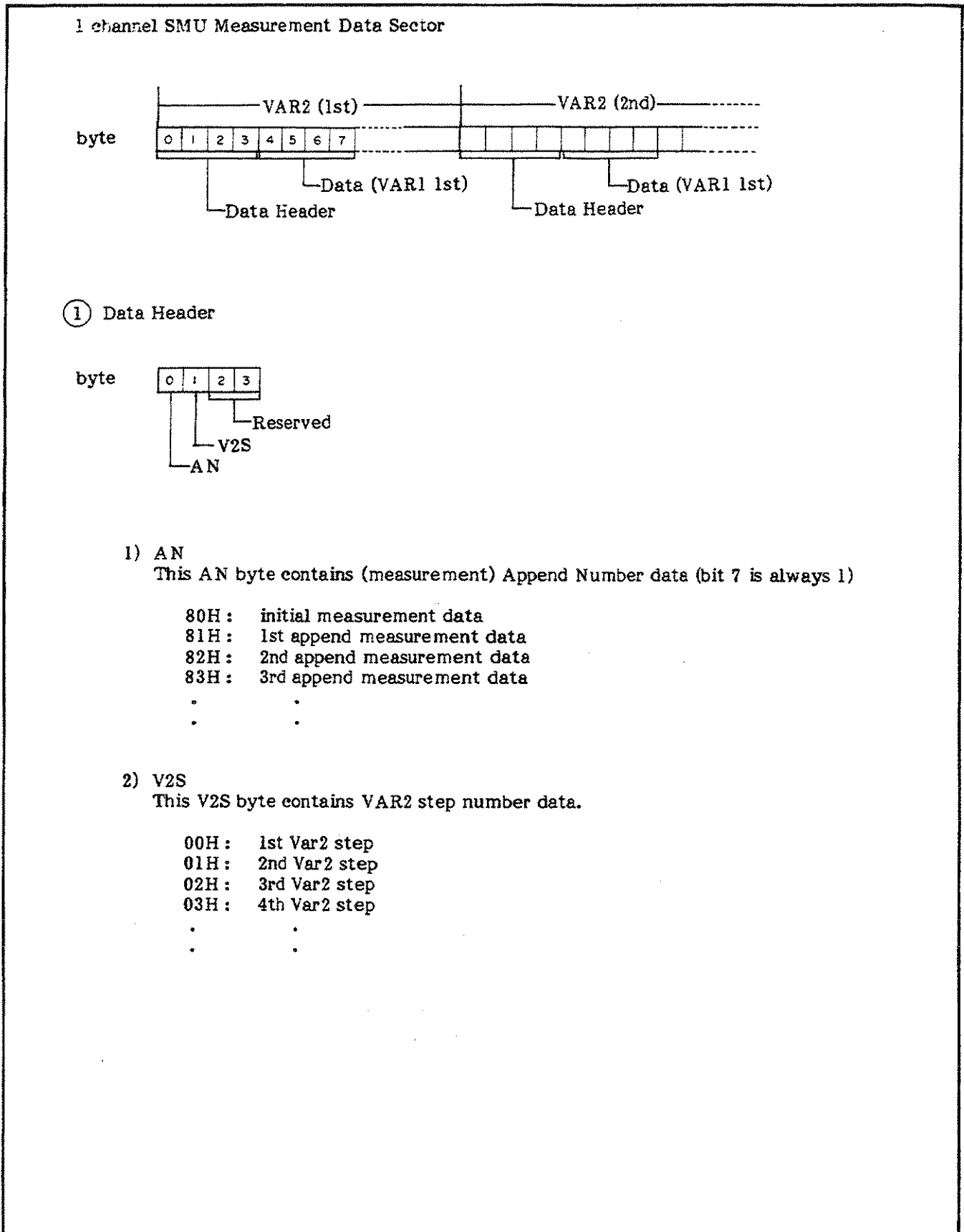
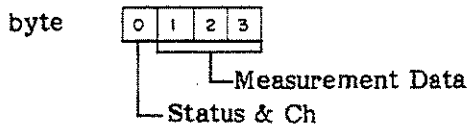

Figure 3-77 Measurement Data Sector Structure (1 of 2)

## ② Data



## 1) Status &amp; Ch

The Status & Ch byte contains data error status and channel number data.

bit 0~2	transform binary to decimal number
	0: SMU1
	1: SMU2
	2: SMU3
	3: SMU4
	4: Vm1
	5: Vm2
	7: lost data
bit 3~6	Status
	if bit 3 is 1 : A/D converter is saturated.
	if bit 4 is 1 : Oscillation
	if bit 5 is 1 : Other channel has reached compliance
	if bit 6 is 1 : This channel has reached compliance.
bit 7	always 0

## 2) Measurement Data

Data contained in the measurement Data bytes written using the 4145B's 3 byte floating point data format, which is the same as the 4 byte floating point format shown in Figure 3-68, except the last byte is omitted.

## 3) Blank (unused) areas.

All blank measurement data bytes will return "FFH".

## ③ Blank (unused) Area

Blank measurement data bytes will return "FFH".

Figure 3-77 Measurement Data sector Structure (2 of 2)



## Note

This sample program runs under the BASIC 3.0 or 4.0 environment, and requires loading the GRAPH binary files as well as the appropriate files from your disc drive.

```

10  INTEGER Base,Smu_no,Data_ptr,Flag,Stat,Ch
20  INTEGER Comment(0:127),Prog45(0:383),Data45(2432:4735)
30  INTEGER Meas_ch_active(5)
40  INTEGER Data_start,Data_end
50  INTEGER Prev_valid
60  REAL Sweep_start,Sweep_end,Sweep_step,Var1,Vary
70  REAL Ymin,Ymax
80  DIM FileNames$(100),Workdir$(100)
90  !
100 Workdir$=SYSTEMS("MSI")
110 MASS STORAGE IS ":HP9122.700,0"
120 !
130 GINIT
140 GRAPHICS ON
150 GCLEAR
160 !
170 LINPUT "Please enter file name",FileNames$
180 ASSIGN @File TO FileNames$
190 !
200 ENTER @File;Comment(*).Prog45(*).Data45(*)
210 !
220 IF FNGet_byte(Prog45(*),760)=0 THEN           ! DATAS
230   DISP "No valid data !!!"
240 ELSE
250   Ch_active_frag=0
260   FOR Channel=0 TO 5
270     Meas_ch_active(Channel)=BIT(FNGet_byte(Prog45(*),617+Channel),6)
280     Ch_active_frag=Ch_active_frag+Meas_ch_active(Channel)
290   NEXT Channel
300   IF Ch_active_frag<>0 THEN
310     FOR Channel=0 TO 5
320       IF BIT(FNGet_byte(Prog45(*),617+Channel),6) THEN           ! MCCB
330         Smu_no=Channel
340         Data_start=FNGet_word(Prog45(*),331+Smu_no*10+5)           ! DACB
350         Data_end=FNGet_word(Prog45(*),331+Smu_no*10+8)           ! DACB
360         Sweep_start=FNGet_real(Prog45(*),171+8)
370         Sweep_end=FNGet_real(Prog45(*),171+12)
380         Sweep_step=FNGet_real(Prog45(*),171+16)
390         Ymin=FNGet_real(Prog45(*),423+12)
400         Ymax=FNGet_real(Prog45(*),423+16)
410       !
420       VIEWPORT 10,120,10,90
430       WINDOW Sweep_start,Sweep_end,Ymin,Ymax
440       !
450       Var1=Sweep_start
460       FOR Data_ptr=Data_start TO Data_end-1 STEP 4
470         Vary=FNGet_data(Data45(*),Data_ptr,Flag,Stat,Ch)
480         SELECT Flag
490         CASE 0! Data
500           IF Prev_valid THEN
510             DRAW Var1,Vary           :
520           ELSE
530             MOVE Var1,Vary
540           END IF
550           Prev_valid=1
560         CASE 1
570           Var1=Sweep_start
580           Prev_valid=0
590         CASE -1

```

Figure 3-78. Sample Program for Reading a Data File (Sheet 1 of 4)

```

600             Prev_valid=0
610             END SELECT
620             Var1=Var1+Sweep_step
630             NEXT Data_ptr
640             ELSE
650             END IF
660             NEXT Channel
670             ELSE
680             DISP "Not measurement channel !!!"
690             END IF
700             END IF
710             !
720             MASS STORAGE IS Workdir$
730             !
740             END
750             !-----
760             DEF FNGet_real(INTEGER Array(*),Pointer) !-----
770             !
780             INTEGER Byte_1st,Byte_2nd,Byte_3rd,Byte_4th
790             REAL Real_value
800             !
810             Byte_1st=FNGet_byte(Array(*),Pointer+0)
820             Byte_2nd=FNGet_byte(Array(*),Pointer+1)
830             Byte_3rd=FNGet_byte(Array(*),Pointer+2)
840             Byte_4th=FNGet_byte(Array(*),Pointer+3)
850             Byte_to_real(Byte_1st,Byte_2nd,Byte_3rd,Byte_4th,Real_value)
860             RETURN (Real_value)
870             FNEND
880             !-----
890             DEF FNGet_data(INTEGER Array(*),Pointer,Data_flag,Smu_status,Channel) !---
900             !
910             INTEGER Byte_1st,Byte_2nd,Byte_3rd,Byte_4th
920             REAL Real_value
930             !
940             Byte_1st=FNGet_byte(Array(*),Pointer+0)
950             Byte_2nd=FNGet_byte(Array(*),Pointer+1)
960             Byte_3rd=FNGet_byte(Array(*),Pointer+2)
970             Byte_4th=FNGet_byte(Array(*),Pointer+3)
980             Byte_to_data(Byte_1st,Byte_2nd,Byte_3rd,Byte_4th,Real_value,Data_flag,Sm
u_status,Channel)
990             IF Data_flag=1 THEN
1000             SELECT Channel
1010             CASE 0 TO 5                                ! SMU #1~4. Vm #1~2
1020             Channel=Channel+1
1030             CASE 7                                    ! lost data
1040             Channel=-1
1050             CASE ELSE                                ! illegal
1060             Channel=0
1070             END SELECT
1080             END IF
1090             RETURN (Real_value)
1100             FNEND
1110             !-----
1120             DEF FNGet_string$(INTEGER Array(*),Pointer,Length) !-----
1130             !
1140             INTEGER Char_pointer
1150             INTEGER Char_valid
1160             DIM String$(100)
1170             DIM Char$(1)
1180             !
1190             String$=""

```

Figure 3-78. Sample Program for Reading a Data File (Sheet 2 of 4)

```

1200 Char_valid=0
1210 FOR Char_pointer=MIN(Length,100) TO 1 STEP -1
1220 Char$=CHR$(FNGet_byte(Array(*),Pointer+Char_pointer-1))
1230 IF NUM(Char$)<32 THEN Char$=" " ! change control to space
1240 IF Char$<>" " THEN Char_valid=1 ! end of trailing space
1250 IF Char_valid THEN String$=Char$&String$ ! concatenate
1260 NEXT Char_pointer
1270 RETURN (String$)
1280 FNEND
1290 !-----
1300 DEF FNGet_word(INTEGER Array(*),Pointer) !-----
1310 !-----
1320 INTEGER Upper_byte,Lower_byte,Word_value
1330 !
1340 IF (Pointer MOD 2)=0 THEN
1350 RETURN (Array(Pointer DIV 2))
1360 ELSE
1370 Upper_byte=FNGet_byte(Array(*),Pointer+0)
1380 Lower_byte=FNGet_byte(Array(*),Pointer+1)
1390 Byte_to_word(Upper_byte,Lower_byte,Word_value)
1400 RETURN (Word_value)
1410 END IF
1420 FNEND
1430 !-----
1440 DEF FNGet_byte(INTEGER Array(*),Pointer) !-----
1450 !-----
1460 INTEGER Upper_byte,Lower_byte
1470 !
1480 Word_to_byte(Array(Pointer DIV 2),Upper_byte,Lower_byte)
1490 IF (Pointer MOD 2)=0 THEN
1500 RETURN (Upper_byte) ! even address
1510 ELSE
1520 RETURN (Lower_byte) ! odd address
1530 END IF
1540 FNEND
1550 !-----
1560 SUB Byte_to_real(INTEGER Byte1,Byte2,Byte3,Byte4,REAL Real1) !-----
1570 !-----
1580 REAL Flac,Expo
1590 !
1600 Flac=(FNSigned8(Byte2)*256.+Byte3)*256.+Byte4
1610 Expo=FNSigned8(Byte1)-23
1620 Real1=Flac*2Expo
1630 SUBEND
1640 !-----
1650 SUB Byte_to_data(INTEGER Byte1,Byte2,Byte3,Byte4,REAL Real1,INTEGER Data_f
lag,Smu_status,Channel)
1660 !-----
1670 SELECT Byte1
1680 CASE 255 ! no data
1690 Data_flag=-1
1700 Smu_status=0
1710 Channel=0
1720 Real1=0
1730 CASE ELSE
1740 IF BIT(Byte1,7) THEN ! header mark
1750 Data_flag=1
1760 Smu_status=BINAND(Byte1,IVAL("0111111",2))
1770 Channel=Byte2
1780 Real1=0
1790 ELSE ! normal data

```

Figure 3-78. Sample Program for Reading a Data File (Sheet 3 of 4)

```

1800     Data_flag=0
1810     Byte_to_real(Byte2,Byte3,Byte4,0,Real1)
1820     Smu_status=SHIFT(BINAND(Byte1,IVAL("01111000",2)),3)
1830     Channel=BINAND(Byte1,IVAL("00000111",2))
1840     END IF
1850     END SELECT
1860     SUBEND
1870     !-----
1880     SUB Byte_to_word(INTEGER Byte1,Byte2,Word1) !-----
1890     !-----
1900     Word1=BINIOR(SHIFT(Byte1,-8),Byte2)           ! conjunction MSB and LSB
1910     SUBEND
1920     !-----
1930     SUB Word_to_byte(INTEGER Word1,Byte1,Byte2) !-----
1940     !-----
1950     Byte1=BINAND(SHIFT(Word1,8),IVAL("11111111",2))! MSB, right justify
1960     Byte2=BINAND(Word1,IVAL("11111111",2))       ! LSB
1970     SUBEND
1980     !-----
1990     DEF FNSigned8(INTEGER Byte1) !-----
2000     !-----
2010     IF BIT(Byte1,7) THEN
2020         RETURN (Byte1-IVAL("100",16))
2030     ELSE
2040         RETURN (Byte1)
2050     END IF
2060     FNEND
2070     !-----

```

Figure 3-78. Sample Program for Reading a Data File (Sheet 4 of 4)