

Valuetronics International, Inc.  
1-800-552-8258  
**MASTER COPY**



# HP 4263A LCR Meter User's Guide



# HP 4263A LCR Meter at a Glance

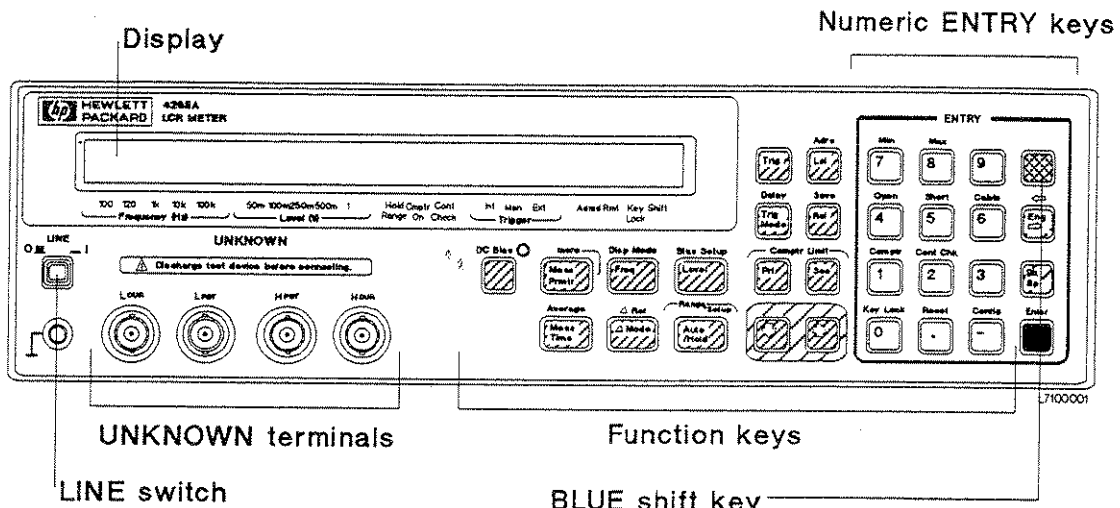

Activates the secondary function printed in blue above the keys. For example,

Pressing   executes an OPEN correction.

(In this book, the BLUE shift key is expressed as  the top of the key is not labelled "blue".)

## Annunciator ( marks, at the bottom of the display )

Shows the instrument's operational state. For example,

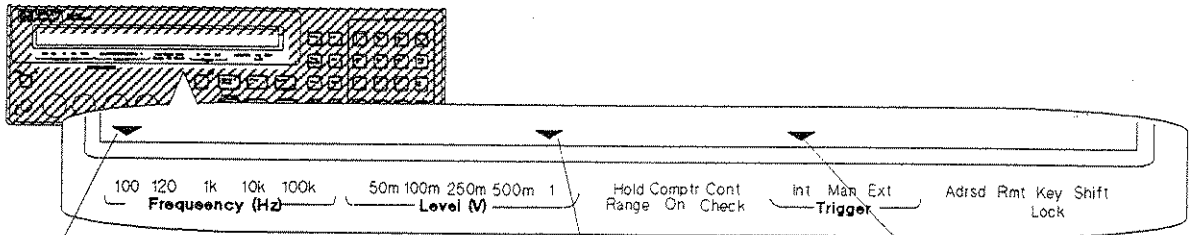

Indicates the test frequency is 100 Hz.

Indicates the test level is 1 V.

Indicates the internal trigger mode is selected.



# Contents

---

<b>1. Preparation for Use</b>	
In This Chapter . . . . .	1-1
Power Requirements . . . . .	1-1
To Set Power LINE Voltage . . . . .	1-1
To Set Power LINE Frequency . . . . .	1-2
<b>2. Operating the HP 4263A</b>	
In This Chapter . . . . .	2-1
Measurement Procedure . . . . .	2-1
To Reset HP 4263A to its Default Settings . . . . .	2-2
To Connect Test Fixture . . . . .	2-2
To Set Cable Length—Canceling the Phase Shift Error . . . . .	2-2
To Select Measurement Parameter . . . . .	2-3
To Set Test Frequency . . . . .	2-3
To Set Test Level . . . . .	2-3
To Set DC Bias Source Voltage . . . . .	2-4
To Select Measurement Time Mode . . . . .	2-4
To Set Averaging Rate . . . . .	2-4
To Select Measurement Range . . . . .	2-5
Auto Range mode—Automatically Selecting the Optimum Measurement Range . . . . .	2-5
Hold Range mode—Selecting the Measurement Range of Your Choice . . . . .	2-5
To Select Trigger Mode . . . . .	2-6
To Set Trigger Delay Time . . . . .	2-6
To Perform OPEN Correction . . . . .	
—Canceling the stray admittance in parallel with the DUT . . . . .	2-7
To Perform SHORT Correction . . . . .	
—Canceling the residual impedance in series with the DUT . . . . .	2-7
To Use the Comparator Function . . . . .	2-8
Setting the Limit Values . . . . .	2-8
Sorting . . . . .	2-8
To Use the Contact Check Function . . . . .	
—Monitoring the connection of test electrodes and DUT . . . . .	2-9
To Use the Deviation Measurement Function . . . . .	2-9
Setting the Deviation Reference Values . . . . .	2-9
Selecting the Deviation Mode . . . . .	2-9
To Select Display Mode . . . . .	2-10
To Select Beeper Mode . . . . .	2-10
To Set Printer—Printing the measurement data . . . . .	2-11
To Connect DUT . . . . .	2-11
To Apply DC Bias . . . . .	2-12
To Trigger a Measurement . . . . .	2-12
If You Have a Problem . . . . .	2-12
Reference . . . . .	2-13
Default Settings . . . . .	2-13
Measurement Parameters . . . . .	2-13
Accessories Available . . . . .	2-14

HP 16064B LED Display/Trigger Box . . . . .	2-14
Test Fixtures and Test Leads . . . . .	2-14
Measurement Range Setting . . . . .	2-16
Other Topics . . . . .	2-16
<b>3. Measurement Examples</b>	
In This Chapter . . . . .	3-1
HP 4263A Features and Benefits . . . . .	3-1
Test System Configuration on the Production Line . . . . .	3-1
Electrolytic Capacitor Measurement—For High Capacitance . . . . .	3-2
DUT . . . . .	3-2
Requirements . . . . .	3-2
Measurement Setup . . . . .	3-2
Measurement Procedure . . . . .	3-2
For More Information . . . . .	3-4
Inductor Measurement—Versatile measurement parameters . . . . .	3-5
DUT . . . . .	3-5
Requirements . . . . .	3-5
Measurement Setup . . . . .	3-5
Measurement Procedure . . . . .	3-5
For More Information . . . . .	3-7
Transformer Measurement (Option 001 Only) . . . . .	3-8
DUT . . . . .	3-8
Requirements . . . . .	3-8
Measurement Setup . . . . .	3-8
Measurement Procedure . . . . .	3-8
For More Information . . . . .	3-10

## Figures

---

2-1. Measurement Procedure . . . . .	2-1
2-2. Connecting a Test Fixture . . . . .	2-2
2-3. Printer Output . . . . .	2-11
2-4. Connecting the DUT . . . . .	2-11

## Tables

---

1-1. Line Voltage Selection . . . . .	1-1
---------------------------------------	-----

## Preparation for Use

### In This Chapter

First you must set the HP 4263A to match the available power LINE voltage, before turning the HP 4263A ON.

If the HP 4263A's power LINE voltage and frequency are properly set and ready to use, you can skip this chapter.

### Power Requirements

The HP 4263A's power source requirements are as follows:

**LINE Voltage :** 100 / 120 / 220 / 240 V ac ( $\pm 10\%$ )

**LINE Frequency :** 47 to 66 Hz

**Power Consumption :** 45 VA maximum

### To Set Power LINE Voltage

1. Confirm that the power cable is disconnected.
2. Slide the LINE Voltage selector on the rear panel to match the ac LINE voltage which will be used (see Table 1-1).

**Table 1-1. Line Voltage Selection**

Voltage Selector	Line Voltage	Required Fuse
(a) 115 V	100 / 120 V	T 0.5 A 250 V (HP part number 2110-0202)
(b) 230 V	220 / 240 V	T 0.25 A 250 V (HP part number 2110-0201)

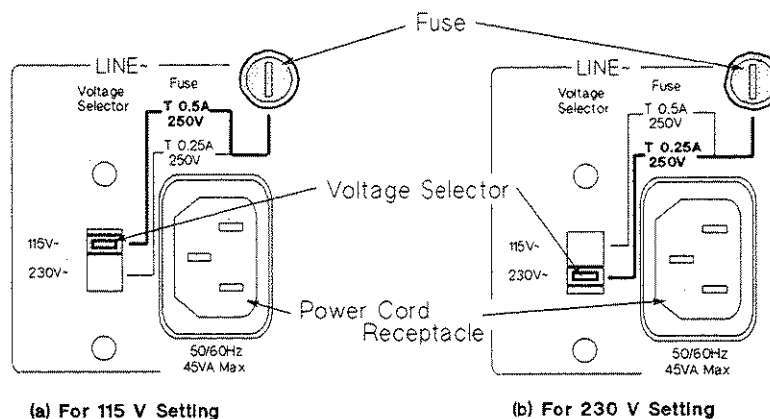

## To Set Power LINE Frequency



**Note** In this manual, the BLUE shift key is expressed as , the top of the key is not labelled "blue".

1. Connect the power cable to the power cord receptacle on the rear panel.
2. Push the LINE switch in and the HP 4263A will emit a beep when it turns ON. All digits are displayed while the self test is in progress. (If any message is displayed, see "Error Messages" at the back of Operation manual.) The HP 4263A will be ready for operation after a message like the following is displayed.



HP 4263A REV 0.100 OPT 001

If your HP 4263A is not equipped with Option 001, this area will be blank.

3. Press  . The following message is displayed.

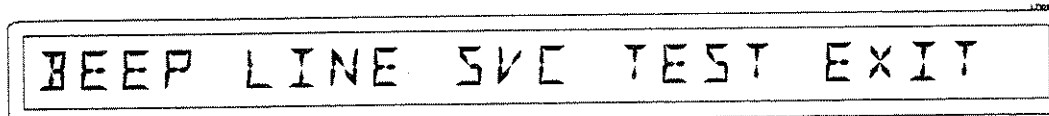

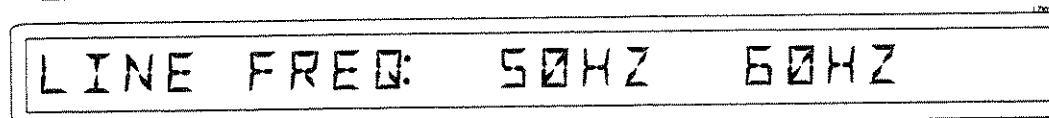

BEEP LINE SVC TEST EXIT

4. Press  until LINE blinks, then press .



LINE FREQ: 50HZ 60HZ

A blinking item means that it is currently selected.

5. If the setting does not match the ac line frequency, press  to toggle the setting between 50 HZ and 60 HZ.
6. Press  twice to exit this menu.

**Note** The power line frequency setting is stored and is not changed after reset or power-off. Once you set it, you do not need to set the line frequency again as long as the same power line frequency is being used.



## Operating the HP 4263A

### In This Chapter

Basic operation of the HP 4263A is explained.

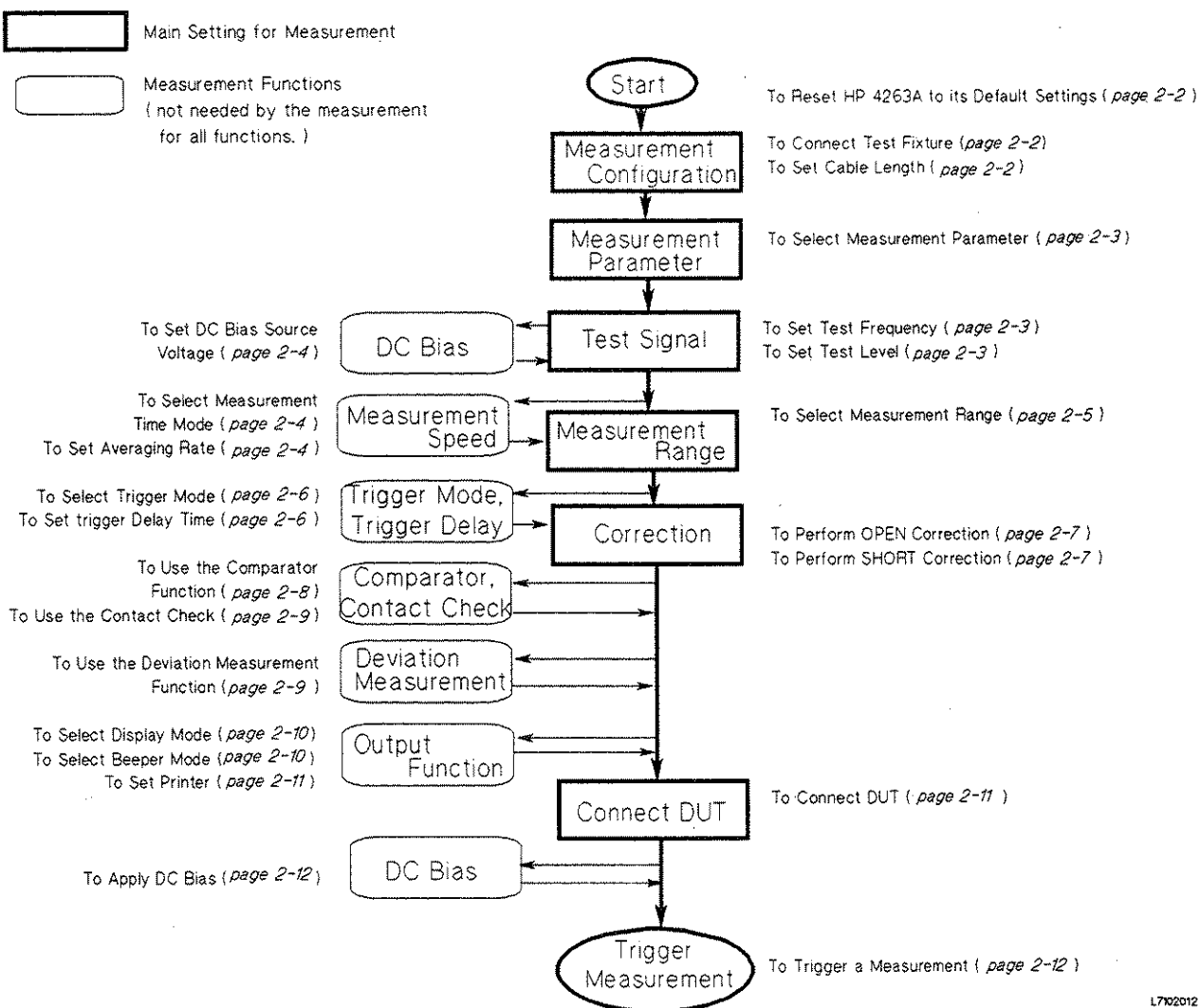

### Measurement Procedure





L7102012

Figure 2-1. Measurement Procedure

## To Reset HP 4263A to its Default Settings

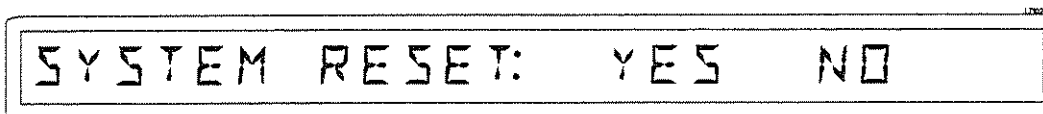
1. Press   to select the reset menu.



2. Press  until YES is blinking, then press .

The HP 4263A will be reset to its default settings. For more information about the default settings, see “Default Settings” later in this chapter.

## To Connect Test Fixture

Connect the test fixture to the UNKNOWN terminals as follows:

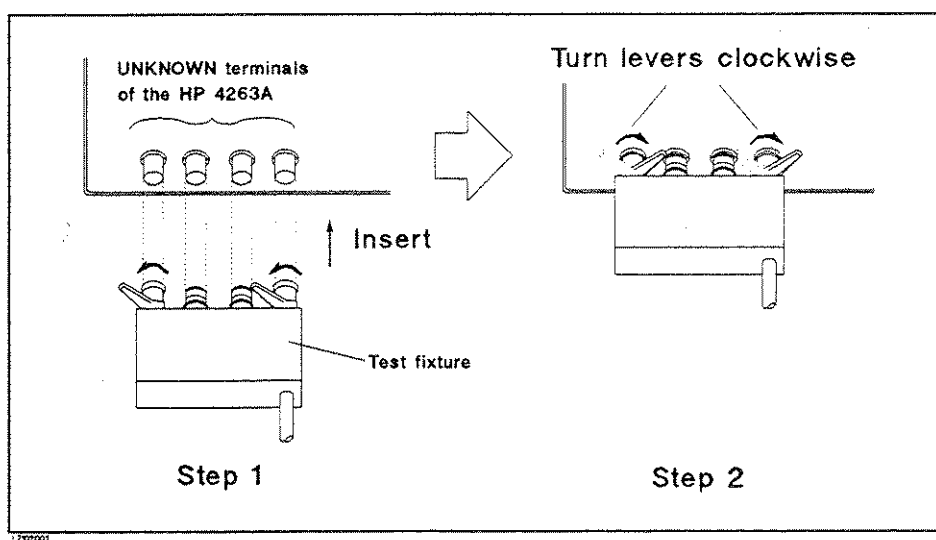

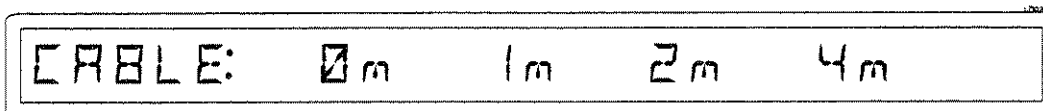

Figure 2-2. Connecting a Test Fixture



See information on available test fixtures, “Accessories Available” later in this chapter.

## To Set Cable Length—Canceling the Phase Shift Error

1. Press  . Cable lengths 0 m, 1 m, 2 m, and 4 m will be displayed.









The blinking cable length is the current setting.

2. Select the desired cable length using  or . To determine which length you should select, see “Accessories Available” later in this chapter.
3. Press .

## To Select Measurement Parameter

1. Press . Measurement parameters are displayed. For example, page 3/8 is displayed as follows (For all pages, see “Measurement Parameters” later in this chapter). The blinking parameter is the parameter currently selected.



2. Press  or  (or  ) until the desired parameter page is displayed.
3. Press  until the desired parameter is selected (blinking).
4. Press .

## To Set Test Frequency

Press  until the **Frequency (Hz)** annunciator points to the desired test frequency.

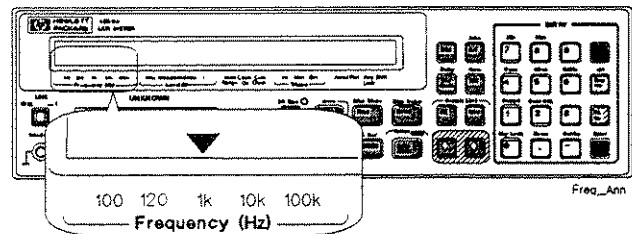



Note that the 10 kHz test frequency is not available when the cable length setting is 4 m, and the 100 kHz test frequency is not available when the cable length setting is 2 m or 4 m.

## To Set Test Level

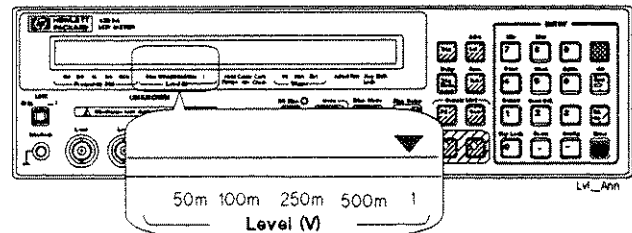
Press  until the **Level (V)** annunciator points to the desired test signal level.



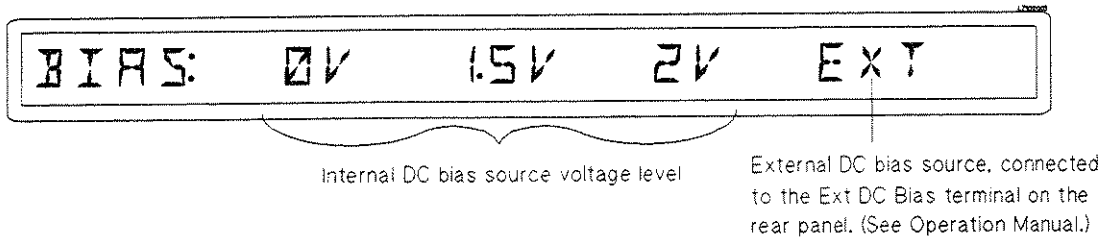

## To Set DC Bias Source Voltage

1. Press  . The available DC bias source voltage selections will be displayed.



The blinking item is the current setting.

2. Select the desired DC bias voltage value using  or , and press .



Now the DC bias source is selected. For how to apply the DC bias voltage, see “To Apply DC Bias”, later in this chapter.

## To Select Measurement Time Mode

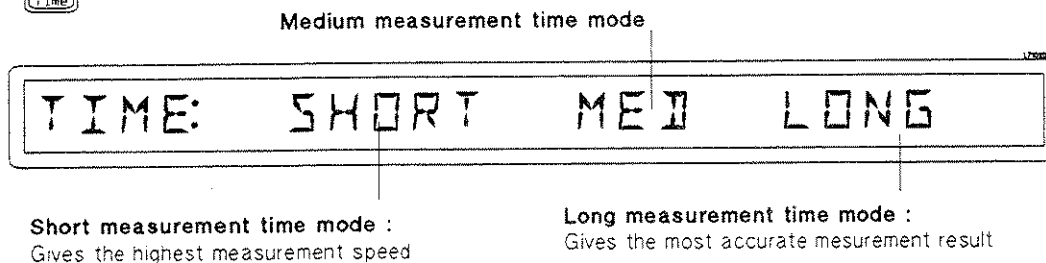
1. Press .







The blinking item is the current setting.

2. Select the measurement time mode using  or .
3. Press  to set the mode and to exit.

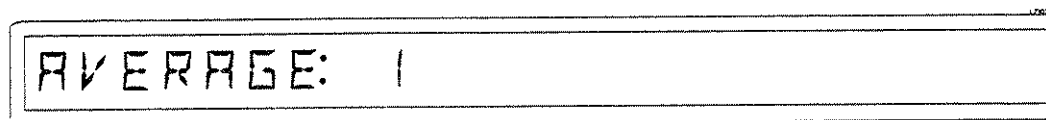
## To Set Averaging Rate

1. Press  .



2. Enter the averaging rate using the numeric ENTRY keys. (For example, to enter 4, press .) You can enter integer values from 1 to 256. Also, you can increase or decrease the value using  or .
3. Press  to set the value and to exit.

## To Select Measurement Range

### Auto Range mode

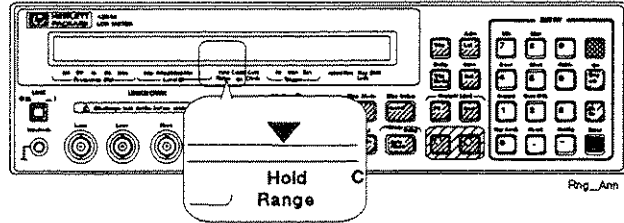

#### —Automatically Selecting the Optimum Measurement Range

Press . The **Hold Range** annunciator turns OFF.





### Hold Range mode—Selecting the Measurement Range of Your Choice

To select the measurement range:

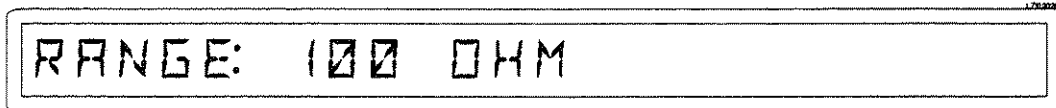

1. Press  . The measurement range setup menu is displayed.



2. Press  or  until the desired range is displayed. Or, input the impedance value to be measured using the numeric ENTRY keys, and the HP 4263A will select the optimum measurement range setting.
3. Press . The **Hold Range** annunciator turns ON.

#### Note



While a measurement is in progress, only pressing  or  increases or decreases the measurement range setting.

The available ranges are 0.1  $\Omega$ , 1  $\Omega$ , 10  $\Omega$ , 100  $\Omega$ , 1 k $\Omega$ , 10 k $\Omega$ , 100 k $\Omega$ , and 1 M $\Omega$ . To determine which measurement range you should select, see “Measurement Range Setting” later in this chapter.

## To Select Trigger Mode

Press  until the Trigger annunciator points to the desired trigger mode.

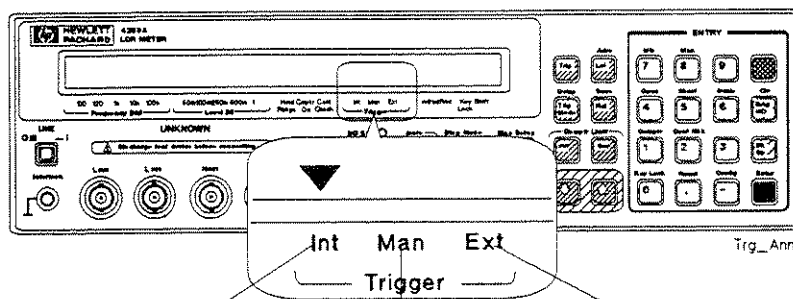

**Internal trigger source mode :**  
Free running measurement

**Manual Trigger mode :**  
Trigger a measurement manually



**External trigger source mode :**  
Trigger a measurement by external signal input (from an external trigger source, a handler interface, or the HP 16064B.)

To trigger a measurement in each mode, see "To Trigger a Measurement" later in this chapter.

## To Set Trigger Delay Time

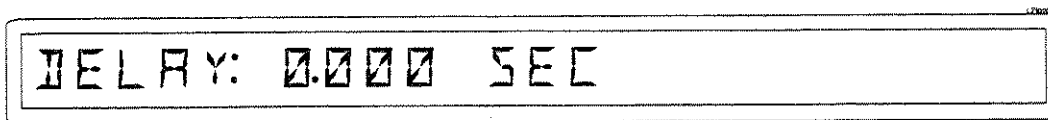
1. Press  .





2. Enter the desired trigger delay time using the numeric ENTRY keys. (For example, to set 0.5 sec, press    .) You can set the trigger delay time from 0 sec to 9.999 sec.

3. Press  to set the value and to exit.

---

## To Perform OPEN Correction —Canceling the stray admittance in parallel with the DUT

1. Confirm that the test fixture is connected to the UNKNOWN terminals without a DUT connected.
2. Press   . The following message is displayed.



OPEN CORRECTION

After a while, the HP 4263A will display the OPEN correction finished message,





CORR: COMPLETE

and return to measurement mode.

If “OUT OF LIMIT”, a WARNING message, is displayed, the OPEN admittance is so high that it would be unsuitable for OPEN correction data. This is only a WARNING, the OPEN correction data will still be used. However, you must verify the test fixture connection to the UNKNOWN terminals and the procedure used to perform the OPEN correction.

---

## To Perform SHORT Correction —Canceling the residual impedance in series with the DUT

1. Configure the test electrodes in a SHORT configuration by connecting the High and Low electrodes to each other or by connecting a shorting bar to the test fixture.
2. Press   . The following message is displayed.



SHORT CORRECTION

After a while, the HP 4263A will display the SHORT correction finished message,





CORR: COMPLETE

and return to measurement mode.

If “OUT OF LIMIT”, a WARNING message, is displayed, the SHORT impedance is so high that it would be unsuitable for SHORT correction data. This is only a WARNING, the SHORT correction data will still be used. However, you must verify the test fixture connection to the UNKNOWN terminals and the procedure used to perform the SHORT correction.



## To Use the Comparator Function

### Setting the Limit Values

1. Press  or  to select the parameter to set.

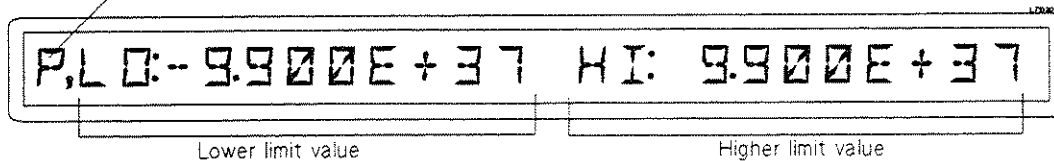

*P* or *S* stands for primary or secondary parameter.



2. A blinking L0: shows that you can enter the lower limit value. Enter the value using the numeric ENTRY keys, then press  to enter the value. You can set the value from  $-9.900 \times 10^{37}$  to  $9.900 \times 10^{37}$ .
3. A blinking HI: shows that you can enter the higher limit value. Enter the value using the numeric ENTRY keys, then press  to enter the value and to exit. You can set the value from  $-9.900 \times 10^{37}$  to  $9.900 \times 10^{37}$ .

### Sorting

To start sorting,

Press  . The **Comptr On** annunciator turns ON.

To abort sorting,

Press  . The **Comptr On** annunciator turns OFF.

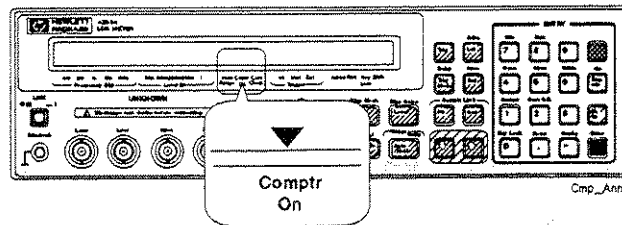

The sorting results are HIGH, IN, and LOW.

Where,

HIGH      greater than the higher limit  
 IN        between the higher and lower limits  
 LOW      less than the lower limit

The HP 4263A shows the comparison results using the display, beeper, printer, and HP 16064B LED Display/Trigger Box.

- For result output to the display, see “To Select Display Mode” later in this chapter.
- For result output to the beeper, see “To Select Beeper Mode” later in this chapter.
- For result output to the printer, see “To Set Printer—Printing the measurement data” later in this chapter.
- For result output to the HP 16064B, see “Accessories Available” later in this chapter.



## To Use the Contact Check Function —Monitoring the connection of test electrodes and DUT

To enable the contact check function,

Press   , and the

Cont Chk annunciator turns ON.

To abort the contact check function,

Press   , and the Cont Chk annunciator turns OFF.

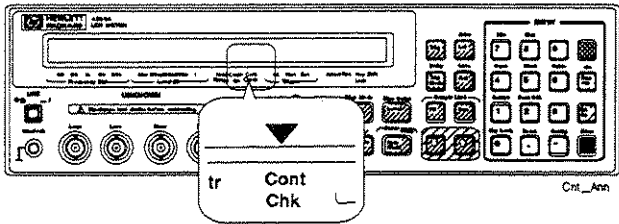

When the contact check failed, the HP 4263A displays N.C. (No-Contact).

The OPEN/SHORT correction must be performed correctly for a valid contact check.



## To Use the Deviation Measurement Function

### Setting the Deviation Reference Values

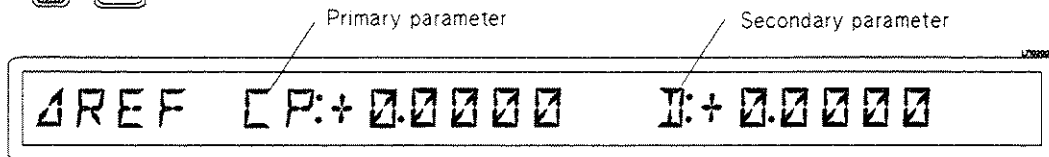
1. Press   .



The blinking parameter is a prompt to enter the reference value.



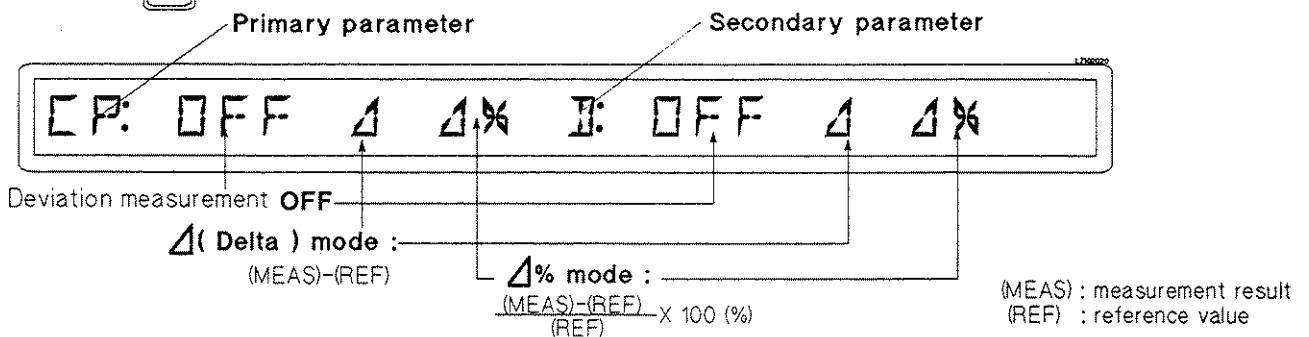

2. Select the parameter to enter using  and .
3. Enter the numeric value using the numeric ENTRY keys.
4. Press  to enter the value and to exit.

### Selecting the Deviation Mode

1. Press  .





The blinking parameter is a prompt to select the mode.

2. Select the parameter using  and .
3. Select the deviation mode using  and press .

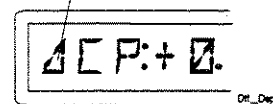
Δ is displayed in the deviation measurement mode.



## To Select Display Mode

Press   until the desired display is displayed. The following modes are available.

- The Measurement Display mode shows the measurement data:

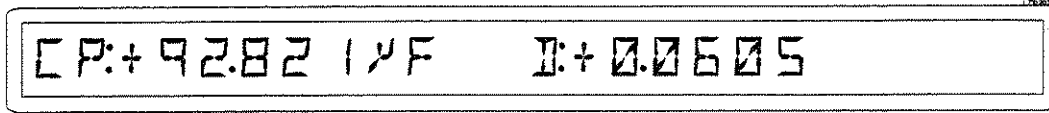

- The Comparison Display mode shows the comparison results:

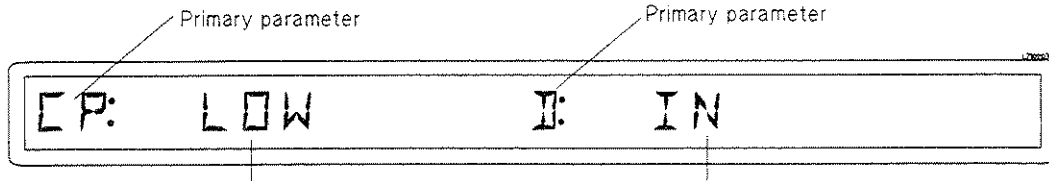

OFF : Comparator is OFF.      IN : Between higher limit and lower limit.  
 HIGH : Greater than higher limit.      LOW : Less than lower limit.

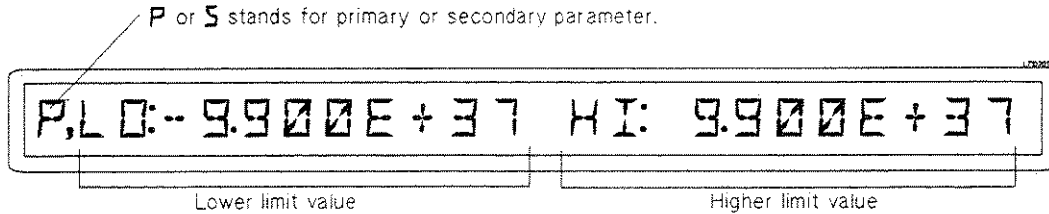

- The Limit Table modes (two modes: one for the primary parameter and another for the secondary parameter) shows the comparator limits:



- The Display OFF mode shows the annunciators only.

## To Select Beeper Mode



To change the beeper mode for the comparator result reporting:

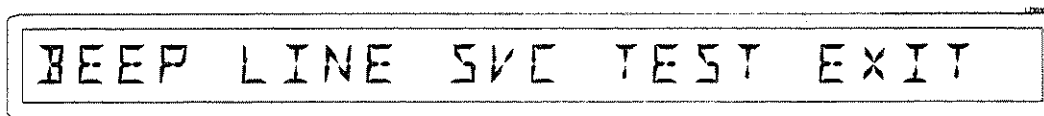

1. Press  .

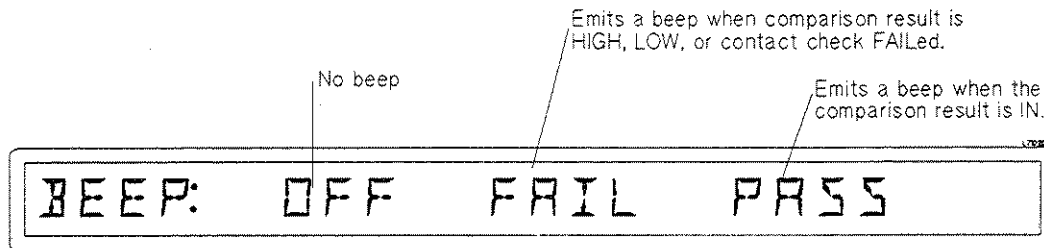

2. Select BEEP using  or  and press  to select.



3. Select the beep mode using  or , and press  to exit to the previous display.

4. Select EXIT using  or , and press  to exit.

## To Set Printer—Printing the measurement data

1. Use an HP-IB compatible printer, set to the listen-always mode.
2. Connect the printer to the HP 4263A's HP-IB port on the rear panel.
3. Turn the printer ON.
4. Set the HP 4263A to talk only mode (Set the HP 4263A's HP-IB address to 31).

a. Press    

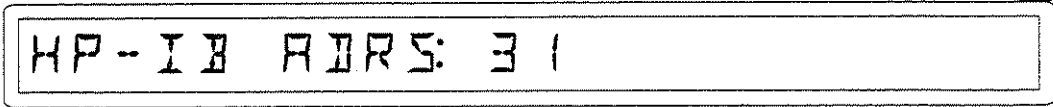

b. Press . The Adrsd annunciator turns ON and the printer begins printing the measurement data.

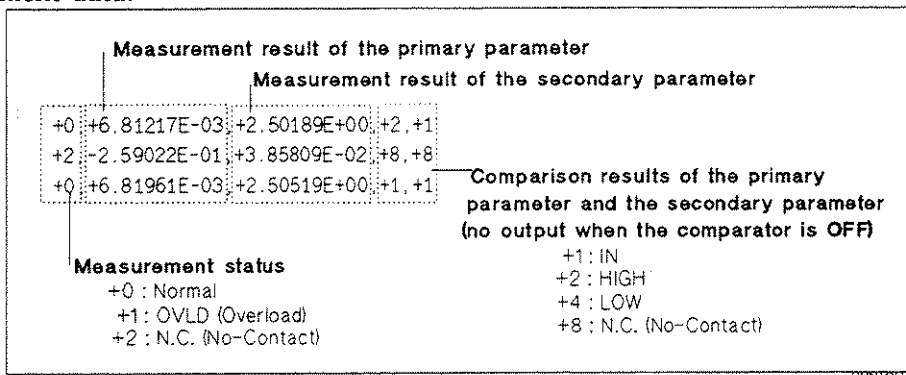

Figure 2-3. Printer Output

When you want to disable printing, change the HP-IB address to an address other than 31 (for example, 17, which is the default setting).

Press     

## To Connect DUT

Connect the DUT to the test electrodes.

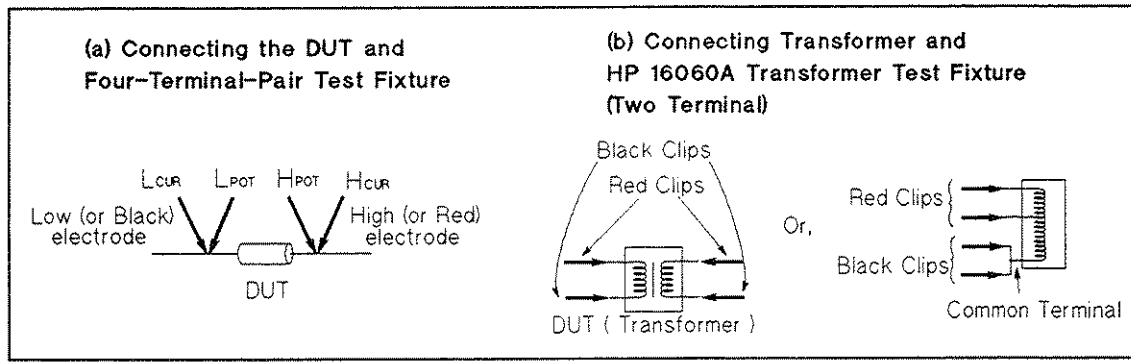



Figure 2-4. Connecting the DUT

## To Apply DC Bias

Press  to apply the DC bias.

The DC Bias ON/OFF indicator is ON.

(Press  again to turn OFF the DC bias.)

The DC Bias ON/OFF indicator is OFF.)

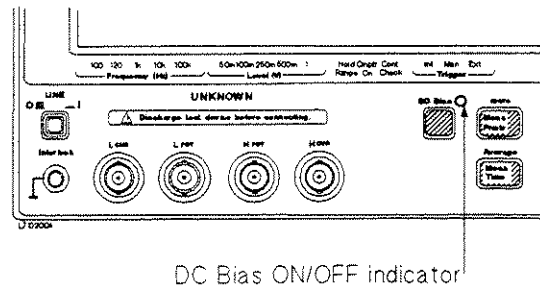





## To Trigger a Measurement



- In internal trigger mode—The HP 4263A makes continuous free-running measurements.
- In manual trigger mode—Press  when you want to trigger a measurement.
- In external trigger mode— Connect the external trigger source to the EXT TRIGGER terminal on the HP 4263A's rear panel, and apply a TTL level trigger signal to trigger a measurement. (For details, see Operation Manual.)  
Note that it must be set to the external trigger mode to trigger from an external handler or the HP 16064B LED Display/Trigger Box.

## If You Have a Problem

If any of the problems listed below occur, follow the instructions described.

- If you find yourself lost when operating the HP 4263A, you can get back on track by:
  - To return to the measurement mode, press  several times.
  - To return to the default settings, press  . (If the reset not accepted, confirm that the **key Lock** annunciator is turned ON. See next.)
- If the HP 4263A does not accept key input:
  - Check whether or not the **Key Lock** annunciator is ON. If so,
    - Press  . The **Key Lock** annunciator turns OFF and the front-panel keys are unlocked.
    - Check that the HP 16064B LED display/trigger box is connected to the HP 4263A and it is set to lock out the keys. If so, unlock the keys from the HP 16064B.
- If the HP 4263A displays annunciators only:
 

The display mode is set to the Display OFF mode.

  1. If the HP 4263A is in the key lockout mode, cancel the key lockout mode. (See previous description.)
  2. Press   to change the display mode to a mode other than Display OFF.
- If ----- or OVLD is displayed:
 

The measurement result is out of the measurable range. Check the DUT and make sure the measurement range is properly set.

## Reference

### Default Settings

- Frequency : 1 kHz
- Test voltage level : 1 Vrms
- DC Bias : OFF
- DC Bias source : 0 V
- Measurement parameter : Cp-D
- Deviation measurement : OFF
- Measurement range : Auto
- Measurement time : MEdium
- Averaging rate : 1
- Trigger mode : Internal
- Trigger delay : 0 ms
- Comparator : OFF
- Contact check : OFF
- Display mode : Measurement mode
- Beep mode : FAIL mode
- Cable length : 0 m
- OPEN/SHORT correction data is cleared

### Measurement Parameters

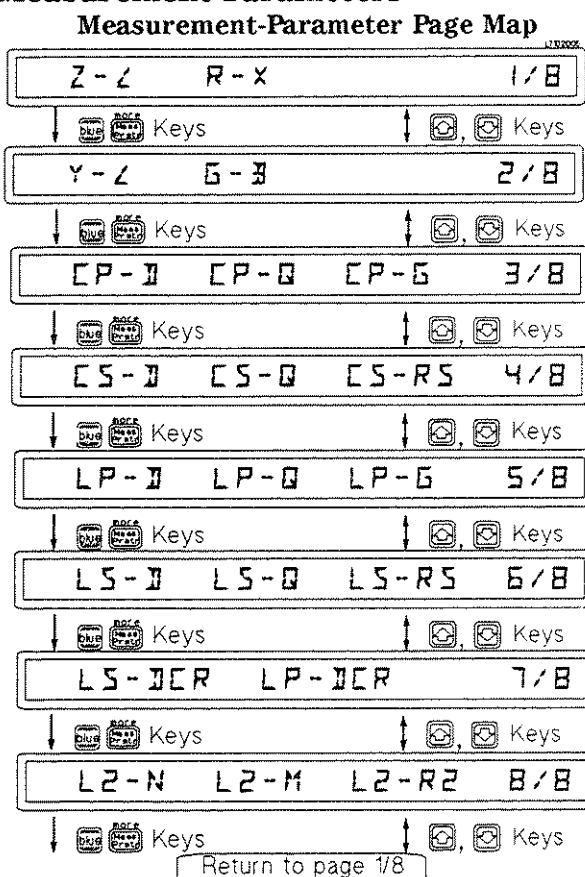

### Measurement Parameters

- Z : impedance ( absolute value )
- Y : admittance ( absolute value )
- ∠ : phase angle
- R : resistance
- LS : equivalent series inductance
- LP : equivalent parallel inductance
- CS : equivalent series capacitance
- CP : equivalent parallel capacitance
- Q : quality factor
- D : dissipation Factor
- G : conductance
- B : susceptance
- X : reactance
- DCR : dc resistance
- N : turns ratio of transformer<sup>1</sup>
- M : mutual inductance<sup>1</sup>
- L2 : inductance<sup>1</sup>
- R2 : dc resistance<sup>1</sup>

<sup>1</sup> This parameter is measured using the transformer measurement configuration (two-terminal measurement configuration).

### Note



The measurement parameters on pages 7/8 and 8/8 are available only with Option 001 ( Add N/M/DCR Measurement Function ). If your HP 4263A is not equipped with Option 001, you cannot access these pages, and your HP 4263A will only display a total of 6 pages, from 1/6 to 6/6. To measure the parameters in page 8/8, the transformer measurement configuration is required. So use the HP 16060A Transformer Test Fixture.

### Accessories Available

#### HP 16064B LED Display/Trigger Box

The HP 16064B LED Display/Trigger Box triggers a measurement when its trigger key is pressed, and displays the contact check and comparison results using LEDs. It allows you to manually operate the comparator function of the HP 4263A.

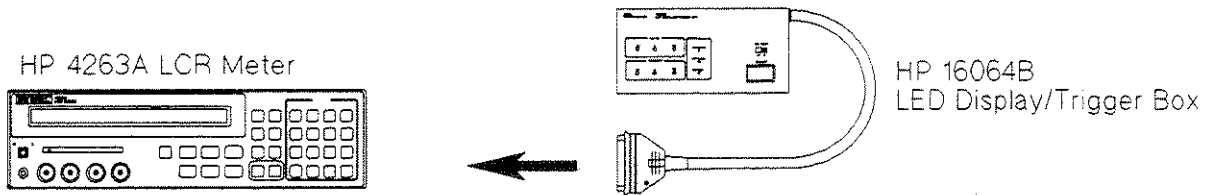

Connect to the Handler Interface connector on the rear panel.

#### Test Fixtures and Test Leads

For measurement versatility, various types of test fixtures and test leads are available for the HP 4263A. When using these test fixtures and test leads, set the HP 4263A to the corresponding cable length of the test fixture or test leads being used.

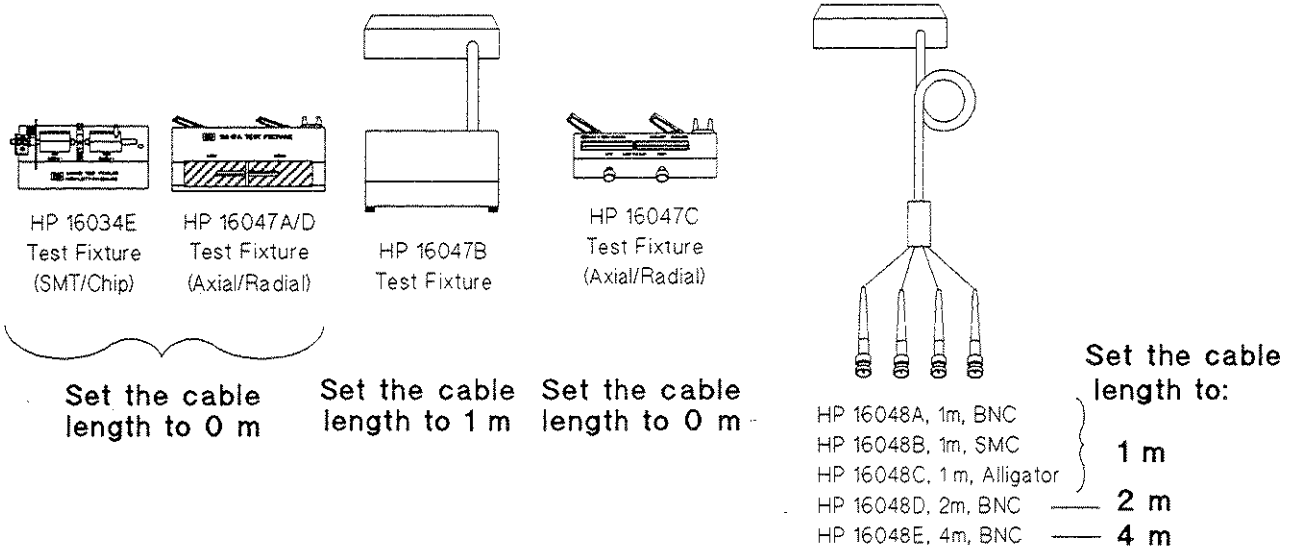

**HP 4263A**

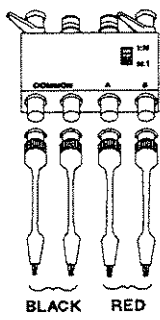

HP 16060A  
Transformer  
Test Fixture

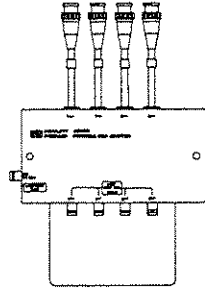

HP 16065C  
External  
Bias Adapter

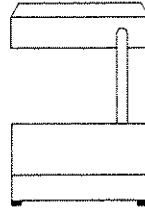

HP 16065A  
EXT Voltage  
Bias Fixture

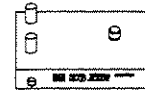

HP 16085B  
Terminal Adapter  
(4TP to APC 7)

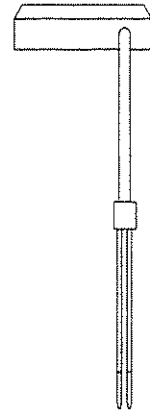

HP 16334A  
Test Fixture  
(Tweezer)

Set the cable length to 0 m

Set the cable length to 1 m

Set the cable length to 0 m

Set the cable length to 1 m

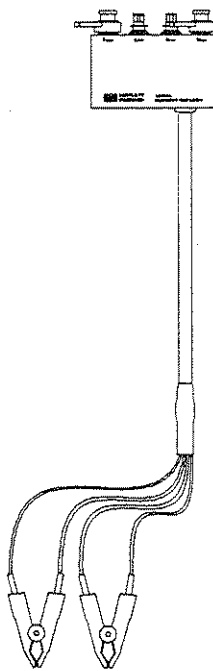

HP 16089A  
Kelvin Clip Leads  
Large clip, 1 m length

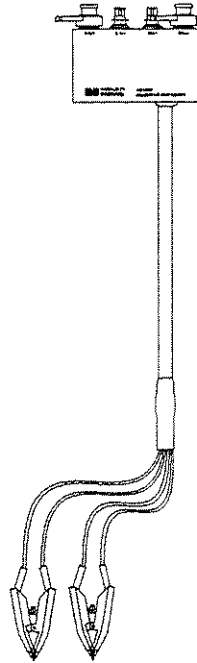

HP 16089B  
Kelvin Clip Meads  
Medium chip, 1 m length

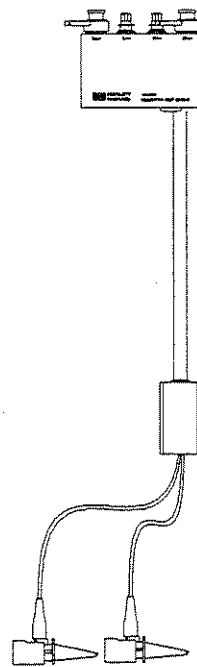

HP 16089C  
Kelvin IC Clip Leads  
IC Package clip, 1 m length

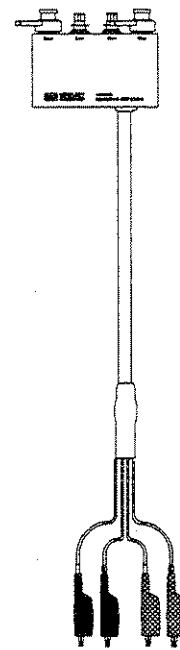

HP 16089D  
Alligator Clip Leads  
Four clips, 1 m length

Set the cable length to 1 m

## Measurement Range Setting

Range Setting	Optimum Measurement Range
0.1 $\Omega^1$	$ Z  \leq 100 \text{ m}\Omega$
1 $\Omega$	$100 \text{ m}\Omega <  Z  \leq 1 \Omega$
10 $\Omega$	$1 \Omega <  Z  \leq 10 \Omega$
100 $\Omega$	$10 \Omega <  Z  < 1 \text{ k}\Omega$
1 $\text{k}\Omega$	$1 \text{ k}\Omega \leq  Z  < 10 \text{ k}\Omega$
10 $\text{k}\Omega$	$10 \text{ k}\Omega \leq  Z  < 100 \text{ k}\Omega$
100 $\text{k}\Omega^2$	$100 \text{ k}\Omega \leq  Z  < 1 \text{ M}\Omega$
1 $\text{M}\Omega^2$	$1 \text{ M}\Omega \leq  Z  < 10 \text{ M}\Omega$

<sup>1</sup> This range is available with test level settings of 1 Vrms and 500 mVrms.

<sup>2</sup> This range is not available for the 100 kHz test frequency setting.

---

## Other Topics

For details on these functions, see the *Operation Manual*.

- Initial Inspection — Chapter 1 of the *Operation Manual*
- Key Lock Function — Chapter 2 and Chapter 3 of the *Operation Manual*
- HP-IB — Chapter 4 and Chapter 5 of the *Operation Manual*
- Load correction (HP-IB Only) — Chapter 4 and Chapter 5 of the *Operation Manual*
- Handler Interface — Chapter 3, Chapter 6, and Appendix B of the *Operation Manual*
- Save / Recall — Chapter 2 and Chapter 3 of the *Operation Manual*
- Backup Function — Chapter 3 of the *Operation Manual*
- Specification — Chapter 8 of the *Operation Manual*
- Maintenance — Chapter 9 of the *Operation Manual*
- Error Messages — “Error Messages” in back of the *Operation Manual*



## Measurement Examples

### In This Chapter

The HP 4263A's features and benefits are discussed, and which you can investigate by trying the typical measurement examples described in this chapter.

### HP 4263A Features and Benefits

HP 4263A LCR Meter is a general purpose LCR meter, 0.1% basic accuracy, designed for both component evaluation production line, and fundamental impedance testing for bench-top applications.

#### Fast test system throughput

- High speed measurement: 25 ms
- High speed contact check: 5 ms
- Quick test recovery
- Front-end protection
- Built-in comparator
- Handler-interface
- HP-IB interface
- Cable Length Setting—0, 1, 2, and 4 meters

#### Versatile measurement

- 11 impedance parameters
- 100, 120, 1 k, 10 k, and 100 kHz test frequencies
- 50 m, 100 m, 250 m, 500 m, and 1 Vrms test levels
- Wide capacitance test range
- Transformer parameter (N/M/DCR) measurements (Option 001)

### Test System Configuration on the Production Line

The HP 4263A's handler interface outputs signals to indicate measurement completed, contact check judgment, and PASS/FAIL judgments of the comparator function. The handler interface has an input for an external trigger signal and a keylock signal. Using these signals, the HP 4263A can easily be combined with a component handler and a system controller to fully automate component testing, sorting, and quality control data processing to increase production efficiency.

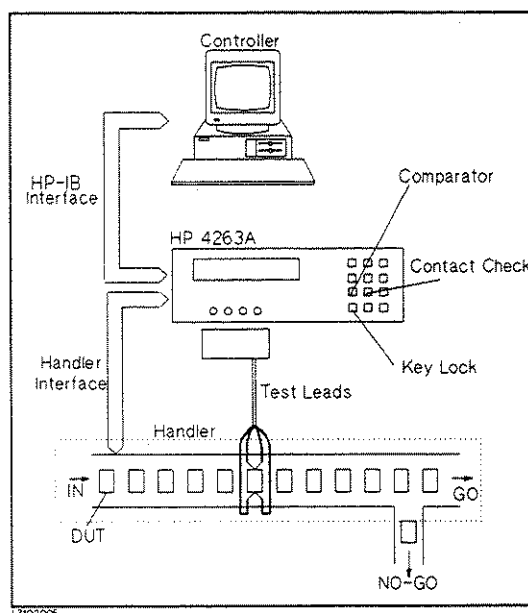

## Electrolytic Capacitor Measurement—For High Capacitance

The HP 4263A's measurement accuracy and wide measurement range are the right tools to make precise measurements of electrolytic capacitor parameters.

Electrolytic capacitors are generally high capacitance, so their impedance is low. The HP 4263A has a 100 mΩ measurement range, and keeps its high measurement accuracy when measuring low impedance. For example, the HP 4263A measures an aluminium electrolytic capacitor, 22,000 μF, at a test frequency of 120 Hz, with about 0.5 % accuracy. You can try this measurement using the following procedure.

Generally, charged capacitors discharge through the front end input circuit and may destroy an instrument. The HP 4263A's front end is designed for protection and maintains test integrity.

### DUT

Aluminium electrolytic capacitor ( 22,000 μF ± 20 % )

### Requirements

Test Fixture : HP 16089B Kelvin Clip Leads

### Measurement Setup

Measurement parameter : Cs-D<sup>1</sup>  
 Test frequency : 120 Hz  
 Test signal level : 1 Vrms

<sup>1</sup> For high capacitance measurement, equivalent series parameter Cs-D is commonly used.

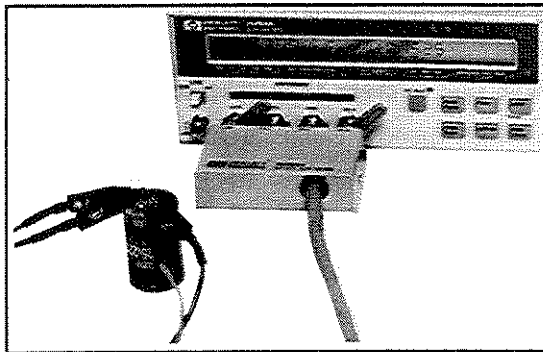

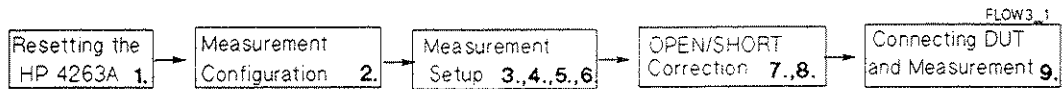

### Measurement Procedure

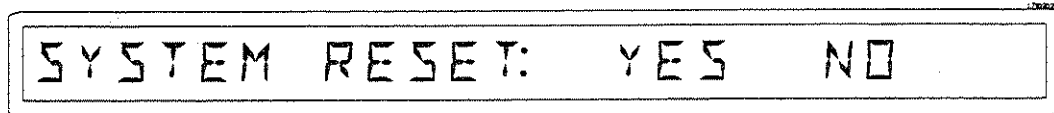

1. Reset the HP 4263A.

a. Press   .



b. Press  until YES blinks, and press  .

2. Connect test fixture to the UNKNOWN terminals as follows.

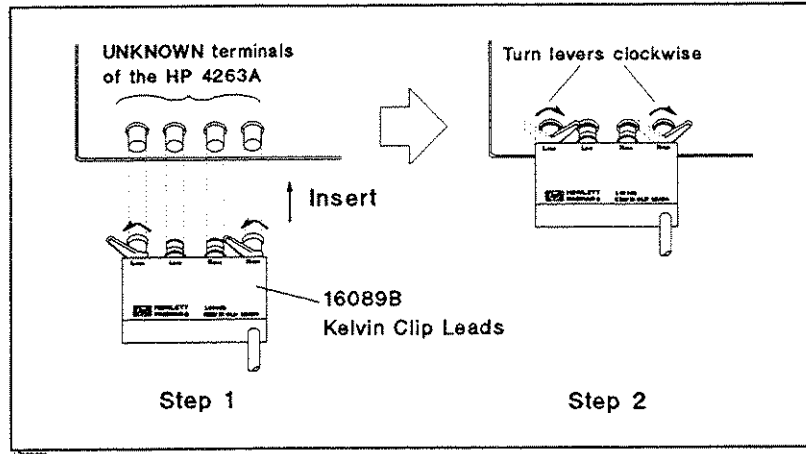

3. Set the cable length to 1 m.

a. Press .

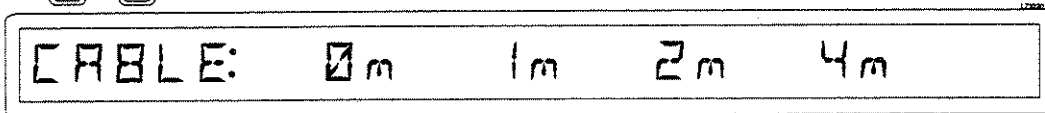

b. Press and until 1m is selected and press .

4. Set measurement parameter to Cs-D.

a. Press and the following is displayed.

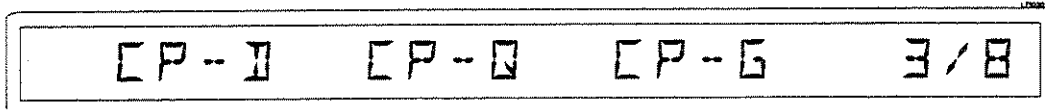

b. Press and until CS-D is displayed.

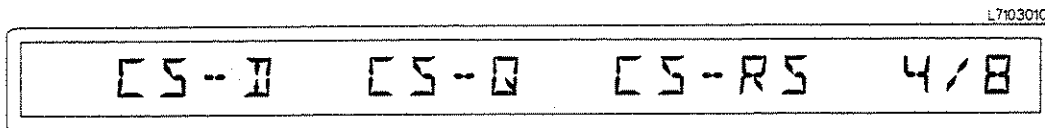

The blinking parameter is currently selected.

c. Select CS-D using and press .

5. Set the test frequency to 120 Hz.

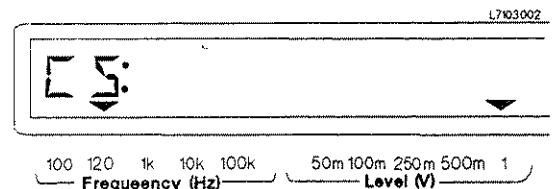

Press until the **Frequency (Hz)** annunciator points to 120 Hz.



6. Set the test voltage to 1 V.

Press until the **Level (V)** annunciator points to 1 V.

7. Perform an OPEN correction.

- a. Separate the test lead clips ( Nothing must be connected to the test lead clips).
- b. Press   .

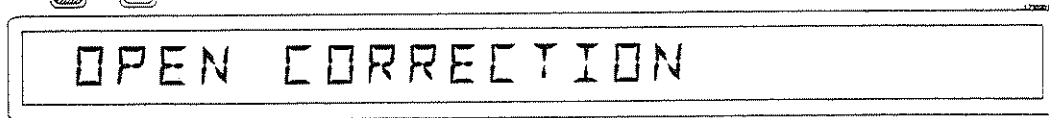

After a while, CORR: COMPLETE will be displayed, then the OPEN correction is completed. (If OUT OF LIMIT is displayed, see "To Perform OPEN Correction —Canceling the stray admittance in parallel with the DUT" in Chapter 2.)

8. Perform a SHORT correction.

- a. Short the test lead clips together as shown in the following figure:

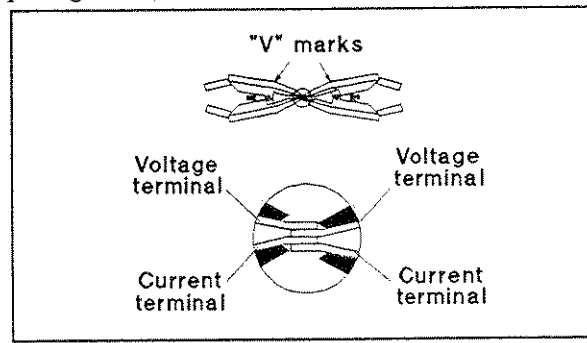

- b. Press   .

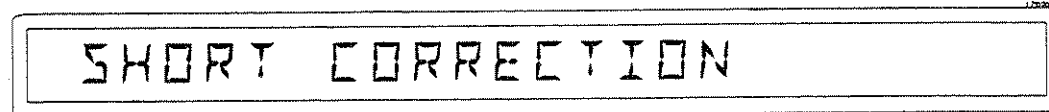

After a while, CORR: COMPLETE will be displayed, then the SHORT correction is completed. (If OUT OF LIMIT is displayed, see "To Perform SHORT Correction —Canceling the residual impedance in series with the DUT" in Chapter 2.)

9. Connect the DUT to the test fixture and the measurement result will be displayed.

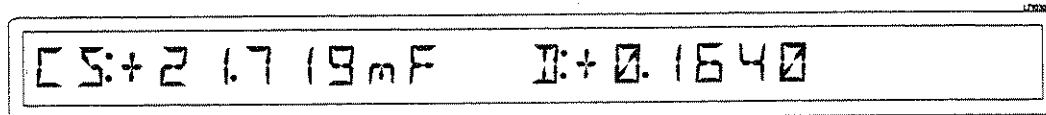

**For More Information**

- To apply DC bias — See "To Set DC Bias Source Voltage" in Chapter 2.
- To print out the measurement result — See "To Set Printer—Printing the measurement data" in Chapter 2

## Inductor Measurement—Versatile measurement parameters

The HP 4263A offers 11 measurement parameters for LCR measurement. In addition to these parameters, Option 001 adds ability to make turns ratio (N), mutual inductance (M), dc resistance (DCR) measurements.

This example shows a basic measurement for an inductor, and its DCR. You can measure both inductance and DCR without resetting the measurement configuration.

### DUT

Inductor ( 220  $\mu$ H  $\pm$  5 % @ 100 kHz )

### Requirements

Test Fixture : HP 16047A

### Measurement Setup

Measurement parameter : Lp-Q and Lp-DCR  
 Test frequency : 100 kHz  
 Test signal level : 100 mVrms



### Measurement Procedure

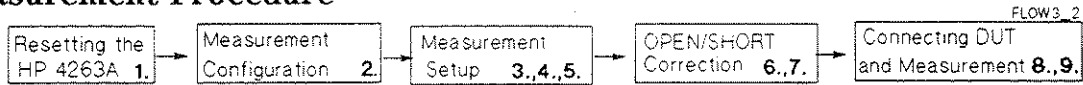

1. Reset the HP 4263A.

a. Press .

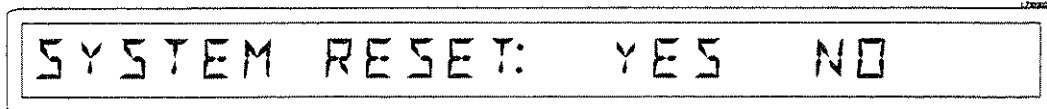

b. Press until YES blinks, and press .

2. Connect the test fixture to the UNKNOWN terminals.

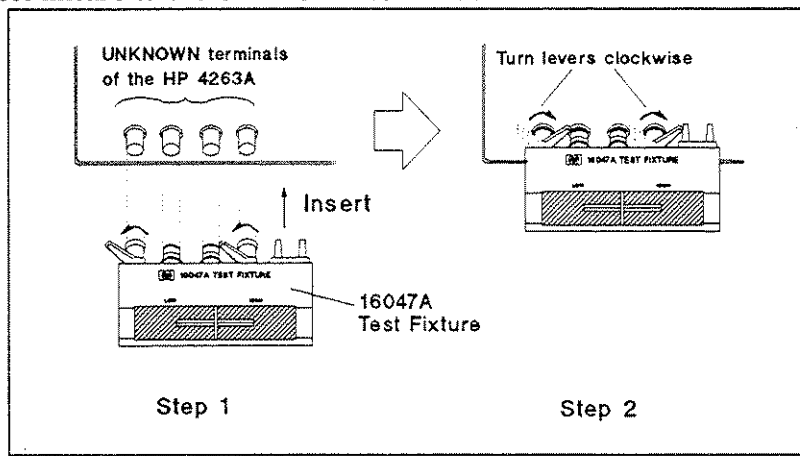

3. Select measurement parameter Lp-Q.

- a. Press  and the following is displayed.



- b. Press  and  until LP-Q is displayed.



The blinking parameter is currently selected.

- c. Select LP-Q using  and press .

4. Set the test frequency to 100 kHz.

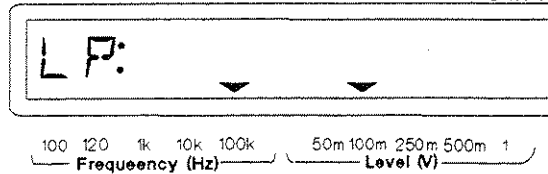

- Press  until the **Frequency (Hz)** annunciator indicate 100 kHz.



5. Set the test voltage to 100 mVrms.

- Press  until the **Level (V)** annunciator indicates 100 mV.

6. Perform an OPEN correction.

- a. Remove any device inserted in the test electrodes to create an OPEN condition ( Nothing should be connected to the test electrodes).
- b. Press  .

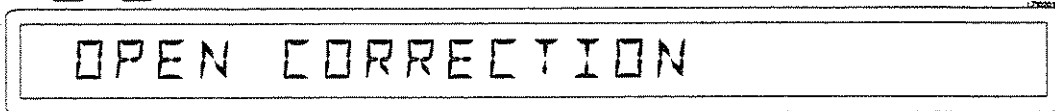

After a while, CORR: COMPLETE will be displayed, then the OPEN correction is completed. (If OUT OF LIMIT is displayed, see "To Perform OPEN Correction –Canceling the stray admittance in parallel with the DUT" in Chapter 2.)

7. Perform a SHORT correction.

- a. SHORT the test electrodes together. (Connecting a shorting device to the test fixture as shown in the following figure).

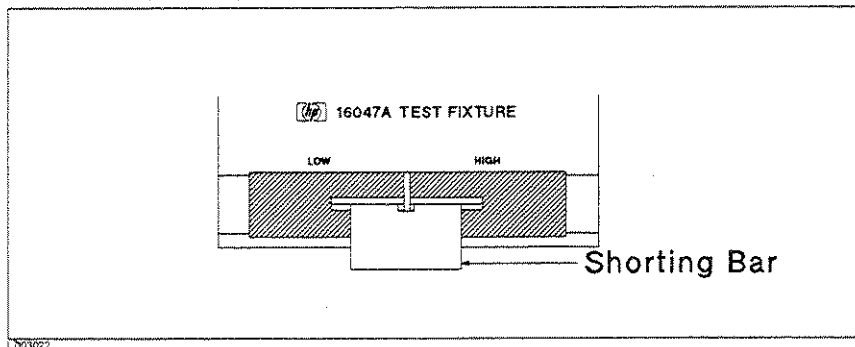

- b. Press  .

SHORT CORRECTION

After a while, CORR: COMPLETE will be displayed, when the SHORT correction is completed. (If OUT OF LIMIT is displayed, see “To Perform SHORT Correction –Canceling the residual impedance in series with the DUT” in Chapter 2.)

8. Connect the DUT to the test fixture and the measurement result will be displayed.

LP:+2 16.55  $\mu$ H    Q:    18.6

**Note** Step 9 is for an HP 4263A with Option 001 only.



9. Change the measurement parameter to Lp-DCR.

- a. Press and the following is displayed.

LP-D    LP-Q    LP-G    5/8

- b. Press and until LP-DCR is displayed.

LS-DCR    LP-DCR    7/8

- c. Select LP-DCR using and press . The measurement result will be displayed again.

LP:+2 16.55  $\mu$ H    DCR:+7.0986 OHM

**For More Information**

- To select other measurement parameters – See “To Select Measurement Parameter” in Chapter 2.
- To apply a DC bias – See “To Set DC Bias Source Voltage” in Chapter 2.
- To print out the measurement result – See “To Set Printer—Printing the measurement data” in Chapter 2

## Transformer Measurement (Option 001 Only)

With the HP 4263A's ability to measure turns ratio (N), mutual inductance (M), and dc resistance (DCR), transformer-parameter calculations are no longer time-consuming tasks. Moreover the HP 16060A Transformer Test Fixture makes it easy to setup transformer measurement configurations.

The following example shows how easy it is to measure turns ratio (N), mutual inductance (M), and dc resistance (DCR) measurement of transformer.

### DUT

Transformer ( 1 : 8 )

### Requirements

Test Fixture : HP 16060A Transformer Test Fixture

### Measurement Setup

Measurement parameter : L2-N and L2-R2  
 Test frequency : 100 kHz  
 Test signal level : 100 mVrms

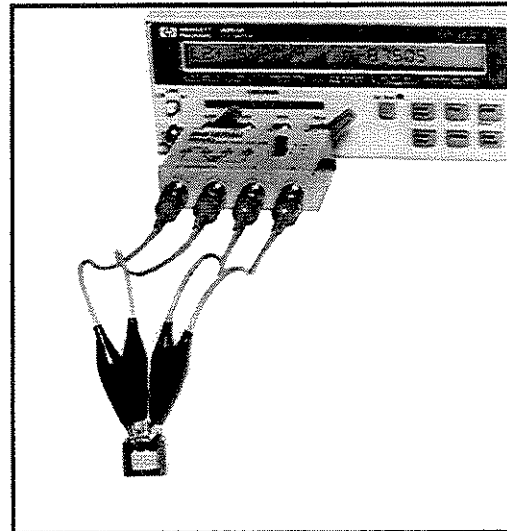

### Measurement Procedure

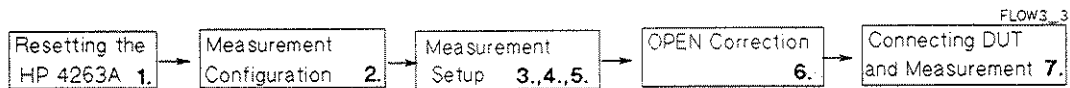

1. Reset the HP 4263A.

a. Press .

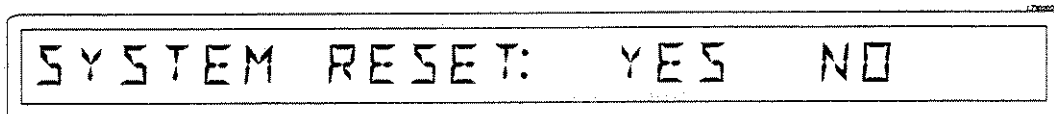

b. Press until YES blinks, and press .

2. Connect the test fixture to the UNKNOWN terminals.

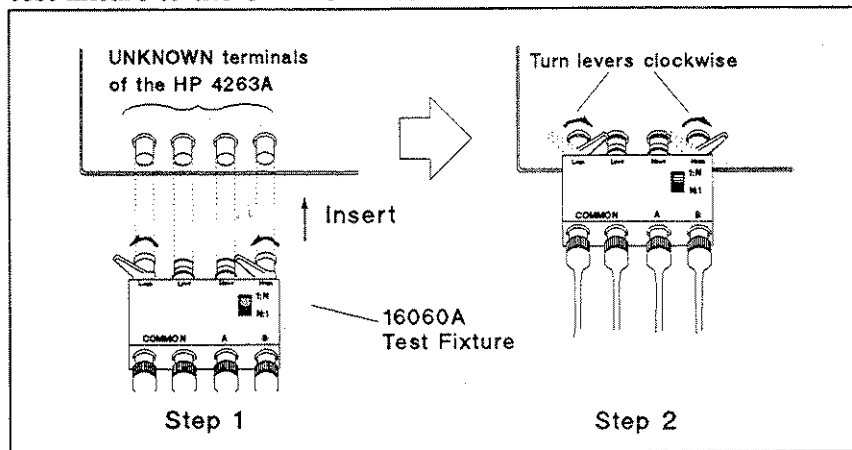



**HP 4263A**

3. Set the measurement parameter to L2-N.

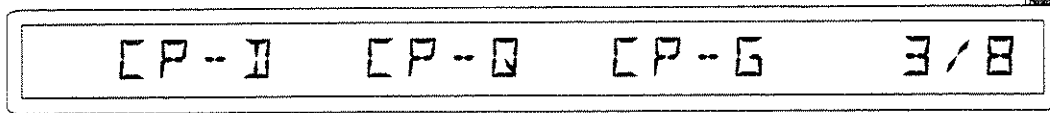

a. Press  and the following is displayed.

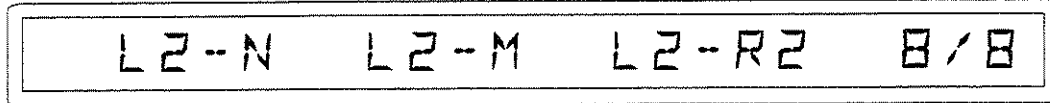

b. Press  and  until L2-N is displayed.



The blinking parameter is currently selected.

c. Select L2-N using  and press .

4. Set the test frequency to 100 kHz.

Press  until the **Frequency (Hz)** annunciator indicate 100 kHz.

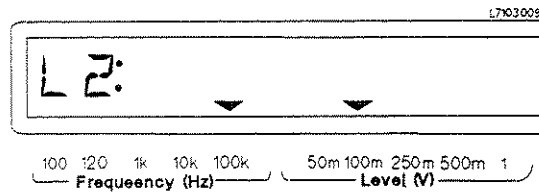

5. Set the test voltage to 100 mVrms.

Press  until the **Level (V)** annunciator indicates 100 mV.

6. Perform an OPEN correction.

a. Short the red clips together and short the black clips together, then separate the shorted red and black sets of clips from each other. ( See the following figure.)

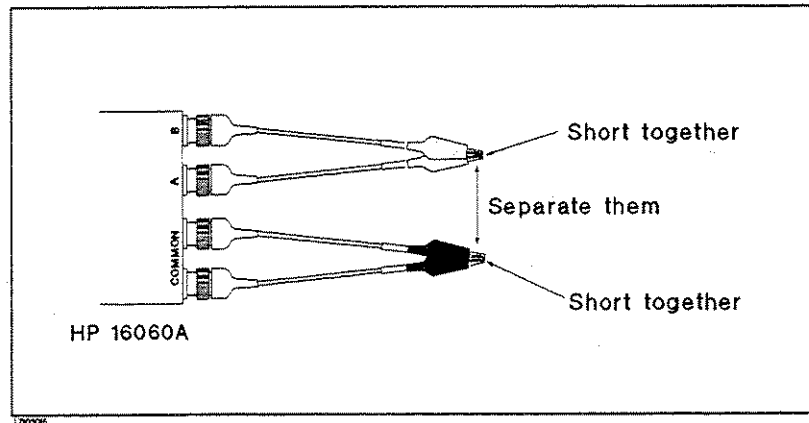

b. Press  .



After a while, CORR: COMPLETE will be displayed when the OPEN correction is completed. (If OUT OF LIMIT is displayed, see "To Perform OPEN Correction —Canceling the stray admittance in parallel with the DUT" in Chapter 2.)

**Note**



Do not perform the SHORT correction of the HP 4263A when the L2-N, L2-M, or L2-R2 measurement parameters are selected.

7. Connect the DUT to the test fixture and the measurement result will be displayed.

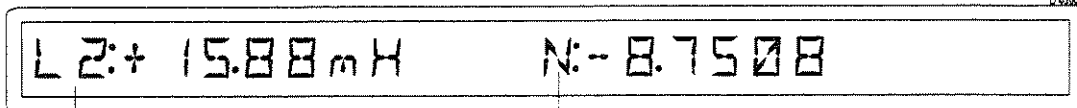
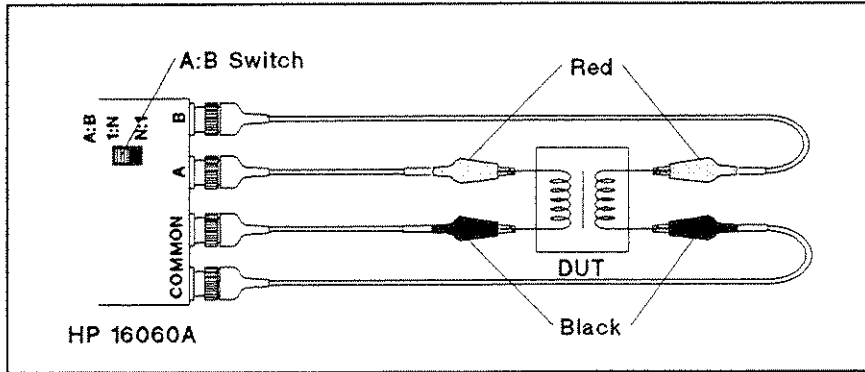

Self inductance of winding connected to:  
 "A" ( when the A:B switch position is N:1 )  
 "B" ( When the A:B switch position is 1:N )

Turns ratio (  $N \geq 0.9$  )  
 "A/B" ( when the A:B switch position is N:1 )  
 "B/A" ( When the A:B switch position is 1:N )

Set the switch to the opposite position if the HP 4263A displays OVLD as the measured value of N. The HP 4263A cannot measure a value of N less than 0.9, and OVLD means that the measurement result is out of range.

Set the switch to the opposite position if the HP 4263A displays OVLD displayed as measurement value of N change the HP 16060A's switch.

The leading sign of N indicates the polarity of transformer as follows:

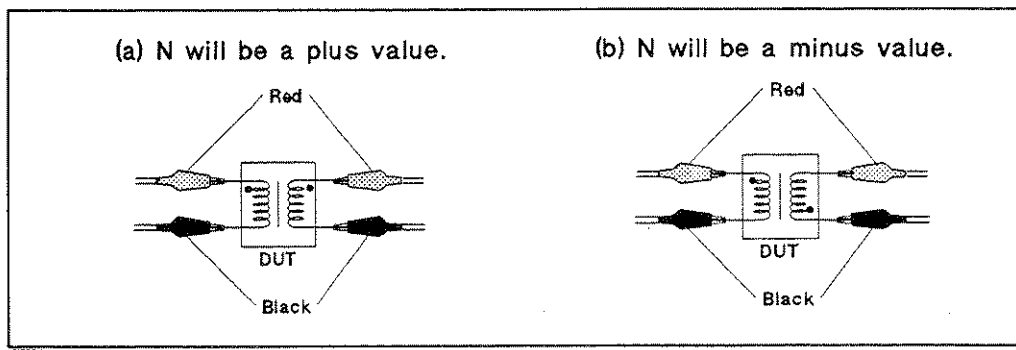

**For More Information**

- To select other parameters — You can measure L2-M (mutual inductance) and L2-R2 (dc resistance) without changing the measurement configuration. To change the measurement parameter, see "To Select Measurement Parameter" in Chapter 2.
- To print out the measurement result — See "To Set Printer—Printing the measurement data" in Chapter 2

## Function Keys

- ON/OFF indicator
-  Toggles DC bias output between ON and OFF. ( page 2-12 )
-  Selects the measurement parameter. ( page 2-3 )
-  Selects the next measurement-parameter page. ( page 2-3 )
-  Selects the test frequency. ( page 2-3 )
-  Selects the display mode. ( page 2-10 )
-  Selects the test signal level. ( page 2-3 )
-  Selects the DC bias source level. ( page 2-4 )
-  Selects the measurement time mode. ( page 2-4 )
-  Sets the averaging rate. ( page 2-4 )
-  Selects the deviation measurement mode. ( page 2-9 )
-  Sets the reference value for deviation measurement. ( page 2-9 )
-  Toggles the measurement range mode between Auto and Hold. ( page 2-5 )
-  Selects the measurement range. ( page 2-5 )
-  Triggers a measurement in the Manual trigger mode. ( page 2-12 )
-  Selects the trigger mode. ( page 2-6 )
-  Sets the trigger delay time. ( page 2-6 )
-  Returns the HP 4263A to the local mode. ( See Operation Manual )
-  Sets the HP-IB address. ( page 2-11 or See Operation Manual )
-  Recalls the instrument settings from internal memory. ( See Operation Manual )
-  Saves the instrument settings to internal memory. ( See Operation Manual )
-  Sets the comparator limit value of primary and secondary parameters. ( page 2-8 )
-  Increases or decreases the setting value. ( See Operation Manual )
-  Retrieves the minimum value. ( See Operation Manual )
-  Retrieves the maximum value. ( See Operation Manual )
-  Executes an OPEN correction. ( page 2-7 )
-  Executes a SHORT correction. ( page 2-7 )
-  Selects the cable length. ( page 2-2 )
-  Toggles the comparator function between ON and OFF. ( page 2-8 )
-  Toggles the contact check function between ON and OFF. ( page 2-9 )
-  Locks out any key input except this key. ( See Operation Manual )
-  Resets the HP 4263A to the default settings. ( page 2-2 )
-  Sets the beeper mode and power LINE frequency, and executes the internal test. ( page 1-2, 2-10 )

## Documentation Map

- *User's Guide* (HP part number 04263-90001) ← This Book  
Is a handy reference to help you to get started using your HP 4263A, basic measurements and commonly used features are explained.
- *Operation Manual* (HP part number 04263-90000, furnished with the HP 4263A)  
Provides information on initial inspection, how to operate the HP 4263A, in-depth reference information, general information, specifications, and maintenance information.
- *Service Manual* (HP part number 04263-90031, Option 0B3 only)  
Explains how to adjust, troubleshoot, and repair the HP 4263A.

---

## In User's Guide

- Chapter 1, Preparation for Use  
For initial turn ON of the HP 4263A
- Chapter 2, Operating the HP 4263A  
Basic measurement operation
  - Getting acquainted with the HP 4263A—for beginners
  - Handy reference for measurement task—for all users
- Chapter 3, Measurement Example  
Measurement Examples for typical HP 4263A applications
  - Capacitor Measurement
  - Inductor Measurement
  - Transformer measurement

In the *User's Guide*, information on the following subjects is not discussed:

- Initial Inspection
- HP-IB remote control
- Using with a Handler
- Maintenance
- Specifications
- Error Messages

For detailed information on these subjects, refer to the *Operation Manual*.



