

HP 4339A High Resistance Meter
User's Guide

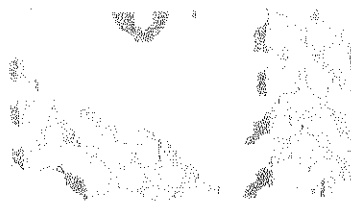

1
2
3
4
5
6
7
8
9
10
11
12
13
14
15
16
17
18
19
20
21
22
23
24
25
26
27
28
29
30
31
32
33
34
35
36
37
38
39
40
41
42
43
44
45
46
47
48
49
50
51
52
53
54
55
56
57
58
59
60
61
62
63
64
65
66
67
68
69
70
71
72
73
74
75
76
77
78
79
80
81
82
83
84
85
86
87
88
89
90
91
92
93
94
95
96
97
98
99
100

WARNING

HIGH VOLTAGE SHOCK HAZARD (MAX. 1000 Vdc)

The HP 4339A High Resistance Meter forces dangerous voltage up to 1000 Vdc on the UNKNOWN terminals, or the electrodes of the accessory (the HP 16008B Resistivity Cell, the HP 16339A Test Fixture, or the HP 16117B,C Test Leads) which is connected to the HP 4339A. (When the High Voltage indicator on the front panel is ON, the HP 4339A outputs dangerous voltage more than 42 Vdc.) To prevent an electrical shock, observe the following safety precautions.

- Operate the HP 4339A and the accessories following the description on their *Operation (and Service) Manuals*, especially for the description written in the Warnings.
- Do *not* touch the UNKNOWN terminal or the electrode, when the V Output indicator on the front panel is ON, that is, when the HP 4339A forces voltage.
- Perform the operation tests of the interlock function and the High Voltage indicator at least once a day, before using the HP 4339A. Refer to "Checking Procedure" in chapter 3 of the *Operation and Service Manual* of the each accessory for the operation tests procedures.
- Warn workers around the HP 4339A about dangerous conditions.

警告

高電圧感電注意 (最大 1000 Vdc)

HP 4339A ハイ・レジスタンス・メータは、UNKNOWN端子、または、HP 4339Aに接続されたアクセサリ (HP 16008Bレジスティビティ・セル、HP 16339Aテスト・フィクスチャ、または、HP 16117B,Cテスト・リード) の電極に危険電圧 (最大 1000 Vdc) を出力することがあります。この危険電圧による感電を避けるために、下記の事項を必ず実施してください。

- ・ HP 4339Aを操作するときには、必ずマニュアルの記述に従ってください。特に、「警告」に書かれていることは必ず守ってください。
- ・ 電圧出力中 (フロント・パネルのV Outputインディケータの点灯中) は、UNKNOWN端子、または、アクセサリの電極に触れないでください。
- ・ 測定に使用するアクセサリを使って、測定開始前に、Interlock機能、High Voltageインディケータの動作テストを行ってください。(1日1回以上) 手順は、各アクセサリのOperating and Service Manualの3章の"Checking Procedure"項を参照してください。
- ・ 周囲の他の作業者に対しても、危険電圧を出力することがあることを知らせ、UNKNOWN端子、または、アクセサリの電極に触れないように注意してください。

AVVERTENZA

PERICOLO DI SCOSSA AD ALTA TENSIONE (MAX. 1000 Vdc)

L'ohmmetro HP 4339A emette pericolosi livelli di tensione che possono raggiungere i 1000 Vdc sui terminali UNKNOWN, o sugli elettrodi degli impianti di prova o cavi di prova (Cella di resistività HP 16008B, Impianto di prova HP 16339A, o Cavi di prova C HP 16117B) che sono collegati all'HP 4339A. (Quando l'indicatore High Voltage sul pannello anteriore è attivato (ON), l'HP 4339A emette tensione elettrica pericolosa (più di 42 Vdc)) Per prevenire una scossa elettrica, osservare le seguenti precauzioni di sicurezza.

- Usare l'HP 4339A e gli accessori secondo le istruzioni dei rispettivi Manuali d'istruzione (e Servizio), specialmente le istruzioni date nelle "Avvertenze".
- Non toccare i terminali UNKNOWN o gli elettrodi quando l'indicatore V Output o il pannello anteriore sono attivati (ON): cioè quando della tensione viene applicata all'uscita dell'HP 4339A.
- Eseguire le prove di funzionamento della funzione Interlock e dell'indicatore High Voltage almeno una volta al giorno, prima di usare l'HP 4339A. Fare riferimento al "Checking Procedure" al capitolo 3 dell'Operation and Service Manual dell'accessorio che si sta usando per le procedure della prova di funzionamento.
- Informare gli operatori che si occupano dell'HP 4339A, delle condizioni di pericolo esistenti e riferire loro ciò che è possibile fare e ciò che non lo è!

WARNUNG

LEBENSGEFÄHRLICHE HOCHSPANNUNG (MAX. 1000 Vdc)

Das Hochwiderstandsmeßgerät HP 4339A gibt eine gefährliche Hochspannung von bis zu 1000 Vdc an den UNKNOWN-Klemmen oder an den Elektroden von Zubehör (z.B. Widerstandszelle HP 16008B, Meßvorrichtungen HP 16339A oder Meßleitungen HP 16117B,C), welche an den HP 4339A angeschlossen sind, ab. (Wenn der Hochspannungsindikator auf der Vorderseite an ist, gibt der HP 4339A eine Spannung von mehr als 42 Vdc ab.) Um elektrische Schläge zu vermeiden, sind folgende Sicherheitsmaßnahmen zu beachten:

- Bedienen Sie den HP 4339A und seine Zubehörteile immer nur unter Einhaltung der Anweisungen in den zugehörigen Bedienungsanleitungen, insbesondere unter Beachtung der darin enthaltenen Warnungen.
- Berühren Sie nicht die UNKNOWN-Klemmen der Elektrode, wenn der V-Output-Indikator an der Vorderseite **aufleuchtet**, d.h., wenn der HP 4339A eine Spannung ausgibt.
- Führen Sie den Funktionstest der Interlock-Funktion und des Hochspannungsindikators wenigstens ein Mal täglich aus, bevor Sie den HP 4339A für Messungen benutzen. Beziehen Sie sich hierzu auf den Abschnitt "Checking Procedure" in Kapitel 3 im *Operation and Service Manual* des jeweiligen Zubehörs.
- Informieren Sie Kollegen/Kolleginnen in der Nähe des HP 4339A über gefährliche Betriebszustände.

AVISO

PELIGRO DE DESCARGA ELECTRICA DE ALTA TENSION (MAX. 1000 V. CC)

El Medidor de Alta Resistencia modelo HP 4339A genera tensiones peligrosas de hasta 1000 V. cc en los terminales UNKNOWN, así como en los electrodos de los accesorios del equipo (la Célula de Resistividad HP 16008B, el Accesorio de Medida HP 16339A, o las Sondas de Prueba HP 16117B,C) conectados al HP 4339A. (Cuando el indicador de "High Voltage" -alta tensión- del panel frontal esté encendido, entonces el HP 4339A producirá unas tensiones peligrosas en sus conectores de salida, con valores superiores a los 42 V. cc). Para evitar las posibles descargas eléctricas, hay que respetar las siguientes medidas de seguridad:

- Manejar el HP 4339A y sus accesorios siguiendo las instrucciones que se indican en los manuales de operación y mantenimiento (*Operation and Service Manuals*), prestando especial atención a las descripciones indicadas en los Avisos correspondientes.
 - No tocar ninguno de los terminales UNKNOWN ni los electrodos, cuando el indicador "V Output" del panel frontal esté encendido, es decir, cuando el HP 4339A esté suministrando tensión en sus bornes.
 - Antes de utilizar el HP 4339A realice las pruebas de funcionamiento de la función "interlock" y del indicador "High Voltage", al menos una vez al día. Puede consultar la sección "Checking Procedure" (Procedimientos de Comprobación) del capítulo 3 del manual *Operation and Service Manual* suministrado con cada uno de los accesorios, para conocer los procedimientos de pruebas operacionales.
 - Advierta a las personas que trabajen alrededor del HP 4339A, sobre las posibles situaciones de peligro que pueden producirse.
-

AVERTISSEMENT

RISQUES D'ELECTROCUTION — HAUTE TENSION (1000 VOLTS)

Le mesureur haute résistance HP 4339A produit des tensions élevées pouvant atteindre 1000 volts (courant continu) entre les bornes UNKNOWN de l'instrument ou les électrodes de l'accessoire support de test raccordé (cellule de résistivité HP 16008B, support de test de composant HP 16339A, cordons de test HP 16117B/C). Lorsque le voyant High Voltage de la face avant est allumé, la tension de sortie est supérieure à 42 volts. Pour éviter tout risque d'électrocution, observez les précautions suivantes :

- N'utilisez le HP 4339A et ses accessoires que de la façon décrite dans leurs manuels respectifs (*Operation Manual* et *Service Manual*), en respectant en particulier les notes d'avertissement.
- Ne touchez JAMAIS aux bornes UNKNOWN de l'instrument ni aux électrodes lorsque le voyant "V Output" de la face avant est allumé, c'est-à-dire quand la sortie du HP 4339A est sous tension.
- Exécutez les tests de fonctionnement de la fonction de sécurité (Interlock) et du voyant "High Voltage" au moins une fois par jour avant de commencer à vous servir du HP 4339A. Reportez-vous à la section "Checking Procedure" du chapitre 3 du *HP 4339A Operation and Service Manual* de chaque accessoire pour connaître les procédures de test.
- Informez les opérateurs travaillant autour du HP 4339A des risques liés à son utilisation.

警告

高压危险(最高电压: 1000Vdc(直流))

在HP4339A高电阻表的UNKNOWN端以及测量固定件或测量导线的电极处(HP16008B阻抗电池、HP16339A测量固定件、HP16117B、C测量导线),会有1000Vdc(直流)的危险电压。而这些端头都是与HP4339A相连接的。(当前面板上的High Voltage指示器处于ON(接通)的位置时,HP4339A有高于42Vdc(直流)的危险电压输出)为了防止触电,请遵守下列安全注意事项。

- 在操作HP4339A及其附件时,请按照操作说明书(或维修说明书)中的指示进行操作,并特别要注意“警告”中的注意事项。
- 当前面板上的V Output指示器处于ON(接通)状态时,请不要触摸UNKNOWN端及电极,因为这时HP4339A有输出电压。
- 在使用HP4339A之前,请参照您在操作测量过程中使用的附件的 Operation and Service Manual的第3章的“Checking Procedure”的内容,每日最少进行一次操作测量的Interlock功能和High Voltage指示器的操作。
- 请警告HP4339A周围的作业人员高压危险的存在,并使他们的知道该做什么和不该做什么!

警告

高壓危險(最高電壓: 1000Vdc(直流))

在HP4339A高電阻錶的UNKNOWN端以及測量固定零件或測量導線的電極處(HP16008B阻抗電池、HP16339A測量固定零件、HP16117B、C測量導線),會有1000Vdc(直流)的危險電壓。而這些端交都是與HP4339A相連接的。(當前面板上的High Voltage指示器處於ON(接通)的位置時,HP4339A有高於42Vdc(直流)的危險電壓輸出。)爲了防止觸電,請遵守下列安全注意事項。

- 在操作HP4339A及其附件時,請按照操作說明書(或維修說明書)中的指示進行操作,並特別要注意“警告”中的注意事項。
- 當前面板上的V Output指示器處於ON(接通)狀態時,請不要觸摸UNKNOWN端及電極,因爲這時HP4339A有輸出電壓。
- 在使用HP4339A之前,請參照您在操作測量過程中使用的附件的 Operation and Service Manual的第3章的“Checking Procedure”的內容,每日最少進行一次操作測量的Interlock功能和High Voltage指示器的操作。
- 請警告HP4339A周圍的作業人員高壓危險的存在,並使他們知道該做什麼和不該做什麼。

경고
고전압 쇼크 위험(최대 1000V 직류)

UNKNOWN 단자, 또는 HP 4339A에 연결되어 있는 테스트 설비의 전극봉 혹은 테스트 리드선(16008 B 저항 셀, HP 16339A 테스트 설비, 또는 HP 16117B, C 테스트 리드선)에는 직류 1000V 정도의 위험한 전압 레벨의 HP 4339A 고저항계 출력(프런트 패널에 High Voltage 지시계가 ON일 때, 직류 42V 이상의 HP 4339A 출력으로 위험한 전압입니다.)으로서, 전기적 쇼크를 방지하기 위하여 다음의 안전 유의사항을 주의깊게 참조해 주십시오.

- HP 4339A 및 부속품의 자동(혹은 서비스) 취급 설명서에 따른 지시대로 작동해 주십시오.
- UNKNOWN 단자 혹은 전극봉은 접촉을 절대로 삼가해야 하며, V Output 지시계의 프런트 패널이 ON일 때, 전압은 HP 4339A의 출력전압입니다.
- HP 4339A는 사용전에, Interlock 기능의 작동시험과 High Voltage 지시계를 적어도 1일에 1회 점검해야 합니다. 작동 테스트 진행순서를 위한 부속품의 Operation and Service Manual의 3장에 있는 "Checking Procedure" 를 참조해 주십시오.
- HP 4339A의 주위는 매우 위험하므로, 작업자는 안전사항을 반드시 준수해야 합니다.

HP 4339A High Resistance Meter
User's Guide





HP Part No. 04339-90001
Printed in JAPAN June 1992

First Edition

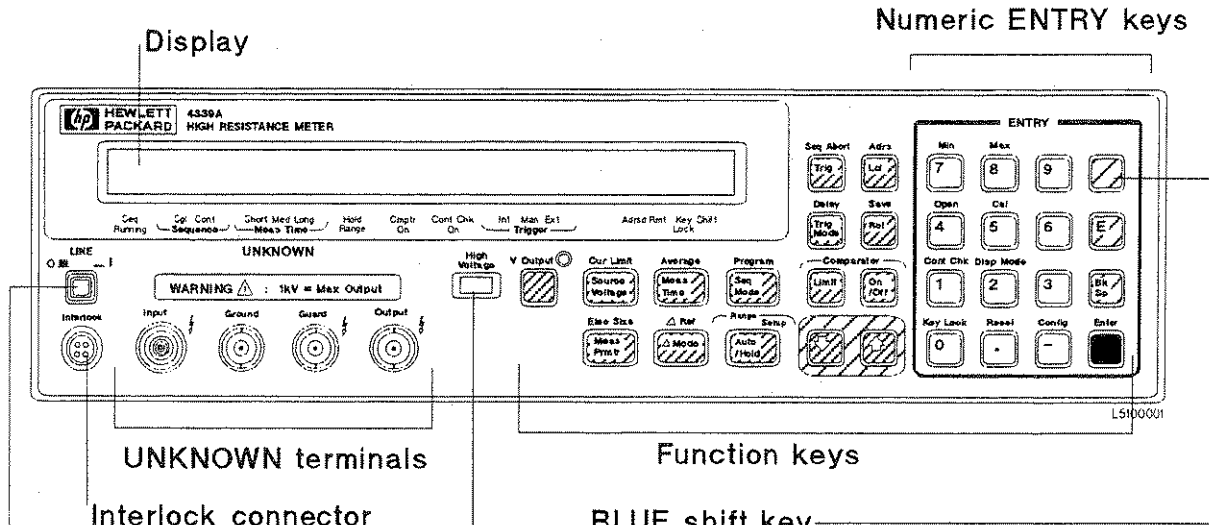
HP 4339A High Resistance Meter at a Glance



UNKNOWN terminals
Interlock connector
LINE switch
High Voltage indicator
 indicates the voltage output exceeds 42 V.

BLUE shift key
 Activates the secondary function printed in blue above the keys. For example,
 Pressing   executes an OPEN correction.
 (In this book, the BLUE shift key is expressed as )

Warning  **Do not touch the UNKNOWN terminals or the electrodes of the accessory, when the High Voltage indicator is ON.**





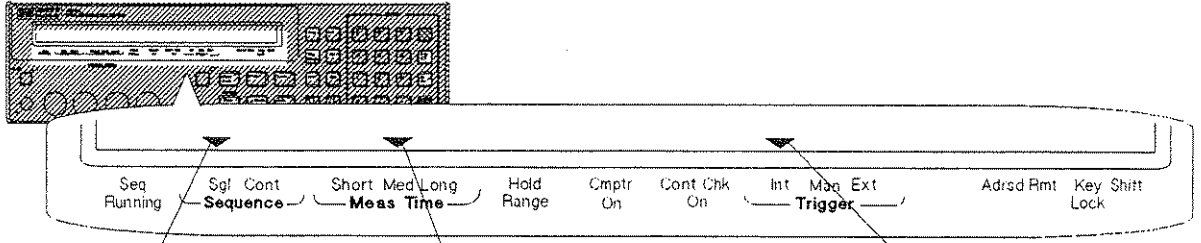













































Annunciator ( symbols, at the bottom of the display)

Shows the instrument's operational state. For example,



Indicates the measurement sequence single mode is selected. Indicates the medium measurement time is selected. Indicates that internal trigger is selected.

Function Keys

<p>V Output indicator</p> <p>V Output </p> <p>Toggles test voltage output between ON and OFF. (page 2-15)</p>	<p> Manual trigger (page 2-15)</p>	<p>  Executes an OPEN correction. (page 2-5)</p>
<p> Sets the test voltage. (page 2-4)</p> <p>  Sets the current limit. (page 2-4)</p>	<p> Selects the type of trigger. (page 2-9)</p> <p>  Sets the trigger delay time. (page 2-9)</p>	<p>  Executes the calibration. (page 2-4)</p>
<p> Selects the measurement parameter. (page 2-6)</p> <p>  Sets the electrode size of a resistivity cell. (page 2-7)</p>	<p> Returns the HP 4339A to the local mode. (See Operation Manual)</p> <p>  Sets the HP-IB address. (page 2-13 or See Operation Manual)</p>	<p>  Toggles the contact check function between ON and OFF. (page 2-10)</p>
<p> Selects the measurement sequence mode. (page 2-14)</p> <p>  Sets the measurement sequence parameters. (page 2-14)</p>	<p> Recalls the instrument settings from internal memory. (See Operation Manual)</p> <p>  Saves the instrument settings to internal memory. (See Operation Manual)</p>	<p>  Selects the display mode. (page 2-12)</p>
<p> Selects the measurement time. (page 2-8)</p> <p>  Sets the averaging rate. (page 2-9)</p>	<p> Sets the comparator limit value. (page 2-11)</p> <p> Toggles the comparator between ON and OFF. (page 2-11)</p>	<p>  Locks out any front panel key except this key. (See Operation Manual)</p>
<p> Selects the deviation measurement mode. (page 2-10)</p> <p>  Sets the reference value for deviation measurement. (page 2-10)</p>	<p> Increases or decreases the setting value. (See Operation Manual)</p>	<p>  Resets the HP 4339A to the default settings. (page 2-2)</p>
<p> Toggles between auto range and hold range. (page 2-8)</p> <p>  Selects the measurement range. (page 2-8)</p>	<p>  Retrieves the minimum value. (See Operation Manual)</p> <p>  Retrieves the maximum value. (See Operation Manual)</p>	<p>  Sets the beeper mode and power LINE frequency, and executes the internal test. (page 1-2, 2-12)</p>

Documentation Map

- *HP 4339A User's Guide* (HP part number 04339-90001)

This guide is a handy reference to help you to get started using your HP 4339A. Basic measurements and commonly used features are explained.

- *HP 4339A Operation Manual* (HP part number 04339-90000, furnished with the HP 4339A)

Provides information on initial inspection, how to operate the HP 4339A, in-depth reference information, general information, specifications, and maintenance information.

- *HP 4339A Service Manual* (HP part number 04339-90031, Option 0B3 only)

Explains how to adjust, troubleshoot, and repair the HP 4339A.

In User's Guide

- Chapter 1, Preparation for Use

For initial turn on of the HP 4339A

- Chapter 2, Operating the HP 4339A

Basic measurement operation

Getting acquainted with the HP 4339A—for beginners

Handy reference for common measurement tasks—for all users

- Chapter 3, Measurement Examples

Measurement Examples for typical HP 4339A applications

Measuring Insulation Resistance of a Capacitor

Measuring Volume Resistivity of a Insulation Material

In the User's Guide, information on the following subjects is not discussed:

- Initial inspection
- HP-IB remote control
- Using with handler
- Maintenance
- Specifications
- Error messages

For detailed information on these subjects, see the *HP 4339A Operation Manual*.

Preparation for Use

In This Chapter

Before turning the HP 4339A ON, you must first set the HP 4339A to match the available power LINE voltage.

If the HP 4339A's power LINE voltage and frequency are properly set and ready to use, you can skip this chapter.

Power Requirements

The HP 4339A's power source requirements are as follows:

LINE Voltage : 100 / 120 / 220 / 240 V ac ($\pm 10\%$)



LINE Frequency : 47 to 66 Hz

Power Consumption : 45 VA maximum

To Set Power LINE Voltage

1. Confirm that the power cable is disconnected.
2. Slide the LINE Voltage selector on the rear panel to match the power LINE voltage which will be used (see Table 1-1).

Table 1-1. Line Voltage Selection

Voltage Selector	Line Voltage	Required Fuse
	100 V / 120 V	T 0.5 A 250 V (HP part number 2110-0202)
	220 V / 240 V	T 0.25 A 250 V (HP part number 2110-0201)

HP 4339A Rear Panel

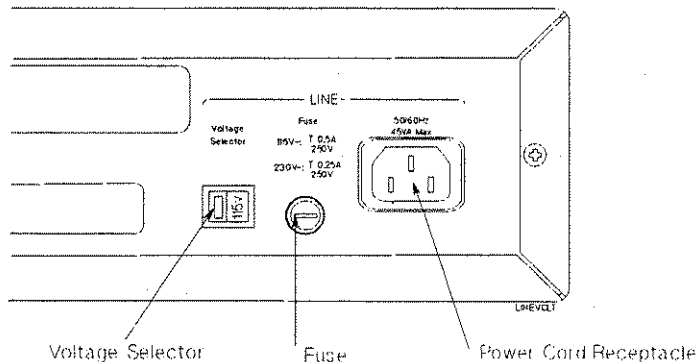



To Set Power LINE Frequency

1. Connect the power cable to the power cord receptacle on the rear panel.
2. Push the LINE switch in and the HP 4339A will emit a beep when it turns ON. All digits are displayed while the self test is in progress. (If any message is displayed, see "Error Messages" back of *HP 4339A Operation Manual*.) The HP 4339A will be ready for operation after a message like the following is displayed.



L5101004

HP 4339A REV 0100

3. Press  . The following message is displayed.

L5101005



OFST BEEP LINE MORE EXIT

4. Press  until "LINE" blinks, then press .

L5101006

LINE FREQ: 50HZ 60HZ

A blinking item means that it is currently selected.

5. If the setting does not match the power LINE frequency, press  to toggle the setting between "50HZ" and "60HZ".
6. Press  twice to exit this menu.

Note



The power line frequency setting is stored and is not changed after reset or power-off. Once you set it, you do not need to set the line frequency again as long as the same power line frequency is being used.

Operating the HP 4339A

In This Chapter

Basic measurement operations of the HP 4339A and references are explained.

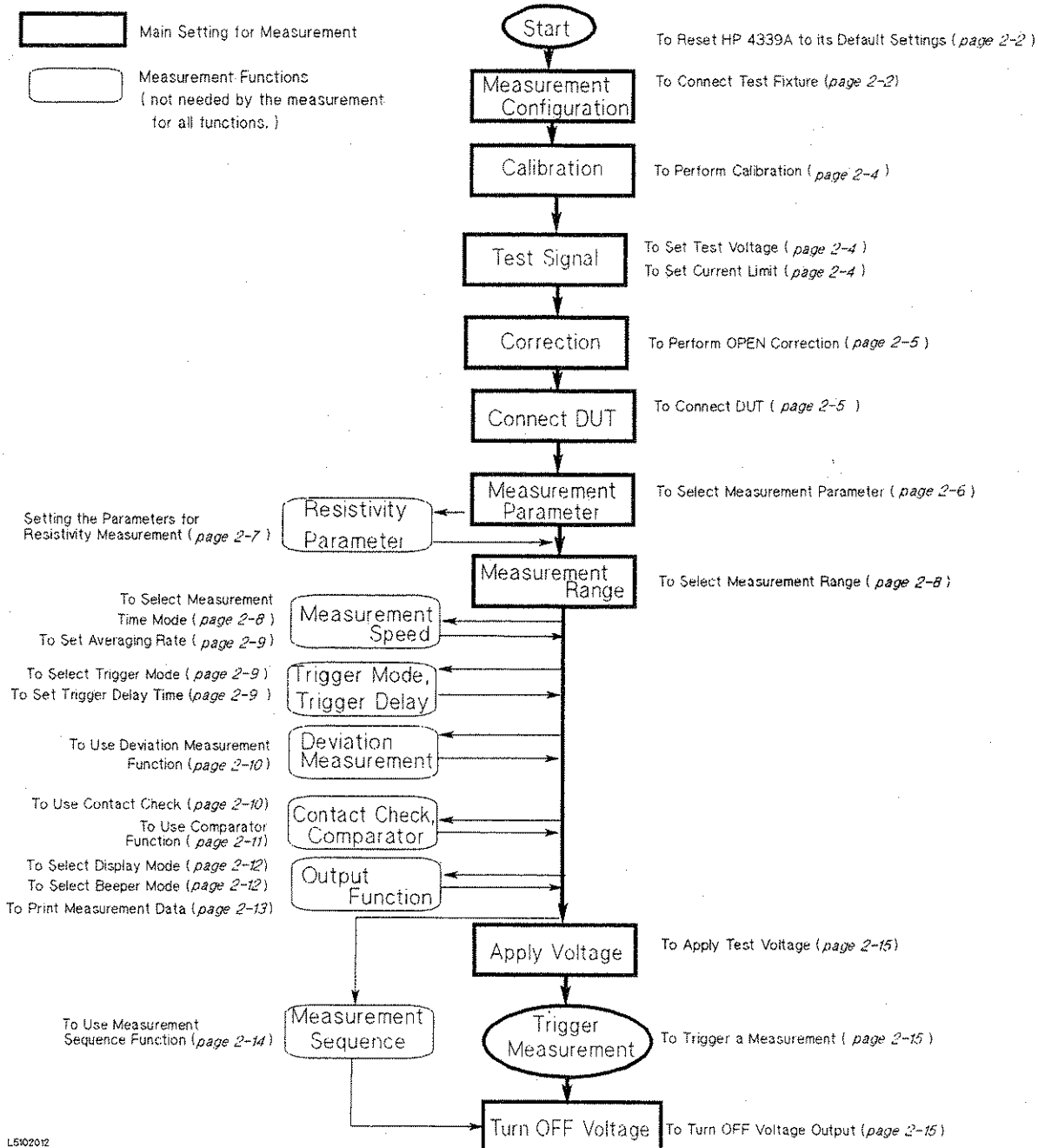

Measurement Procedure





L5102012

Figure 2-1. Measurement Procedure

To Reset HP 4339A to its Default Settings

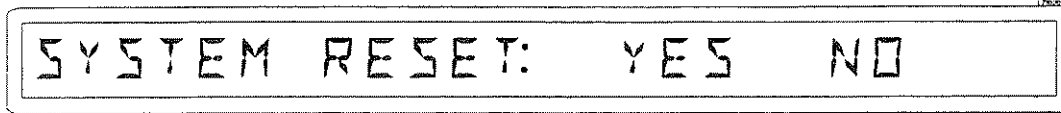
1. Press   to select the reset menu.



2. Press  until YES is blinking, then press .

For more information about the default settings, see "Default Settings" later in this chapter.

To Connect Test Fixture

Connect the test fixture to the UNKNOWN terminals as follows:

Warning



Do *not* touch the UNKNOWN terminals or the electrodes of the accessory, when the High Voltage indicator is ON, the HP 4339A outputs dangerous voltages of up to 1000 Vdc. Before handling the HP 4339A or the accessory, turn OFF the test voltage pressing  and confirm that the High Voltage indicator is OFF.

HP 16008B Resistivity Cell

The HP 16008B is used to measure the volume or surface resistance/resistivity of insulation materials.

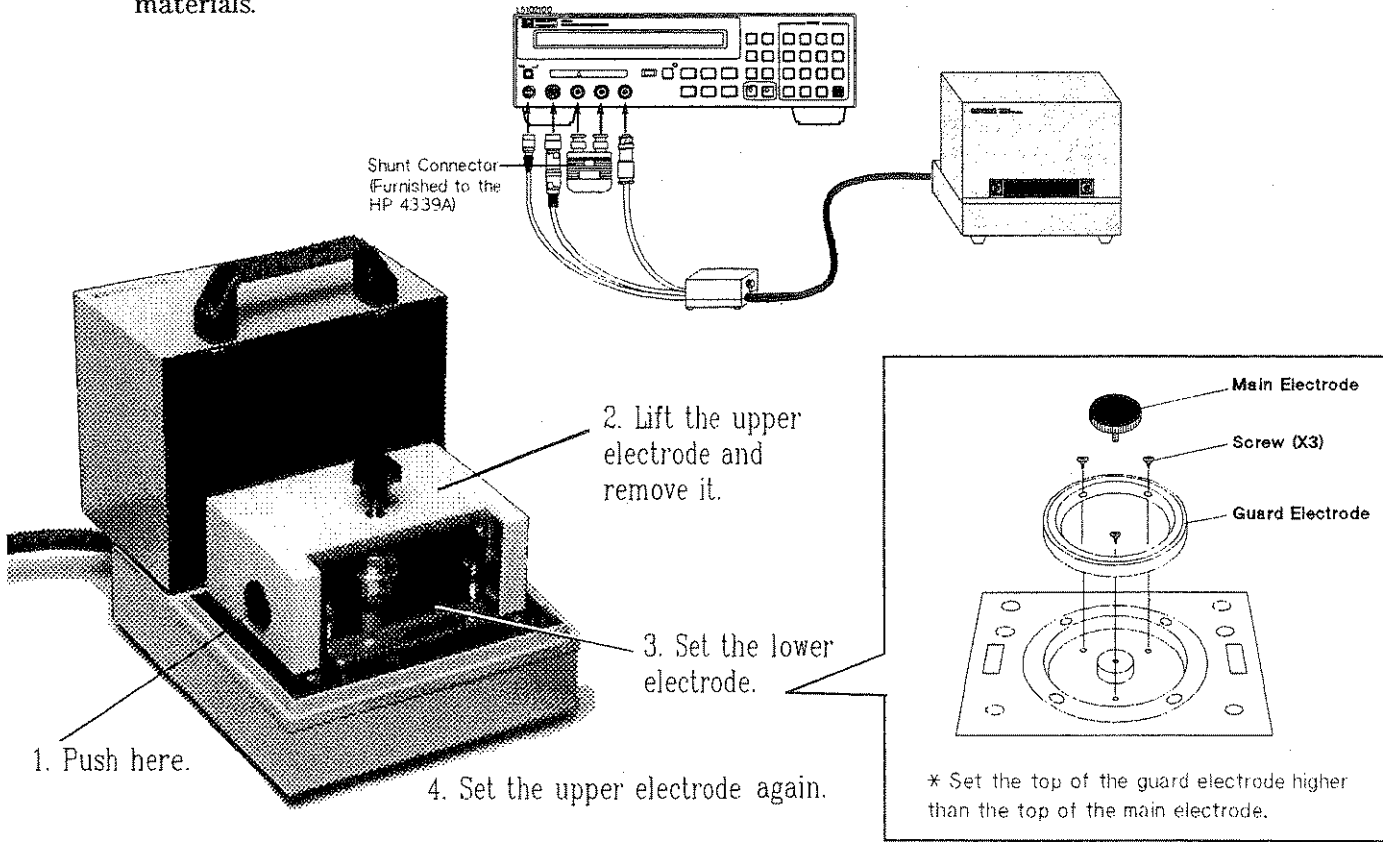

Three size electrodes are available. For detail see "Accessories Available" later in this chapter.

HP 4339A

HP 16117B Low Noise Test Lead

The HP 16117B is used to measure the resistance of insulation materials.

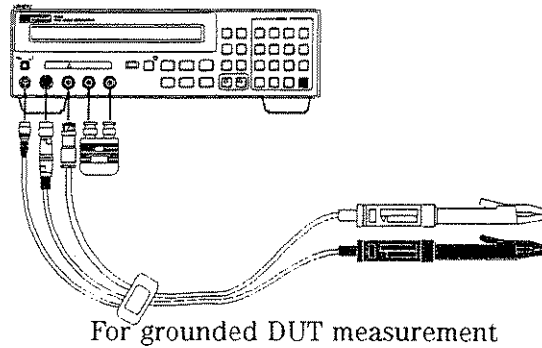
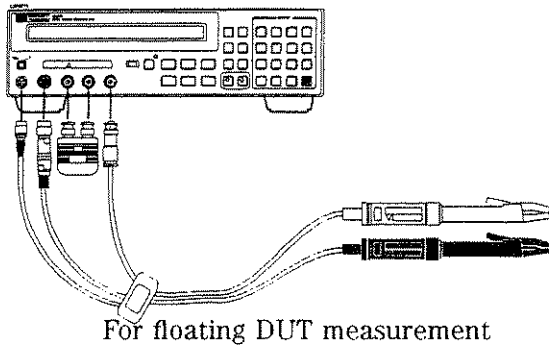

HP 16339A Component Test Fixture

The HP 16339A is used to measure insulation resistance of electronic components.

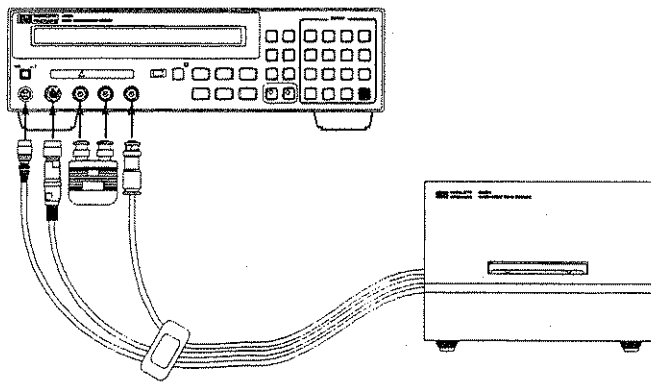

Top view (cover is opened)
of the HP 16339A

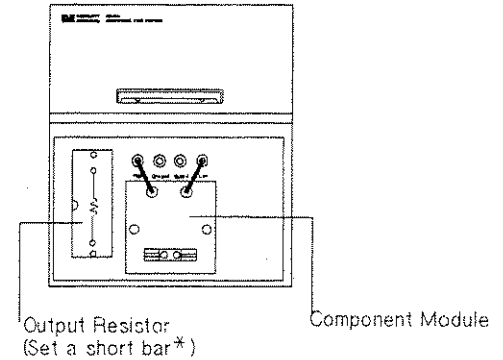

To set the component module :

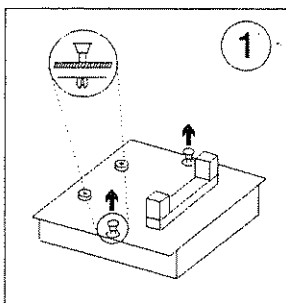

Pull the clamps up.

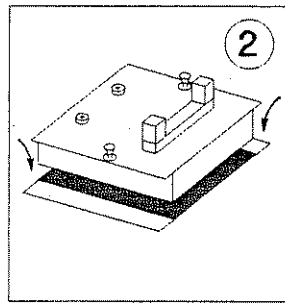

Insert the module.

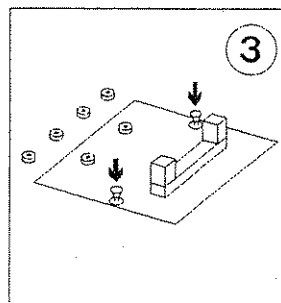

Push the clamps down.

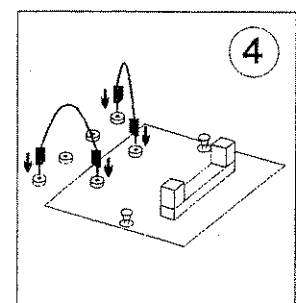



connect the banana cables.

Three type modules are available. For detail see "Accessories Available" later in this chapter.

* Measuring a high capacitance DUT and keeping good S/N ratio, change the short bar to an appropriate resistor. For detail, see page 3-6 of *HP 16339A Component Test Fixture Operation and Service Manual*.

To Perform Calibration—Canceling internal measurement errors

1. Press  . The HP 4339A will display calibration message.

LS102015

CALIBRATION

After displaying this message, the HP 4339A will return to the measurement display with the end message shown below and will be ready to use.

LS102016



CALIBRATION: COMPLETE

To Set Test Voltage

1. Press  and the current voltage setting will be displayed.

LS102010

VOLTAGE: 0.0V

2. Enter the value using the numeric ENTRY keys (for example, to set 10 V, press  ) then press .

LS102114

R: + 0.0000 OHM V: 10.0V

Test voltage is displayed.

To Set Current Limit

To set the current limit or to show the current setting:

1. Press  .

LS102001

CURRENT LIMIT: 0.5mA

2. Enter the value, then press  to enter the value and to exit.

Available current limits are:



0.5 mA (default)	5.0 mA (at test voltage 0 to 250 V only)
1.0 mA	10 mA (at test voltage 0 to 100 V only)
2.0 mA (at test voltage 0 to 500 V only)	

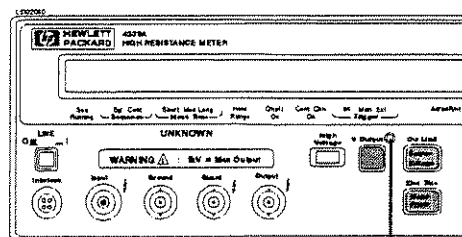

To Perform OPEN Correction —Canceling the stray admittance in parallel with the DUT

1. Separate each electrode of the test fixture. For details about fixture operation, refer to “Test Fixtures and Test Leads” later in this chapter.
2. Press . A source voltage is applied to the test fixture, and the **V Output** indicator will turn ON.



V Output indicator

Warning  Pressing  may cause the HP 4339A to output dangerous voltage, up to 1000 Vdc. Do *not* touch the UNKNOWN terminals or the electrodes of the accessory when the V Output indicator is ON.

3. Press  . The correction message will be displayed.



After a while, the HP 4339A will display the OPEN correction finished message,



and return to the measurement mode.

4. Press . The **V Output** indicator will turn OFF.

If “OUT OF LIMIT” is displayed



The OPEN admittance is so high that it would be unsuitable for OPEN correction data.

- Check that the test electrodes are properly opened.

Perform the OPEN correction again.

To Connect DUT

Set the DUT to the test fixture. For details, see “Test Fixtures and Test Leads”.

Warning  Do *not* touch the UNKNOWN terminals or the electrodes of the accessory, when the High Voltage indicator is ON, the HP 4339A outputs dangerous voltage of up to 1000 Vdc. Before handling the HP 4339A or the accessory, turn OFF the test voltage pressing  and confirm that the High Voltage indicator is OFF.

To Select Measurement Parameter

Press  until the desired measurement parameter is displayed.

- Resistance : R

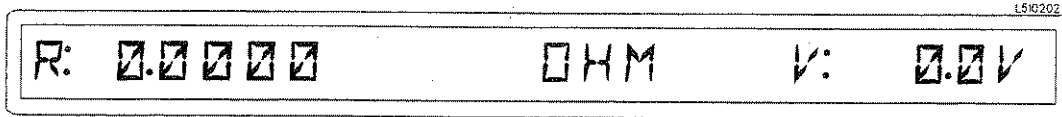

- Current : I

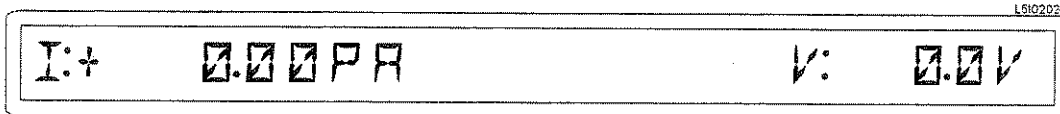

- Resistivity : ρ_V or ρ_S

Note



If the HP 16008B resistivity cell is connected to the HP 4339A, to change volume and surface resistivity, switch the volume/surface selector switch on the resistivity cell.

Volume Resistivity (ρ_V) : RV

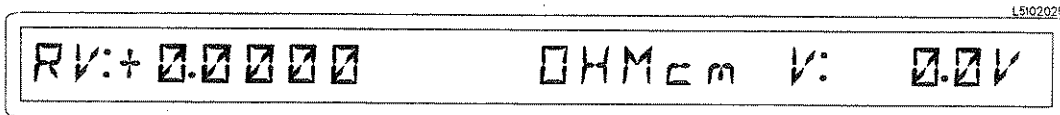

Surface Resistivity (ρ_S) : RS

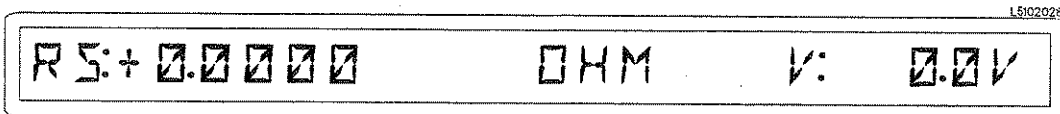

Setting the Parameters for Resistivity Measurement

Press   .

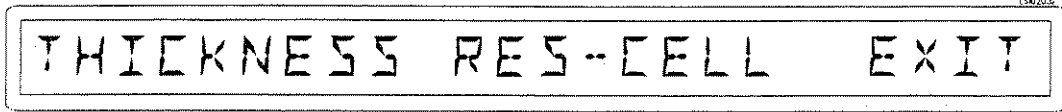

Setting Thickness of the DUT

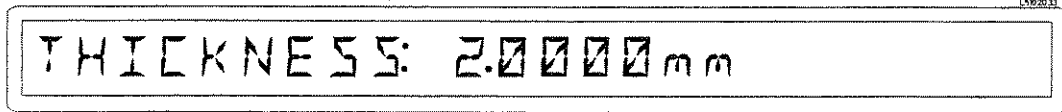

1. Select THICKNESS using  or  , and press  .



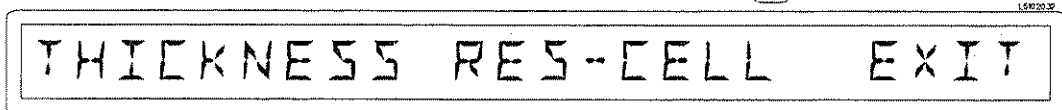



2. Enter the thickness using the numeric ENTRY keys, and press  .



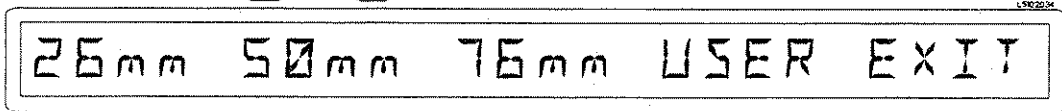

Setting the Electrode Size

1. Select RES-CELL using  or  .

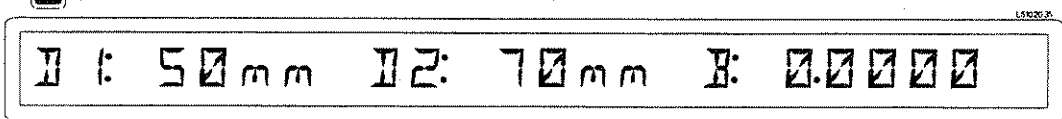

2. Select the electrode size that you want to use (26mm, 50mm, or 76mm) using  or  , and press  .



3. Press  .

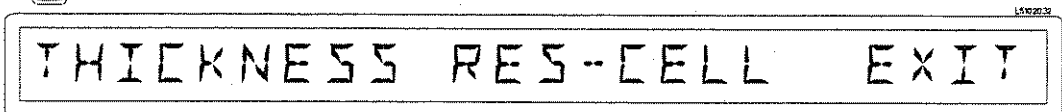

4. Press  to EXIT.

To Select Measurement Range

Auto Range mode

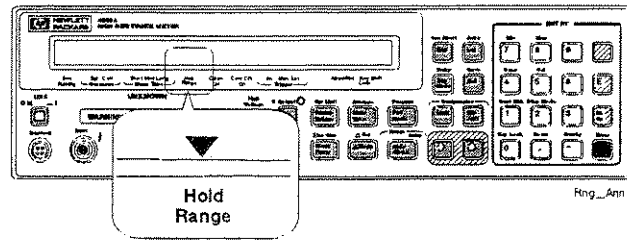

—Automatically selecting the optimum measurement range

Press . The **Hold Range** annunciator turns OFF.





Hold Range mode—Holding the measurement range of your choice

To select the measurement range,

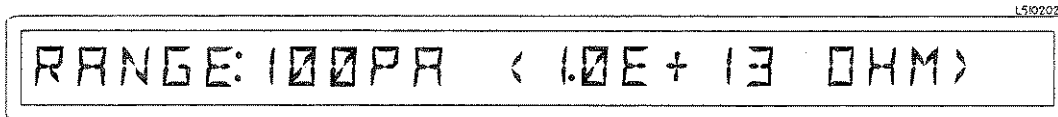
1. Press  or . The measurement range setup menu is displayed.



2. Press  or  until the desired range is displayed. Or, input the current value to be measured using the numeric ENTRY keys, and the HP 4339A will select the optimum measurement range setting.
3. Press . The **Hold Range** annunciator turns ON.

Available measurement ranges:

- 100 pA (Not available at Short measurement time)
- 1 nA
- 10 nA
- 100 nA
- 1 μ A
- 10 μ A
- 100 μ A (Available at Short measurement time only)

To Select Measurement Time Mode



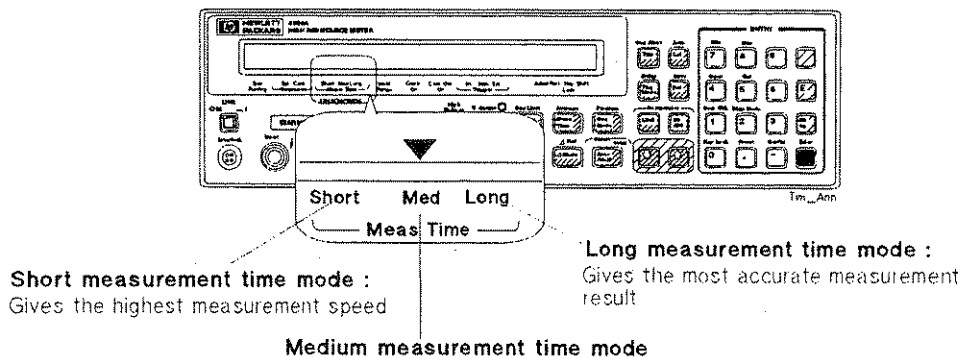

Press  until the **Meas Time** annunciator points to the desired measurement time mode.

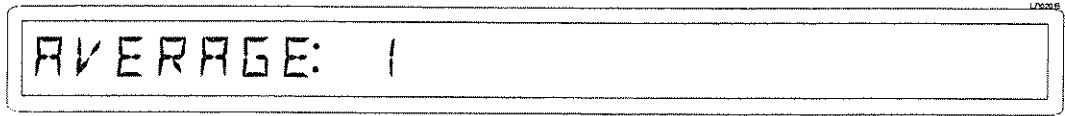

To Set Averaging Rate—Stabilizing the measurement result

1. Press  .



2. Enter the averaging rate using the numeric ENTRY keys. (For example, to enter 4, press ) You can enter integer values from 1 to 256. Also, you can increase or decrease the value using  or .
3. Press  to set the value and to exit.

To Select Trigger Mode

Press  until the **Trigger** annunciator points to the desired trigger mode.

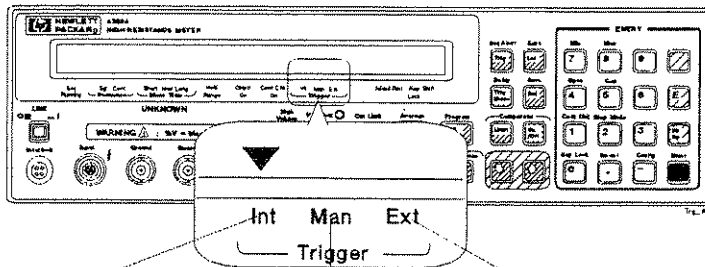

Internal trigger :
Free running measurement

Manual Trigger :
Trigger a measurement when pressing 





External trigger :
Trigger a measurement by external signal input (from an external trigger source, a handler interface, or the HP 16064B).

To trigger a measurement in each mode, see “To Trigger a Measurement” later in this chapter.

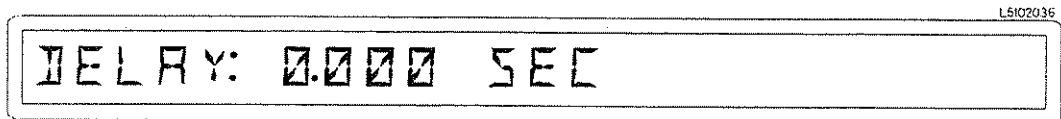
To Set Trigger Delay Time

1. Press  .





2. Enter the desired trigger delay time using the numeric ENTRY keys. (For example, to set 0.5 s, press   ) You can set the trigger delay time from 0 s to 9.999 s.
3. Press  to set the value and to exit.

To Use Deviation Measurement Function

Setting the Deviation Reference Values

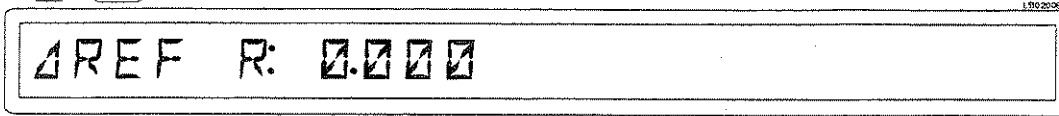
1. Press  .



2. Enter the numeric value using the numeric ENTRY keys.
 3. Press  to enter the value and to exit.

Selecting the Deviation Mode

Press  until the desired deviation mode is selected.

Deviation Measurement OFF

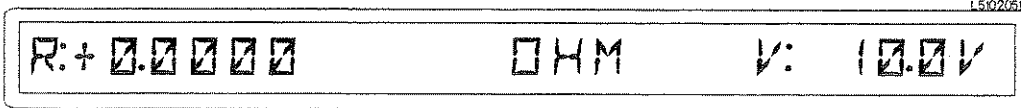

Δ (Delta) Mode : (MEAS)-(REF)



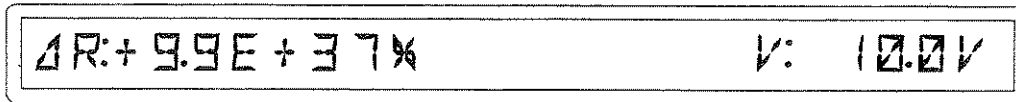

Δ % Mode : $\frac{(MEAS)-(REF)}{(REF)} \times 100(\%)$





(MEAS) : measurement result
 (REF) : reference value

To Use Contact Check Function —Monitoring the connection of test electrodes and DUT

To enable the contact check function,

Press  , and the Cont Chk On annunciator turns ON.

To turn the contact check function off,

Press  , and the Cont Chk On annunciator turns OFF.

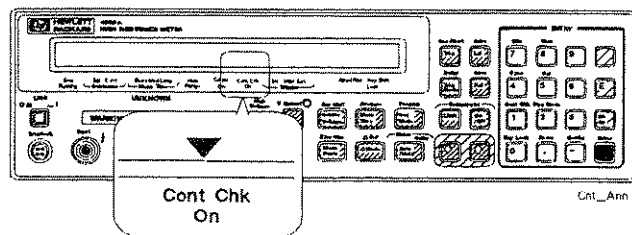

When contact check failed, the HP 4339A displays N.C.(No-Contact).



The OPEN correction function must be performed correctly for a valid contact check.

To Use Comparator Function

Setting the Limit Values

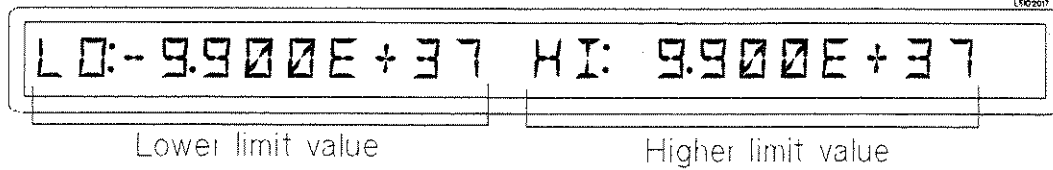
1. Press  .



2. A blinking LO: shows that you can enter the lower limit value. Enter the value using the numeric ENTRY keys, then press  to enter the value. You can set the value from -9.900×10^{37} to 9.900×10^{37} .
3. A blinking HI: shows that you can enter the higher limit value. Enter the value using the numeric ENTRY keys, then press  to enter the value and to exit. You can set the value from -9.900×10^{37} to 9.900×10^{37} .

Sorting

To start sorting,

Press  . The **Comptr On** annunciator turns ON.

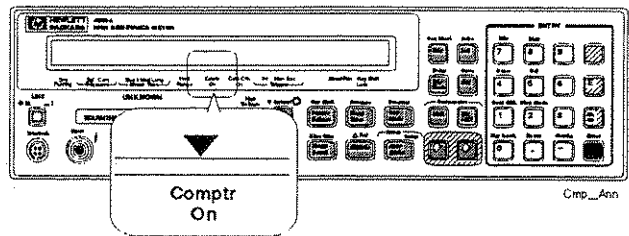

To turn sorting off,

Press  . The **Comptr On** annunciator turns OFF.

The sorting results are HIGH, IN, and LOW.



Where,

HIGH	greater than higher limit
IN	between higher limit and lower limit
LOW	less than lower limit

The HP 4339A shows the comparison results using the display, beeper, printer, and HP 16064B LED Display/Trigger Box. (To use the HP 16064B, see "Accessories Available" later in this chapter.)

- For result output to the display, see "To Select Display Mode" in the next page.
- For result output to the beeper, see "To Select Beeper Mode" in the next page.
- For result output to the printer, see "To Print Measurement Data" later in this chapter.

To Select Display Mode

Press   until the desired mode is displayed. The following modes are available.

- The Measurement Display mode shows the measurement data:

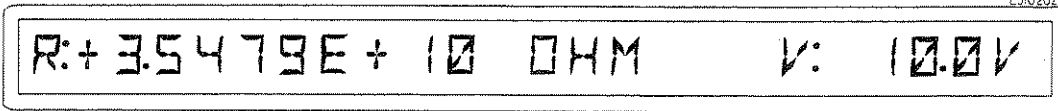

- The Comparison Display mode shows the comparison results:

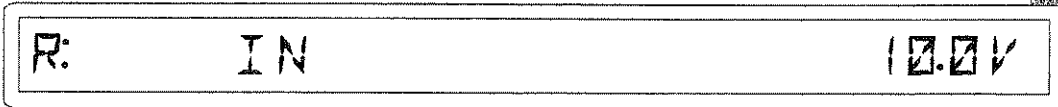

OFF : Comparator is OFF. IN : Between higher limit and lower limit.
 HIGH : Greater than higher limit. LOW : Less than lower limit.

- The Limit Table mode shows the comparator limits:

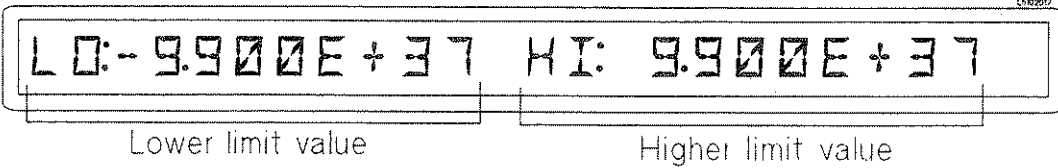





- The Display OFF mode shows the annunciators only.

To Select Beeper Mode

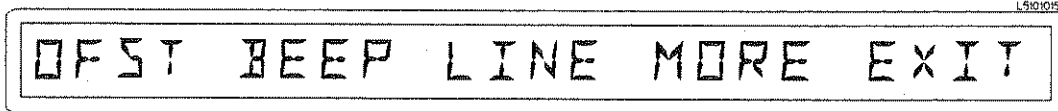



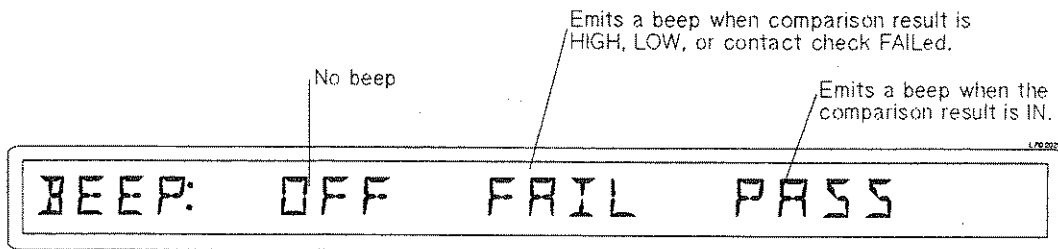

To change the beeper mode for the comparator result reporting:

1. Press  .



2. Select BEEP using  or  and press  to select.



3. Select the beep mode using  or , and press  to exit to the previous display.
4. Select EXIT using  or , and press  to exit.



To Print Measurement Data

Setting the Printer

1. Use an HP-IB compatible printer, set the printer to the listen-always mode.
2. Connect the printer to the HP 4339A's HP-IB port on the rear panel.
3. Turn the printer ON.

Printing

Set the HP 4339A to talk only mode (Set the HP 4339A's HP-IB address to 31).

1. Press   **3**  **1**.

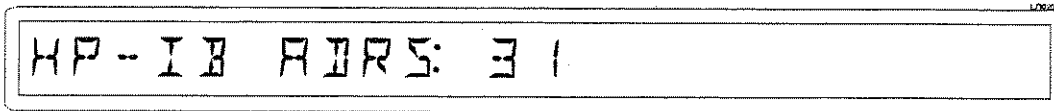

2. Press . The Adrsd annunciator turns ON and the printer begins printing the measurement data.

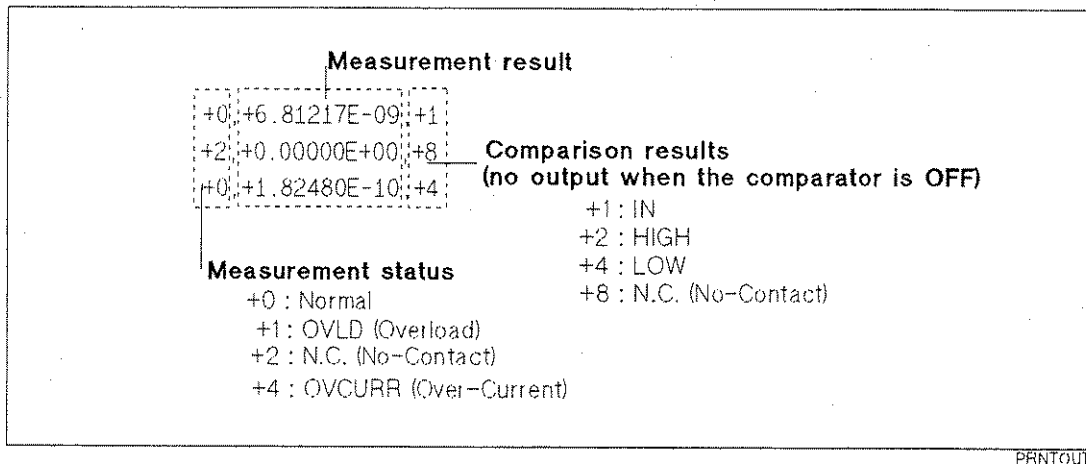







Figure 2-2. Printer Output

Disabling Printing

Change the HP-IB address to an address other than 31 (for example, 17, which is the default setting).

- Press    **1**  **7** .



To Use Measurement Sequence Function —Controlling charge-measurement in a sequence

Selecting the Measurement Sequence Mode

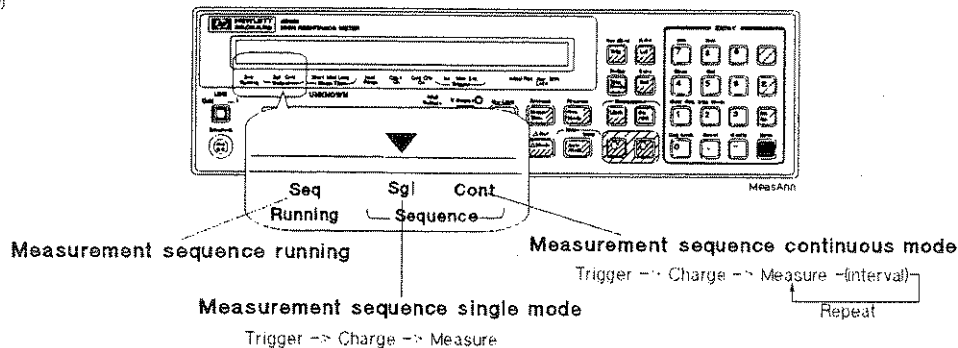
Press  until the desired mode is selected.



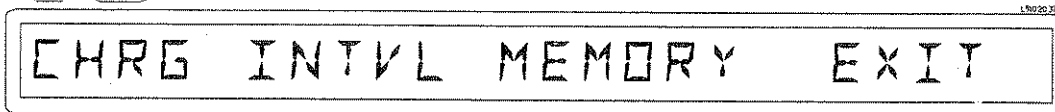

Setting the Measurement Sequence

1. Press  . The sequence mode menu will be displayed.



2. Set charge time.

a. Select CHRG using  or , then press .

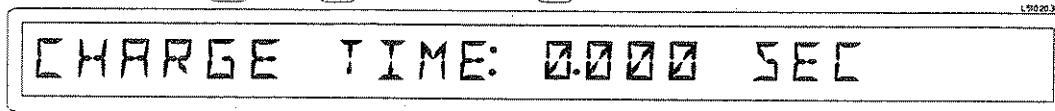

b. Enter the charge time, then press .

3. Set interval time (Cont mode only).

a. Select INTVL using  or , then press .

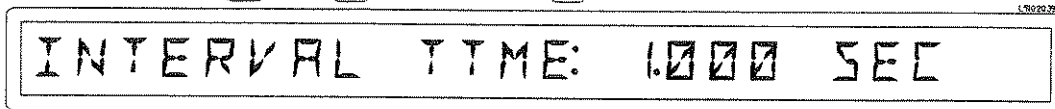

b. Enter the interval time, then press .

4. Set number of repetitions (Cont mode only).

a. Select MEMORY using  or , then press .

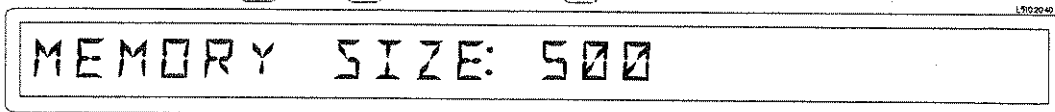

b. Enter the number of measurement points, then press .

5. Press  to EXIT.

Starting Measurement Sequence

Press . The Seq Running annunciator is set to ON.

Warning Pressing  may cause the HP 4339A to output dangerous voltage, up to 1000 Vdc. Do *not* touch the UNKNOWN terminals or the electrodes of the accessory, when the V output indicator is ON.





Aborting Measurement Sequence

Press  . The Seq Running annunciator is set to OFF.

To Apply Test Voltage

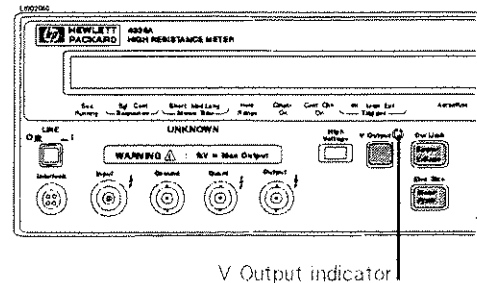
Press . The V Output indicator turns ON.



Warning Pressing  may output dangerous voltage, up to 1000 Vdc. Do *not* touch the UNKNOWN terminals or the electrodes of the accessory when the V Output indicator is ON.



To Trigger a Measurement

- In internal trigger mode—The HP 4339A makes continuous free-running measurements.
- In manual trigger mode—Press  when you want to manually trigger a measurement.
- In external trigger mode— Connect the external trigger source to the EXT TRIGGER terminal on the HP 4339A's rear panel, and apply a TTL level trigger signal to trigger a measurement. (For details, see the *HP 4339A Operation Manual*.)
Note that the HP 4339A must be set to the external trigger mode to be triggered from an external handler or from the HP 16064B LED Display/Trigger Box.

To Turn OFF Voltage Output

Press  and confirm the V Output indicator and the High Voltage indicator is turn OFF.

Warning If the High Voltage Indicator turns ON after turning OFF the test voltage, the DUT is still charged. This happens especially for capacitive DUTs. Do *NOT* handle the DUT while the High Voltage Indicator is turned ON. When the charge on the DUT discharges to a safe level (less than 42 V) the High Voltage indicator will turn OFF.



Reference

Default Settings

- Test voltage output : OFF
- Test voltage : 0 V
- Current limit : 0.5 mA
- Measurement parameter : R
- Resistivity cell
 - D1 : 50 mm
 - D2 : 70 mm
 - t : 2 mm
 - B : 0
- Deviation measurement : OFF
- Measurement range : Auto
- Measurement time : MEdium
- Averaging rate : 1
- Trigger mode : Internal
- Trigger delay time : 0 ms
- Comparator : OFF
- Contact check : OFF
- Display mode : Measurement mode
- Beep mode : FAIL mode
- Offset-error canceling : OFF
- OPEN correction data is cleared

Accessories Available

HP 16064B LED Display/Trigger Box

The HP 16064B LED Display/Trigger Box triggers a measurement when its trigger key is pressed, and displays the comparison results using LEDs. It allows you to manually operate the comparator function of the HP 4339A.

HP 4339A
High Resistance Meter

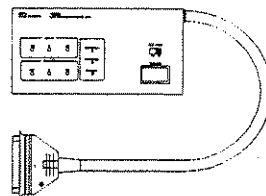
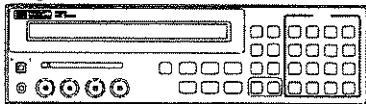

HP 16064B
LED Display/Trigger Box

Connect to the Handler Interface connector on the rear panel.

Test Fixtures and Test Leads

Following test fixtures and test leads are available for the HP 4339A for various forms of DUTs.

HP 16008B Resistivity Cell

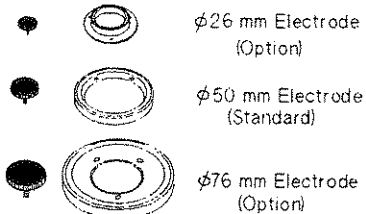
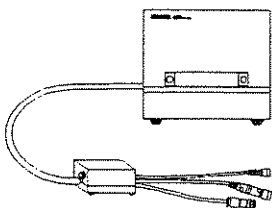

Option 001: Add both 26 mm and 76mm electrodes

Option 002: Add 26 mm electrode

Option 003: Add 76 mm electrode

HP 16117B Low Noise Test Leads



HP 16117C Low Noise Test Leads



For custom terminations

HP 16339A Component Test Fixture

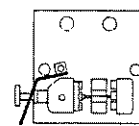
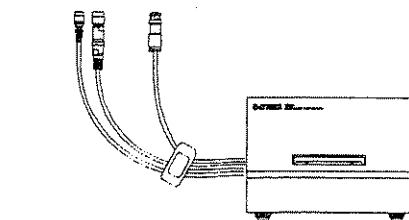

SMD Module

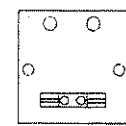

Axial Lead Module

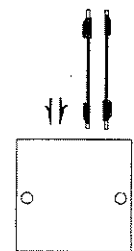

Alligator Clip and Flat Table

HP 4339A

HP 16008B

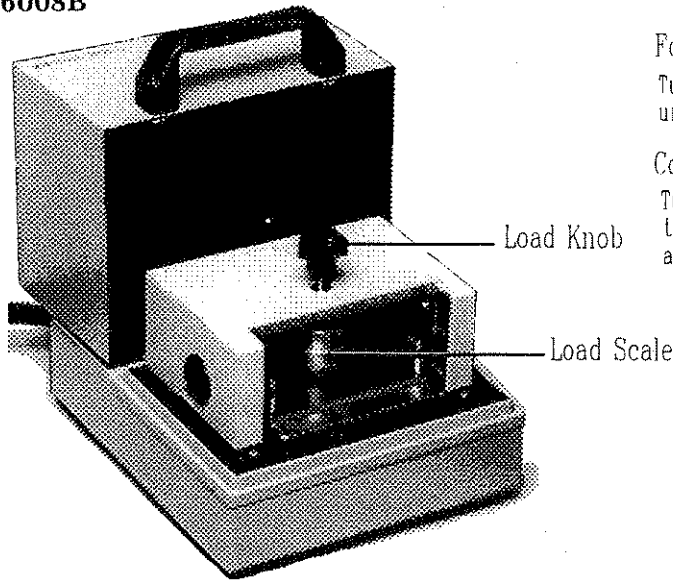

For an OPEN correction
Turn the load knob counterclockwise until the upper electrode does not move.

Connecting the DUT
Turn the load knob clockwise until the load scale indicates between 0 kg and 10 kg.

HP 16339A

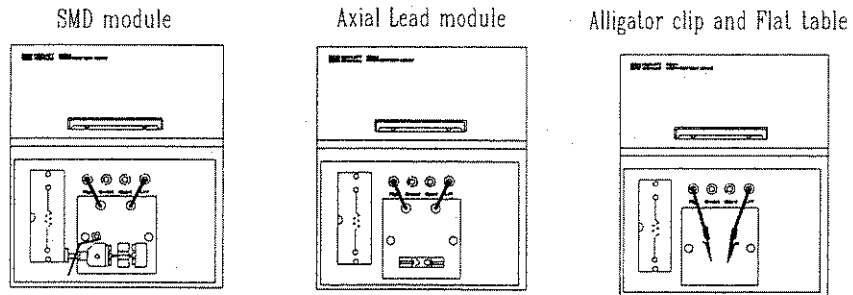

For an OPEN correction
same as the DUT's width

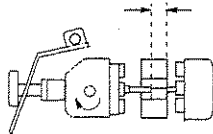

Tighten the screw to hold the electrode.

Nothing must be connected to electrode.

Remove the alligator clips.

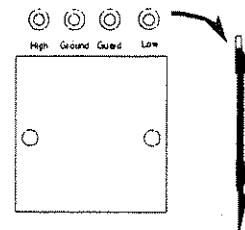

HP 16117B

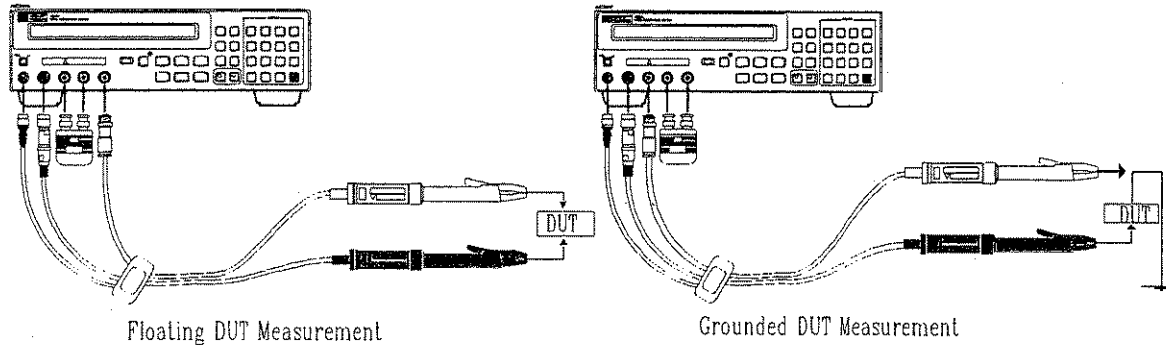

Other Topics

For details on these functions, see the *HP 4339A Operation Manual*.

- Initial Inspection — Chapter 1 of the *Operation Manual*
- Auto-Offset Canceling — Chapter 2 and Chapter 3 of the *Operation Manual*
- Key Lock Function — Chapter 2 and Chapter 3 of the *Operation Manual*
- HP-IB — Chapter 4 and Chapter 5 of the *Operation Manual*
- Handler Interface — Chapter 3 and Appendix B of the *Operation Manual*
- Save / Recall — Chapter 2 and Chapter 3 of the *Operation Manual*
- Backup Function — Chapter 3 of the *Operation Manual*
- Specification — Chapter 8 of the *Operation Manual*
- Maintenance — Chapter 9 of the *Operation Manual*
- Error Messages — “Error Messages” in back of the *Operation Manual*



If You Have a Problem

If any of the problems listed below occur, follow the instructions given for the problem.

- If you find yourself lost when operating the HP 4339A



You can get back on track by:

To return to the measurement mode Press  several times.

To return to the default settings Press  . (If the reset is not accepted, confirm that the **key Lock** annunciator is turned ON. See next.)

- If the HP 4339A does not accept key input:

□ Check whether or not the **Key Lock** annunciator is ON. If so:

□ Press  . The **Key Lock** annunciator turns OFF and the front-panel keys are unlocked.

□ Check that the HP 16064B LED display/trigger box is connected to the HP 4339A and it is set to lock out the keys. If so, unlock the keys from the HP 16064B.

- If  is not accepted:

□ Check whether the interlock connector is firmly connected.



□ If you are using the HP 16008B or the HP 16339A,

□ Check whether the top cover of the test fixture is closed.

- If the HP 4339A displays annunciators only:

The display mode is set to the Display OFF mode.

1. If the HP 4339A is in the key lockout mode, cancel the key lockout mode. (See previous description.)

2. Press   to change the display mode to a mode other than Display OFF.

- If ----- or “OVL” is displayed:

The measurement result is out of the measurable range. Check the DUT and make sure the measurement range is properly set.

Measurement Examples

In This Chapter

The HP 4339A's features are discussed, which you can investigate by trying the typical measurement examples described in this chapter.

HP 4339A Features

For precision bench-top applications HP 4339A High Resistance Meter is the right tool for accurate high resistance and low current tests.

High quality testing

- Remove parasitics with error correction
- High confidence testing with contact check function
- Consistent results with 0.6 % basic accuracy

Versatile measurement

- Four measurement parameters :
R, I, ρV , ρS
- Variety of test fixtures and accessories

No resistivity calculation required : The HP 4339A automatically calculates the surface and volume resistivity.

Measurement sequence function allows you to control a resistance measurement in a sequence(charge-measure-discharge).

Test System Configuration for a Production Line

The HP 4339A's handler interface outputs signals to indicate measurement completed, contact check judgment, and PASS/FAIL judgments of the comparator function. The handler interface has an input for an external trigger signal and a keylock signal. Using these signals, the HP 4339A can easily be combined with a component handler and a system controller to fully automate component testing, sorting, and quality control data processing to increase production efficiency.

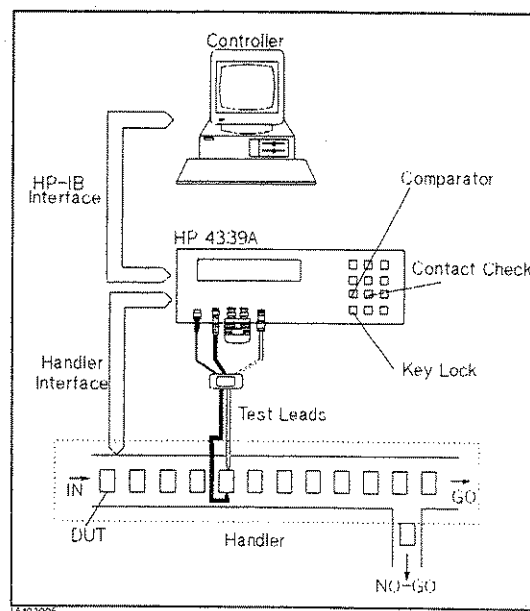

Measuring Insulation Resistance of Capacitor

This example shows the procedure to measure insulation resistance of capacitor after charged 1 minute. Using the test sequence measurement function reduces the measurement complexity.

Warning



Do not touch the UNKNOWN terminals or the electrodes of the accessory, when the High Voltage indicator is ON, the HP 4339A outputs dangerous voltage of up to 1000 Vdc. Before handling the HP 4339A or the accessory, turn OFF the test voltage pressing  and confirm that the High Voltage indicator is OFF.

DUT

Chip ceramic capacitor

Requirements

Test Fixture : HP 16339A, SMD module

Measurement Setup

Measurement Parameter : R

Measurement Range : Auto range mode

Test Voltage : 10 V



Use the measurement sequence single mode (measure after charged for 1 minute.)

Measurement Procedure

1. Reset the HP 4339A.

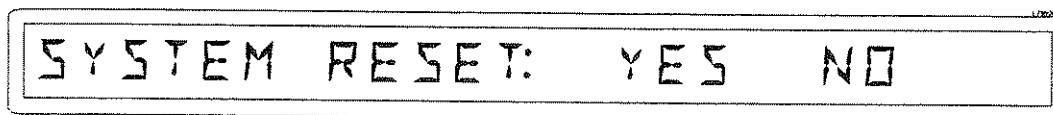
a. Press  .



b. Press  until YES blinks, and press .

2. Connect the test fixture to the UNKNOWN terminals as follows:

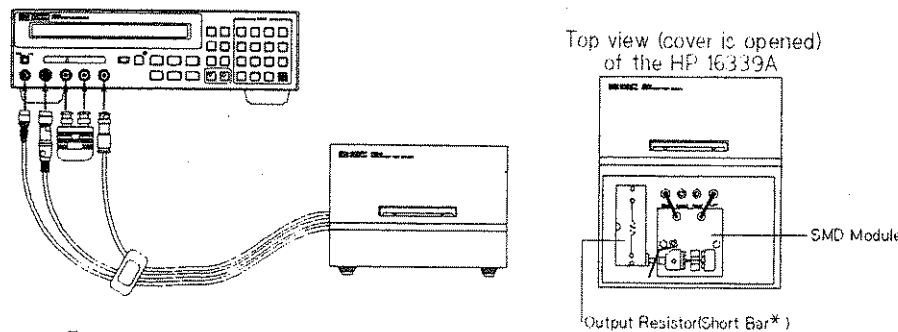

To set the SMD module :

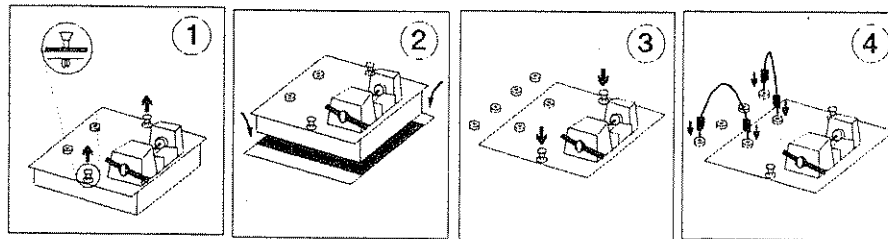

Pull the clamps up.

Insert the SMD module.

Push the clamps down.

Connect the banana cables.

* For detail, see "HP 16339A Component Test Fixture" in Chapter 2.

HP 4339A

3. Perform calibration.

Press   .





After a while, "CALIBRATION: COMPLETE" will be displayed, then the calibration is completed.

4. Set the test voltage.

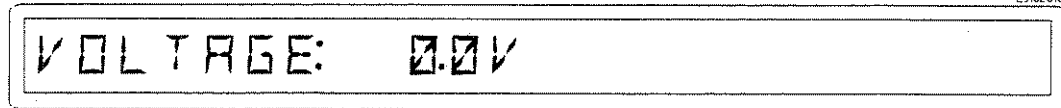
a. Press  .



b. Press    . The HP 4339A displays 10 V.

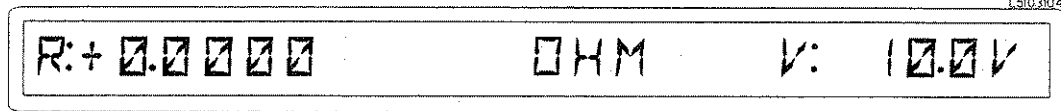

5. Perform an OPEN correction.

a. Separate and set the test electrodes (nothing must be connected to the electrodes).

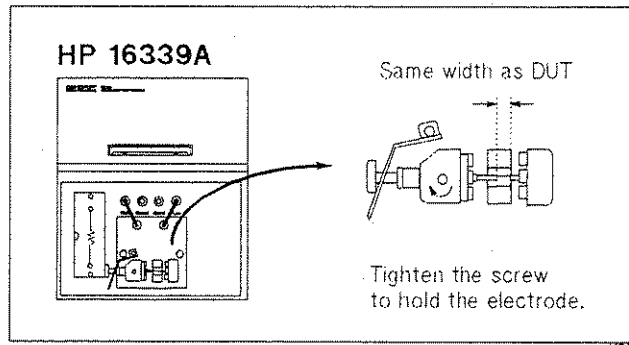

b. Close the cover.

c. Press  . The measurement parameter I:(current) will be displayed.

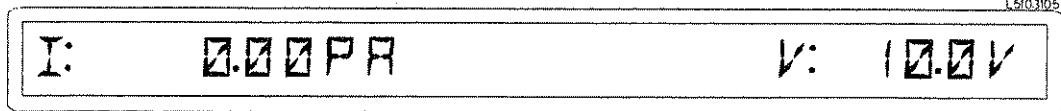

d. Press  . The Meas Time annunciator will indicate **Long**.

e. Press  . The V Output indicator will turn ON.

f. Wait until the I value has stabilized within 0.5 pA.

g. Press   .

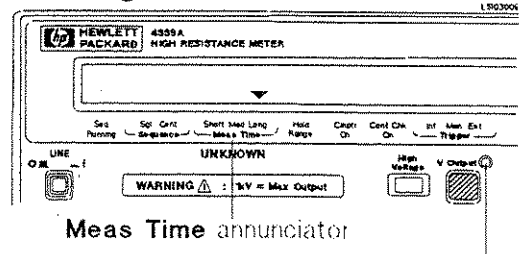

L5M02608

OPEN CORRECTION

After a while, CORR: COMPLETE will be displayed, then the OPEN correction is completed. (If OUT OF LIMIT is displayed, see "To Perform OPEN Correction -Canceling the stray admittance in parallel with the DUT" in Chapter 2.)

h. Press . The V Output indicator will turn OFF.

6. Connect the DUT and close the cover.

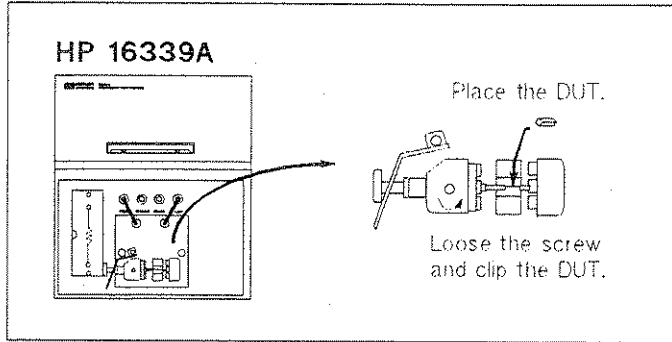

7. Set measurement parameter to R(resistance); press  until the measurement parameter R: is displayed.

L5103106

R: + 0.0000 OHM V: 10.0V

8. Set the measurement sequence function to the charging time of 1 minute.

a. Press  .

L502037

CHR G INTVL MEMORY EXIT

CHR G is blinking.

b. Press .

L502038

CHARGE TIME: 0.000 SEC

c. Press   .

d. Press  to EXIT.

e. Press . The Sequence annunciator points to Sgl.

9. Press . After charging 1 minute, the measurement result will be displayed. The following figure shows the typical measurement result display.

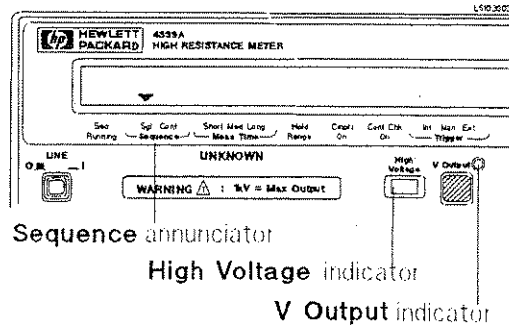

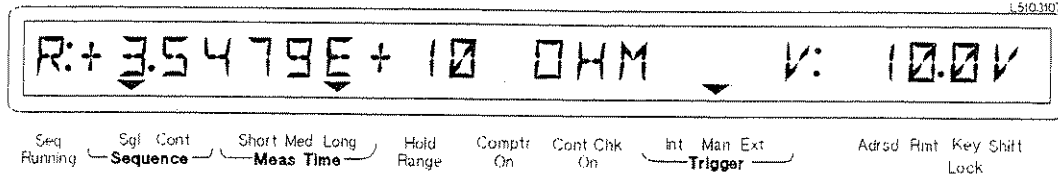

For More Information

- To print out the measurement result — See “To Print Measurement Data” in Chapter 2
- To select measurement level — See “To Set Test Voltage” in Chapter 2

Measuring Resistivity of Insulation Material

This example shows the procedure to measure resistivity of an insulation material after charged 1 minute. The HP 16008B Resistivity Cell is a right tool to measure resistivity of solid insulation materials.

DUT

Insulation Material
(5 mm × 120 mm × 120 mm)

Requirements

Test Fixture : HP 16008B, ϕ 50 mm electrode

Measurement Setup

Measurement parameter : RV(ρ V)

Measurement Range : Auto range mode

Test Voltage : 500 V



Use the measurement sequence single mode (measure after charged for 1 minute.)

Measurement Procedure

1. Reset the HP 4339A.

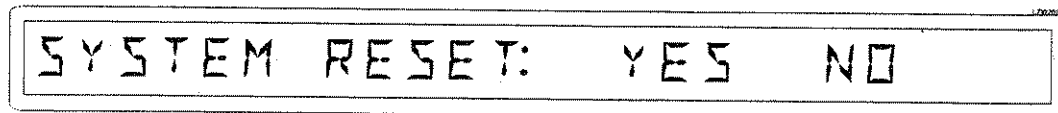
a. Press  .



b. Press  until YES blinks, and press .

2. Connect test fixture to the UNKNOWN terminals as follows:

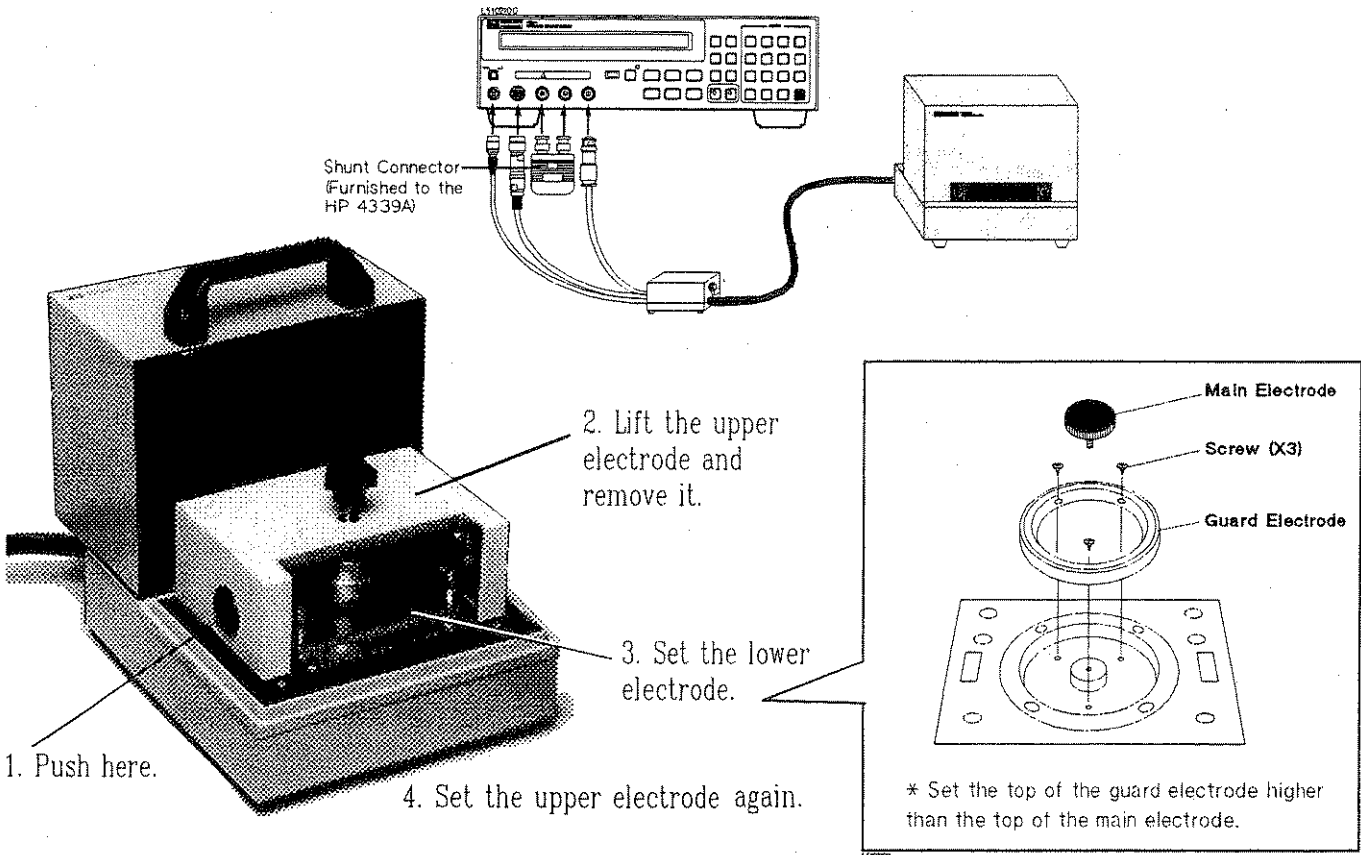

3. Perform calibration.

Press .



After a while, "CALIBRATION: COMPLETE" will be displayed, then the calibration is completed.

4. Set the test voltage.

a. Press .

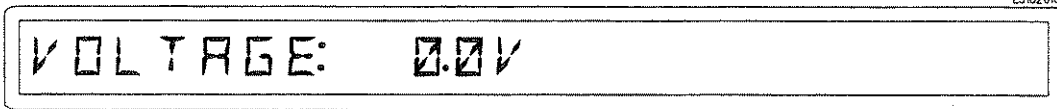

b. Press . The HP 4339A displays 500 V.

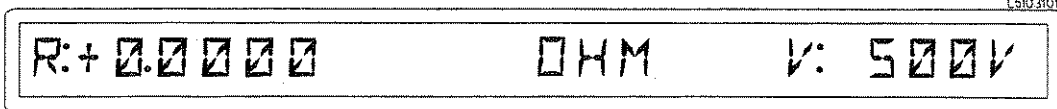



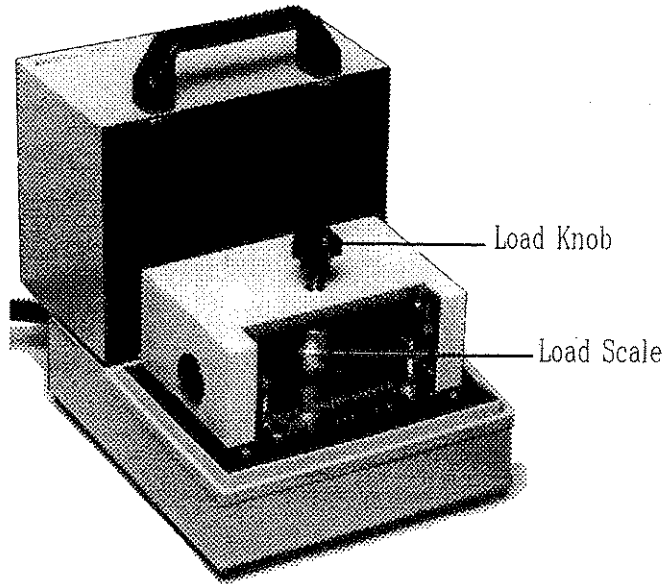

5. Perform an OPEN correction.
 - a. Turn the load knob counterclockwise(ccw) until the upper electrode does not move.

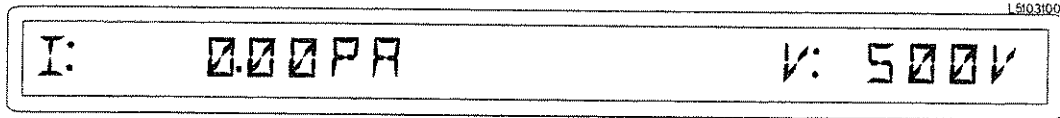

- b. Close the cover.
 - c. Press  . The measurement parameter I:(current) will be displayed.



- d. Press  . The Meas Time annunciator will indicate Long.
 - e. Press  . The V Output indicator will turn ON.
 - f. Wait until the I value has stabilized within 0.5 pA.
 - g. Press   .

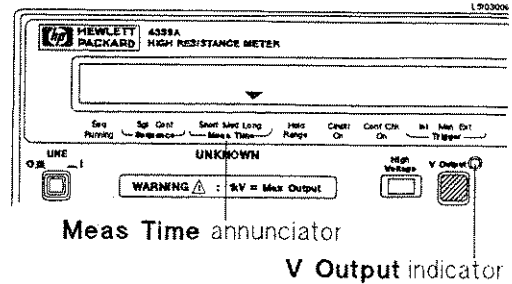

After a while, CORR: COMPLETE will be displayed, then the OPEN correction is completed. (If OUT OF LIMIT is displayed, see "To Perform OPEN Correction—Canceling the stray admittance in parallel with the DUT" in Chapter 2.)

- h. Press  . The V Output indicator will turn OFF.
6. Set the DUT.
 - a. Place the DUT on the Main electrode.

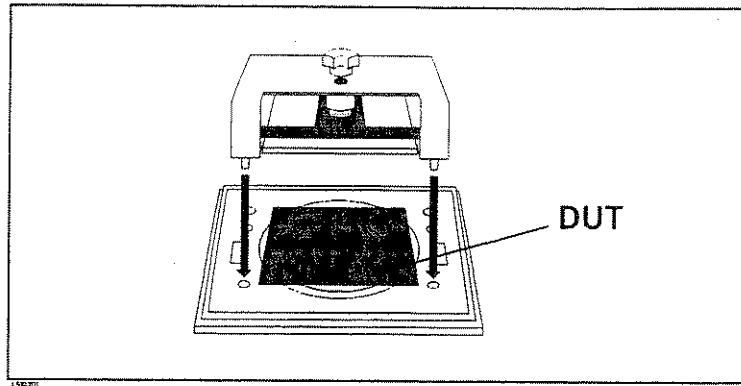

- b. Turn the load knob and stick the electrode on the DUT. (Let the load scale indicate more than 0 kg and less than 10 kg.)
 - c. Close the cover.
7. Set measurement parameter to RV (ρ_v : volume resistivity).
- a. Turn the Volume/Surface selector of the HP 16008B to "Volume".
 - b. Press several times until the measurement parameter RV: is displayed.

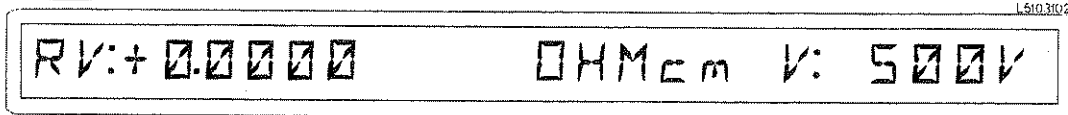

8. Set the measurement sequence function to the charging time of 1 minute.

- a. Press .

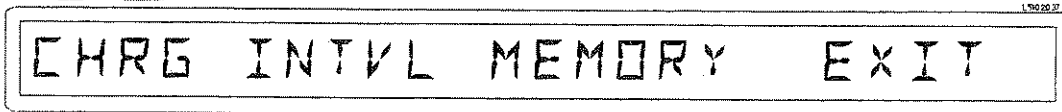

CHR G is blinking.

- b. Press .

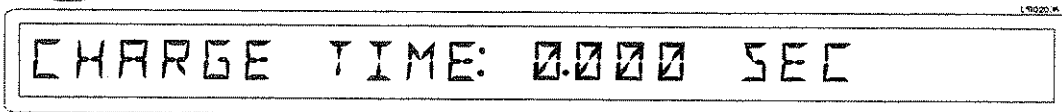

- c. Press .

- d. Press to EXIT.

- e. Press . The **Sequence** annunciator points to Sgl.

- 9. Press . After charging 1 minute, the measurement result will be displayed. The following figure shows the typical measurement result display.

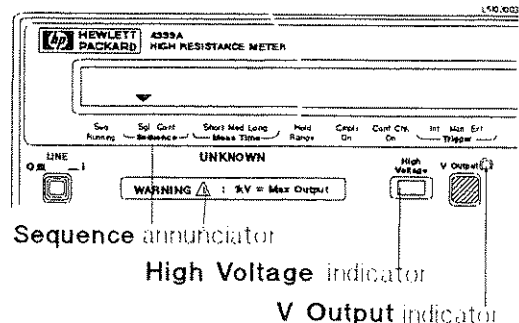

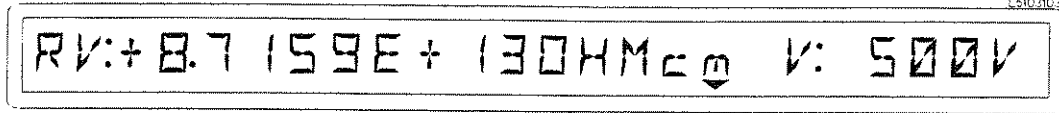

Seq Running Sgl Cont **Sequence** Short Med Long **Meas Time** Hold Range Compr On Cont Click On Int Man Ext **Trigger** Adrsd Rmt Key Shift Lock

For More Information

- To print out the measurement result — See “To Print Measurement Data” in Chapter 2
- To select other measurement parameters — See “To Select Measurement Parameter” in Chapter 2
- To select measurement level — See “To Set Test Voltage” in Chapter 2

REGIONAL SALES AND SUPPORT OFFICES

For information relating to Sales or Support of Hewlett-Packard products first contact your local Hewlett-Packard office listed in the white pages of your telephone directory. If none is listed locally, contact one of the addresses listed below to obtain the address or phone number of the Hewlett-Packard Sales or Support office nearest you.

ASIA

Hewlett-Packard Asia Ltd.
47/F, 26 Harbour Road,
Wanchai, HONG KONG
G.P.O. Box 863, Hong Kong
Tel: (852)5-8330833
Telex: 76793 HPA HX
Cable HPASIAL TD

AUSTRALASIA

Hewlett-Packard Australia Ltd.
31-41 Joseph Street
BLACKBURN, Victoria 3130
Australia
Tel: (61)895-2895
Telex: 31-024
Cable: HEWPARD Melbourne

CANADA

Hewlett-Packard (Canada) Ltd.
6877 Goreway Drive
MISSISSAUGA, Ontario L4V 1M8
Tel: (416)678-9430
Telex: 069-8644

JAPAN

Yokogawa-Hewlett-Packard Ltd.
29-21 Takaido-Higashi, 3 Chome
Suginami-ku TOKYO 168
Tel: 03(331)6111
Telex: 232-2024 YHPTOK

MEDITERRANEAN AND MIDDLE EAST

Hewlett-Packard S.A.
Mediterranean and Middle East
Operations
Atrina Centre
32 Kifissias Avenue
Paradissos-Amarousion, ATHENS
Greece
Tel: (30)682 88 11
Telex: 21-6588 HPAT GR
Cable: HEWPACKSA Athens

BENELUX & SCANDINAVIA

Hewlett-Packard S.A.
Uilenstede 475
P.O. Box 999
NL-1183 AG AMSTELVEEN
The Netherlands
Tel: (31)20/43 77 71
Telex: 18 919 hpncr nl

SOUTH & EAST EUROPE, AFRICA

Hewlett-Packard S.A.
7 rue du Bois-du-Lan
CH-1217 MEYRIN 2, Geneva
Switzerland
Tel: (41)22/83 12 12
Telex: 27835 hmca
Cable: HEWPACKSA Geneva

FRANCE

Hewlett-Packard France
Parc d'activites du Bois Briard
2, avenue du Lac
91040 EVRY Cedex
Tel: 1 6/077 83 83
Telex: 6923 15F

GERMAN FEDERAL REPUBLIC

Hewlett-Packard GmbH
Hewlett-Packard-Strasse
Postfach 1641
D-6380 BAD HOMBURG
West Germany
Tel: 06172/400-0
Telex: 410 844 hpbhg

ITALY

Hewlett-Packard Italiana S.p.A.
Via G. Di Vittorio 9
I-20063 CERNUSCO SUL
NAVIGLIO
(Milano)
Tel: 02/92 36-91
Telex: 334632

UNITED KINGDOM

Hewlett-Packard Ltd.
King Street Lane
Winnersh, WOKINGHAM
Berkshire RG11 5AR
Tel: 734/78/ 47 74
Telex: 847178

EASTERN USA

Hewlett-Packard Co.
4 Choke Cherry Road
ROCKVILLE, MD 20850
TEL: (301)670-4300

MIDWESTERN USA

Hewlett-Packard Co.
5201 Tollview Drive
ROLLING MEADOWS, IL 6008
Tel: (312)255-9800

SOUTHERN USA

Hewlett-Packard Co.
2000 South Park Place
P.O. Box 105005
ATLANTA, GA 30348
Tel: (404)955-1500

WESTERN USA

Hewlett-Packard Co.
5161 Lankershim Blvd.
P.O. Box 3919
NO. HOLLYWOOD, CA 91609
Tel: (818)506-3700

OTHER INTERNATIONAL AREAS

Hewlett-Packard Co.
Intercontinental Headquarters
3495 Deer Creek Road
PALO ALTO, CA 94304
Tel: (415)857-1501
Telex: 034-8300
Cable: HEWPACK

1
2
3
4
5
6
7
8
9
10
11
12
13
14
15
16
17
18
19
20
21
22
23
24
25
26
27
28
29
30
31
32
33
34
35
36
37
38
39
40
41
42
43
44
45
46
47
48
49
50
51
52
53
54
55
56
57
58
59
60
61
62
63
64
65
66
67
68
69
70
71
72
73
74
75
76
77
78
79
80
81
82
83
84
85
86
87
88
89
90
91
92
93
94
95
96
97
98
99
100

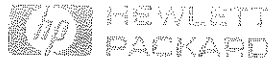

Reorder No. or
Manual Part No.
04339-90001

Copyright © 1992
Hewlett-Packard
Printed in Japan 6/92

**Manufacturing
Part No.
04339-90001**



04339-90001