

HP 4396A  
Network/Spectrum Analyzer  
Task Reference

---



---

**HP 4396A Network/Spectrum Analyzer**

# **Task Reference**

## **SERIAL NUMBERS**

This manual applies directly to instruments with serial number prefix 3241J. For additional information about serial numbers, read "Serial Number" in Appendix A of this manual.



**HP Part No. 04396-90000**  
**Microfiche Part No. 04396-90050**  
**Printed in Japan December 1992**

**First Edition**

---

**Notice**

The information contained in this document is subject to change without notice.

This document contains proprietary information that is protected by copyright. All rights are reserved. No part of this document may be photocopied, reproduced, or translated to another language without the prior written consent of the Hewlett-Packard Company.

Yokogawa-Hewlett-Packard, LTD.  
Kobe Instrument Division  
1-3-2, Murotani, Nishi-ku, Kobe-shi,  
Hyogo, 651-22 Japan

---

## Manual Printing History

The manual printing date and part number indicate its current edition. The printing date changes when a new edition is printed. (Minor corrections and updates that are incorporated at reprint do not cause the date to change.) The manual part number changes when extensive technical changes are incorporated.

December 1992 ..... First Edition

---

## **Safety Summary**

The following general safety precautions must be observed during all phases of operation, service, and repair of this instrument. Failure to comply with these precautions or with specific *WARNINGS* given elsewhere in this manual violates safety standards of design, manufacture, and intended use of the instrument.

*The Hewlett-Packard Company assumes no liability for the customer's failure to comply with these requirements.*

## **Ground The Instrument**

This is a Safety Class 1 product (provided with a protective earth terminal). An uninterruptible safety earth ground must be provided from the main power source to the product input wiring terminals, power source to the product input wiring terminals, power cord, or supplied power cord set. Whenever it is likely that the protection has been impaired, the product must be made inoperative and secured against any unintended operation.

## **DO NOT Operate in an Explosive Atmosphere**

Do not operate the instrument in the presence of flammable gases or fumes. Operation of any electrical instrument in such an environment is a safety hazard.

## **Keep Away From Live Circuits**

Operating personnel must not remove instrument covers. Component replacement and internal adjustments must be made by qualified maintenance personnel. Do not replace components with the power cable connected. Under certain conditions, dangerous voltages may exist even with the power cable removed. To avoid injuries, always disconnect power and discharge circuits before touching them.

## **DO NOT Service Or Adjust Alone**

Do not attempt internal service or adjustment unless another person, capable of rendering first aid and resuscitation, is present.

## **DO NOT Substitute Parts Or Modify Instrument**

Because of the danger of introducing additional hazards, do not substitute parts or perform unauthorized modifications to the instrument. Return the instrument to a Hewlett-Packard Sales and Service Office for service and repair to ensure the safety features are maintained.

## Dangerous Procedure Warnings

Warnings, such as the example below, precede potentially dangerous procedures throughout this manual. Instructions contained in the warnings must be followed.

**Warning**



---

**Dangerous voltages, capable of causing death, are present in this instrument. Use extreme caution when handling, testing, and adjusting this instrument.**

---

---

## Typeface Conventions

<b>Bold</b>	Boldface type is used when a term is defined. For example: <b>icons</b> are symbols.
<i>Italics</i>	Italic type is used for emphasis and for titles of manuals and other publications.  Italic type is also used for keyboard entries when a name or a variable must be typed in place of the words in italics. For example: <i>copy filename</i> means to type the word <i>copy</i> , to type a space, and then to type the name of a file such as <i>file1</i> .
Computer	Computer font is used for on-screen prompts and messages.
<b>HARDKEYS</b>	Labeled keys on the instrument front panel are enclosed in <b>□</b> .
<b>SOFTKEYS</b>	Softkeys located to the right of the CRT are enclosed in <b>◻</b> .



---

## Certification

Hewlett-Packard Company certifies that this product met its published specifications at the time of shipment from the factory. Hewlett-Packard further certifies that its calibration measurements are traceable to the United States National Institute of Standards and Technology, to the extent allowed by the Institution's calibration facility, or to the calibration facilities of other International Standards Organization members.

---

## Warranty

This Hewlett-Packard instrument product is warranted against defects in material and workmanship for a period of one year from the date of shipment, except that in the case of certain components listed in *General Information* of this manual, the warranty shall be for the specified period. During the warranty period, Hewlett-Packard Company will, at its option, either repair or replace products which prove to be defective.

For warranty service or repair, this product must be returned to a service facility designated by HP. Buyer shall prepay shipping charges to HP and HP shall pay shipping charges to return the product to Buyer. However, Buyer shall pay all shipping charges, duties, and taxes for products returned to HP from another country.

HP warrants that software and firmware designated by HP for use with an instrument will execute its programming instruction when properly installed on that instrument. HP does not warrant that the operation of the instrument, or software, or firmware will be uninterrupted or error free.

---

## Limitation of Warranty

The foregoing warranty shall not apply to defects resulting from improper or inadequate maintenance by Buyer, Buyer-supplied software or interfacing, unauthorized modification or misuse, operation outside of the environmental specifications for the product, or improper site preparation or maintenance.

*No other warranty is expressed or implied. HP specifically disclaims the implied warranties of merchantability and fitness for a particular purpose.*

---

## **Exclusive Remedies**

*The remedies provided herein are buyer's sole and exclusive remedies. HP shall not be liable for any direct, indirect, special, incidental, or consequential damages, whether based on contract, tort, or any other legal theory.*

---

## **Assistance**

Product maintenance agreements and other customer assistance agreements are available for Hewlett-Packard products.

For any assistance, contact your nearest Hewlett-Packard Sales and Service Office. Addresses are provided at the back of this manual.

## Safety Symbols

General definitions of safety symbols used on equipment or in manuals.



Instruction manual symbol: the product is marked with this symbol when it is necessary for the user to refer to the instruction manual in order to protect against damage to the instrument.



Indicates dangerous voltage (terminals fed from the interior by voltage exceeding 1000 volts must be so marked).

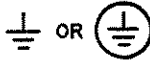

Protective conductor terminal. For protection against electrical shock in case of a fault. Used with wiring terminals to indicate the terminal which must be connected to ground before operating equipment.



Low-noise or noiseless, clean ground (earth) terminal. Used for a signal common, as well as providing protection against electrical shock in case of fault. A terminal marked with this symbol must be connected to ground in the manner described in the installation (Operation) manual, and before operating the equipment.

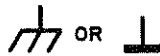

Frame or chassis terminal. A connection to the frame (chassis) of the equipment which normally includes all exposed metal structures.



Alternating current (power line).



Direct current (power line).



Alternating or direct current (power line).

**Warning**



**Warning** denotes a hazard. It calls attention to a procedure, practice, condition or the like, which, if not correctly performed or adhered to, could result in injury or death to personnel.

**Caution**



**Caution** denotes a hazard. It calls attention to a procedure, practice, condition or the like, which, if not correctly performed or adhered to, could result damage to or destruction of part or all of the product.

**Note**



**Note** denotes important information. It calls attention to a procedure, practice, condition or the like, which is essential to highlight.

---

## How To Use This Manual

This manual provides a procedure how to operate the HP 4396A. You can use this manual to learn about the operations and the features of the HP 4396A. When you have an objective but do not know how to accomplish it, this manual provides a best way to make your objective.

Following chapters are included in this manual

<b>Chapter</b>	<b>Description</b>
Chapter 1	This chapter provides how to access the functions and data entry of the HP 4396A. After chapter 2, procedure step is simplified about details. So, you should read this chapter and understand about the basic rules of the HP 4396A operation.
Chapter 2	This chapter provides a spectrum measurement procedure with the HP 4396A. If you want to know about an operation of the spectrum analyzer part of the HP 4396A, read this chapter. The HP 4396A has some useful features for a spectrum measurement. This chapter presents you how to use them.
Chapter 3	This chapter describes an typical spectrum measurement using the HP 4396A. When you want to operate the HP 4396A for a specific measurement, see this chapter.
Chapter 4	This chapter provides basic network measurement procedure with the HP 4396A. If you want to know about basic operation of the network analyzer part of the HP 4396A, read this chapter. The HP 4396A has some useful features for the network measurement. This chapter presents you how to use them.
Chapter 5	This chapter describes an advanced network measurement of the HP 4396A. When you want to operate the HP 4396A for a specific measurement, see this chapter.
Chapter 6	This chapter provides the procedures of a common feature that can be used for spectrum and network analyzer mode of the HP 4396A. Printing and saving/recalling data are also included in this chapter.

Appendix A provides a manual change history and an information of the serial number.

---

## Documentation Map

The following manuals are available for the analyzer.

### **Task Reference (HP Part Number 04396-90000)**

Task Reference helps you to learn how to use the analyzer. This manual provides simple step-by-step instructions without concepts.

### **User's Guide (HP Part Number 04396-90001)**

The User's Guide walks you through system setup and initial power-on, shows how to make basic measurements, explains commonly used features, and typical application measurement examples. After you receive your analyzer, begin with this manual.

### **Function Reference (HP Part Number 04396-90002)**

The Function Reference describes all function accessed from the front panel keys and softkeys. It also provides information on options and accessories available, specifications, system performance, and some topics about the analyzer's features.

### **Programming Guide (HP Part Number 04396-90003)**

The Programming Guide shows how to write and use BASIC program to control the analyzer.

### **HP-IB Command Reference (HP Part Number 04396-90004)**

The HP-IB Command Reference provides a summary of all available HP-IB commands. It also provides information on the status reporting structure and the trigger system (these features conform to the SCPI standard).

### **Using HP Instrument BASIC with the HP 4396A (Option 1C2 only) (HP Part Number 04396-90005)**

The Using HP Instrument BASIC with the HP 4396A describes how HP Instrument BASIC works with the analyzer.

### **HP Instrument BASIC Manual Set (Option 1C2 only), (HP Part Number E2083-90000)**

The HP Instrument BASIC User's Handbook introduces you to the HP Instrument BASIC programming language, provide some helpful hints on getting the most use from it, and provide a general programming reference. It is divided into three books, *HP Instrument BASIC Programming Techniques*, *HP Instrument BASIC Interface Techniques*, and *HP Instrument BASIC Language Reference*.

### **Performance Test Manual (HP Part Number 04396-90100)**

The Performance Test Manual explains how to verify conformance to published specifications.

### **Service Manual (Option 0BW only), (HP Part Number 04396-90101)**

The Service Manual explains how to adjust, troubleshoot, and repair the instrument. This manual is option 0BW only.

---

## Microfiche Copies of the Manual

Use the microfiche part number on the title page to order a package of 10 × 15 centimeter (4 × 6 inch) microfilm transparencies of the *User's Guide*, the *Task Reference*, the *Function Reference*, the *HP-IB Programming Guide*, the *HP-IB Command Reference*, the *Using HP Instrument BASIC with the HP 4396A*, the *Performance Test Manual*, and the *Service Manual*.

# Contents

---

<b>1. Overview</b>	
Key Operation Overview . . . . .	1-1
Hardkeys and Softkeys . . . . .	1-1
Toggle Keys . . . . .	1-1
Numerical Entries . . . . .	1-2
Notes . . . . .	1-2
Character Entries . . . . .	1-2
To Enter Characters . . . . .	1-2
<b>2. Recommended Spectrum Measurement Task Sequence</b>	
Step 1: Preparing for a Measurement . . . . .	2-2
To Connect an Unknown Signal . . . . .	2-2
To Preset the Analyzer . . . . .	2-2
To Select the Active Channel . . . . .	2-3
To Display Dual Channels . . . . .	2-3
To Select the Spectrum Analyzer Mode . . . . .	2-4
Step 2: Setting the Trigger . . . . .	2-5
To Select the Trigger Mode . . . . .	2-5
To Use the External Trigger . . . . .	2-6
To Set the Trigger Signal Polarity . . . . .	2-6
To Select the Sweep Condition . . . . .	2-6
Step 3: Selecting the Measurement Format . . . . .	2-7
To Select the Display Unit . . . . .	2-7
Notes . . . . .	2-7
Step 4: Setting the Frequency Range . . . . .	2-8
To Set the Center Frequency . . . . .	2-8
To Set the Marker Position to Center . . . . .	2-9
To Set the Maximum Peak to Center . . . . .	2-10
To Change the Center with the Specified Step Size . . . . .	2-10
Example: Displaying Harmonics . . . . .	2-11
To Set the Frequency Span . . . . .	2-12
To Set the Frequency Range to Full Span . . . . .	2-12
Notes . . . . .	2-12
To Narrow the Span Setting . . . . .	2-13
To Zoom To a Part of the Trace . . . . .	2-14
To Change the Zooming Magnification . . . . .	2-14
To Display a Zoomed Trace on the Other Channel . . . . .	2-14
To Zoom Between the Marker and the $\Delta$ Marker . . . . .	2-15
Step 5: Setting the Vertical Settings . . . . .	2-16
To Set the Reference Level . . . . .	2-17
Using the Entry Keys . . . . .	2-17
Using the Marker . . . . .	2-17
To Change the Scale per Division . . . . .	2-18
Step 6: Tuning the Settings . . . . .	2-19
To Set the Resolution Bandwidth (RBW) . . . . .	2-19
To Set the Video Bandwidth . . . . .	2-20

To Turn Off the Video Bandwidth . . . . .	2-20
To Minimize the Sweep Time . . . . .	2-21
Step 7: Performing Calibration . . . . .	2-22
To Perform the Reference Level Calibration . . . . .	2-22
To Use the External Reference . . . . .	2-23
To Turn Off Calibration . . . . .	2-24
To Perform the Calibration for the 75 $\Omega$ Configuration . . . . .	2-24
Step 8: Reading the Measured Result . . . . .	2-25
To Read a Value Using the Marker . . . . .	2-26
To Stabilize the Trace . . . . .	2-27
To Stop the Sweep . . . . .	2-27
To Use the Averaging Function . . . . .	2-27
To Use Maximum or Minimum Hold Function . . . . .	2-28
To Capture an Unstable Signal Using Signal Track . . . . .	2-28
To Use the Sub-markers . . . . .	2-29
To Use the $\Delta$ Marker . . . . .	2-30
To Search For a Single Peak on the Trace . . . . .	2-31
To Search For Multiple Peaks . . . . .	2-32
To Specify the Search Range . . . . .	2-33
Using the Marker . . . . .	2-33
Using the $\Delta$ Marker . . . . .	2-33
To Ignore Small Peaks . . . . .	2-35
Defining the Peak Threshold . . . . .	2-35
Using Rotary Knob . . . . .	2-35
Using the Marker . . . . .	2-35
Defining Peak Height . . . . .	2-36

### 3. Typical Spectrum Measurement Techniques

To Measure the Noise Level . . . . .	3-2
To Convert to a Different Equivalent Noise Bandwidth . . . . .	3-3
To Measure the Carrier to Noise Ratio . . . . .	3-4
To Perform the Time Gated Spectrum Analysis . . . . .	3-5
Step 1: Determining Gate Trigger Parameters . . . . .	3-5
Step 2: Gate Trigger Source Connection . . . . .	3-8
Step 3: Setting Center and Span Frequency . . . . .	3-8
Step 4: Adjusting Gate Trigger . . . . .	3-9
Step 5: Setting RBW, VBW, and Averaging . . . . .	3-10
To Set the Resolution Bandwidth . . . . .	3-10
To Set the VBW . . . . .	3-10
Step 6: Measuring . . . . .	3-11
To Measure Zero Span . . . . .	3-12
Notes . . . . .	3-12
To Stabilize the Trace Using the Video Trigger . . . . .	3-12
To Read a Time Transition Using the Marker . . . . .	3-13
To Track Unstable Harmonics Using Search Track . . . . .	3-14
To Track and Zoom a Signal . . . . .	3-15
Step 1: Setting the Wide Frequency Range . . . . .	3-15
Step 2: Setting the Narrow Frequency Range for the Other Channel . . . . .	3-15



<b>4. Recommended Network Measurement Task Sequence</b>	
Step 1: Preparing for a Measurement	4-2
To Connect the Test Device	4-3
To Preset the Analyzer	4-4
To Select the Active Channel	4-4
To Select the Network Analyzer Mode	4-4
Step 2: Setting the Sweep	4-5
To Select the Trigger Mode	4-5
To Use the External Trigger	4-6
To Set the Trigger Signal Polarity	4-6
To Trigger on Each Display Point	4-7
To Select the Sweep Condition	4-7
To Select the Sweep Type	4-7
To Use the Power Sweep	4-8
Step 3: Selecting the Measurement Format	4-9
To Select the Input Port	4-9
With the T/R Test Set	4-9
With the S-Parameter Test Set	4-9
To Select the Measurement Format	4-10
To Display Trace As a Smith Chart	4-11
To Change Marker Readout Format	4-11
To Use Impedance Conversion Function	4-12
Step 4: Setting the Sweep Parameter	4-13
To Set the Sweep Parameter Using <b>Start</b> and <b>Stop</b>	4-13
Step 5: Setting the Vertical Settings	4-14
To Set the Scale and Reference Automatically	4-14
Notes	4-15
Step 6: Tuning the Settings	4-16
To Increase the Dynamic Range (Setting IF Bandwidth)	4-16
Notes	4-16
Step 7: Performing Calibration	4-17
To Select an Appropriate Calibration Method	4-17
To Perform a Response Calibration	4-18
To Perform a Response & Isolation Calibration	4-18
To Perform an S11 1-Port Calibration	4-19
To Perform an S22 1-Port Calibration	4-20
To Make Full 2-Port Calibration	4-21
To Perform a 1-Path 2-Port Calibration	4-24
To Select the Calibration Kit	4-27
To Customize the User Defined Calibration Kit	4-27
To Define the Standard Definition	4-27
Step 1: Preparation	4-27
Step 2: Activating the Define Standard Menu	4-27
Step 3: Entering a C Parameters	4-28
Step 4: Entering an OFFSET Parameters	4-28
Step 5: Entering a Standard Class Label	4-28
Step 6: Completing the Definition of a Calibration Kit	4-28
To Define a Class Assignment	4-29
Step 1: Preparing for the Class Assignment	4-29
Step 2: Specifying the Class	4-30
Step 3: Labeling the Standard Class Label	4-30
To Label and Save Calibration Kit	4-30
To Verify Definition of User-Defined Calibration Kit	4-31
Step 8: Reading the Measured Result	4-32

To Read a Value Using the Marker . . . . .	4-32
To Stabilize the Trace . . . . .	4-33
To Stop the Sweep . . . . .	4-33
To Reduce Variation of the Measurement Trace Using Averaging . . . . .	4-33
To Restart the Averaging . . . . .	4-33
To Use the Sub-markers . . . . .	4-34
To Use the $\Delta$ Marker . . . . .	4-35
To Search For a Point that has the Target Value . . . . .	4-36
To Search for the Peak-to-Peak of Ripples Using the Statistics Function . . . . .	4-37
Step 1: To Specify the Search Range . . . . .	4-37
Step 2: To Search For the Ripple . . . . .	4-37
To Define the Peak for Search . . . . .	4-38
Defining the Peak Slope to Ignore the Relatively Broad Peaks . . . . .	4-38
Entering Directly . . . . .	4-38
Using the Marker . . . . .	4-38
Specifying the Peak Threshold to Ignore the Absolutely Small Peaks . . . . .	4-39
Entering Directly . . . . .	4-39
Using the Marker . . . . .	4-39

**5. Typical Network Measurements**

To Measure the 3 dB Bandwidth Using the Width Function . . . . .	5-2
To Monitor the Spectrum of the Network Measurement Input . . . . .	5-3
To Measure the Electrical Length . . . . .	5-4
To Set Velocity Factor of a Cable . . . . .	5-5
To Measure the Phase Deviation . . . . .	5-6
To Display the Deviation from the Linear Phase . . . . .	5-6
To Display the Group Delay . . . . .	5-7
To Set the Group Delay Aperture . . . . .	5-7
To Cancel an Extension of a Measurement Cable . . . . .	5-8
If the Electrical Delay of the Extended Cable is Known If the Electrical Delay of the Extended Cable is Unknown . . . . .	5-8
Measuring the Electrical Length of the Cable . . . . .	5-10
Measuring the OPENEd or SHORTEd Cable Reflection . . . . .	5-11
Notes . . . . .	5-11

**6. Using Features Common to Both Modes of Operation**

To Perform GO/NO-GO Testing . . . . .	6-2
Step 1: Planning the Limit Lime . . . . .	6-2
Step 2: Editing a Limit Line Table . . . . .	6-3
To Modify or Delete the Segment . . . . .	6-5
Step 3: Executing a Limit Line Test . . . . .	6-5
To Make a Limit Line Test Active . . . . .	6-5
To Beep When the Limit Test is Failed . . . . .	6-6
Notes . . . . .	6-6
To Offset the Limit Line . . . . .	6-7
To Make a List Sweep . . . . .	6-9
Step 1: Planning the List Sweep . . . . .	6-9
Step 2: Editing a Sweep List . . . . .	6-10

To Modify or Delete the Segment . . . . .	6-11
Step 3: Activating the List Sweep . . . . .	6-12
Notes . . . . .	6-12
To Use the Trace Memory . . . . .	6-13
Step 1: To Store the Trace into the Trace Memory . . . . .	6-13
Step 2: To Display Memory Traces . . . . .	6-13
Notes . . . . .	6-13
To Offset the Trace . . . . .	6-14
To Clear the Offset . . . . .	6-14
Notes . . . . .	6-14
To Use the Trace Math Function . . . . .	6-15
To Turn Off the Data Math Function . . . . .	6-15
To Multiply the Trace . . . . .	6-15
To Clear a Multiplied Trace . . . . .	6-15
To Print and Plot . . . . .	6-16
To Print Out a Display Image . . . . .	6-16
To See or Print a Measured Value List . . . . .	6-16
To Print an Analyzer Setting . . . . .	6-17
To Plot a Display Image . . . . .	6-17
To Plot to a Transparent Sheet . . . . .	6-18
To Use a Different HP-IB Address for the Printer/Plotter . . . . .	6-18
Notes . . . . .	6-18
To Save and Recall . . . . .	6-19
To Save an Analyzer Setting or Measurement Data . . . . .	6-19
To Specify a Data Array Type . . . . .	6-20
To Recall a Saved Analyzer Setting . . . . .	6-20
To Save a Display Image to an HP-GL File . . . . .	6-21
To Save Measured Data for a Spreadsheet . . . . .	6-22
To Copy the File . . . . .	6-23
To Initialize a Disk for Use . . . . .	6-23
To Initialize the RAM Disk for Use . . . . .	6-24
Notes . . . . .	6-24

**A. Manual Changes**

Introduction . . . . .	A-1
Manual Changes . . . . .	A-1
Serial Number . . . . .	A-2

**Index**

# Figures

---

1-1. Character Entry Menu . . . . .	1-3
2-1. Location of the S Input . . . . .	2-2
2-2. Dual Channel Display . . . . .	2-3
2-3. Location of EXT TRIGGER Connector . . . . .	2-6
2-4. Marker to Center . . . . .	2-9
2-5. Peak to Center . . . . .	2-10
2-6. Displaying Harmonics . . . . .	2-11
2-7. Narrowing Span with Signal Track . . . . .	2-13
2-8. Marker Zoom . . . . .	2-14
2-9. MKR $\Delta$ →SPAN . . . . .	2-15
2-10. Marker to Reference . . . . .	2-17
2-11. Changing Scale/Div. . . . .	2-18
2-12. Setting Resolution Bandwidth (RBW) . . . . .	2-19
2-13. Setting Video Bandwidth (VBW) . . . . .	2-20
2-14. Minimized Sweep Time . . . . .	2-21
2-15. Reference Level Calibration Connection . . . . .	2-23
2-16. Reference Level Calibration Connection for the 75 $\Omega$ Configuration . . . . .	2-24
2-17. Marker Readout . . . . .	2-26
2-18. Maximum Holding the Drifting Signal . . . . .	2-28
2-19. Sub-marker and Marker List . . . . .	2-29
2-20. $\Delta$ Marker . . . . .	2-30
2-21. Peak Search . . . . .	2-31
2-22. Searching for Multiple Peaks . . . . .	2-32
2-23. Search Range . . . . .	2-34
2-24. Threshold Function . . . . .	2-36
3-1. Noise Readout . . . . .	3-2
3-2. C/N Measurement . . . . .	3-4
3-3. Time Domain Measurement Configuration . . . . .	3-5
3-4. Target and Trigger Signal Timing on the Oscilloscope . . . . .	3-6
3-5. Gate Parameters . . . . .	3-7
3-6. Time Gated Measurement Configuration . . . . .	3-8
3-7. Time Gated Spectrum Analysis . . . . .	3-11
3-8. Marker Time . . . . .	3-13
3-9. Tracking Unstable Harmonics Using Search Track . . . . .	3-14
3-10. Tracking and Zooming a Signal . . . . .	3-16
4-1. Using the Transmission/Reflection Test Set . . . . .	4-3
4-2. Using the S-Parameter Test Set . . . . .	4-3
4-3. Location of EXT TRIGGER Connector . . . . .	4-6
4-4. Smith Chart . . . . .	4-11
4-5. Sweep Parameter Setting . . . . .	4-13
4-6. Autoscale Function . . . . .	4-14
4-7. Setting IF Bandwidth (IFBW) . . . . .	4-16
4-8. Marker Readout . . . . .	4-32
4-9. Sub-markers . . . . .	4-34
4-10. $\Delta$ Marker . . . . .	4-35

4-11. Ripple Parameters Readout . . . . .	4-37
4-12. Peak Definition . . . . .	4-39
5-1. Bandwidth Measurement Using Width Function . . . . .	5-2
5-2. Spectrum Monitoring in the Network Measurement . . . . .	5-3
5-3. Adding Electrical Length . . . . .	5-4
5-4. Deviation from the Linear Phase . . . . .	5-6
5-5. Setting Group Delay Aperture . . . . .	5-7
5-6. Port Extension With the T/R Test Set . . . . .	5-8
5-7. Cable Measurement Configuration . . . . .	5-10
5-8. Cable Measurement Configuration . . . . .	5-11
6-1. Limit Line Image . . . . .	6-2
6-2. Frequency, Upper and Lower Limit . . . . .	6-3
6-3. Limit Line Editor . . . . .	6-4
6-4. Limit Line Test . . . . .	6-5
6-5. Offsetting Limit Lines . . . . .	6-8
6-6. List Sweep (Upper) Reduces Sweep Time . . . . .	6-10
6-7. List Sweep Editor . . . . .	6-10
6-8. Offsetting the Trace . . . . .	6-14
6-9. Reading Saved Data from Spreadsheet Software . . . . .	6-22
A-1. Serial Number Plate . . . . .	A-2

# Tables

---

3-1. Minimum Gate Length setting with RBW setting . . .	3-10
4-1. Calibration Method Selection Table . . . . .	4-17
4-2. Example of the Standard Definitions (HP 85032B 50Ω Type-N Calibration Kit) . . . . .	4-27
4-3. Standard Class Assignment of the HP 85032B . . . . .	4-29
A-1. Manual Changes by Serial Number . . . . .	A-1
A-2. Manual Changes by Firmware Version . . . . .	A-1

# Overview

---

This chapter contains the following information:

- Key Operation Overview
- Numerical Entries
- Character Entries

After chapter 2, the procedural steps do not contain as much detailed information. Therefore, you should read this chapter to understand the basic rules of analyzer's operation.

---

## Key Operation Overview

### Hardkeys and Softkeys

There are two types of front-panel keys; hardkeys and softkeys. Most hardkeys that have a label display function menus on the right side of the display. These function menus are also called softkey menus.

Softkey menus list functions other than those accessed directly by the hardkeys. To activate a function that is on a softkey menu, press the key located to the right of the displayed function label.

This manual uses the following conventions:

<b>Hardkey</b>	Indicates a hardkey
<b>Softkey</b>	Indicates a softkey

### Toggle Keys

Some softkeys toggle menu settings. On a softkey label, the currently active setting is displayed in high intensity and upper case characters. The inactive setting is displayed in low intensity and lower case characters.

This manual shows a toggled setting as follows:

- Toggle **DUAL CHAN** on **OFF** to **ON** off.

This line means that the dual channel function is currently OFF. You turn it ON by pressing the corresponding softkey. The resulting upper case expression, **ON**, shows that the function is now active (ON).

For more information about each hardkey and softkey, see the *Function Reference* manual.

## Numerical Entries

A numerical data entry is preceded by some function settings. For example, before entering a center frequency you must specify the center frequency value. The analyzer provides the following three ways to enter numerical data:

Using	Description
Numerical keys 0 .. 9	Enters numerical data directly and terminates the entry using the units terminator keys. This capability is useful when you know the value you must enter. For example, to enter 1 MHz, press 1 (M/μ).
↑ and ↓ key	Increments or decrements the settings. This is useful for changing settings broadly.
Rotary knob 	Changes settings continuously. This is useful if you want to change the setting while verifying changes on the display.

**Notes** You can use following techniques when entering numerical data:

- If you enter a wrong character, press **Back Space** to erase the last character entered.
- If you want to clear the current entry, press **Entry Off**.

---

## Character Entries

Save, recall, and display title functions require character entries. When a function that requires character entry is activated, a character entry menu is displayed (see Figure 1-1).

You can enter the characters by using following procedure:

### To Enter Characters

1. Move the cursor ("↑") under the character you want to enter.
2. Press **SELECT LETTER** or **X1**.
3. Repeat step 1 and 2 until all characters are entered.
4. Press **DONE**.



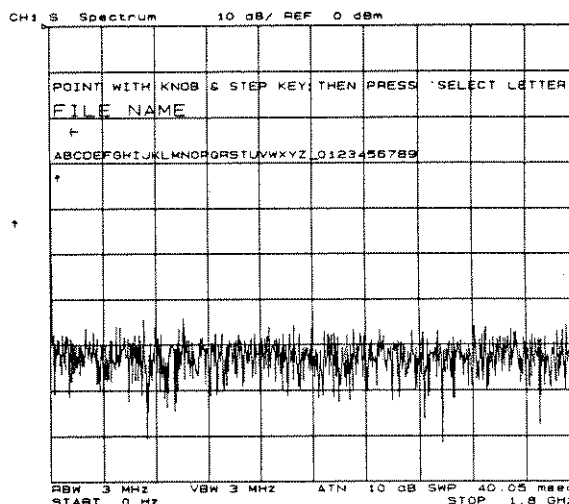

Figure 1-1. Character Entry Menu

You can use the following techniques when entering characters:

- If you want to use different case characters, press  $\uparrow$  and  $\downarrow$  to toggle the upper and lower case of an alphabet list:

ABCDEFGHIJKLMNOPQRSTUVWXYZ\_0123456789

abcdefghijklmnopqrstuvwxyz\_0123456789

- If you enter a wrong character, press **BACK SPACE** or **Back Space** to erase the last entered character.
- If you want to clear the current entry, press **ERASE TITLE**.

If the keyboard is connected, you can use it for the character entry.  
(Option 1C2 only)



## Recommended Spectrum Measurement Task Sequence

---

This chapter describes a typical task sequence commonly used for any measurement using the spectrum analyzer mode.

If you are using the analyzer for the first time, see the *User's Guide* first. The *User's Guide* provides the information needed to install and set up the analyzer, and a quick start guide to introduce you to the analyzer.

The measurement tasks described in this chapter are as follows:

- Step 1: Preparing for a measurement
- Step 2: Setting the trigger
- Step 3: Selecting the measurement format
- Step 4: Setting the frequency range
- Step 5: Setting the vertical settings
- Step 6: Tuning the settings
- Step 7: Performing calibration
- Step 8: Reading the measured result

Generally, you can make a measurement by performing these steps. If you want to perform a more complex spectrum measurement, chapter 3 provides additional measurement techniques.

### Step 1: Preparing for a Measurement

This step prepares the analyzer for a spectrum measurement. You must perform the following procedures before you enter measurement parameters (such as frequency range).

- To connect an unknown signal
- To preset the analyzer
- To select the active channel
- To select the spectrum analyzer mode

#### To Connect an Unknown Signal

- Connect the unknown signal to the S input on the front panel.

The S input is a standard N 50  $\Omega$  female connector. If you want to connect the BNC cable, use the N-BNC adapter (furnished).

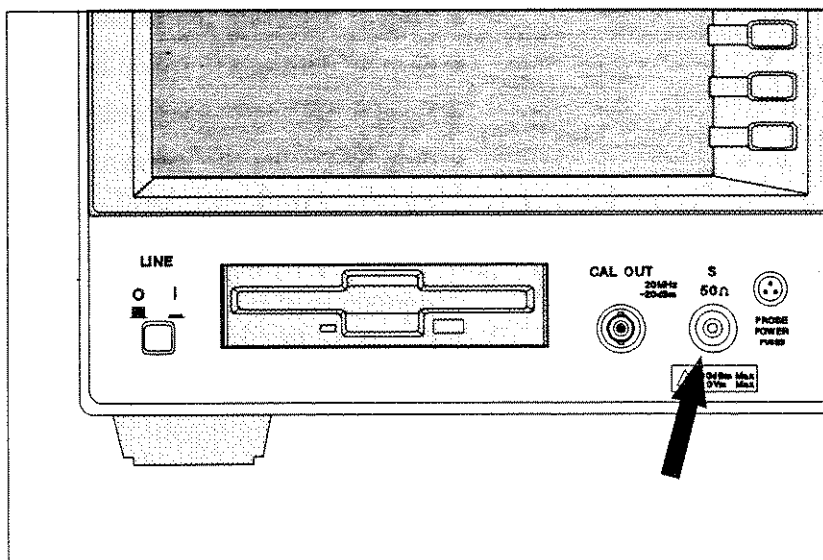

C5202001

Figure 2-1. Location of the S Input

#### To Preset the Analyzer

- In the INSTRUMENT STATE block, press the green **Preset** key to set the analyzer to the preset state.

For additional information about the preset state, see appendix D of the *Function Reference*.

### To Select the Active Channel

- In the ACTIVE CHANNEL block, press **Ch 1** (channel 1) or **Ch 2** (channel 2) to toggle the active channel.

The analyzer has two independent channels. Each channel can have different settings that include whether the mode of operation is network analyzer or spectrum analyzer. Select the active channel before you select any other settings.

You can display two channels simultaneously.

### To Display Dual Channels

1. Press **Display**.
2. Toggle **DUAL CHAN** on OFF to ON off.
3. Press **MORE**.
4. Select the following display modes:

Display Mode	Toggle
Split channel	<b>SPLIT CHAN</b> on OFF to ON off
Overlap channel	<b>SPLIT CHAN</b> ON off to on OFF

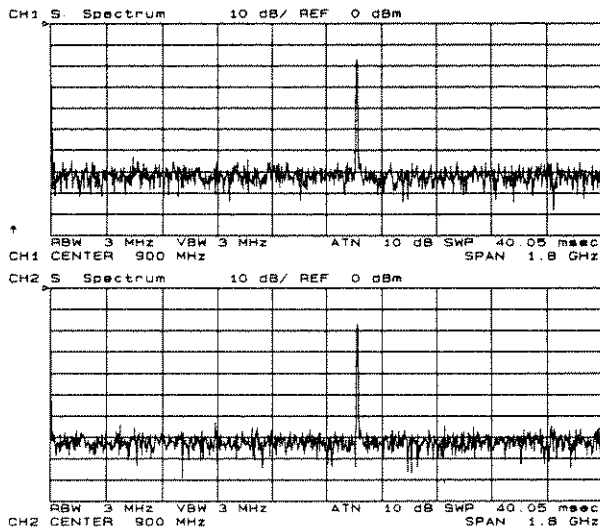

Toggle to **SPLIT DISP** ON off.

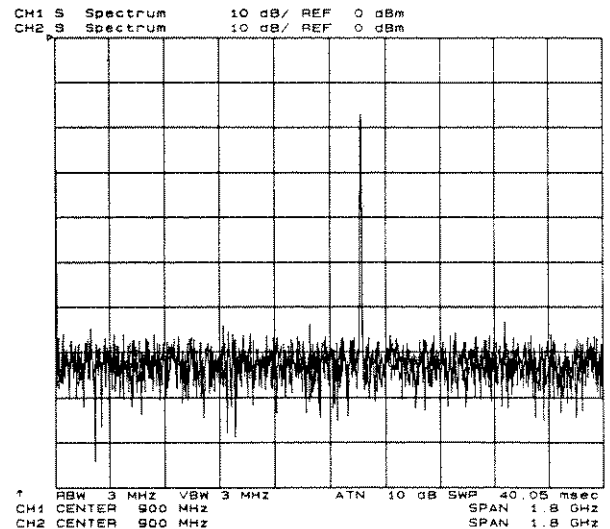

Toggle to **SPLIT DISP** on OFF.

Figure 2-2. Dual Channel Display

## Preparing for a Measurement

### To Select the Spectrum Analyzer Mode

1. Press **Meas**.
2. Press **ANALYZER TYPE**, **SPECTRUM ANALYZER**.

When you change the analyzer type (mode), the analyzer is reset to a known state. So, you must select the analyzer type before you select any additional settings.

## Step 2: Setting the Trigger

This step selects the trigger source and the sweep condition using the following procedures:

- To select the trigger mode
  - To use the external trigger
- To select the sweep condition

### To Select the Trigger Mode

1. Press **Trigger**.
2. Press **TRIGGER: [FREE RUN]**.
3. Select the trigger mode:

To Select a Trigger to	Press
Internal trigger source	FREE RUN
External trigger source	EXTERNAL <sup>1</sup>
Video trigger	VIDEO <sup>2</sup>
Manual	MANUAL
Time gated trigger	GATE <sup>3</sup>

<sup>1</sup> See the "To Use the External Trigger" procedure.

<sup>2</sup> The "To Stabilize the Trace Using the Video Trigger" in Chapter 3, describes how to use this trigger mode.

<sup>3</sup> The "To Perform the Time Gated Spectrum Analysis" in Chapter 3, describes how to use this trigger mode. This function is option 1D6 only.





### Step 3: Selecting the Measurement Format

This step provides the following procedure:

- To select the display unit

#### To Select the Display Unit

1. Press **Format**.
2. Select unit:

To Display	Unit	Press
Power	dBm	dBm
	W	WATT
Voltage	dBV	dBV
	dB $\mu$ V	dBuV
	V	VOLT

2: Spectrum Measurement Task

You can change the displayed unit anytime you want. The analyzer calculates the unit conversion using the internal stored data. The sweep is not required (it can even be in the hold state).

**Notes** For more information about each unit, see chapter 5 of the *Function Reference*.

If you want to make a noise measurement instead of a spectrum measurement, see “To Measure the Noise Level” in Chapter 3.





### Step 4: Setting the Frequency Range

The analyzer has some useful commands for setting the frequency range. This step provides the following procedures that are related to setting the frequency range.

- To set the center frequency
  - To set the marker position to center
  - To set the maximum peak to center
  - To change the center with the specified step size
- To set the frequency span
  - To set the frequency range to full span
  - To narrow the span setting
- To zoom to a part of the trace
  - To change the zooming magnification
  - To display a zoomed trace on the other channel
  - To zoom between the marker and the  $\Delta$ marker

#### To Set the Center Frequency

1. Press **Center** to activate the center frequency function.
2. Change the center frequency to place the target signal in the center of the grid by using the following keys:

To	Use
Set directly	 ...  and units terminator keys
Change continuously	
Change with 1-2-5 steps <sup>1</sup>	 

<sup>1</sup> You can change the step size of  . See "To Change the Center with the Specified Step Size" in this step.

## Setting the Frequency Range

### To Set the Marker Position to Center

1. Press **Marker** to display the reverse-triangle shaped marker.
2. Place the marker on the position you want to set to the center by using the rotary knob.
3. Press **MKR**→**CENTER**.
4. Press **Entry Off**.

The center frequency setting immediately changes to the marker position. If you are measuring an unknown signal, display the signal in full span first. Then move the signal to the center using this function.

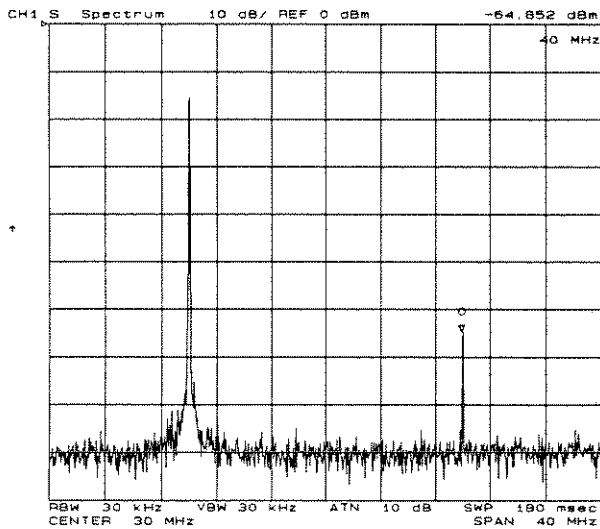

Move the marker

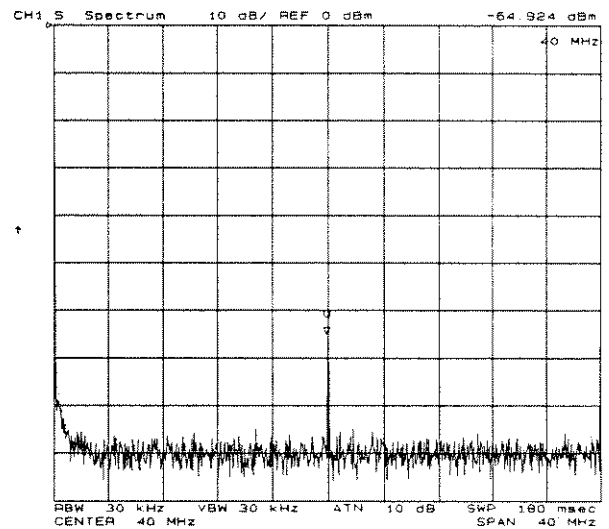

Press **MKR**→**CENTER**

Figure 2-4. Marker to Center

## Setting the Frequency Range

### To Set the Maximum Peak to Center

1. Press **Marker→**.
2. Press **PEAK→CENTER**.
3. Press **Entry Off**.

This function changes the center frequency to display the maximum peak in the center of the grid.

### Note



When the frequency span setting is too wide, the peak cannot be placed in the center of the grid correctly. If the peak is not on the center of the grid, press **PEAK→CENTER** again.

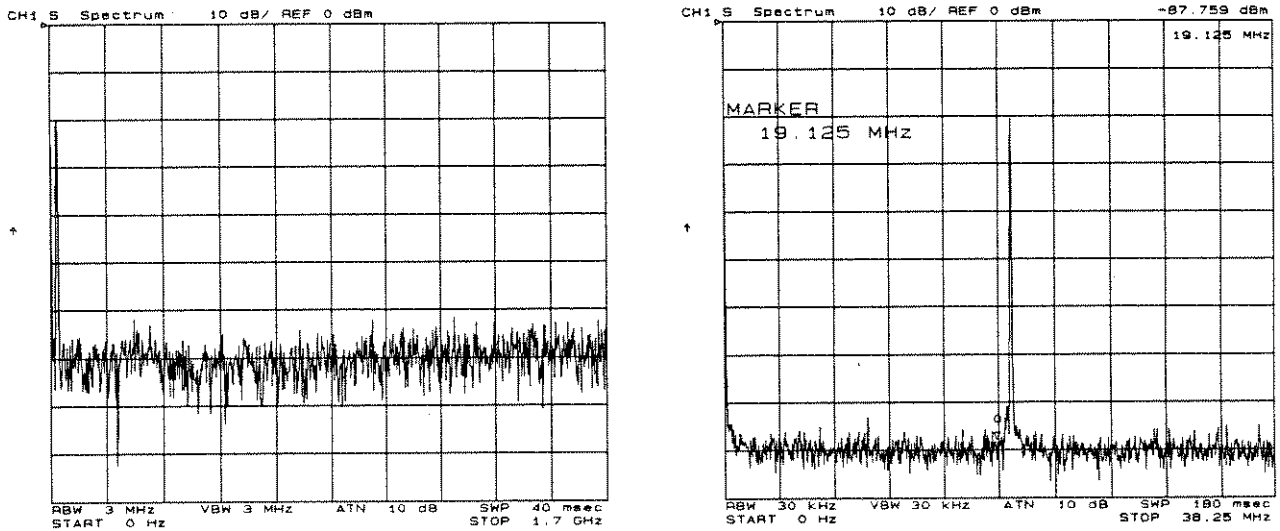

Figure 2-5. Peak to Center

### To Change the Center with the Specified Step Size

1. Press **Center**.
2. Do one of the following:
  - Press **CENTER STEP SIZE**. Then set a step size directly by using **0** ... **9** and the units terminator keys.
  - Press **Marker**. Move the marker to the point you want to use as the step size frequency. Then press **Center** **MKR→CNTR STEP**.
3. Toggle **STEP SIZE AUTO** man to auto **MAN**.
4. Press **Center**.
5. Press **↑** to increment (or **↓** to decrement) the center frequency setting the specified step size.

## Setting the Frequency Range

This function is useful to display peaks that have a constant interval (such as a harmonics) one after the other. The following example shows how to display the harmonics using this function.

**Example: Displaying Harmonics.** When you want to display the fundamental and the harmonics of 100 MHz signal:

1. Press **Center** 100 **(M/μ)**. Then set the span to display the fundamental in the center of the grid.
2. Press **Span** 150 **(M/μ)**.
3. Toggle **Search** **SEARCH TRK** on OFF to ON off to enable the search track function.
4. Press **SEARCH:PEAK** to move the marker on the fundamental.
5. Press **Center** **MKR→CNTR STEP**. Enter 100 MHz (so the step size matches the fundamental frequency).
6. Toggle **STEP SIZE** **AUTO** man to auto **MAN** to enable the specified step size.
7. Press **Center**. Then press **(↑)** to display the second harmonic.
8. To display higher order harmonics, press **(↑)** as required.

The marker searches for the next harmonic each time you change the center frequency by using the search track function.

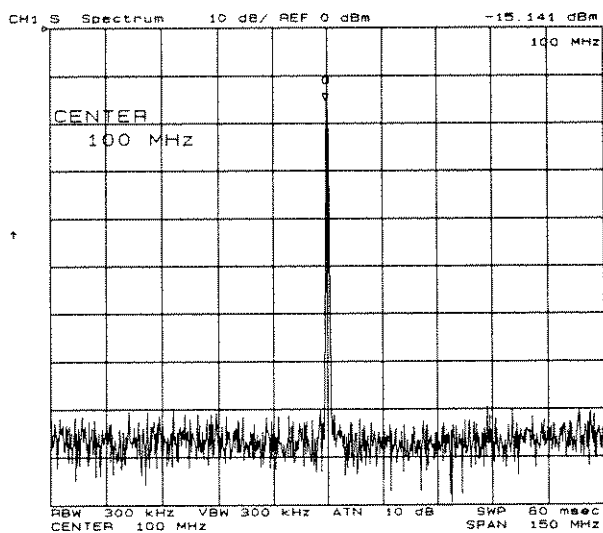

Fundamental

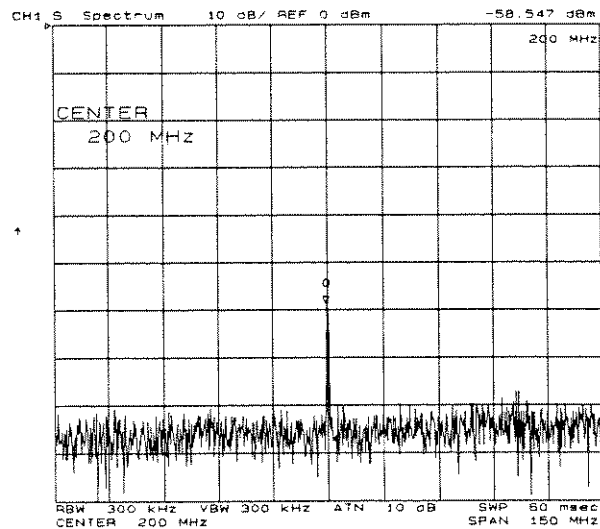



Second Harmonics

Figure 2-6. Displaying Harmonics

## Setting the Frequency Range

### To Set the Frequency Span

1. Press **Span**.
2. Enter the frequency span to display the target peak in the optimum grid setting.

To	Use
Set directly	<b>0</b> ... <b>9</b> and units terminator keys
Change continuously	
Change with 1-2-5 steps	 

### To Set the Frequency Range to Full Span

1. Press **Span**.
2. Press **FULL SPAN**.

This function is useful when you want to get a general view of the spectrum after you have obtained the detailed view of a specific signal.

**Notes** You can set the sweep parameter using **Start** and **Stop** instead of **Center** and **Span**. See "To Set the Sweep Parameter Using **Start** and **Stop**" in Chapter 4.

## To Narrow the Span Setting

1. Press **Search**.
2. Press **SEARCH:PEAK** to place the marker on the carrier.
3. Toggle **SIGNAL TRK on OFF** to **ON off**.
4. Narrow the span setting. See the "To Set the Frequency Span" procedure.

When you narrow the span setting substantially, the test signal can disappear from display. This happens because of the difference between the displayed and actual frequencies. For example, when the span setting is set to full span, the displayed test signal frequency has an error of approximately 2 MHz because of its resolution (1.8 GHz/800). If you narrow the span setting to less than the error frequency, the test signal can be lost from the display.

The signal track function allows you to avoid this situation. When signal track is enabled, the analyzer narrows the span setting while centering the test signal as you narrow the span setting. Therefore, the test signal is placed in the center of the grid.

The following figures show an example of narrowing the span with the signal track function. The actual signal frequency is 1.00001 GHz. When the center is fixed and the span is 10 kHz, the signal is out of display. The signal track function tracks the signal by changing the center frequency, and keeps displaying the signal in the center of the display.

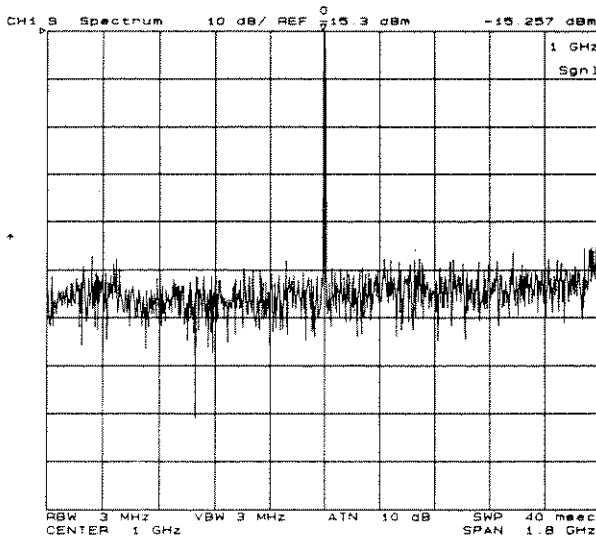

Span 1.8 GHz

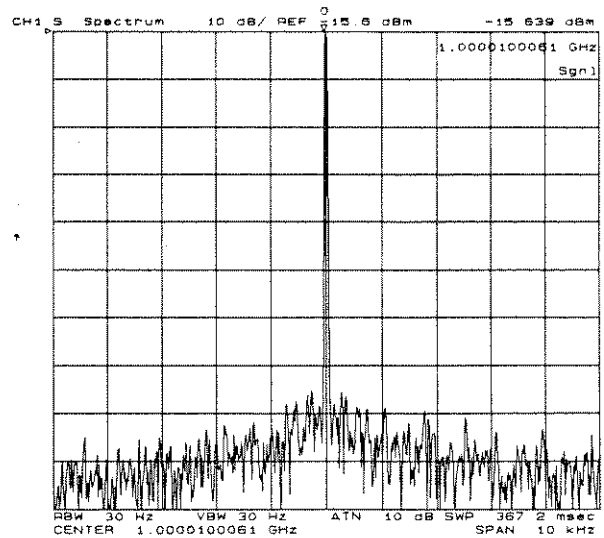

Span 10 kHz

Figure 2-7. Narrowing Span with Signal Track

## Setting the Frequency Range

### To Zoom To a Part of the Trace

1. Move the marker to the point where you want to observe the signal details.
2. Press **Marker→**.
3. Press **MKR ZOOM**.
4. To zoom more, press **MKR ZOOM** again.

### To Change the Zooming Magnification

1. Press **MORE ZOOMING APERTURE**.
2. Enter a zooming aperture value as a percentage of the span.  
If you want to magnify the display 20 times, enter 5% for the zooming magnification.

### To Display a Zoomed Trace on the Other Channel

1. Display two channels on the CRT. See the "To Display Dual Channels" procedure.
2. Toggle **Marker→ CROSS CHAN** on **OFF** to **ON**.
3. Press **MKR ZOOM**.

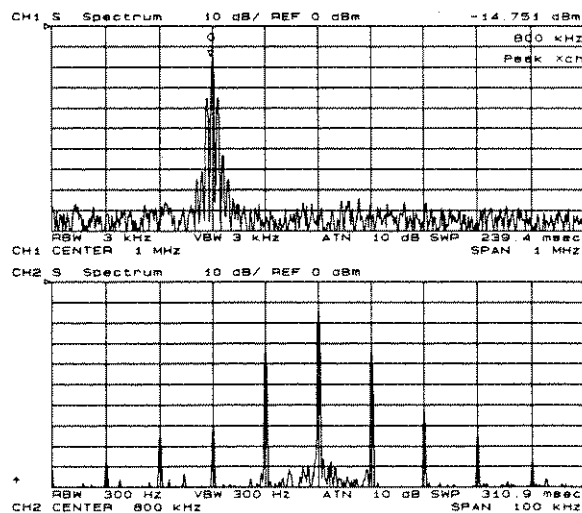



Figure 2-8. Marker Zoom



To Zoom Between the Marker and the  $\Delta$ Marker

1. Press **Marker**.
2. Move the marker to the start point you want to zoom to by using the .
3. Press  **$\Delta$ MODE MENU  $\Delta$ MKR**.
4. Move the marker to the end point you want to zoom to by using the .
5. Press **Marker  $\rightarrow$  MORE**.
6. Press **MKRA  $\rightarrow$  SPAN**.

The center frequency and span setting are changed automatically to display the specified area. You can display the zooming result on the other channel by toggling **CROSS CHAN on OFF** to **DN off**.

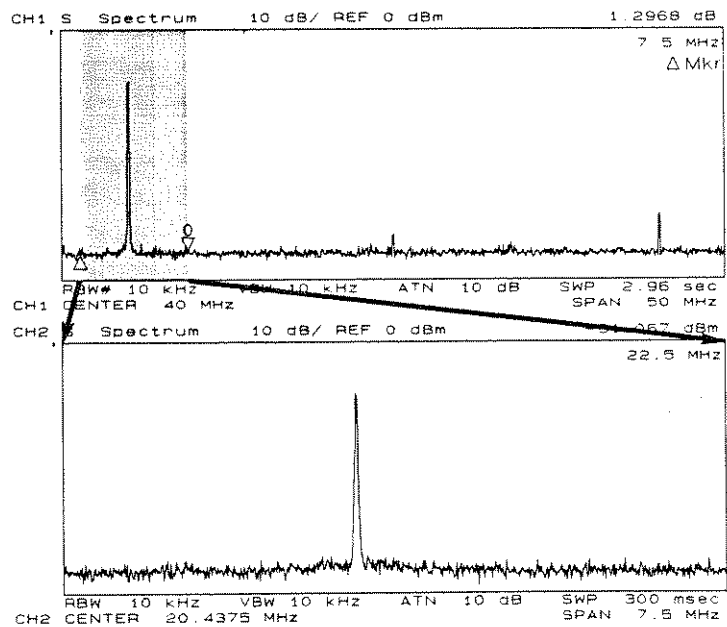
Figure 2-9. MKRA  $\rightarrow$  SPAN

### Step 5: Setting the Vertical Settings





You need to change the vertical settings if the top of peak is out of the grid or a signal level is too small relative to a reference setting. To change the vertical settings, change the reference value or spread the display area by changing the scale per division setting by doing one of the following procedures:

- To set the reference level
- To change the scale per division

## To Set the Reference Level

### Using the Entry Keys

1. Press **Scale Ref**.
2. Press **REFERENCE VALUE**.

To	Use
Move trace toward top	 or 
Move trace toward bottom	 or 
Set reference value directly	<b>0</b> ... <b>9</b> and unit keys

### Using the Marker

1. Press **Search** **SEARCH:PEAK** to move the marker to the peak.
2. Press **Scale Ref**.
3. Press **MKR→REFERENCE**.

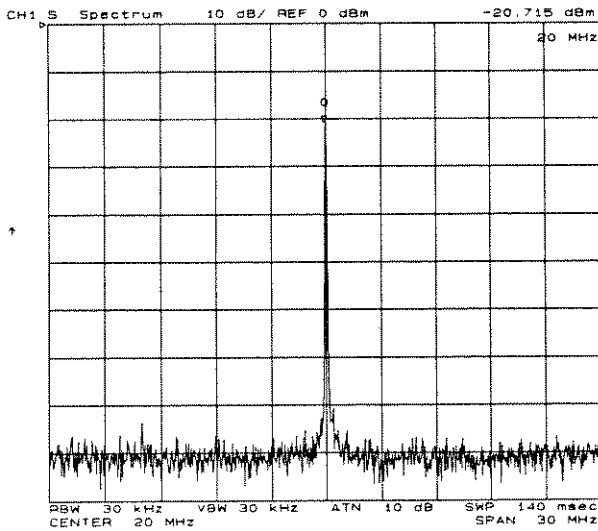

Move the marker to the top of the peak

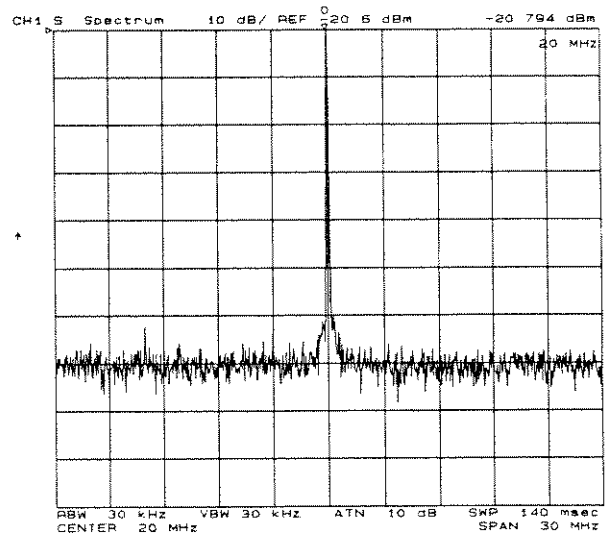



Press **Scale Ref** **MKR→REFERENCE**

Figure 2-10. Marker to Reference

## Setting the Vertical Settings

### To Change the Scale per Division

1. Set the reference level to the peak level of the target signal. See the "To Set the Reference Level" procedure.
2. Press **Scale Ref**.
3. Press **SCALE/DIV**.
4. Change the scale/division setting to display additional details by using following keys:

To	Use
Change continuously	
Change 1-2-5 steps	 
Set Scale/Div directly	<b>0</b> ... <b>9</b> and unit keys

This function can be used to display a small peak on a full grid.

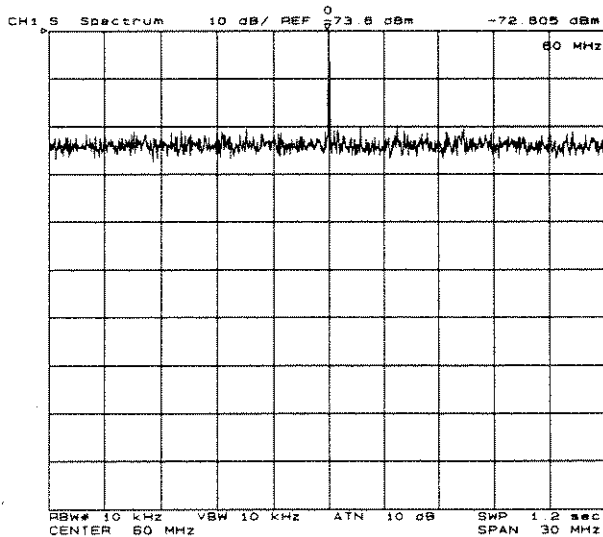

Scale 10 dB/Div

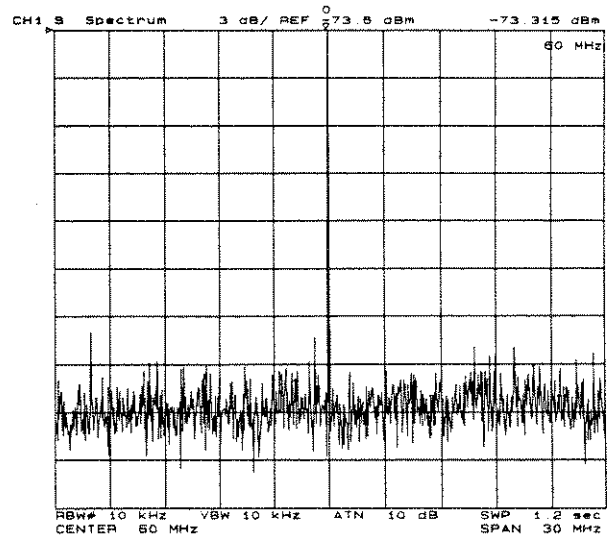

Scale 3 dB/Div

Figure 2-11. Changing Scale/Div.

## Step 6: Tuning the Settings

This step provides the bandwidth settings. The RBW setting affects the resolution of the frequency and lowers the displayed noise floor. The video bandwidth setting reduces noise variation.

- To set the resolution bandwidth (RBW)
- To set the video bandwidth
- To minimize the sweep time

### To Set the Resolution Bandwidth (RBW)

1. Press **Bw/Avg**.
2. Change the RBW setting by using **↑**, **↓**, or the **↻**.

If the internal IF filter is wider than the difference of the adjacent signals, the analyzer cannot separate them. You must set the Resolution Bandwidth (RBW) narrower to make sure the analyzer can recognize each signal. For more information about RBW, see the *Function Reference*.

Narrowing the RBW reduces the noise power per display point. As a result, the displayed noise floor is down and the lower level signal is displayed.

For example, the trace of a 20 kHz amplitude modulated signal conceals sidebands in the skirt of the carrier trace when the RBW is 10 kHz. If you set the RBW to 1 kHz, the carrier and sidebands are split completely and the displayed noise floor is down.

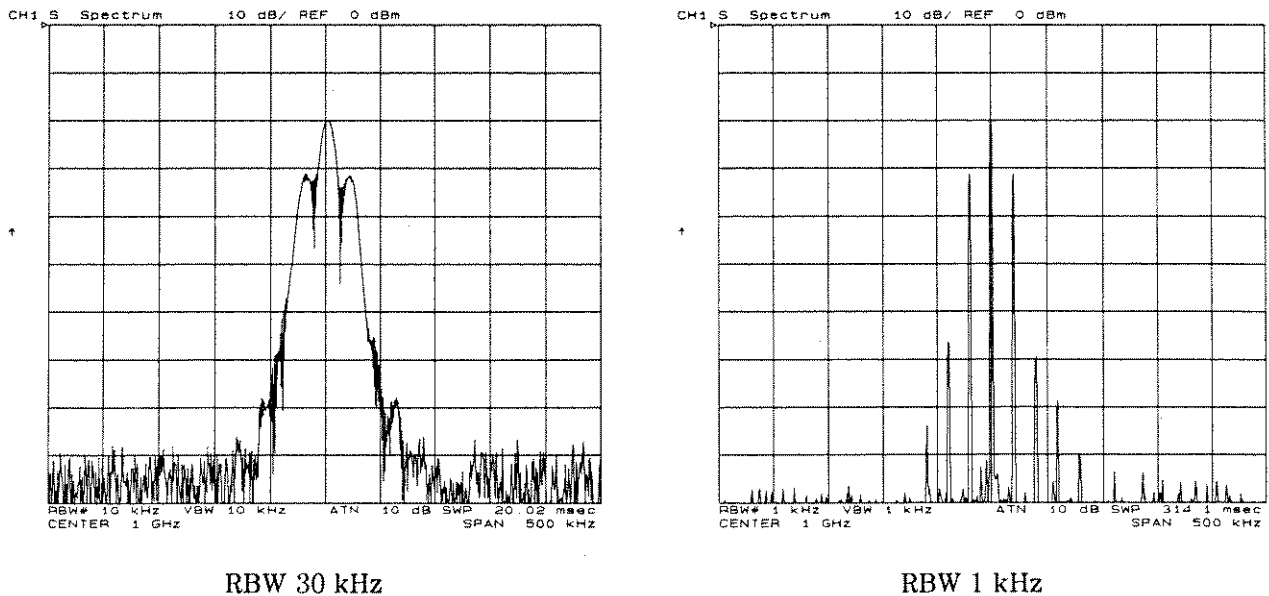



Figure 2-12. Setting Resolution Bandwidth (RBW)

## Tuning the Settings

### To Set the Video Bandwidth

1. Press **Bw/Avg**.
2. Press **VIDEO BW**.
3. Set video bandwidth by using the following keys:

To	Use
Lower noise level	<b>↓</b> , or 
Faster sweep time	<b>↑</b> , or 
Set bandwidth directly	<b>0</b> ... <b>9</b> and unit keys

When the target signal and the noise are hard to distinguish because of noise variation, narrow the video bandwidth. This reduces the noise variations and makes the signal clearly visible. However, if the video bandwidth is narrowed, the sweep takes more time.

The allowable VBW setting is 1/1, 1/3, 1/10, 1/30, 1/100, and 1/300 of the current RBW setting.

### To Turn Off the Video Bandwidth

1. Press **Bw/Avg** **VIDEO BW**.
2. Enter the same value as the RBW setting.

For more information about the VBW, see chapter 12 of the *Function Reference* manual.

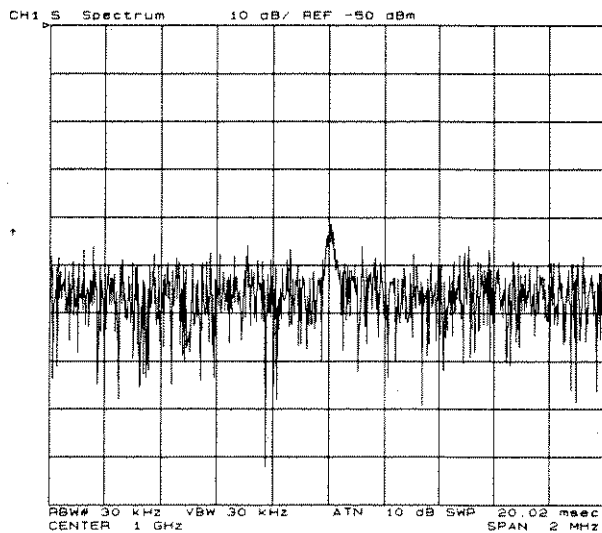

Video BW 10 kHz

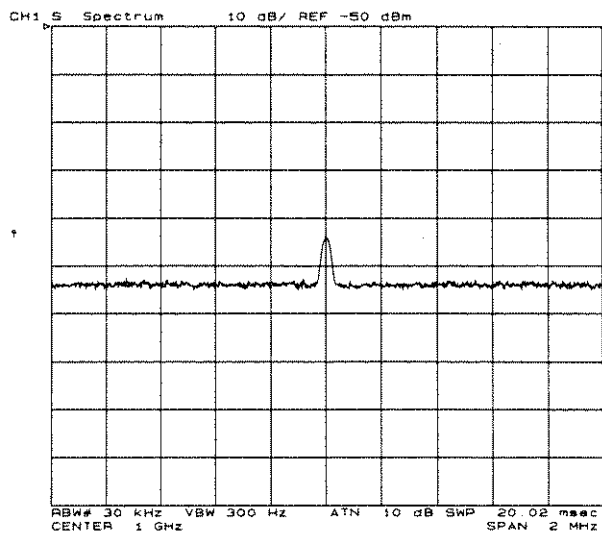

Video BW 300 Hz

Figure 2-13. Setting Video Bandwidth (VBW)

## To Minimize the Sweep Time

1. Press **Sweep**.
2. Press **SWEEP TIME**.
3. Press **0** **X1**.

The analyzer reduces the NOP (number of points) to equalize the display resolution and the RBW. As a result, the displayed trace becomes rough. However, the frequency readout resolution does not change.

This feature is effective when the RBW is greater than Span/(NOP-1). For more information about this feature, see chapter 6 of the *Function Reference* manual.

Figure 2-14 shows an example of minimizing the sweep time. Center, span, VBW, and RBW settings are the same, but the sweep time that is shown on the right bottom of each trace is different. The sweep time of channel 2 is approximately 25% of channel 1.

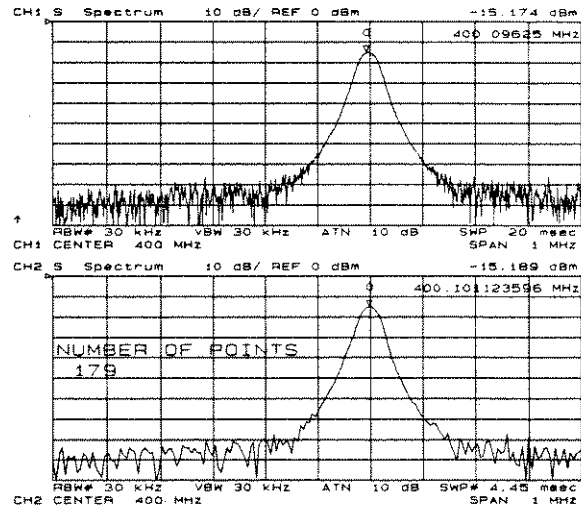

Figure 2-14. Minimized Sweep Time

### Step 7: Performing Calibration

This step provides procedures for the reference level calibration. Performing the reference level calibration improves the level accuracy.

- To perform the reference level calibration
- To use the external reference
- To turn off the calibration

#### To Perform the Reference Level Calibration

1. Wait at least 30 minutes after the analyzer is turned on. This warming up period is required to meet the analyzer's specifications.
2. Attach the N(m)-BNC(f) adapter (furnished) to an input (S, R, A, or B). (See Figure 2-15.)
3. Connect the CAL OUT output and the selected input using the BNC cable (furnished).
4. Press **Meas**. Then select the input (that the cable is connected to) by pressing **S**, **R**, **A** or **B**.
5. Press **Cal**.
6. Press **EXECUTE LVL CAL**.

The analyzer automatically changes the frequency setting to measure the CAL OUT signal. When the reference level calibration is completed, all measurement settings are restored.

After the calibration is completed, "Cor" appears on the left side of the grid.

To obtain a higher level measurement accuracy, perform the reference level calibration just before reading the measured value. If you change the setting of the RBW or the attenuator, you must perform the reference level calibration again. The analyzer stores the calibration data individually for each of the inputs.

The error terms that are canceled by the reference level calibration are described in chapter 12 of the *Function Reference* manual.



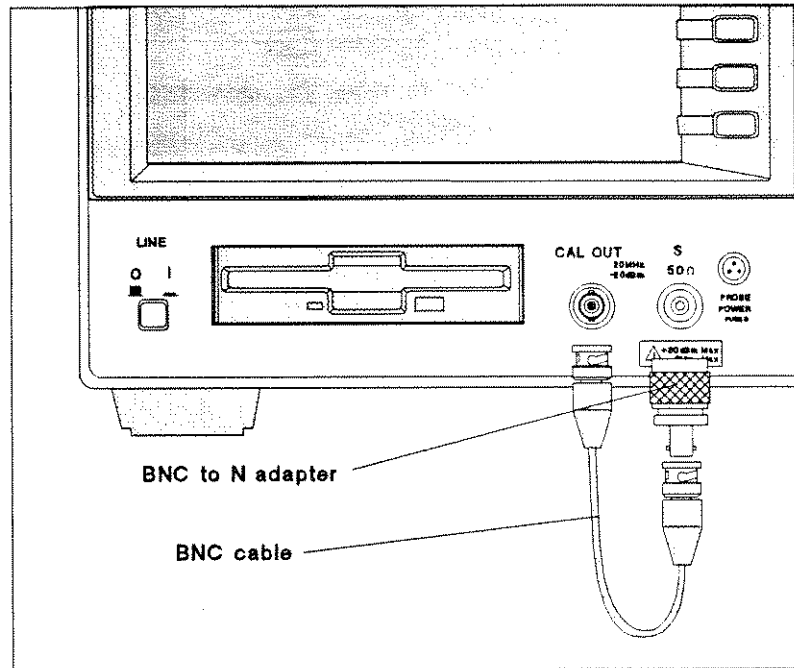

Figure 2-15. Reference Level Calibration Connection

### To Use the External Reference

You can use an external reference signal instead of the internal reference.

1. Wait at least 30 minutes after the analyzer is turned on. This warming up period is required to meet the analyzer's specifications.
2. Connect the external reference to the selected front-panel spectrum input.
3. Set up the frequency range to measure the external reference signal.
4. If a unit other than dBm is selected, press **Format** dBm .
5. Press **Search** SEARCH:PEAK . Then move the marker to the peak of the external reference signal.
6. Read the external reference signal level.
7. Calculate the *expected level* – *readout level* of the reference signal.
8. Press **Cal** LVL CAL DATA . Then enter the calculated value.

## Performing Calibration

### To Turn Off Calibration

1. Press **Cal**
2. Press **LVL CAL DATA**. Then press **0** **×1**

The “Cor” notation disappears from the display.

### To Perform the Calibration for the 75 Ω Configuration

If you want to perform a reference level calibration in the 75 Ω configuration:

1. If the analyzer is not set up for a 75 Ω configuration, see appendix A of the *User's Guide*.
2. Confirm that the analyzer is configured to measure the 75 Ω configuration by pressing **Cal** **INPUT Z**.
3. Wait at least 30 minutes after the analyzer is turned on. This warming up period is required to meet the analyzer's specifications.
4. Attach the 75 Ω N(m) to 50 Ω BNC(f) adapter to the HP 11852B option C04 50 Ω(m)/75 Ω(f) minimum loss pad that is connected to the S input. (See Figure 2-16.)
5. Connect the CAL OUT and the S input with the 50 Ω BNC cable.
6. Press **EXECUTE LVL CAL**.
7. After the completion of calibration, disconnect the BNC cable.
8. Detach the 75 Ω N(m) to 50 Ω BNC(f) adapter.

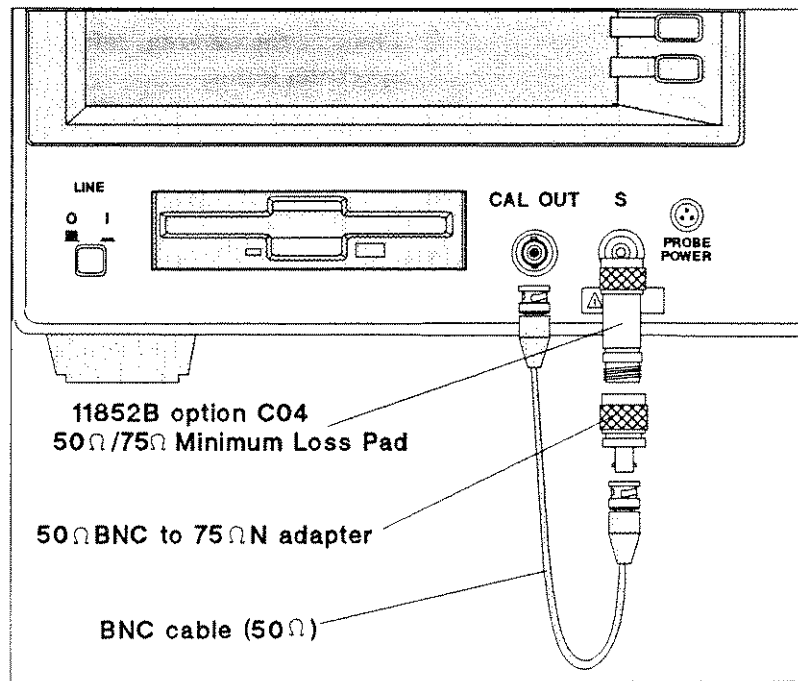

**Figure 2-16.**  
**Reference Level Calibration Connection for the 75 Ω Configuration**

## Step 8: Reading the Measured Result

If you can display the correct trace on the display, you can read the measured signal level using the marker. The analyzer has several useful search functions. This step provides the procedures for reading the measured results using the marker.

- To read a value using the marker
- To stabilize the trace
- To use the sub-markers
- To use the  $\Delta$ marker
- To search for a single peak on the trace
- To search for multiple peaks
- To ignore small peaks

## Reading the Measured Result

### To Read a Value Using the Marker

1. Press **Marker**.
2. Move the marker by performing the following steps:
  - Turn the rotary knob until the marker moves to the point where you want to read the measured value.
  - Enter the target frequency by using numerical keys.
3. Read the marker value displayed on the upper right of the display.

If you want a more accurate frequency reading of the target signal, set the span and the RBW as narrow as possible.

#### Note



The readout resolution of the frequency is determined by the setting of the frequency span, the number of points (NOP), and the resolution bandwidth (RBW). The resolution is the larger value between  $\text{SPAN}/(\text{NOP}-1)$  and RBW. For example, when the frequency span is 10 MHz, the NOP is 801, and the RBW is 10 kHz, the readout resolution is approximately 12.5 kHz.

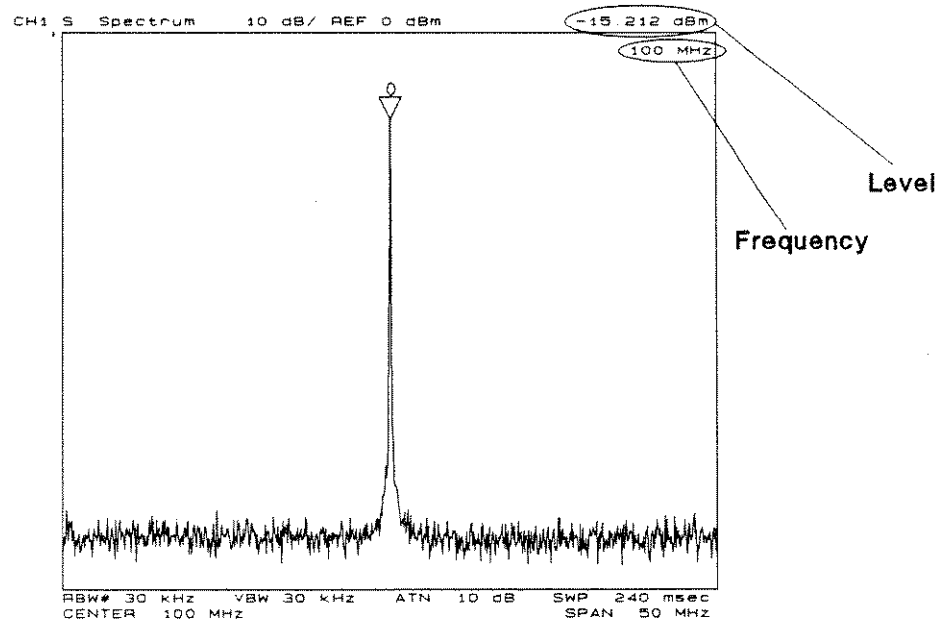

Figure 2-17. Marker Readout

**To Stabilize the Trace**

When the trace is not stable and the marker value changes frequently, it is difficult to read the measured value. You can use the following techniques to stabilize the trace:

- Stop the sweep.
- Use the averaging function.
- Use the maximum or minimum hold function.
- Capture the unstable signal using signal track.

**To Stop the Sweep**

1. Press **Trigger**.
2. Press **SWEEP: HOLD**.

The sweep is stopped immediately (even if the sweep is in progress). If you want to restart the sweep, press **CONTINUOUS** to start a free-run sweep or press **SINGLE** to make a single sweep.

**To Use the Averaging Function**

1. Press **Bw/Avg**.
2. Press **AVERAGING FACTOR**.
3. If needed, enter the averaging factor (number of times). Then press the **×1**. Default averaging factor is 16.
4. Toggle **AVERAGING** on **OFF** to **ON** off.

The averaging notation (Avg) appears on left side of the grid when averaging is turned on. The averaging notation indicates the number of times averaging has been performed. When averaging is completed, the counter stops incrementing. However, the trace continues updating with each sweep.

Averaging requires a sweep with a specified number of times that is enough for an averaging factor to complete the averaging. You can set the number of sweeps by using the number of groups function.

If you want to change the setting of any parameter when averaging, you can restart averaging from the 0 count.

To restart the averaging, press **Bw/Avg** **AVERAGING RESTART**. This resets averaging counter to 0.

## Reading the Measured Result

### To Use Maximum or Minimum Hold Function

1. Press **Display**.
2. Press **DATA HOLD [OFF]**.

To Hold	Press
Maximum Level	<b>MAX</b>
Minimum Level	<b>MIN</b>

“Max” (or “Min”) appears on the right of the grid when the maximum (minimum) hold function is activated.

To turn off the maximum or minimum hold, press **Display**  
**DATA HOLD [MAX] HOLD: OFF**.

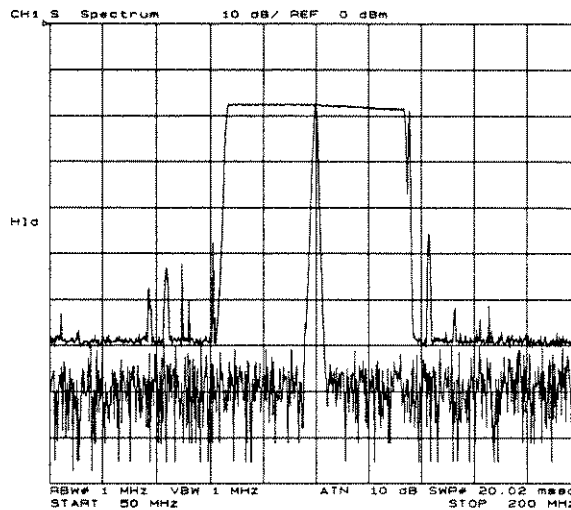

Figure 2-18. Maximum Holding the Drifting Signal

### To Capture an Unstable Signal Using Signal Track

1. Press **Search**.
2. Press **SEARCH:PEAK** to move the marker to the peak of the drifting test signal.
3. Toggle **SIGNAL TRK** on **OFF** to **ON** off.

The signal track function captures the peak that is indicated by the marker and places it in the center of the grid for each sweep. If the peak is unstable horizontally, use this function. The analyzer automatically changes the center frequency to keep the peak in the center of the grid.

## To Use the Sub-markers

1. Press **Marker**.
2. Move the marker to the point where you want to set the sub-marker.
3. Press **SUB MKR**.
4. Select the sub-marker from **SUB MKR 1 to 7**.
5. Press **Utility**.
6. Toggle **MKR LIST on OFF to ON** off to display the marker list on the bottom of the display.

The sub-marker appears at the point of that the marker is displayed. Sub-markers are fixed horizontally and you cannot move them.

The sub-marker value can only be displayed by using the marker list.

To clear a sub-marker, press **Marker CLEAR SUB MKR**. Then press the sub-marker number that you want to erase from the display.

To clear all of the markers, press **Marker PRESET MKRS**.

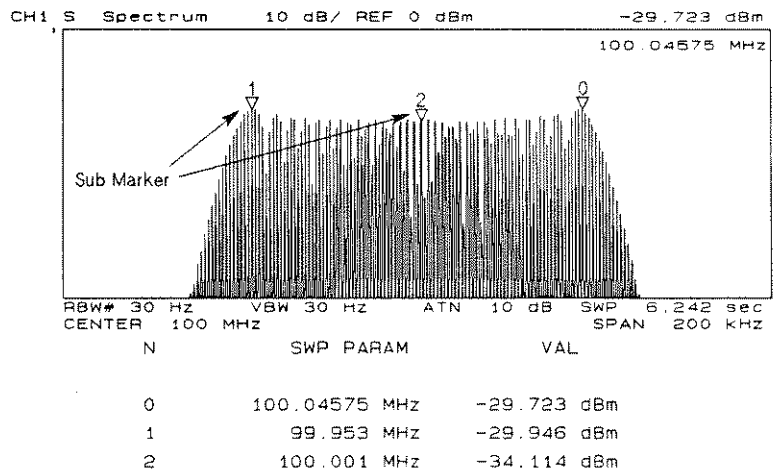



Figure 2-19. Sub-marker and Marker List

## Reading the Measured Result

### To Use the $\Delta$ Marker

1. Press **Marker**.
2. Place the marker at the point you want use as the reference point by using the .
3. Press  **$\Delta$ MODE MENU**.
4. Press  **$\Delta$ MKR**.
5. The reference marker appears at the marker point.
6. To move the marker:
  - Enter an offset frequency by using the numerical keys.
  - Turn the rotary knob until the marker moves to the point you want to read the value.
7. Read the level and the frequency differences from the reference marker that are displayed on the upper right of the grid.

The marker value on the upper right of the grid shows the frequency and the level differences between the reference marker and the marker.

When you use the sub-markers, use the marker list to display the difference between reference the marker and the sub-markers.

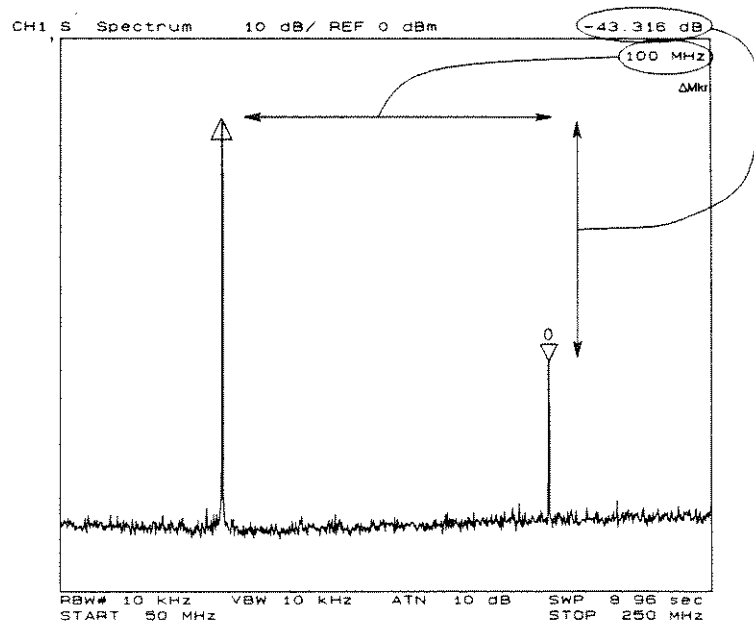

Figure 2-20.  $\Delta$ Marker



To Search For a Single Peak on the Trace

1. Press **Search**.
2. Press **SEARCH:PEAK** to search a maximum peak.
3. If you want to search for another peak:

To search next peak for	Press
2nd highest peak	NEXT PEAK
Peak just to the left	NEXT PEAK LEFT
Peak just to the right	NEXT PEAK RIGHT

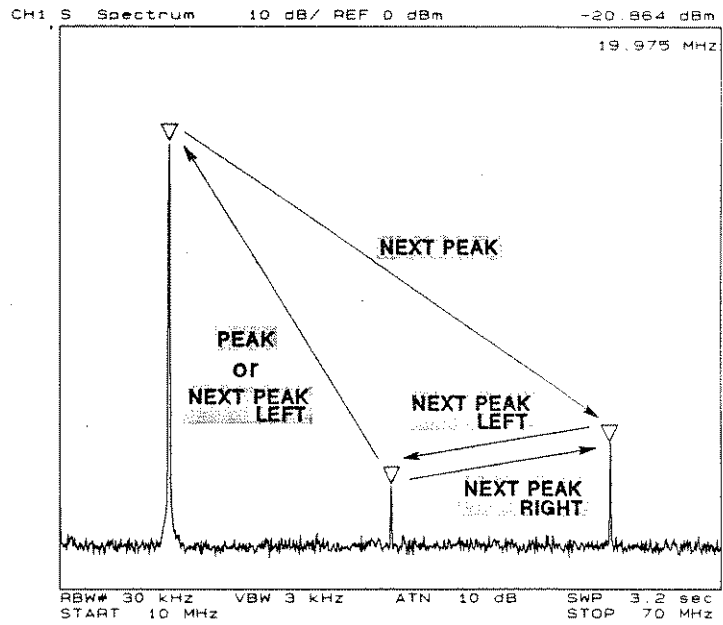

Figure 2-21. Peak Search

## Reading the Measured Result

### To Search For Multiple Peaks

1. Press **Search** **MULTIPLE PEAKS**.

2. Do any of following:

To search for peaks	Press
For the all peaks	<b>SEARCH: PEAKS ALL</b>
For peaks on the right	<b>PEAKS RIGHT</b>
For peaks on the left	<b>PEAKS LEFT</b>

3. Press **Utility**. Toggle **MKR LIST** on **OFF** to **ON** off to list all marker values.

When this function is enabled, the marker is placed on the maximum peak and the sub-markers are placed on up to seven other peaks. **PEAKS ALL** searches for all the peaks and places the sub-markers in the order of peak level.

**PEAKS RIGHT** and **PEAKS LEFT** search only to the right or left side of the peak and place the sub-markers on peaks in the order found.

If the frequency of the carrier is unstable, use the search track function by toggling **Search** **SEARCH TRK** on **OFF** to **ON** off. The analyzer searches for the peaks each sweep to capture the shifted carrier and any harmonics or sidebands.

If the marker is to search for peaks other than harmonics, specify the peak threshold for the search function. This makes the search function ignore the peaks that have a lower level than the threshold level. See the "To Ignore Small Peaks" procedure.

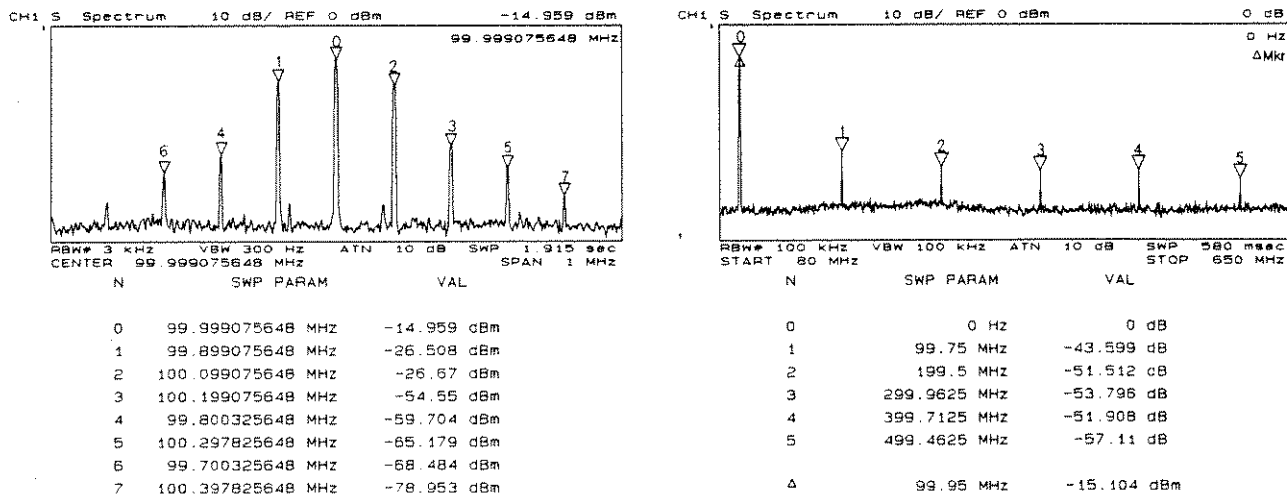

**PEAKS: ALL**

**PEAKS RIGHT with Δmarker**

Figure 2-22. Searching for Multiple Peaks

## To Specify the Search Range

You can set the search function to search within a specified range. To specify the search range, use one of the following two procedures:

- Using the marker
- Using the  $\Delta$ marker

### Using the Marker

1. Press **Search**.
2. Press **SEARCH RANGE MENU**.
3. Toggle **PART SRCH** on **OFF** to **ON** off.
4. Move the marker to the start point of the search range.
5. Press **MKR→LEFT RNG** to set the marker position as the left edge of the range.
6. Move the marker to the end point of the search range.
7. Press **MKR→RIGHT RNG** to set the marker position to the right edge of the range.
8. Press **RETURN**.

### Using the $\Delta$ Marker

1. Press **Marker**.
2. Move the marker to the start point of the search range.
3. Press  **$\Delta$ MODE MENU**.
4. Press  **$\Delta$ MKR**.
5. Move the marker to the end point of the search range.
6. Press **Search**.
7. Press **SEARCH RANGE MENU**.
8. Toggle **PART SRCH** on **OFF** to **ON** off to enable the search range.
9. Press **MKRA→SEARCH RNG**.

All the search functions search within a specified search range. You can specify the search range for each channel individually. The triangle-shaped indicator at the bottom of the grid shows the current search range (see Figure 2-23). In this figure, PEAK searches for the highest peak within the specified range. It does not search all of the grid.

## Reading the Measured Result

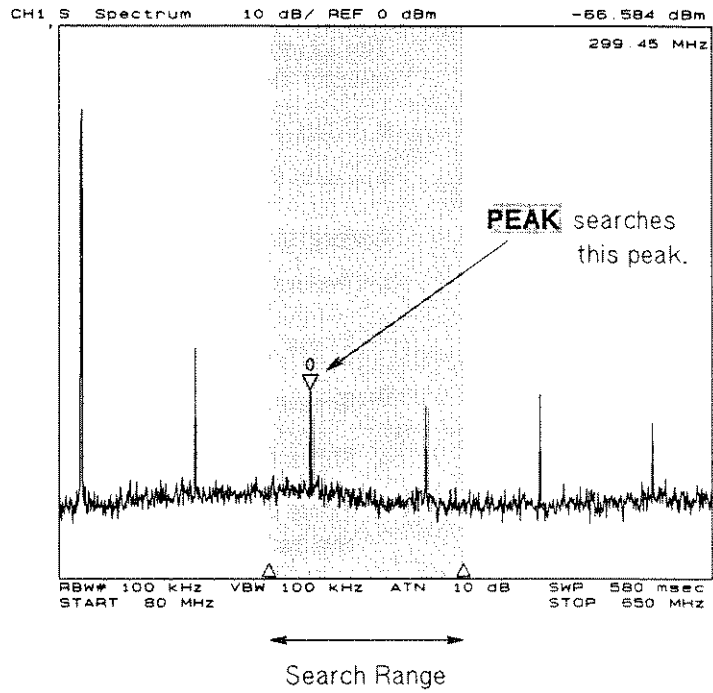

**Figure 2-23. Search Range**

To turn off the part search, toggle **PART SRCH ON** off to on **OFF**.

**To Ignore Small Peaks**

You can set the search function to ignore small peaks (such as noise) by defining the peak. The analyzer accept the following two types of peak definition.

- Peak threshold
- Peak height

**Defining the Peak Threshold****Using Rotary Knob.**

1. Press **Search**.
2. Press **SEARCH:PEAK PEAK DEF MENU**.
3. Toggle **THRESHOLD on OFF** to **ON off** to display the red threshold line.
4. Press **THRESHOLD VALUE**. Then set the threshold value using the following:
  - Enter the threshold value using numerical keys.
  - Turn the rotary knob to move the threshold line to the appropriate position.
5. Press **RETURN**

**Using the Marker.**

1. Press **Search SEARCH:PEAK**.
2. Move the marker to the point you want to set as a threshold value.
3. Press **PEAK DEF MENU MKR→THRESHOLD**.
4. Toggle **THRESHOLD on OFF** to **ON off**.
5. Press **RETURN**

When the peak threshold is activated, the red threshold line is displayed. The marker search function searches only for peaks above the threshold line.

## Reading the Measured Result

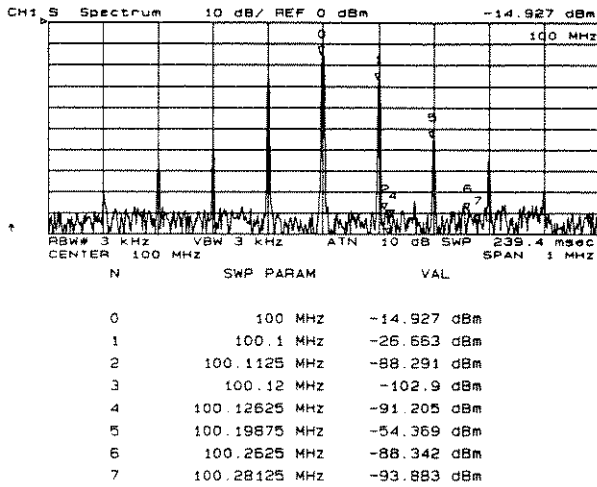

Before Defining the Threshold

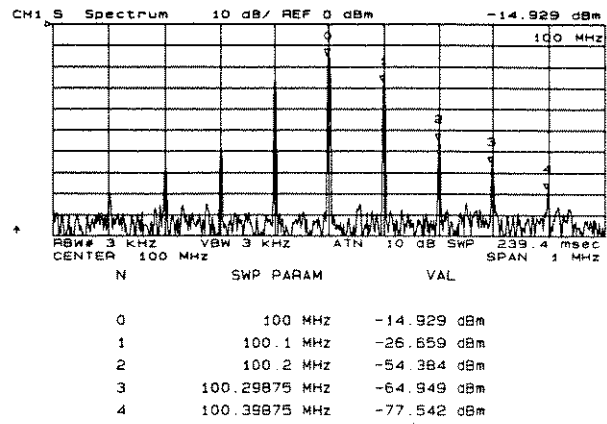

After Defining the Threshold

Figure 2-24. Threshold Function

### Defining Peak Height

1. Press **Search**.
2. Press **SEARCH:PEAK PEAK DEF MENU**.
3. Press **PEAK DEF: ΔY**.
4. Enter a peak height using the numerical keys and the units terminator keys.
5. Press **RETURN**.

For more information about peak definition, see chapter 12 of the *Function Reference* manual.

## Typical Spectrum Measurement Techniques

---

This chapter describes typical measurement techniques using the spectrum analyzer mode of operation.

The measurement techniques described in this chapter are as follows:

- To measure the noise level
- To measure the carrier to noise ratio
- To perform the time gated spectrum analysis
- To measure zero span (time domain measurement)
- To track unstable harmonics using search track
- To track and zoom a signal

## To Measure the Noise Level

1. Press **Format**.
2. Press **NOISE**.
3. Press **Scale Ref**. Then press **⇩** until the noise trace closes to the reference level.
4. Press **Bw/Avg**. Then press **VIDEO BW**.
5. Press **⇩** to flatten the noise trace.
6. Press **Marker**. Then turn the **⊙** and read the normalized noise level.

The marker readout unit becomes “dBm/Hz” and is normalized by the 1 Hz equivalent noise bandwidth (ENBW). To convert the ENBW, see the “To Convert to a Different Equivalent Noise Bandwidth” procedure.

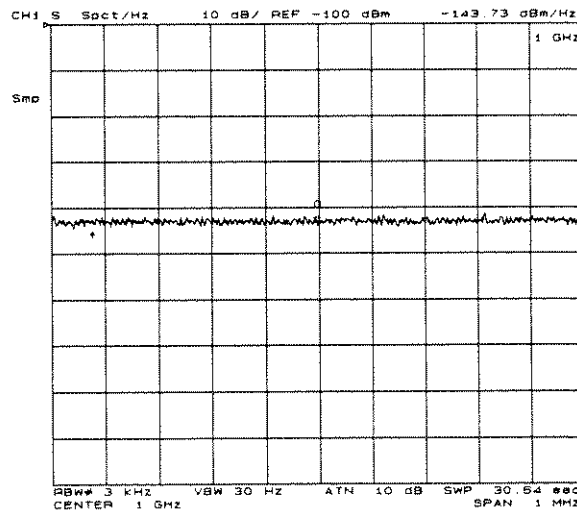

Figure 3-1. Noise Readout

### Note



When you change the format to a noise format, the analyzer changes the detection mode to sample detection. If you return the format to **SPECTRUM**, the detection mode automatically is set to the positive peak detection mode. This happens even if you selected the negative detection mode before changing to the noise format.



## To Convert to a Different Equivalent Noise Bandwidth

1. Calculate the conversion factor by using the following equations with displayed units:

Unit	Use
dBm/Hz	$K = 10 \log \frac{BW}{1}$
dBV/Hz and dB $\mu$ V/Hz	$K = 20 \log \frac{BW}{1}$
V/Hz and W/Hz	$K = BW$

Where,  $BW$  is the different equivalent noise bandwidth.

2. Press **Display** **DATA MATH**.
  - Press **OFFSET** for dBm/Hz, dBV/Hz, and dB $\mu$ V/Hz.
  - Press **GAIN** for V/Hz and W/Hz.
3. Enter  $K$ , then press **(x1)**.

## To Measure the Carrier to Noise Ratio

1. Set up the frequency range to measure a carrier signal.
2. Press **Search** **SEARCH:PEAK** to place the marker on the carrier signal.
3. Press **Scale Ref** **MKR→REFERENCE** to set the reference level to the carrier signal level.
4. Adjust the scale/div to display the carrier and noise floor. Use **Scale Ref** **SCALE/DIV**.
5. Press **Marker** **ΔMODE MENU ΔMKR** to place the reference marker on the carrier signal.
6. Press **Bw/Avg**. Then press **VIDEO BW**.
7. Enter an appropriate video bandwidth to reduce the variation.
8. Press **Marker**. Then do either of the following:
  - Enter the offset frequency by using the numeric keys.
  - Move the marker into the noise level of the trace by using the rotary knob.
9. If you want to normalize the marker readout with the RBW filter, press **Utility** and toggle **NOISE FORM** on **OFF** to **ON** off.
10. Read the difference from the reference marker.

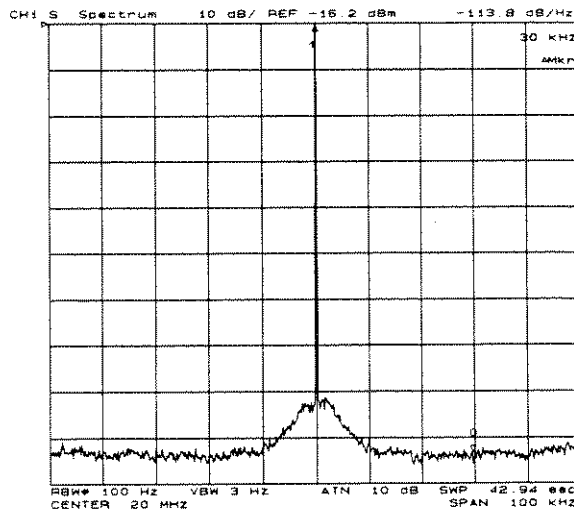

Figure 3-2. C/N Measurement

## To Perform the Time Gated Spectrum Analysis

Do the following steps to perform a time gated spectrum analysis:

1. Determining Gate Trigger Parameters
2. Gate Trigger Source Connection
3. Setting Center and Span Frequency
4. Adjusting Gate Trigger
5. Setting RBW, VBW, and Averaging
6. Measuring

**Note**



This function is only available with the option 1D6.

### Step 1: Determining Gate Trigger Parameters

1. Connect the target signal and the trigger signal to an oscilloscope input (see Figure 3-3).

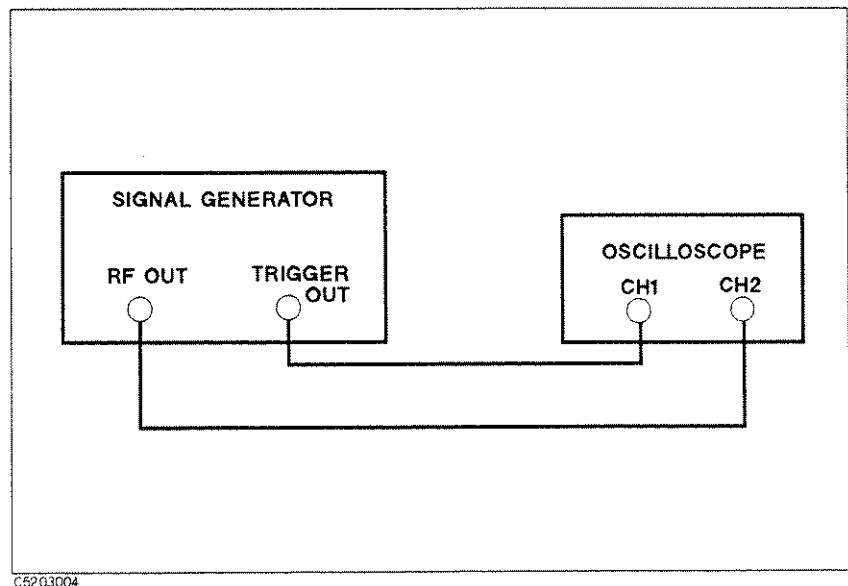

**Figure 3-3. Time Domain Measurement Configuration**

2. Adjust the oscilloscope to display the two signals.

## To Perform the Time Gated Spectrum Analysis

3. Using the oscilloscope, check the following parameters:

■ For the target signal:

- Signal width ( $\tau$ )
- Signal delay (SD)

■ For the trigger signal:

- Pulse width (if you use the level trigger mode)

The signal delay (SD) is the delay inherent in the signal (that is, SD is the length of time after the trigger, but before the signal of interest occurred and becomes stable).

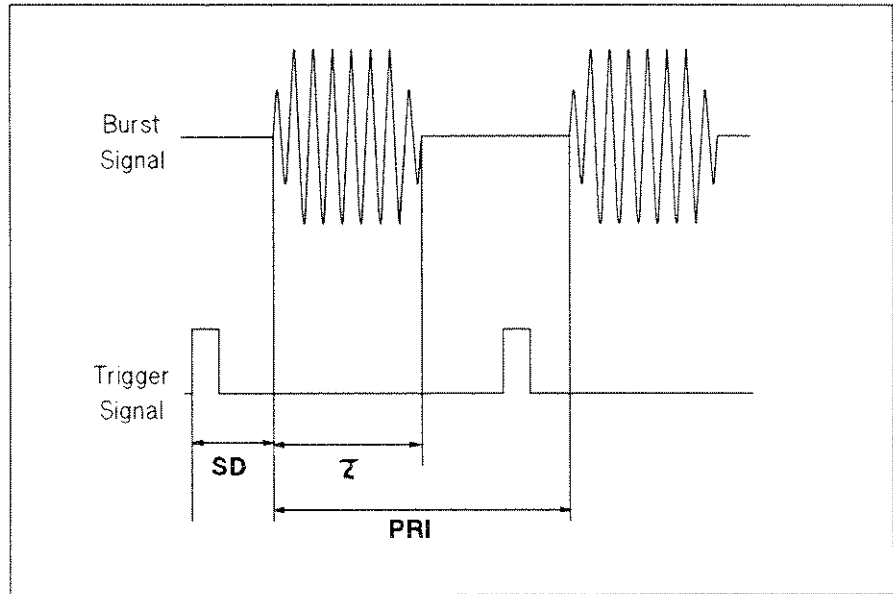

**Figure 3-4. Target and Trigger Signal Timing on the Oscilloscope**

## To Perform the Time Gated Spectrum Analysis

4. Calculate the set up time (SUT) using,  $SUT = \tau/2$ .
5. Determine the gate parameters using the following equations:
  - Gate delay = SUT + SD
  - Gate length =  $\tau/4$

Figure 3-5 shows the scheme of these parameters.

Open the “gate” during the time the signal is in a stable condition. The time from the start time of a signal and the open time of a gate is the “set up time” (SUT). Generally, SUT is set to half the pulse width. This is done so that you can allow the maximum time for the signal and RBW filter of the analyzer to become stable. You must also consider the end of the gate. Shut the gate before the last quarter of the pulse width to maintain a stable condition during the time the gate is open.

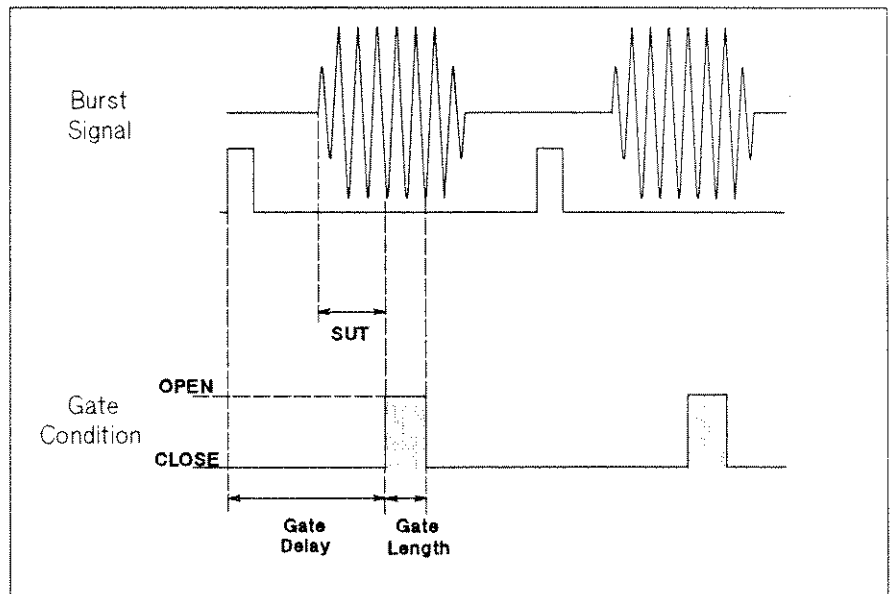

Figure 3-5. Gate Parameters

## To Perform the Time Gated Spectrum Analysis

### Step 2: Gate Trigger Source Connection

1. Connect the RF signal source to the S input of the analyzer.
2. Connect the trigger output from the signal source to the EXT TRIGGER connector on the rear panel of the analyzer.

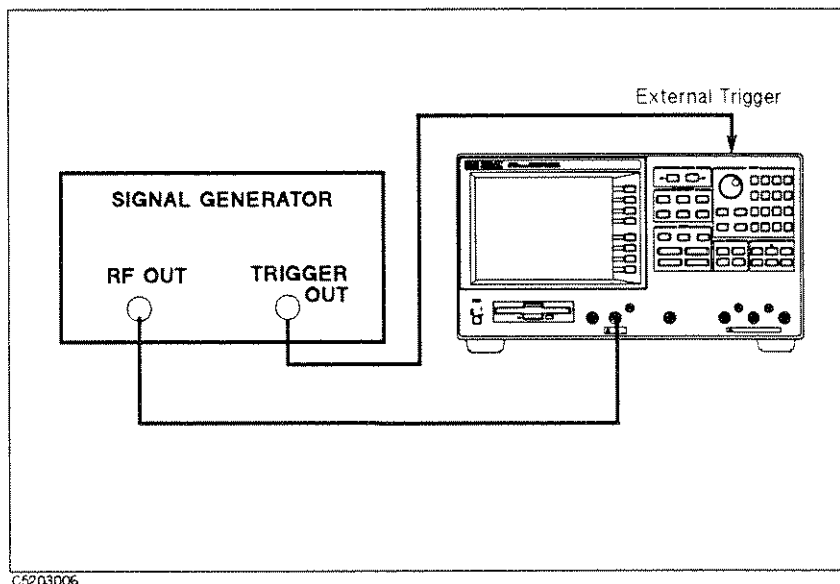

Figure 3-6. Time Gated Measurement Configuration

### Step 3: Setting Center and Span Frequency

- Set up the center and span frequency of the analyzer to display the target signal.

### Step 4: Adjusting Gate Trigger

1. Press **Trigger** **CONTINUOUS** to activate a gate trigger.
2. Press **TRIGGER: [FREE RUN]**.
3. Press **GATE [LEVEL]**.
4. Select the gate control mode. Select LEVEL or EDGE by toggling **GATE CTL: LEVEL** and **EDGE** to the required mode.
5. If you selected the LEVEL trigger mode, set the trigger polarity for starting the gate.
6. Press **GATE DELAY**.
7. Set a gate delay time.
8. If you select the EDGE trigger mode, press **GATE LENGTH**. Then set the gate open length.

You can see the gate trigger condition by monitoring the GATE Output terminal using an oscilloscope. The GATE Output terminal is located on the analyzer's rear panel.

For detailed information about the EDGE and LEVEL gate control modes, see the *Function Reference*.

## To Perform the Time Gated Spectrum Analysis

### Step 5: Setting RBW, VBW, and Averaging

#### To Set the Resolution Bandwidth

1. Press **Bw/Avg**.
2. Set the resolution bandwidth wider than  $\frac{2}{SUT}$ .

The RBW setting you can use is limited by the gate open position. You can adjust a longer gate delay for a narrower RBW in step 5. This is because the RBW filters need charge time until normal condition. Therefore, you need to consider the balanced point between SUT and RBW. Generally, the RBW filter's charge time is defined as  $2/RBW$ . Therefore, the SUT must be longer than  $2/RBW$  or the RBW must be wider than  $2/SUT$ .

#### Note



If the RBW is set narrower than 3 kHz, the analyzer turns into the stepped FFT mode. In the stepped FFT mode, the gate length must be longer than one FFT sampling step time. You must set the gate length longer than the minimum gate length that is listed in Table 3-1.

**Table 3-1.**  
Minimum Gate Length setting with RBW setting

RBW	Allowable Gate Length
1 Hz	$\geq 5.1857$ s
3 Hz	$\geq 1.6595$ s
10 Hz	$\geq 0.51858$ s
30 Hz	$\geq 0.13457$ s
100 Hz	$\geq 0.051213$ s
300 Hz	$\geq 0.012813$ s
1 kHz	$\geq 0.0032125$ s
3 kHz	$\geq 0.0016125$ s

#### To Set the VBW

1. Press **VIDEO BW**.
2. Set the video bandwidth.

You can set any video bandwidth (VBW) without concern for the gate length setting. The analyzer implements the video filter using digital processing. The video filter of the analyzer requires no settling time for normal operation. Therefore, it is not affected by the gate length setting.

You can also use the averaging function to reduce the variation of the trace. The averaging function converges to the top of the variation. This is different from the VBW, which converges to the middle of the variation.



## To Perform the Time Gated Spectrum Analysis

### Step 6: Measuring

1. Adjust the span setting to fit the trace to your requirement.
2. Perform your measurement.

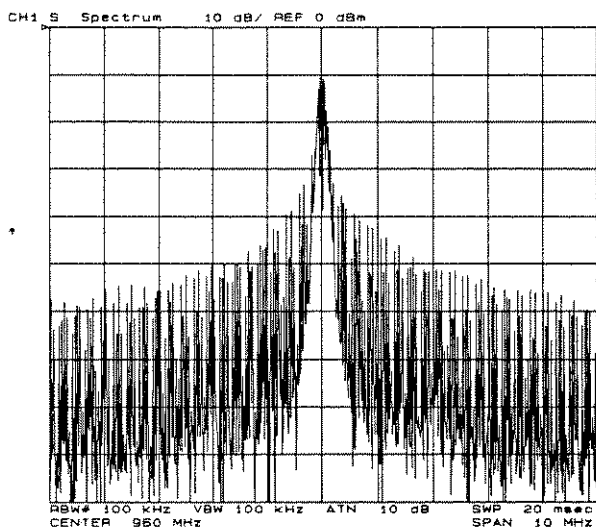

Before Time Gated

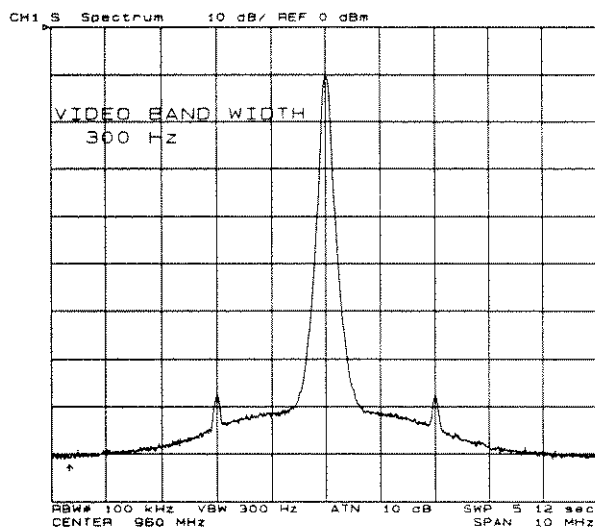

After Time Gated

Figure 3-7. Time Gated Spectrum Analysis

## To Measure Zero Span

1. Determine the following parameters:
  - Sweep Time
  - Display Number of Points (NOP)
2. Press **Center**. Then enter the frequency of the target signal.
3. Press **Span** **ZERO SPAN** to set the frequency span to 0 Hz.
4. Press **Sweep**.
5. Select the sampling mode:
  - If  $(\text{Sweep Time}) / (\text{NOP} - 1) \geq 25 \mu\text{s}$ , then toggle to **SAMPLING [NORM rept]**. And Do both of step 6 and 7.
  - If  $(\text{Sweep Time}) / (\text{NOP} - 1) < 25 \mu\text{s}$ , then toggle to **SAMPLING [norm REPT]**. And do either step 6 or 7.
6. Set the sweep time, press **Sweep** **SWEEP TIME** then enter the sweep time.
7. Set the number of points (NOP), by pressing **Sweep** **NUMBER of POINTS** and entering the NOP.

The allowable minimum sweep time is determined by the sampling mode and NOP. In the normal sampling mode, the minimum sweep time is  $25 \mu\text{s} \times \text{NOP}$ .

In the repetitive sampling mode, the sweep time is determined by  $0.5 \mu\text{s} \times \text{NOP}$ . This is because that the time resolution is fixed at  $0.5 \mu\text{s}$  in the repetitive sampling mode.

**Notes** You can set the RBW greater than 10 kHz. If you enter less than 10 kHz for the RBW, it is set to 10 kHz.

You must set the trigger source either **EXTERNAL** or **VIDEO** to select the repetitive sampling mode.

The detection mode is automatically set to the sample detection mode.

### To Stabilize the Trace Using the Video Trigger

1. Press **Trigger**.
2. Press **TRIGGER: [FREE RUN]**.
3. Press **VIDEO**.
4. Adjust the video trigger level by using  to trigger the sweep at appropriate trace level.

If the sweep time and the pulse repetition rate (PRI) are not synchronized, the trace does not appear in the same position on the grid on every sweep. To avoid this, change the video trigger setting as appropriate.

**To Read a Time Transition Using the Marker**

1. Press **Utility**.
2. Toggle **MKR TIME** on **OFF** to **ON** off.
3. Move the marker by using the .
4. Read the transition time that is displayed on the upper right of the grid.

When in zero span measurement, the marker displays the same frequency on every point of trace. Using the marker time function, you can change the marker display to the time format instead of the frequency. The marker displays a time transition from the left end of the grid.

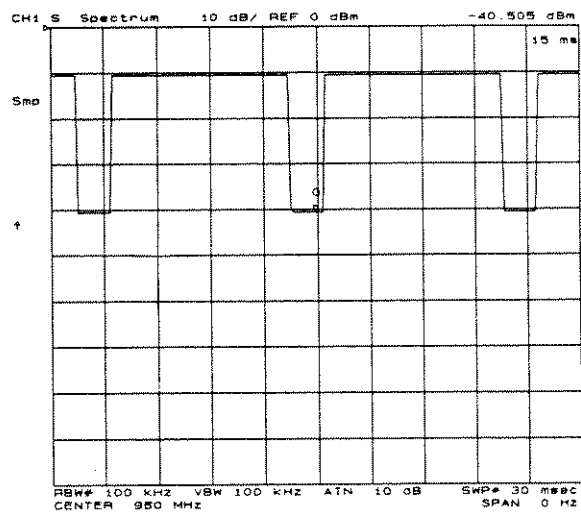

**Figure 3-8. Marker Time**

3: Typical Spectrum Measurement

## To Track Unstable Harmonics Using Search Track

1. Set the frequency range to display the carrier and the harmonics.
2. Press **Search** **SEARCH:PEAK** to move the marker to the peak.
3. Press **Marker** **ΔMODE MENU TRACKING ΔMKR** to set up the marker as a reference Δmarker that can move with the carrier.
4. Toggle **Search** **SEARCH TRK** on **OFF** to **ON** off to enable the search function on every sweep.
5. Press **MULTIPLE PEAKS** **SEARCH:PEAKS RIGHT** to search for carrier and harmonics under the search track.
6. Press **Utility**. Then toggle **MKR LIST** on **OFF** to **ON** off.

Even if the frequency of a carrier changes, the analyzer automatically tracks the carrier and the harmonics on the end of the sweep. Then the analyzer lists the difference between the carrier and the harmonics on the lower display.

If necessary, use the peak threshold to ignore the peaks other than the harmonics. See "To Ignore Small Peaks" in Chapter 2.

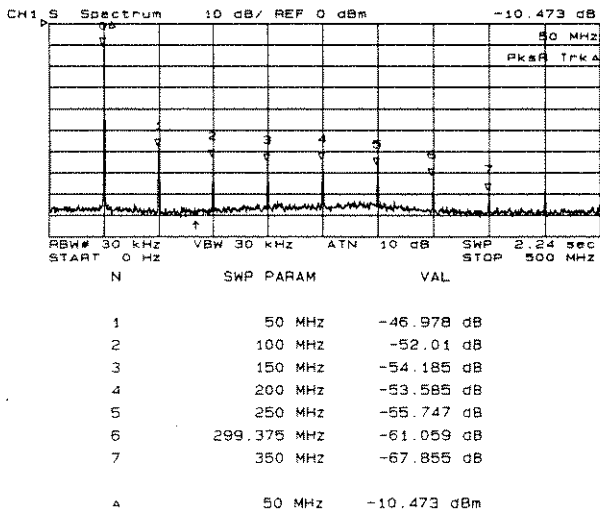

Carrier Frequency: 50 MHz

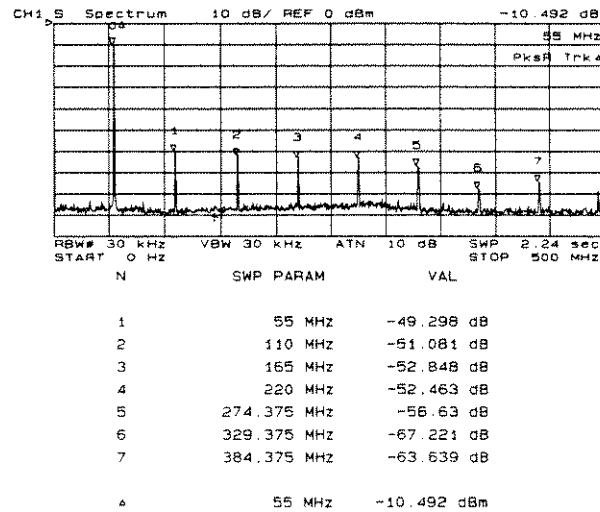

55 MHz

Figure 3-9. Tracking Unstable Harmonics Using Search Track

---

## To Track and Zoom a Signal

### Step 1: Setting the Wide Frequency Range

1. Set both channels to the spectrum analyzer mode.
2. Press **Display**. Then toggle **DUAL CHAN** on **OFF** to **ON** off.
3. Select either channel to track the signal in wide span. Then set a frequency range that can display the signal as you change the frequency.
4. Press **Marker→**.
5. Toggle **CROSS CHAN** on **OFF** to **ON** off.
6. Press **Search** **PEAK**.
7. Toggle **SIGNAL TRK** on **OFF** to **ON** off.

### Step 2: Setting the Narrow Frequency Range for the Other Channel

1. Select the other channel to display the zoomed signal in a narrow span.
2. Press **Span**.
3. Enter the frequency span to display the detail of the target signal. Note that the span of the zoomed channel must be wider than the frequency resolution  $\times 2$  of the channel that is set in step 1.
4. Press **Search**. Then toggle **SEARCH TRK** on **OFF** to **ON** off.
5. Use **PEAK** (or the marker search functions) to analyze the target signal.

The analyzer displays a wide view on the wide span channel and a detailed view on the zoomed channel. When the frequency of the signal is changed, the wide span channel tracks the signal and the center frequency of the zoomed channel automatically changes to display the target signal.

When the marker list is turned on, wide span channel disappears from the display. However, the wide span channel keeps tracking the signal in the background and displays the results on the zoomed channel.

For more information about frequency resolution, see "To Read a Value Using the Marker" in Chapter 2.

## To Track and Zoom a Signal

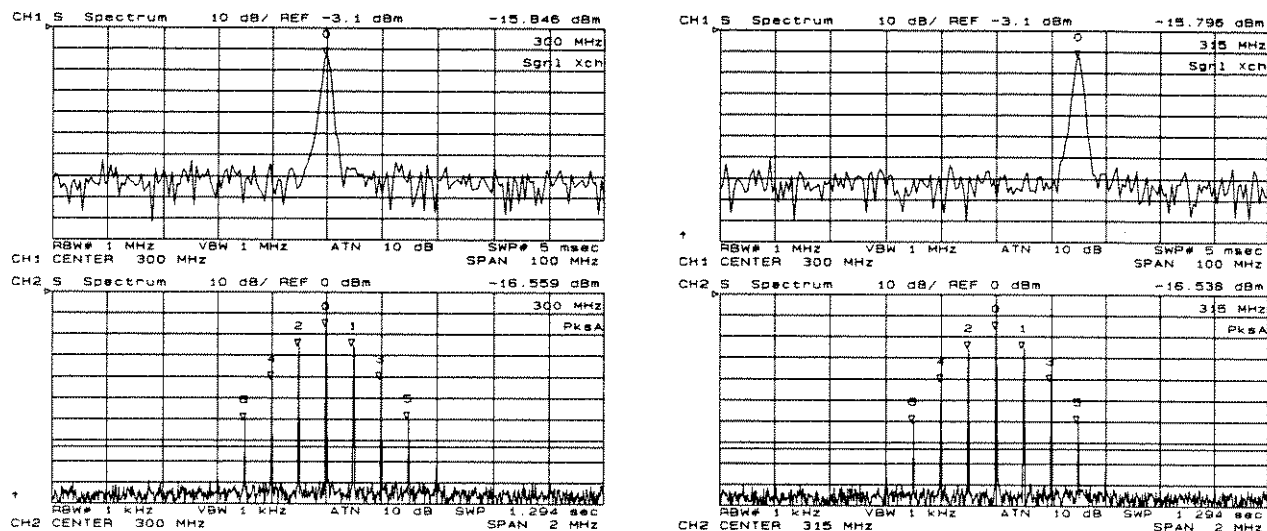

300 MHz Carrier

315 MHz Carrier

Figure 3-10. Tracking and Zooming a Signal

### Note



If the span of the zoomed channel is wider than the RBW of the wide channel, you can reduce the sweep time of the wide span channel. If the sweep time is reduced, the analyzer can track the faster movement of the target signal.

1. Press **[Ch 1]** or **[Ch 2]** to activate the wide span channel that has the active signal track function.
2. Press **[Bw/Avg]**. Then set the RBW to the maximum setting that is narrower than the span of the zoomed channel.
3. Press **[Sweep]**. Then press **SWEEP TIME**.
4. Press **[0]** **[X1]**.

## Recommended Network Measurement Task Sequence

---

This chapter describes a typical task sequence for any measurement using the network analyzer mode.

If you are using the analyzer for the first time, see the *User's Guide* first. The *User's Guide* provides the information needed to install and set up the analyzer, and a quick start guide to introduce you to the analyzer.

The measurement tasks described in this chapter are as follows:

- Step 1: Preparing for a measurement
- Step 2: Setting the sweep
- Step 3: Selecting the measurement format
- Step 4: Setting the sweep parameter
- Step 5: Setting the vertical settings
- Step 6: Tuning the settings
- Step 7: Performing calibration
- Step 8: Reading the measured result

Generally, you can make a measurement by performing these steps. If you want to perform a more complex network measurement, chapter 5 provides additional measurement techniques.

### Step 1: Preparing for a Measurement

This step provides the procedures needed to prepare for a network measurement. You must perform the following tasks before you select measurement parameters (such as frequency range):

- To connect the test device
- To preset the analyzer
- To select the active channel
- To select the network analyzer mode



## To Connect the Test Device

You must setup the test set before performing the network measurement. See appendix A of the *User's Guide* for the set up information of the test sets.

- Connect the device under test (DUT) as shown in Figure 4-1 or Figure 4-2.

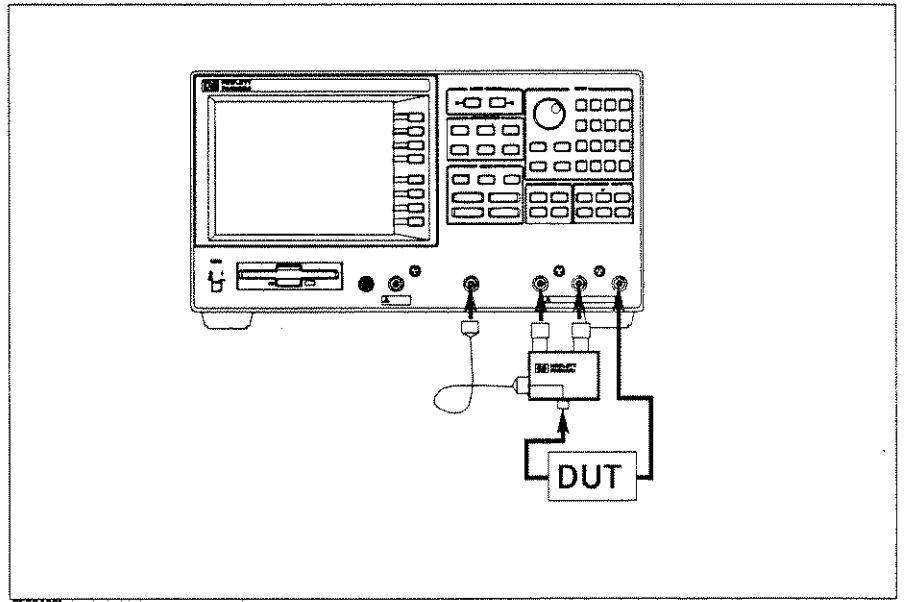

CS204001

Figure 4-1. Using the Transmission/Reflection Test Set

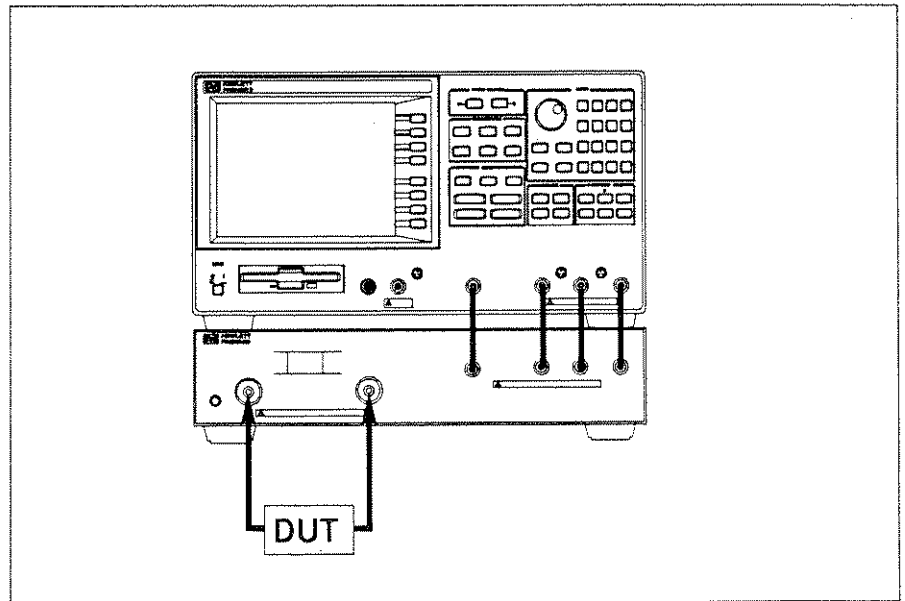

CS204002

Figure 4-2. Using the S-Parameter Test Set

## Preparing for a Measurement

### To Preset the Analyzer

- In the INSTRUMENT STATE block, press the green **Preset** key to set the analyzer to the preset state.

For additional information about the preset state, see the *Function Reference*.

### To Select the Active Channel

- In the ACTIVE CHANNEL block, press **Ch 1** (channel 1) or **Ch 2** (channel 2) to select the active channel.

The analyzer has two independent channels. Each channel can have a different setting that includes whether the mode of operation is network analyzer or spectrum analyzer. Select the active channel before you set up any other settings.

Using this feature, you can change immediately to either of different two settings by pressing a single key.

### To Select the Network Analyzer Mode

1. Press **Meas**.
2. Press **ANALYZER TYPE NETWORK ANALYZER**.

When you change the analyzer type, the analyzer is set to the preset state. So, when you want to change the analyzer type, you must select it before you set up the other settings or just after you select the active channel.

## Step 2: Setting the Sweep

This step selects the trigger source and the sweep condition.

- To select the trigger mode
  - To use the external trigger
  - To trigger on each display point
- To select the sweep condition
- To select the sweep type
  - To use the power sweep

### To Select the Trigger Mode

1. Press **Trigger**.
2. Press **TRIGGER: [FREE RUN]**.
3. Select the trigger mode:

To Select a Trigger to	Press
Free run	<b>FREE RUN</b>
External trigger source	<b>EXTERNAL</b> <sup>1</sup>
Manual	<b>MANUAL</b>

<sup>1</sup> See the "To Use the External Trigger" procedure.

**VIDEO** and **GATE** (option 1D6 only) are only used for the spectrum measurements.



**To Trigger on Each Display Point**

1. Press **Trigger**.
2. Press **TRIGGER: [FREE RUN]**.
3. Select a trigger source:

Trigger source	Do
Manual	Press <b>MANUAL</b> .
External	Press <b>EXTERNAL</b> .

4. Toggle **TRIG EVENT [ON SWEEP]** to **[ON POINT]**.
5. Apply a trigger event by pressing **MANUAL** (for **MANUAL**) or entering the external trigger signal (for **EXTERNAL**).

The sweep indicator (“↑”) is moved to each point by the trigger event. You can select this mode only for **MANUAL**, **EXTERNAL**, or the bus trigger mode. For more information about the bus trigger mode, see the *HP-IB Command Reference*.

**To Select the Sweep Condition**

1. Press **Trigger**.
2. Choose one of the following:

To Sweep	Do
Continuously	Press <b>CONTINUOUS</b> .
Single Time	Press <b>SINGLE</b> .
Specified Times	Press <b>NUMBER of GROUPS</b> . Then enter the number of times to sweep.

**To Select the Sweep Type**

1. Press **Sweep** **SWEEP TYPE MENU**.
2. Choose one of the following:

Sweep type	Do
Linear Frequency	Press <b>LIN FREQ</b> .
Log Frequency	Press <b>LOG FREQ</b> .
List Frequency	See “To Make a List Sweep” in Chapter 6.
Power Sweep	See the “To Use the Power Sweep” procedure.

## Setting the Sweep

### To Use the Power Sweep

1. Press **Source** **CW FREQ.**. Then enter the CW frequency.
2. Press **Sweep**.
3. Press **SWEEP TYPE MENU**.
4. Press **POWER SWEEP**.
5. Enter the start and stop power.

For example, to sweep from -20 dBm to 10 dBm, press **Start** **2** **0** **-** **x1**, **Stop** **1** **0** **x1**.

You can set the sweep power with 0.1 dB resolution.

### Step 3: Selecting the Measurement Format

This step provides following procedures for selecting measurement format:

- To select the input port
- To select the measurement format
- To display trace in a smith chart
- To use the impedance conversion function

#### To Select the Input Port

##### With the T/R Test Set

- Press **Meas**.

To measure	Type	Press
Reflection	Ratio	A/R
Transmission	Ratio	B/R
Reflection	Absolute	A
Transmission	Absolute	B
Source	Absolute	R

##### With the S-Parameter Test Set

1. Set up the S-parameter test set. See Appendix A of the *User's Guide*.
2. Press **Meas**.

To measure	Direction	Press
Reflection	Forward	Ref1:FWD S11 [A/R]
Transmission	Forward	Trans:FWD S21 [B/R]
Transmission	Reverse	Trans:REV S12 [B/R]
Reflection	Reverse	Ref1:REV S22 [A/R]

## Selecting the Measurement Format

### To Select the Measurement Format

1. Press **Format**.
2. Select a measurement format from the following:

To Select	Press
LOG Magnitude	LOG MAG
Phase	PHASE
Group Delay	DELAY <sup>1</sup>
Smith Chart	SMITH CHART <sup>2</sup>
Polar Chart	POLAR CHART
Liner Magnitude	LIN MAG
Standing Wave Ratio (SWR)	SWR
Real Part Only	MORE FORMAT: REAL
Imaginary Part Only	MORE IMAGINARY
Expanded Phase	MORE EXPANDED PHASE
Admittance Chart (Inv. Smith Chart)	MORE ADMITTANCE CHART

1 See "To Display the Group Delay" in Chapter 5.

2 See the "To Display Trace As a Smith Chart" procedure.

If you selected an absolute measurement by selecting R, A or B under the **Meas** key, only the following formats can be selected:

To Select	Press
LOG Magnitude	LOG MAG
Liner Magnitude	LIN MAG
Standing Wave Ratio (SWR)	SWR

For more information about the measurement format, refer to chapter 5 of the *Function Reference* manual.



### To Display Trace As a Smith Chart

1. Press **Format**.
2. Press **SMITH CHART** to display the smith chart.
3. Use the marker to read a measured value, by pressing **Marker** and rotating .

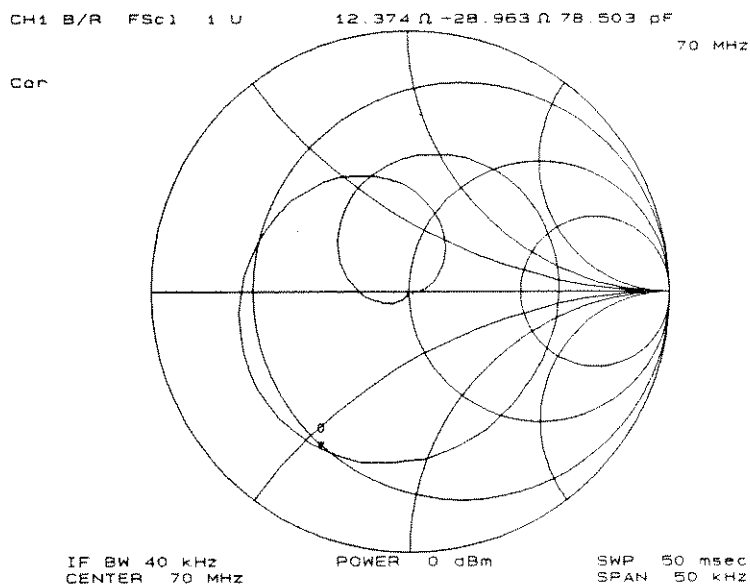

Figure 4-4. Smith Chart

To change the marker readout format, use the following procedure:

### To Change Marker Readout Format

1. Press **Utility** **SMTH/POLAR MENU**.
2. Select display format using the following keys:

Format	Press
Real and Imaginary	CHART FMT: REAL IMAG
Linear Magnitude and Phase	LIN MAG PHASE
Log Magnitude and Phase	LOG MAG PHASE
Impedance	R+jX
Admittance	G+jB
SWR and Phase	SWR PHASE

## Selecting the Measurement Format

### To Use Impedance Conversion Function

1. Press **Meas**.
2. Press **CONVERSION [OFF]**.
3. Select one of the formats listed below:

<b>Convert to</b>	<b>Selected Port</b>	<b>Press</b>
Impedance	A/R, S11, or S12	Z:Refl
	B/R, S21, or S22	Z:Trans
Admittance	A/R, S11, or S12	Y:Refl
	B/R, S21, or S22	Y:Trans



The marker readout value is a linear impedance or admittance value even if the LOG MAG format is selected.

For additional information about the impedance conversion function, see the *Function Reference*.

## Step 4: Setting the Sweep Parameter

### To Set the Sweep Parameter Using **Start** and **Stop**

1. Press **Start** to activate the start frequency function.
2. Change the start frequency setting using the following keys:

To	Use
Set directly	<b>0</b> ... <b>9</b> and units terminator keys
Change continuously	
Change with 1-2-5 steps	 

3. Press **Stop**.
4. Enter the stop frequency in a similar way.

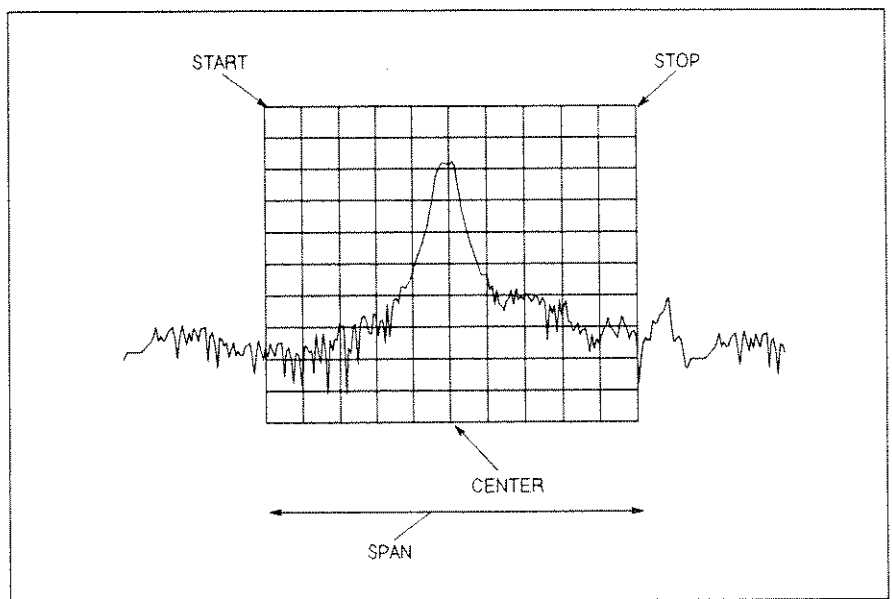

C5204011

Figure 4-5. Sweep Parameter Setting

You can set the sweep parameter using **Center** and **Span** instead of **Start** and **Stop**. See “Step 4: Setting the Frequency Range” in Chapter 2.

## Step 5: Setting the Vertical Settings

It is necessary to change a vertical setting if the trace is out of the grid or is too flat to see the required characteristics. This step provides the procedure needed to set the vertical scaling of the analyzer:

- To set the scale and reference automatically

### To Set the Scale and Reference Automatically

1. Press **Scale Ref**.
2. Press **AUTO SCALE** to fit the trace within the grid.

The scale and reference are automatically adjusted to obtain an optimum trace display.

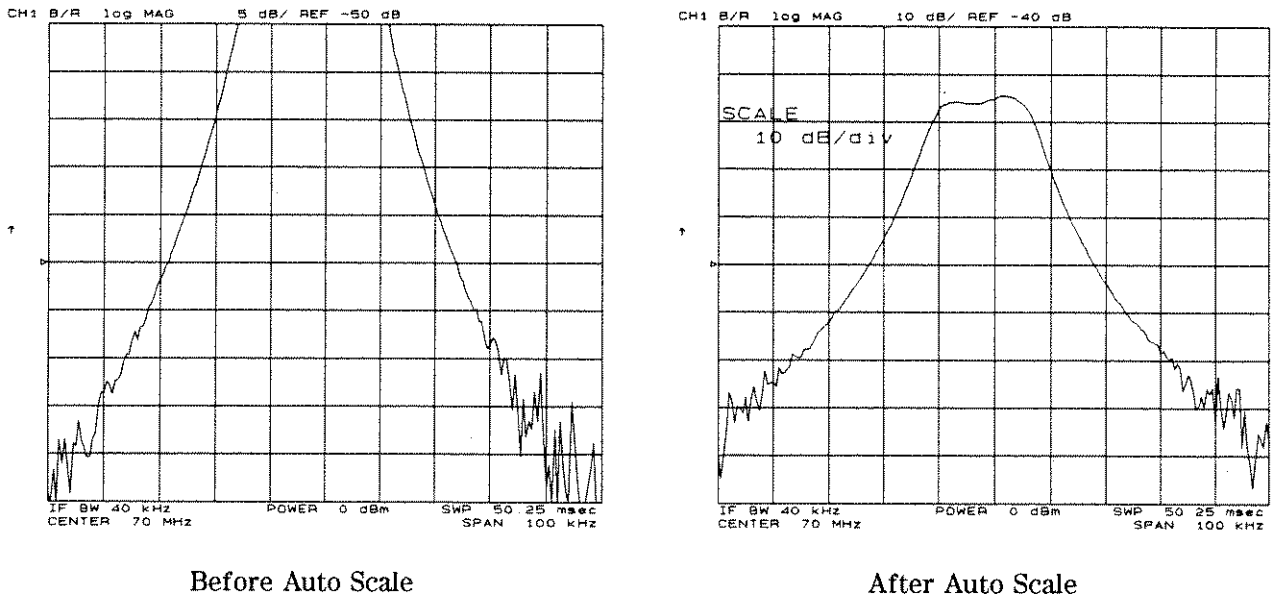

Figure 4-6. Autoscale Function

**Notes** If you want to set the scale and reference value manually, the following functions are available:

- To change the scale per division setting, press **SCALE/DIV**.
- To change the reference position that is shown as “▶”, use **REFERENCE POSITION** and **↑** **↓** keys.
- To change the reference value, use **REFERENCE VALUE**.

If you are displaying a data trace and a memory trace together, you need to consider whether you want to change the scale for one or both traces. You can change the traces as follows:

- If you want to change the scale setting for the data trace only, set **SCALE FOR [DATA]** and **D&M SCALE [UNCOUPLE]** under **Scale Ref** key.
- If you want to change the scale setting for the memory trace only, set **SCALE FOR [MEMORY]** and **D&M SCALE [UNCOUPLE]**.
- If you want to change the scale settings for the both traces, set **D&M SCALE [COUPLE]**.

## Step 6: Tuning the Settings

This step provides the following procedure:

- To increase the dynamic range

### To Increase the Dynamic Range (Setting IF Bandwidth)

1. Press **Bw/Avg**.
2. Press **IF BW**.
3. Press **↑** or **↓**, or enter an IF bandwidth value directly from the numeric keypad.

Narrowing the IF bandwidth setting increases the dynamic range but it makes the sweep speed slower.

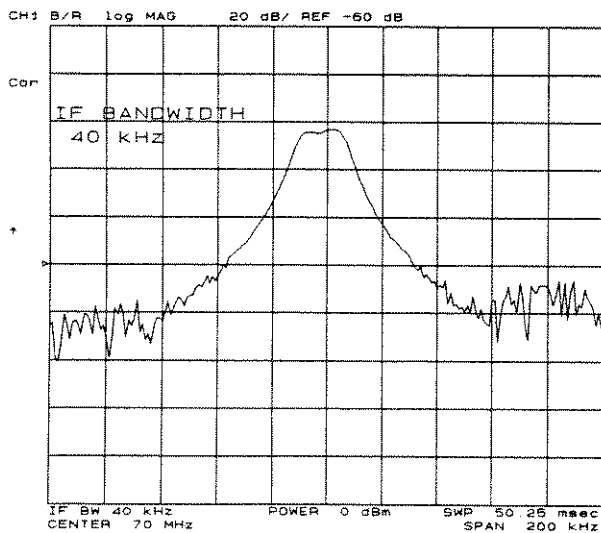

IF Bandwidth 40 kHz

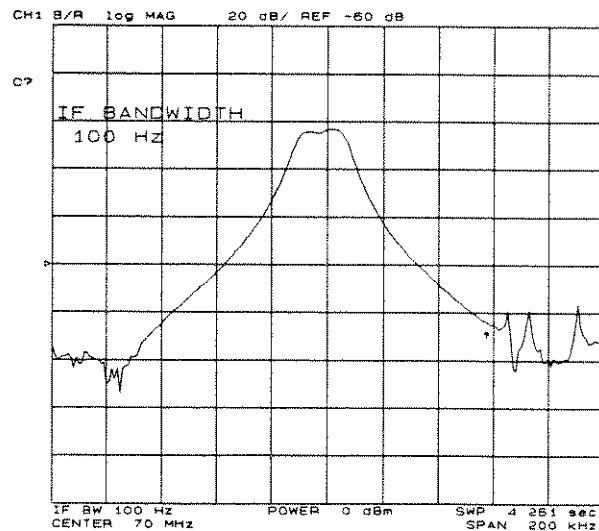

IF Bandwidth 100 Hz

Figure 4-7. Setting IF Bandwidth (IFBW)

**Notes** You can increase the dynamic range by using the following techniques:

- Apply the highest allowable power. The output power can be set by pressing **Source POWER**.
- Use the averaging. See "To Reduce Variation of the Measurement Trace Using Averaging".

## Step 7: Performing Calibration

This step provide procedures for performing calibration. The calibration cancels the errors and improves the measurement accuracy. The analyzer has six different methods of calibration. You can select the method that fits your measurement requirement by reading "To Select an Appropriate Calibration Method" procedure. This step also contains a procedure to customize a calibration kit.

- To select an appropriate calibration method
- To perform a response calibration
- To perform a response & isolation calibration
- To perform an S11 1-port calibration
- To perform an S22 1-port calibration
- To perform a full 2-port calibration
- To perform a 1-path 2-port calibration
- To select the calibration kit
- To customize the user defined calibration kit

### To Select an Appropriate Calibration Method

The analyzer has six calibration methods. You can choose the appropriate calibration method to fit your measurement by using Table 4-1.

Table 4-1. Calibration Method Selection Table

Measurement Type	Calibration Method	Complexity	See
Transmission or reflection measurement when the highest accuracy is not required.	Response	simple	"To Perform a Response Calibration"
Transmission of high insertion loss devices or reflection of high return loss devices. Not as accurate as 1-port or 2-port calibration.	Response & isolation	simple	"To Perform a Response & Isolation Calibration"
Reflection of any one-port device or well terminated two-port device.	S <sub>11</sub> 1-port	slightly complex	"To Perform an S11 1-Port Calibration"
Reflection of any one-port device or well terminated two-port device.	S <sub>22</sub> 1-port	slightly complex	"To Perform an S22 1-Port Calibration"
Transmission or reflection of highest accuracy for two-port devices. S-parameter Test Set is required.	Full 2-port	complex	"To Make Full 2-Port Calibration"
Transmission or reflection of highest accuracy for two-port devices. (Reverse test device between forward and reverse measurements.)	One-path 2-port	complex	"To Perform a 1-Path 2-Port Calibration"

## Performing Calibration

### To Perform a Response Calibration

1. Press **Cal** **CALIBRATE MENU RESPONSE** to display the response calibration menu.
2. Connect one of following standards. Then press the corresponding key.

Measurement Type	Connect Standard	Press
Transmission Measurement	THRU	THRU
Reflection Measurement	OPEN	OPEN
	SHORT	SHORT

3. Press **DONE: RESPONSE**.

### To Perform a Response & Isolation Calibration

1. Press **Cal** **CALIBRATE MENU RESPONSE & ISOL'N** to display the response and isolation calibration menu.
2. Press **RESPONSE**.
3. See 2 of the "To Perform a Response Calibration" procedure.
4. Press **DONE: RESPONSE**.
5. Connect isolation standard (LOAD).
6. Press **ISOL'N STD**.
7. Press **DONE RESP ISOL'N CAL**.



## To Perform an S11 1-Port Calibration

### Step 1: Opening the S-11 1-Port Calibration Menu

1. Press **Cal**.
2. Select the proper calibration kit. If the connector type or calibration kit name shown in the **CAL KIT** softkey label is not the same as the calibration kit to be used, see the "To Select the Calibration Kit" procedure.
3. Press **CALIBRATE MENU S11 1-PORT**.

### Step 2: Measuring the OPEN

1. Connect OPEN standard to port 1.
2. Press **(S11):OPEN** (for the 7 mm or 3.5 mm cal kit) or **(S11):OPENS** (for the type-N cal kit).

When the 7 mm or 3.5 mm calibration kit is selected, the message "WAIT - MEASURING CAL STANDARD" is displayed while the OPEN data is measured. The softkey label **OPEN** is then underlined. Skip to step 3.

3. If the type-N calibration kit is selected, do the following.
  - a. Press **OPEN [M]** (for a male port connector) or press **OPEN [F]** (for a female port connector).  
The OPEN data is measured and the softkey label is then underlined.
  - b. Press **DONE:OPENS**.

### Step 3: Measuring the SHORT

1. Disconnect the OPEN. Then connect a SHORT standard to port 1.
2. Press **SHORT** (for the 7 mm or 3.5 mm calibration kit) or **SHORTS** (for the type-N calibration kit).

When the 7 mm or 3.5 mm calibration kit is selected, the SHORT data is measured and the softkey label is underlined. Skip to step 4.

3. If the type-N calibration kit is selected, do the following.
  - a. Press **SHORT [M]** (for a male port connector) or press **SHORT [F]** (for a female port connector).  
The SHORT data is measured and the softkey label is then underlined.
  - b. Press **DONE:SHORTS**.

### Step 4: Measuring the LOAD

1. Disconnect the SHORT, and connect an impedance-matched LOAD (usually 50 or 75  $\Omega$ ) at port 1.

## Performing Calibration

2. Press **LOAD**. Then wait the LOAD is measured and the **LOAD** softkey is underlined.

### Step 5: Completing the Calibration

1. Press **DONE 1-PORT CAL** to complete the calibration.

The error coefficients are computed, and the correction menu is returned to the screen with **CORRECTION ON**. A corrected S11 trace is displayed, and "Cor" appears at the left side of the screen.

If you press **DONE** without measuring all the required standards, the message "CAUTION: ADDITIONAL STANDARDS NEEDED" is displayed.

## To Perform an S22 1-Port Calibration

This calibration is similar to the S11 1-port calibration except that S22 is selected automatically. It is used only with an S-parameter test set.

For S-parameter measurements in the reverse direction with a transmission/reflection test kit, use the S11 1-port or 1-path 2-port calibration and reverse the DUT between measurement sweeps.

## To Make Full 2-Port Calibration

### Step 1: Calling the Full 2-Port Calibration Menu

1. Press **Cal**.
2. Select the proper calibration kit. If the connector type or calibration kit name shown in the **CAL KIT** softkey label is not the same as the calibration kit to be used, see the "To Select the Calibration Kit" procedure.
3. Press **CALIBRATE MENU FULL 2-PORT REFLECT'N**.

### Step 2: Measuring the Reflection

1. Connect a shielded OPEN to port 1.
2. Press **(S11): OPEN** (for the 7 mm or 3.5 mm calibration kit) or **(S11): OPENS** (for the type-N calibration kit).

When the 7 mm or 3.5 mm calibration kit is selected in step 1, the OPEN data is measured and the softkey label **OPEN** is underlined.

3. If the type-N calibration kit is selected, do the following.
  - a. Press **OPEN [M]** (for a male port connector) or press **OPEN [F]** (for a female port connector).  
The OPEN data is measured. The softkey label is then underlined.
  - b. Press **DONE: OPENS**.
4. Disconnect the OPEN and connect the SHORT to port 1.
5. Press **(S11): SHORT** (for the 7 mm or 3.5 mm calibration kit) or **(S11): SHORTS** (for the type-N calibration kit).

When the 7 mm or 3.5 mm calibration kit is selected, the SHORT data is measured and the softkey label **SHORT** is underlined.

6. If the type-N calibration kit is selected, do the following.
  - a. Press **SHORT [M]** (for a male port connector) or press **SHORT [F]** (for a female port connector).  
The SHORT data is measured and the softkey label is then underlined.
  - b. Press **DONE: SHORTS**.
7. Disconnect the SHORT and connect an impedance-matched LOAD (usually 50 or 75  $\Omega$ ) at port 1.
8. Press **(S11): LOAD**. Then confirm the **LOAD** softkey label is underlined.
9. Repeat the OPEN-SHORT-LOAD measurements described above, connecting the devices in turn to port 2 and using the (S22) softkeys.

## Performing Calibration

10. Press **REFLECT'N DONE**.

The reflection calibration coefficients are computed and stored. The two-port calibration menu is displayed (with the **REFLECT'N** softkey underlined).

### Step 3: Measuring the Transmission

1. Press **TRANSMISSION**.
2. Connect a THRU connection between port 1 and port 2 at the points where the test device is connected.
3. When the trace settles, press **FWD. TRANS. THRU**. Then wait S21 frequency response is measured and the softkey label is underlined.
4. Press **FWD. MATCH THRU**. Then wait the S11 load match is measured and the softkey label is underlined.
5. Press **REV. TRANS. THRU**. Then wait the S12 frequency response is measured and the softkey label is underlined.
6. Press **REV. MATCH THRU**. Then wait the S22 load match is measured and the softkey label is underlined.
7. Press **TRANS. DONE**.

The transmission coefficients are computed and stored. The two-port calibration menu is displayed (with the **TRANSMISSION** softkey underlined).

### Step 4: Measuring the Isolation

1. If correction for isolation is not required, press **ISOLATION OMIT ISOLATION ISOLATION DONE**. Then skip to step 5.
2. If correction for isolation is required, connect impedance-matched LOADs to port 1 and port 2.
3. Press **FWD ISOL'N ISOL'N STD**. Then wait the S21 isolation is measured and the softkey label is underlined.
4. Press **REV ISOL'N ISOL'N STD**. Then wait the S12 isolation is measured and the softkey label is underlined.
5. Press **ISOLATION DONE**.

The isolation error coefficients are stored. The two-port calibration menu is displayed (with the **ISOLATION** softkey underlined).

### Step 5: Completing the Calibration

1. Press **DONE: 2-PORT CAL** to complete the calibration.

The error coefficients are computed and stored. The correction menu is displayed (with **CORRECTION ON**). A corrected trace is displayed. The notation "C2" at the left of the screen indicates that two-port error correction is ON.

## Performing Calibration

Now the test device can be connected and measured. Save the calibration data on the built-in disk drive.

## Performing Calibration

### To Perform a 1-Path 2-Port Calibration

#### Step 1: Calling the 1-Path 2-Port Calibration Menu

1. Press **Cal**.
2. Select the proper calibration kit. If the connector type or calibration kit name shown in the **CAL KIT** softkey label is not the same as the calibration kit to be used, see the "To Select the Calibration Kit" procedure.
3. Press **CALIBRATE MENU ONE-PATH 2-PORT REFLECT'N**.

#### Step 2: Measuring the Reflection

1. Connect a shielded OPEN to the test port.
2. Press **(S11): OPEN** (for the 7 mm calibration kit) or **(S11): OPENS** (for the type-N calibration kit).  
  
The OPEN data is measured, and the softkey label **OPEN** is underlined.
3. If the type-N calibration kit is selected, do the following.
  - a. Press **OPEN [M]** (for a male port connector) or press **OPEN [F]** (for a female port connector).  
  
The OPEN data is measured and the softkey label is then underlined.

- b. Press **DONE:OPENS**.

4. Disconnect the OPEN and connect a SHORT to the test port.
5. Press **SHORT** (for the 7 mm or 3.5 mm calibration kit) or **SHORTS** (for the type-N calibration kit).

When the 7 mm or 3.5 mm calibration kit is selected, the SHORT data is measured and the softkey label **SHORT** is underlined.

6. If the type-N calibration kit is selected, do the following.
  - a. Press **SHORT [M]** (for a male port connector) or press **SHORT [F]** (for a female port connector).

The SHORT data is measured and the softkey label is then underlined.

- b. Press **DONE:SHORTS**.

7. Disconnect the SHORT and connect an impedance-matched LOAD (50 or 75  $\Omega$ ) to the test port.
8. Press **LOAD**. Then wait the LOAD is measured and the softkey label **LOAD** is underlined.
9. Press **REFLECT'N DONE**.

The reflection calibration coefficients are computed and stored. The two-port calibration menu is displayed (with the **REFLECT'N** softkey underlined).

**Step 3: Measuring the Transmission**

1. Connect a THRU between the test port and the return cable to the analyzer (connect to the points at which the test device is connected).
2. Press **TRANSMISSION**.
3. Press **FWD. TRANS. THRU**. Then wait the S21 frequency response is measured and the softkey label is underlined.
4. Press **FWD. MATCH THRU**. Then wait the S11 load match is measured and the softkey label is underlined.
5. Press **TRANS. DONE**.

The transmission coefficients are computed and stored. The two-port calibration menu is displayed (with the **TRANSMISSION** softkey underlined).

**Step 4: Measuring the Isolation**

1. If correction for isolation is not required, press **ISOLATION OMIT ISOLATION ISOLATION DONE**. Skip to step 5.
2. If correction for isolation is required, connect impedance-matched LOADs to the test port and the return port.
3. Press **FWD ISOL'N ISOL'N STD**. Then wait the S21 isolation is measured and the softkey label is underlined.
4. Press **ISOLATION DONE**.

The isolation error coefficients are stored. The two-port calibration menu is displayed (with the **ISOLATION** softkey underlined).

**Step 5: Completing the Calibration**

1. Press **DONE 2-PORT CAL** to complete the calibration.

The error coefficients are computed and stored. The correction menu is displayed with **CORRECTION ON**. A corrected trace is displayed. The notation "C2" at the left of the screen indicates that 2-port error correction is ON.

**Step 6: Performing the Measurement**

1. Connect the test device in the reverse direction. Then press **PRESS to CONTINUE**.
2. Reconnect the test device in the forward direction. Then press **PRESS to CONTINUE**.

## Performing Calibration

Now the error corrected trace is displayed. If you measure the other test device, press **Trigger** **MEASUREMENT RESTART**. Then perform the procedure of step 6.

Save the calibration data on a disk or RAM disk.

For additional information about calibration, see chapter 5 of the *Function Reference*.



### To Select the Calibration Kit

1. Press **Cal**.
2. Press **CAL KIT [...]**.
3. Press one of the following keys:

Calibration Kit	Press
7 mm calibration kit	CAL KIT: 7mm
3.5 mm calibration kit	3.5mm
50 Ω N type	N 50Ω
75 Ω N type	N 75Ω
User defined calibration kit	USER KIT

### To Customize the User Defined Calibration Kit

#### To Define the Standard Definition

##### Step 1: Preparation.

1. Prepare the “*Standard Definitions*” table of the standard kit you want to use.

Table 4-2 is an example of a standard definition table.

**Table 4-2.**  
Example of the Standard Definitions (HP 85032B 50Ω Type-N Calibration Kit)

STANDARD		C0 ×10 <sup>-15</sup> F	C1 ×10 <sup>-27</sup> F	C2 ×10 <sup>-36</sup> F/Hz	C3 ×10 <sup>-45</sup> F/Hz	FIXED OR SLIDING	OFFSET			FREQUENCY (GHz)		COAX or WAVEGUIDE	STANDARD LABEL
NO.	TYPE						DELAY ps	LOSS M0/s	Z0 Ω	MINIMUM	MAXIMUM		
1	SHORT						0	700	50	0	999	COAX	SHORT(M)
2	OPEN	108	55	130	0		0	700	50	0	999	COAX	OPEN(M)
3	LOAD					FIXED	0	700	50	0	999	COAX	BROAD-BAND
4	DELAY/THRU						0	700	50	0	999	COAX	THRU
5													
6													
7	SHORT						17.544	700	50	0	999	COAX	SHORT(F)
8	OPEN	62	17	28	0		17.544	700	50	0	999	COAX	OPEN(F)

4: Network Measurement Task

##### Step 2: Activating the Define Standard Menu.

1. Press **Cal**.
2. Press **CAL KIT [...]**.
3. Press **MODIFY [...]**.
4. Press **DEFINE STANDARD**.
5. Select standard number.

## Performing Calibration

6. Select standard type.

If you did not select standard type as OPEN in step 2, skip to step 4.

### Step 3: Entering a C Parameters.

1. Press **C0**. Then enter  $C0 (\times 10^{-15}F)$ .
2. Press **C1**. Then enter  $C1 (\times 10^{-27}F/Hz)$ .
3. Press **C2**. Then enter  $C2 (\times 10^{-36}F/Hz^2)$ .

### Step 4: Entering an OFFSET Parameters.

1. Press **SPECIFY OFFSET**.
  - Press **OFFSET DELAY**. Then enter DELAY.
  - Press **OFFSET LOSS**. Then enter LOSS.
  - Press **OFFSET Z0**. Then enter  $Z_0$ .
2. Press **STD OFFSET DONE**.

### Step 5: Entering a Standard Class Label.

1. Press **LABEL STD**.
2. Enter a standard label up to 10 characters.
3. Press **DONE**.

### Step 6: Completing the Definition of a Calibration Kit.

1. Press **STD DONE (DEFINED)**.
2. Press **KIT DONE (MODIFIED)**.

**To Define a Class Assignment**

**Step 1: Preparing for the Class Assignment.**

1. Prepare the standard class assignment table for your calibration kit.

**Table 4-3.**  
**Standard Class Assignment of the HP 85032B**

	A	B	C	D	E	F	G	STANDARD CLASS LABEL
S <sub>11</sub> A	2	8						OPENS
S <sub>11</sub> B	1	7						SHORTS
S <sub>11</sub> C	3							LOAD
S <sub>22</sub> A	2	8						OPENS
S <sub>22</sub> B	1	7						SHORTS
S <sub>22</sub> C	3							LOAD
Forward Transmission	4							Fwd. Trans Thru
Reverse Transmission	4							Rev. Trans Thru
Forward Match	4							Fwd. Match Thru
Reverse Match	4							Rev. Match Thru
Response	1	7	2	8	4			RESPONSE
Response & Isolation	1	7	2	8	4			Response & Isol'n

## Performing Calibration

### Step 2: Specifying the Class.

1. Press **SPECIFY CLASS**.
2. Select standard class.

To Select	Press
S <sub>11</sub> A	SPECIFY: S11A
S <sub>11</sub> B	S11B
S <sub>11</sub> C	S11C
S <sub>22</sub> A	SPECIFY: S22A
S <sub>22</sub> B	S22B
S <sub>22</sub> C	S22C
Forward Transmission	MORE SPECIFY: FWD. TRANS.
Reverse Transmission	MORE REV. TRANS.
Forward Match	MORE FWD. MATCH
Reverse Match	MORE REV. MATCH
Response	MORE RESPONSE
Response & Isolation	MORE RESPONSE & ISOL'N

3. Enter the standard number from A to G.
4. Press **CLASS DONE (SPEC'D)**.

### Step 3: Labeling the Standard Class Label.

1. Press **LABEL CLASS** to label the standard class.
2. Select the standard class.  
See 2 of Step 2.
3. Enter or modify the correspondent standard class label.
4. Press **LABEL DONE**.

### To Label and Save Calibration Kit.

1. Press **LABEL KIT**.
2. Enter label.
3. Press **DONE KIT DONE (MODIFIED)**.
4. Press **CAL KIT [...] SAVE USER KIT USER KIT**.
5. Press **RETURN**.

After the user-defined calibration kit is defined, you can verify the definition using the copy function that lists standard parameters and class assignment.

**To Verify Definition of User-Defined Calibration Kit.**

1. Press **Cal** **CAL KIT [...]** **USER KIT** to specify the calibration kit as a user-defined kit.
2. Press **Copy** **MORE CAL KIT DEFINITION**.
  - To display the standard parameters defined, press **STANDARD DEFINITION**. Then press the softkey labeled standard number if you want to list the defined parameters.
  - To display the defined class assignment, press **CLASS ASSIGNMENT**.
3. To make a hardcopy, press **PRINT [STANDARD]**.
4. To return to the normal display, press **RESTORE DISPLAY**.

## Step 8: Reading the Measured Result

If you can obtain the correct trace on the display, you can readout the trace gain and frequency by using the marker. The analyzer can search for specific points (like peaks or ripples) by using the marker search function. This step provides procedures for reading values using the marker and the marker search functions.

- To read a value using the marker
- To stabilize the trace
- To use the sub-markers
- To use the  $\Delta$ marker
- To search for a point which has the target value
- To search for the peak-to-peak of ripples using the statistics function
- To define the peak for search

### To Read a Value Using the Marker

1. Press **Marker**.
2. Move the marker to the point you want to read using the .
3. Read the marker value displayed on the upper right of the display.

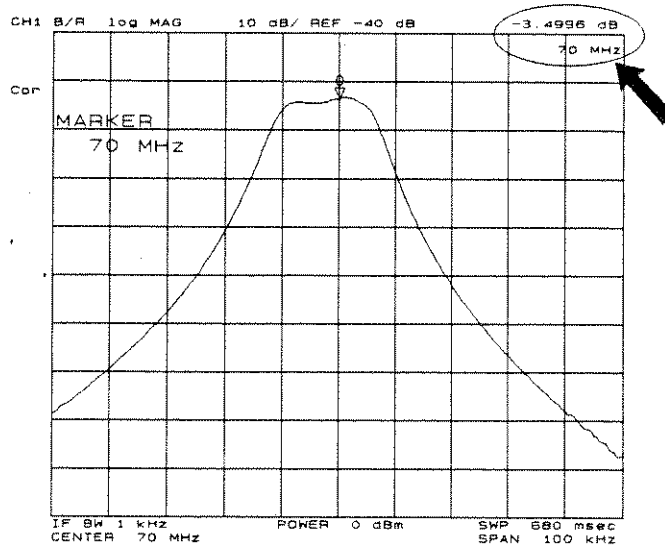

Figure 4-8. Marker Readout

**To Stabilize the Trace**

When the marker value changes frequently and it is difficult to read the value, you can use the following techniques to stabilize the trace:

- Stop the sweep.
- Use the averaging function.

**To Stop the Sweep**

1. Press **Trigger**.
2. Press **SWEEP: HOLD**.

The sweep is stopped immediately (even if the sweep is in progress). If you want to restart the sweep, press **CONTINUOUS**.

**To Reduce Variation of the Measurement Trace Using Averaging**

1. Press **Bw/Avg**.
2. Press **AVERAGING FACTOR**.
3. Enter the number of times to average. Then press **(x1)**.
4. Toggle **AVERAGING** on **OFF** to **ON** off.

"Avg" appears on the left side of display when averaging is turned on. The averaging notation counts the averaging factor during averaging until it reaches the specified averaging factor. When averaging is completed, the counter halts and the trace continues updating with each sweep.

The averaging factor can be set from 0 to 999.

If you want to change the setting of any parameter when averaging, you can restart averaging from the 0 count.

**To Restart the Averaging.**

1. Press **Bw/Avg**.
2. Press **AVERAGING RESTART**.

This resets the averaging counter to 0 and the counter starts incrementing with every sweep.

## Reading the Measured Result

### To Use the Sub-markers

1. Press **Marker**.
2. Move the marker to a point where you want to set a sub-marker.
3. Press **SUB MKR**.
4. Select from **SUB MKR 1** to **7**.
5. Press **Utility**.
6. Toggle **MKR LIST** on **OFF** to **ON** off.

The sub-marker appears at the point of that the marker is displayed. Sub-markers are fixed horizontally and you cannot move them.

The sub-marker value can only be displayed by using the marker list.

To clear a sub-marker, press **Marker** **CLEAR SUB MKR**. Then press the sub-marker number that you want to erase from the display.

To clear all the markers, press **Marker** **PRESET MKRS**.

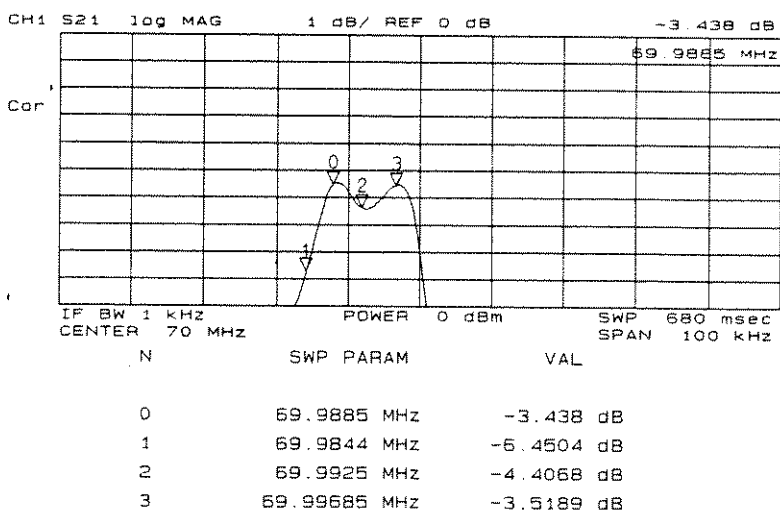

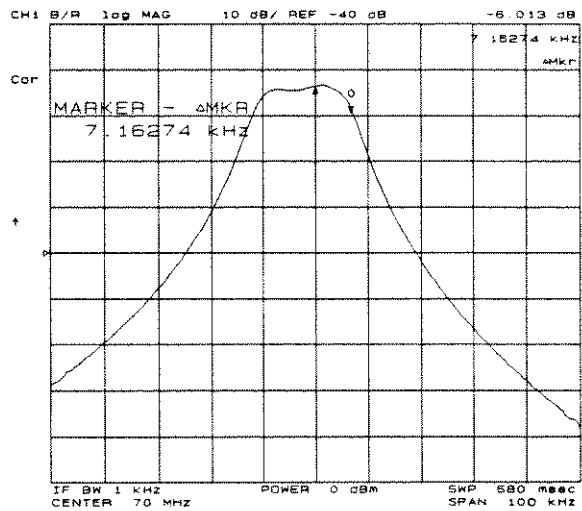

Figure 4-9. Sub-markers



**To Use the ΔMarker**

1. Press **Marker**.
2. Place the marker on the point you want use as a reference point using the .
3. Press **ΔMODE MENU**.
4. Press **ΔMKR**. The reference marker appears at the marker place.
5. Move the marker by using the following procedures:
  - Enter a difference frequency (or power) by using the numerical keys.
  - Turn the rotary knob until the marker moves to the point you want to read the value.
6. Read the gain and the frequency (or power) differences from the reference marker that are displayed on the upper right of the grid.



**Figure 4-10. ΔMarker**

## Reading the Measured Result

### To Search For a Point that has the Target Value

1. Press **Search**.
2. Press **TARGET**.
3. Enter the target value using **0** ... **9** and the unit terminator keys.

To search for a target on	Press
All of the display	<b>TARGET</b>
Left side of the marker	<b>SEARCH LEFT</b>
Right side of the marker	<b>SEARCH RIGHT</b>

When the  $\Delta$ marker is active, the target value becomes the difference from the reference marker, not an absolute value. For example, you can search for the -3 dB cutoff point of a filter by mixing the  $\Delta$ marker and the target search function.

## To Search for the Peak-to-Peak of Ripples Using the Statistics Function

### Step 1: To Specify the Search Range

1. Press **Marker**. Then move the marker to the start point of the range.
2. Press **ΔMODE MENU ΔMKR** to place the reference marker on the start point of the range.
3. Move the marker to the end point of the range.
4. Press **Search SEARCH RANGE MENU**.
5. Toggle **PART SRCH** on **OFF** to **ON** off.
6. Press **MKRA→SEARCH RNG** to set the range defined by the reference marker and the marker as the search range.

Triangle-shaped indicator ( $\Delta$ ) at the bottom of the grid shows current search range.

### Step 2: To Search For the Ripple

1. Press **Utility**.
2. Toggle **STATISTICS** on **OFF** to **ON** off.

**STATISTICS** displays the mean value (mean), the standard deviation (s.dev), and the peak-to-peak value (p-p) of the ripple within the specified range of the active channel. This information is displayed on the upper right of the display (see Figure 4-11). If you did not specify the search range, the analyzer searches within the displayed area.

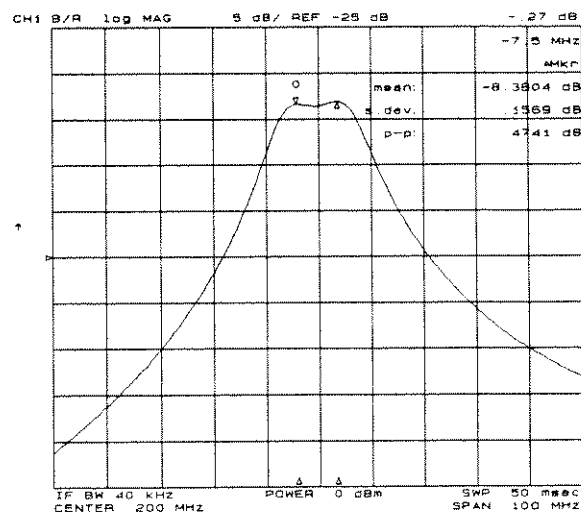

Figure 4-11. Ripple Parameters Readout

## Reading the Measured Result

### To Define the Peak for Search

You can define the target peak for the search function using the following techniques:

- Defining the peak slope to ignore the relatively broad peaks.
- Specifying the peak threshold to ignore the absolutely small peaks.

#### Defining the Peak Slope to Ignore the Relatively Broad Peaks Entering Directly.

1. Press **Search** **SEARCH:PEAK**.
2. Press **PEAK DEF MENU**.
3. Press **PEAK DEF:ΔX**. Then enter a width of the peak.
4. Press **PEAK DEF:ΔY**. Then enter a height of the peak.

#### Using the Marker.

1. Press **Marker**. Then move the marker on the local maximum you want to search.
2. Press **ΔMODE MENU ΔMKR**.
3. Press **Search** **SEARCH:PEAK PEAK DEF MENU**.
4. Move the marker to the foot of the peak.
5. Press **MKR→PEAK DELTA**.

This parameter defines the slope of the peak. The definition is made by defining  $\Delta X$  and  $\Delta Y$  as shown in Figure 4-12. The search function searches only for peaks that are steeper than the specified slope. Use this function when the search function searches for a peak that has a gentle slope.

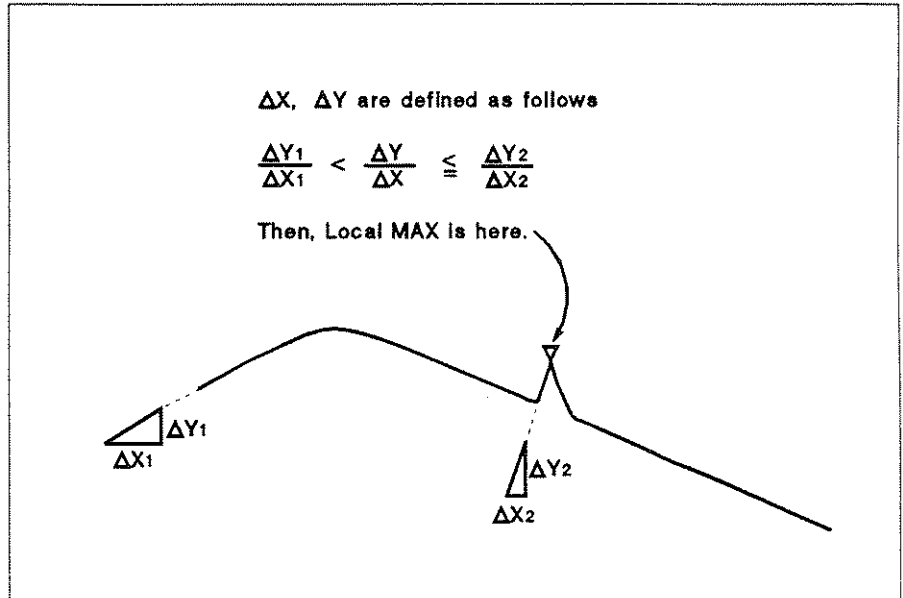

C5204013

Figure 4-12. Peak Definition

### Specifying the Peak Threshold to Ignore the Absolutely Small Peaks

#### Entering Directly.

1. Press **[Search]** SEARCH:PEAK PEAK DEF MENU .
2. Press THRESHOLD VALUE .
3. Enter a threshold value.
4. Toggle THRESHOLD on OFF to ON off .

The red threshold line is displayed. The all search function searches for only the upper side of the threshold line.

#### Using the Marker.

1. Press **[Search]**.
2. Press SEARCH:PEAK PEAK DEF MENU .
3. Move the marker to the point you want to set as the threshold value.
4. Press MKR→THRESHOLD .
5. Toggle THRESHOLD on OFF to ON off .

For more information about a peak definition, see chapter 12 of the *Function Reference*.



## Typical Network Measurements

---

This chapter provides the following typical measurement techniques using the network analyzer mode of operation:

- To measure the 3 dB bandwidth using the width function
- To monitor the spectrum of the network measurement input
- To measure the electrical length
- To measure the phase deviation
- To cancel an extension of a measurement cable

## To Measure the 3 dB Bandwidth Using the Width Function

1. Press **Search**.
2. Do either one of the following:

To Use	Do
Maximum point as a reference	Press <b>MAX</b> .
Nominal frequency as a reference	Enter the nominal frequency using the numerical keys.

3. Press **ΔMODE MENU ΔMKR** to make the marker a reference.
4. Press **Search WIDTH [OFF] WIDTH VALUE**.
5. Press **(-) (3) (x1)** to enter -3 dB.
6. Toggle **WIDTH on OFF** to **ON off**.

The sub-markers appear at a specified level down on both sides of the reference marker and the center of the two sub-markers, as shown in Figure 5-1. The bandwidth (BW), center frequency (cent), Q factor (Q), insertion loss (loss), and left and right hand bandwidth from the center frequency ( $\Delta L.F$  and  $\Delta R.F$ ) are displayed on the upper right of the grid.

You can move the reference marker using the rotary knob. When you enable the width function, the reference marker automatically turns into a tracking  $\Delta$ marker that allows you to move the reference marker.

For more information about the width function, see chapter 12 of the *Function Reference* manual.

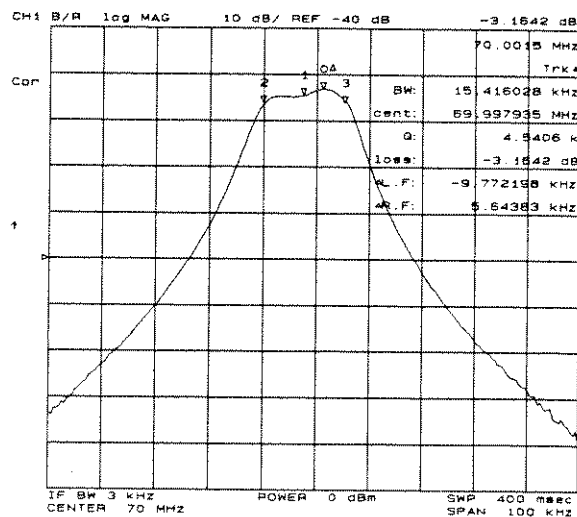

Figure 5-1.  
Bandwidth Measurement Using Width Function



## To Monitor the Spectrum of the Network Measurement Input

1. Press **Display**. Then toggle **DUAL CHAN** on **OFF** to **ON** off.
2. Press **Ch 1** or **Ch 2** to activate the other channel (that is, the channel that was not used for the network measurement).
3. Press **Meas** **ANALYZER TYPE**.
4. Press **SPECTRUM ANALYZER** to set the spectrum analyzer mode.
5. Set the same frequency setting for both channels.
6. Press **Meas**. Then select the input port (**A** or **B**) that you used for the network measurement.

You can monitor the spectrum of the network input without reconnecting the cables. This feature allows you to analyze the network characteristics while separating the effect of unknown signals (for example spurious signals) without performing any additional procedures.

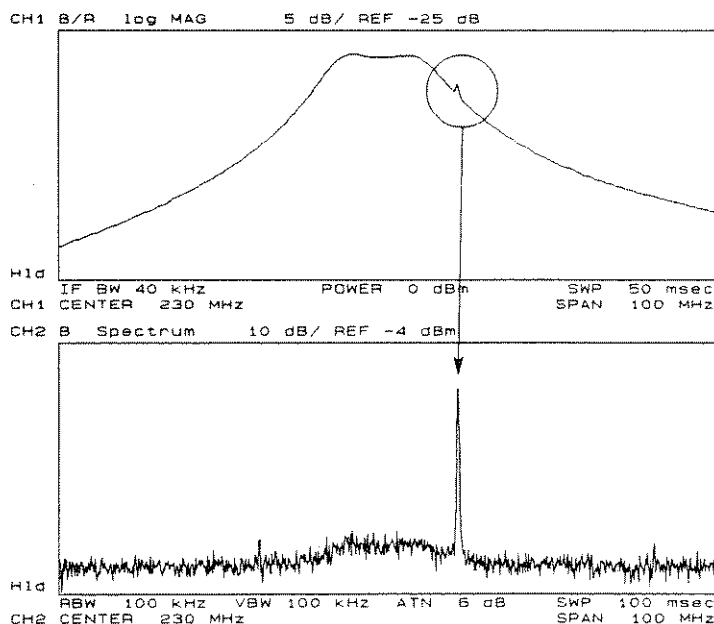
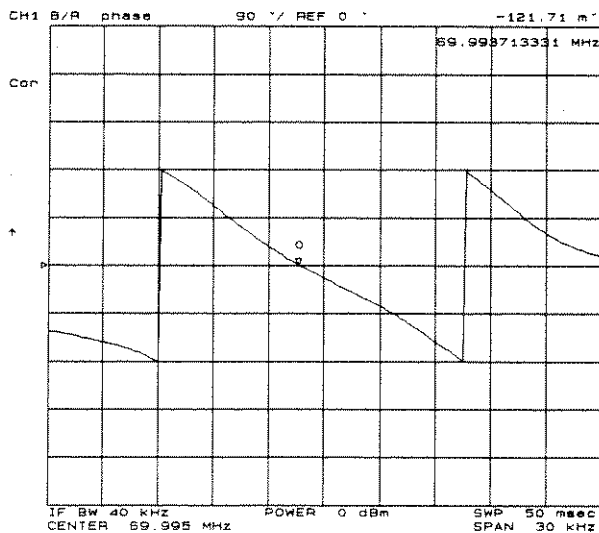

Figure 5-2. Spectrum Monitoring in the Network Measurement

## To Measure the Electrical Length

1. Select the phase format.
2. Do one of the following procedure:
  - Using the marker:
    - a. Press **Marker**.
    - b. Turn the rotary knob to position the marker at the center of the display.
    - c. Press **Scale Ref** **ELECTRICAL DELAY MENU**.
    - d. Press **MKR**→**DELAY**.
  - Using the rotary knob:
    - a. Press **Scale Ref** **ELECTRICAL DELAY MENU**.
    - b. Press **ELECTRICAL DELAY**.
    - c. Turn the rotary knob until the trace becomes flat at the interested frequency.
3. Press **ELECTRICAL DELAY**. Then read the electrical length that is displayed under the electrical delay time.



Before Adding the Electrical Length

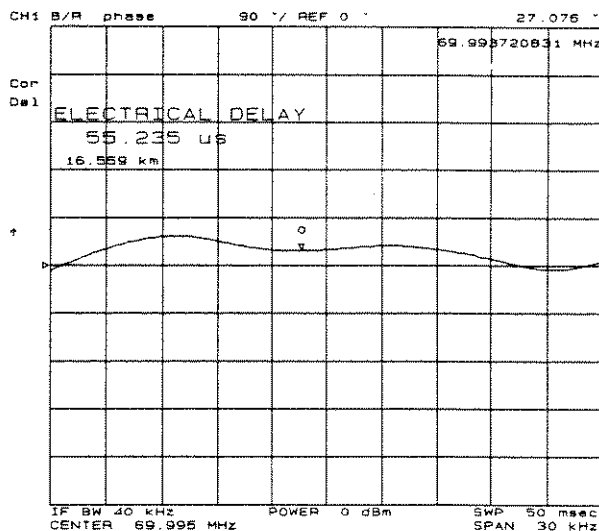

After Adding the Electrical Length

Figure 5-3. Adding Electrical Length

If the average relative permittivity ( $\epsilon_R$ ) of the DUT is known over the frequency span, the length calculation can be adjusted to better indicate the actual length of the DUT. This can be done by entering the relative velocity factor for the DUT.

### To Set Velocity Factor of a Cable

1. Press **Cal**.
2. Press **MORE**.
3. Press **VELOCITY FACTOR**.
4. Enter a new value. Then press **x1**.

The relative velocity factor for a given dielectric can be calculated by:

$$V_f = \frac{1}{\sqrt{\epsilon_R}}$$

Default setting of the velocity factor is 1.

## To Measure the Phase Deviation

### To Measure the Phase Deviation

#### To Display the Deviation from the Linear Phase

1. Set up the frequency range.
2. Display the phase trace by pressing **Format** **PHASE**.
3. Adjust the scale settings by pressing **Scale Ref** **AUTO SCALE**.
4. Press **Marker**. Then move the marker to any of the points where the sloping trace crosses the center (place the marker on the sloping portion of the trace, not the vertical phase "wrap-around").
5. Press **Scale Ref** **ELEC DELAY MENU** **MKR**→**DELAY** to add enough electrical length to match the group delay present at the marker frequency.
6. Read the phase value as a deviation from the linear phase.

By adding the electrical length to flatten the phase response, the linear phase shift caused by the DUT is removed. The displayed response is the deviation from the linear phase.

To turn off the electrical length function, press **Scale Ref** **ELEC DELAY MENU** **ELECTRICAL DELAY** **0** **X1**.

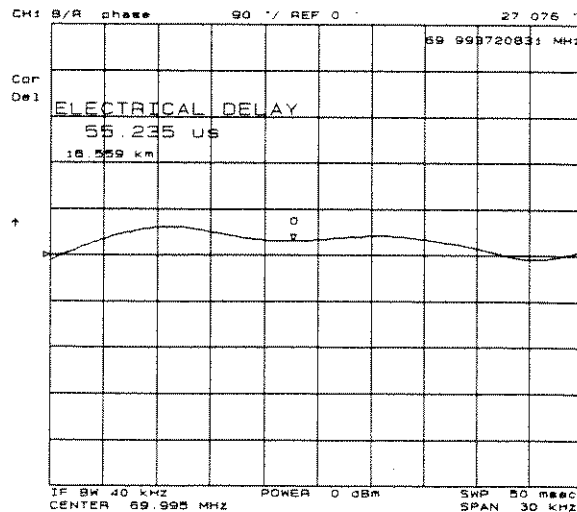

Figure 5-4. Deviation from the Linear Phase

### To Display the Group Delay

1. Press **Format**.
2. Press **DELAY**.

The group delay format displays phase deviation to group delay aperture. Therefore, setting the group delay aperture affects the trace shape. Setting a wider aperture makes the trace smoother. The default setting of the aperture is 1% of span.

### To Set the Group Delay Aperture

1. Press **Bw/Avg**.
2. Press **GROUP DELAY APERTURE**.
3. Enter group delay aperture value as a percentage of the span.

The Group delay aperture is based on the number of points, not the real aperture. For example, if the number of points is 201, a 1% group delay aperture calculates the group delay using the adjacent measurement points on both sides. Therefore, the group delay trace is different by the number of points setting even if the group delay aperture is the same setting.

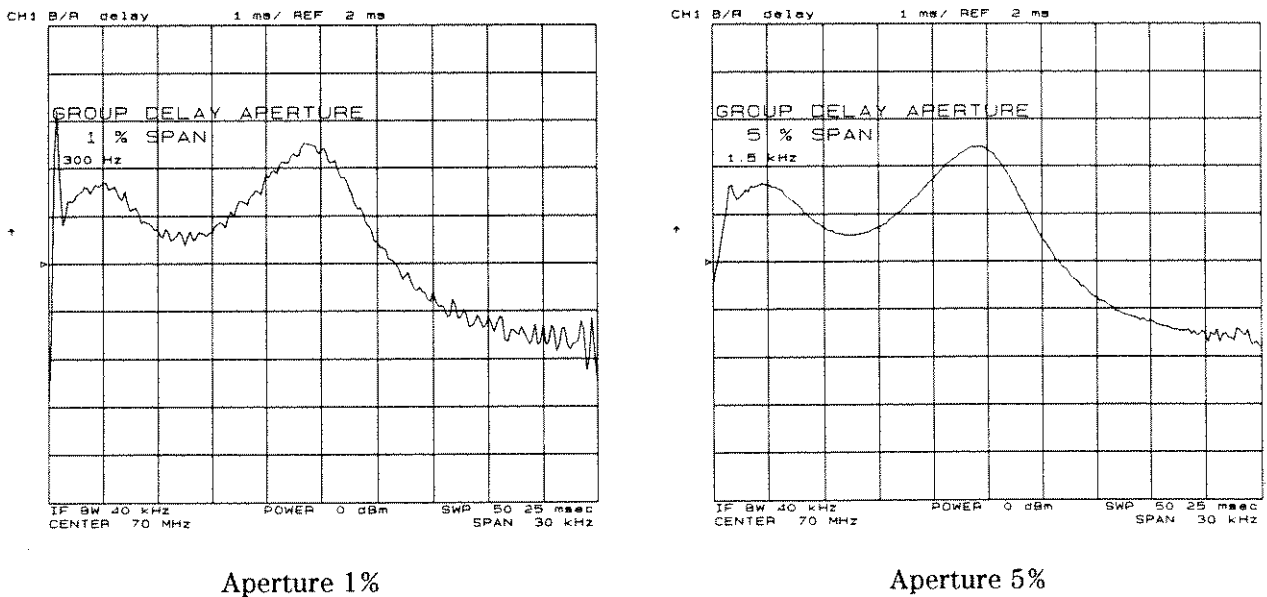

Figure 5-5. Setting Group Delay Aperture

For more information about a group delay, see chapter 12 of the *Function Reference*.

## To Cancel an Extension of a Measurement Cable

### If the Electrical Delay of the Extended Cable is Known

1. Press **Cal** **MORE** **PORT EXTENSION** to call the port extension menu.
2. Enter the electrical delay values for each input.
  - If you do not use the S-parameter test set:
    - Press **EXTENSION INPUT R**. Then enter the electrical delay of the cable that is connected to the R input.
    - Press **EXTENSION INPUT A**. Then enter the electrical delay of the A input.
    - Press **EXTENSION INPUT B**. Then enter the electrical delay of the B input.

If you use the transmission/reflection (T/R) test set, enter the electrical delay of the cable that is connected to the TEST PORT (for the R and A inputs).

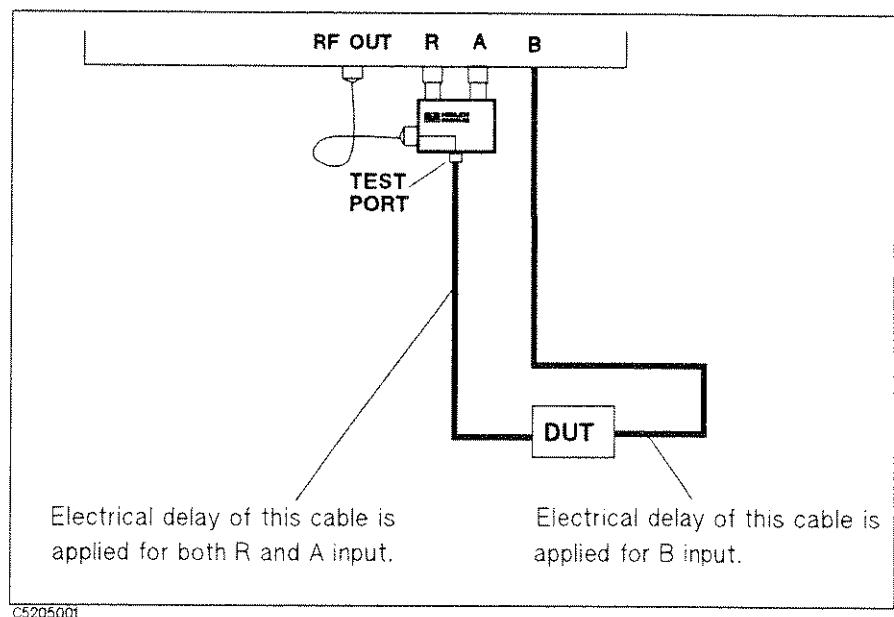

Figure 5-6. Port Extension With the T/R Test Set

## To Cancel an Extension of a Measurement Cable

- If you use the S-parameter test set:
  - Enter "0" for EXTENSION INPUT R, EXTENSION A and EXTENSION INPUT B to clear the port extension of the R, A and B inputs.
  - Press EXTENSION PORT 1. Then enter the electrical delay of the PORT 1.
  - Press EXTENSION PORT 2. Then enter the electrical delay of the PORT 2.
- 3. Toggle EXTENSION on OFF to ON off to enable the port extension.

## To Cancel an Extension of a Measurement Cable

### If the Electrical Delay of the Extended Cable is Unknown

You can determine the electrical delay of the cable by following methods:

- Measuring the electrical length of the cable.
- Measuring the OPENed or SHORTed cable reflection.

#### Measuring the Electrical Length of the Cable

1. Connect the cable as shown in Figure 5-7.
2. Set up the frequency range to the measurement condition.
3. Press **[Meas]** **B/R** (or **Trans:FWD S21 [B/R]**) to select the transmission measurement.
4. Press **[Format]** **PHASE** to select the phase format.
5. Press **[Marker]**. Then move the marker to the sloping trace that crosses the center of the display.
6. Press **[Scale Ref]** **ELEC DELAY MENU ELECTRICAL DELAY MKR→DELAY**, then read the electrical delay of the cable.
7. Press **[0]** **[X1]** to clear the electrical delay offset.
8. Enter a measured electrical delay as described in the "If the Electrical Delay of the Extended Cable is Known" procedure.

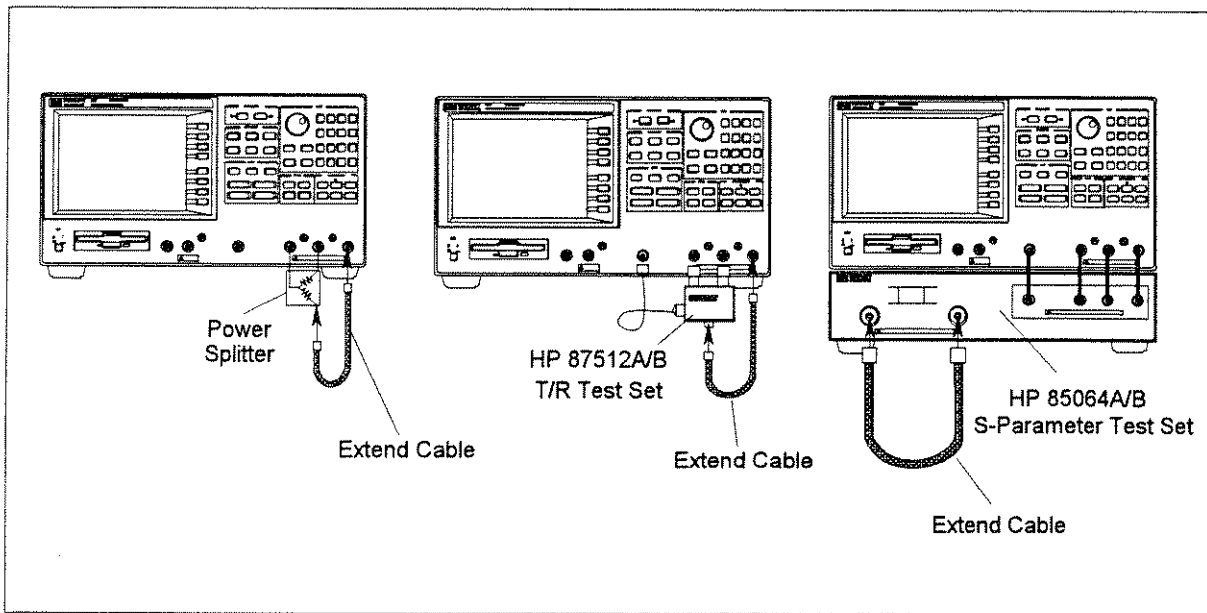

Figure 5-7. Cable Measurement Configuration



## To Cancel an Extension of a Measurement Cable

### Measuring the OPENed or SHORTed Cable Reflection

1. Connect the cable as shown in Figure 5-8.
2. Set up the frequency range for the measurement condition.
3. Press **Meas** **A/R** (or **Ref1:FWD S11 [A/R]**) to select the reflection measurement.
4. Press **Format** **PHASE** to select the phase format.
5. Press **Marker**. Then move the marker to the sloping trace that crosses the center of the display.
6. Press **Scale Ref** **ELEC DELAY MENU** **ELECTRICAL DELAY** **MKR→DELAY**, then read the electrical delay of the cable. Note that this value is twice the real delay because there is an output and a return paths.
7. Press **0** **(x1)** to clear the electrical delay offset.
8. Enter *half the value* of the measured electrical delay as described in the "If the Electrical Delay of the Extended Cable is Known" procedure.

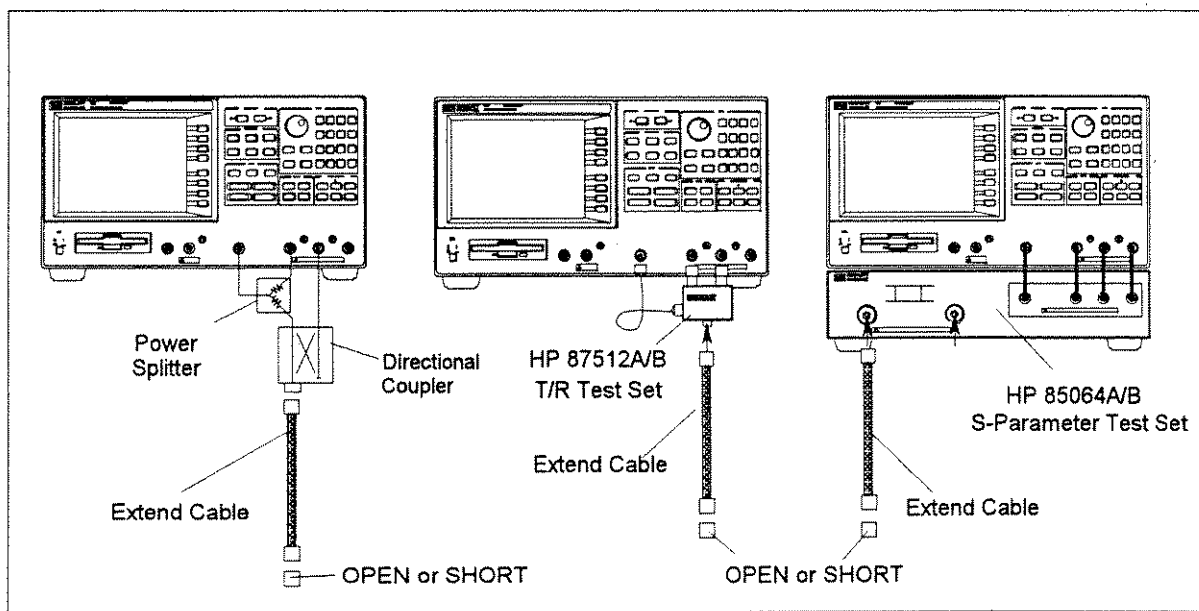
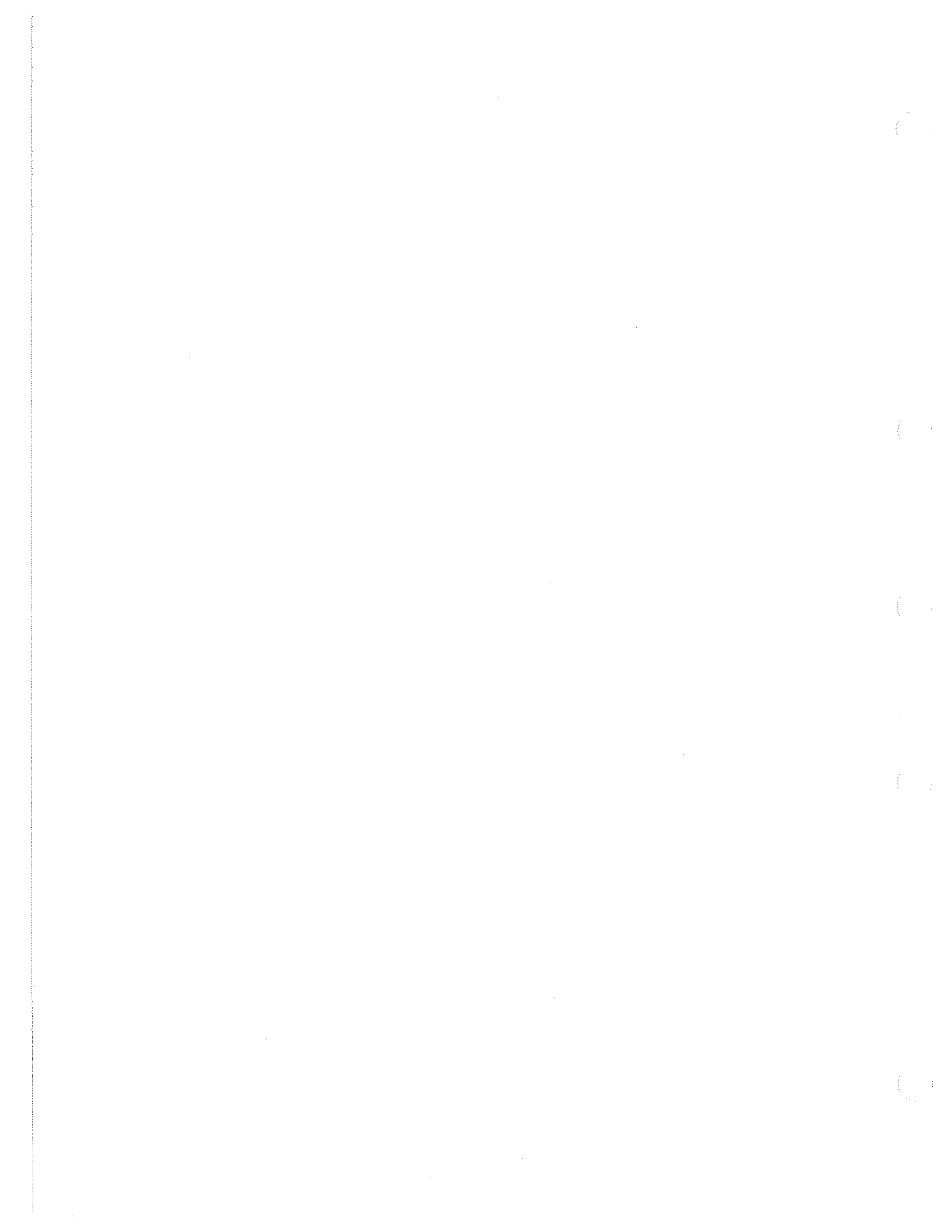

Figure 5-8. Cable Measurement Configuration

**Notes** For more information about Electrical delay and port extension, refer to chapter 5 of the *Function Reference*.



## Using Features Common to Both Modes of Operation

---

This chapter provides procedures for the analyzer features that can be used in both the spectrum and network analyzer modes of operation.

This chapter provides the following procedures:

- To perform GO/NO-GO testing
- To offset the limit line
- To make a list sweep
- To use the trace memory
- To offset the trace
- To use the trace math functions
- To print and plot
- To save and recall

## To Perform GO/NO-GO Testing

### Step 1: Planning the Limit Line

1. Determine the following parameters before editing the limit line:

Parameter	Description
Sweep Parameter	Frequency of each segment.
Upper Limit	Upper limit level of each segment.
Lower Limit	Lower limit level of each segment.

The limit line is constructed by connecting the segment points as shown in Figure 6-1.

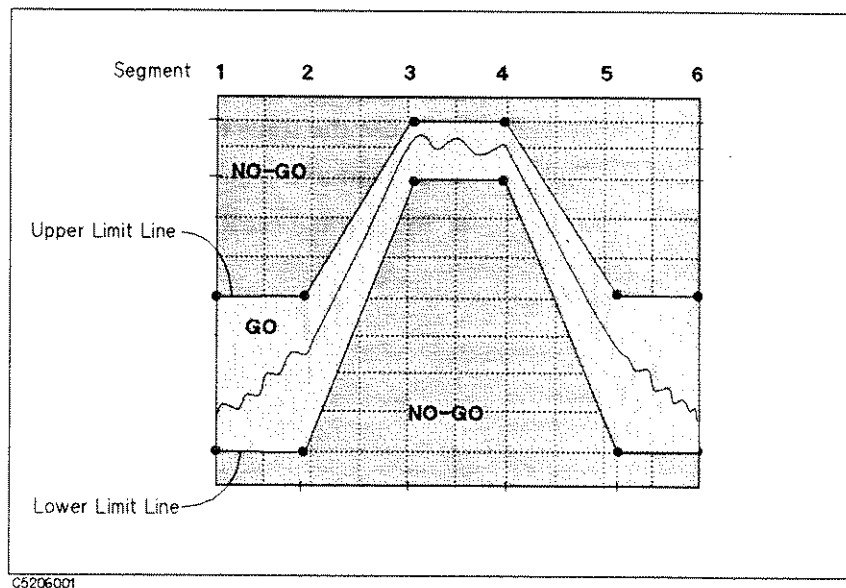
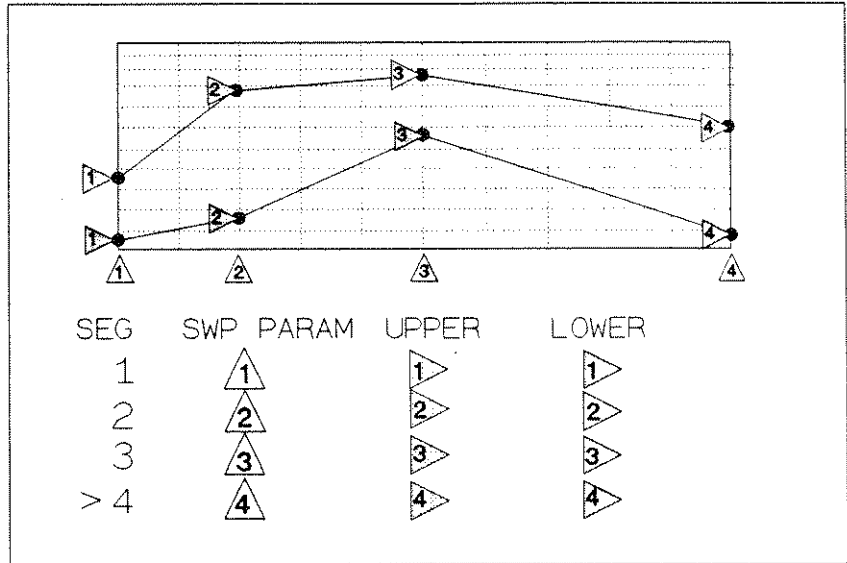

Figure 6-1. Limit Line Image

For example, if you want to specify four points for the limit test, the limit line image is as shown in Figure 6-2. Each point has frequency information and an upper and a lower limit value. Enter these values as described in the "Step 2: Editing a Limit Line Table" procedure.



C5206003

Figure 6-2. Frequency, Upper and Lower Limit

In this example, the limit line connects four limit points. If a measured trace exceeds the upper or lower limit line, the limit test fails.

## Step 2: Editing a Limit Line Table

1. Set up the frequency range of the grid before starting the limit line edit.
2. Press **System**.
3. Press **LIMIT MENU**. Then toggle **LIMIT LINE** on OFF to ON. This makes it easier to understand the status of the limit line while you are editing it.
4. Press **EDIT LIMIT LINE** to call the limit line editor.
5. If an old limit line table is still in the limit line editor, press **CLEAR LIST CLEAR LIST YES** to clear it.
6. Press **EDIT** to edit the first segment.

## To Perform GO/NO-GO Testing

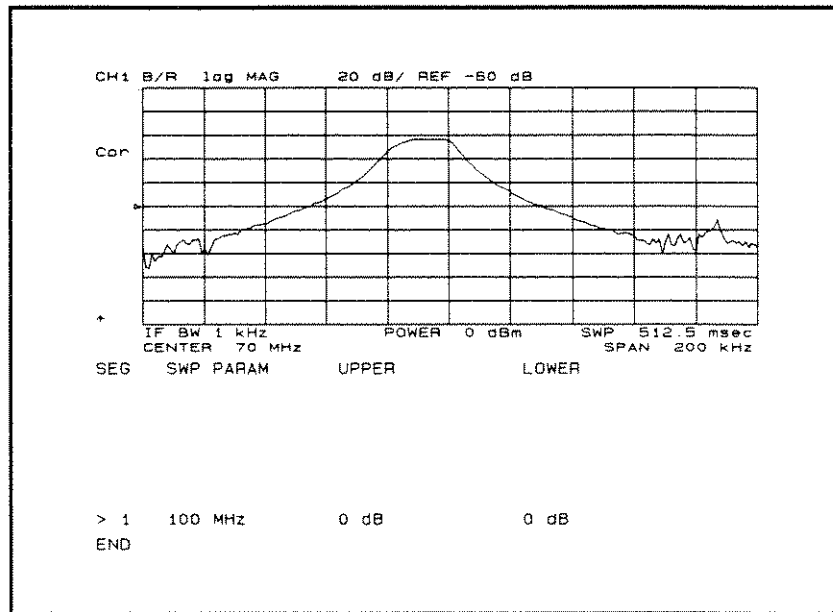

Figure 6-3. Limit Line Editor

7. Enter the frequency of the segment in one of the following ways:
  - Press **SWP PARAM**. Then enter the frequency of the segment.
  - Move the marker to the point you want to use as the frequency of the segment. Then press **MKR→SWP PARAM**.
8. Press **UPPER LIMIT**. Then enter an upper limit value.
9. Press **LOWER LIMIT**. Then enter a lower limit value.
10. Press **DONE** to end editing the segment.
11. Press **ADD** to edit the next segment.
12. Repeat list item 7 to list item 11 until all segments are defined.
13. When you finish editing all segments, press **DONE** to complete editing the limit line table.

You can enter the limit value using the middle and width method by pressing **MIDDLE VALUE** and **DELTA LIMIT**. You then enter the amplitude value as a middle amplitude value with a delta limit. The upper and lower limit lines appear at an equal positive and negative distance from the specified middle amplitude.

**To Modify or Delete the Segment**

1. Press **SEGMENT**.
2. Select the segment you want to delete or modify:
  - Enter the segment number you want to modify. Then press **(X1)**.
  - Move cursor, ">", to the segment you want to modify by using the **(↑)**, the **(↓)**, or the **(↻)**.
3. Do either of the following:

To	Press
Modify specified segment	EDIT
Delete specified segment	DELETE

**Step 3: Executing a Limit Line Test****To Make a Limit Line Test Active**

1. Press **(System)**.
2. Press **LIMIT MENU**.
3. Toggle **LIMIT TEST** on **OFF** to **ON** off.

If the limit line test passes, a green **PASS** message appears on the right of the grid. If it fails, a red **FAIL** message is displayed. You can set the analyzer to beep if the limit line test fails. (See the "To Beep When the Limit Test is Failed" procedure.)

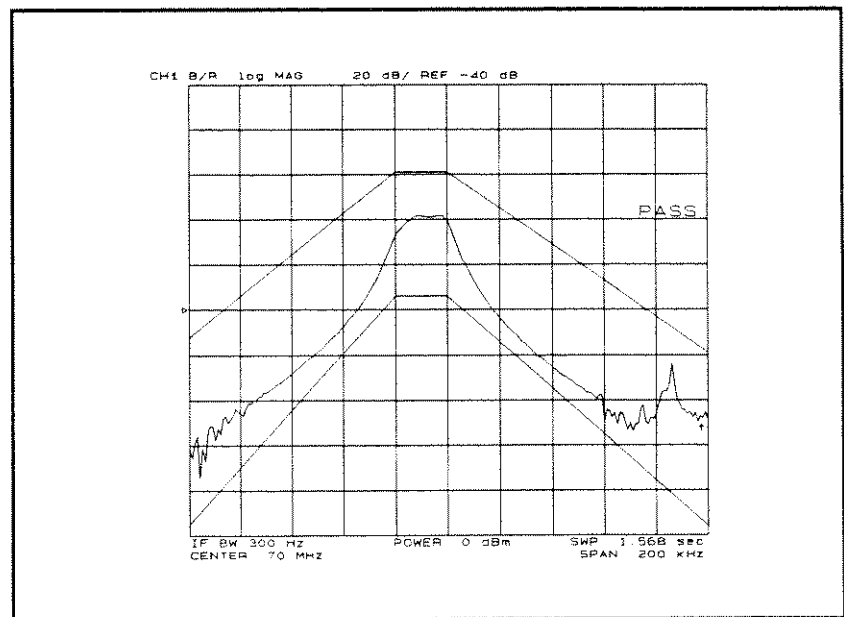

Figure 6-4. Limit Line Test

## To Perform GO/NO-GO Testing

### To Beep When the Limit Test is Failed

1. Press **System**.
2. Press **LIMIT MENU**.
3. Toggle **BEEP FAIL** on **OFF** to **ON** off.

**Notes** You can save the edited limit line table with all other instrument settings by pressing **Save** **STATE**. See "To Save an Analyzer Setting or Measurement Data" for more information.



## To Offset the Limit Line

1. Press **(System)** **LIMIT MENU**.
2. Press **LIMIT LINE OFFSETS**.
3. Press the following keys:

To move line	Press
Horizontally	SWP PARAM OFFSET
Vertically	AMPLITUDE OFFSET

4. Then move the limit line by entering an offset value using one of the following:

To	Use
Move continuously	
Move with steps	
Enter offset value directly	<b>(0)</b> ... <b>(9)</b> and unit keys

5. To move the limit line vertically to the marker position:
  - a. Press **(Marker)** Then move the marker to the point you want to set as the offset value.
  - b. Press **(System)** **LIMIT LINE MENU** **LIMIT LINE OFFSETS**  
**MKR** → **AMP. OFS.**
6. When you are finished offsetting the limit line, press **RETURN**.

## To Offset the Limit Line

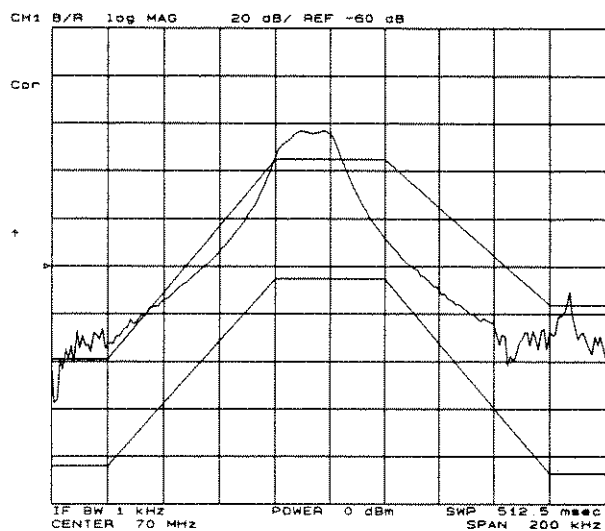

Before Offset

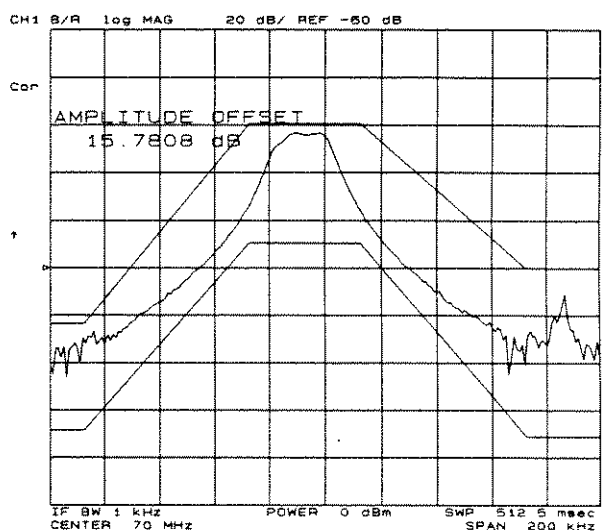

After Offset

**Figure 6-5. Offsetting Limit Lines**

To clear the offset, enter 0 for all the offset values.

## To Make a List Sweep

### Step 1: Planning the List Sweep

1. Determine the following parameters before editing the sweep list.

Parameter	Description
Sweep Parameter	Frequency (or power for the power sweep) of each segment. Each segment cannot be continuous. You can reduce the sweep time by setting the segment only for the required part of the trace.
Number of points	Number of display points. You can adjust the display area for each segment by setting this parameter.
RBW	This parameter is for the spectrum analyzer mode. You can set the resolution bandwidth for the each segment individually. This is useful if you want to display higher resolution only for the specific segment.
IF BW	This parameter for the network analyzer mode. You can set the IF bandwidth for each segment individually. This is useful if you want to display higher dynamic range only for the specific segment.
Output Power	Output power from the RF OUT port of each segment. The allowable range is -70 dBm to +20 dBm. When you want to use the internal tracking generator for spectrum measurement, you can set this parameter in the spectrum analyzer mode. *

\*  $RBW \geq 10$  kHz only.

## To Make a List Sweep

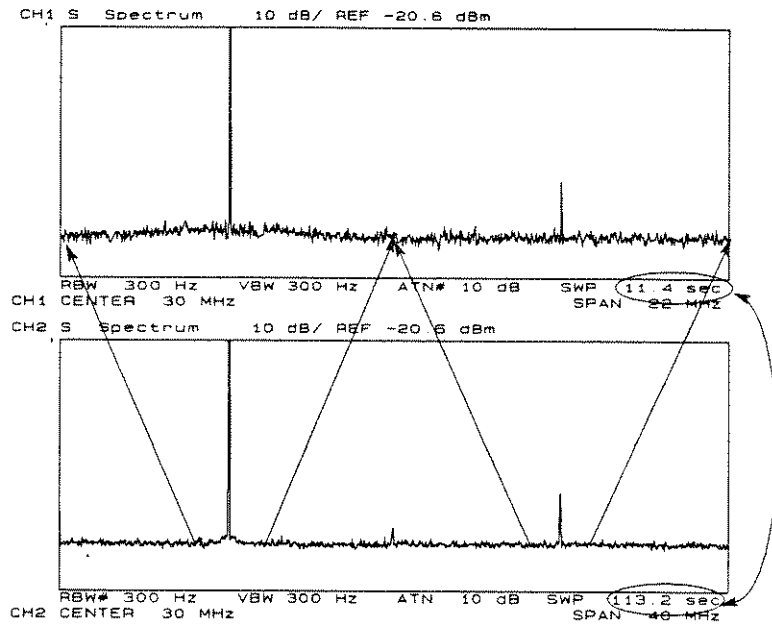

Figure 6-6. List Sweep (Upper) Reduces Sweep Time

## Step 2: Editing a Sweep List

1. Press **Sweep** **SWEEP TYPE MENU EDIT LIST** to call the sweep list editor.
2. Press **EDIT** to edit the sweep list.

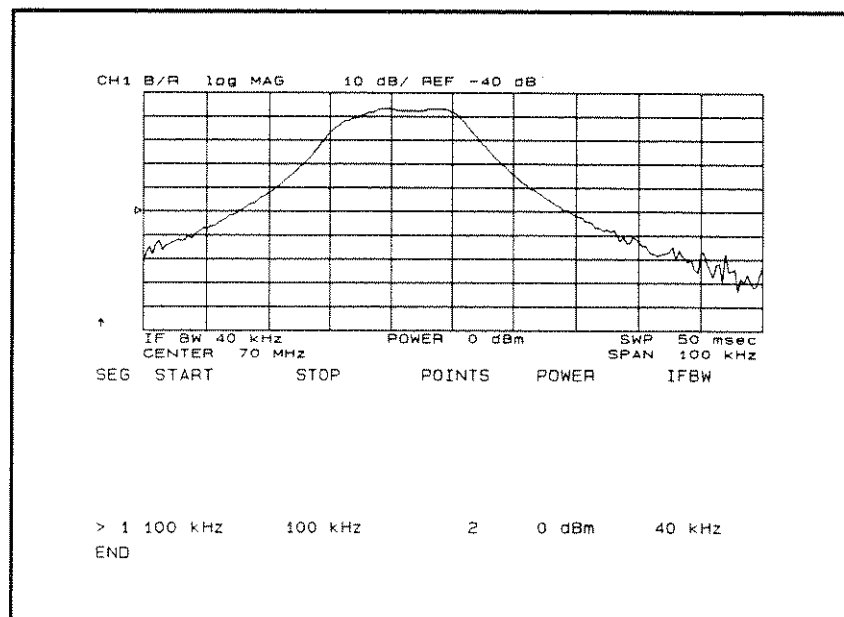

Figure 6-7. List Sweep Editor

3. Enter the frequency (or power) range of the segment.

### To Make a List Sweep

- Move the marker to the start point. Then press **SEGMENT: MKR→START**.
  - Move the marker to the stopping point. Then press **MKR→STOP**.
  - Press **(Start)** to enter the start sweep parameter. Then press **(Stop)** to enter the stop sweep parameter.
4. Press **NUMBER of POINTS**. Then enter the number of points for the segment.
  5. Set the output power:
    - When in spectrum analyzer mode, ignore this parameter unless you are using the internal tracking generator. The default value (0 dBm) is not applied until you turn on the RF Output.
    - Press **POWER**. Then enter the output power level for the segment.
  6. Set the internal filter bandwidth:
    - When in spectrum analyzer mode, press **RES BW** to set the resolution bandwidth.
    - When in network analyzer mode, press **IF BW** to set the IF bandwidth.
  7. Press **SEGMENT DONE** to complete editing the segment.
  8. Press **ADD** to edit the next segment.
  9. Repeat list item 3 to list item 8 until you complete editing of all required segments.
  10. When you finish editing all the segments, press **LIST DONE** to complete the sweep list.

### To Modify or Delete the Segment

1. Press **SEGMENT**.
2. Select the segment you want to delete or modify:
  - Enter the segment number you want to modify. Then press **(X1)**.
  - Move the cursor, ">", to the segment you want to modify by using the **(↑)**, the **(↓)**, or the **(↻)**.
3. Do either of the following:

To	Press
Modify specified segment	<b>EDIT</b>
Delete specified segment	<b>DELETE</b>

## To Make a List Sweep

### Step 3: Activating the List Sweep

1. Press **Sweep**.
2. Press **SWEEP TYPE MENU**.
3. Press **LIST FREQ**.
4. If you use the output power in the spectrum analyzer mode, press **Source**. Then toggle **RF OUT** on **OFF** to **ON** off.

**Notes** If you want to delete an edited sweep list, press **Sweep**  
**SWEEP TYPE MENU EDIT LIST CLEAR LIST CLEAR LIST YES**.

You can save and recall the edited sweep list with all other instrument settings by pressing **Save** **STATE**. See "To Save an Analyzer Setting or Measurement Data" for more information.

For more information about the list sweep, see chapter 6 of the *Function Reference*.

## To Use the Trace Memory

### Step 1: To Store the Trace into the Trace Memory

1. Display the trace you want to store into the trace memory.
2. Press **Display**.
3. Press **DATA→MEMORY**.

This operation only stores the digitized trace data into the trace memory (not the display on CRT). You can store the trace data for the trace memory of each channel individually. The stored trace data is retained until new data is stored, the analyzer is preset, or power is turned off.

### Step 2: To Display Memory Traces

1. Press **Display**.
2. Select the display trace:

To display	Press
Memory trace	MEMORY
Data and memory trace together	DATA and MEMORY
Data trace	DATA

Memory traces are displayed as green (channel 1) or red (channel 2) to distinguish between the two traces. You can change this color by using the modify colors menu under **Display** MORE ADJUST DISPLAY.

If the trace memory of the active channel is empty, the error message (CAUTION: NO VALID MEMORY TRACE) is displayed.

**Notes** The scale of the memory trace is coupling with the data trace. If you want to change the scale setting for only the data or memory trace, toggle **Scale Ref** D&M SCALE [COUPLE] to [UNCOUPLE]. Then toggle SCALE FOR [DATA] or [MEMORY] before you change the settings.

For more information about trace memory, see chapter 5 of the *Function Reference*.

## To Offset the Trace

### To Offset the Trace

1. Press **Display**.
2. Press **DATA MATH [DATA]**.
3. Press **OFFSET**. Then enter the offset value.

To	Press
Set the marker position to the offset value	<b>MKR→OFFSET</b>
Enter the offset value directly	<b>OFFSET</b> . Then enter the offset value

4. Press **RETURN**.

For example, if an attenuator is inserted between a signal source and the input port of the analyzer, the offset function corrects the attenuation of the input signal and displays the trace referenced to the input signal to the attenuator.

Offset indicator, **-0**, appears on the left side of the grid.

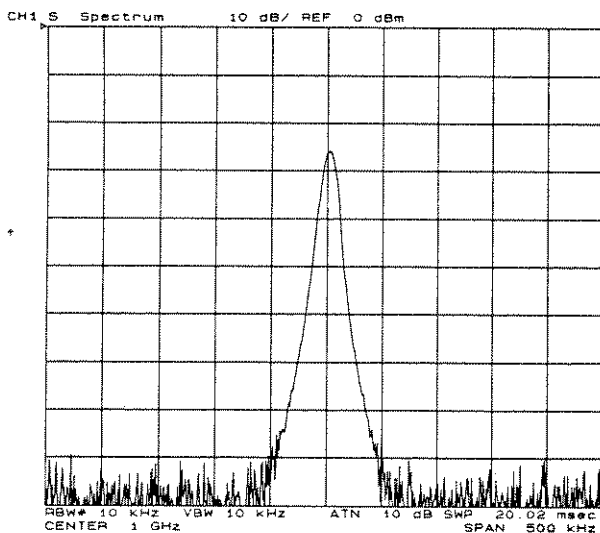

6 dB Attenuated Signal

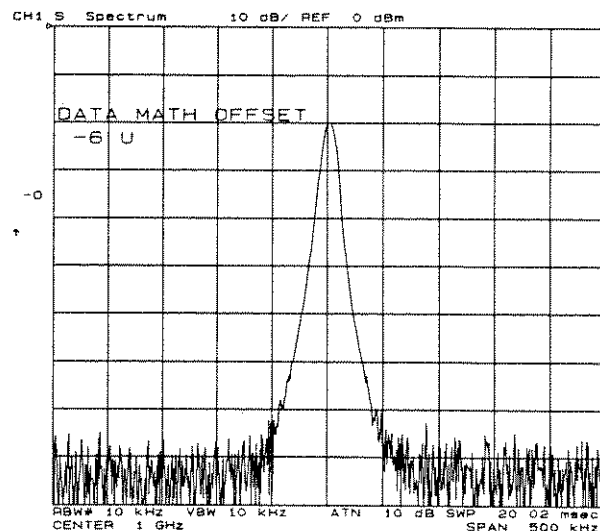

After Offset

Figure 6-8. Offsetting the Trace

### To Clear the Offset

1. Press **Display**.
2. Press **DATA MATH [DATA-0]**.
3. Press **DEFAULT GAIN & OFS**.

**Notes** For more information about offsetting and multiplying traces, see the *Function Reference*.



## To Use the Trace Math Function

1. Press **Display**.
2. Press **DATA MATH [DATA]**.
3. Do one of the following:



To	Press
Add Trace with Memory Trace	DATA+MEM
Subtract Trace with Memory Trace	DATA-MEM
Divide Trace with Memory Trace	DATA/MEM

## To Turn Off the Data Math Function

1. Press **Display**.
2. Press **DATA MATH**.
3. Press **DATA MATH: DATA**.

## To Multiply the Trace

1. Press **Display**.
2. Press **DATA MATH [DATA]**.
3. Press **GAIN**. Then enter a multiplication factor:

To	Use
Change value continuously	
Change value with 1-2-5 steps	
Enter value directly	<b>0</b> ... <b>9</b> and unit keys

## To Clear a Multiplied Trace

1. Press **Display**.
2. Press **DATA MATH [G\*DATA]**.
3. Press **DEFAULT GAIN & OFS**.

### To Print and Plot

This step provides the following procedures for printing and plotting:

- To print out a display image
- To see or print a measured value list
- To print an analyzer setting
- To plot a display image
- To plot to a transparent sheet
- To use a different HP-IB address for the printer/plotter

### To Print Out a Display Image

1. Connect the printer to the analyzer with an HP-IB cable.
2. Set the HP-IB address of the printer to 1.
3. Verify that the printer is NOT set to the "Listen Always" mode.
4. Press **Local**. Then press **SYSTEM CONTROLLER**.
5. Press **Copy** **PRINT [STANDARD]** to print out a display image.

To stop printing or plotting in progress, press **Copy** **COPY ABORT**.

### To See or Print a Measured Value List

1. Press **Copy**.
2. Press **MORE LIST VALUES** to display the measured value list.
  - To see all of the measured value list, press **NEXT PAGE** or **PREV PAGE** to turn the pages.
  - To print or plot out the measured value list, press **PRINT [STANDARD]** or **PLOT** respectively.
  - To return to the measurement display, press **RESTORE DISPLAY**.

## To Print an Analyzer Setting

1. Press **Copy**.
2. Press **MORE OPERATING PARAMETERS** to display the analyzer setting table as shown below.
3. Press **PRINT [STANDARD]** to print out the settings.
4. To return to the measurement display, press **RESTORE DISPLAY**.

Analyzer Setting Table

OPERATING PARAMETER	CH1	CH2
ANALYZER TYPE	NA	NA
SWEEP TYPE	LIN FREQ	LIN FREQ
NUMBER of POINTS	201	201
RF OUT	ON	ON
PORT 1 ATTEN.	0 dB	0 dB
PORT 2 ATTEN.	0 dB	0 dB
GROUP DELAY APERTURE	1 % SPAN	1 % SPAN
PHASE OFFSET	0 °	0 °
PORT 1 EXTENSION	0 s	0 s
PORT 2 EXTENSION	0 s	0 s
INPUT R EXTENSION	0 s	0 s
INPUT A EXTENSION	0 s	0 s
INPUT B EXTENSION	0 s	0 s
	OFF	OFF
VELOCITY FACTOR	1	1
CAL KIT	7mm	7mm
Z0	50 ohm	50 ohm
CAL TYPE	NONE	NONE

## To Plot a Display Image

1. Connect an HP-IB plotter to the analyzer with an HP-IB cable.
2. Set the HP-IB address of the plotter to 5.
3. Press **Local**. Then press **SYSTEM CONTROLLER**.
4. Press **Copy PLOT** to plot out a display image.

To stop printing or plotting in progress, press **Copy COPY ABORT**.

## To Print and Plot

### To Plot to a Transparent Sheet

1. Press **Copy** **DEFINE PLOT**.
2. Toggle **PLOT SPEED** to **[SLOW]**.
3. Set a transparent sheet on the plotter.
4. Plot the image as described in the "To Plot a Display Image" procedure.

### To Use a Different HP-IB Address for the Printer/Plotter

1. Press **Local** **SET ADDRESSES**.
2. Press **ADDRESS: PLOTTER** or **ADDRESS: PRINTER**. Then enter a new HP-IB address.
3. Press **RETURN** to return to the top menu.

**Notes** Available printers and plotters are listed in chapter 9 of the *Function Reference*.

## To Save and Recall

This step provides the following procedures for saving and recalling:

- To save an analyzer setting or measurement data
- To recall a saved analyzer setting
- To save a display image to an HP-GL file
- To save measured data for a spreadsheet
- To copy the file
- To initialize a disk for use
- To initialize the RAM disk for use

## To Save an Analyzer Setting or Measurement Data

1. Insert a LIF or DOS formatted 3.5 inch disk into the built-in disk drive (if you are recalling an instrument state file from the RAM disk, skip this step).
2. Press **Save**.
3. Select a save data type:

Save Data Type	Press
Instrument states only	STATE
Measurement data only <sup>1</sup>	DATA ONLY (binary)

<sup>1</sup> You can specify a data array type. See the "To Specify a Data Array Type" procedure.

4. Select where the file is stored by pressing either **STOR DEV [DISK]** (for the built-in disk drive) or **STOR DEV [MEMORY]** (for the RAM disk).
5. Enter a filename. Then press **DONE**.

The analyzer automatically detects the disk format as either the LIF (Logical Interchange Format) or DOS (Disk Operating System). If you insert an any other format type disk, an error message is displayed.

For more information, appendix C of the *Function Reference* provides a complete list of the instrument state to be saved.

### Note



You can automatically recall the instrument state every time the analyzer is turned ON. Use "AUTOREC" as a filename. The analyzer recalls this file from a disk that is inserted in the built-in disk drive when it is turned ON.

## To Save and Recall

### To Specify a Data Array Type

1. Press **Save** **DEFINE SAVE DATA**.
2. Toggle to **ON off** the item what you want to save:

<b>Data array</b>	<b>Toggle</b>
Raw data array	<b>RAW on OFF to ON off</b>
Calibration data array	<b>CAL on OFF to ON off</b>
Data array	<b>DATA on OFF to ON off</b>
Memory array	<b>MEM on OFF to ON off</b>
Data Trace array	<b>DATA TRACE on OFF to ON off</b>
Memory Trace array	<b>MEM TRACE on OFF to ON off</b>

3. Press **RETURN** to return to the top menu.

### To Recall a Saved Analyzer Setting

1. Insert a disk (if you are recalling an instrument state file from the RAM disk, skip this step).
2. Press **Recall**.
3. Select where the file is stored by pressing either **STOR DEV [DISK]** (for a built-in disk drive) or **STOR DEV [MEMORY]** (for a RAM disk).
4. Search for the filename you want to recall (the files are listed on the softkey label).
5. If a target file is not listed on the softkey label, turn the label page by pressing **PREV FILES** or **NEXT FILES**.
6. Press the softkey corresponding to the filename label.

## To Save a Display Image to an HP-GL File

1. Press **Save** **ASCII SAVE**.
2. Press **GRAPHICS**.
3. Select where to store the file by pressing either **STOR DEV [DISK]** (for a built-in disk drive) or **STOR DEV [MEMORY]** (for a RAM disk).
4. Enter filename. Then press **DONE**.

The analyzer saves an HP-GL file with an extension, “.HPG” for a DOS format, or a suffix, “\_G” for a LIF format.

If you want to change the extension for a DOS format, press **Save** **ASCII SAVE DEFINE EXTENSION GRAPHICS [.HPG]** to call the extension defining menu. Then enter a new extension. This feature is only available for a DOS format disk.

If there is a file that has the same name you entered on the disk, the error message, “filename error” will be displayed. To save the file, use the other filename to save or purge the old file. To purge a file, press **Save** **FILE UTILITIES PURGE FILE** then select the displayed filename by pressing the associated softkey.

## To Save and Recall

### To Save Measured Data for a Spreadsheet

1. Insert a DOS format disk into the built-in disk drive.
2. Press **Save** **ASCII SAVE**.
3. Press **DATA ONLY (ASCII)**.
4. Select the built-in disk drive as the storage device by toggling to **STOR DEV [DISK]**.
5. Enter a filename. Then press **DONE**.

The analyzer saves an ASCII file with a ".TXT" extension. If you want to change the extension, press **Save** **ASCII SAVE DEFINE EXTENSION** **ASCII [ .TXT]** to call the extension defining menu. Then enter a new extension.

The measured data is saved as ASCII text. Each value is separated by a tab. When you open this file from the spreadsheet software, specify the file format as the "TEXT with TAB delimiter".

Frequency	Data Trace	Memory Trace
1.50E+07	-0.04E+01	0.00E+00
1.50E+07	0.52E+01	0.00E+00
1.50E+07	-0.97E+01	0.00E+00
1.50E+07	0.85E+01	0.00E+00
1.51E+07	-0.94E+01	0.00E+00
1.51E+07	-0.89E+01	0.00E+00
1.51E+07	0.37E+01	0.00E+00
1.51E+07	-1.00E+02	0.00E+00
1.51E+07	0.94E+01	0.00E+00
1.51E+07	-0.85E+01	0.00E+00
1.51E+07	-0.37E+01	0.00E+00
1.51E+07	-0.80E+01	0.00E+00
1.52E+07	-0.63E+01	0.00E+00
1.52E+07	-0.80E+01	0.00E+00
1.52E+07	0.61E+01	0.00E+00

Figure 6-9. Reading Saved Data from Spreadsheet Software



**To Copy the File**

1. Press **(Save) FILE UTILITIES**.
2. Press **COPY FILE**.
3. Select a storage device where the file is stored by toggling either **STOR DEV [DISK]** (for the build-in disk drive) or **STOR DEV [MEMORY]** (for the RAM disk).
4. Search for the filename you want to recall (the files are listed on the softkey label).
5. If a target file is not listed on the softkey labels, turn the label page by pressing **PREV PAGE** or **NEXT PAGE**.
6. Press the softkey corresponding to the filename label.
7. Enter the filename of the target file.
8. Select the target storage device by toggling **STOR DEV [DISK]** or **[MEMORY]**.
9. Press **DONE** to copy the file.

You cannot copy a file between the LIF and DOS formats. When you want to copy a file on a DOS formatted disk to the RAM disk, you must initialize the RAM disk to the DOS format.

**To Initialize a Disk for Use****Note**

---

Initializing the disk erases all data on the disk.

---

1. Verify that the disk is not write protected.
2. Insert the disk.
3. Press **(Save) FILE UTILITIES**.
4. Select the disk format (either DOS or LIF) by toggling **FORMAT [DOS]** or **[LIF]**.
5. Toggle to **STOR DEV [DISK]** to select the disk drive.
6. Press **INITIALIZE**.
7. Press **INITIALIZE DISK: YES** to initialize the disk.

## To Save and Recall

## To Initialize the RAM Disk for Use

### Note



---

Initializing the RAM disk erases all data on the RAM disk.

---

1. Press **Save** **FILE UTILITIES**.
2. Select the disk format (either DOS or LIF) by toggling **FORMAT [DOS]** or **[LIF]**.
3. Toggle to **STOR DEV [MEMORY]** to select the RAM disk.
4. Press **INITIALIZE INITIALIZE MEMORY: YES**.

The files on the RAM disk are kept until the analyzer is turned off. When the analyzer is turned off, the data on the RAM disk is lost.

The format is retained in the backup memory. The analyzer initializes the RAM disk automatically every time it is turned ON (using the format in the backup memory).

### Notes

For more information about saving data, see chapter 8 of the *Function Reference*.

## Manual Changes

---

### Introduction

This appendix contains the information required to adapt this manual to earlier versions or configurations of the HP 4396A than the current printing date of this manual. The information in this manual applies directly to the HP 4396A Network/Spectrum Analyzer serial number prefix listed on the title page of this manual.

### Manual Changes

To adapt this manual to your HP 4396A, refer to Table A-1 and Table A-2, and make all of the manual changes listed opposite your instrument's serial number and firmware version.

Instruments manufactured after the printing of this manual may be different than those documented in this manual. Later instrument versions will be documented in a manual changes supplement that will accompany the manual shipped with that instrument. If your instrument's serial number is not listed on the title page of this manual or in Table A-1, it may be documented in a *yellow MANUAL CHANGES* supplement.

Turn on the line switch or execute the "\*IDN?" command by HP-IB to confirm the firmware version. See *HP-IB Command Reference* for information on the "\*IDN?" command. For additional information on serial number coverage, see chapter 1 of the *Function Reference*.

**Table A-1. Manual Changes by Serial Number**

Serial Prefix or Number	Make Manual Changes

**Table A-2. Manual Changes by Firmware Version**

Version	Make Manual Changes

## Serial Number

Hewlett-Packard uses a two-part, nine-character serial number that is stamped on the serial number plate (see Figure A-1) attached to the rear panel. The first four digits and the letter are the serial prefix and the last five digits are the suffix.

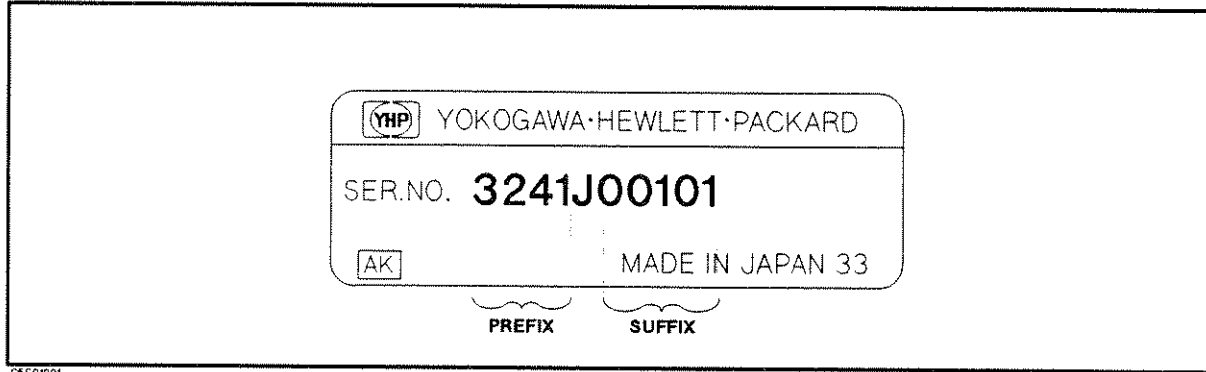

Figure A-1. Serial Number Plate

# Index

## 5

50  $\Omega$ (m)/75  $\Omega$ (f) minimum loss pad, 2-22

## 7

75  $\Omega$  N to 50  $\Omega$  BNC adapter , 2-22

## A

**A** , 4-7

**ADDRESS** , 6-16

admittance , 4-9

**ADMITTANCE CHART** , 4-7

analyzer mode

network , 4-3

spectrum , 2-3

**ANALYZER TYPE** , 2-3, 4-3

**A/R** , 4-7

ASCII save , 6-19

**AUTOREC** , 6-17

**AUTO SCALE** , 4-12

averaging , 2-25, 4-28

**AVERAGING FACTOR** , 2-25, 4-28

## B

**B** , 4-7

**Back Space** , 1-2, 1-3

**BACK SPACE** , 1-3

**↕** **↕** , 1-2

**B/R** , 4-7

built-in disk drive , 6-17

**Bw/Avg** , 2-17

## C

calibration

1-path 2-port , 4-21

75  $\Omega$  configuration , 2-22

external reference , 2-21

full 2-port , 4-19

kit , 4-23

response , 4-16

response & isolation , 4-16

S-11 1-port , 4-17

S-22 1-port , 4-18

turning off reference level calibration ,  
2-21

calibration , 4-15

calibration data , 6-17

calibration for spectrum measurement , 2-20

calibration method , 4-15

**CAL KIT** , 4-23

**CAL OUT** output , 2-20

capturing unstable signal , 2-26

carrier to noise ratio , 3-4

**Center** , 2-7

center frequency

marker→ , 2-7

peak→ , 2-8

center frequency , 2-7

center step

setting , 2-9

**CENTER STEP SIZE** , 2-9

**Ch 1** , 2-3, 4-3

**Ch 2** , 2-3, 4-3

channel

active , 2-3, 4-3

dual , 2-3

split , 2-3

character entry , 1-2

**CLEAR SUB MKR** , 2-27, 4-28

connect

unknown signal , 2-2

**CONTINUOUS** , 2-5, 2-25, 4-6

**CROSS CHAN** , 2-13, 3-14

**CW FREQ** , 4-6

## D

**DATA and MEMORY** , 6-10

data array , 6-17

data hold

maximum , 2-25

minimum , 2-25

**DATA HOLD** , 2-25

**DATA MATH** , 6-13

**DATA ONLY** , 6-17

**DATA→MEMORY** , 6-10

data trace array , 6-17

dBm/Hz , 3-2  
**DELAY** , 4-7  
detection mode  
  sample , 3-2  
deviation , 5-6  
disk  
  initialize , 6-20  
display  
  overlap channel , 2-3  
  split channel , 2-3  
**D&M SCALE[UNCOUPLE]** , 4-12  
DOS , 6-17  
**DUAL CHAN** , 2-3  
DUT  
  connecting , 4-2

**E**  
**ELEC DELAY MENU** , 5-6  
**ELECTRICAL DELAY** , 5-4, 5-6  
electrical length , 5-4  
entry  
  character , 1-2  
  numerical data , 1-2  
**Entry Off** , 1-2  
equivalent noise bandwidth , 3-2  
**ERASE TITLE** , 1-3  
**EXECUTE LVL CAL** , 2-20, 2-22  
**EXPANDED PHASE** , 4-7  
extended cable , 5-8  
extension , 6-18  
**EXTERNAL** , 2-4, 4-4  
EXT TRIGGER connector , 2-4, 4-4

**F**  
file  
  copy , 6-19  
  purge , 6-18  
file format  
  DOS , 6-20  
  LIF , 6-20  
filter , 5-2  
format  
  group delay , 5-7  
  network analyzer , 4-7  
  noise , 3-2  
  smith chart , 4-8  
**Format** , 2-6, 4-7  
**FREE RUN** , 4-4  
frequency  
  center , 2-7  
  full span , 2-11  
  span , 2-11

  zero span , 3-11  
frequency resolution , 2-23

## G

**GAIN** , 3-2  
gate trigger  
  averaging , 3-9  
  edge mode , 3-8  
  gate delay , 3-5  
  gate length , 3-5  
  level mode , 3-8  
  RBW , 3-8  
  VBW , 3-9  
gate trigger , 3-5  
go/no-go testing , 6-2  
group delay , 5-7  
group delay aperture , 5-7

## H

hardkey , 1-1  
harmonics  
  displaying , 2-9  
HP 11852B option C04 , 2-22  
HP-GL , 6-18  
HP-IB address , 6-14, 6-16

## I

IF bandwidth , 4-14  
IF BW , 4-14  
**IMAGINARY** , 4-7  
impedance , 4-9  
initialize disk , 6-20  
initialize RAM disk , 6-20  
input impedance , 2-22  
input port , 4-7  
**INPUT Z** , 2-22  
instrument state , 6-17

## K

keyboard , 1-3  
key operation , 1-1

## L

LIF , 6-17  
limit line  
  table , 6-3  
  to edit , 6-3  
limit line test  
  activating , 6-5  
  beep , 6-5  
  display line , 6-3  
  modify table , 6-4  
  offset line , 6-6  
limit line test , 6-2

linear phase , 5-6  
LIN FREQ , 4-6  
LIN MAG , 4-7  
listen always , 6-14  
list sweep , 6-7  
LIST VALUES , 6-14  
LOG FREQ , 4-6  
LOG MAG , 4-7  
LVL CAL DATA , 2-21

## M

manual changes , A-1  
marker  
  displaying difference , 2-28, 4-29  
  fixed  $\Delta$ marker , 3-4  
  marker list , 2-27, 2-30, 4-28  
  noise marker , 3-4  
  reading value , 2-23, 4-27  
  to center , 2-7  
  tracking  $\Delta$ marker , 3-13  
  transition time , 3-11  
   $\Delta$ marker , 2-28, 4-29  
  Marker , 2-23, 4-27  
max hold , 2-25  
measurement  
  3 dB bandwidth , 5-2  
  cable electrical length , 5-9  
  carrier to noise ratio (C/N) , 3-4  
  noise level , 3-2  
  peak to peak of ripple , 4-31  
  ripple parameters , 4-31  
  time domain , 3-11  
  time gated , 3-5  
  zero span , 3-11  
MEMORY , 6-10  
memory array , 6-17  
memory trace , 6-13  
memory trace array , 6-17  
microfiche , x  
MKR LIST , 2-27, 2-30, 4-28  
MKR→CENTER , 2-7  
MKR→CNTR STEP , 2-9  
MKR→DELAY , 5-6  
MKR→LEFT RNG , 2-31  
MKR→REFERENCE , 2-15  
MKR→RIGHT RNG , 2-31  
MKR $\Delta$ →SPAN , 2-14  
MKR TIME , 3-11  
MKR $\Delta$ →SEARCH RNG , 2-31

MKR ZOOM , 2-13  
multiply trace , 6-13

## N

N-BNC adapter , 2-2, 2-20  
NEXT PEAK , 2-29  
NOISE , 3-2  
NOISE FORM , 3-4  
noise marker , 3-4  
NUMBER of GROUPS , 2-5, 4-6  
numerical keys , 1-2

## O

OFFSET , 3-2  
opened cable reflection , 5-9  
OPERATING PARAMETERS , 6-14  
option 1D6 , 3-5  
oscilloscope , 3-5

## P

PART SRCH , 2-31, 4-31  
peak  
  defining peak specification , 4-32  
  setting to center , 2-8  
  to search multiple peaks , 2-30  
  to search single peak , 2-29  
PEAK ALL , 2-30  
PEAK DEF MENU , 2-33, 2-34, 4-32, 4-33  
PEAK→CENTER , 2-8  
PEAKS LEFT , 2-30  
PEAKS RIGHT , 2-30  
peak threshold , 2-33  
PHASE , 4-7  
plot  
  display image , 6-15  
  transparent sheet , 6-15  
POLAR CHART , 4-7  
port extension , 5-8  
PORT EXTENSION , 5-8  
power , 2-6  
POWER SWEEP , 4-6  
Preset , 2-2, 4-3  
print  
  analyzer setting , 6-14  
  display image , 6-14  
  list values , 6-14  
PRINT , 6-14  
purge file , 6-18

## R

R , 4-7  
RAM disk  
    initialize , 6-20  
raw data , 6-17  
RBW  
    to set , 3-8  
REAL , 4-7  
recall  
    analyzer setting , 6-18  
    automatically , 6-17  
reference level  
    marker→ , 2-15  
    setting , 2-15  
reference level calibration , 2-20  
REFERENCE POSITION , 4-12  
REFERENCE VALUE , 2-15, 4-12  
Ref1:FWD S11 [A/R] , 4-7  
Ref1:REV S22 [A/R] , 4-7  
relative permittivity ( $\epsilon_R$ ) , 5-5  
repetitive sampling mode , 3-11  
RES BW , 2-17  
resolution , 2-23  
resolution bandwidth (RBW) , 2-17  
RESPONSE , 4-16  
RESPONSE & ISOL'N , 4-16  
rotary knob , 1-2

## S

sample detection , 3-2  
sampling mode , 3-11  
save  
    analyzer setting , 6-17  
    data array type , 6-17  
    display image , 6-18  
    extension , 6-18  
    measurement data , 6-17  
SCALE/DIV , 2-16  
scale/division  
    setting , 2-16  
scale/division , 4-12  
search  
    multiple peaks , 2-30  
    peak definition , 4-32  
    range , 4-31  
    search range , 2-31  
    target value , 4-30  
    to define peak shape , 2-34  
    to define peak threshold , 2-33  
SEARCH TRK , 2-9, 3-13  
SEGMENT , 6-4

serial number , A-2  
set up time (SUT) , 3-5, 3-8  
shorted cable reflection , 5-9  
signal delay (SD) , 3-5  
signal track  
    cross channel , 3-14  
    signal track , 2-12, 2-26  
SIGNAL TRK , 2-12, 2-26, 3-14  
signal width ( $\tau$ ) , 3-5  
SINGLE , 2-5, 2-25, 4-6  
S input , 2-2  
SMITH CHART , 4-7  
SMTH/POLAR MENU , 4-9  
softkey , 1-1  
span  
    full , 2-11  
    narrowing , 2-12  
    setting , 2-11  
    Δmarker→ , 2-14  
    zooming , 2-13  
Span , 2-11  
S-parameter test set , 4-2, 4-7  
spectrum monitoring , 5-3  
SPLIT DISP , 2-3  
spreadsheet , 6-19  
standard class  
    assignment , 4-25  
    label , 4-24  
    specifying , 4-25  
standard definition  
    table , 4-23  
Start , 4-11  
STATE , 6-17  
STATISTICS , 4-31  
Stop , 4-11  
sub-marker  
    using , 2-27, 4-28  
SUB MKR , 2-27, 4-28  
sweep  
    linear , 4-6  
    log , 4-6  
    power , 4-6  
    to stop , 2-25, 4-28  
sweep condition , 4-6  
SWEEP: HOLD , 2-25, 4-28  
sweep time  
    minimize , 2-19  
SWEEP TIME , 3-15  
sweep type , 4-6  
swept harmonics , 3-13  
SWR , 4-7



## T

**TARGET** , 4-30  
text with tab delimiter , 6-19  
**THRESHOLD** , 2-33, 4-33  
time gated spectrum analysis , 3-5  
toggle keys , 1-1  
trace arithmetic , 6-13  
trace math  
  to add , 6-13  
  to divide , 6-13  
  to subtract , 6-13  
trace math , 6-13  
trace memory , 6-10  
trace offset  
  clear , 6-12  
  setting , 6-11  
**TRACKING ΔMKR** , 3-13  
**Trans:FWD S21 [B/R]** , 4-7  
transmission/reflection (T/R) test set , 4-2,  
  4-7  
**Trans:REV S12 [B/R]** , 4-7  
**TRIG EVENT [ON POINT]** , 4-5  
**Trigger** , 2-4, 4-4  
trigger event , 4-5  
trigger mode , 2-4, 4-4  
trigger signal  
  negative , 2-5, 4-5  
  positive , 2-5, 4-5  
trigger source  
  external , 2-4, 4-4  
  internal , 2-4  
**TRIG PLRTY** , 2-5, 4-5

## U

**ΔMKR** , 2-28, 4-29  
unit , 2-6

## V

**VELOCITY FACTOR** , 5-5  
**VIDEO** , 3-11  
video bandwidth (VBW) , 2-18  
**VIDEO BW** , 2-18  
video trigger , 3-11  
voltage , 2-6

## W

**WIDTH** , 5-2

## Y

Y  
  converting , 4-9  
**Y:Refl** , 4-9  
**Y:Trans** , 4-9

## Z

Z  
  converting , 4-9  
zooming  
  setting magnification , 2-13  
  Δmarker , 2-14  
zooming , 2-13  
**ZOOMING APERTURE** , 2-13  
**Z:Refl** , 4-9  
**Z:Trans** , 4-9



## REGIONAL SALES AND SUPPORT OFFICES

*For information relating to Sales or Support of Hewlett-Packard products first contact your local Hewlett-Packard office listed in the white pages of your telephone directory. If none is listed locally, contact one of the addresses listed below to obtain the address or phone number of the Hewlett-Packard Sales or Support office nearest you.*

### ASIA

Hewlett-Packard Asia Ltd.  
47/F, 26 Harbour Road,  
Wanchai, **HONG KONG**  
G.P.O. Box 863, Hong Kong  
Tel: (852)5-8330833  
Telex: 76793 HPA HX  
Cable HPSIAL TD

### AUSTRALASIA

Hewlett-packard Australia Ltd.  
31-41 Joseph Street  
**BLACKBURN**, Victoria 3130  
Australia  
Tel: (61)895-2895  
Telex: 31-024  
Cable: HEWPARD Melbourne

### CANADA

Hewlett-Packard (Canada) Ltd.  
6877 Goreway Drive  
**MISSISSAUGA**, Ontario L4V 1M8  
Tel: (416)678-9430  
Telex: 069-8644

### JAPAN

Yokogawa-Hewlett-Packard Ltd.  
29-21 Takaido-Higashi, 3 Chome  
Suginami-ku **TOKYO** 168  
Tel: 03(331)6111  
Telex: 232-2024 YHPTOK

### MEDITERRANEAN AND MIDDLE EAST

Hewlett-Packard S.A.  
Mediterranean and Middle East  
Operations  
Atrina Centre  
32 Kifissias Avenue  
Paradissos-Amarousion, **ATHENS**  
Greece  
Tel: (30)682 88 11  
Telex: 21-6588 HPAT GR  
Cable: HEWPACKSA Athens

May, 1990

P/N 04284-90009

### BENELUX & SCANDINAVIA

Hewlett-Packard S.A.  
Uilenstede 475  
P.O. Box 999  
NL-1183 AG **AMSTELVEEN**  
The Netherlands  
Tel: (31)20/43 77 71  
Telex: 18 919 hpner nl

### SOUTH & EAST EUROPE, AFRICA

Hewlett-Packard S.A.  
7 rue du Bois-du-Lan  
CH-1217 **MEYRIN** 2, Geneva  
Switzerland  
Tel: (41)22/83 12 12  
Telex: 27835 hmea  
Cable: HEWPACKSA Geneva

### FRANCE

Hewlett-Packard France  
Parc d'activites du Bois Briard  
2, avenue du Lac  
91040 **EVRY** Cedex  
Tel: 1 6/077 83 83  
Telex: 6923 15F

### GERMAN FEDERAL REPUBLIC

Hewlett-Packard GmbH  
Hewlett-Packard-Strasse  
Postfach 1641  
D-6380 **BAD HOMBURG**  
West Germany  
Tel: 06172/400-0  
Telex: 410 844 hpbhg

### ITALY

Hewlett-Packard Italiana S.p.A.  
Via G. Di Vittorio 9  
1-20063 **CERNUSCO SUL  
NAVIGLIO**  
(Milano)  
Tel: 02/92 36-91  
Telex: 334632

### UNITED KINGDOM

Hewlett-Packard Ltd.  
King Street Lane  
Winnersh, **WOKINGHAM**  
Berkshire RG11 5AR  
Tel: 734/78/ 47 74  
Telex: 847178

### EASTERN USA

Hewlett-Packard Co.  
4 Choke Cherry Road  
**ROCKVILLE**, MD 20850  
TEL: (301)670-4300

### MIDWESTERN USA

Hewlett-Packard Co.  
5201 Tollview Drive  
**ROLLING MEADOWS**, IL 6008  
Tel: (312)255-9800

### SOUTHERN USA

Hewlett-Packard Co.  
2000 South Park Place  
P.O. Box 105005  
**ATLANTA**, GA 30348  
Tel: (404)955-1500

### WESTERN USA

Hewlett-Packard Co.  
5161 Lankershim Blvd.  
P.O. Box 3919  
**NO. HOLLYWOOD**, CA 91609  
Tel: (818)506-3700

### OTHER INTERNATIONAL AREAS

Hewlett-Packard Co.  
Intercontinental Headquarters  
3495 Deer Creek Road  
**PALO ALTO**, CA 94304  
Tel: (415)857-1501  
Telex: 034-8300  
Cable: HEWPACK

