

**HP 4934A Transmission Impairment Measuring Set
Operating and Calibration Manual**

SERIAL NUMBERS

This manual applies directly to instruments
with serial numbers prefixed 3648U.

For additional important information about serial numbers,
see INSTRUMENTS COVERED BY MANUAL in Chapter 3.



**HP Part No. 04934-90054
Printed in U.K.
November 1998**

Copyright © Hewlett-Packard Ltd. 1998

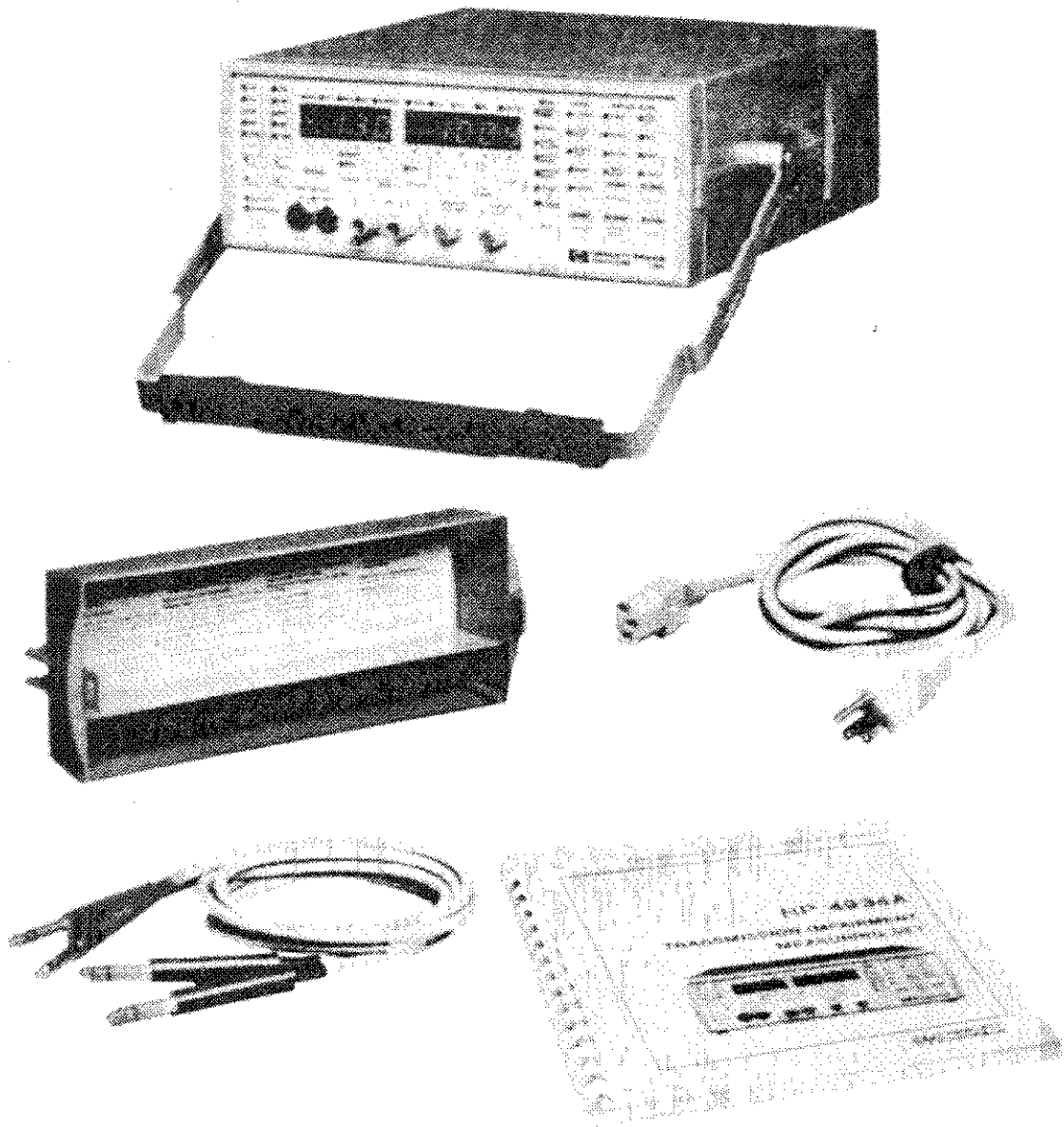

**HP 4934A Transmission Impairment Measuring Set
and Accessories Supplied**

-
-
-
-
-
-
-
-
-
-
-
-
-
-
-
-
-
-
-
-
-
-
-

Instrument Description

The HP 4934A is a wideband (20 Hz to 110 kHz), (20 Hz to 200 kHz option 021) Transmission Impairment Measuring Set (TIMS). The transmission impairment measurements which can be made are listed below.

- Level Frequency
- Noise
- Noise with Tone
- Signal to Noise
- Impulse Noise
- P/AR (Peak to Average Ratio)
- Noise to Ground

The HP 4934A can make measurements directly on leased lines or on dial-up lines. It has loop holding capability, a monitor speaker and butt-in connection (useful for talking to the far end of the test line).

There are four permanently stored frequencies: 404 Hz, 1004 Hz, 2804 Hz and 2713 Hz. Any other four frequencies may be temporarily assigned or stored by the user.

The HP 4934A can test circuits using single frequency (SF) signaling - use the SF SKIP feature. SF SKIP prevents the HP 4934A from transmitting signaling frequencies in the range 2600 Hz \pm 150 Hz.

Vertical line on the left side of the page.

Horizontal line segment on the left side of the page.

Horizontal line segment near the bottom of the page.

Contents

1 Getting Started

- Introduction 1-1
- Switch-On 1-1
- Front Panel Features 1-2
- Demonstrating the HP 4934A 1-5
 - Demonstration 1 1-5
 - Demonstration 2 1-6
- Error Codes 1-7

2 Making Measurements

- Preliminary Setup 2-1
 - Connecting the HP 4934A to the Test Circuit 2-1
- Dial and Hold 2-2
 - Dialing using the HP 4934A and a Butt-in 2-3
 - Receiving an Incoming Call and Holding the Line 2-4
- Level and Frequency 2-5
 - Principles 2-5
 - Instrument Operation 2-7
- Message Circuit Noise 2-10
 - Principles 2-10
 - How it is Measured 2-11
 - Instrument Operation 2-12
- Noise with Tone (Notched Noise) 2-13
 - Principles 2-13
 - How it is Measured 2-13
 - Instrument Operation 2-14
- Signal to Noise 2-15
 - Principles 2-15
 - How it is Measured 2-15

Contents

Instrument Operation	2-16
Impulse Noise	2-17
Principles	2-17
Instrument Operation	2-18
P/AR (Peak to Average Ratio)	2-21
Principles	2-21
How it is Measured	2-22
Instrument Operation	2-22
Noise to Ground	2-23
Principles	2-23
How it is Measured	2-23
Instrument Operation	2-24

3 General Information

Introduction	3-1
About this Version	3-1
Specification	3-2
Safety Information	3-2
General	3-2
Safety Symbols	3-3
Statement of Compliance	3-5
Electromagnetic Compatibility (EMC) Information	3-5
Instruments Covered by Manual	3-7
Options Available	3-8
Accessories Supplied	3-9
Accessories Available	3-9
Specifications	3-10

Contents

4 Installation

- Introduction 4-1
- Initial Inspection 4-1
- Preparation for Use 4-2
 - Power Requirements 4-2
 - Line Fuse 4-2
 - Power Cable 4-3
- Battery (Option 001 or Retrofit) 4-3
 - Battery 4-3
- Mating Connectors (Front Panel) 4-4
- Operating Environment 4-4
- Cleaning 4-4
- Noise Declaration 4-5
- Storage and Shipment 4-5
 - Environment 4-5
 - Packaging 4-5

5 Performance Tests

- Introduction 5-1
- Calibration Cycle 5-1
- Recommended Test Equipment 5-2
- Operational Verification 5-3
- Receiver Frequency 5-4
- Receiver Level 5-5
- Weighting Filters 5-6
- Impulse Noise Count 5-9
- Loss of Holding Tone 5-10
- Hold Circuit 5-11
- Dynamic Hold Circuit 5-13
- Performance Tests 5-18

Contents

Transmitter Frequency Accuracy	5-19
Transmitter Level Range	5-20
Transmitter Level Accuracy	5-21
Transmitter Flatness at +10 dBm	5-22
Transmitter Flatness at -40 dBm	5-24
Receiver Frequency Range/Accuracy	5-30
Receiver Level Accuracy	5-32
Message Circuit Noise Accuracy	5-34
Notch Filter Rejection	5-36
Signal to Noise Ratio Accuracy	5-37
Impulse Noise Threshold Accuracy	5-39
Noise to Ground Accuracy	5-41
Peak to Average Ratio (P/AR) Accuracy	5-43

6 Software Downloading

Introduction	6-1
Quick Download Procedure	6-2
About the DOWNLOAD Program	6-3

7 Remote Control

Introduction	7-1
The Serial Port	7-2
Serial Port Type	7-2
Baud Rates	7-2
Cable Pinout	7-3
Null Modem	7-3
Setting up for Remote Control	7-4
Connecting the TMS to a Controller	7-4

Contents

Setting the Baud Rate 7-4
Activating Remote Mode 7-4
Deactivating Remote Mode 7-4
Control Commands 7-5
Query Commands 7-8
Results Display (DISP?) Format 7-8
Range Error Messages 7-9

**A Service Accessory 1 (SA1)
20 dB Amplifier/4 kHz Filter**

Performance Test A-1

**B Service Accessory 2 (SA2)
Power Splitter/Adder**

Performance Test B-1

Contents

Getting Started

Introduction

This chapter aims to get you ready to make measurements. It takes you through switch-on, introduces operating features and provides simple procedures to demonstrate how easy the HP 4934A is to use.

Switch-On

CAUTION

Before switching on this instrument, make sure that the line voltage selector switch is set to the voltage of the power supply and the correct fuse installed. Assure the power supply voltage is in the specified range.

Switch on the HP 4934A by pressing the **ON/STBY** key.

The instrument automatically does a self-test check at power on (takes approximately 10 seconds). During this time all front panel indicators and displays will light (except for the **CHARGING** and **BATTERY** indicators).

When the self-test is complete the instrument starts measuring **LEVEL** **FREQ**. Both display windows momentarily blank, then a minus sign “-” and period “.” appear in the left window, followed by the transmitter level (in dBm). The right window displays 1004 Hz.

If any of the self tests fail at power-on, an error code (see Page 1-7) is displayed briefly in the right window during self-test.

Front Panel Features

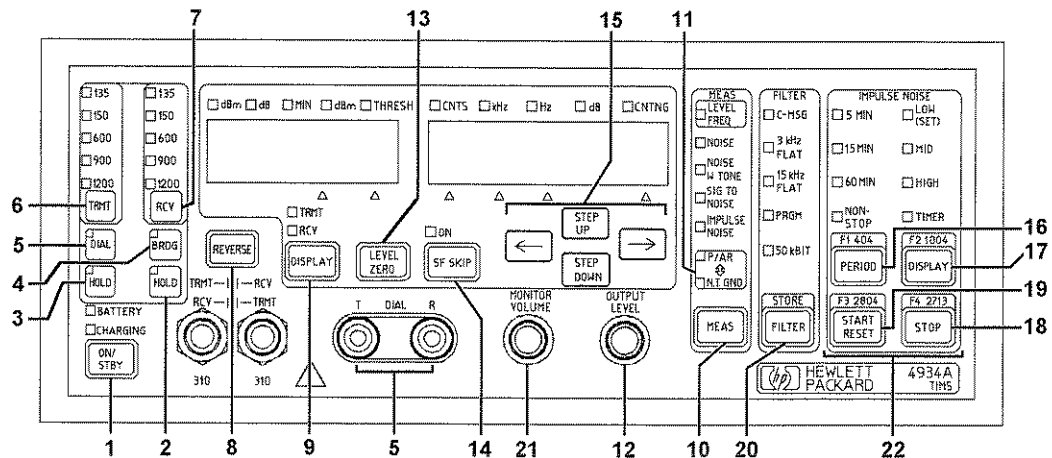

- 1 **ON/STBY** powers up the complete instrument. In the STBY (standby) mode, only some circuits have power. When a battery is fitted the **ON/STBY** key has the following indicators associated with it:
BATTERY - indicates the instrument is powered from the internal battery. During battery operation, connect the chassis terminal on the side panel to earth ground.
CHARGING - indicates the instrument is in the STBY (standby) mode with AC power connected and the battery is charging.
- 2 **HOLD (RCV)** connects the receive hold circuit to the RCV port when testing dial-up lines.
- 3 **HOLD (TRMT)** connects the transmit hold circuit to the TRMT port when testing dial-up lines.
- 4 **BRDG** selects a high input impedance (>50 k Ω) for testing lines that are already terminated. In BRDG (bridged) mode, it is still necessary to use the **RCV** key to select the terminating impedance for the line you are testing. This ensures that the HP 4934A will display the correct results.
- 5 **DIAL** connects the T (tip) and R (ring) binding posts to the TRMT port (transmitter disconnected). To test a dial-up line or talk over the test line, connect a butt-in to the T and R DIAL binding posts.

- 6 **TRMT** selects the transmitter source impedance.
- 7 **RCV** selects the receiver terminating impedance or, in bridged mode, selects the impedance of the circuit under test.
- 8 **REVERSE** interchanges the TRMT and RCV function of the two 310 ports. The indicators above the ports show the current function.
- 9 **DISPLAY** selects either the received or transmitted parameters for display. The TRMT and RCV indicators above the **DISPLAY** key show which parameters are being displayed.
- 10 **MEAS** selects the following measurements:
 - LEVEL FREQ (level frequency measurements)
 - NOISE (noise measurements)
 - NOISE W TONE (noise with tone measurements)
 - SIG TO NOISE (signal-to-noise measurements)
 - IMPULSE NOISE (impulse noise measurements)
 - P/AR (peak to average ratio measurements)
 - N.T. GND (noise to ground measurements)
- 11 **OUTPUT LEVEL** sets the transmitter output level.
- 12 **LEVEL ZERO** allows relative level measurements in the LEVEL FREQ mode. The displayed received signal becomes the 0 dB reference when you press **LEVEL ZERO**. All subsequent results are relative to this reference. The displayed results are a measure of loss, that is a higher level than the reference is indicated by a “-” sign. This is standard in the telephone industry.
- 13 **SF SKIP** prevents the instrument from transmitting signaling frequencies in the range 2600 Hz \pm 150 Hz. If SF SKIP is enabled the instrument automatically prevents the selection of frequencies in this range. You can also change the SF SKIP center frequency, see Page 2-9.
- 14 **STEP UP, STEP DOWN**, \rightarrow and \leftarrow change the transmit frequency value in the LEVEL FREQ mode or the low threshold in the IMPULSE NOISE mode. Use \rightarrow and \leftarrow to select the digit to change. The selected digit is highlighted by a lit pointer. Change the value of the selected digit using the **STEP UP** and **STEP DOWN** keys.
- 15 **PERIOD** selects one of the four Impulse Noise measurement periods.
- 16 **DISPLAY** displays the Impulse Noise measurement time or threshold/count values. Only the LOW (SET) threshold value can be changed, see Page 2-20.
- 17 **STOP** allows the Impulse Noise measurement to be stopped without affecting the Impulse Noise counter.

18 START RESET sets the Impulse Noise counter to zero and starts the Impulse Noise measurement.

19 FILTER selects one of the filters in the noise measurement modes.

- C-MSG
- 3 kHz FLAT
- 15 kHz FLAT
- PRGM
- 50 kBIT

20 MONITOR VOLUME controls the volume of the monitor speaker.

21 In the LEVEL FREQ mode, the blue keys F1 to F4 select preset frequencies. At switch-on these frequencies are:

- F1: 404 Hz
- F2: 1004 Hz
- F3: 2804 Hz
- F4: 2713 Hz

New frequencies can be assigned to F1 to F4, see Page 2-9.

Demonstrating the HP 4934A

The following demonstrations show how easy the HP 4934A is to use. A detailed explanation of the HP 4934A measurement capability is given in Chapter 2. The HP 4934A TRMT and RCV ports are connected by a looping cable in these demonstrations.

Demonstration 1

A single tone measurement with the transmitter set to -10 dBm and the frequency set to 1804 Hz.

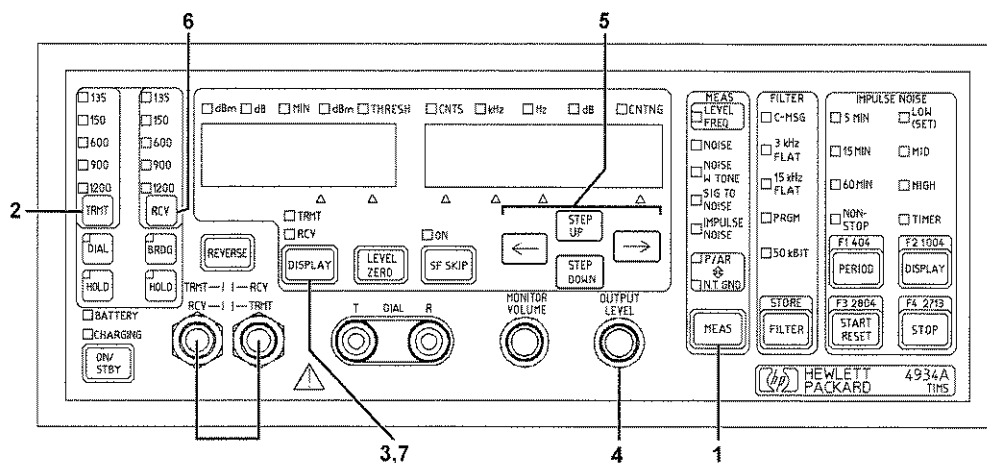

- 1 Use **MEAS** to select LEVEL FREQ.
TRANSMITTER
- 2 Use the **TRMT** key to set the transmitter impedance to 600 Ω
- 3 Display the transmitted level and frequency using the **DISPLAY** key (TRMT indicator lit).
- 4 Use the **OUTPUT LEVEL** control to adjust the transmitted level to -10 dBm.
- 5 Change the transmitted frequency to 1804 Hz using the \rightarrow , \leftarrow , **STEP UP** and **STEP DOWN** keys.

RECEIVER

- Use the **RCV** key to set the receiver impedance to 600Ω
- Display the received level and frequency using the **DISPLAY** key (RCV indicator lit).

Demonstration 2

A noise-with-tone measurement with the holding tone set to -13 dBm and the C-Message filter selected.

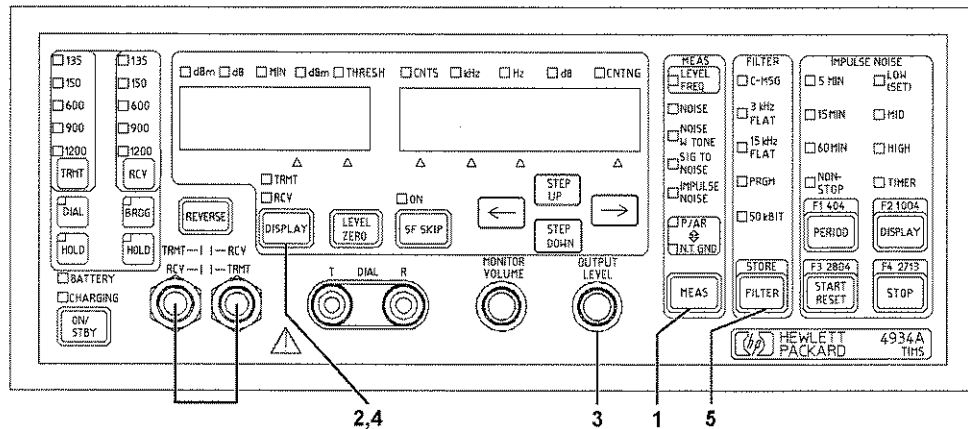

- Use the **MEAS** key to select NOISE W. TONE.

TRANSMITTER

- Display the transmitted level and frequency using the **DISPLAY** key (TRMT indicator lit). Level in dBm is in the left window. The frequency (fixed at 1004 Hz) is in the right window.

- Set the level to -13 dBm using the **OUTPUT LEVEL** control.

RECEIVER

- Display the received noise level using the **DISPLAY** key (RCV indicator lit).
- Select the C-MSG filter using the **FILTER** key.
- Read the weighted noise in dBmC in the left window. The received frequency is in the right window.



Error Codes

The error codes are described in the following table:

Code	Description
Err 1 to Err 6	Instrument faulty, see Service Manual.
Err 7	Received holding tone level too high or too low- check transmitted level or circuit under test.
Err 8	Impulse Noise threshold set too high - adjust.
"-" sign in right window	Loss of holding tone during pulse Noise measurement - only a warning, the instrument continues counting.

Making Measurements

Preliminary Setup

Connecting the HP 4934A to the Test Circuit

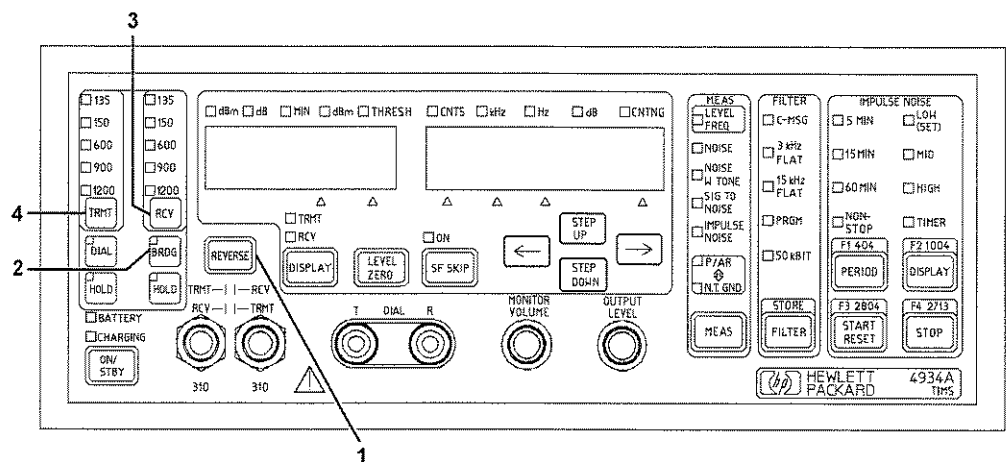

CAUTION

Ensure no more than 200 V dc or 10 V rms at 60 Hz is connected between tip and ring of the TRMT or RCY jacks.

- 1 The two 310-type jacks of the HP 4934A can function as a Transmitter output or Receiver input. Pressing the **REVERSE** key causes the function of the two 310-type jacks to be reversed. The current function of the ports is indicated by the indicators below the **REVERSE** key.
- 2 If the line to be tested is already terminated, press **BRDGG**.
- 3 Select the receiver input impedance using the **RCY** key - 135, 150, 600, 900 or 1200Ω. When operating in BRDGG (bridged) mode, still ensure the correct impedance is selected.

- 4 Select the transmitter output impedance using the **TRMT** key - 135, 150, 600, 900 or 1200Ω

Dial and Hold

The HP 4934A can be used with a butt-in to dial up lines or for talking along a line. The HP 4934A can hold lines which require a DC current to maintain the connection once the butt-in is disconnected.

The diagram below shows how the hold, dial and reverse functions work.

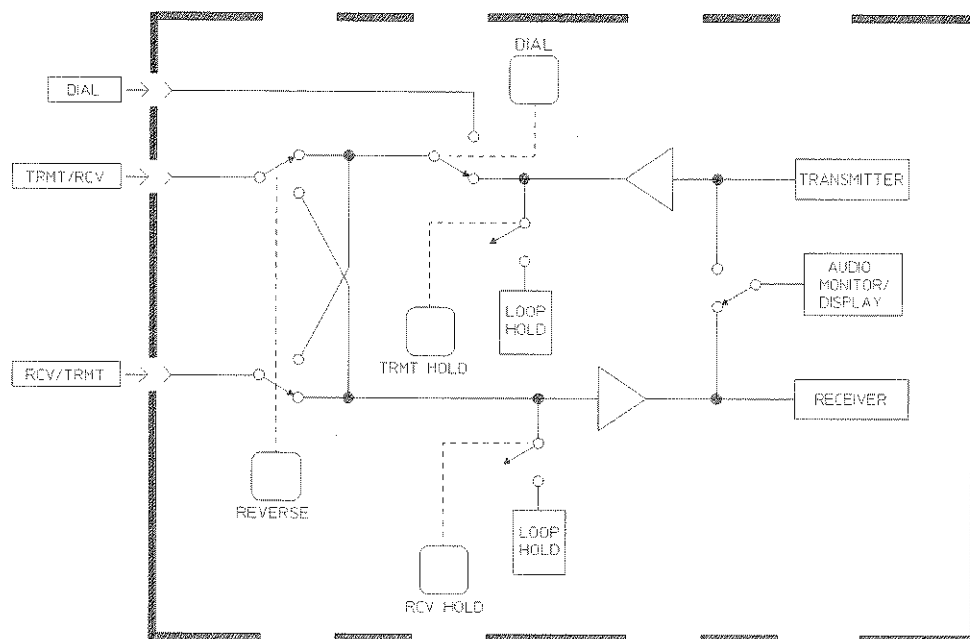

Dialing using the HP 4934A and a Butt-in

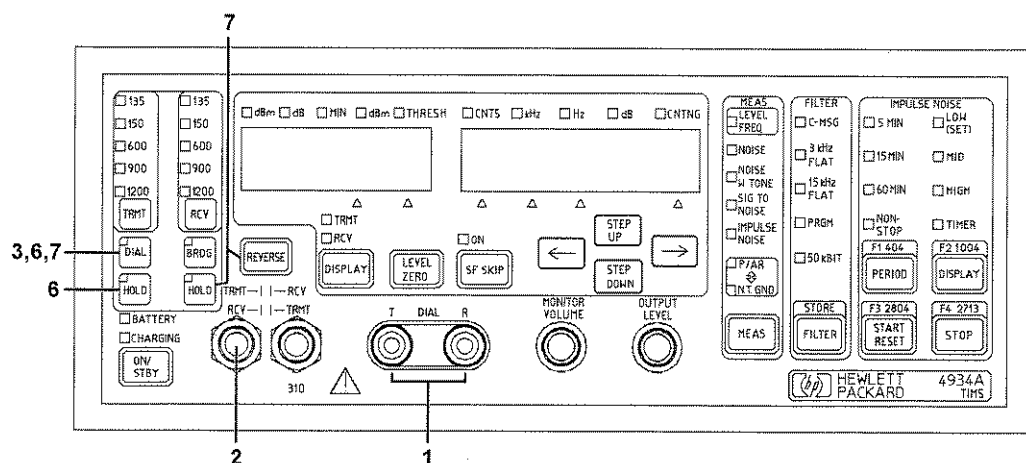

- 1 Connect the butt-in to the T and R DIAL binding posts.
- 2 Connect the test circuit to the TRMT port.
- 3 Select DIAL to connect the butt-in through to the TRMT port. The DIAL indicator will light.
- 4 Dial up the line you want using the butt-in.
- 5 When the far end goes off-hook you can use the butt-in for voice communication.
- 6 To continue to hold the line and connect the HP 4934A transmitter to it, select TRMT HOLD then DIAL. You can now transmit test signals along the line. To re-establish the speech path, press **DIAL**. To drop the line, press TRMT **HOLD**.
- 7 Alternatively, to continue to hold the line and connect the HP 4934A receiver to it, select RCY HOLD then REVERSE. You can now receive test signals from the line. To re-establish the speech path, press **REVERSE** and **DIAL**. To drop the line, press RCY **HOLD**.

Receiving an Incoming Call and Holding the Line

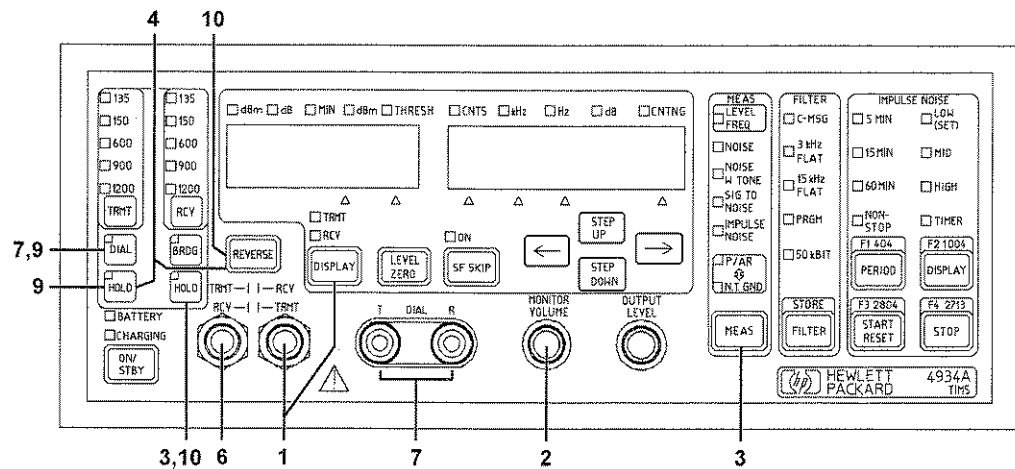

Without a Butt-In

- 1 Connect the RCV port to the test line. Use the **DISPLAY** key to light the RCV indicator.
- 2 Adjust the volume of the audio monitor (so that you can hear any received signal) using the **MONITOR VOLUME** control.
- 3 When a call comes in, you will hear a *buzzing* on the audio monitor. To seize the line, press **RCV HOLD**. The caller can now speak to you or transmit test signals. To make measurements, use **MEAS** to select the appropriate measurement.
- 4 To transmit test signals while continuing to hold the line, press **TRMT HOLD** then **REVERSE**.
- 5 To drop the line, press the appropriate **HOLD** key.

With a Butt-In (if you want to talk)

- 6 Connect the **TRMT** port to the test line.
- 7 Connect the butt-in to the **T** and **R DIAL** binding posts and press **DIAL** to connect the butt-in through to the **TRMT** port. The **DIAL** indicator will light.
- 8 When you receive a call, the butt-in will ring. Go off-hook to receive the call.
- 9 To connect the HP 4934A transmitter to the line, select **TRMT HOLD** then **DIAL**. You can now transmit test signals along the line. To re-establish the speech path, press **DIAL**. To drop the line, press **TRMT HOLD**.

- 10 Alternatively, to connect the HP 4934A receiver to the line, press **RCV HOLD** then **REVERSE**. You can now receive test signals from the line. To re-establish the speech path, press **REVERSE**. To drop the line, press **RCV HOLD**.

Level and Frequency

Principles

LEVEL/FREQUENCY encompasses 4 related measurements: loss, attenuation distortion, gain slope and frequency. All use the same measurement configuration.

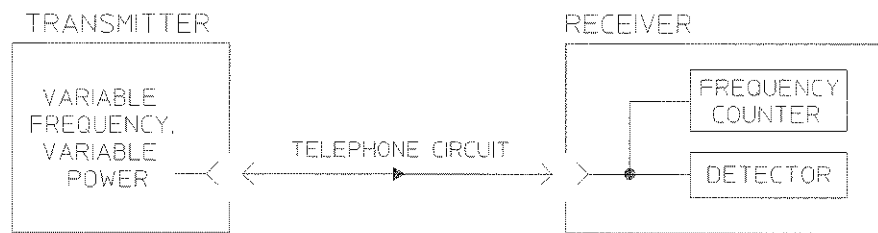

1004 Hz Loss

This measurement is used to determine the point-to-point loss (or gain) of a channel at 1004 Hz. 1004 Hz is transmitted instead of 1000 Hz to avoid measurement errors caused by signals which are submultiples of the 8 kHz PCM sample rate.

- 1 The transmitter sends 1004 Hz at the nominal data level (usually -13 dBm0).
- 2 The receiver measures the level and frequency of the received signal. The loss is the difference between the transmitted and received levels.

NOTE

If the channel is already terminated, the receiver can measure the level via a high impedance input (bridging mode).

Attenuation Distortion

Attenuation distortion defines the flatness and usable bandwidth of the circuit.

- 1 The transmitter usually sends 1004 Hz at the nominal data level. The level received at this frequency is set as the reference level.
- 2 The transmitter is stepped through a range of spot frequencies over the channel bandwidth. At each frequency, the receiver displays the difference between the level at the reference frequency and the level received.

Gain Slope

This is a quick method for assessing the flatness of a channel using only three frequencies, two of which are close to the edges of the channel bandwidth. The level measured at 1004 Hz is the reference level; then the attenuation is measured at 404 Hz and 2804 Hz relative to the reference level.

Frequency

Frequency shift can occur over facilities such as FDM carrier systems and is measured by comparing the frequency sent into the channel with the frequency received at the far end of the channel.

NOTE

The calculation of frequency shift may not be valid when measured on looped-around carrier facilities since the frequency shift in one direction may be canceled by frequency shift in the return direction.

Instrument Operation

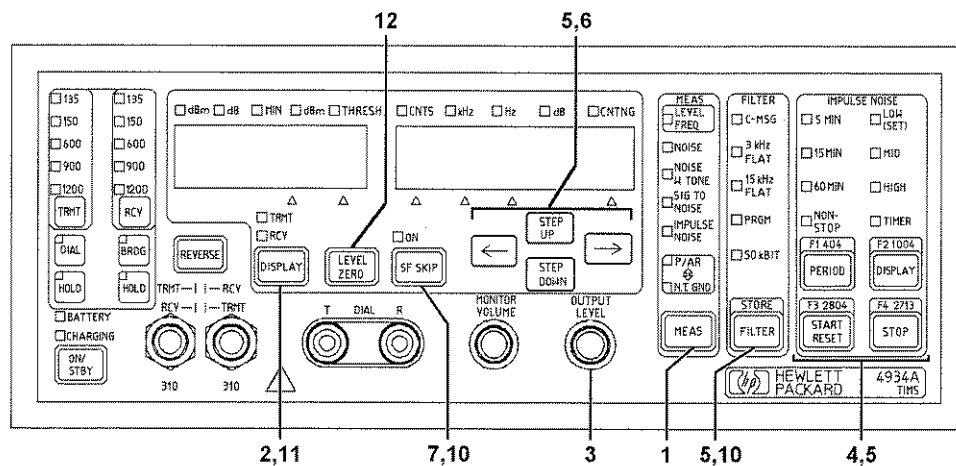

- 1 Use **MEAS** to select LEVEL FREQ.

TRANSMITTER

- 2 Display the transmitted level and frequency using the **DISPLAY** key (the TRMT indicator will be lit). A frequency of 1004 Hz is initially transmitted each time LEVEL FREQ is selected.
- 3 Change the transmitted level if desired, using the **OUTPUT LEVEL** control (the level in dBm is in the left window).

NOTE

In some systems it is not desirable to transmit levels above -13 dBm0 as interference with other channels may occur.

Decide whether you want to use a preset frequency or some other frequency.

Preset Frequency

In the LEVEL FREQ mode, the blue keys give single keystroke access to four preset frequencies. The normal preset frequencies are 404 Hz, 1004 Hz, 2804 Hz and 2713 Hz.

- 4 To select a preset frequency, press the appropriate blue key.

Key	Normal Frequency
F1	404 Hz
F2	1004 Hz
F3	2804Hz
F4	2713 Hz

- 5** To store a different preset frequency:
 Set the new frequency in the right window, using the →, ←, **STEP UP** and **STEP DOWN** keys.
 Enter the new frequency into one of the stores by pressing the blue **STORE** key followed by the appropriate blue F1 to F4 key.

NOTE

The normal frequency values are re-established when the power is cycled or when the measurement mode is switched between P/AR and N.T. GND.

Some Other Frequency

- 6** Change the value of the transmitted frequency in the right window using the →, ←, **STEP UP** and **STEP DOWN** keys.

Single Frequency (SF) Signaling

- 7** Press **SF SKIP** to prevent the instrument from transmitting signaling frequencies in the range 2600 Hz ±150 Hz.

Changing the SF Skip Center Frequency

- 8** Disconnect the transmit side of the line from the test set first to avoid dropping the circuit.
9 Set the new frequency in the right window.
10 Press **STORE**, followed by **SF SKIP**.

NOTE

The SF SKIP center frequency 2600 Hz is re-established at power on or when the measurement mode is switched between P/AR and N.T. GND.



RECEIVER

11 Display the received level and frequency using the **DISPLAY** key (RCV indicator will be lit).

Receiver Reference

12 If attenuation relative to a reference is required, press **LEVEL ZERO** when the reference signal is present and stable (for attenuation distortion measurements this is normally at 1004 Hz). This changes the level reading from an absolute value in dBm (in the left window) to a relative attenuation value in dB. All subsequent received level readings will be relative to this value. A negative reading “-” indicates a level higher than the reference level.

Pressing **LEVEL ZERO** a second time changes the level reading back to absolute units in dBm.

To change the transmitted frequency, return to step 2.

NOTE

Error Codes will be displayed if the input level to the receiver is too high or unstable (see the error codes in Chapter 1).

Message Circuit Noise

Principles

The measurement uses no test signal and quantifies background noise with a choice of band limiting filters (C-Message, 3 kHz Flat, 15 kHz Flat, Program and 50 kBit).

C-Message: This filter weights noise in the same way it would be heard by a telephone user. However, it is also used to evaluate the effects of noise on voice-grade data circuits because its response is relatively flat over the frequency range for data transmission.

3 kHz Flat: This filter attenuates much less at low frequencies (60 Hz to 500 Hz) than the C-Message filter. By performing a 3 kHz measurement after a C-Message measurement, the effect of low frequency noise (60 Hz commercial power, 20 Hz ringing, etc.) can be determined.

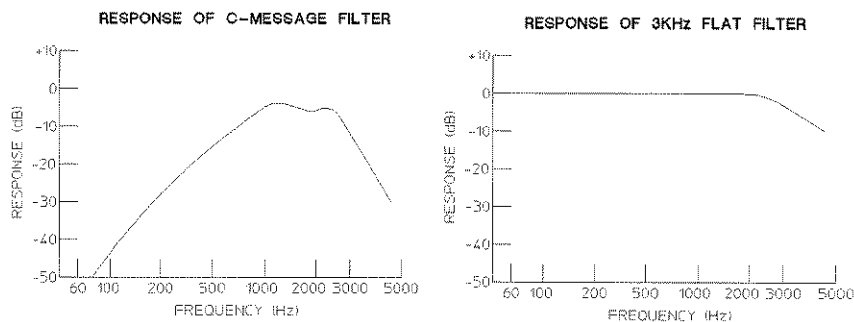

15 kHz Flat: This filter is used when measuring noise on program channels used in the broadcasting industry. Like the 3 kHz Flat filter, it passes low frequency noise.

Program: This filter is used when measuring noise on program channels used in the broadcasting industry to communicate between the studio and transmitter site.

50 kBit: This is a weighted filter used to measure noise on wideband data circuits.

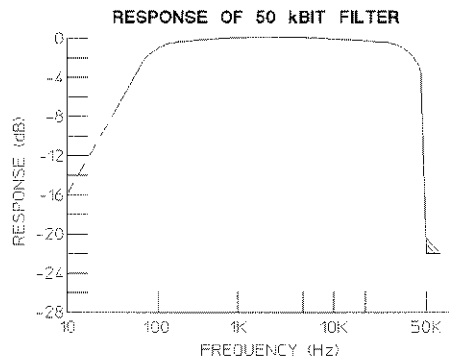
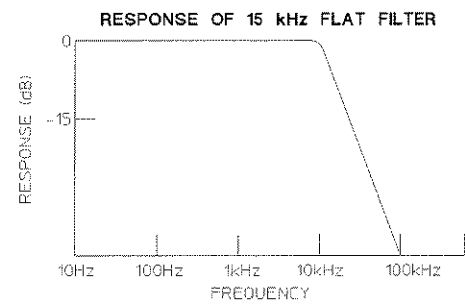
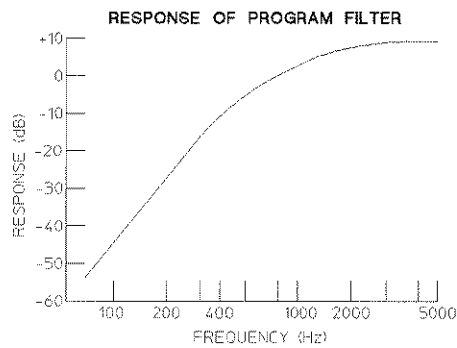

How it is Measured

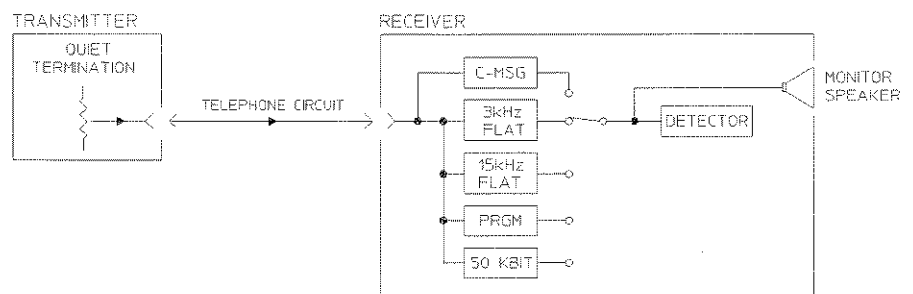

- 1 At one end of the line, the transmitter provides a quiet termination of the appropriate impedance.
- 2 At the other end, the receiver measures the noise via a weighting filter. Noise levels are displayed in dBm (0dBm = -90dBm). When the C-Message filter is selected, the noise is in units of dBmC.

Instrument Operation

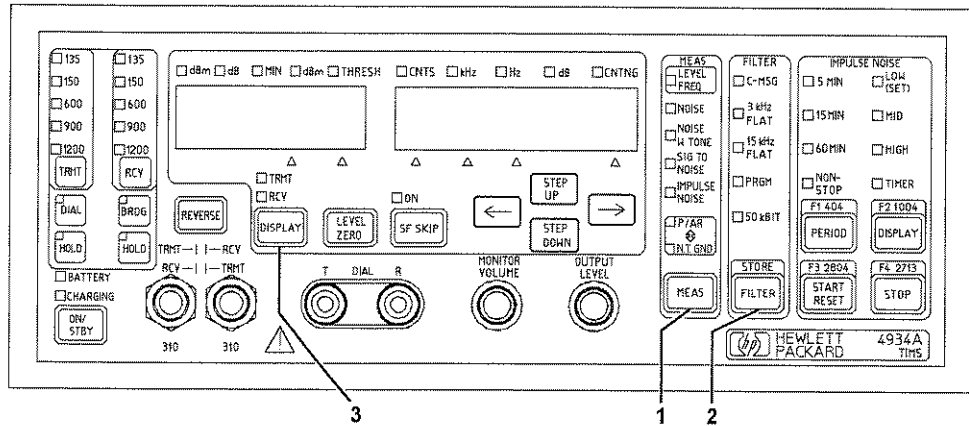

During this measurement the transmitter is quiet terminated (indicated by a decimal point "." in the left window when the display is in TRMT mode).

RECEIVER

- 1 Use **MEAS** to select NOISE.
- 2 Use **FILTER** to select the required filter.
- 3 Display the received noise level using the **DISPLAY** key (the RCV indicator will be lit). The noise level, in dBm, is in the left window. If the C-Message filter is selected the result is in units of dBmC.

Noise with Tone (Notched Noise)

Principles

This measurement quantifies total noise which includes background noise and noise generated only when a signal is present, such as when the circuit includes companders and/or quantizers.

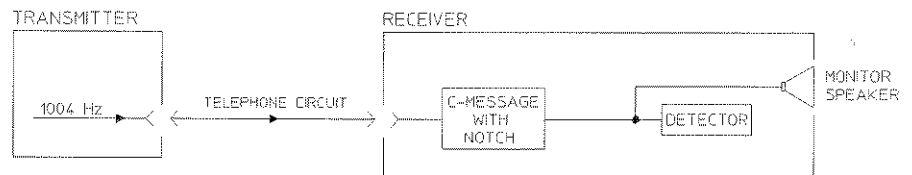

How it is Measured

- 1 The transmitter sends a 1004 Hz holding tone at the nominal data level.
- 2 The receiver notches out the 1004 Hz holding tone and what is left is measured via a weighting filter (C-Message, 3 kHz Flat, 15 kHz Flat, Program or 50 kBit). The measured noise level is displayed in dBm (0 dBm = -90 dBm). When the C-Message filter is used, the result is in units of dBmC. The notch attenuates all frequencies in the range 995 Hz to 1025 Hz by at least 50 dB.

FREQUENCY RESPONSE = C-MESSAGE FILTER WITH 1004Hz NOTCH

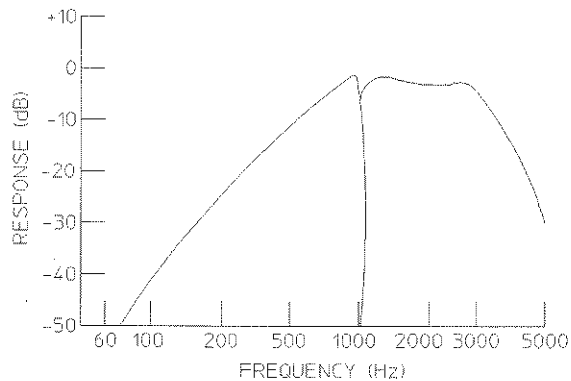

Instrument Operation

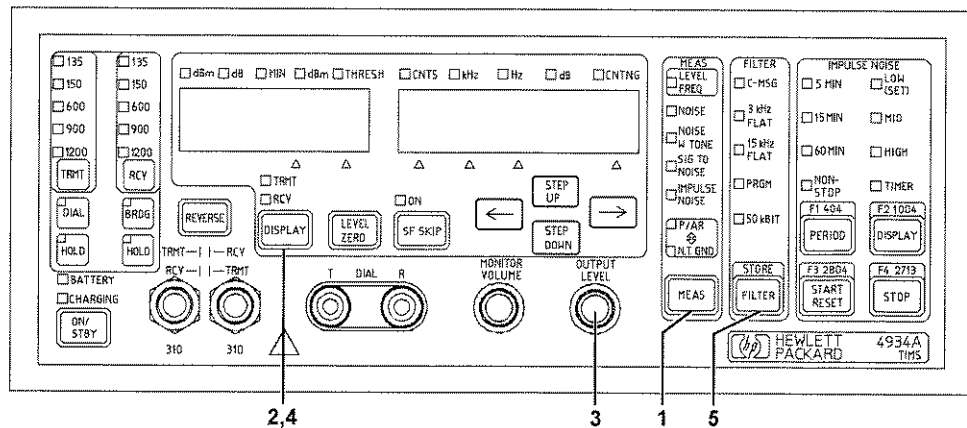

- 1 Use **MEAS** to select NOISE W TONE.

TRANSMITTER

- 2 Display the transmitted level and frequency using the **DISPLAY** key (the TRMT indicator will be lit). The level, in dBm, is in the left window. The frequency in the right window is fixed at 1004 Hz.
- 3 Set the transmitted level to the nominal data level using the OUTPUT LEVEL control.

RECEIVER

- 4 Display the received noise level using the **DISPLAY** key (the RCY indicator will be lit).
- 5 Select the required filter using the **FILTER** key.
- 6 Read the weighted noise in dBm, in the left window. If the C-Message filter is selected, the result is in dBmC. The received frequency is displayed in the right window.

Signal to Noise

Principles

The signal-to-noise measurement determines the ratio of received signal-plus-noise power to noise power and gives a measure of the margin between the data signal and the background noise.

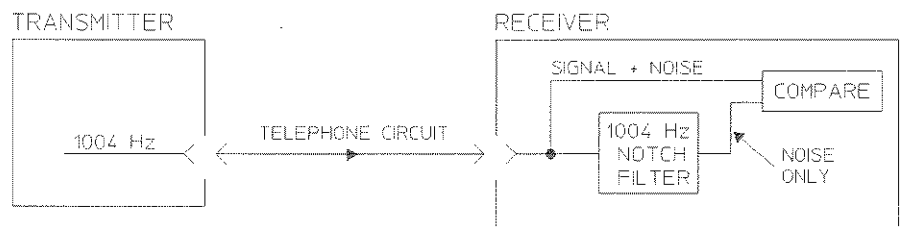

$$\text{SIGNAL-TO-NOISE RATIO} = 10 \text{ LOG } \frac{\text{SIGNAL POWER} + \text{NOISE POWER}}{\text{NOISE POWER}}$$

How it is Measured

- 1 The transmitter sends a 1004 Hz holding tone at the nominal data level.
- 2 The receiver notches out the 1004 Hz holding tone and what is left is measured via a filter (C-Message, 3 kHz Flat, 15 kHz Flat, Program or 50 kBit) then compared with the original signal-plus-noise. The computed ratio is displayed in dB.

Instrument Operation

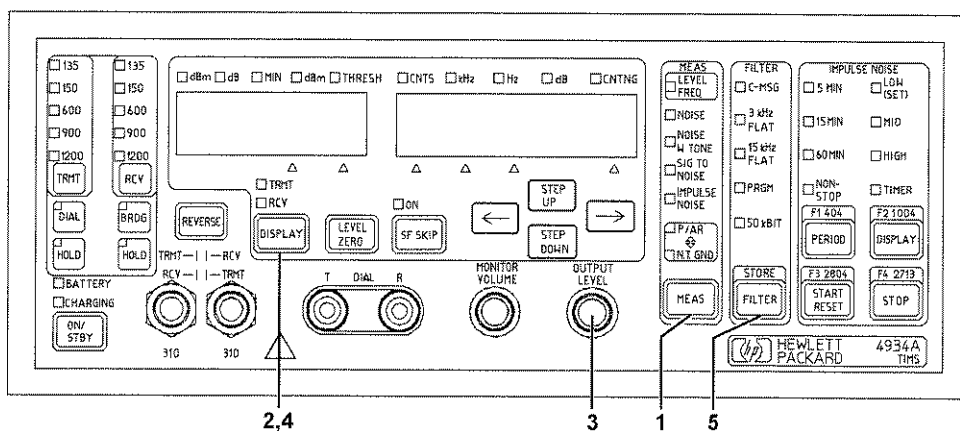

- 1 Use **MEAS** to select SIG TO NOISE.

TRANSMITTER

- 2 Display the transmitted level and frequency using the **DISPLAY** key (the TRMT indicator will be lit). Level, in dBm, is in the left window. The frequency (fixed at 1004 Hz) is in the right window.
- 3 Set the transmitted level to the nominal data level using the **OUTPUT LEVEL** control.

RECEIVER

- 4 Display the received signal-to-noise ratio using the **DISPLAY** key (the RCV indicator will be lit).
- 5 Select the required filter using the **FILTER** key.
- 6 Read the signal-to-noise ratio in dB in the right window and the level of the received tone in dBm in the left window.



Impulse Noise

Principles

Impulse noise includes noise spikes like the clicks and pops often heard on a telephone line. The spikes are much higher in level than the background noise and, generally, last less than one millisecond.

The impulse noise measurement counts the number of noise spikes against 3 threshold levels simultaneously. The low level threshold is selectable; the medium and high thresholds are fixed at 4 dB and 8 dB above the low threshold.

The waveform (b) below illustrates a received holding tone (or test tone) that includes interfering impulse noise spikes.

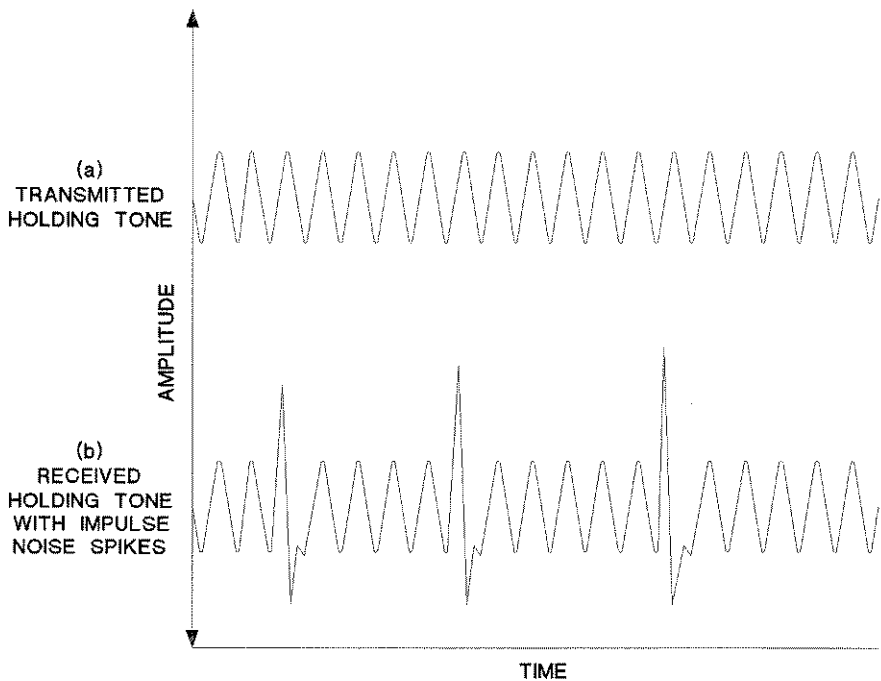

The HP 4934A measures impulse noise with or without a holding tone. The HP 4934A transmits a holding tone and uses the notch filter in the receiver when either the C-Message or 3 kHz Flat Filter is selected. With the 15 kHz Flat, Program or 50 kBit Filter selected, the transmitter is quiet terminated and the receiver notch filter is not selected.

Instrument Operation

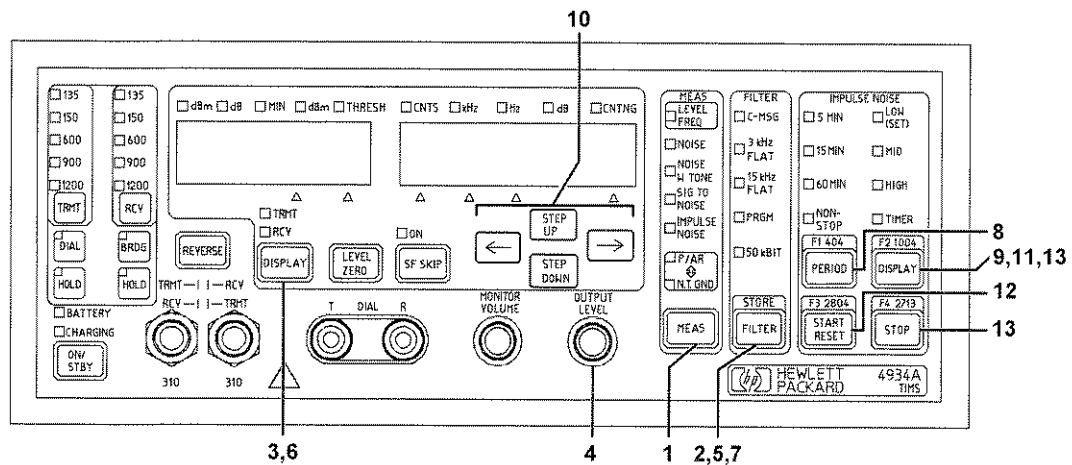

- 1 Use **MEAS** to select IMPULSE NOISE.

TRANSMITTER

To measure Impulse Noise with a holding tone, go to step 2. To measure Impulse Noise without a holding tone, go to step 5.

Impulse Noise with a Holding Tone

- 2 Select either the C-Message or 3 kHz Flat Filter using the **FILTER** key.
- 3 Display the transmitted level and frequency using the **DISPLAY** key (the TRMT indicator will be lit). Level, in dBm, is in the left window. The frequency (fixed at 1004 Hz) is in the right window.
- 4 Set the transmitted level to the nominated data level using the **OUTPUT LEVEL** control.

Impulse Noise without a Holding Tone

- 5 Select either the 15 kHz Flat, PRGM or 50 kBit Filter using the **FILTER** key. The

transmitter is quiet terminated (indicated by a decimal point in the left window when the display is in the TRMT mode).

RECEIVER

- 6 Use **DISPLAY** to select the RCV display mode.
- 7 Select the required filter using the **FILTER** key. If you are doing a loopback test, the filter selection has already been made in the transmitter procedure.

Setting the Impulse Noise Measurement Period

- 8 Use the **PERIOD** key to select a timed measurement (5, 15 or 60 minutes) or nonstop.

Setting the Impulse Noise Threshold

- 9 Use the Impulse Noise **DISPLAY** key to select LOW (SET). The current threshold value will appear in the left window (the THRESH and dBm indicators will be lit).
- 10 Use the →, ←, **STEP UP** and **STEP DOWN** keys to set the threshold value.

NOTE

If a holding tone exists on the line:

To maintain measurement accuracy, the impulse "low" threshold should be no more than 25 dB below the holding tone level.

- 11 Use the Impulse Noise **DISPLAY** key to display the resulting MID and HIGH threshold values. These are 4 dB and 8 dB greater than the low threshold value up to a limit of 109 dBm.

Starting/Stopping the Measurement

- 12 Press **START RESET** to set the impulse noise counters to zero (the CNTS and CNTNG indicators will light) and start the measurement.
- 13 Use the IMPULSE NOISE **DISPLAY** key to select TIMER.
If you select a timed measurement (5, 15 or 60 minute period) in step 8, when you press **START RESET** the time shown in the left window will decrement in 1 minute intervals to zero - the measurement then automatically stops.
If you select NON-STOP in step 8, when you press **START RESET** the time starts from zero and increments in one minute intervals. Press **STOP** to end the measurement.

NOTE

During a timed measurement you can check the current LOW, MID and HIGH threshold count by using the **DISPLAY** key. After checking the counts ensure that the instrument is set to **TIMER** again.

14 When the measurement is complete the impulse noise count is in the right window (the **CNTS** indicator will be lit). A “-” sign in the right window indicates a loss of received holding tone (impulse noise with holding tone measurement only).

NOTE

Selecting a new filter during the measurement causes the measurement to stop running.

P/AR (Peak to Average Ratio)

Principles

P/AR is a good quick measure of the combined effect of impairments which produce intersymbol interference on a data signal (for example, phase/delay distortion, attenuation distortion, intermodulation distortion and noise).

P/AR cannot determine which impairment is causing the problem - its value is primarily as a benchmark measurement to show up degradations with time in the transmission quality of a line.

A deviation of more than 4 P/AR units from the benchmark value usually indicates that some characteristic of the channel has changed significantly.

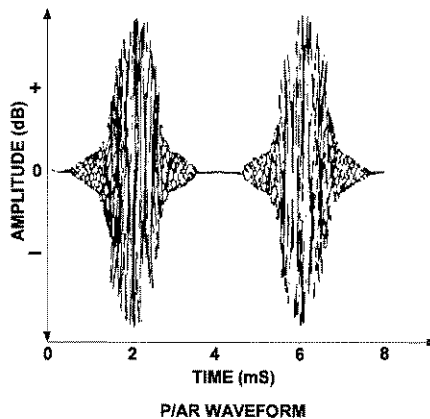

KEY	FREQUENCY	KEY	FREQUENCY
A	140.625 Hz	I	2140.625 Hz
B	380.625	J	2390.625
C	640.625	K	2640.625
D	890.625	L	2890.625
E	1140.625	M	3140.625
F	1390.625	N	3390.625
G	1640.625	O	3640.625
H	1890.625	P	3890.625

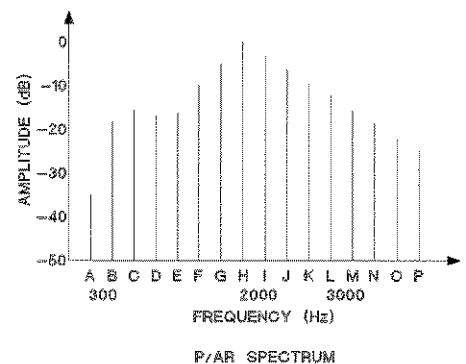

How it is Measured

- 1 The transmitter sends a complex signal which approximates a modem signal (16 frequencies with a known envelope shape).
- 2 From the received signal envelope, the receiver calculates the peak-to-average ratio. This is compared with the known peak-to-average ratio of the transmitted signal. A scaling factor ensures that a P/AR of 100 indicates no signal degradation.

Instrument Operation

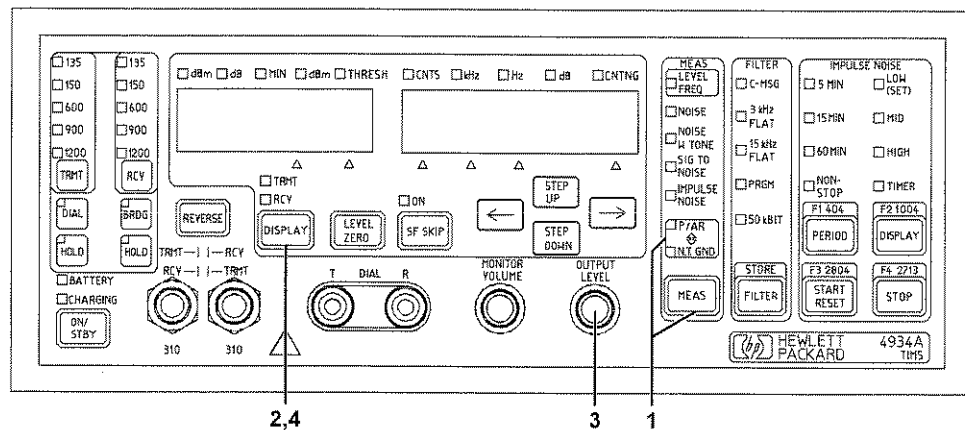

Use **MEAS** to select P/AR - there will be a 10 second delay before the HP 4934A starts measuring.

TRANSMITTER

- 3 Display the transmitted P/AR signal level (in dBm) in the left window using the **DISPLAY** key (the TRMT indicator will be lit).

Set the transmitted level to the nominal data level using the **OUTPUT LEVEL** control.

RECEIVER

- 4 Display the received signal level in the left window and the P/AR reading in the right window using the **DISPLAY** key (the RCV indicator will be lit).

Noise to Ground

Principles

This measurement determines the longitudinal (common mode) noise present on a circuit (with reference to ground) and is a measure of the susceptibility of the circuit to electrical coupling from external interference. Often this interference is power-line related and so is best measured using the 3 kHz Flat filter.

Common mode noise can be converted to transverse noise in the circuit by line imbalance.

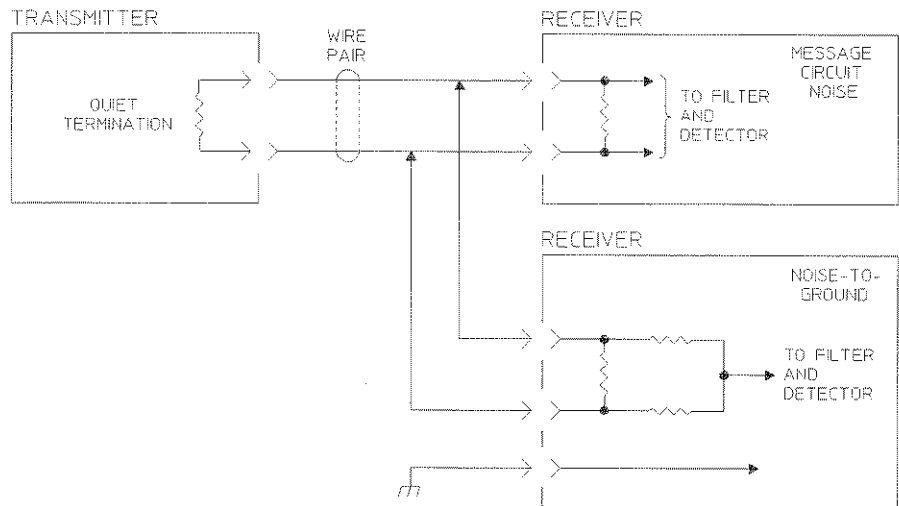

How it is Measured

The measurement technique is similar to the message circuit noise measurement but the input configuration is designed to respond to longitudinal signals. The ground used as the signal reference is the sleeve of the test cord, which is also connected to the instrument chassis and the power line ground.

Instrument Operation

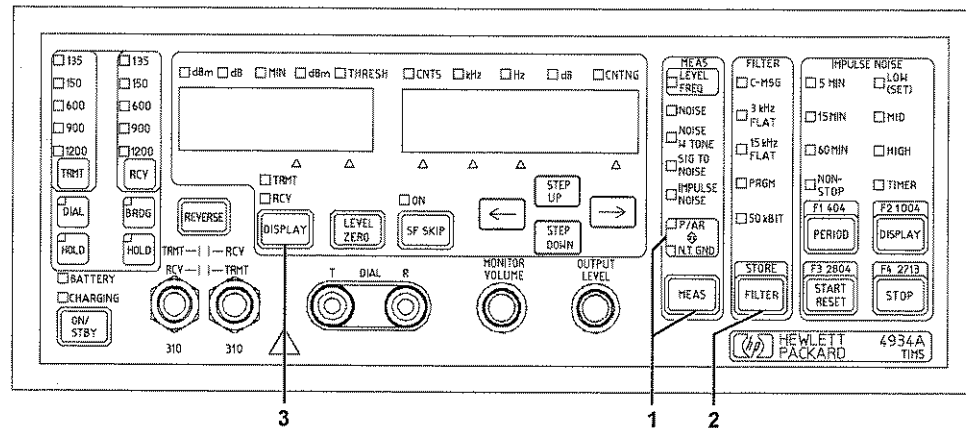

During this measurement the transmitter is quiet terminated (indicated by a decimal point "." in the left window when the display is in the TRMT mode).

RECEIVER

- 1 Use the **MEAS** key to select N.T. GND - there will be a 10 second delay before the HP 4934A starts measuring.
- 2 Select the required filter using the **FILTER** key.
- 3 Display the received noise level using the **DISPLAY** key (the RCY indicator will be lit). The noise level, in dBm, is in the left window. If you select the C-Message filter, the result is in dBmC.

General Information

Introduction

This manual contains information which allows the user to operate and calibrate the Hewlett-Packard Model 4934A Transmission Impairment Measuring Set. An HP 4934A and the accessories supplied are shown at the front of this manual (opposite the instrument description).

About this Version

Applicability

This version of the *4934A TIMS Operating & Calibration Manual* applies to HP 4934A standard unit or with options 021 or 022 installed, running software version **1.2**. These TIMS units are easily identified by the presence of a 9-pin RS-232 serial port on the right side, above the AC connector.

Some functions of older 4934As, or units running earlier versions of the software may operate differently; some functions of test sets running later software versions may not be covered by this supplement. Be sure to refer to any additional user manual supplements or release notes that came with your 4934A TIMS, or call CERJAC Telecom Operation at 1-800-9-CERJAC or +1-508-266-3300.

Check the Software Version

You can check the version number of the operating software in your 4934A by observing the right display during the start up routine. The software version is indicated in the format **r x.x**.

Specification

Instrument specifications are listed on Page 3-10. These specifications are the performance standards or limits against which the instrument is tested.

Safety Information

The following general safety precautions must be observed during all phases of operation, service, and repair of this instrument. Failure to comply with these precautions or with specific warnings elsewhere in this manual violates safety standards of design, manufacture, and intended use of the instrument. Hewlett-Packard Company assumes no liability for the customer's failure to comply with these requirements.

This is a Safety Class I instrument (provided with a protective earthing ground, incorporated in the powercord). The mains plug shall only be inserted in a socket outlet provided with a protective earth contact. Any interruption of the protective conductor inside or outside of the instrument is likely to make the instrument dangerous. Intentional interruption is prohibited.

General

DO NOT operate the product in an explosive atmosphere or in the presence of flammable gasses or fumes.

DO NOT use repaired fuses or short-circuited fuseholders: For continued protection against fire, replace the line fuse(s) only with fuse(s) of the same voltage and current rating and type.

DO NOT perform procedures involving cover or shield removal unless you are qualified to do so: Operating personnel must not remove equipment covers or shields. Procedures involving the removal of covers and shields are for use by service-trained personnel only.

DO NOT service or adjust alone: Under certain conditions, dangerous voltages may exist even with the equipment switched off. To avoid dangerous electrical shock, service personnel must not attempt internal service or adjustment unless another person, capable of rendering first aid and resuscitation, is present.







DO NOT operate damaged equipment: Whenever it is possible that the safety protection features built into this product have been impaired, either through





physical damage, excessive moisture, or any other reason, REMOVE POWER and do not use the product until safe operation can be verified by service-trained personnel. If necessary, return the product to a Hewlett-Packard Sales and Service Office for service and repair to ensure the safety features are maintained.

DO NOT substitute parts or modify equipment: Because of the danger of introducing additional hazards, do not install substitute parts or perform any unauthorized modification to the product. Return the product to a Hewlett-Packard Sales and Service Office for service and repair to ensure the safety features are maintained.

Safety Symbols

The following symbols on the instrument and in the manual indicate precautions which must be taken to maintain safe operation of the instrument.

Safety Symbols	
	The Instruction Documentation Symbol. The product is marked with this symbol when it is necessary for the user to refer to the instructions in the supplied documentation.
	Indicates the field wiring terminal that must be connected to earth ground before operating the equipment - protects against electrical shock in case of fault.
 OR 	Frame or chassis ground terminal - typically connects to the equipment's metal frame.
	Alternating current (AC)
	Direct current (DC)
	Indicates hazardous voltages

Safety Symbols	
WARNING	Warning denotes a hazard. It calls attention to a procedure, which if not correctly performed or adhered to could result in injury or loss of life. Do not proceed beyond a warning note until the indicated conditions are fully understood and met.
CAUTION	Caution denotes a hazard. It calls attention to a procedure, which if not correctly performed or adhered to could result in damage to or destruction of the instrument. Do not proceed beyond a warning note until the indicated conditions are fully understood and met.
	The CE mark shows that the product complies with all relevant European legal Directives accompanied by a year, it's when the design was proven).
ISM 1-A	This is a symbol of an Industrial Scientific and Medical Group 1 Class A product.
	The CSA mark is a registered trademark of the Canadian Standards Association.
	Indicates a functional earth terminal.
	The recycling symbol.
	The dispose of properly symbol.



Statement of Compliance

This instrument has been designed and tested in accordance with IEC Publication 1010-1 + A1:1992 + A2:1995 Safety requirements for Electrical Equipment for Measurement, Control and Laboratory Use, and has been supplied in a safe condition. The instruction documentation contains information and warnings which must be followed by the user to ensure safe operation and to maintain the instrument in a safe condition.

Electromagnetic Compatibility (EMC) Information

This product has been designed to meet the protection requirements of the European Communities Electromagnetic Compatibility (EMC) directive 89/336/EEC. In order to preserve the EMC performance of the product, any cable which becomes worn or damaged must be replaced with the same type and specification.

Declaration of Conformity

according to ISO/IEC Guide 22 and EN45014

Manufacturer's Name: Hewlett Packard Ltd.
Manufacturer's Address: Telecommunications Networks Test
Division
South Queensferry
West Lothian, EH30 9TG
Scotland, United Kingdom

Declares that the product

Product Name: Transmission Impairment Test Set
Model Numbers: HP 4934A
Product Options: All

This declaration covers all options of the above products as detailed in TCF A-59519852-02.
Conforms with the protection requirements of European Council Directive 89/336/EEC on the approximation
of the laws of the member states relating to electromagnetic compatibility.
Against EMC test specifications EN 55011:1991 (Group 1, Class A) and EN 50082-1:1992

As Detailed in: Electromagnetic Compatibility (EMC)
Technical Construction File (TCF) No. A-59519852-02

Assessed by: Dti Appointed Competent Body
EMC Test Centre,
GEC-Marconi Avionics Ltd.,
Maxwell Building,
Donibristle Industrial Park,
KY11 5LB
Scotland, United Kingdom

Technical Report Number:6893/2200/CBR, dated 21 August 1997

Supplementary Information:

The product conforms to the following safety standards:

EN 61010-1(1993) / IEC 61010-1(1990) + A1(1992) + A2 (1994)
CSA-C22.2 No. 1010.1-92
EN 60825-1(1994) / IEC 825-1 (1993)

The product herewith complies with the requirements of the Low Voltage Directive 73/23/EEC, and carries the
CE-marking accordingly.

South Queensferry, Scotland

31 July 1998



Location

Date

W.R. Pearson / Quality Manager

Europe Contact:
Your Local Hewlett-Packard Sales and Service Office or Hewlett Packard GmbH, Department 2Q / Standards
Europe
Herrenberger Strasse 130, D7030 Boblinger (Fax: +49-7031-143143)



Instruments Covered by Manual

Attached to the instrument is a serial number plate. This serial number is in the form XXXXUXXXXX. It is in two parts; the first four digits and the letter are the serial prefix and the last five are the suffix. The prefix is the same for all identical instruments, it changes only when a change is made to the instrument. The suffix however, is assigned sequentially and is different for each instrument. The contents of this manual apply to instruments with the serial number prefix(es) listed under SERIAL NUMBERS on the title page.

An instrument manufactured after the printing of this manual may have a number prefix that is not listed on the title page. The unlisted serial number prefix indicates the instrument is different from those described in this manual. The manual for this new instrument is accompanied by a Manual Changes supplement. This supplement contains "change information" that explains how to adapt the manual to the new instrument.

In addition to change information, the supplement may contain information for correcting errors in the manual. To keep this manual as current and accurate as possible, Hewlett-Packard recommends that you periodically request the latest Manual Changes supplement. The supplement for this manual is identified with the manual print date and part number, both of which appear on the manual title page. Complementary copies of the supplement are available from Hewlett-Packard. For information concerning a serial number prefix that is not listed on the manual title page or in the Manual Changes supplement, contact your nearest Hewlett-Packard office.

Options Available

The following options are available and may have been ordered with the HP 4934A:

- | | |
|-------------------|---|
| Option 001 | Rechargeable Ni-Cd battery and charger. |
| Option 010 | Delete Test Cords (two HP 15513A 1m WECO 310-to-WECO 310 cables). |
| Option 021 | Extends frequency range to 200 kHz. |
| Option 910 | Provides an additional copy of the Operating and Calibration Manual and two copies of the Service Manual. |
| Option 915 | Used for ordering a copy of the Service Manual to enable a service trained person to troubleshoot and repair the instrument. |
| Option W30 | 3-year Extended Support. W30 is an extended hardware support agreement. It provides 2-year extended hardware support beyond the standard 1-year return to bench warranty. |
| Option 1A3 | For Bell Operating Companies: Provides Bellcore Common Language Equipment Identification (CLEI) compliance (Product and Shipping carton labeling). |

Accessories Supplied

The accessories supplied with the HP 4934A are:

<i>Accessories Supplied</i>	<i>Part Number</i>
Power Cord	HP 8120-1378
Operating and Calibration Manual	HP 04934-90054
Test Cords - Two 1m WECO 310-to-WECO 310 cables	HP 15513A
Instruction Label	HP04934-90002

The Instruction Label is primarily intended to be fixed to the inside of the front cover. However, it is supplied loose so that you can fix it to a location of your choice. The location should be a flat clean dry surface. To fix the label, remove the protective backing, then carefully position the label on the flat surface.

Accessories Available

The following accessories are available and may have been ordered with the HP 4934A:

HP 18182A	1.5m (60-inch) test cord with a 310 male connector and alligator clips.
HP 15678A	19-inch rack mount kit.
HP 15677A	Ladder bracket.
HP E6321A	Soft vinyl carrying case with handles and shoulder strap and space for manuals and test cords.

Specifications

This section details the specifications of the 4934A TMS. Except where otherwise stated, the following parameters are warranted performance specifications. Parameters described as “typical” or “nominal” are supplemental characteristics that provide a useful indication of typical, but non-warranted, performance. Test methods meet IEEE standards 743-1984.

Transmitter Frequency

Range	Resolution	Accuracy
20 to 99999 Hz	1 Hz	±50 ppm
100 to 110 kHz†	10 Hz	±120 ppm

† Wideband option expands range to 200 kHz.

Additional Transmitter Functions

SF Skip: Transmitter skips 2600 ± 150 Hz.

Four Preset Frequencies: Normally 404, 1004, 2804, and 2713 Hz.

- User can temporarily change these and the SF Skip center frequency.

Receiver Frequency

Range	Resolution	Accuracy
20 to 9999 Hz	1 Hz	±1 Hz
10 to 110 kHz †	10 Hz	±10 Hz

† Wideband option expands range to 200 kHz.

Transmitter Level

Range: -40 to +13 dBm.

Resolution: 0.1 dB.

Accuracy at 1004 Hz, 0 to -19 dBm: Typically 0.1 dB.

Flatness (dB relative to 1004 Hz):

Level (dBm)	Frequency (Hz)				
	20-200	200-15k	15k-60k	60k-85k	85k-110k †
+10 to +13	+1-2.5	±0.3	±0.5	±0.7	±2.0
-40 to +10	±1.5	±0.3	±0.5	±0.6	±2.0

† Wideband option expands range to 200 kHz.

Distortion (dB down from fundamental, typical):

Level (dBm)	Frequency (Hz)		
	30-100	100-4k	4k-110k†
+10 to +13	20	45	45
0 to +10	20	50	45
-30 to 0	40	45	40
-40 to -30	40	43	33

† Wideband option expands range to 200 kHz.

At 1004 Hz, 0 dBm: THD typically >65 dB down from fundamental.

Receiver Level

Range: -60 to +13 dBm.

Resolution: 0.1 dB.

Detector Type: Average.

Accuracy (dB):

Level (dBm)	Frequency (Hz)						
	20-50	50-200	200-15k	15k-60k	60k-85k	85k-110k *	110k-200k †
+13 to -40	±1.0	±0.5	±0.2	±0.5	±0.5	±2.0	±2.0
-40 to -60	±1.3	±0.6	±0.4	±0.8	±1.0	±2.0	±2.0

At 1004 Hz, -20 to +13 dBm ± 0.1 dB: Receiver accuracy is specified from 500 Hz when using the 135 or 150 ohm terminations.

* Receiver accuracy specified when Transmitter frequency is <110 kHz.

† Frequency range 110k - 200k applicable when Wideband option 021 is installed.

Message Circuit Noise (Receiver)

- Transmitter: off and terminated

Range: 0 to 100 dbrn (135 & 150 ohm: 10 to 100 dBrn).

Resolution: 1 dB.

Detector Type: Quasi-RMS.

Accuracy: For 135 and 150 ohms: ±3 dB from 10 to 15 dBrn; ±1 dB from 15 to 100 dBrn. For 600, 900, 1200 ohms: ±1 dB from 10 to 100 dBrn; ±3 dB from 0 to 10 dBrn.

Filters: C-Message, 3 kHz Flat, 15 kHz Flat, Program, 50 kbit.



Noise-with-Tone (Receiver)

- Transmitter: 1004 Hz tone.

Notch Filter: >50 dB rejection from 995 to 1025 Hz.

Range (at 600, 900 and 1200 ohm): 10 to 100 dBrn.

Resolution: 1 dB.

Accuracy: ± 1.5 dB from 20 to 100 dBrn, ± 3 dB from 10 to 20 dBrn.

Detector Types: (noise) Quasi-RMS; (tone) Average.

Filters: C-Message, 3 kHz Flat, 15 kHz Flat, Program, 50 kbit.

Signal-To-Noise Ratio (Receiver)

- Transmitter: 1004 Hz tone.

Signal Level Range (600, 900 and 1200 ohm): -40 to +10 dBm.

Ratio Range: 10 to 45 dB.

Ratio Resolution: 1 dB.

Accuracy (signal -30 to +10 dBm): S/N 10 to 40 dB: ± 1 dB; S/N 40 to 45 dB: ± 2 dB.

Detector Types: (noise) Quasi-RMS; (tone) Average.

3-Level Impulse Noise (Receiver)

- Transmitter: C-Message or 3 kHz Flat receive filter selected: 1004 Hz tone. Any other receive filter: off and terminated.

Level Range: -40 to +10 dBm.

Notch Filter: >50 dB rejection of levels < -5 dBm.
>40 dB rejection of levels > -5 dBm.
Frequency range 995 to 1025 Hz.

Threshold Ranges (at 600 ohm): Low 30 to 109 dBrn, Mid and High 4 and 8 dB higher respectively, up to 109 dBrn.

Threshold Accuracy: 40 dBrn ± 3 dB, >50 dBrn ± 1 dB.

Loss of Holding Tone: “_” sign in right display; latching.

Count Timer: Nominally 5, 15, 60 minutes, or nonstop.

Count Range: 0 to 9999.

Max Count Rate: Nominally 8 per second.

Noise-to-Ground (Receiver)

- Transmitter: off and terminated.

Range (600, 900 and 1200 ohm): 50 to 130 dBrn.

Resolution: 1 dB.

Accuracy: ± 1.5 dB (60–130 dBrn); ± 2.5 dB (50–60 dBrn).

Filters and Detector: See message circuit noise.

P/AR

Transmitter

Signal: 16 frequencies in range 140 to 3890 Hz.

Level range: –40 to 0 dBm.

Resolution: 1 dB.

Receiver

P/AR Range: 0 to 120 units.

Resolution: 1 unit.

Accuracy (30 to 110 units): ± 2 units.

Level Range: –40 to +3 dBm RMS
(135 and 150 ohm: –30 to +3 dBm RMS).

Resolution: 1 dB.

General

Maximum DC Blocking: 200 V nominal.

Impedances: Nominally 135,150,600, 900 and 1200 ohm. Transmit and receive impedances are independently selectable.

Receiver Return Loss: (600, 900 and 1200 ohm; 50 Hz to 4kHz) Typically >30 dB.

Bridging Loss (up to 20 kHz): Typically <0.2 dB.

Longitudinal Balance: (typical) >80 dB at 60 Hz, >70 dB at 540 Hz, >60 dB up to 4 kHz, decreasing at 6 dB per octave up to 20 kHz.

Hold Circuits: Two, each drawing 23 mA nominal.

AC Power Requirement: Selectable between 90 to 126Vac RMS, 48 to 66 Hz and 198 to 264 Vac RMS, 48 to 66 Hz. 20 VA maximum.

Battery Supply (option 001): Nominally 6 hours (4 hours minimum) operation at 25 °C. Complete recharge typically in 14 hours with unit in standby mode.

RS-232 port: DB-9S connector; DTE; baud rates 300, 1200, 2400, 9600, 19200, 38400. 8-bits; no parity; 1 stop bit; hardware flow control.

Temperature range (without batteries): Operating: 0 to +50 °C. Storage: -40 to +75 °C.

Temperature Range (with batteries): Operating: 0 to +40 °C; Storage: -20 to +55 °C.

Size (W H D; including handle): 28.0 10.5 35.5 cm
(11.0 4.1 14.0 inches)

Weight (without batteries): 3.7 kg (8.2 lb).

Weight (with batteries): 5.0 kg (11.0 lb).

Installation

Introduction

This section provides installation instructions for the Hewlett-Packard Model 4934A Transmission Impairment Measuring Set and its accessories. This section also includes information about initial inspection, preparation for use, packaging, storage and shipment.

Initial Inspection

WARNING

To avoid hazardous electrical shock, do not perform electrical tests when there are signs of shipping damage to any portion of the outer enclosure (covers, panels, meters and so on).

Inspect the shipping container for damage. If the shipping container or cushioning material is damaged, it should be kept until the contents of the shipment have been checked for completeness and the instrument has been checked mechanically and electrically. Procedures for checking electrical performance are given in Chapter 5 of this manual. If the contents are incomplete, if there is mechanical damage or defect or if the HP 4934A does not pass the Performance Tests, notify the nearest Hewlett-Packard office. If the shipping container is damaged or the cushioning material shows signs of stress, notify the carrier as well as the Hewlett-Packard office. Keep the shipping materials for the carrier's inspection. The HP office will arrange for repair or replacement at HP option without waiting for claim settlement.

WARNING

If this instrument is not used as specified, the protection provided by the equipment could be impaired. This instrument must be used in a normal condition only (in which all means for protection are intact).

Preparation for Use

WARNING

To avoid the possibility of injury or death, the following precautions must be followed before the instrument is switched on.

A. Note that the protection provided by grounding the instrument cabinet may be lost if any power cable other than the three-pronged type supplied is used to couple the AC line voltage to the instrument.

B. If this instrument is to be energized via an auto-transformer to reduce or increase the line voltage, make sure that the common terminal is connected to the neutral pole of the power source.

C. The power cable plug shall only be inserted into a socket outlet provided with a protective earth contact. The protective action must not be negated by the use of an extension cord without a protective conductor (grounding).

Power Requirements

The instrument requires a power source of 90 to 126 V AC, 48 to 66 Hz single phase. If necessary, the 4934A can be changed to 198-264 V AC, 48 to 66 Hz using an internal switch. Check instructions before doing so and ensure the correct fuse is used. The power consumption is less than 20 VA.

Line Fuse

The line fuse is located on the side panel.

WARNING

For continued protection against fire hazard, replace the line fuse only with the same type and line rating (F 125mA, 250V for 230V operation or F 250mA, 250V for 15V operation). The use of other fuses or materials is prohibited.

Power Cable

This instrument is equipped with a three-wire power cable. When connected to a properly grounded power outlet, this cable grounds the instrument case.

Battery (Option 001 or Retrofit)

Battery



CAUTION

CONTAINS NICKEL CADMIUM BATTERY MUST BE RECYCLED OR DISPOSED OF PROPERLY.

Consult your local HP office for details.

Only replace with batteries of the same type and rating. Rechargeable nickel-cadmium, 6 cell 4Ah batteries.

WARNING

Do not short circuit the battery terminals, it may cause serious personal injury. The battery should only be changed by service trained personnel.

Do not incinerate or otherwise mutilate the battery. It might burst or release toxic materials causing personal injury.

For operator protection during battery operation, connect the chassis terminal on the side panel to earth ground.

The instrument will run with a fully charged battery for nominally 6 hours at 25 degrees centigrade. Full charge is ensured by charging for 14 hours at 25 degrees centigrade. The battery is not Operator replaceable, refer to to service-trained personnel or return to the nearest HP Service Centre.

Mating Connectors (Front Panel)

The TRMT and RCV front panel jacks are 310-type connectors. The mating plug for the jacks is part number HP 1251-0695.

Operating Environment

This instrument is designed for indoor use only.

Temperature	The instrument may be operated in temperatures from 0 degrees centigrade to +50 degrees centigrade. The temperature for battery operation is 0 degrees centigrade to +50 degrees centigrade.
Humidity	The instrument may be operated in environments with humidity up to 95% at 40 degrees centigrade. However, the instrument should also be protected from temperature extremes which may cause condensation within the instrument.
Altitude	The instrument may be operated at altitudes up to 4,600m (15,000 ft.).
Air Flow	To provide adequate cooling, an air gap of approximately 3 inches should be maintained around the instrument.

Cleaning

To clean the module/instrument: Use a soft, clean damp cloth to clean the front-panel and clam shell covers.

CAUTION

This instrument is designed for use in Installation Category II and Pollution Degree 2 per IEC 61010 and 60644 respectively.

Noise Declaration

LpA<70dB

am Arbeitsplatz (operator position)

normaler Betrieb (normal position)

nach DIN 45635 pt. 19 (per ISO 7779)

Storage and Shipment

Environment

The instrument may be stored or shipped in environments within the following limits:

Temperature -40 degrees centigrade to +75 degrees centigrade without a battery and -20 degrees centigrade to +55 degrees centigrade with a battery.

Humidity 90%

Altitude 15,300m (50,000 ft.)

The instrument should also be protected from temperature extremes which may cause condensation within the instrument.

Packaging

Tagging for Service

If the instrument is being returned to Hewlett-Packard for service, please complete one of the blue repair tags located at the front of the service manual (if you have one) or give details on a label then attach the tag or label to the instrument.

Original Packaging

Containers and material identical to those used in the factory packaging are available through Hewlett-Packard offices. If the

instrument is being returned to Hewlett-Packard for servicing, attach a tag indicating the type of service required, return address, model number and full serial number. Also mark the container "FRAGILE" to ensure careful handling.

Other Packaging The following general instructions should be used for repacking with commercially available materials:

- a Wrap instrument in heavy paper or plastic. (If shipping to Hewlett-Packard office or service center, attach a tag indicating type of service required, return address, model number and full serial number.)
- b Use strong shipping container. A double-walled carton of 35-pound test material is adequate.
- c Use a layer of shock absorbing material 70 to 100 mm (3 to 4 inch) thick around all sides of the instrument to provide firm cushioning and prevent movement inside the container. Protect the control panel with the front cover provided or with cardboard.
- d Seal shipping container securely.
- e Mark the shipping container clearly.
- f In any correspondence, refer to instrument by model number and full serial number.

Performance Tests

Introduction

This chapter contains procedures which tests the HP 4934A electrical performance to the specifications in Chapter 3.

There are two levels of performance testing contained in this chapter:

Operational**Verification**

Provides >90% confidence that the instrument is operating to its full warranted specification.

Full Performance**Test**

Ensures that the instrument is operating to its full warranted specification.

Results of the Performance Test may be recorded on the Test Record at the end of Chapter 5, or on the Abbreviated Test Record at the end of the Operational Verification procedures.

Calibration Cycle

Results recorded on the Test Record at incoming inspection can be used for comparison in yearly maintenance and calibration or after repairs or adjustments.

Recommended Test Equipment

The test equipment required is listed in the following table. Equipment which meets or exceeds the critical specifications may be substituted for the recommended model.

Recommended Test Equipment

Instrument	Critical Specification	Recommended Model
AC Calibrator	Frequency range 20 Hz to 110 kHz. Voltage range 1.5 mV to 80 V.	DATRON 4707A
Synthesizer	Balanced 600Ω output	HP 3336B
DMM	6 1/2 digit resolution	HP 3456A
DC Power Supply	Dual output, range 0 to 48 V	HP 6234A
Frequency Counter	Range 20 Hz to 10 MHz, .001 Hz resolution at 20 Hz.	HP5315A
Decade Transformer	Attenuation 0 to 85 dB.	Model DT72A DEKATRAN
600Ω Resistor	0.01% 0.25W	HP 0811 - 3502
100Ω Resistor	1% 0.25W	HP 0757 - 0178
20 dB Amplifier and 4 kHz low pass filter	Details of the specification and construction are in Appendix A which is at the rear of this manual.	SA1
Power Adder	Details of the specification and construction are in Appendix B which is at the rear of this manual.	SA2
WECO 310 type connector		HP 1252 - 0695

Operational Verification

The Operational Verification tests quickly establish with >90% confidence that the HP 4934A meets the specifications listed in Chapter 3. If any test fails to meet specification, refer to the Adjustments in Chapter 5 of the Service Manual. If after adjustment the specification still cannot be met, refer to the troubleshooting in Chapter 8 of the Service Manual.

The following table lists all the Operational Verification Tests.

Operational Verification	What to Do
Transmitter Frequency	Carry out the Performance Test on Page 5-19 at the following frequencies: 20 Hz, 1000 Hz, 50 kHz and 110 kHz.
Transmitter Level	Carry out the Performance Test on Page 5-20.
Receiver Frequency	Carry out the procedure on Page 5-4.
Receiver Level	Carry out the procedure on Page 5-5.
Weighting Filters	Carry out the procedure on Page 5-6.
Message Circuit Noise	Carry out the Performance Test on Page 5-34.
Impulse Noise	Carry out steps 1 to 17 in the Performance Test on Page 5-39.
Impulse Noise Count	Carry out the procedure on Page 5-9.
Peak to Average Ratio (P/AR)	Carry out the Performance Test on Page 5-43.
Loss of Holding Tone	Carry out the procedure on Page 5-10.
Hold Circuits	Carry out the procedure on Page 5-11.
Dynamic Hold Circuits	Carry out the Performance Test on Page 5-13.

Receiver Frequency

- 1 Connect the HP 4934A TRMT port to the RCV port.
- 2 Set the HP 4934A as follows:

Measurement	: LEVEL FREQ
Transmitter (TRMT) Impedance	: 600 Ω
Receiver (RCV) Impedance	: 600 Ω
Display Mode	: TRMT
Transmitter Level/Frequency	: 0 dBm/20 Hz

- 3 Set the Display Mode to RCV. Check the displayed frequency is between 19 and 21 Hz.
- 4 Set the transmitter frequency (Display Mode - TRMT) to each of the values in the following table and check that the displayed receiver frequency (Display Mode - RCV) is within limits.

Transmitter Frequency	Receiver Frequency
1,000 Hz	998 to 1002 Hz
50,000 Hz	49.99 to 50.01 kHz
110,000 Hz	109.99 to 110.01 kHz



Receiver Level

- 1 Connect the HP 4934A TRMT port to the RCV port.
- 2 Set the HP 4934A as follows:

Measurement	: LEVEL FREQ
Transmitter (TRMT) Impedance	: 600Ω
Receiver (RCV) Impedance	: 600Ω
Display Mode	: TRMT
Transmitter Level/Frequency	: 0 dBm/1004 Hz
- 3 Set the Display Mode to RCV. Check the displayed level is between -0.2 and +0.2 dBm.
- 4 Set the transmitter level to -19 dBm (Display Mode - TRMT).
- 5 Check that the received level (Display Mode - RCV) reading is between -19.2 and -18.8 dBm.

Weighting Filters

EQUIPMENT

AC Calibrator: DATRON 4707A

CAUTION

Ensure that the AC Calibrator OUTPUT is switched off or set to the minimum level before proceeding with the following procedure.

- 1 Connect the AC Calibrator output to the HP 4934A RCV port.

C-Message Filter

- 2 Set the HP 4934A as follows:

Measurement	: NOISE
Transmitter (TRMT) Impedance	: 600Ω
Receiver (RCV) Impedance	: 600Ω
Display Mode	: RCV
Filter	: C-MSG

- 3 Set the AC Calibrator output level to 0.7746 V then switch on the OUTPUT.

NOTE

Do not adjust the AC Calibrator output level during the remainder of this test.

- 4 Set the AC Calibrator to each of the frequencies listed in the following table and check the HP 4934A noise readings.

AC Calibrator Frequency	HP 4934A Noise Reading
300 Hz	71 to 77 dBm
600 Hz	83 to 87 dBm
1,000 Hz	89 to 91 dBm
2,500 Hz	87 to 91 dBm
5,000 Hz	57 to 65 dBm

3 kHz Flat Filter

- 5 Select the 3 kHz FLAT filter.
- 6 Set the AC Calibrator to each of the frequencies in the following table and check the HP 4934A noise readings.

AC Calibrator Frequency	HP 4934A Noise Reading
400 Hz	88 to 92 dBrn
1,000 Hz	89 to 91 dBrn
3,000 Hz	84 to 90 dBrn
6,000 Hz	74 to 82 dBrn

15 kHz Flat Filter

- 7 Select the 15 kHz FLAT filter.
- 8 Set the AC Calibrator to each of the frequencies in the following table and check the HP 4934A noise readings

AC Calibrator Frequency	HP 4934A Noise Reading
400 Hz	88 to 92 dBrn
1,000 Hz	89 to 91 dBrn
15,000 Hz	84 to 90 dBrn
30,000 Hz	74 to 82 dBrn

Program Filter

- 9 Select the PRGM filter.
- 10 Set the AC Calibrator to each of the frequencies in the following table and check the HP 4934A noise readings.

AC Calibrator Frequency	HP 4934A Noise Reading
100 Hz	61 to 67 dBrn
500 Hz	81 to 85 dBrn
1,000 Hz	88 to 92 dBrn
2,000 Hz	92 to 98 dBrn
7,000 Hz	92 to 100 dBrn
10,000 Hz	76 to 86 dBrn

50 kBit Filter

11 Select the 50 kBit filter.

12 Set the AC Calibrator to each of the frequencies in the following table and check the HP 4934A noise readings.

AC Calibrator Frequency	HP 4934A Noise Reading
50 Hz	85 to 90 dBrn
1,000 Hz	89 to 91 dBrn
15,000 Hz	87 to 91 dBrn
25,000 Hz	86 to 90 dBrn
50,000 Hz	< 69 dBrn

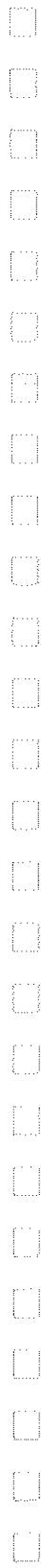

Impulse Noise Count

CAUTION

Ensure that the AC Calibrator OUTPUT is switched off or set to the minimum level before proceeding with the following procedure.

- 1 Connect the AC Calibrator output to the HP 4934A RCV port.
- 2 Set the HP 4934A as follows:

Measurement	: IMPULSE NOISE
Transmitter (TRMT) Impedance	: 600Ω
Receiver (RCV) Impedance	: 600Ω
Display Mode	: RCV
Filter	: 15 kHz FLAT
Period	: NON-STOP
Impulse Noise Display	: LOW (SET)
- 3 Set the AC Calibrator output level to 0.7746 V at 2,000 Hz then switch on the OUTPUT.
- 4 Set the LOW (SET) threshold to 75 dBm.
- 5 Press START RESET to start the measurement.
- 6 Wait 60 seconds then press **STOP**.
- 7 Check the reading on the HP 4934A display is 480 ± 48 counts.
- 8 Select the MID threshold. Check the reading on the display is 480 ± 48 counts.
- 9 Select the HIGH threshold. Check the reading on the display is 480 ± 48 counts.

Loss of Holding Tone

1 Connect the HP 4934A TRMT port to the RCV port.

2 Set the HP 4934A as follows:

Measurement	: NOISE W TONE
Filter	: C-MSG
Transmitter (TRMT) Impedance	: 600Ω
Receiver (RCV) Impedance	: 600Ω
Display Mode	: TRMT
Transmitter Level	: 0 dBm

3 Set the Display Mode to RCV and remove the cable from the RCV port.

4 Err 7 should be displayed in the right window.

Hold Circuit

WARNING

Hazardous voltages are present during this procedure - only service trained personnel, aware of the hazards involved, should perform the test.

EQUIPMENT

DC Voltmeter	: HP 3456A
DC Power Supply	: HP 6234A
100Ω 1% Resistor	: HP 0757-0178
WECO 310 Connector	: HP 1252-0695

PROCEDURE

- 1 Connect the equipment as shown in the following figure.

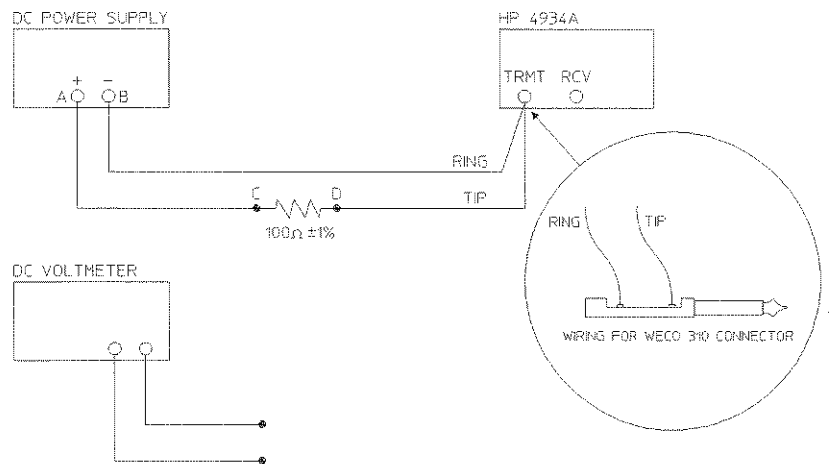

- 2 Set the HP 4934A as follows:

Measurement	: LEVEL FREQ
Transmitter (TRMT) Impedance	: 600Ω
Receiver (RCV) Impedance	: 600Ω
Transmit Hold Select	: TRMT HOLD
Receive Hold Select	: RCV HOLD

Transmitter Hold Circuit

- 3 Connect the DC Voltmeter across points A and B shown in the previous figure.
- 4 Adjust the DC Power Supply output level until a 48 V reading is obtained on the DC Voltmeter.
- 5 Connect the DC Voltmeter across points C and D shown in the previous figure and note the reading.
- 6 Calculate the hold current as follows:
Hold Current = (Voltage noted in step 5)+100
The specification of the hold current is nominally 26 mA.
- 7 Switch off the DC Power Supply.
- 8 Reverse the polarity of the connections to the DC Power Supply.
- 9 Switch on the DC Power Supply.
- 10 Repeat steps 5 to 7.

Receiver Hold Circuit

- 11 Press **REVERSE**.
- 12 Repeat steps 5 to 10.

Dynamic Hold Circuit

EQUIPMENT

Function Generator : HP 3325A (50 Ω output impedance, DC offset capability)

PROCEDURE

- 1 Connect the Function Generator output to the HP 4934A RCV port.
- 2 Set the HP 4934A as follows:

Measurement	: LEVEL FREQ
Receiver (RCV) Impedance	: 600 Ω
Bridge (BRDG) Select	: BRDG ON

- 3 Set the Function Generator as follows:

Function	: Sine
Frequency	: 1004 Hz

Adjust the Function Generator output level until the HP 4934A RCV display reads 0 dBm (approx. +10.8 dBm on the HP 3325A). Do not adjust the Function Generator output level for the remainder of this test.

- 4 Select RCV HOLD on the HP 4934A.
- 5 Set the Function Generator DC Offset level to 3.9V.
- 6 Check the reading on the HP 4934A RCV display is 0 \pm 0.3 dBm.
- 7 Set the Function Generator DC offset level to -3.9V.
- 8 Check the reading on the HP 4934A RCV level display is 0 \pm 0.3 dBm.

<i>Hewlett-Packard</i>	<i>Tested by:</i>
<i>Model 4934A</i>	<i>Date:</i>
<i>Transmission Impairment Measuring Set</i>	<i>Serial No.:</i>

Table 1 Operation Verification Test Record

Page No.	Test Description	Result		
		<i>Min</i>	<i>Actual</i>	<i>Max</i>
5-19	<i>Transmitter Frequency Accuracy</i>			
	Step 3: 20 Hz	19.999 Hz		20.001 Hz
	Step 4: 1000 Hz	999.95 Hz		1000.05 Hz
	50,000 Hz	49,997.5 Hz		50,002.5 Hz
	110,000 Hz	109,986.8 Hz		110,013.2 Hz
5-21	<i>Transmitter Level Accuracy</i>			
	Step 4: 0 dBm	0.7657 V		0.7836 V
	Step 5: -5 dBm	0.4306 V		0.4406 V
	-10 dBm	0.2421 V		0.2478 V
	-19 dBm	0.0859 V		0.0879 V
5-4	<i>Receiver Frequency</i>			
	Step 3: 20 Hz	19 Hz		21 Hz
	Step 4: 1000 Hz	998 Hz		1002 Hz
	50,000 Hz	49.99 kHz		50.01 kHz
	110,000 Hz	109.99 kHz		110.01 kHz
5-5	<i>Receiver Level</i>			
	Step 3: 0 dBm	-0.2 dBm		0.2 dBm
	Step 5: -19 dBm	-19.2 dBm		-18.8 dBm

5-14 Performance Tests

Table 1 **Operation Verification Test Record**

Page No.	Test Description	Result		
		<i>Min</i>	<i>Actual</i>	<i>Max</i>
5-6	<i>Weighting Filters</i>			
	<i>C-Message Filter</i>			
	Step 4:	300 Hz	71 dBrn	77 dBrn
		600 Hz	83 dBrn	87 dBrn
		1000 Hz	89 dBrn	91 dBrn
5-7	<i>3 kHz Flat Filter</i>			
	Step 6:	400 Hz	88 dBrn	92 dBrn
		1000 Hz	89 dBrn	91 dBrn
		3000 Hz	84 dBrn	90 dBrn
		6000 Hz	74 dBrn	82 dBrn
5-7	<i>15 kHz Flat Filter</i>			
	Step 8:	400 Hz	88 dBrn	92 dBrn
		1000 Hz	89 dBrn	91 dBrn
		15,000 Hz	84 dBrn	90 dBrn
5-7	<i>Program Filter</i>			
	Step 10:	100 Hz	61 dBrn	67 dBrn
		500 Hz	81 dBrn	85 dBrn
		1000 Hz	88 dBrn	92 dBrn
		2000 Hz	92 dBrn	98 dBrn
		7000 Hz	92 dBrn	100 dBrn
	10000 Hz	76 dBrn	86 dBrn	

Table 1

Operation Verification Test Record

Page No.	Test Description	Result		
		Min	Actual	Max
5-8	<i>50 kBit Filter</i>			
	Step 12:	50 Hz	85 dBrn	90 dBrn
		1000 Hz	89 dBrn	91 dBrn
		15000 Hz	87 dBrn	91 dBrn
		25000 Hz	86 dBrn	90 dBrn
		50000 Hz		69 dBrn
5-9	<i>Impulse Noise</i>			
	Step 7:	Low Count	432	528
	Step 8:	Mid Count	432	528
	Step 9:	High Count	432	528
5-42	<i>Noise to Ground Accuracy</i>			
	Step 4:	65.17 V	127 dBrn	130 dBrn
	Step 5:	8.2049 V	109 dBrn	112 dBrn
		0.8205 V	89 dBrn	92 dBrn
		82.049 mV	69 dBrn	72 dBrn
		9.2061 mV	50 dBrn	53 dBrn
5-43	<i>Peak to Average Ratio</i>			
	Step 3:	-23 dBm	98	102
	Step 4:	-20 dBm	98	102
		-40 dBm	98	102
5-10	<i>Loss of Holding Tone</i>			
Step 4:	Err 7 displayed			



Table 1 **Operation Verification Test Record**

Page No.	Test Description	Result		
		<i>Min</i>	<i>Actual</i>	<i>Max</i>
5-12	<i>Hold Current</i> Step 6: Current nominally 26 mA			

Performance Tests

The following procedures check the electrical performance of the HP 4934A to the specifications listed in Chapter 3.

If any of the following tests fail, carry out the adjustments described in Chapter 5 of the Service Manual. If this fails to correct the problem, refer to the troubleshooting section in Chapter 8 of the Service Manual or return the instrument to the nearest HP Service Office.

Transmitter Frequency Accuracy

SPECIFICATION

Frequency Range : 20 Hz to 110 kHz
Frequency Accuracy : 20 Hz to 99,999 kHz \pm 0.005%
: 100 kHz to 110 kHz \pm 0.012%

DESCRIPTION

A Frequency Counter is used to check the accuracy and range of the HP 4934A transmitter.

EQUIPMENT

Frequency Counter : HP 5315A

PROCEDURE

- 1 Set the HP 4934A as follows:

Measurement : LEVEL FREQ
Transmitter (TRMT) Impedance : 600 Ω
Display Mode : TRMT
Transmitter Output Level/Frequency : 0 dBm/20 Hz

- 2 Connect the HP 4934A TRMT port to the Frequency Counter input.
- 3 Check the reading on the Frequency Counter is between 19.999 and 20.001 Hz.
- 4 Set the HP 4934A transmitter frequency to each of the values in the following table and check the Frequency Counter reading.

Transmitter Frequency	Frequency Counter Reading
1000 Hz	999.95 to 1000.05 Hz
10,000 Hz	9,999.5 to 10000.5 Hz
50,000 Hz	49,997.5 to 50002.5 Hz
99,999 Hz	99,994 to 100,004 Hz
110,000 Hz	109,986.8 to 110,013.2 Hz

Transmitter Level Range

SPECIFICATION

Level Range: -40 dBm to +13 dBm

DESCRIPTION

An AC Voltmeter and a 600 Ω resistor are used to check the level range of the HP 4934A transmitter.

EQUIPMENT

AC Voltmeter : HP 3456A
600 Ω \pm 0.01% Resistor : HP 0811-3502

PROCEDURE

- 1 Connect the 600 Ω resistor across the AC Voltmeter input.
- 2 Connect the HP 4934A TRMT port to the AC Voltmeter input.
- 3 Set the HP 4934A as follows:

Measurement	: LEVEL FREQ
Transmitter (TRMT) Impedance	: 600 Ω
Display Mode	: TRMT
Transmitter Frequency	: 1004 Hz
- 4 Set the HP 4934A transmitter output level to a maximum by turning the OUTPUT LEVEL control fully clockwise. The reading on the AC Voltmeter should be greater than 3.42 V.
- 5 Set the HP 4934A transmitter output level to a minimum by turning the OUTPUT LEVEL control fully counter-clockwise. The reading on the AC Voltmeter should be less than 0.00775 V.

Transmitter Level Accuracy

SPECIFICATION

Level Accuracy (at 1004 Hz): -19 dBm to 0 dBm \pm 0.1 dB (typical)

DESCRIPTION

An AC Voltmeter and 600 Ω resistor are used to check the HP 4934A transmitter output level accuracy at 1004 Hz.

EQUIPMENT

AC Voltmeter : HP 3456A
600 Ω \pm 0.01% Resistor : HP 0811-3502

PROCEDURE

- 1 Connect the 600 Ω resistor across the AC Voltmeter input.
- 2 Connect the HP 4934A TRMT port to the AC Voltmeter input.
- 3 Set the HP 4934A as follows:

Measurement	: LEVEL FREQ
Transmitter (TRMT) Impedance	: 600 Ω
Display Mode	: TRMT
Transmitter Level/Frequency	: 0 dBm/1004 Hz
- 4 Check the reading on the AC Voltmeter is between 0.7657 and 0.7836 V.
- 5 Set the HP 4934A transmitter output level to each of the values in the following table and check the AC Voltmeter readings.

HP 4934A Output Level	AC Voltmeter Reading
-5 dBm	0.4306 to 0.4406V
-10 dBm	0.2421 to 0.2478V
-19 dBm	0.0859 to 0.0879V

Transmitter Flatness at +10 dBm

SPECIFICATION

Transmitter Flatness	20 Hz to 200 Hz	: ±1.0 dB
	200 Hz to 15 kHz	: ±0.2 dB
	15 kHz to 85 kHz	: ±0.5 dB

DESCRIPTION

An AC Voltmeter and 600Ω resistor are used to check the HP 4934A transmitter flatness at +10 dBm over the frequency range 20 Hz to 85 kHz.

EQUIPMENT

AC Voltmeter	: HP 3456A
600Ω ±0.01% Resistor	: HP 0811-3502

PROCEDURE

- 1 Connect the 600Ω resistor across the AC Voltmeter input.
- 2 Connect the HP 4934A TRMT port to the AC Voltmeter input.
- 3 Set the HP 4934A as follows:

Measurement	: LEVEL FREQ
Transmitter (TRMT) Impedance	: 600Ω
Display Mode	: TRMT
Transmitter Frequency	: 1004 Hz
- 4 Adjust the HP 4934A transmitter output level until a reading of 2.4495 V is obtained on the AC Voltmeter.
- 5 Set the HP 4934A transmitter frequency to each of the values in the following table and check the AC Voltmeter readings.

Transmitter Flatness at -40 dBm

SPECIFICATION

Transmitter Flatness	20 Hz to 200 Hz	: ±1.0 dB
	200 Hz to 15 kHz	: ±0.2 dB
	15 kHz to 85 kHz	: ±0.5 dB

DESCRIPTION

An AC Voltmeter, AC Calibrator and 20 dB Amplifier are used to check the HP 4934A transmitter flatness at -40 dBm over the frequency range 20 Hz to 85 kHz.

The 20 dB Amplifier is required to increase the -40 dBm level to within the specified range of the AC Voltmeter. The amplifier provides a 600Ω termination and is powered from a separate DC Power Supply.

If a high input impedance amplifier is used, a 600Ω termination is required.

Variations in the gain of the 20 dB Amplifier are compensated for at each of the test frequencies in the following procedure.

EQUIPMENT

AC Voltmeter	: HP 3456A
AC Calibrator	: DATRON 4707A
20 dB Amplifier	: SA1 (see Appendix A)
Dual Output DC Power Supply	: HP 6234A

PROCEDURE

CAUTION

Ensure that the AC Calibrator OUTPUT is switched off or set to the minimum level before proceeding with the following procedure.

1 Connect the equipment as shown in the following figure:

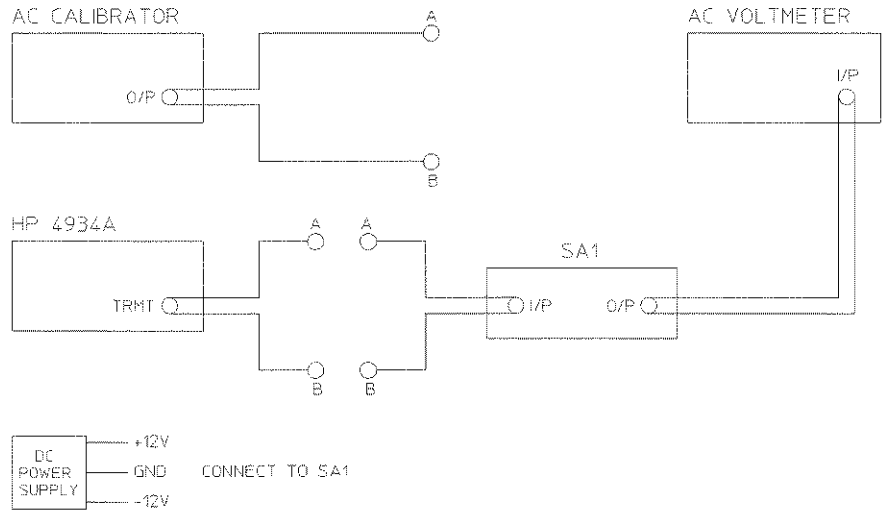

- 2 Set the SA1 gain to 20 dB and filter to **FLAT**.
- 3 Set the AC Calibrator to 7.746 mV at 1000 Hz then switch on the OUTPUT.
- 4 Connect the AC Calibrator output to the input of SA1 and the SA1 output to the AC Voltmeter input.
- 5 Note the reading on the AC Voltmeter.
- 6 Set the HP 4934A as follows:

Measurement	: LEVEL FREQ
Transmitter (TRMT) Impedance	: 600Ω
Display Mode	: TRMT
Transmitter Frequency	: 1000 Hz
- 7 Disconnect the AC Calibrator from the input of SA1.
- 8 Connect the HP 4934A TRMT port to the input of SA1.
- 9 Adjust the HP 4934A transmitter output level until the reading on the AC Voltmeter is the same as that noted in step 5.

NOTE

Do not change the HP 4934A transmitter output level or the AC Calibrator output level during the remainder of this procedure.

- 10** Adjust the HP 4934A transmitter frequency to each of the values in the table on Pages 5-27 to 5-29. Note the reading on the AC Voltmeter at each frequency.
- 11** Reconnect the AC Calibrator to SA1.
- 12** Adjust the AC Calibrator frequency to each of the values in the table on Pages 5-27 to 5-29. Note the reading on the AC Voltmeter at each frequency.
- 13** Use the AC Voltmeter readings and the table on Pages 5-27 to 5-29 to check the flatness. This is best explained by the following example:
If the frequency is 20 Hz, and the AC Voltmeter reading in step 12 were 71.0 mV
- Look up 71 mV in the V_{out} column, then check the 20 Hz column for the allowable voltage range when the HP 4934A is connected to the AC Voltmeter. If the reading in step 10 is within the 79.7 to 63.3 mV range, the 20 Hz check would be good.

V_{out} (in mV)	$\pm 1\text{dB}$ at 20 Hz and 50 Hz	$\pm 0.2\text{ dB}$ at 200 Hz and 15 kHz	$\pm 0.5\text{ dB}$ at 60 kHz and 85 kHz
65.0	72.9 to 57.9	66.5 to 63.5	68.9 to 61.4
65.4	73.4 to 58.3	66.9 to 63.9	69.3 to 61.7
65.8	73.8 to 58.6	67.3 to 64.3	69.7 to 62.1
66.2	74.3 to 59.0	67.7 to 64.7	70.1 to 62.5
66.6	74.7 to 59.4	68.2 to 65.1	70.5 to 62.9
67.0	75.2 to 59.7	68.6 to 65.5	71.0 to 63.3
67.4	75.6 to 60.1	69.0 to 65.9	71.4 to 63.6
67.8	76.1 to 60.4	69.4 to 66.3	71.8 to 64.0
68.2	76.5 to 60.8	69.8 to 66.6	72.2 to 64.4
68.6	77.0 to 61.1	70.2 to 67.0	72.7 to 64.8
69.0	77.4 to 61.5	70.6 to 67.4	73.1 to 65.1
69.4	77.9 to 61.9	71.0 to 67.8	73.5 to 65.5
69.8	78.3 to 62.2	71.4 to 68.2	73.9 to 65.9
70.2	78.8 to 62.6	71.8 to 68.6	74.4 to 66.3
70.6	79.2 to 62.9	72.2 to 69.0	74.8 to 66.7
71.0	79.7 to 63.3	72.7 to 69.4	75.2 to 67.0
71.4	80.1 to 63.6	73.1 to 69.8	75.6 to 67.4
71.8	80.6 to 64.0	73.5 to 70.2	76.1 to 67.8
72.2	81.0 to 64.3	73.9 to 70.6	76.5 to 68.2
72.6	81.5 to 64.7	74.3 to 70.9	76.9 to 68.5
73.0	81.9 to 65.1	74.7 to 71.3	77.3 to 68.9
73.4	82.4 to 65.4	75.1 to 71.7	77.7 to 69.3
73.8	82.8 to 65.8	75.5 to 72.1	78.2 to 69.7
74.2	83.3 to 66.1	75.9 to 72.5	78.6 to 70.0
74.6	83.7 to 66.5	76.3 to 72.9	79.0 to 70.4

V_{out} (in mV)	$\pm 1\text{dB}$ at 20 Hz and 50 Hz	$\pm 0.2\text{ dB}$ at 200 Hz and 15 kHz	$\pm 0.5\text{ dB}$ at 60 kHz and 85 kHz
75.0	84.2 to 66.8	76.7 to 73.3	79.4 to 70.8
75.4	84.6 to 67.2	77.2 to 73.7	79.9 to 71.2
75.8	85.0 to 67.6	77.6 to 74.1	80.3 to 71.6
76.2	85.5 to 67.9	78.0 to 74.5	80.7 to 71.9
76.6	85.9 to 68.3	78.4 to 74.9	81.1 to 72.3
77.0	86.4 to 68.6	78.8 to 75.2	81.6 to 72.7
77.4	86.8 to 69.0	79.2 to 75.6	82.0 to 73.1
77.8	87.3 to 69.3	79.6 to 76.0	82.4 to 73.4
78.2	87.7 to 69.7	80.0 to 76.4	82.8 to 73.8
78.6	88.2 to 70.1	80.4 to 76.8	83.3 to 74.2
79.0	88.6 to 70.4	80.8 to 77.2	83.7 to 74.6
79.4	89.1 to 70.8	81.2 to 77.6	84.1 to 75.0
79.8	89.5 to 71.1	81.7 to 78.0	84.5 to 75.3
80.2	90.0 to 71.5	82.1 to 78.4	85.0 to 75.7
80.6	90.4 to 71.8	82.5 to 78.8	85.4 to 76.1
81.0	90.9 to 72.2	82.9 to 79.2	85.8 to 76.5
81.4	91.3 to 72.5	83.3 to 79.5	86.2 to 76.8
81.8	91.8 to 72.9	83.7 to 79.9	86.6 to 77.2
82.2	92.2 to 73.3	84.1 to 80.3	87.1 to 77.6
82.6	92.7 to 73.6	84.5 to 80.7	87.5 to 78.0
83.0	93.1 to 74.0	84.9 to 81.1	87.9 to 78.4
83.4	93.6 to 74.3	85.3 to 81.5	88.3 to 78.7
83.8	94.0 to 74.7	85.8 to 81.9	88.8 to 79.1
84.2	94.5 to 75.0	86.2 to 82.3	89.2 to 79.5
84.6	94.9 to 75.4	86.6 to 82.7	89.6 to 79.9

V_{out} (in mV)	$\pm 1\text{dB}$ at 20 Hz and 50 Hz	$\pm 0.2\text{ dB}$ at 200 Hz and 15 kHz	$\pm 0.5\text{ dB}$ at 60 kHz and 85 kHz
85.0	95.4 to 75.8	87.0 to 83.1	90.0 to 80.2
85.4	95.8 to 76.1	87.4 to 83.5	90.5 to 80.6
85.8 86.2	96.3 to 76.5	87.8 to 83.8	90.9 to 81.0
86.6	96.7 to 76.8 97.2 to 77.2	88.2 to 84.2 88.6 to 84.6	91.3 to 81.4 91.7 to 81.8
87.0	97.6 to 77.5	89.0 to 85.0	92.2 to 82.1
87.4	98.1 to 77.9	89.4 to 85.4	92.6 to 82.5
87.8	98.5 to 78.3	89.8 to 85.8	93.0 to 82.9
88.2	99.0 to 78.6	90.3 to 86.2	93.4 to 83.3
88.6	99.4 to 79.0	90.7 to 86.6	93.8 to 83.6
89.0	99.9 to 79.3	91.1 to 87.0	94.3 to 84.0
89.4	100.3 to 79.7	91.5 to 87.4	94.7 to 84.4
89.8	100.8 to 80.0	91.9 to 87.8	95.1 to 84.8
90.2	101.2 to 80.4	92.3 to 88.1	95.5 to 85.2
90.6	101.7 to 80.7	92.7 to 88.5	96.0 to 85.5
91.0	102.1 to 81.1	93.1 to 88.9	96.4 to 85.9
FACTOR	1.12202 to .89125	1.02329 to .97724	1.05925 to .94406

Receiver Frequency Range/Accuracy

SPECIFICATION

Frequency Range : 20 Hz to 110 kHz
Frequency Accuracy : 20 Hz to 9.999 kHz 0.5 Hz
: 10 kHz to 110 kHz 5 Hz

DESCRIPTION

An AC Calibrator and Frequency Counter are used to check the HP 4934A receiver range and accuracy.

EQUIPMENT

AC Calibrator : DATRON 4707A
Frequency Counter : HP 5315A

PROCEDURE

CAUTION

Ensure that the AC Calibrator OUTPUT is switched off or set to the minimum level before proceeding with the following procedure.

- 1 Connect the equipment as shown in the following figure:

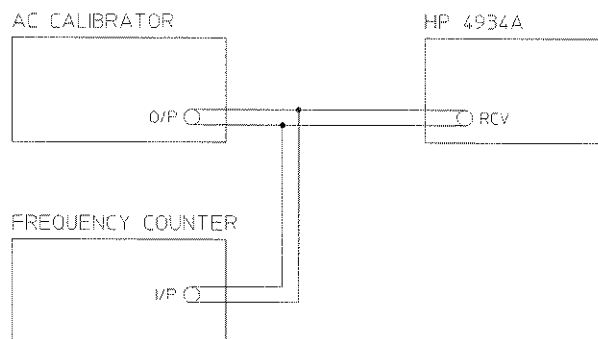

- 2 Set the AC Calibrator output level to 0.7746 V then switch on the OUTPUT. Set the AC Calibrator frequency to 20 Hz as observed on the Frequency Counter.



3 Set the HP 4934A as follows:

Measurement : LEVEL FREQ
Receiver (RCV) Impedance : 600Ω
Display Mode : RCV

4 Check the HP 4934A receiver frequency reading is between 19 Hz and 21 Hz.

5 Set the AC Calibrator frequency to each of the values given in the following table (as observed on the Frequency Counter) and check the HP 4934A receiver frequency reading.

AC Calibrator Frequency	HP 4934A Receiver Reading
1,000 Hz	999 to 1001 Hz
10,000 Hz	9,995 to 10,005 Hz
50,000 Hz	49.99 to 50.01 kHz
100,000 Hz	99.99 to 100.01 kHz
110,000 Hz	109.99 to 110.01 kHz

Receiver Level Accuracy

SPECIFICATION

Input Level: -40 dBm to +13 dBm

Frequency Range	20 Hz to 50 Hz	: ±1 dB
	50 Hz to 200 Hz	: ±0.5 dB
	200 Hz to 15 kHz	: ±0.2 dB
	15 kHz to 85 kHz	: ±0.5 dB

Level Accuracy (at 1004 Hz): -20 to +10 dBm ±0.1 dB

DESCRIPTION

An AC Calibrator is used to check the HP 4934A receiver level accuracy.

EQUIPMENT

AC Calibrator : DATRON 4707A

PROCEDURE

CAUTION

Ensure that the AC Calibrator OUTPUT is switched off or set to the minimum level before proceeding with the following procedure.

- 1 Connect the AC Calibrator output to the HP 4934A RCV port.
- 2 Set the HP 4934A as follows:

Measurement	: LEVEL FREQ
Receiver (RCV) Impedance	: 600Ω
Display Mode	: RCV
- 3 Set the AC Calibrator output level to 2.4495 V at 1000 Hz then switch on the OUTPUT.
- 4 Check the HP 4934A receiver level reading is between 9.9 and 10.1 dBm.
- 5 Set the AC Calibrator output level to 77.46 mV.



- 6 Check the HP 4934A receiver level reading is between -20.1 and -19.9 dBm.
- 7 Set the AC Calibrator output level to 2.748 V at 20 Hz.
- 8 Check the HP 4934A receiver level reading is between 10 and 12 dBm.
- 9 Set the AC Calibrator to each of the frequencies in the following table and check the HP 4934A receiver level readings.

AC Calibrator Frequency	HP 4934A Receiver Level
50 Hz	10.5 to 11.5 dBm
200 Hz	10.8 to 11.2 dBm
15,000 Hz	10.8 to 11.2 dBm
85,000 Hz	10.5 to 11.5 dBm

- 10 Set the AC Calibrator output level to 7.746 mV at 20 Hz.
- 11 Check the HP 4934A receiver level reading is between -41 and -39 dBm.
- 12 Set the AC Calibrator to each of the frequencies in the following table and check the HP 4934A receiver level readings.

AC Calibrator Frequency	HP 4934A Receiver Level
50 Hz	-40.5 to -39.5 dBm
200 Hz	-40.2 to -39.8 dBm
15,000 Hz	-40.2 to -39.8 dBm
85,000 Hz	-40.5 to -39.5 dBm

Message Circuit Noise Accuracy

SPECIFICATION

TRANSMITTER: Quiet Terminated

RECEIVER

Filters: C-Message, 3 kHz Flat, 15 kHz Flat, Program and 50 kBit

Range 600, 900 and 1200 Ω : 0 to 100 dBrn
 135 and 150 Ω : 7 to 100 dBrn

Accuracy : 10 dBrn to 100 dBrn ± 1 dBrn
 : 0 dBrn to 10 dBrn ± 3 dBrn

DESCRIPTION

The Message Circuit Noise accuracy is checked using an AC Calibrator and Decade Transformer. The Decade Transformer attenuates a test signal from the AC Calibrator.

EQUIPMENT

AC Calibrator : DATRON 4707A
Decade Transformer : Model DT72A DEKATRAN

PROCEDURE

CAUTION

Ensure that the AC Calibrator OUTPUT is switched off or set to the minimum level before proceeding with the following procedure.

- 1 Connect the equipment as shown in the following figure:

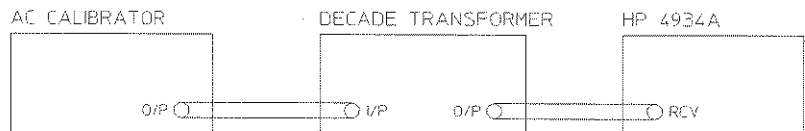



2 Set the HP 4934A as follows:

Measurement : NOISE
Filter : C-MSG
Display Mode : RCV
Receiver (RCV) Impedance : 600Ω

3 Set the AC Calibrator output level to 2.1831 V at 1000 Hz then switch on the OUTPUT.

4 Set the Decade Transformer to 1.0000000.

5 Check the message circuit noise reading on the HP 4934A is between 98 and 100 dBrn.

6 Set the AC Calibrator output level to 0.7746 V.

7 Check the reading on the HP 4934A is between 89 and 91 dBrn.

8 Set the Decade Transformer to each of the settings listed in the following table and check the HP 4934A noise reading.

Decade Transformer Settings	(dB)	HP 4934A Noise Reading
0.3162278	(-10)	79 to 81 dBrn
0.1000000	(-20)	69 to 71 dBrn
0.0316228	(-30)	59 to 61 dBrn
0.0100000	(-40)	49 to 51 dBrn
0.0031623	(-50)	39 to 41 dBrn
0.0010000	(-60)	29 to 31 dBrn
0.0003162	(-70)	19 to 21 dBrn
0.0001000	(-80)	9 to 11 dBrn
0.0000562	(-85)	2 to 8 dBrn

Notch Filter Rejection

SPECIFICATION

Rejection (995 to 1025 Hz): >50 dB

DESCRIPTION

An AC Calibrator is used to check the HP 4934A Notch Filter rejection.

EQUIPMENT

AC Calibrator : DATRON 4707A

PROCEDURE

CAUTION

Ensure that the AC Calibrator OUTPUT is switched off or set to the minimum level before proceeding with the following procedure.

- 1 Connect the AC Calibrator output to the HP 4934A RCV port.
- 2 Set the HP 4934A as follows:

Measurement	: NOISE W TONE
Filter	: C-MSG
Receiver (RCV) Impedance	: 600 Ω
Display Mode	: RCV
- 3 Set the AC Calibrator output level to 0.7746 V at 995 Hz then switch on the OUTPUT.
- 4 Check the reading on the HP 4934A is less than 40 dB_{rn}.
- 5 Set the AC Calibrator to each of the frequencies in the following table and check the HP 4934A noise readings.

AC Calibrator Frequency	HP 4934A Noise Reading
1004 Hz	<40 dB _{rn}
1015 Hz	<40 dB _{rn}
1025 Hz	<40 dB _{rn}



Signal to Noise Ratio Accuracy

SPECIFICATION

TRANSMITTER

Holding Tone Frequency : 1004 Hz fixed tone
Other Specifications : See LEVEL FREQ in the Specifications in Chapter 3.

RECEIVER

Filters: C-Message, 3 kHz Flat, 15 kHz Flat, Program and 50 kBit (all + Notch Filter)

Signal Level Range 600, 900 and 1200Ω : -40 to +10 dBm
Signal to Noise Ratio Range (Signal Level >-30 dBm) : 10 to 45 dB
Signal to Noise Ratio Accuracy : 10 to 40 dB±1 dB
: 40 to 45 dB±2 dB

DESCRIPTION

A Synthesizer and Power Adder (SA2) are used to check the Signal to Noise Ratio accuracy. Signal to Noise Ratio is the amplitude ratio of the holding tone to the background noise. An 1800 Hz tone is used to simulate the noise and is added to the HP 4934A 1004 Hz holding tone using the Power Adder.

EQUIPMENT

Synthesizer : HP 3336B
Power Adder : SA2 (see Appendix B)

NOTE

Do not use an AC Calibrator in place of a Synthesizer with a 600Ω balanced output or errors will occur.

PROCEDURE

- 1 Connect the equipment as shown in the following figure:

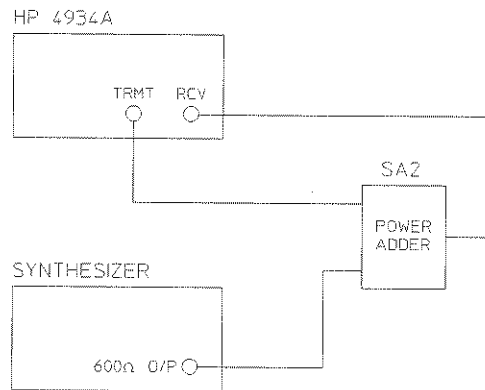

- 2 Set the HP 4934A as follows:

Measurement	: SIG TO NOISE
Filter	: 15 kHz FLAT
Transmitter (TRMT) Impedance	: 600Ω
Receiver (RCV) Impedance	: 600Ω
Display Mode	: TRMT
Transmitter Level	: +10 dBm

- 3 Set the Synthesizer output level to 0 dBm at 1800 Hz.
- 4 Set the HP 4934A Display Mode to RCV, then check the signal to noise ratio reading on the display is 10 dB \pm 1 dB.
- 5 Set the Synthesizer output level to each of the values in the following table and check the noise reading on the HP 4934A.

Synthesizer Level	HP 4934A Noise Reading
-10 dBm	20 dB \pm 1 dB
-20 dBm	30 dB \pm 1 dB
-30 dBm	40 dB \pm 1 dB
-35 dBm	45 dB \pm 2 dB



Impulse Noise Threshold Accuracy

SPECIFICATION

RECEIVER

Level Range	: -40 to +10 dBm
Range - Low Threshold	: 30 to 109 dBm
Mid Threshold	: 34 to 109 dBm
High Threshold	: 38 to 109 dBm
Threshold Accuracy	: > 40 dBm \pm 3 dB, >50 dBm \pm 1 dB

DESCRIPTION

An AC Calibrator is used to verify the Low, Mid and High impulse noise thresholds.

EQUIPMENT

AC Calibrator : DATRON 4707A

CAUTION

Ensure that the AC Calibrator OUTPUT is switched off or set to the minimum level before proceeding with the following procedure.

PROCEDURE

- 1 Connect the AC Calibrator output to the HP 4934A RCV input.
- 2 Set the AC Calibrator output level to 1.732 mV at 1000 Hz then switch on the OUTPUT.

Low Threshold Check

- 3 Set the HP 4934A as follows:

Measurement	: IMPULSE NOISE
Receiver (RCV) Impedance	: 600 Ω
Display Mode	: RCV
Filter	: 15 kHz FLAT
Period	: NON-STOP

- 4 Set the Impulse Noise LOW (SET) threshold to 43 dBrn.
- 5 Start the measurement by pressing **START RESET**; the displayed count should remain at zero.
- 6 Slowly increase the AC Calibrator output level until the HP 4934A starts counting; the AC Calibrator level should be less than 3.456 mV.
- 7 Press **STOP** to stop the low threshold check.
Mid Threshold Check
- 8 Set the AC Calibrator output level to 2.745 mV.
- 9 Select the Mid threshold using the HP 4934A Impulse Noise **DISPLAY** key.
- 10 Press **START RESET** to start the measurement; the displayed count should remain at zero.
- 11 Slowly increase the AC Calibrator output level until the HP 4934A starts counting; the AC Calibrator level should be less than 5.477 mV.
- 12 Press **STOP** to stop the Mid threshold check.
High Threshold Check
- 13 Set the AC Calibrator output level to 5.477 mV.
- 14 Select the HIGH threshold using the HP 4934A Impulse Noise **DISPLAY** key.
- 15 Press the **START RESET** key; the displayed count should remain at zero.
- 16 Slowly increase the AC Calibrator output level until the HP 4934A starts counting; the AC Calibrator level should be less than 6.895 mV.
- 17 Press **STOP** to stop the high threshold check.
- 18 Repeat the above procedure for each of the LOW (SET) threshold settings listed in the following table:

HP 4934A Settings	Low Check		Mid Check		High Check	
	<i>Min</i>	<i>Max</i>	<i>Min</i>	<i>Max</i>	<i>Min</i>	<i>Max</i>
60 dBrn	15.455 mV	19.457 mV	24.495 mV	30.837 mV	38.822 mV	48.874 mV
80 dBrn	0.1546 V	0.1946 V	0.2449 V	0.3084 V	0.3882 V	0.4887 V
100 dBrn	1.5455 V	1.9457 V	2.4495 V	3.0837 V	3.8822 V	4.8874 V



Noise to Ground Accuracy

SPECIFICATION

TRANSMITTER: Quiet terminated

RECEIVER

Filters: C-Message, 3 kHz Flat, 15 kHz Flat, Program and 50 kBit

Range 600, 900 and 1200Ω : 50 to 130 dBm

Accuracy: ±1.5 dB

DESCRIPTION

A common mode signal from an AC Calibrator is used to check the Noise to Ground accuracy.

EQUIPMENT

AC Calibrator : DATRON 4707A

WECO 310 Connector : HP 1251-0695

PROCEDURE

WARNING

Hazardous voltages are present during this procedure - only service trained personnel, aware of the hazards involved, should perform the test.

CAUTION

Ensure that the AC Calibrator OUTPUT is switched off or set to the minimum level before proceeding with the following procedure.

1 Connect the equipment as shown in the following figure:

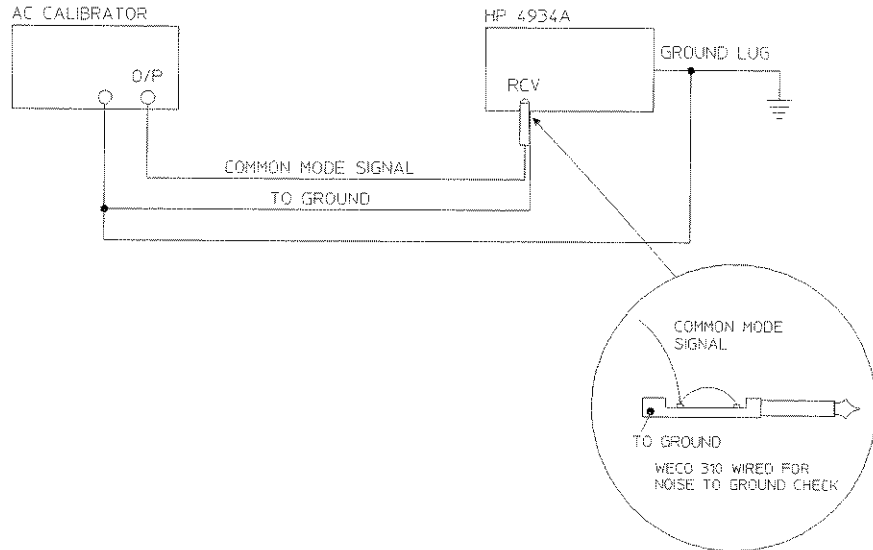

2 Set the HP 4934A as follows:

Measurement	: N.T. GND
Transmitter (TRMT) Impedance	: 600Ω
Receiver (RCV) Impedance	: 600Ω
Display Mode	: RCV
Filter	: C-MSG

3 Set the AC Calibrator output level to 65.17 V at 1000 Hz then switch on the OUTPUT.

4 Check the reading on the HP 4934A display is between 127 and 130 dBm.

5 Set the AC Calibrator output level to each of the values in the following table and check the N.T. GND reading on the HP 4934A display.

AC Calibrator Setting	N.T. GND Reading
8.2049 V	109 dBm to 112 dBm
0.8205 V	89 dBm to 92 dBm
82.049 V	69 dBm to 72 dBm
9.2061 V	50 dBm to 53 dBm

Peak to Average Ratio (P/AR) Accuracy

SPECIFICATION

TRANSMITTER

Signal Spectrum : 16 Frequencies 140 Hz to 3890 Hz

Level : -40 to 0 dBm

Level Resolution : 1 dB

RECEIVER

P/AR Range : 0 to 120 P/AR Units

Resolution : 1 P/AR Unit

Accuracy : 30 to 110 P/AR Units ± 2 P/AR Units

PROCEDURE

1 Connect the HP 4934A TRMT port to the RCV port using a short cable.

2 Set the HP 4934A as follows:

Measurement	: P/AR
Transmitter (TRMT) Impedance	: 600 Ω
Receiver (RCV) Impedance	: 600 Ω
Display Mode	: TRMT
Transmitter Level	: -23 dBm

3 Set the Display Mode to RCV. Check the reading on the HP 4934A display is between 98 and 102 P/AR Units.

4 Set the transmitter level to each of the values in the following table and check the P/AR readings in the RCV display mode.

Output Level	P/AR Reading
-20 dBm	98 to 102 P/AR Units
-40 dBm	98 to 102 P/AR Units

Hewlett-Packard Model 4934A Transmission Impairment Measuring Set

Location: _____ *Serial No.:* _____

Tested by: _____

Temperature: _____ *Certified by:* _____

Humidity: _____ *Date:* _____

Table 2 Performance Test Record

Page No.	Test Description	Result		
		<i>Min</i>	<i>Actual</i>	<i>Max</i>
5-19	<i>Transmitter Frequency Accuracy</i>			
	Step 3: 20 Hz	19.999 Hz		20.001 Hz
	Step 4: 1000 Hz	999.95 Hz		1000.05 Hz
	10,000 Hz	9,999.5 Hz		10,000.5 Hz
	50,000 Hz	49,997.5 Hz		50,002.5 Hz
	100,000 Hz	99,994 Hz		100,004 Hz
5-20	<i>Transmitter Level Range</i>			
	Step 4: Fully clockwise	3.42 V		
	Step 5: Fully anti-clockwise			0.00775V
5-21	<i>Transmitter Level Accuracy</i>			
	Step 4: 0 dBm	0.7657 V		0.7836 V
	Step 5: -5 dBm	0.4306 V		0.4406 V
	-10 dBm	0.2421 V		0.2478 V
	-19 dBm	0.0859 V		0.0879 V

Table 2

Performance Test Record

Page No.	Test Description	Result		
		Min	Actual	Max
5-22	<i>Transmitter Flatness at 10 dBm</i>			
	Step 5:	20 Hz	2.1831 V	2.7484 V
		200 Hz	2.3937 V	2.5065 V
		5,000 Hz	2.3937 V	2.5065 V
		15,000 Hz	2.3937 V	2.5065 V
		30,000 Hz	2.3125 V	2.5946 V
		85,000 Hz	2.3125 V	2.5946 V
5-24	<i>Transmitter Flatness at -40 dBm</i>			
		20 Hz to 200 Hz: ± 1.0 dB		
		200 Hz to 15 kHz: ± 0.2 dB		
		15 kHz to 85 kHz: ± 0.5 dB		
5-30	<i>Receiver Frequency Range and Accuracy</i>			
	Step 4:	20 Hz	19 Hz	21 Hz
	Step 5:	1000 Hz	999 Hz	1001 Hz
		10,000 Hz	9,995 Hz	10,005 Hz
		50,000 Hz	49.99 kHz	50.01 kHz
		100,000 Hz	99.99 kHz	100.01 kHz
		110,000 Hz	109.99 kHz	110.01 kHz
5-32	<i>Receiver Level Accuracy</i>			
	Step 4:	1000 Hz	9.9 dBm	10.1 dBm
	Step 6:		-20.1 dBm	-19.9 dBm
	Step 8:	20 Hz	10 dBm	12 dBm

Table 2

Performance Test Record

Page No.	Test Description	Result		
		<i>Min</i>	<i>Actual</i>	<i>Max</i>
	<i>Receiver Level Accuracy (cntd)</i>			
	Step 9: 50 Hz	10.5 dBm		11.5 dBm
	200 Hz	10.8 dBm		11.2 dBm
	15,000 Hz	10.8 dBm		11.2 dBm
	85,000 Hz	10.5 dBm		11.5 dBm
	Step 11: 20 Hz	-41 dBm		-39 dBm
	Step 12: 50 Hz	-40.5 dBm		-39.5 dBm
	200 Hz	-40.2 dBm		-39.8 dBm
	15,000 Hz	-40.2 dBm		-39.8 dBm
	85,000 Hz	-40.5 dBm		-39.5 dBm
	<i>Message Circuit Noise Accuracy</i>			
5-35	Step 5:	98 dBrn		100 dBrn
	Step 7:	89 dBrn		91 dBrn
	Step 8:	79 dBrn		81 dBrn
		69 dBrn		71 dBrn
		59 dBrn		61 dBrn
		49 dBrn		51 dBrn
		39 dBrn		41 dBrn
		29 dBrn		31 dBrn
		19 dBrn		21 dBrn
		9 dBrn		11 dBrn
		2 dBrn		8 dBrn

Table 2

Performance Test Record

Page No.	Test Description	Result		
		Min	Actual	Max
5-36	<i>Notch Filter Rejection</i>			
	Step 4: 995 Hz			40 dBrn
	Step 5 1004 Hz			40 dBrn
	1015 Hz			40 dBrn
5-38	<i>Signal to Noise Ratio Accuracy</i>			
	Step 4:	9 dB		11 dB
	Step 5:	19 dB		21 dB
		29 dB		31 dB
		39 dB		41 dB
5-40	<i>Impulse Noise Threshold Accuracy</i>			
	Step 6: Count starts at			3.456mV
	Step 11: Count starts at			5.477mV
	Step 16: Count starts at			6.895mV
	Step 18: 60 dBrn			
	Low	15.455 mV		19.457mV
	Mid	24.495 mV		30.837mV
	High	38.822 mV		48.874mV
	80 dBrn			
	Low	0.1546 V		0.1946V
Mid	0.2449 V		0.3084V	
High	0.3882 V		0.4887V	

Table 2

Performance Test Record

Page No.	Test Description	Result		
		Min	Actual	Max
5-42	<i>Impulse Noise Threshold Accuracy (cntd)</i>			
	<i>100 dBrn</i>			
	Low	1.5455 V		1.9457V
	Mid	2.4495 V		3.0837V
	High	3.8822 V		4.8874V
	<i>Noise to Ground Accuracy</i>			
	Step 4: 65.17 V	127 dBrn		130 dBrn
	Step 5: 8.2049 V	109 dBrn		112 dBrn
	0.8205 V	89 dBrn		92 dBrn
	82.049 mV	69 dBrn		72 dBrn
9.2061 mV	50 dBrn		53 dBrn	
5-43	<i>P/AR Accuracy</i>			
	Step 3: -23 dBm	98		102
	Step 4: -20 dBm	98		102
	-40 dBm	98		102

Software Downloading

Introduction

This chapter describes how to use a PC to download new operating software to the 4934A TMS.

The basic procedure for downloading software is as follows:

- Check the distribution diskette for “readme” files.
- Connect a PC to the 4934A using a serial cable.
- Put the 4934A into Download mode and set the baud rate.
- Execute the download command on the PC.

The following section describes the procedure in detail.

Quick Download Procedure

NOTE

Be sure to check the distribution diskette for any "readme" files which may contain additional information and instructions about the download procedure.

For 4934A pinout information, see *4934A TIMS Serial Port Pinout* in Chapter 7. For cable information, see *Cable Pinout* in Chapter 7.

Make sure your PC COM port is correctly set up to communicate with the 4934A

1. Switch off the 4934A and connect the unit to the PC from which you will download the software.
 - For a direct connection, use a straight-through RS-232 serial cable to connect the 4934A's serial port to a COM port on the PC.
 - For a dial-up connection (using modems), use a null-modem cable or adapter to connect the 4934A's serial port to the modem. Set up the far-end PC and modem as appropriate for your system.
2. Switch on the 4934A and promptly press the START RESET key during the start-up routine (while the serial number is being displayed).
When the unit is in Download mode, the left display shows + dl and the right display shows the installed software revision.
3. Use the RCV key to set the 4934A's baud rate for the download procedure. Each time you press RCV, the right display shows the currently selected baud rate. The baud rate for software download can be set to 1200, 2400, 9600, 19200, or 38400 (defaults to 9600 at power up).
4. At the PC, insert the distribution diskette into the A: or B: floppy drive.
5. From a DOS prompt, select the drive by typing A: (or B:) and then press return.
6. Next type DOWNLOAD and then press return.
7. Press a key to begin the download, or press Esc to cancel.

NOTE

If you interrupt the download program, the 4934A will be inoperable until a successful download is performed.

8. When the download is complete, the 4934A reboots. The software revision is displayed on the right display at start up.



You can type
DOWNLOAD /? to
get help with this
command.

Each software .OUT
file is keyed to
individual 4934A
serial numbers. A
particular copy of a
.OUT file may be
valid for only one or
several test sets,
depending on your
requirements.

About the DOWNLOAD Program

The DOWNLOAD.EXE executable file is included on the distribution diskette when you receive your operating software upgrade. While simply typing DOWNLOAD to execute the program is adequate for most applications, the DOWNLOAD program accepts several variables that modify its operation for special cases.

The full format for the download command is as follows:

```
DOWNLOAD filename.ext /Pn /In /Bnnn /Annn
```

The parts of the command are described below.

DOWNLOAD: The root command. Starts the software download process. If no parameters are specified the default values are used (see below) which is equivalent to typing DOWNLOAD /P1 /I4 /B38.4 /A3F8.

filename.ext: Selects the software file to be downloaded. Operating software files end with the extension .OUT. If no file is specified, the program downloads the first file in the working directory that has the .OUT extension. Distribution diskettes include only one software file, so it is rare that you would need to use the file name in the download command.

/Pn: Specifies the COM port to be used on the PC, where n is 1 through 4. For example /P3 selects COM3. If no port is specified, COM1 is used.

/In: Specifies the system interrupt request line (IRQ) for the COM port, where n is 1–7. For example /I4 selects IRQ 4. If no IRQ is specified, IRQ 4 is used for COM1 and COM3 and IRQ 3 is used for COM2 and COM4.

/Bnnn: Specifies the baud rate for the COM port, where nnnn is 1200, 4800, 9600, 19.2, or 38.4. For example /B19.2 sets the baud rate to 19.2 Kbaud. If no baud rate is specified, 38.4 Kbaud is used.

/Annn: Specifies the COM port's base address in hexadecimal notation, where each digit of nnn can be 0 through F. For example /A3F8 sets the base address for 3F8h. If no base address is specified the base addresses 3F8, 2F8, 3E8, and 2E8 are used for COM1 through COM4, respectively.

6-4 Software Downloading

Remote Control

Introduction

The 4934A TIMS can be controlled remotely through its RS-232 serial port. When connected to a controller, for example a PC running a terminal emulation program, the unit can be operated just as if the front-panel controls were being used.

The TIMS is operated using a set of control commands to set parameters, execute tests, and so forth. A set of query commands is used to retrieve measurements for display on the controller device.

The Serial Port

The serial port is on the 4934A's right side, above the AC connector. Your unit will have a serial port if a 200 kHz option is installed. This port is used for remote control (see page 7-1) and for downloading software (see *Software Downloading*, page 6-1).

Serial Port Type

The serial port is a DB-9S (9-pin socket) connector. The 4934A acts a DTE device; if you are connecting to a DCE device you can use a straight-through cable (see *Cable Pinout*, page 7-3). To connect another DTE device, a null-modem must be used. The pinout of the serial port is as follows:

4934A TIMS Serial Port Pinout

Pin Number	Functions	
1	No connection.	
2	TXD	Transmit data output.
3	RXD	Receive data input.
4	DSR	Data set ready input.
5	GND	Ground.
6	DTR	Data terminal ready output.
7	CTS	Clear to send input.
8	RTS	Request to send output.
9	No connection.	

The serial port uses the following communication parameters:

- 8 data bits
- No parity
- 1 stop bit
- Hardware flow control

Baud Rates

The serial port supports the following baud rates: 300, 1200, 2400, 9600, 19200, and 38400. Note that 38400 baud is only available for software downloading. The 4934A always defaults to 9600 baud at power up.

To change the baud rate for remote control, see *Setting the Baud Rate*, page 7-4. To change the baud rate for software downloading, see *Quick Download Procedure*, page 6-2.

7-2 Remote Control



Cable Pinout

The following table shows the pinouts for a straight-through 9-pin cable.
Straight-Through Cable

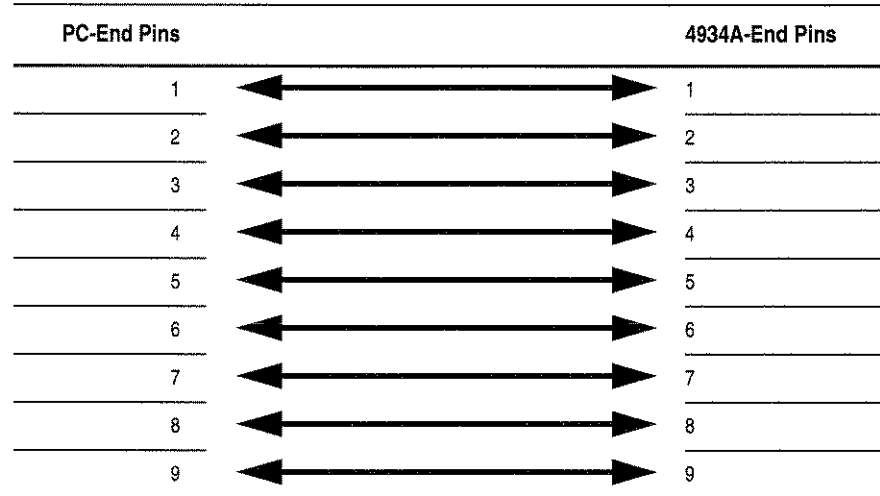

Null Modem

The following table shows the pinouts for a null modem cable. This is the cable to be used when a Vectra is being used as the controller.

Null-Modem Cable

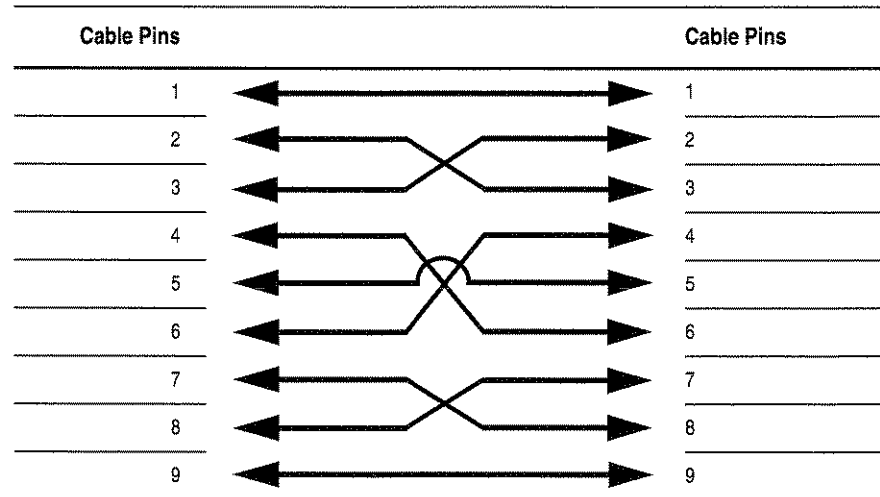

Setting up for Remote Control

Connecting the TIMS to a Controller

To connect the 4934A to a controller, use an appropriate serial cable from the unit's serial port (on the right side) to the serial port on the controller.

For 4934A pinout information, see *4934A TIMS Serial Port Pinout*, page 7-2.

For cable information, see *Cable Pinout*, page 7-3.

Setting the Baud Rate

To change the 4934A serial port baud rate for remote control operation first put the unit into LEVEL FREQ mode. Next press STORE followed by P/AR N.T. GND to cycle through the baud rate choices. The display shows bd in the left display and the current baud rate in the right display.

The baud rates available are 300, 1200, 2400, 9600, and 19200.

NOTE

The 4934A always resets to 9600 baud at power up.

The 4934A uses 8 data bits, no parity, 1 stop bit, and hardware flow control.

Activating Remote Mode

The 4934A enters remote control mode when it detects the RMT command at the serial input. While the unit is in remote mode, the front-panel controls are locked out (pressing any key displays a not local message).

Deactivating Remote Mode

The 4934A exits remote mode when it detects the LCL command at the serial port. The unit returns to normal operation. You can also deactivate remote operation by switching the unit off and then back on again.



Control Commands

Control commands change the 4934A's operation. Control commands emulate a front-panel key; sending a command is comparable to pressing the corresponding key. Another set of commands (query commands) retrieve results from the unit (see *Query Commands*, page 7-8).

When the 4934A accepts a command it returns **OK** to the controller. Unknown commands cause the unit to return **ERR**. Inappropriate commands are ignored.

HP 4934A TIMS Remote Control Commands

Command	Description
RESET	Resets unit to power on condition.
RMT	Puts unit into remote mode, disable front panel.
LCL	Returns unit to front-panel (local) control.
TRMT	Same as pressing the TRMT key.
RCV	Same as pressing the RCV key.
NORM	Sets input jacks to TRMT-RCV configuration (as with REVERSE key).
REV	Sets input jacks to RCV-TRMT configuration (as with REVERSE key).
T135	Sets Tx Impedance to 135 ohms (as with the TRMT key).
T150	Sets Tx Impedance to 150 ohms.
T600	Sets Tx Impedance to 600 ohms.
T900	Sets Tx Impedance to 900 ohms.
T1200	Sets Tx Impedance to 1200 ohms.
R135	Sets Rx Impedance to 135 ohms (as with the RCV key).
R150	Sets Rx Impedance to 150 ohms.
R600	Sets Rx Impedance to 600 ohms.
R900	Sets Rx Impedance to 900 ohms.
R1200	Sets Rx Impedance to 1200 ohms.

HP 4934A TMS Remote Control Commands, continued

Command	Description
DIALON	Sets DIAL key on.
DIALOFF	Sets DIAL key off.
TERM	Sets BRDG key off.
BRIDGE	Sets BRDG key on.
THOLDON	Sets the Tx HOLD key on.
THOLDOFF	Sets the Tx HOLD key off.
RHOLDON	Sets the Rx HOLD key on.
RHOLDOFF	Sets the Rx HOLD key off.
LF	Sets MEAS to LEVEL FREQ selection (as with the MEAS key).
NOISE	Sets MEAS to NOISE selection.
NWT	Sets MEAS to NOISE W TONE selection.
STN	Sets MEAS to SIG TO NOISE selection.
IMN	Sets MEAS to IMPULSE NOISE selection.
PAR	Sets MEAS to P/AR selection.
NTG	Sets MEAS to N.T.GND selection.
CMES	Sets FILTER to C-MSG selection (as with the FILTER key).
3K	Sets FILTER to 3 kHz FLAT selection.
15K	Sets FILTER to 15 kHz FLAT selection.
PROG	Sets FILTER to PRGM selection.
50KB	Sets FILTER to 50 kBIT selection.
5M	Sets Impulse Noise PERIOD to 5 MIN (as with PERIOD key).
15M	Sets Impulse Noise PERIOD to 15 MIN selection.
60M	Sets Impulse Noise PERIOD to 60 MIN selection.
CONT	Sets Impulse Noise PERIOD to NON-STOP selection.

HP 4934A TIMS Remote Control Commands, continued

Command	Description
LOW	Sets Impulse Noise DISPLAY to LOW (SET) selection.
MID	Sets Impulse Noise DISPLAY to MID selection.
HIGH	Sets Impulse Noise DISPLAY to HIGH selection.
TIMER	Sets Impulse Noise DISPLAY to TIMER selection.
START	Same as pressing the START RESET key.
STOP	Same as pressing the STOP key.
LEV nn.n	Acts as the OUTPUT LEVEL knob; sets level to <i>nn.n</i> dBm (range: -36 to 13 dBm)
FREQ nnnnnn	Acts as frequency selection buttons; sets frequency to <i>nnnnnn</i> Hz.
THRESH nn	Acts as Impulse Noise LOW Threshold (SET) selection.
ZERON	Sets LEVEL ZERO on.
ZEROFF	Sets LEVEL ZERO off.
SKIPON	Sets SF SKIP on.
SKIPOFF	Sets SF SKIP off.
STORE	Same as pressing the STORE key. Requires subsequent F1, F2, F3, or F4 command to complete action. Does not work with SF SKIP.
F1	Same as pressing the F1 404 key.
F2	Same as pressing the F2 1004 key.
F3	Same as pressing the F3 2804 key (and START command).
F4	Same as pressing the F4 2713 key (and STOP command).

Query Commands

Query commands retrieve measurements or other data from the 4934A.

HP 4934A TIMS Remote Query Commands

Command	Description
UCS?	Returns unit configuration.
DISP?	Returns current results; see below.
VERS?	Returns software version number.
SN?	Returns unit serial number.
ERR?	Returns last range error message; see next page.
ID?	Returns "HP 4934A."

Results Display (DISP?) Format

The DISP? command returns results in one of two format, depending on the current MEAS (measurement) mode.

For LEVEL FREQ, NOISE, NOISE W TONE, SIG TO NOISE, IMPULSE NOISE (TRMT), P/AR, and N.T. GND measurement modes, the DISP? command returns:

value1, value2

where *value1* is the value displayed on the left display and *value2* is the measurement displayed on the right display. All levels and signal-to-noise ratio values include the tenths digit.

For IMPULSE NOISE (RCV) measurements, the DISP? command returns:

LL, MM, HH, TT

where *LL* is the count of impulse noise low threshold crossing; *MM* is the count of middle threshold crossings, *HH* is the count of high threshold crossings; and *TT* is the timer value in minutes.

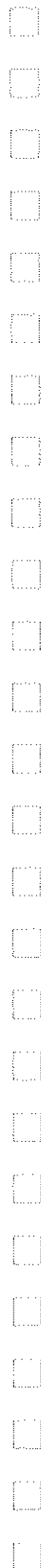

Range Error Messages

The LEV, FREQ, and THRESH commands accept a range of valid values. If an out-of-range value is entered, the 4934A still returns OK to the controller. However, the ERR? can check for the most recent out-of-range command value.

NOTE

The ERR? command identifies only the most recent out-of-range value entered.

The ERR? returns one of the following responses.

ERR? Responses

Response	Description
No Errors	No range errors were detected since the last ERR? command.
Level over range	The last LEV value was too high.
Level under range	The last LEV value was too low.
Frequency over range	The last FREQ value was too high.
Frequency under range	The last FREQ value was too low.
Threshold over range	The last THRESH value was too high.
Threshold under range	The last THRESH value was too low.

7-10 Remote Control

Service Accessory 1 (SA1) 20 dB Amplifier/4 kHz Filter

Performance Test

SPECIFICATION

Unity Gain with Flat Filter : 0 dB \pm 1.5 dB from 20 Hz to 85 kHz
20 dB Gain with Flat Filter : 20 dB \pm 1.5 dB from 20 Hz to 85 kHz
4 kHz Filter : Rejection at 10 kHz is greater than 10 dB

EQUIPMENT

AC Calibrator : DATRON 4707A
AC Voltmeter : HP 3456A
Dual Output DC Power Supply : HP 6234A

PROCEDURE

CAUTION

Ensure that the AC Calibrator OUTPUT is switched off or set to the minimum level before proceeding with the following procedure.

- 1 Connect the equipment as shown in the following figure:

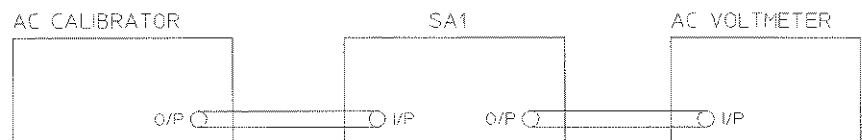

Unity Gain and Flatness Check

2 Set SA1 as follows:

Gain : Unity

Filter : Flat

3 Set the AC Calibrator output level to 0.7746 V at 20 Hz then switch on the OUTPUT.

4 Check that the AC Voltmeter is between 0.6517 V and 0.9206 V.

5 Set the AC Calibrator to each frequency listed in the following table and check the corresponding AC Voltmeter reading

AC Calibrator Frequency	AC Voltmeter Reading
50 Hz	0.6517 V to 0.9206 V
200 Hz	0.6517 V to 0.9206 V
1000 Hz	0.6517 V to 0.9206 V
15 kHz	0.6517 V to 0.9206 V
60 kHz	0.6517 V to 0.9206 V
85 kHz	0.6517 V to 0.9206 V

20 dB Gain and Flatness Check

6 Set SA1 as follows:

Gain : 20 dB

Filter : Flat

7 Set the AC Calibrator output level to 7.746 mV at 20 Hz.

8 Check that the AC Voltmeter reading is between 65.17 mV and 92.06 mV.

9 Set the AC Calibrator to each frequency listed in the following table and check the corresponding AC Voltmeter reading.



AC Calibrator Frequency	AC Voltmeter Reading
50 Hz	65.17 mV to 92.06 mV
200 Hz	65.17 mV to 92.06 mV
1000 Hz	65.17 mV to 92.06 mV
15 kHz	65.17 mV to 92.06 mV
60 kHz	65.17 mV to 92.06 mV
85 kHz	65.17 mV to 92.06 mV

4 kHz Filter Check

10 Set SA1 as follows:

Gain : Unity

Filter : 4 kHz L.P.

11 Set the AC Calibrator frequency to 100 Hz.

12 Adjust the AC Calibrator output level until the reading on the AC Voltmeter is 0.7746 V.

NOTE

Do not adjust the AC Calibrator output level for the remainder of the test.

13 Set the AC Calibrator frequency to 10 kHz.

14 Check that the reading on the AC Voltmeter is less than 0.2450 V.

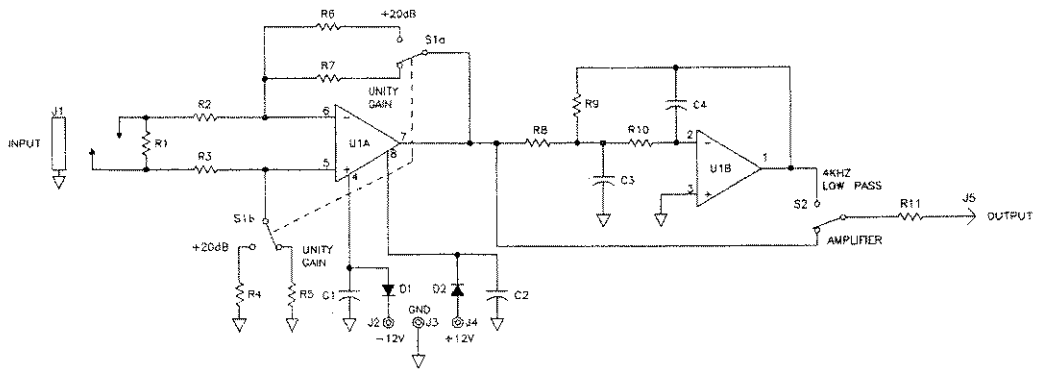

SA1 Schematic
Replaceable Parts

Ref. Designator	Description	Qty.	HP Part No.
SA1	Amplifier/Filter Assembly	1	04935-60018
C1	Capacitor 0.12 μ F \pm 5%	2	0160-3468
C2	Capacitor 0.12 μ F \pm 5%		0160-3468
C3	Capacitor 10k pF \pm 1%	1	0160-3548
C4	Capacitor 1k pF \pm 1%	1	0160-2387
D1	Diode	2	1901-0040
D2	Diode		1901-0040
R1	Resistor 600 Ω \pm 0.1%	2	0698-7408
R2	Resistor 10 k Ω \pm 1%	4	0757-0442
R3	Resistor 10 k Ω \pm 1%		0757-0442
R4	Resistor 100 k Ω \pm 1%	2	0757-0465
R5	Resistor 10 k Ω \pm 2%		0757-0442

Replaceable Parts (Continued)

R6	Resistor 100 k Ω \pm 1%		0757-0465
R7	Resistor 10 k Ω \pm 1%		0757-0442
R8	Resistor 42.2 k Ω \pm 1%	2	0698-3450
R9	Resistor 42.2 k Ω \pm 1%		0698-3450
R10	Resistor 2.87 k Ω \pm 1%	1	0698-3151
R11	Resistor 600 Ω \pm 0.1%		0698-7408
U1	MC3400L	1	1826-0712
S1	Switch	2	3101-0973
S2	Switch		3101-0973
J1	Connector	1	1251-3677
J2	Binding Post	3	1510-0076
J3	Binding Post		1510-0076
J4	Binding Post		1510-0076
J5	BNC Connector	1	1250-1780

**A-6 Service Accessory 1 (SA1)
20 dB Amplifier/4 kHz Filter**

B

Service Accessory 2 (SA2) Power Splitter/Adder

Performance Test

SPECIFICATION

Characteristic Impedance : 600Ω
Attenuation between any two ports : $6.02\text{ dB} \pm 0.05\text{ dB}$ at 40 Hz to 40 kHz

EQUIPMENT

AC Voltmeter : HP 3456A
Synthesizer : HP 3336B
Resistor $600\Omega \pm 0.01\%$: HP 0811-3502

NOTE

Do not use an AC Calibrator in place of a Synthesizer with a 600Ω balanced output or errors will occur.

PROCEDURE

- 1 Connect the equipment as shown in the following figure:

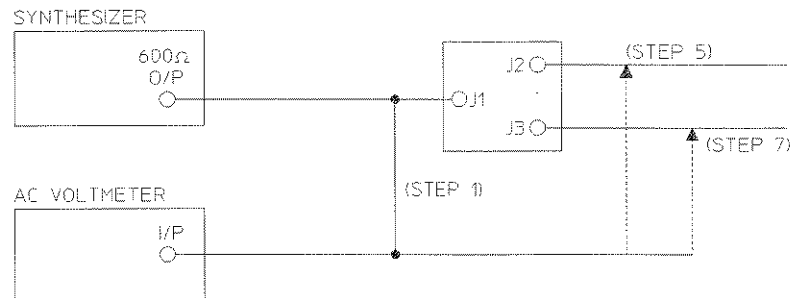

- 2 Set the Synthesizer output level to 0 dBm at 200 Hz.
- 3 Adjust the Synthesizer output level until the reading on the AC Voltmeter is between 1.5420 V and 1.5491 V
- 4 Connect the 600Ω resistor across J2 and the AC Voltmeter across J3.
- 5 Check the AC Voltmeter reading is between 0.7702 V and 0.7791 V.
- 6 Connect the AC Voltmeter across J2 and the resistor across J3 then repeat step 5.
- 7 Repeat steps 2 to 6 with the Synthesizer frequency at 40 kHz.

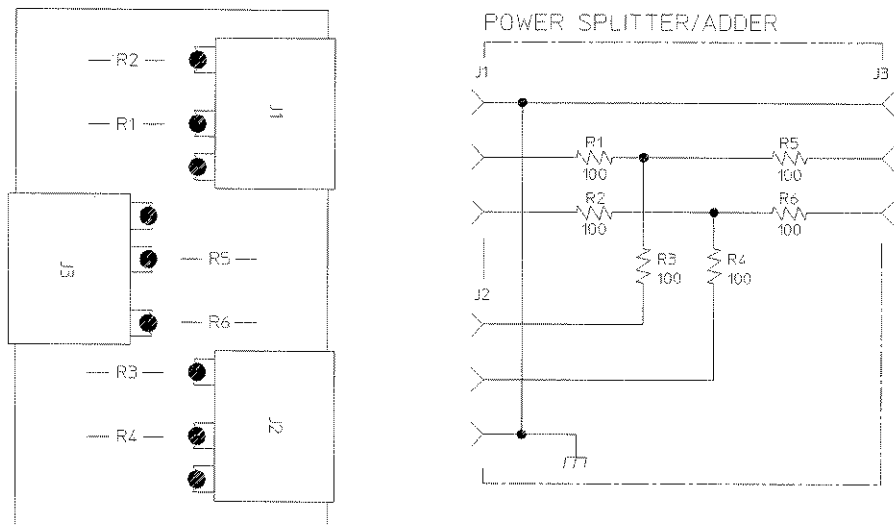

Replaceable Parts

Ref. Designator	Description	Qty.	HP Part No.
R1 to R6	Resistor Fxd 100Ω 0.1% 1/8 W	6	0698-6323
J1 to J3	Connector 3-pin	3	1251-2533
MSC	Connector single pin	9	1251-0600
MSC	Blank Printed Circuit Board	1	03779-20045

B-2 Service Accessory 2 (SA2) Power Splitter/Adder

Index

Numerics

15 kHz Flat Filter, 2-10
3 kHz Flat Filter, 2-10
50 kBit Filter, 2-10

A

Accessories Available, 3-9
Accessories Supplied, 3-9
Attenuation Distortion, 2-6, 2-9

B

Battery, 4-3
Battery (led), 1-2
Bridged Mode, 2-1

C

Charging (led), 1-2
C-Message Filter, 2-10

D

Dial and Hold, 2-2
Dialing Using a Butt-In, 2-3

E

Error Codes, 1-7

F

Filters
15 kHz Flat, 2-10
3 kHz Flat, 2-10
50 kBit, 2-10
C-Message, 2-10
Operational Verification, 5-6
PRGM (Program), 2-10
Frequency Shift, 2-6
Front Panel Features, 1-2, 1-4
Fuse, 4-2

G

Gain Slope, 2-6

H

Hold Circuit (Operational Verification), 5-11, 5-13
Holding a Line
With a Butt-in, 2-4
Without a Butt-In, 2-4

I

Impulse Noise
Count (Operational Verification), 5-9
Instrument Operation, 2-18, 2-20
Principles, 2-17, 2-18
Setting Thresholds, 2-19
Starting/Stopping the Measurement, 2-19
Threshold Accuracy (Performance Test), 5-39
Timed Measurement, 2-19
With a Holding Tone, 2-18
Without a Holding Tone, 2-18
Initial Inspection, 4-1
Instruments Covered by Manual, 3-7

K

Keys
BRDG, 1-2
DIAL, 1-2
DISPLAY (Impulse Noise), 1-3
DISPLAY (RCV/TRMT), 1-3
FILTER, 1-4
HOLD (RCV), 1-2
HOLD (TRMT), 1-2
LEVEL ZERO, 1-3
MEAS, 1-3
ON/STBY, 1-2
PERIOD, 1-3
RCV, 1-2
REVERSE, 1-3
SF SKIP, 1-3
START RESET, 1-4
STEP DOWN, 1-3
STEP UP, 1-3
STOP, 1-3
TRMT, 1-3

L

Level and Frequency
Instrument Operation, 2-7, 2-9
Principles, 2-5, 2-6
Line Fuse, 4-2
Loss (1004 Hz), 2-5
Loss of Holding Tone (Operational Verification), 5-10

M

Mating Connectors, 4-4
Measurements
Impulse Noise, 2-17, 2-20
Level and Frequency, 2-5, 2-9
Message Circuit Noise, 2-10, 2-12
Noise to Ground, 2-23, 2-24
Noise with Tone, 2-13, 2-14
Notched Noise, 2-13, 2-14
P/AR (Peak to Average Ratio), 2-21, 2-22
Signal to Noise, 2-15, 2-16
Message Circuit Noise
Accuracy (Performance Test), 5-34
Instrument Operation, 2-11
Principles, 2-10, 2-11
Monitor Control, 1-4

N

Noise to Ground
Accuracy (Performance Test), 5-41
Instrument Operation, 2-24
Principles, 2-23
Noise with Tone
Instrument Operation, 2-14
Principles, 2-13
Notch Filter Rejection (Performance Test), 5-36
Notched Noise
Instrument Operation, 2-14
Principles, 2-13

O

Operational Verification, 5-3, 5-13
Options Available, 3-8
Output Level Control, 1-3

P

P/AR
Accuracy (Performance Test), 5-43
Instrument Operation, 2-22
Principles, 2-21, 2-22
Performance Tests, 5-18, 5-44
Power Cable, 4-3
Power Requirements, 4-2
Preparation for Use, 4-2
Preset Frequencies, 2-7
PRGM (Program) Filter, 2-10

Index

R

Receiver

- Frequency (Operational Verification), 5-4
- Frequency Range/Accuracy (Performance Test), 5-30
- Level (Operational Verification), 5-5
- Level Accuracy (Performance Test), 5-32
- Receiver (RCV) Impedance, 2-1
- Receiving an Incoming Call
 - With a Butt-in, 2-4
 - Without a Butt-In, 2-4
- Reversing the two 310 Port Connections, 2-1

S

Safety symbols, 3-3

Signal to Noise

- Accuracy (Performance Test), 5-37
- Instrument Operation, 2-16
- Principles, 2-15
- Single Frequency (SF) Signaling, 2-8
- Single Point Frequencies, 2-8

T

Transmitter

- Flatness at +10 dBm (Performance Test), 5-22
 - Frequency Accuracy (Performance Test), 5-19
 - Level Accuracy (Performance Test), 5-21
 - Level Range (Performance Test), 5-20
 - Transmitter (TRMT) Impedance, 2-2
-