

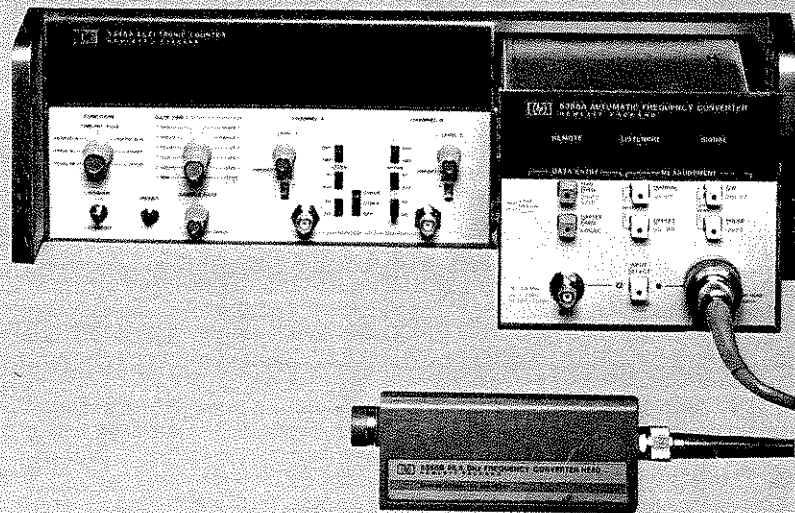

5355A AUTOMATIC FREQUENCY CONVERTER

AND

5356A/B/C FREQUENCY CONVERTER HEADS



- General Information
- Installation
- Operating and Programming
- Performance Tests
- Adjustments
- Replaceable Parts
- Manual Changes
- Service



HEWLETT
PACKARD

MANUAL CHANGES MODEL 5355A (05355-90013)

SERIAL PREFIX OR
SERIAL NUMBER

CHANGES

Page 1-2, Table 1-1. Model 5355A Specifications:

All Serials Maximum Input:
>Add two asterisks (**) to "+5 dBm" for the 5356C.
>Add the following footnote:
 ** In Pulse Mode 1.5 to 5.0 GHz, 0 dBm (+5 dBm typical).

>Add two asterisks (**) to the "+15dBm" on all ranges
 for the 5356C.
>Change the two-asterisk footnote to read as follows:
 *** In Pulse Mode, 0dBm (+5dBm typical)."

Page 1-3, Table 1-1. Model 5355A Specifications:

All Serials >Delete the asterisk(*) next to 5355A, under PULSE MODE
 column.
>Delete the Min Pulse Width, in the 5355A column, to 150ns.
>Delete, at bottom of page, "Specifications apply only to
 external gating of 5345/5355".

2132A >Change the MAN MODE specification from "60ns" to "75ns" in
 the area labeled "PULSE MODE" "Pulse Width" "MIN".
>Change the "PULSE MODE" "Accuracy" specification (lower
 right-hand corner) from "(.08EXT GATE WIDTH)" to
 "(.12/EXT GATE WIDTH)".

Page 1-4, Table 1-1. Model 5355A Specifications:

All Serials >Change maximum Operating Temperature to 55 degrees.

2132A >Change 40ns to 65ns under DEFINITIONS, rms jitter=.

Page 1-5. General Information:

All Serials >Add the following paragraph after Table 1-2:
 OPTION W30 (Extended Hardware Support) provides two addi-
 tional years of return-to-HP hardware-service support.
 Option W30 is available only at time of purchase. Service
 contracts are available from Hewlett-Packard for instruments
 which did not include Option W30 at time of purchase. For
 more information, contact your nearest Hewlett-Packard
 Sales and Support office (offices are listed at the back of
 this manual).

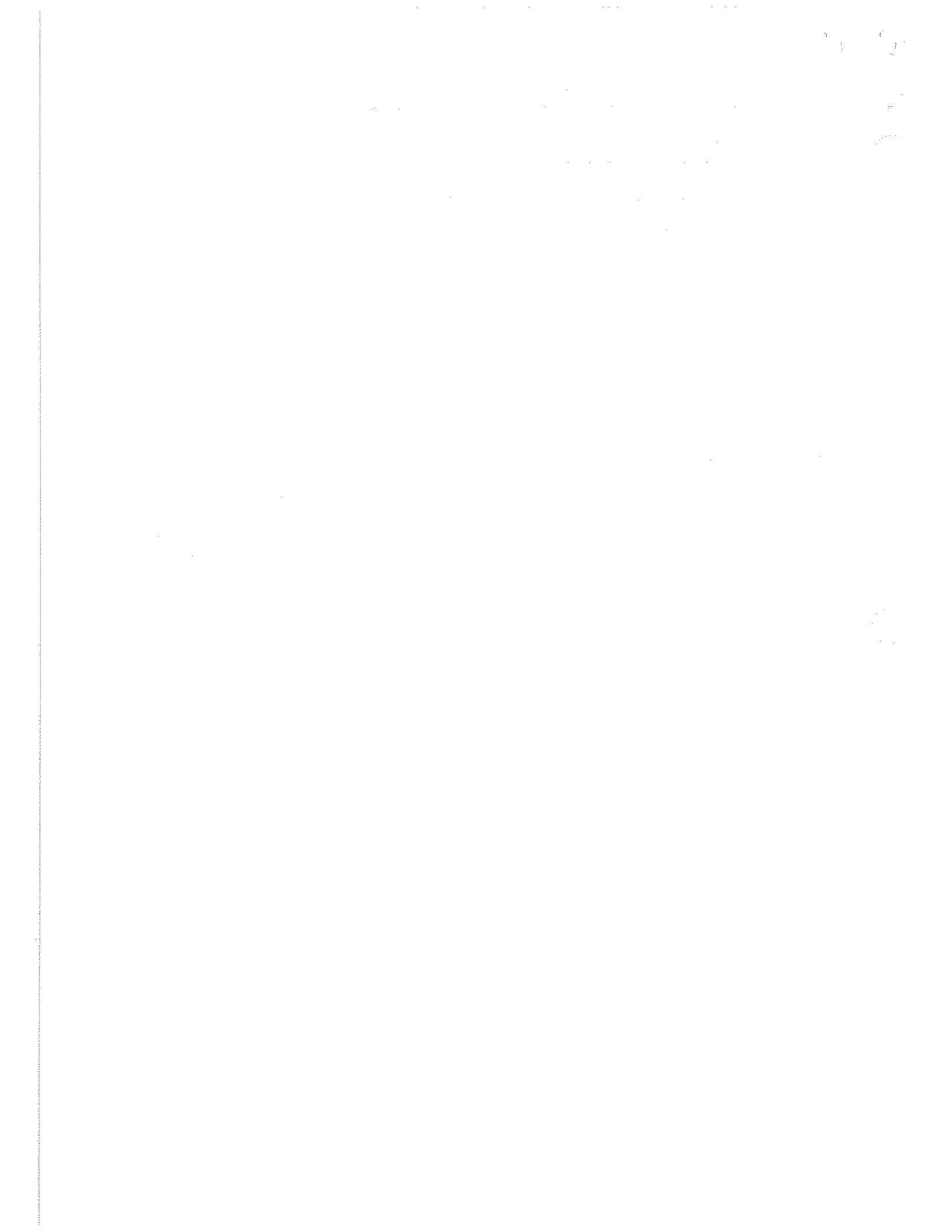

SERIAL PREFIX OR
SERIES NUMBER

CHANGES

Page 3-7, Operation and Programming:

All Serials

Paragraph 3-29:

>Add the following sentence between "simultaneously (in CW auto mode)." and "The special FM mode":

"A signal must be present before the 5355A signal light flashes."

>Add to the end of paragraph 3-29:

"It should be noted that the 5355A, when used in conjunction with the 5356C Frequency Converter Head, will always be in the special FM mode. Use of the special FM mode with the 5356C head is necessary to ensure proper harmonic number determination at frequencies above 26.5 Ghz.

Page 3-18. Operation and Programming:

All Serials

>Add note following paragraph 3-54:

NOTE

The 5355A, when used in conjunction with the 5356C Frequency Converter Head, will always be in the special FM mode.

2242A

>Replace the Display/Error Condition table with the following table:

DISPLAY

ERROR CONDITION

 (CW Automatic only)

5345A rear panel GATE CONTROL INPUT switch in wrong position. Should be in INTERNAL position.

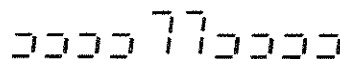

Harmonic number (n)=0 due to a low input frequency or due to the CHECK/COM A/SEP switch on 5345A front panel in CHECK position. Should be in COM A or SEP.



Indicates the CHECK/COM A/SEP switch on 5345A front panel in CHECK position. Should be in COM A or SEP.

Handwritten marks and symbols in the top right corner, possibly including a date or initials.

MANUAL CHANGES MODEL 5355A (05355-90013)

SERIAL PREFIX OR
SERIES NUMBER

CHANGES

Page 3-19, Paragraph 3-56. CONVERTER CODES:

2242A >Replace the Display/Head Installed table with the following table:

| DISPLAY | HEAD INSTALLED |
|------------|--------------------------------|
| ⋮⋮⋮⋮⋮0⋮⋮⋮⋮ | 5356A (1.5—18 GHz) |
| ⋮⋮⋮⋮⋮1⋮⋮⋮⋮ | 5356B (1.5—26.5 GHz) |
| ⋮⋮⋮⋮⋮2⋮⋮⋮⋮ | 5356B Option 001 (18-26.5 GHz) |
| ⋮⋮⋮⋮⋮4⋮⋮⋮⋮ | 5356C (1.5—40 GHz) |
| ⋮⋮⋮⋮⋮5⋮⋮⋮⋮ | 5356C Option 001 (26.5-40 GHz) |

Page 4-17. Performance Tests:

All Serials Paragraph 4-30. TEST 2. MANUAL MODE:
>Change "60 ns PULSE WIDTH" to "75 ns PULSE WIDTH".
Step a. waveform figure:
>Change "60" to "75" in both occurrences.
>Change "-9.2 dB" to "-8.2 dB".

Page 4-20. Performance Tests:

All Serials Table 4-2. Maximum Input Specifications, HP Model 5356A, B, and C Frequency Converter Heads:
>Add two asterisks (**) to "+ 5 dBm" for the 5356C.
>Add the following footnote:
**In Pulse Mode 1.5 to 5.0 GHz, 0 dBm (+5 dBm typical).

Page 5-4. Adjustments:

All Serials >Change display from =====Ic===== to =====IC===== in paragraph f.

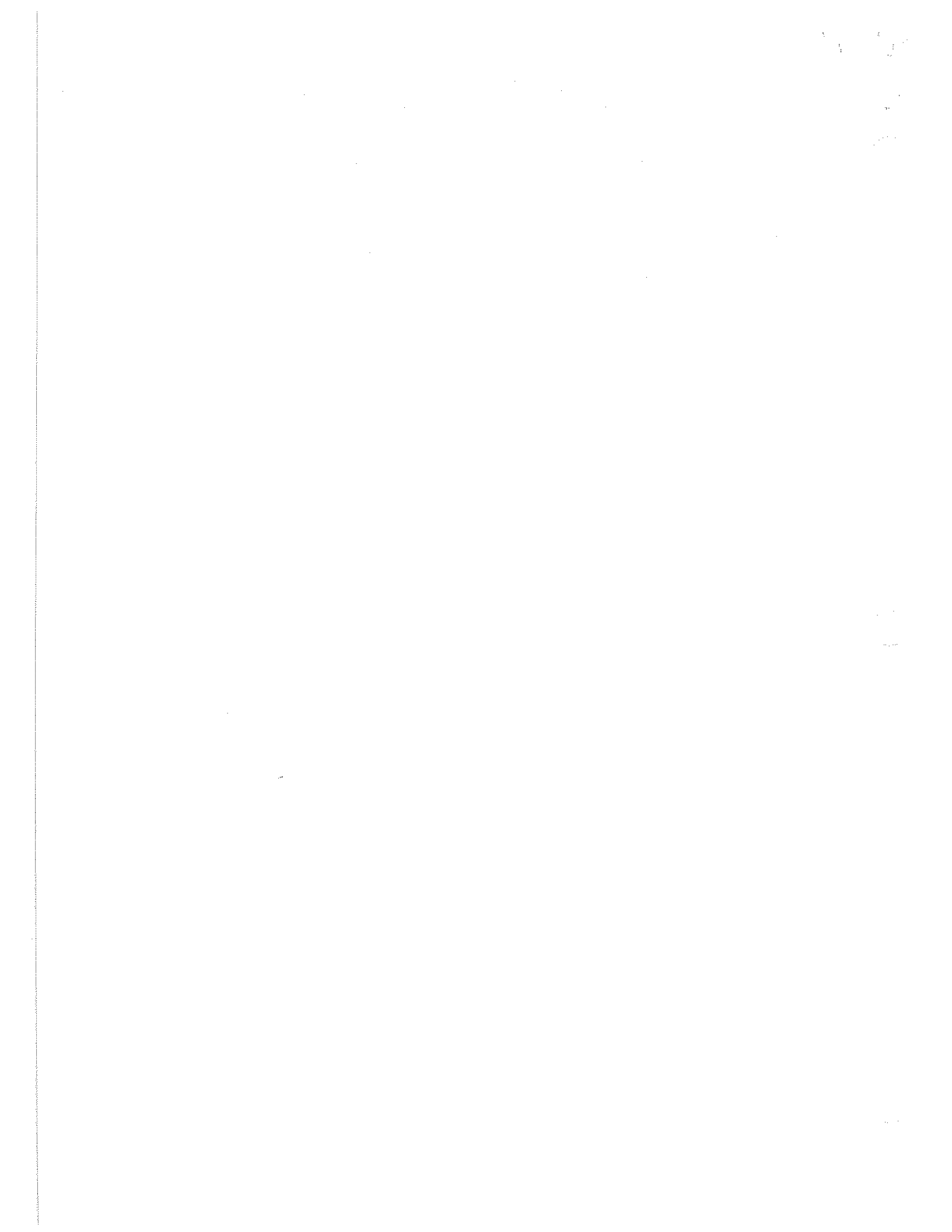

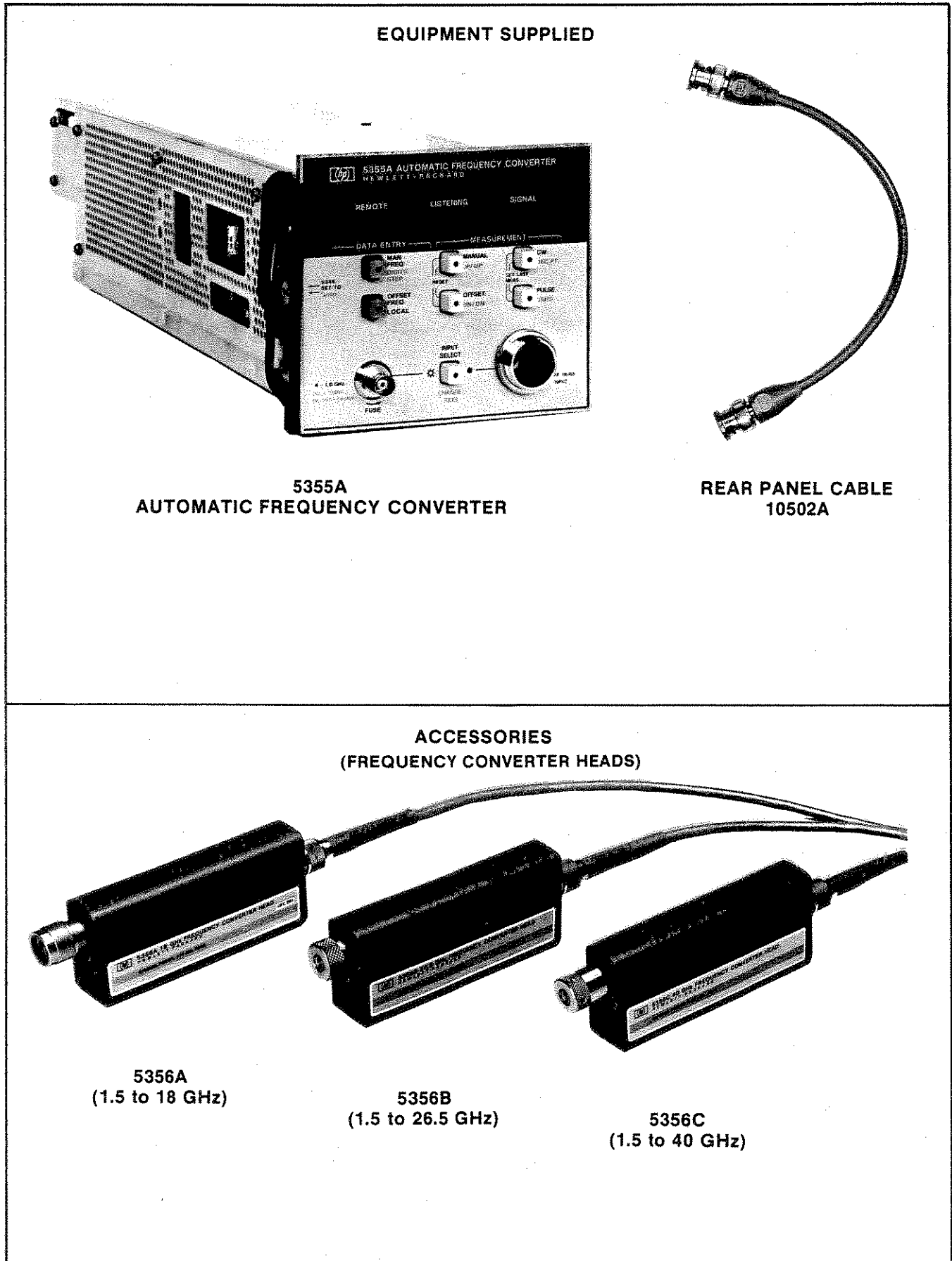

Figure 1-1. HP 5355A Automatic Frequency Converter and Accessories

SECTION I GENERAL INFORMATION

1-1. INTRODUCTION

1-2. This manual provides information pertaining to the installation, operation, testing, adjustment, and maintenance of the HP Model 5355A Automatic Frequency Converter and accessories.

1-3. *Figure 1-1* shows the HP 5355A and accessories. The 5355A is a plug-in unit for the HP 5345A Electronic Counter. The 5356A, 5356B, or 5356C Frequency Converter Head extends the frequency range of the 5355A.

1-4. SPECIFICATIONS

1-5. Instrument specifications are listed in *Table 1-1*. These specifications are the performance standards or limits against which the instrument may be tested. Specifications are based on operation with the HP 5345A Electronic Counter.

1-6. INSTRUMENTS COVERED BY MANUAL

1-7. This instrument has a two-part serial number. The first four digits and the letter comprise the serial number prefix. The last five digits form the sequential suffix that is unique to each instrument. The contents of this manual apply directly to instruments having the same serial number prefix(es) as listed under SERIAL PREFIX on the title page.

1-8. An instrument manufactured after the printing of this manual may have a serial prefix that is not listed on the title page. This unlisted serial prefix indicates that the instrument is different from those documented in this manual. The manual for this instrument is supplied with a yellow Manual Changes supplement that contains change information that documents the differences.

1-9. OPERATING MANUAL

1-10. Packaged with this manual is an Operating Information Supplement. This is simply a copy of the first three sections of this manual. This supplement should be kept with the instrument for use by the operator. Additional copies of the Operating Information Supplement or the Operating and Service Manual can be ordered through your nearest Hewlett-Packard Sales and Service Office (a list of these offices is provided at the end of this manual). The part numbers are listed on the title page of this manual.

1-11. MICROFICHE

1-12. Also listed on the title page of this manual following the Operating and Service Manual and Operating Information Supplement part numbers are Microfiche part numbers for these publications. These numbers can be used to order 4- \times 6-inch microfilm transparencies of these publications. The Microfiche package includes the latest Manual Changes supplement and all pertinent Service Notes.

Table 1-1. Model 5355A Specifications

| INPUT SPECIFICATIONS (PULSE AND CW MODE) | | | | |
|--|--|--|--|--|
| | 5356A | 5356B* | 5356C* | 5355A † |
| Frequency Range | 1.5—18 GHz | 1.5—26.5 GHz (Option 001: 18—26.5 GHz) | 1.5—40 GHz (Option 001: 26.5—40 GHz) | 0.4—1.6 GHz |
| Sensitivity 0.4—1.6 GHz 1.5—12.4 GHz 12.4—18 GHz 18—26.5 GHz 26.5—34 GHz 34—40 GHz | — -20 dBm -15 dBm — — — | — -20 dBm -15 dBm -15 dBm — — | — -25 dBm -20 dBm -20 dBm -15 dBm -10 dBm | -15 dBm — — — — — |
| NOTE: For pulse widths <200 ns reduce sensitivity by 5 dB | | | | |
| Maximum Input 0.4—1.6 GHz 1.5—12.4 GHz 12.4—18 GHz 18—26.5 GHz 26.5—40 GHz | — +5 dBm -5 dBm — — | — +5 dBm +5 dBm +5 dBm — | — +5 dBm +15 dBm +15 dBm +15 dBm | +5 dBm — — — — |
| Dynamic Range 0.4—1.6 GHz 1.5—12.4 GHz 12.4—18 GHz 18—26.5 GHz 26.5—34 GHz 34—40 GHz | — 25 dB 20 dB — — — | — 25 dB 20 dB 20 dB — — | — 30 dB 35 dB 35 dB 30 dB 25 dB | 20 dB — — — — — |
| Damage Level | +25 dBm peak | +25 dBm peak | +25 dBm peak | +24 dBm peak (fuse in BNC connector) |
| Impedance | 50Ω NOMINAL | 50Ω NOMINAL | 50Ω NOMINAL | 50Ω NOMINAL |
| SWR 0.4—1.6 GHz 1.5—10 GHz 10—18 GHz 18—26.5 GHz 26.5—34 GHz 34—40 GHz | — <2:1 TYPICAL <3:1 TYPICAL — — — | — <2:1 TYPICAL <3:1 TYPICAL <3:1 TYPICAL — — | — <2:1 TYPICAL <3:1 TYPICAL <3:1 TYPICAL <3:1 TYPICAL <5:1 TYPICAL | <2.5:1 TYPICAL — — — — — |
| Connector | N Male | SMA male with collar (Option 001: 18—26.5 GHz waveguide (WR 42)) | APC—3.5 male with collar (Option 001: 26.5—40 GHz waveguide (WR28)) | BNC |
| *Specifications in italics apply to both the standard 5356 Head and Option 001 of the same model. | | | | † 0.4—1.6 GHz input |
| OPERATING MODE SPECIFICATIONS (CW MODE) | | | | |
| | 5356A/B/C INPUT AUTO MODE | 5356A/B/C MAN MODE | 5355A 0.4—1.6 GHz INPUT | |
| FM Tolerance | 5356A/B: 15 MHz p-p (60 MHz in special FM mode) 5356C: 60 MHz p-p Rate: dc—10 MHz | 80 MHz p-p Rate: dc—10 MHz | Instantaneous frequency must not exceed 0.4—1.6 GHz range. | |
| AM Tolerance | Any modulation index provided the minimum signal level is greater than the counter sensitivity. | | | |
| Multiple Signal Discrimination (TYPICAL) | Automatically measures largest signal provided signal is 8 dB greater than any signal within 500 MHz and 20 dB greater than any signal over 1.5—26.5 GHz range. (5356C only: 15 dB (option 001: 20 dB) greater than any signal over 26.5—40 GHz range) | | | |
| Acquisition Time (TYPICAL) | 5356A/B: 400 ms (1.1s in special FM mode) 5356C: 1.4s (option 001: 1.1s) | 15 ms | <1 ms (FREQ ≥ 800 MHz) 5345A GATE TIME + 45 ms (FREQ <800 MHz) | |

Specifications describe the instrument's warranted performance. Supplemental characteristics are intended to provide information useful in applying the instrument by giving **TYPICAL** or **NOMINAL**, but nonwarranted performance parameters. Definition of terms is provided at the end of the specification section.

Table 1-1. Model 5355A Specifications (Continued)

| OPERATING MODE SPECIFICATIONS (CW MODE) (Continued) | | | |
|--|---|--|--|
| | 5356A/B/C INPUT AUTO MODE | 5356A/B/C MAN MODE | 5355A 0.4—1.6 GHz INPUT |
| Measurement Time | Gate Time ≤ 100 ms: Acquisition time + 4 X 5345A GATE TIME + 5345A Sample Rate + 125 ms. Gate Time > 100 ms: Acquisition time + 5345A GATE TIME + 5345A Sample Rate + 35 ms | | Acquisition time + 5345A GATE TIME + 5345A SAMPLE RATE + 35 ms |
| LSD Displayed | $\frac{1 \text{ Hz}}{5345A \text{ GATE TIME}}$ | | |
| Resolution | $\pm 2 \times \text{LSD} \pm 1 \times 10^{-10} \text{ rms} \times \text{FREQ}$ | | $\pm 5 \times \text{LSD}$ |
| Accuracy † | Resolution ± (time base error X FREQ) | | Resolution ± (time base error X FREQ) |
| PULSE MODE | | | |
| | 5356A/B/C INPUT AUTO MODE | 5356A/B/C INPUT MAN MODE | 5355A* 0.4—1.6 GHz INPUT |
| FM Tolerance (TYPICAL) | 50 MHz p-p chirp | 80 MHz p-p chirp | Instantaneous frequency must not exceed 0.4—1.6 GHz range |
| Acquisition Time (TYPICAL) | 5356A/B/C MAN MODE: 0 5356A/B AUTO MODE: 100 μs/(EXT. GATE WIDTH X PRF) + 650 ms for EXT GATE ≤ 100 μs. (2/PRF) + 650 ms for EXT GATE > 100 μs. 5356C AUTO MODE: 100 μs/(EXT GATE WIDTH X PRF) + 1.55s (Option 001: 1.25s) + 8 (Option 001: 7)/PRF for EXT GATE ≤ 100 μs. 10 (Option 001: 9)/PRF + 1.55s (Option 001: 1.25s) for EXT GATE > 100 μs. | | 0 (FREQ ≥ 800 MHz) $\frac{5345A \text{ GATE TIME}}{\text{EXT GATE WIDTH X PRF}}$ + 45 ms (FREQ < 800 MHz) |
| Calibration Time | $\frac{5345A \text{ GATE TIME}}{\text{EXT GATE WIDTH X PRF}} + 75 \text{ ms}$ Performed during 10 consecutive measurements when PULSE Mode is selected, after any front panel change, or when the EXTERNAL GATE width changes by more than 12%. Only calibrates if External Gate is < 100 μs. | | |
| Measurement Time (TYPICAL) | Acquisition Time + Calibration Time + 5345A SAMPLE RATE + 5345A GATE TIME or 100 μs (whichever is greater) $\frac{\text{EXT GATE WIDTH X PRF}}{+ 100\text{ms}}$ | Acquisition Time + Calibration Time + 5345A SAMPLE RATE + 60 ms + (1 μs + 5345A GATE TIME) $\frac{\text{EXT GATE WIDTH X PRF}}$ | |
| Pulse Width: Min: Max: | 100 ns 20 ms | 60 ns 20 ms | 100 ns 1 s |
| Pulse Repetition Frequency Min: Max: | NOTE: Minimum off time is 400 ns (i.e., 2 MHz PRF with 100 ns pulses) | | |
| | 50 Hz 2 MHz | 50 Hz 2 MHz | 100 Hz 2 MHz |
| Minimum ON/OFF RATIO | 25 dB (TYPICAL) | | |
| Maximum Video Feedthrough | 15 mV p-p (TYPICAL) for rf burst rise and fall times ≥ 10 ns | | |
| LSD Displayed | 1 Hz/5345A GATE TIME | | |
| Resolution | $\pm 2 \times \text{LSD} \pm \text{rms jitter}^{**}$ | | $\pm 10 \times \text{LSD} \pm 5 \times \text{rms jitter}^{**}$ |
| Accuracy † | Resolution ± $\frac{.04}{\text{EXT GATE WIDTH}}$ $\pm 3 \text{ KHz} \pm (\text{Time base error} \times \text{FREQ})$ | | $(\pm 16 \times \text{LSD}) \pm (5 \times \text{rms jitter}^{**})$ $\pm (.08/\text{EXT GATE WIDTH})$ $\pm 24 \text{ KHz}$ $\pm (\text{Time base error} \times \text{FREQ})$ |

Specifications apply only to external gating of 5345/5355 ** See jitter specification on following page. † After one minute warm-up.

Table 1-1. Model 5355A Specifications (Continued)

| | |
|---|---|
| <p>5356A OPTION 001 HIGH PASS FILTER SPECIFICATIONS</p> <p>Insertion Loss: <1 dB from 1.5—18 GHz</p> <p>Insertion Loss below 100 MHz: >35 dB</p> | <p>DEFINITIONS</p> <p>LSD Displayed: Unit value of least significant digit.</p> <p>Resolution: Maximum deviation (or rms deviation) between successive measurements under constant environmental and constant input conditions.</p> <p>Accuracy: Deviation from the true value as fixed by universally accepted standards for frequency and time.</p> <p>Minimum ON/OFF Ratio: For a pulsed rf input, the required minimum difference, in dB, between the pulse ON signal level and pulse OFF signal level which will enable the 5355 to distinguish a pulse input.</p> <p>Maximum Video Feedthrough: For a pulse rf input, the maximum peak-to-peak voltage caused by the superposition of video components above 75 MHz, which the 5355/56 can tolerate in the burst.</p> <p>rms jitter =</p> $\frac{1}{\sqrt{(5345A \text{ GATE TIME}) (EXT \text{ GATE WIDTH})}} + X$ <p style="text-align: center;">X = 100 Hz rms</p> <p>For EXT GATE signals generated by the 5355A, the EXT GATE WIDTH equals the input PULSE WIDTH minus 30 ns (TYPICAL) for the 5356A/B/C input and equals input PULSE width minus 40 ns (TYPICAL) for the 5355 0.4—1.6 GHz input.</p> |
| <p>GENERAL</p> <p>IF OUT: Down converted signal in range of 80—375 MHz available at 5355 rear panel IF OUT connector. 0 dBm NOMINAL level.</p> <p>GATE OUT: 0 to -1 volt detected IF signal used to drive 5345A EXTERNAL GATE CONTROL INPUT. Width of GATE OUT is approximately 30 ns less than rf burst width.</p> <p>PULSE OUT: Detected IF signal: TTL levels; TTL low indicates signal present; +1 to 0V TYPICAL into 50Ω.</p> <p>Operating Temperature: 0° to 55°C</p> <p>Weight: 5355A: 3.75 kg (8 lb., 4 oz.) net 5356A/B/C: 0.54 kg (1 lb., 3 oz.) net</p> <p>5356A/B/C Dimensions: 27.4 mm, 138 mm, 56.6 mm (1.08", 5.43", 2.23") Cable length: 1.68 metres (66")</p> | |

1-13. SAFETY CONSIDERATIONS

1-14. This product is used as part of a Safety Class I instrument (provided with a protective earth terminal). Safety information pertinent to the operation and servicing of this instrument is included in appropriate sections of this manual.

1-15. EQUIPMENT SUPPLIED

1-16. The only equipment supplied with the 5355A plug-in unit is the BNC Cable (HP Part No. 05355-60101) shown in Figure 1-1.

1-17. ACCESSORIES

1-18. Accessories available for use with the 5355A are as follows (connector and filter options listed in Table 1-2):

- 5356A Frequency Converter Head (1.5—18 GHz)
- 5356B Frequency Converter Head (1.5—26.5 GHz)
- 5356C Frequency Converter Head (1.5—40 GHz)
- Extender Board Service Kit, HP Part No. 05355-60100 (See paragraph 1-19)
- APC 7 to N(f) Adapter, HP 11524A

Table 1-2. 5356 Frequency Converter Head Options

| Connector Options | 5356A (1.5—18 GHz) | 5356B (1.5—26.5 GHz) | 5356C (1.5-40 GHz) |
|-----------------------|----------------------------|----------------------|--------------------|
| TYPE N MALE | Standard or H10 for 24 GHz | N/A | N/A |
| SMA MALE W/COLLAR | Option H01 | Standard | |
| APC 3.5 MALE W/COLLAR | N/A | Option H01 | Standard |
| WAVEGUIDE | N/A | Option 001 (WR-42) | Option 001 (WR-28) |
| FILTER OPTION | | | |
| High Pass Filter | Option 001 | N/A | N/A |

1-19. DESCRIPTION

1-20. The 5355A plug-in unit, when used with a 5345A Electronic Counter provides measurements of CW or burst frequencies from 400 MHz to 1.6 GHz. Since the 5345A has a range of 0 to 500 MHz, the 5345A/5355A combination offers frequency measurement capability from 0—1.6 GHz. Frequencies up to 40 GHz may be measured by use of the accessories described in the following paragraph.

1-21. For higher frequency measurements, the 5356A, 5356B, or 5356C Frequency Converter Head is used. The heads use the single sampler, harmonic heterodyne technique to downconvert the input signal frequency. The 5356A allows measurements from 1.5 to 18 GHz, the 5356B allows measurements from 1.5 to 26.5 GHz, and the 5356C allows measurements from 1.5 to 40 GHz. The head connects to the signal source and the attached 5½ foot cable connects to the multipin connector on the front panel of the 5355A.

1-22. Signals in the 0.4 to 1.6 GHz range are sent through a prescaler (divider) in the 5355A to the IF circuits. Signals in the 1.5 to 40 GHz range are sent through the down-converter head to the IF circuits. The 5355A automatically acquires the input CW or pulsed rf signal and under control of its microprocessors algorithm, routes the down-converted signal to the 5345A mainframe to be counted and displayed.

1-23. SERVICE EQUIPMENT AVAILABLE

1-24. A kit of extender boards is available to allow servicing printed circuit assemblies while extended from the instrument. The extender boards allow the assemblies to be extended from their plug-in connectors for monitoring with appropriate test equipment. The HP part number of the kit is 05355-60100. Refer to paragraph 8-183 for detailed information.

1-25. RECOMMENDED TEST EQUIPMENT

1-26. The test equipment listed in Table 1-3 is recommended for use during performance tests, adjustments, and troubleshooting. Substitute test equipment may be used if it meets the required characteristics listed in the table.

Table 1-3. Recommended Test Equipment

| Instrument | Required Characteristics | Recommended Model |
|-----------------------------|---|--|
| Oscilloscope | dc to 275 MHz | HP 1725A |
| Oscilloscope | dc to 1 GHz | HP 180A/1810A |
| Oscilloscope | dc to 200 MHz | HP 183C/1830A/1840A |
| Oscilloscope Probe Kit | | HP 10020A |
| Signal Generator | .1 to 4.3 GHz .4 to 2.0 GHz 2 to 18 GHz 18 to 26.5 GHz 26.5 to 40 GHz | HP 8620C/8621B HP 8620C/86222B HP 8620C/86290B HP 8690B/8696A HP 8690A/8697A |
| Digital Multimeter | 20V range | HP 3465A |
| AC Voltmeter | 10 to 375 MHz | HP 3406A |
| Power Splitter | dc to 18 GHz | HP 11667A |
| Signature Analyzer | | HP 5004A |
| Power Meter | 10 MHz to 18 GHz | HP 436A |
| Power Sensor | 10 MHz to 18 GHz -30 dBm to +20 dBm | HP 8481A |
| Spectrum Analyzer | 10 MHz to 500 MHz | HP 8565A |
| Resistive Divider Probe Set | 50Ω, 20:1 Attenuation | HP 10020A |
| Sweep Analyzer | 100 MHz to 1 GHz | HP 8755A/182T |
| Detector | 100 MHz to 1 GHz | HP 11664A |
| Crystal Detector | 18 to 26.5 GHz 26.5 to 40 GHz | HP K422A HP R422A |
| Power Meter | 18 to 26.5 GHz | HP 432A |
| Thermistor Mount | 18 to 26.5 GHz 26.5 to 40 GHz | HP K486A HP R486A |
| Directional Coupler | 18 to 26.5 GHz 26.5 to 40 GHz | HP K752A HP R752A, R752C |
| Step Attenuator | 10 dB step, dc to 26.5 GHz, APC-3.5 | HP 8495D (With Option 004) |
| Attenuator | 3 dB, 100 MHz to 1 GHz | HP 8491A |
| Variable Attenuator | 18 to 26.5 GHz 26.5 to 40 GHz | HP K382A HP R382A |
| Adapter | Waveguide (WR-42) to SMA | OSM P/N 2000-6256-00 Model #20188AJ |
| Adapter | Waveguide to OSM, 26.5 to 40 GHz | Maury Microwave, U223A |
| Adapter | Waveguide (WR-42) to APC-3.5 | Narda 4608B |
| Waveguide, Straight Section | 26.5 to 40 GHz | Maury Microwave, U101A4 |
| Waveguide, Bend | 26.5 to 40 GHz | Maury Microwave, U135A |
| Logic Probe | TTL Compatibility | HP 545A |
| Logic Pulser | TTL Compatibility | HP 546A |
| Current Tracer | 1 mA to 1A range | HP 547A |
| AP Clips | Clip for 14/16 pin IC's | HP P/N 705-0048 |

Table 1-3. Recommended Test Equipment (Continued)

| Instrument | Required Characteristics | Recommended Model |
|--------------------|--|-------------------|
| Pulse Modulator | 2 to 18 GHz | HP 11720A |
| Pulse Generator | General purpose | HP 8012A |
| Extender Board Kit | 5355A Compatibility | 05355-60100 |
| Power Supply | 1 to 15V | HP 6284A |
| Modulator | Sweep Analyzer Compatibility | HP 11665B |
| Signal Generator | Pulse Modulation Capability 50 to 400 MHz | HP 8640B |
| Pulse Generator | 1 to 20 μ s Pulse Width 1 to 20 μ s Pulse Repetition Rate 0 to 5V Output | HP 8013A |
| Frequency Counter | To 225 MHz CW | HP 5382A |
| Frequency Counter | To 1200 MHz CW | HP 5340A |
| HP-IB Bus Analyzer | HP-IB Compatibility | HP 59401A |
| Active Probe | 500 MHz | HP 1120A |
| Probe Power Supply | 1120A Compatibility | HP 1122A |
| Mixer | .2 to 2 GHz (WJM1J) | HP P/N 0960-0455 |



SECTION II INSTALLATION

2-1. INTRODUCTION

2-2. This section provides instructions for unpacking, inspection, preparation for use, storage, and shipment of the 5355A plug-in.

2-3. UNPACKING AND INSPECTION

2-4. If the shipping carton is damaged, inspect the 5355A for visible damage (scratches, dents, etc.). If the 5355A is damaged, notify the carrier and the nearest Hewlett-Packard Sales and Service Office immediately (offices are listed at the back of this manual). Keep the shipping carton and packing material for the carrier's inspection. The HP Sales and Service Office will arrange for repair or replacement of your instrument without waiting for the claim against the carrier to be settled.

2-5. PREPARATION FOR USE

2-6. Power Requirements

2-7. The 5355A does not require external ac power. All necessary power is supplied by the 5345A when the 5355A is plugged in.

2-8. Operating Environment

2-9. The operating temperature range is 0°C to 55°C. If these limits are exceeded at the installation site, auxiliary cooling or heating should be used to keep environment within limits.

2-10. Installation

2-11. To install the 5355A, proceed as follows:

- a. On the 5345A, set POWER switch to STANDBY.
- b. Pull the locking handle on the left side of the 5355A up to the horizontal position.
- c. Slide the 5355A into the 5345A. Use caution to prevent damage to interface connectors at rear of unit.
- d. Push locking handle down and toward the instrument until it is parallel with the front panel.
- e. For operating information, address switch settings, and connections to rear panel BNC connectors, refer to Section III.

2-12. Compatibility with 5345A

2-13. The 5345A must be in EXT GATE mode when the 5355A is in PULSE mode and must be in INT GATE mode when the 5355A is in CW mode. If the GATE CONTROL switch on the rear panel of the 5345A is left in INT position, then the proper gating mode is selected automatically in 5345A's that have Serial Prefix 1808A or higher. Older 5345A's with serial prefix 1744A and below require manual selection of EXT GATE mode (for PULSE) and INT GATE mode (for CW). However, a minor modification can be added (see paragraph 8-13) which updates these units.

2-14. HP-IB Interconnections

2-15. HEWLETT-PACKARD INTERFACE BUS. Interconnection data concerning the rear panel HP-IB connector is provided in *Figure 2-1*. This connector is compatible with the HP 10833A/B/C/D HP-IB cables. The HP-IB system allows interconnection of up to 15 (including the controller) HP-IB compatible instruments. The HP-IB cables have identical "piggy-back" connectors on both ends so that several cables can be connected to a single source without special adapters or switch boxes. System components and devices may be connected in virtually any configuration desired. There must, of course, be a path from the calculator (or other controller) to every device operating on the bus. As a practical matter, avoid stacking more than three or four cables on any one connector. If the stack gets too large, the force on the stack produces great leverage which can damage the connector mounting. Be sure each connector is firmly (finger tight) screwed in place to keep it from working loose during use.

2-16. CABLE LENGTH RESTRICTIONS. To achieve design performance with the HP-IB, proper voltage levels and timing relationship must be maintained. If the system cable is too long, the lines cannot be driven properly and the system will fail to perform properly. Therefore, when interconnecting an HP-IB system, it is important to observe the following rules:

- a. The total cable length for the system must be less than or equal to 20 metres (65 feet).
- b. The total cable length for the system must be equal to or less than 2 metres (6.6 feet) times the total number of devices connected to the bus.
- c. The total number of instruments connected to the bus must not exceed 15.

2-17. 5355A Listen Address

2-18. The 5355A contains a rear panel HP-IB instrument address selection switch. There are five switches designated (A5, A4, A3, A2, A1) which are used to select the address. Instructions for setting and changing the listen address are provided in Section III of this manual along with programming codes.

2-19. HP-IB Descriptions

2-20. A description of the HP-IB is provided in Section III of this manual. A study of this information is necessary if the user is not familiar with the HP-IB concept. Additional information concerning the design criteria and operation of the bus is available in IEEE Standard 488-1975, titled "*IEEE Standard Digital Interface for Programmable Instrumentation*".

2-21. Operational Check

2-22. To determine if the instrument is operating properly, refer to the performance check in Section IV. Contact the nearest HP Sales and Service Office (see manual back cover) for information relative to warranty claims.

2-23. PACKAGING FOR RESHIPMENT

2-24. Original Packaging

2-25. The same containers and materials used in factory packing can be obtained through the Hewlett-Packard Sales and Service Offices listed at the rear of this manual.

2-26. If the instrument is being returned to Hewlett-Packard for service, attach a tag indicating the type of service required, return address, model number, and full serial number. Mark the container FRAGILE to assure careful handling.

2-27. In any correspondence refer to the instrument by model number and full serial number.

2-28. Other Packaging Methods

2-29. If it becomes necessary to reship an instrument, good commercial packing should be used. Contract packaging companies in many cities can provide dependable custom packaging on short notice. The following general instructions should be followed when repackaging with commercially available materials.

- a. If shipping to a Hewlett-Packard Office or Center, attach a tag indicating the type of service required, return address, model number, and full serial number.
- b. Wrap the instrument in heavy paper or plastic.
- c. Use a strong shipping container. A double-wall carton made of 350-pound test material is adequate.
- d. Use enough shock-absorbing material (3- to 4-inch layer) around all sides of the instrument to provide a firm cushion and prevent movement inside the container. Protect the control panel with cardboard.
- e. Seal the shipping container securely.
- f. Mark the shipping container FRAGILE to assure careful handling.

2-30. STORAGE

2-31. If the instrument is to be stored for an extended period of time, it should be enclosed in a clean, sealed container.

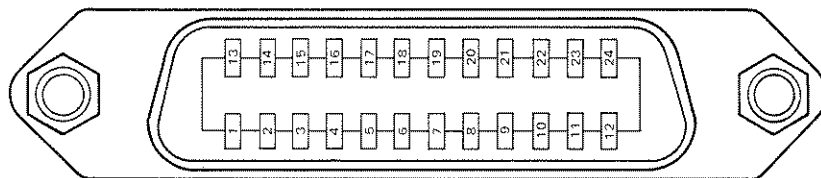

| PIN | LINE |
|-----|------------------------------|
| 1 | DIO1 |
| 2 | DIO2 |
| 3 | DIO3 |
| 4 | DIO4 |
| 13 | DIO5 |
| 14 | DIO6 |
| 15 | DIO7 |
| 16 | DIO8 |
| 5 | EOI |
| 17 | REN |
| 6 | DAV |
| 7 | NRFD |
| 8 | NDAC |
| 9 | IFC |
| 10 | SRQ |
| 11 | ATN |
| 12 | SHIELD-CHASSIS GROUND |
| 18 | P/O TWISTED PAIR WITH PIN 6 |
| 19 | P/O TWISTED PAIR WITH PIN 7 |
| 20 | P/O TWISTED PAIR WITH PIN 8 |
| 21 | P/O TWISTED PAIR WITH PIN 9 |
| 22 | P/O TWISTED PAIR WITH PIN 10 |
| 23 | P/O TWISTED PAIR WITH PIN 11 |
| 24 | ISOLATED DIGITAL GROUND |

THESE PINS ARE INTERNALLY GROUNDED

CAUTION

The 5355A contains metric threaded HP-IB cable mounting studs as opposed to English threads. Metric threaded HP 10631A, B, C, or D HP-IB cable lockscrews must be used to secure the cable to the instrument. Identification of the two types of mounting studs and lockscrews is made by their color. English threaded fasteners are colored silver and metric threaded fasteners are colored black. DO NOT mate silver and black fasteners to each other or the threads of either or both will be destroyed. Metric threaded HP-IB cable hardware illustrations and part numbers follow.

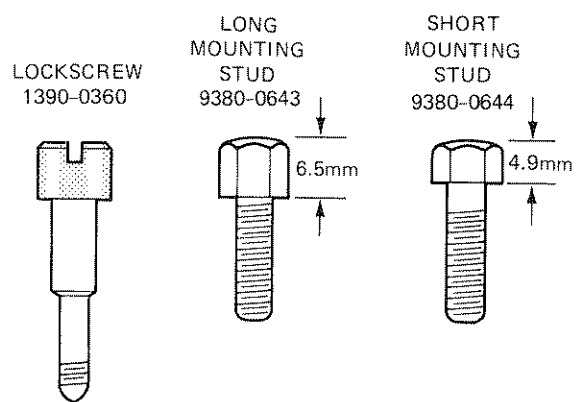

Logic Levels

The Hewlett-Packard Interface Bus logic levels are TTL compatible, i.e., the true (1) state is 0.0V dc to 0.4V dc and the false (0) state is +2.5V dc to +4.0V dc.

Programming

Refer to Section III, Operation

Mating Connector

HP 1251-0293; Amphenol 57-30240.

Mating Cables Available

- HP 10833A, 1 metre (3.28 ft.)
- HP 10833B, 2 metres (6.56 ft.)
- HP 10833C, 4 metres (13.12 ft.)
- HP 10833D, 0.5 metre (1.64 ft.)

Cabling Restrictions for Standard System

1. A Hewlett-Packard Interface Bus System may contain no more than 1.8 metres (6 ft.) of connecting cable per instrument.
2. The maximum accumulative length of connecting cable for any Hewlett-Packard Interface Bus System is 20.0 metres (65.6 ft.).

Figure 2-1. Hewlett-Packard Interface Bus Connection

SECTION III OPERATION AND PROGRAMMING

3-1. INTRODUCTION

3-2. This section contains descriptions of operating characteristics and modes, operating procedures, descriptions of front and rear panel controls and indicators, keyboard test procedures, and Hewlett-Packard Interface Bus (HP-IB) programming information.

3-3. The 5355A is a plug-in for the 5345A Electronic Counter. Operating and programming characteristics of the 5345A must be understood before attempting to operate and program the 5355A. For complete information on the 5345A, refer to the 5345A Operating and Service Manual. When appropriate, the 5355A programming explanations that follow contain notes on the interrelated 5345A programming instructions.



3-4. The 5355A is programmed via the HP-IB. The HP-IB is a carefully defined instrumentation interface which simplifies the integration of instruments, calculators, and computers into systems. The HP-IB is Hewlett-Packard's implementation of IEEE Standard 488-1975, "Standard Digital Interface for Programmable Instrumentation".

3-5. OPERATING CHARACTERISTICS

3-6. The following paragraphs describe the operating ranges and modes, AM and FM tolerance and automatic amplitude discrimination.

3-7. Operating Ranges

3-8. The two operating ranges are 0.4 to 1.6 GHz and 1.5 to 40 GHz. Frequencies in the lower range are measured by use of a prescaler technique while frequencies in the higher range are measured by use of a harmonic heterodyne down-conversion technique. A separate front panel input connector is provided for each range (see Figure 3-1). Selection of the two ranges is

provided by the  key on the front panel. When the  key indicator is lit,

the 0.4—1.6 GHz input (BNC) is routed to the prescaler. When the  key indicator is not

lit, the RF HEAD INPUT (multipin connector) is sent to the IF circuits. The multipin connector input requires the use of the 5356A/B/C Frequency Converter Head. The 5356A covers the range of 1.5 to 18 GHz, the 5356B covers 1.5 to 26.5 GHz, and the 5356C covers 1.5 to 40 GHz. See

Table 1-2. When the  LED is illuminated, the 0.4 to 1.6 GHz input (BNC) is connected, otherwise the RF HEAD INPUT is connected.

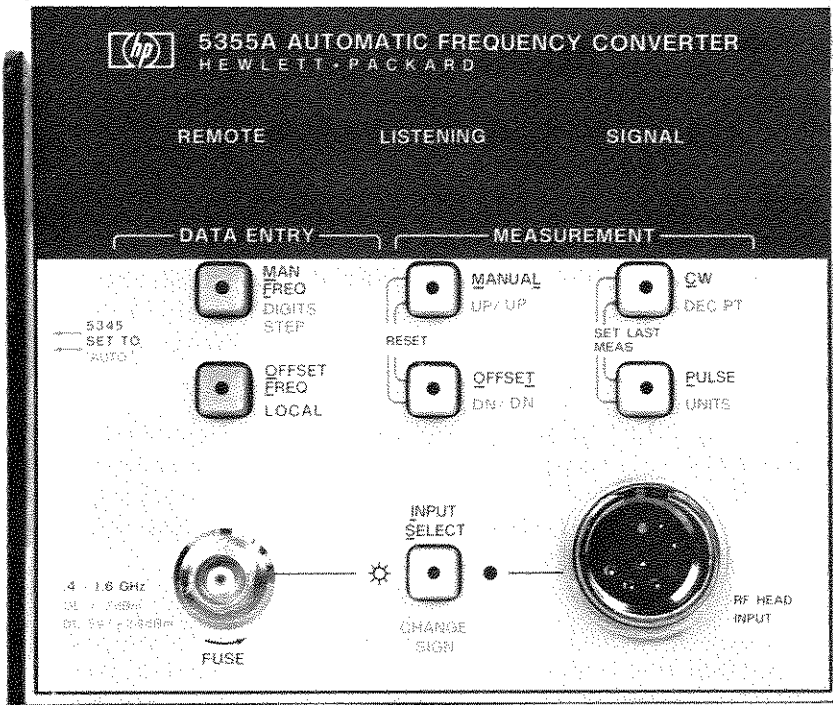

INDICATORS

REMOTE. Indicator illuminates when 5355A is under remote operation and all front panel controls are inoperative except the LOCAL key (unless Local Lockout command has been sent).

LISTENING. Indicator illuminates when 5355A is addressed and monitoring the interface bus.

SIGNAL. Indicator illuminates when input signal is of sufficient level to be counted.

KEY INDICATORS. Indicator within a key illuminates when the key is pressed to initiate the key function. Pressing the key again releases the function and the indicator extinguishes (except for the CW and PULSE keys).

CONTROLS



All front panel controls are pushbutton keys with center indicators that indicate the operating function of the plug-in. The keys are grouped under two general functional headings, DATA ENTRY and MEASUREMENT, as described below.

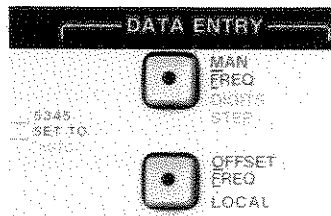

DATA ENTRY Keys





The two color-coded DATA ENTRY keys on the left side of the front panel are used to enter data for a manual center frequency or an offset frequency. When one of these keys is enabled (key indicator illuminated) the functions of the MEASUREMENTS keys to the right are defined by the label whose color corresponds to that of the enabled DATA ENTRY key.

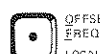

Figure 3-1. Front Panel Controls, Connectors and Indicators

 When key is pressed and illuminated, enters the manual center frequency shown on the counters display (controlled by  or ).



When  pressed again and extinguished, and  pressed, counter displays measurement. The DIGIT STEPS (blue-label) function is in effect when OFFSET FREQ key (blue) is illuminated. Each time the DIGIT STEPS key is pressed, the display is expanded by two digits until 10 decimal places are displayed (depending upon resolution).

 When pressed and illuminated, this key enters the offset frequency (controlled by the UP or DN key) on the counters display and activates all key functions labeled in blue. The OFFSET FREQ key function is in LOCAL control unless the REMOTE indicator is illuminated. When  key is pressed again and extinguished, and  pressed, counter displays the measurement. Successive presses will result in alternate display of measured and offset frequencies. The offset frequency is positive unless the minus (-) sign is displayed (controlled by the  key).

MEASUREMENT KEYS

 When key is pressed and illuminated, a manual frequency measurement is displayed, provided a manual center frequency, within 50 MHz of the input signal has been entered via the  function (DATA ENTRY).

When either DATA ENTRY key is in effect (illuminated) the UP function will cause the display to count up while the UP key is held in. If both the MANUAL and OFFSET keys are pressed simultaneously, the display will reset.

 When key is pressed and illuminated, a resultant frequency (sum or difference of input signal and offset frequency) is displayed, provided an offset frequency has been entered via the  key.

When either DATA ENTRY key is in effect (illuminated) the DN function will cause the display to count down while the DN key is held in.

NOTE

If both  keys are pressed simultaneously, the display will reset.



Figure 3-1. Front Panel Controls, Connectors and Indicators (Continued)



When key is pressed and illuminated, a CW signal input frequency is automatically acquired, measured and displayed. *The CW measurement mode is initiated whenever power is applied to the plug-in.*



When the **OFFSET FREQ LOCAL** key function is active (illuminated) the DEC PT (blue-label) function is active. With at least 3 digits displayed, the DEC PT key shifts the decimal point on the display to the right one place for each of the first two presses of the DC PT key, then two places to the left on the third press. This sequence repeats for successive presses of the key.



When key is pressed and illuminated, a pulsed RF signal input frequency is automatically acquired, measured and displayed.

NOTE

To operate in PULSE mode, the GATE OUT connector on the rear panel of the 5355A must be connected to the GATE CONTROL INPUT connector on the rear panel of the 5345A.



When the **OFFSET FREQ LOCAL** key function is active (illuminated) the UNITS (blue-label) function is active. The UNITS key shifts the displayed resolution annunciator from GHz to MHz, kHz, Hz, and μ Hz, respectively, with each successive press of the UNITS key.

NOTE



If both the **DEC PT** and **SET LAST MEAS** keys are pressed



simultaneously (SET LAST MEAS) the last measurement will be displayed on the 5345A if the 5355A is in the **OFFSET FREQ** or **MAN FREQ DATA ENTRY** mode. (See Table 3-5.)

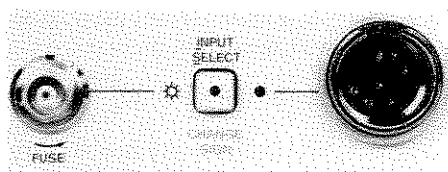

When key is pressed and illuminated, the 0.4 to 1.6 GHz is connected. Otherwise, the RF HEAD INPUT is connected. If the 5356A/B/C Frequency Converter Head is not connected to the 5355A, the 0.4 to 1.6 GHz input is automatically selected when power is applied.



When the **OFFSET FREQ LOCAL** key function is active (illuminated) the CHANGE SIGN key function is active. Each time the key is pressed, the minus (-) sign changes (on or off) in the display.

Figure 3-1. Front Panel Controls, Connectors and Indicators (Continued)

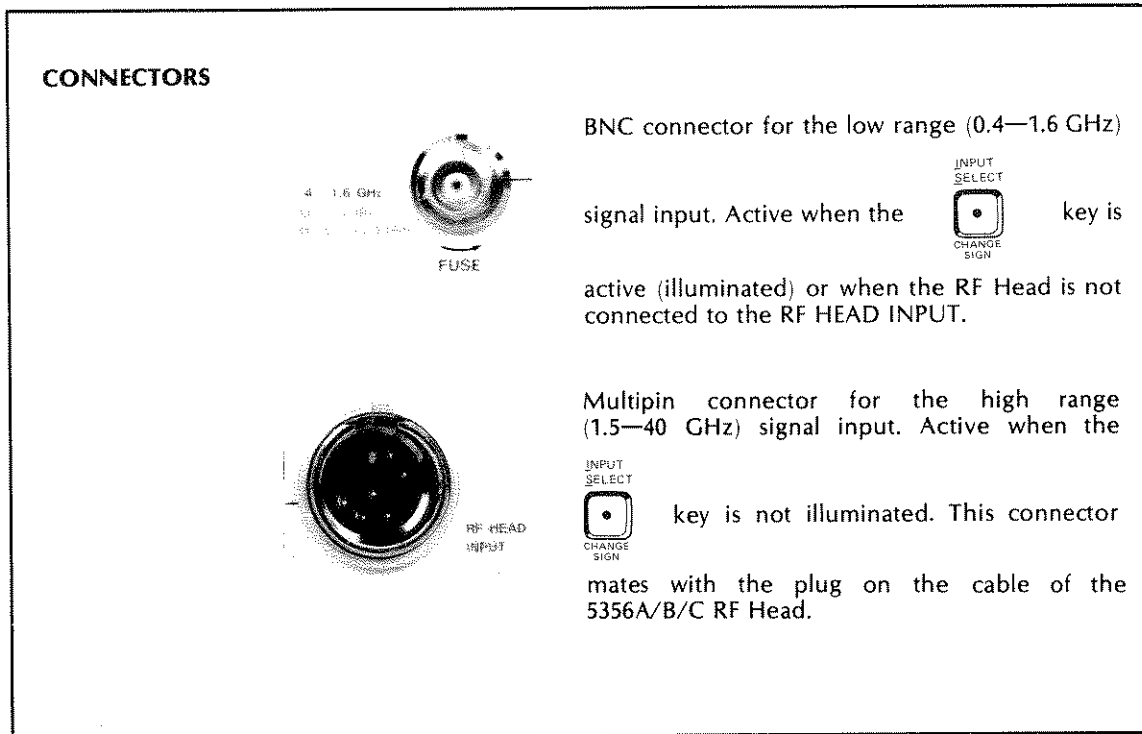

Figure 3-1. Front Panel Controls, Connectors and Indicators (Continued)

3-9. Operating Modes

3-10. Operating modes are selected by the front panel pushbutton keys. The following modes may be selected:

- a. CW
- b. Pulsed RF
- c. Manual
- d. Offset

3-11. CW Mode





3-12. The automatic mode of operation for CW signals is initiated by applying power to the instrument. Input CW signals are acquired, measured and displayed automatically. The illuminated indicator in the CW key shows the operator that this mode of operation is in effect. If other key indicators are illuminated, the 5355A is operating in the mode indicated.



3-13. Pulsed RF Mode

3-14. The Pulsed RF mode (for reception of pulsed RF signals) is initiated by pressing  on the front panel. To operate in this mode, the GATE OUT connector on the rear panel of the 5355A must be connected to the GATE CONTROL INPUT connector on the rear panel of the 5345A. Input pulsed RF signals are acquired, measured, and displayed automatically. The illuminated indicator in the PULSE key shows the operator that this mode of operation is in effect. Measurement of a pulsed RF signal is described in *Table 3-2*.

3-15. Manual Mode

3-16. The manual mode of operation is initiated by pressing the  key. To operate in this mode, the input signal frequency must be known within 50 MHz and this manual frequency must be entered into the display prior to the measurement. Use of the manual mode is described in the following paragraph and an example is shown in *Table 3-3*.

3-17. Pressing the  key results in a display of the low frequency listed below (or a previously entered manual frequency). The  key indicator lights and the gold-labeled key functions are in effect. Press and hold the  key to cause the display to count up to the high frequency listed below in .1 GHz (100 MHz) steps. Press and hold the  key to cause the display to count down to the low frequency in .1 GHz steps. These keys are used to set the display to a frequency within .1 GHz of the input signal. Press and release the





 key to depart the DATA ENTRY function and press  to enter the MEASURE-



MENT function. The following table lists the high and low frequency displayed for each mode of the 5356 Frequency Converter Heads:

| Head Installed | Displayed High Frequency (GHz) | Displayed Low Frequency (GHz) |
|-------------------|--------------------------------|-------------------------------|
| 5356A/B | 40 | 1.5 |
| 5356B, Option 001 | 27.7 | 17 |
| 5356C | 60 | 1.5 |
| 5356C, Option 001 | 60 | 17 |



3-18. OFFSET Mode

3-19. The OFFSET mode is used to add or subtract a constant to/from a measurement. For example, a radio frequency can be measured by measuring the local oscillator frequency and then adding the IF as a positive offset. Use of the OFFSET mode is described in the following paragraph and an example is shown in *Table 3-4*.

3-20. The OFFSET mode of operation is initiated by pressing the  key, which results in a display of -1 GHz (or a previously entered offset frequency). The  key indicator lights and the blue-labeled key functions are in effect.   keys cause the display to count up or down between 1. and 9. GHz to select the offset frequency. The display can be expanded and the resolution of the offset frequency increased by using the

 key and  key functions. In addition,  key can be used for limited

shifting of the decimal point. The  key adds two digits to the display each time it is pressed for a total of 10 decimal places. The  key changes the display annunciators from GHz to MHz, kHz, Hz, mHz, and μ Hz.

3-21. When the offset frequency has been selected as described in the preceding paragraph, press and release the  key to depart the DATA ENTRY mode and press  key to enter the OFFSET mode.

3-22. Remote Programming Mode

3-23. The 5355A is remotely controlled via internal interface circuits and a rear panel connector to the Hewlett-Packard Interface Bus (HP-IB). The 5355A operates in the Listen Only mode. Remote programming is described in detail in paragraph 3-58.

3-24. The REMOTE indicator on the front panel, when illuminated, indicates the 5355A is under remote operation and all front panel controls are inoperative, except  pushbutton (unless the Local Lockout command has been sent).



3-25. The LISTENING indicator on the front panel, when illuminated, indicates the 5355A is addressed and monitoring the interface bus.

3-26. AM Tolerance

3-27. The 5355A/5345A will measure carrier frequencies containing amplitude modulation to any modulation index provided the minimum voltage of the signal is greater than the sensitivity specification of the 5355A.

3-28. FM Tolerance

3-29. The 5355A/5345A will measure carrier frequencies which are modulated in frequency such as a microwave radio carrier. The FM tolerance is the worst case FM deviation which can be present without affecting the counters ability to acquire the signal. If the deviations about the carrier are symmetrical, then the counter averages out the deviations to measure the actual carrier frequency. The FM tolerance is determined by the mode of operation. See *Table 1-1*. The auto mode provides FM tolerance of 15 MHz peak-to-peak. A special FM mode is selected by

pressing  and  simultaneously (in CW auto mode). The special FM mode provides a tolerance of 60 MHz peak-to-peak but results in slower acquisition time (1.1 second compared to 400 milliseconds for CW position).

NOTE

Most measurements should be made without using the special FM mode. The special FM mode should be used only when the input signal has significant amounts of FM (>15 MHz p-p).

3-30. Automatic Amplitude Discrimination (CW Mode)

3-31. The automatic amplitude discrimination feature allows the 5355A to acquire and display the highest level signal within its sensitivity range. The highest level signal must be 8 dB greater in amplitude than any other signal present within 500 MHz and 20 dB greater than any signal over the full range. This feature is useful for discriminating against spurious signals and harmonics.

3-32. OPERATING PROCEDURES

3-33. Operating procedures for the 5355A are given in the following paragraphs. Refer to *Figures 3-1* and *3-2* for descriptions of front and rear panel controls, connectors and indicators, and to *Tables 3-2* through *3-5* for specific examples. Power-up codes are described in paragraph 3-54, Frequency Converter Head codes in paragraph 3-56, and frequency range coverage in *Table 8-21*. Refer to the 5345A manual for operating procedures for the 5345A.

3-34. Preliminary Procedures

3-35. To operate the 5355A and 5345A combined, perform the following preliminary procedures:

- a. Set the 5345A POWER switch to STANDBY.
- b. Set the 5345A FUNCTION switch to PLUG-IN.
- c. Install the 5355A into the 5345A as described in Section II, and attach GATE cable as described in paragraph 3-14.
- d. Set the 5345A SAMPLE RATE fully ccw.
- e. Set 5345A DISPLAY POSITION switch to AUTO, GATE TIME switch to 100 μ s, and channel select switch to COM A or SEP.
- f. Set 5345A rear panel GATE CONTROL INPUT switch to INTERNAL.

3-36. CW Signal Operation

3-37. Perform the preliminary procedures in paragraph 3-35 and proceed:

CAUTION

Do not connect signals with power levels greater than +24 dBm to the BNC input connector.

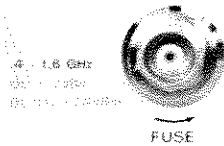

- a. For source signals in the .4 to 1.6 GHz range, connect the signal from the source to the BNC connector on the front panel of the 5355A.

CAUTION

Do not connect signals with power levels greater than 300 milliwatts (+25 dBm), peak to the 5356A/B/C Frequency Converter Head. Higher power levels may damage internal circuits.

- b. For signals in the 1.5—40 GHz range, refer to *Table 1-2* for the 5356 model to use. Connect the Frequency Converter Head to the source and connect the attached cable to the 5355A.



- c. Set the 5345A POWER switch to ON.

- d. If the signal is of sufficient amplitude to light the 5355A SIGNAL indicator, the signal will be automatically measured and displayed on the 5345A.
- e.  indicator light should be on.

3-38. Pulsed RF Signal Operation

3-39. Use the same procedures as in CW Signal Operation (paragraph 3-37) except as follows (see Table 3-2):

NOTE





In the following step, use of a cable of different length may cause measurement errors.

- a. Connect the GATE OUT connector on the rear panel of the 5355A to the GATE CONTROL INPUT connector on the rear panel of the 5345A, using the 10502A cable provided.
- b. Place the 5345A GATE CONTROL switch to INT. (In this switch position a control signal from the 5355A automatically sets the 5345A to EXT GATE mode when PULSE mode on the 5355A is selected and to INT GATE mode when CW mode on the 5355A is selected. However, older 5345A's with Serial Prefix 1744A and below do not have this capability. For these 5345A's when in PULSE mode, set the 5345A GATE CONTROL switch to EXT and when in CW mode, set the switch to INT. A minor modification (see paragraph 8-13) can be made which updates the older 5345A's for automatic selection of EXT/INT GATE.)
- c. Press  key on the front panel of the 5355A.

NOTE

In the 5355A's PULSE mode, a calibration factor is automatically computed during the first 10 measurements (a  is displayed in the 5345A's most significant digit to indicate that the calibration factor is being computed). All subsequent frequency measurements are multiplied by the calibration factor in order to reduce the effects of error. The calibration factor remains unchanged unless the external gate width changes by more than 12% in which case another calibration factor is computed. The accuracy specification applies to readings after the first 10 (see Table 1-1).

3-40. Manual Signal Operation

- a. Press  key and use the  or  to enter a manual center frequency that is within 50 MHz of the input signal frequency.
- b. Press  key again to release the DATA ENTRY mode and press  key to enter the MEASUREMENT mode.

3-42. Offset Measurements









3-43. To make offset measurements proceed as follows (see *Table 3-4*):

- a. Make a CW measurement or a pulsed RF measurement as listed in the applicable procedures in the above paragraphs.

NOTE



In the following step, the offset frequency will be preceded by a minus (-) sign for a negative offset.

To change to a positive offset, press the  key.

- b. Press the  key to display the offset frequency.
- c. Press the  or the  key to change the value of the offset frequency displayed.
- d. Use the  key to expand the display, the  key to move the decimal point and  key to change the units annunciators as described in *Table 3-1*.
- e. Press the  key to extinguish the key indicator and enter the MEASUREMENT mode. The input signal should be displayed.
- f. Press  key to illuminate the key indicator and display the resultant frequency (sum or difference of input signal frequency and offset frequency. Will be the difference if offset displayed was preceded by a minus (-) sign).

3-44. Set Last Measurement Function

3-45. The SET LAST MEAS function (labeled on the front panel) is used in the offset mode or the manual mode to automatically store the last measurement as a negative offset or as a manual

center frequency. This function is accomplished by pressing   keys simultaneously

while in the offset or manual data entry mode. Refer to *Table 3-5* for an example of the SET LAST MEAS function.

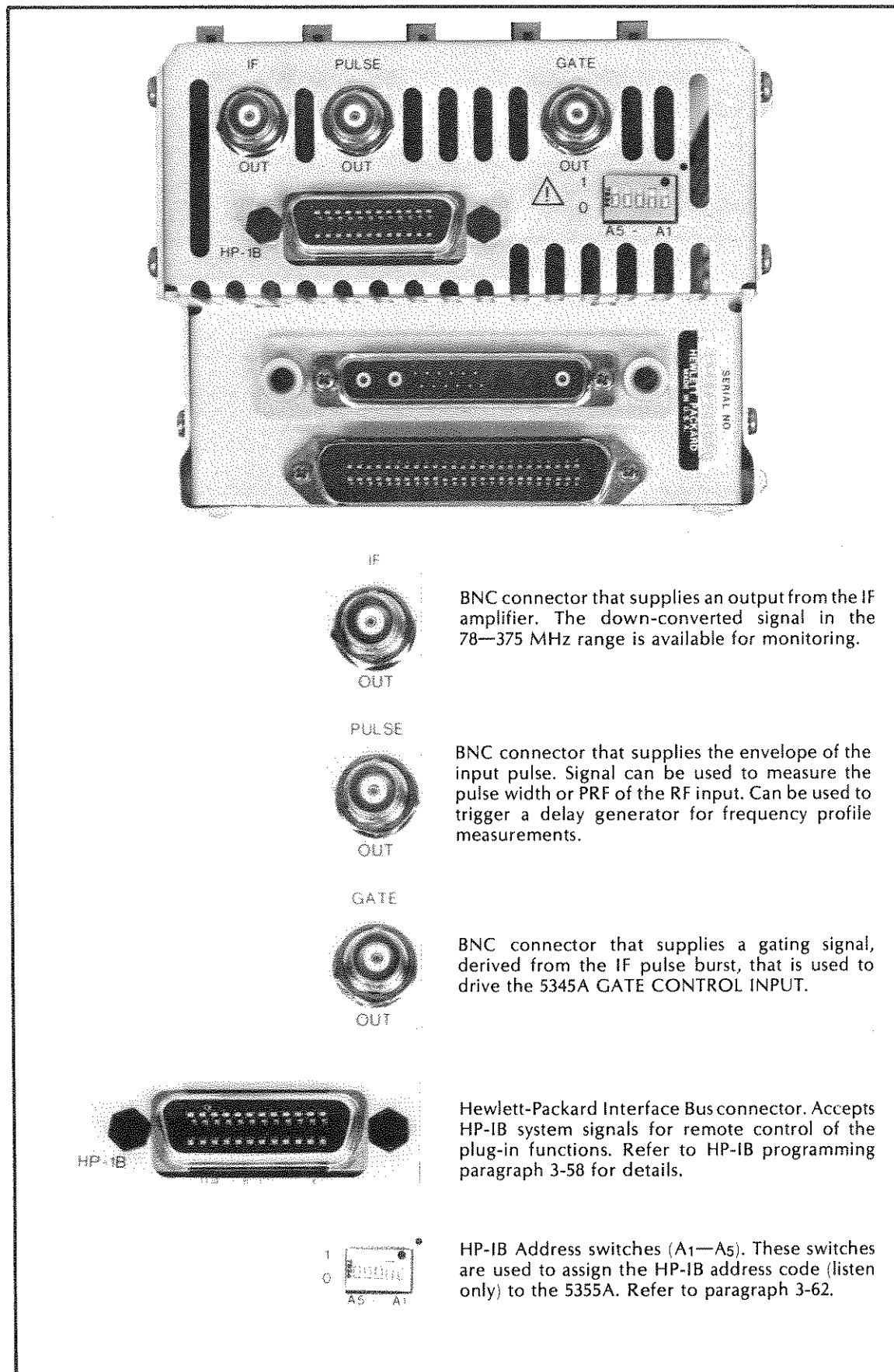

BNC connector that supplies an output from the IF amplifier. The down-converted signal in the 78—375 MHz range is available for monitoring.

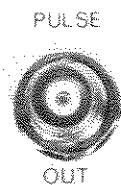

BNC connector that supplies the envelope of the input pulse. Signal can be used to measure the pulse width or PRF of the RF input. Can be used to trigger a delay generator for frequency profile measurements.



BNC connector that supplies a gating signal, derived from the IF pulse burst, that is used to drive the 5345A GATE CONTROL INPUT.

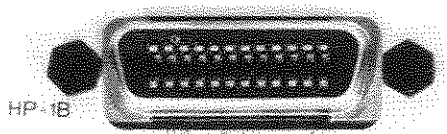

Hewlett-Packard Interface Bus connector. Accepts HP-IB system signals for remote control of the plug-in functions. Refer to HP-IB programming paragraph 3-58 for details.



HP-IB Address switches (A1—A5). These switches are used to assign the HP-IB address code (listen only) to the 5355A. Refer to paragraph 3-62.

Figure 3-2. Rear Panel Control and Connectors

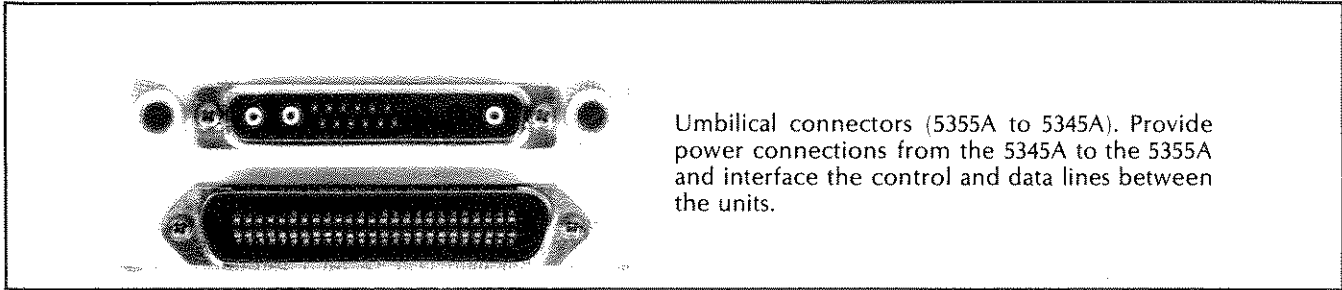

Figure 3-2. Rear Panel Control and Connectors (Continued)

3-46. KEYBOARD CHECK

3-47. Check for proper operation of the keyboard and display by performing the procedures listed in Table 3-1.

Table 3-1. Keyboard Check











| NOTE | | |
|---|--|---|
| Perform the preliminary procedures in paragraph 3-34 and connect a 5356A/B/C Frequency Converter Head to the 5355A prior to proceeding. If a 5356B, Option 001 or 5356C is used refer to paragraph 3-17 for differences in frequencies displayed in steps 4 and 7 through 12. | | |
| STEP | PROCEDURE | RESULTS |
| 1 | Set 5345A POWER switch to ON | All 5355A key LEDs illuminate momentarily. |
| 2 | Press  PULSE UNITS |  CW DEC PT key illuminates. 5345A displays head code momentarily. See paragraph 3-56.) 5345A displays all zeros. |
| 3 | Return to CW mode by pressing  CW DEC PT |  PULSE UNITS key LED illuminates. |
| 4 | Press  MANUAL UP/UP |  CW DEC PT key LED extinguishes. 5345A displays all zeros, except the most significant digit shows  when pulse signal is present (for calibration routine.) See note in paragraph 3-39 for details. |
| 5 | Turn manual mode off by pressing  MANUAL UP/UP | 5345A displays all zeros. |
| 6 | Press  OFFSET DIV/DN | Key LED illuminates. 5345A displays 1.5 GHz for one second, then all zeros. |
| | Turn off offset mode by pressing  OFFSET DIV/DN | Key LED extinguishes. |
| | | Key LED illuminates. 5345A displays -1.0000000000 GHz. |
| | | Key LED extinguishes. 5345A displays all zeros. |

Table 3-1. Keyboard Check (Continued)













| STEP | PROCEDURE | RESULTS |
|------|---|--|
| 7 | Press  | Key LED illuminates. 5345A displays 1.5 GHz. CW key LED extinguished. NOTE Leave MAN FREQ mode in effect (key LED on) for steps 8 through 12. |
| 8 | Press and release  | 5345A displays increments by 0.1, i.e., display increases to 1.6. |
| 9 | Press and hold  | 5345A displays rapidly increments up to 40 and rolls over to 1.5. |
| 10 | Press and release  | 5345A decrements by 0.1 each time the key is pressed. If display is 1.5 before pressing key, display will roll back to 40. |
| 11 | Press and hold  | 5345A display rapidly decrements back to 1.5 before rolling over to 40. |
| 12 | Simultaneously press   | 5345A display resets to 1.5. |
| 13 | Press  to turn off manual mode | Key LED extinguishes. 5345A displays all zeros. |
| 14 | Press  | Key LED illuminates. 5345A displays -1. GHz. CW key LED extinguishes. NOTE Leave OFFSET FREQ mode in effect (key LED on) for steps 15 through 25. |
| 15 | Press and release  | 5345A displays increments by 1 each time key is pressed. |
| 16 | Press and hold  | 5345A rapidly increments up to 9, then rolls over to 1. |
| 17 | Press and release  | 5345A display decrements by 1 each time key is pressed. |
| 18 | Press and hold  | 5345A display rapidly decrements. |

Table 3-1. Keyboard Check (Continued)













| STEP | PROCEDURE | RESULTS |
|------|--|---|
| 19 | Press and release  | 5345A displays two additional zeros. These two digits may be incremented by the  key and decremented by the  key. |
| 20 | Simultaneously press and release    | 5345A display resets to -1. GHz. |
| 21 | Press and release  | 5345A minus sign (-) display goes blank. Press this key again to display minus sign. |
| 22 | Press  | 5345A displays -1.00 GHz. |
| 23 | Press and release  | 5345A display decimal point shifts one place to the right each time the key is pressed for the first two presses, then shifts two places to the left for the third press. This sequence repeats. |
| 24 | Press and release  | For each press of the key, the 5345A displays a different unit of measurement, in the following order: GHz, MHz, kHz, Hz, mHz, and μ Hz. Displays -1. with μ Hz. |
| 25 | Turn off the OFFSET FREQ mode by pressing  | 5345A displays all zeros. |
| 26 | Press  | Key LED illuminates. |

Table 3-2. Pulsed RF Measurements



| NOTE | | |
|--|---|---|
| Connect the GATE OUT connector on the rear panel of the 5355A to the GATE CONTROL INPUT connector on the rear panel of the 5345A, using 10502A cable provided. | | |
| STEP | PROCEDURE | RESULTS |
| 1 | Perform the preliminary procedures in paragraph 3-34. Set the 5345A POWER switch to ON. | The 5355A key LEDs illuminate momentarily.  key illuminates. 5345A displays head code momentarily. (See paragraph 3-56.) 5345A displays all zeros. |
| 2 | Apply pulsed RF signal to RF HEAD INPUT and press  | SIGNAL LED and  LED illuminate. 5345A displays signal frequency. |

Table 3-3. Manual Measurements





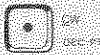

| NOTE | | |
|---|--|---|
| The manual measurement mode decreases acquisition time (see Table 1-1) and can be used if the input frequency is known within 50 MHz. | | |
| STEP | PROCEDURE | RESULTS |
| 1 | Perform the preliminary procedures in paragraph 3-34. Set the 5345A POWER switch to ON. | The 5355A key LEDs illuminate momentarily.  key illuminates. 5345A displays head code momentarily. (See paragraph 3-56.) 5345A displays all zeros. |
| 2 | Press  | Key LED illuminates. 5345A displays the low frequency listed in paragraph 3-17. |
| 3 | Press and Hold  until displayed number is within 50 MHz of the known input signal frequency. | 5345A displays selected number. |
| 4 | Press and release  Press  | Key LED extinguishes. Key LED illuminates. 5345A displays input signal frequency. CW key LED illuminates. SIGNAL LED illuminates. |

Table 3-4. Offset Measurements

NOTE

The offset measurement mode allows a constant to be added to or subtracted from a measurement, as shown below.

| STEP | PROCEDURE | RESULT |
|------|---|---|
| 1 | Perform the preliminary procedures in paragraph 3-34. Set the 5345A POWER switch to ON. | The 5355A key LEDs illuminate momentarily.  key illuminates. 5345A displays head code momentarily. (See paragraph 3-56.) 5345A displays all zeros. |
| 2 | Press  | Key LED illuminates. 5345A displays -1. GHz. |

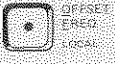
NOTE

Steps 3 through 9 show how to expand the number of digits in the display, position the decimal point and select displayed resolution for precise offset frequencies. If these procedures are understood, proceed to step 10.













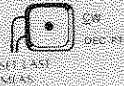

| | | |
|----|---|---|
| 3 | Press  | 5345A display changes from -1. to -1.00 GHz. |
| 4 | Repeat step 3 four more times | 5345A display adds two zeros each time key is pressed (for a total of 10 zeros). |
| 5 | Press  | Key LED illuminates. Decimal point moves one place to right. |
| 6 | Repeat step 5 | Same as step 5. |
| 7 | Repeat step 5 | Decimal point moves two places to left. |
| 8 | Press  | 5345A display changes from GHz to MHz. |
| 9 | Repeat step 8 five more times. | 5345A display changes from MHz to kHz, Hz, mHz, μ Hz, and back to GHz, in that order. |
| 10 | Using procedures described in steps 3 through 9, select desired offset frequency. | 5345A displays offset frequency. |
| 11 | Apply signal to be measured to RF HEAD INPUT, then press  | Key LED extinguishes. 5345A displays input signal. |
| 12 | Press  | Key LED illuminates. 5345A displays resultant frequency. |

Table 3-5. Set Last Measurement Functions

NOTE

For automatic offset mode or manual mode operation perform the preliminary procedures in paragraph 3-34, and connect the signal to be measured to the 5355A. Perform steps 1 through 3 for manual mode. Perform steps 4 through 6 for offset mode of operation.

| STEP | PROCEDURE | RESULTS |
|------|---|--|
| 1 | <p>FOR MANUAL MODE:</p> <p>To set the last measurement as a manual center frequency press .</p> <p>Simultaneously press  and .</p> | <p>Key LED illuminates. 5345A displays any previously entered manual center frequency or the low frequency (listed in paragraph 3-17).</p> <p>Sets the manual center frequency determined by the last measurement.</p> |
| 2 | <p>Press  to exit the data entry mode.</p> | <p>Key LED extinguishes. 5345A displays input frequency.</p> |
| 3 | <p>Press  to enter the manual mode.</p> | <p>Key LED illuminates. 5345A displays input frequency in manual mode.</p> |
| 4 | <p>FOR OFFSET MODE:</p> <p>To automatically store the last measurement as a negative offset, press: .</p> <p>Simultaneously press:  and .</p> | <p>Key LED illuminates. 5345A displays any previously entered offset or -1. GHz.</p> <p>5345A displays the last measurement as a negative offset.</p> |
| 5 | <p>Press  to exit the offset mode.</p> | <p>Key LED extinguishes. 5345A displays input frequency.</p> |
| 6 | <p>Press  to enter offset mode.</p> | <p>5345A displays the drift of the input frequency.</p> |

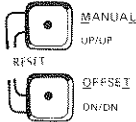

3-48. RESET FUNCTION



3-49. The RESET function, as shown  requires that the MANUAL and OFFSET keys

be pressed simultaneously. This action resets the display during either DATA ENTRY mode of operation. The display resets to 1.5 GHz (or low frequency listed in paragraph 3-17) when in the manual mode and resets to -1. GHz when in the offset mode. The RESET function allows for error correction in the DATA ENTRY mode.

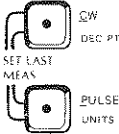
3-50. SPECIAL MODES

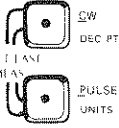

3-51. The two special modes are (1) the FM tolerance mode which increases FM tolerance from 15 MHz p-p to 60 MHz p-p in the automatic mode of operation, and (2) the continuous calibration mode during pulse operation which causes the measurements to be continuously calibrated instead of just the first 10 measurements, as in normal calibration. Procedures for entering the special modes are described below.

3-52. FM TOLERANCE. To enter the special FM tolerance mode during the CW mode of operation, simultaneously press  keys. The  key will continue flashing during this mode.

3-53. CONTINUOUS CALIBRATION. To calibrate continuously during the pulse mode of operation, simultaneously press  keys. A flashing  will be displayed in the most significant digit position during calibration.

3-54. POWER-UP CODES

3-55. When power is applied to the 5355A, certain error codes are displayed on the 5345A to indicate error conditions. Diagnostic indications used for troubleshooting are listed in paragraph 8-197. Operating error indications are listed below:

| DISPLAY | ERROR CONDITION |
|--|--|
|  (CW Automatic only) | 5345A rear panel GATE CONTROL INPUT switch in wrong position. Should be in INTERNAL position. |
|  | Harmonic number (n)=0 due to a low input frequency or due to the CHECK/COM A/SEP switch on 5345A front panel in CHECK position. Should be in COM A or SEP. |
|  | Indicates the CHECK/COM A/SEP switch on 5345A front panel in CHECK position. Should be in COM A or SEP. |

3-56. CONVERTER CODES

3-57. When power is applied to the 5355A certain codes are displayed to indicate which Frequency Converter Head is installed, as follows:

| DISPLAY | HEAD INSTALLED |
|----------------------------|--------------------------------|
| --- -- -- -- --- -- -- -- | 5356A (1.5—18 GHz) |
| --- -- -- -- --- -- -- -- | 5356B (1.5—26.5 GHz) |
| --- -- -- -- --- -- -- -- | 5356B Option 001 (18-26.5 GHz) |
| --- -- -- -- --- -- -- -- | 5356C (1.5—40 GHz) |
| --- -- -- -- --- -- -- -- | 5356C Option 001 (26.5-40 GHz) |

3-58. PROGRAMMING

3-59. Bus Characteristics

3-60. The capability of a device connected to the HP-IB is specified by the interface functions that it has. Table 3-6 lists the interface functions included in the 5355A. The “Interface Function Subset Identifier” refers to the particular capability of the interface function as listed in Appendix C of IEEE Standard 488-1975.

Table 3-6. HP-IB Interface Capability

| INTERFACE FUNCTION SUBSET IDENTIFIER | INTERFACE FUNCTION DESCRIPTION |
|--|--|
| SH0 | No source handshake capability. |
| AH1 | Complete acceptor handshake capability. |
| T0, TE0 | No talker (no basic talker, no serial poll, no talk only mode, does not unaddress to talk if addressed to listen). |
| L2, LE0 | Listener (basic listener, no listen only mode, does not unaddress to listen if addressed to talk). |
| SR0 | No service request capability. |
| RL1 | No complete remote/local capability (with local lockout). |
| PP0 | No parallel poll capability. |
| DC1 | Device clear capability (presets to power-up control states). |
| DT1 | Device trigger capability. |
| C0 | No controller capability. |
| E1 | 1 Unit Bus Load. |
| NOTE: Interface functions provide the means for a device to receive, process and send messages over the bus. | |

3-61. Bus messages are of 12 types. Table 3-7 lists each bus message, a brief description of the message, and the response of the 5355A/5345A to the message. The last column shows typical examples of how to send/receive each message using the 9825A computing controller. For complete details on sending bus messages using the 9825A refer to the “9825A Extended I/O Programming Manual” (Part Number 09825-90025).

Table 3-7. 5355A Bus Message Usage

| Message | Description | 5355A Use | Sample 9825 Statements (5355A Set to Address #2) |
|-------------------------|--|--|--|
| Data | Transfers device-dependent information from one device to one or more devices on the bus. | 5345A sends measurement data via its talk output. 5355A is controlled by program codes. See Table 3-9 for code set. | red 702, A wrt 702, "PRHD1T" |
| Trigger | Causes a group of selected devices to simultaneously initiate a set of device-dependent actions. | Starts a new measurement. | trg 7 or trg 702 |
| Clear | Causes an instrument to be set to a predefined state (a certain range, function, etc.). | Preset code PR presets 5355A to power-up condition and triggers one measurement. | wrt 702 "PR" |
| Remote | Permits selected devices to be set to remote operation, allowing parameters and device characteristics to be controlled by Bus Messages. | 5355A goes to remote if REN is true and addressed to listen. In absence of program data, remote operation is according to the state of the front panel settings just prior to going to remote. | rem 702 |
| Local | Causes selected devices to return to local (front panel) operation. | 5355A goes to local front panel control. In absence of front panel data, local operation is according to the state of the remote data just prior to going to local. | lcl 702 |
| Local Lockout | Disables local (front panel) controls of selected devices. | Disables front panel control. 5355A remains in remote. | llo 7 |
| Clear Lockout and Local | Returns all devices to local (front panel) control and simultaneously clears the Local Lockout Message. | Local lockout cleared and returns to local front panel control. | lcl 7 |
| Require Service | Indicates a device's need for interaction with the controller. | None | — |
| Status Byte | Presents status information of a particular device; one bit indicates whether or not the device currently requires service, the other 7 bits (optional) are used to indicate the type of service required. | None (refer to Table 3-10 for status display). | — |
| Status Bit | A single bit of device-dependent status information which may be logically combined with status bit information from other devices by the controller. | None | — |
| Pass Control | Passes bus controller responsibilities from the current controller to a device which can assume the Bus supervisory role. | None | — |
| Abort | Unconditionally terminates Bus communications and returns control to the system controller. | 5355A unlistens. | cli 7 |

3-62. Address Selection

3-63. The 5355A must be assigned a bus address. *Table 3-8* gives the allowable address switch settings. The setting of switches A₁ through A₅ defines the addresses. The listen address (*Table 3-8*) is used to program the functions of the 5355A.

3-64. Before learning the programming details of the 5355A, some knowledge of 5345A programming is required, as described below.

3-65. Programming the 5355A/5345A

3-66. The 5355A is programmed for remote control of all its operating modes by the codes shown in *Table 3-9*. The 5355A operates remotely only in the listen function and does not output to the HP-IB.

3-67. Measurement data from the 5355A is sent to the 5345A for processing and display. This information is sent to the HP-IB via the talk output of the 5345A which must be programmed by the codes shown in the 5345A Operating and Service Manual, except as described in paragraph 3-68 below.

NOTE

5345A program codes E9 and J1 are invalid when the 5355A is plugged in, as detailed in the following paragraph.

3-68. INVALID 5345A PROGRAM CODES. The 5345A program codes E9 (Sample Rate Hold) and J1 (Sample Trigger Command) are invalid when the 5355A is plugged into the 5345A. These functions are performed by programming the 5355A plug-in using the Hold code, i.e., HD0 selects the 5345A Sample Rate and HD1 is used in place of the normal 5345A code E9 for Sample Rate Hold. (Refer to *Table 3-9*).

NOTE

When the 5345A is operating in remote control, the rear panel GATE CONTROL INPUT switch function must be programmed according to the operating mode of the 5355A. The 5345A must be programmed for External Gate (E;) when the 5355A is in the pulse mode of operation. The 5345A must be programmed for Internal Gate (E3) when the 5355A is in the CW mode of operation.

3-69. Status Display

3-70. The status of the 5355A operation is shown on the display of the 5345A when program code R (Read Status) is sent to the 5355A. The display contains a digit in each position that indicates the mode of operation (first 8 digits) the head code (9th digit) and the error code or diagnostic mode (10th and 11th digits) as illustrated in *Table 3-10*. The head code indicates which Frequency Converter Head is installed. The error codes are described in paragraph 3-54. Diagnostic modes are described in *Table 3-11*.

Table 3-8. Address Selection

ADDRESS SWITCHES



NOTE

Select the listen address from the table below and set the address switches to the corresponding positions.

| ASCII CODE CHARACTER | ADDRESS SWITCHES | | | | | 5-BIT DECIMAL CODE | OCTAL CODE |
|----------------------|------------------|----|----|----|----|--------------------|------------|
| | LISTEN | A5 | A4 | A3 | A2 | | |
| SP | | 0 | 0 | 0 | 0 | 0 | 040 |
| ! | | 0 | 0 | 0 | 0 | 1 | 041 |
| " | | 0 | 0 | 0 | 1 | 0 | 042 |
| # | | 0 | 0 | 0 | 1 | 1 | 043 |
| \$ | | 0 | 0 | 1 | 0 | 0 | 044 |
| % | | 0 | 0 | 1 | 0 | 1 | 045 |
| & | | 0 | 0 | 1 | 1 | 0 | 046 |
| ' | | 0 | 0 | 1 | 1 | 1 | 047 |
| (| | 0 | 1 | 0 | 0 | 0 | 050 |
|) | | 0 | 1 | 0 | 0 | 1 | 051 |
| * | | 0 | 1 | 0 | 1 | 0 | 052 |
| + | | 0 | 1 | 0 | 1 | 1 | 053 |
| , | | 0 | 1 | 1 | 0 | 0 | 054 |
| - | | 0 | 1 | 1 | 0 | 1 | 055 |
| . | | 0 | 1 | 1 | 1 | 0 | 056 |
| / | | 0 | 1 | 1 | 1 | 1 | 057 |
| 0 | | 1 | 0 | 0 | 0 | 0 | 060 |
| 1 | | 1 | 0 | 0 | 0 | 1 | 061 |
| 2 | | 1 | 0 | 0 | 1 | 0 | 062 |
| 3 | | 1 | 0 | 0 | 1 | 1 | 063 |
| 4 | | 1 | 0 | 1 | 0 | 0 | 064 |
| 5 | | 1 | 0 | 1 | 0 | 1 | 065 |
| 6 | | 1 | 0 | 1 | 1 | 0 | 066 |
| 7 | | 1 | 0 | 1 | 1 | 1 | 067 |
| 8 | | 1 | 1 | 0 | 0 | 0 | 070 |
| 9 | | 1 | 1 | 0 | 0 | 1 | 071 |
| : | | 1 | 1 | 0 | 1 | 0 | 072 |
| ; | | 1 | 1 | 0 | 1 | 1 | 073 |
| < | | 1 | 1 | 1 | 0 | 0 | 074 |
| = | | 1 | 1 | 1 | 0 | 1 | 075 |
| > | | 1 | 1 | 1 | 1 | 0 | 076 |

Table 3-9. 5355A Program Code Set

| FUNCTION | | CODE |
|--|--|---|
| NOTE 1 | | |
| Underlined letters are code letters. Asterisk (*) indicates conditions of 5355A at power up. | | |
| <u>HOLD</u> | | *HD0 (Selects 5345A Sample Rate) HD1 (Sample Rate Hold — Replaces 5345A “E9” T (with HD1 — Same as “J1”) |
| <u>TRIGGER</u> (see Note 3 below) | | |
| <u>INPUT SELECT</u> | LOW FREQ *HIGH FREQ | IS1 IS2 |
| <u>MANUAL MODE</u> | *MAN OFF (AUTO) MAN ON | ML0 ML1 |
| <u>CW/PULSE</u> | *CW PULSE | CP1 } Note: If 5345A is in REMOTE you must program CP2 } ext/int gate (CP1-int, CP2-ext). |
| <u>OFFSET MODE</u> | *NO OFFSET APPLY OFFSET | OT0 OT1 |
| <u>OFFSET FREQUENCY ENTRY</u> | | OF [FLOATING POINT] CR LF |
| <u>MANUAL FREQUENCY ENTRY</u> | | MF [FLOATING POINT] CR LF |
| <u>SPECIAL FUNCTION</u> | | |
| | Pulse mode (normal calibration) } CW mode (normal FM tolerance) } Pulse mode (continuous calibration) } CW mode (High FM tolerance) } | *SF0 SF1 |
| <u>DIAGNOSTIC DISPLAY</u> | | *DD00 DD07 DD01 DD08 DD02 DD09 DD03 DD10 DD04 DD11 DD05 DD12 DD06 etc. |
| | See Table 3-11 | |
| <u>PRESET CONTROLS</u> | (Immediate Execute) | *PR (Presets to 5355A power-up condition and triggers one measurement) with the exception that manual and offset frequencies are not initialized. R (See Table 3-10) |
| <u>READ STATUS</u> | | |
| NOTE 2 | | |
| Program Code R will act as a non-T trigger (see NOTE below for description of non-T triggers) if measurement cycle is not complete or if instrument is out of Hold (in HD0). This condition is indicated when the display starts with a minus (-) sign. | | |
| GROUP COMMANDS: | | |
| LOCAL LOCKOUT | | |
| GO TO LOCAL | | |
| DEVICE CLEAR | } See NOTE 3 | |
| SELECTED DEVICE CLEAR | | |
| GROUP EXECUTE TRIGGER | } See NOTE 4 | |
| NOTE 3 | | |
| Any HP-IB program code sequence will also trigger the 5355A, however, a non-T trigger will restart a measurement sequence to cause restarts of the 10 measurement calibration. The T trigger will calibrate the first 10 measurements then stop calibration (normal measurement sequence). Some non-T trigger are: N, CP2, DEVICE CLEAR, etc. | | |
| NOTE 4 | | |
| When the 5355A is in Remote and programmed to HOLD (HD1), the Group Execute Trigger acts the same as a T trigger, otherwise it acts the same as Device Clear. | | |

Table 3-10. 5345A Display of 5355A Status

| NOTE | | | |
|---|--|------------------------|---|
| The READ Status (R) code results in the following display of 5355A status on the 5345A display. This status is also available at the 5345A talk output. | | | |
| | MODES OF OPERATION (Digits listed in either row may be displayed to indicate mode) | HEAD CODE | ERROR CODE OR DIAGNOSTIC MODE |
| Display | - 1 1 1 1 1 1 1 1 | 0 | 00 GHz |
| Indication | CW PRS MAN OFF SIG SPEC CAL LLO FUNC | 5356A | NO ERR |
| Display | - 2 2 0 0 0 0 0 0 | 1 | 01 GHz |
| Indication | PS HD NO NO NO NO NO NO MAN OFF SIG SPEC CAL LLO FUNC | 5356B | See Table 3-11 for 01 through 19 |
| | | 2 5356B OPT. 001 | 77 N=0. 5345A "CHECK" switch position error possible. |
| | | 4 5356C | 99 5345A GATE CONTROL Switch Position Error |
| | | 5 5356C Opt. 001 | 88 5345A "CHECK" switch position error certain. No synthesizer power up test. |
| | | 7 No Head | |

| MODE | DISPLAY |
|-----------|----------------------------|
| CW | = Continuous Wave 1 |
| PS | = Pulse 2 |
| PRS | = Prescaler 1 |
| HD | = Head 2 |
| MAN | = Manual 1 |
| OFF | = Offset 1 |
| SIG | = Signal 1 |
| SPEC FUNC | = Special Function 1 |
| CAL | = Calibrate 1 |
| LLO | = Local Lockout 1 |
| 5356 | = Head Code 0-7 |
| NO ERR | = No Error 00 |

| NOTE | |
|---|--|
| The decimal point (.), and GHz annunciator shown above are standard on each status display. The first eight digits show operating modes, the ninth digit shows the type of Frequency Converter Head installed, the tenth and eleventh digits show the error code or diagnostic mode (see Table 3-11). The display contains a minus sign (-) before the first digit to indicate a non-T trigger (see Table 3-9). | |

Table 3-11. Diagnostic Modes and Special Functions

| NOTE | | | | | | | | | | | | |
|---|--|--|--|--|---------|------|-----|----|-----|---|-----|----|
| <p>IN LOCAL operation the diagnostic modes listed below are obtained in numerical sequence by pressing the gold MAN FREQ and blue OFFSET FREQ keys simultaneously. Observe the display for the mode number listed below to determine the diagnostic mode of the 5355A each time the keys are pressed. If diagnostic mode (1-10) is started in one column, the sequence will stay in that column. Press reset on 5345A and set desired operational mode on 5355A to restart sequence. In REMOTE operation, the diagnostic modes are programmed by use of the codes shown in Table 3-9.</p> | | | | | | | | | | | | |
| MODE <small>† second display each time gold and blue key is pressed</small> | 0.4—1.6 GHz INPUT | | RF HEAD INPUT | | | | | | | | | |
| | Column 1 CW | Column 2 PULSE | Column 3 CW | Column 4 PULSE | | | | | | | | |
| DIAGNOSTIC MODES | | | | | | | | | | | | |
| 01 | Displays 885.2 MHz self-check frequency (synthesizer set to 1 GHz). | | Displays synthesizer frequency to 100 kHz resolution. | | | | | | | | | |
| 02 | NA | Displays ratio of measured pulse width to reference pulse width. | Displays calculated N number. Ignore annunciator and round to nearest integer. (-) sign means add IF. | | | | | | | | | |
| 03 | NA | * Displays reference pulse width. † | Displays (A-B) counts from synthesizer during N determination. | Displays calibration factor. Ignore annunciator. | | | | | | | | |
| 04 | NA | * Displays measured pulse width. | Displays (A-B) counts from IF during N determination. | Displays ratio of measured pulse width to reference pulse width. | | | | | | | | |
| 05 | Displays prescaler frequency; i.e., input frequency divided by 8. | | Displays IF frequency. | * Displays measured pulse width. | | | | | | | | |
| 06 | NA | Displays calibration factor. Ignore annunciator. | NA | * Displays reference pulse width. † | | | | | | | | |
| 07 | | NA | NA | Displays IF ₁ during N determination. | | | | | | | | |
| 08 | | NA | NA | Displays IF ₃ during N determination. | | | | | | | | |
| 09 | | NA | Manual mode frequency measurements with synthesizer set to frequency entered in offset mode. | | | | | | | | | |
| 10 | | NA | Displays IF frequency produced by synthesizer set to frequency entered in offset mode. | | | | | | | | | |
| SPECIAL FUNCTIONS | | | | | | | | | | | | |
| 11 | The integer M in the equation $f_{\text{displayed}} = M \cdot f_{\text{measured}} \pm B$ may be entered. Go to OFFSET mode; M is the integer located in the second through fifth digits; 0001 to 9999. | | | | | | | | | | | |
| 12 | Measurements made are multiplied by M entered in mode 11. An offset may also be entered. | | | | | | | | | | | |
| 13 | Bypasses 5345A SAMPLE RATE (Manual and Auto) | | Bypasses 5345A SAMPLE RATE (Manual and Auto) | | | | | | | | | |
| 14 | Disables calibration All Modes (Manual and Auto) | | Disables calibration All Modes (Manual and Auto) | | | | | | | | | |
| 15 | Both 13 and 14 above | | Both 13 and 14 above | | | | | | | | | |
| 16-19 | Unassigned (Will reset sequence) | | | | | | | | | | | |
| 16 | VCO search at low gain. Used to adjust A5R10 | | NOTES: † Reference pulse width is measured during calibration only. * Pulse width measurements are displayed by annunciators equivalent to time, as follows: <table style="margin-left: auto; margin-right: auto;"> <tr> <td style="text-align: center;">Display</td> <td style="text-align: center;">Time</td> </tr> <tr> <td style="text-align: center;">kHz</td> <td style="text-align: center;">ns</td> </tr> <tr> <td style="text-align: center;">MHz</td> <td style="text-align: center;">μ</td> </tr> <tr> <td style="text-align: center;">GHz</td> <td style="text-align: center;">ms</td> </tr> </table> | | Display | Time | kHz | ns | MHz | μ | GHz | ms |
| Display | Time | | | | | | | | | | | |
| kHz | ns | | | | | | | | | | | |
| MHz | μ | | | | | | | | | | | |
| GHz | ms | | | | | | | | | | | |
| 17 | VCO search at high gain. Used to adjust A5R7 | | | | | | | | | | | |

3-71. SAMPLE PROGRAM

3-72. A sample program for the 5355A is shown below. The 5355A is set to address 08 and the 5345A is set to address 18. The 9825A controller is used with the following equipment installed:

- a. 98210A String-Advanced Programming ROM.
- b. 98213A or 98214A or 98216A General-Extended I/O ROM.
- c. 98034A Interface Card.

```
0: dim AS[25]
1: wrt 718,"I2F2E;I1";wait 100
2: wrt 708,"PRCP2HD1";wait 100
3: wrt 708,"R";red 718,AS;pvt AS
4: wrt 708,"HD0"
5: red 718,AS;pvt AS
6: end
*982
```

```
-2.2001000000E+9
2.997629094E+9
```

3-73. This printout shows a program for reading 5355A status ("R") to be displayed on the 5345A and sent to the 9825A for display and listing. The status is listed at the end of the program. Then a pulse measurement is made and printed out below the status printout.

