



OPERATING AND PROGRAMMING MANUAL

MODEL 54100A/D

DIGITIZING OSCILLOSCOPE

This manual supports 54100A's
with serial prefix 2614A and
54100D's with serial prefix 2615A.

If your instrument has a lower
prefix use Operating and Programming
Manual with HP part no. 54100-90901.

©COPYRIGHT HEWLETT-PACKARD/COLORADO SPRINGS DIVISION
1900 GARDEN OF THE GODS ROAD, COLORADO SPRINGS, COLORADO U.S.A.

ALL RIGHTS RESERVED

Manual Part No. 54100-90906
Microfiche Part No. 54100-90806

PRINTED: MARCH 1986

SAFETY

This product has been designed and tested according to International Safety Requirements. To ensure safe operation and to keep the product safe, the information, cautions, and warnings in this manual, must be heeded. Refer to Section I and the Safety Summary for general safety considerations applicable to this product.

This apparatus has been designed and tested in accordance with IEC publication 348, safety requirements for electronic measuring apparatus, and has been supplied in a safe condition. This manual contains some information and warnings which have to be followed by the user to ensure safe operation and to retain the apparatus in safe condition.

CERTIFICATION

Hewlett-Packard Company certifies that this product met its published specifications at the time of shipment from the factory. Hewlett-Packard further certifies that its calibration measurements are traceable to the United States National Bureau of Standards, to the extent allowed by the Bureau's calibration facility, and to the calibration facilities of other International Standards Organization members.

WARRANTY

This Hewlett-Packard product is warranted against defects in material and workmanship for a period of one year from date of shipment. During the warranty period, Hewlett-Packard Company will, at its option, either repair or replace products which prove to be defective.

For warranty service or repair, this product must be returned to a service facility designated by HP. However, warranty service for products installed by HP and certain other products designated by HP will be performed at Buyer's facility at no charge within the HP service travel area. Outside HP service travel areas, warranty service will be performed at Buyer's facility only upon HP's prior agreement and Buyer shall pay HP's round trip travel expenses.

For products returned to HP for warranty service, Buyer shall prepay shipping charges to HP and HP shall pay shipping charges to return the product to Buyer. However, Buyer shall pay all shipping charges, duties, and taxes for products returned to HP from another country.

LIMITATION OF WARRANTY

The foregoing warranty shall not apply to defects resulting from improper or inadequate maintenance by Buyer, Buyer-supplied software or interfacing, unauthorized modification or misuse, operation outside of the environmental specifications for the product, or improper site preparation or maintenance.

NO OTHER WARRANTY IS EXPRESSED OR IMPLIED. HP SPECIFICALLY DISCLAIMS THE IMPLIED WARRANTIES OR MERCHANTABILITY AND FITNESS FOR A PARTICULAR PURPOSE.

EXCLUSIVE REMEDIES

THE REMEDIES PROVIDED HEREIN ARE BUYER'S SOLE AND EXCLUSIVE REMEDIES. HP SHALL NOT BE LIABLE FOR ANY DIRECT, INDIRECT, SPECIAL INCIDENTAL, OR CONSEQUENTIAL DAMAGES, WHETHER BASED ON CONTRACT, TORT, OR ANY OTHER LEGAL THEORY.

ASSISTANCE

Product maintenance agreements and other customer assistance agreements are available for Hewlett-Packard products.

For any assistance, contact your nearest Hewlett-Packard Sales and Service Office. Addresses are provided at the back of this manual.

SAFETY CONSIDERATIONS

GENERAL - This is a Safety Class I instrument (provided with terminal for protective earthing).

OPERATION - BEFORE APPLYING POWER verify that the power transformer primary is matched to the available line voltage, the correct fuse is installed, and Safety Precautions are taken (see the following warnings). In addition, note the instrument's external markings which are described under "Safety Symbols."

WARNING

- o Servicing instructions are for use by service-trained personnel. To avoid dangerous electric shock, do not perform any servicing unless qualified to do so.
- o BEFORE SWITCHING ON THE INSTRUMENT, the protective earth terminal of the instrument must be connected to the protective conductor of the (mains) powercord. The mains plug shall only be inserted in a socket outlet provided with a protective earth contact. The protective action must not be negated by the use of an extension cord (power cable) without a protective conductor (grounding). Grounding one conductor of a two-conductor outlet is not sufficient protection.
- o If this instrument is to be energized via an auto-transformer (for voltage reduction) make sure the common terminal is connected to the earth terminal of the power source.
- o Any interruption of the protective (grounding) conductor (inside or outside the instrument) or disconnecting the protective earth terminal will cause a potential shock hazard that could result in personal injury.
- o Whenever it is likely that the protection has been impaired, the instrument must be made inoperative and be secured against any unintended operation.
- o Only fuses with the required rated current, voltage, and specified type (normal blow, time delay, etc.) should be used. Do not use repaired fuses or short circuited fuseholders. To do so could cause a shock or fire hazard.
- o Do not operate the instrument in the presence of flammable gasses or fumes. Operation of any electrical instrument in such an environment constitutes a definite safety hazard.

- o Do not install substitute parts or perform any unauthorized modification to the instrument.
- o Adjustments described in the manual are performed with power supplied to the instrument while protective covers are removed. Energy available at many points may, if contacted, result in personal injury.
- o Any adjustment, maintenance, and repair of the opened instrument under voltage should be avoided as much as possible, and when inevitable, should be carried out only by a skilled person who is aware of the hazard involved.
- o Capacitors inside the instrument may still be charged even if the instrument has been disconnected from its source of supply.

SAFETY SYMBOLS



Instruction manual symbol. The product will be marked with this symbol when it is necessary for the user to refer to the instruction manual in order to protect against damage to the product.



Indicates hazardous voltages.



Earth terminal (sometimes used in manual to indicate circuit common connected to grounded chassis).

WARNING

The WARNING sign denotes a hazard. It calls attention to a procedure, practice, or the like, which, if not correctly performed or adhered to, could result in personal injury. Do not proceed beyond a WARNING sign until the indicated conditions are fully understood and met.



The CAUTION sign denotes a hazard. It calls attention to an operating procedure, practice, or the like, which, if not correctly performed or adhered to, could result in damage to or destruction of part or all of the product. Do not proceed beyond a CAUTION sign until the indicated conditions are fully understood or met.

TABLE OF CONTENTS

SECTION 1 WHEN YOU RECEIVE YOUR INSTRUMENT

| | |
|---|-----|
| Introduction | 1-1 |
| Safety Considerations | 1-1 |
| Accessories Supplied With The 54100A/D..... | 1-1 |
| Options | 1-3 |
| Power Cable..... | 1-3 |
| Initial Inspection..... | 1-3 |
| Claims for Damage..... | 1-3 |
| Storage and Shipment | 1-3 |
| Packaging | 1-5 |

SECTION 2 HOW TO USE THIS MANUAL

| | |
|--|-----|
| Introduction | 2-1 |
| When You Receive Your Instrument, Section 1 | 2-1 |
| Meet The 54100A/D Digitizing Oscilloscope, Section 3 | 2-1 |
| Getting Ready to Use the 54100A/D, Section 4 | 2-1 |
| Getting Started With the Front Panel, Section 5 | 2-1 |
| Familiarize Yourself With the Menus, Section 6 | 2-1 |
| Front Panel Exercises, Section 7 | 2-1 |
| Making a Hardcopy, Section 8..... | 2-2 |
| Remote Control, Section 9..... | 2-2 |
| Command Set Overview, Section 10 | 2-2 |
| Appendix A | 2-2 |
| Appendix B | 2-2 |
| Appendix C | 2-2 |

SECTION 3 SPECIFICATIONS AND SUPPLEMENTAL CHARACTERISTICS

| | |
|--|-----|
| Introduction | 3-1 |
| Vertical..... | 3-2 |
| Horizontal | 3-3 |
| Trigger | 3-3 |
| Inputs | 3-4 |
| Cathode-Ray Tube | 3-5 |
| HP 54100A/D Supplemental Characteristics | 3-6 |
| Digitizer..... | 3-6 |
| Vertical..... | 3-6 |

| | |
|--------------------------|------|
| Horizontal | 3-6 |
| Trigger | 3-6 |
| Display | 3-7 |
| Measurement Aids | 3-8 |
| Setup Aids | 3-9 |
| Power Requirements | 3-9 |
| Environmental | 3-10 |

**SECTION 4
GETTING READY TO USE THE 54100A/D**

| | |
|----------------------------------|-----|
| HP 54100A/D Specifications | 4-1 |
| Operating Environment | 4-1 |
| Power Requirements | 4-1 |
| Power Cable | 4-3 |
| HP-IB Address Selection | 4-4 |
| HP-IB Interconnections | 4-4 |

**SECTION 5
FRONT PANEL**

| | |
|--|-----|
| Getting Started With the Front Panel | 5-1 |
| System Control | 5-1 |
| Save/Recall | 5-2 |
| Local | 5-2 |
| Auto-Scale | 5-3 |
| Entry Devices | 5-3 |
| Menu Selection | 5-3 |

**SECTION 6
FAMILIARIZE YOURSELF WITH THE MENUS**

| | |
|---|------|
| Familiarize Yourself With The Menus | 6-1 |
| Vertical | 6-1 |
| Auto-Scale | 6-1 |
| Channel 1 and Channel 2 Menus | 6-1 |
| Normal Mode | 6-2 |
| Magnify Mode | 6-3 |
| Timebase Menu | 6-4 |
| Trigger Menu | 6-7 |
| Pattern Mode | 6-8 |
| Display Menu | 6-11 |
| Delta V (Volts) Menu | 6-13 |
| Delta T (Time) Menu | 6-15 |
| More | 6-17 |

| | |
|--------------------------------|------|
| Wfm Save (Waveform Save) | 6-17 |
| Wfm Math (Waveform Math) | 6-20 |
| Measure | 6-21 |
| Plot | 6-22 |
| Print | 6-24 |
| Probes | 6-24 |
| Utility | 6-26 |
| Cal Menu | 6-26 |
| HP-IB Menu | 6-30 |

**SECTION 7
FRONT PANEL EXERCISES**

| | |
|----------------------------------|------|
| Introduction | 7-1 |
| Inputting a Signal | 7-1 |
| Front Panel Review | 7-1 |
| Make a Voltage Measurement | 7-2 |
| Time Domain Measurements | 7-5 |
| Delay..... | 7-9 |
| Trigger..... | 7-15 |
| Pattern Mode..... | 7-16 |
| State Mode | 7-19 |
| Display..... | 7-19 |
| Normal Mode..... | 7-19 |
| Averaged Mode..... | 7-21 |
| Probes..... | 7-25 |
| Waveform Math | 7-26 |

**SECTION 8
MAKING A HARDCOPY**

| | |
|-------------------------------|-----|
| Introduction | 8-1 |
| Setting Up the 54100A/D | 8-1 |
| Graphics Printer | 8-1 |
| Compatible Printers | 8-2 |
| Plotters | 8-2 |
| Compatible Plotters | 8-3 |

**SECTION 9
REMOTE CONTROL**

| | |
|----------------------------|-----|
| Introduction | 9-1 |
| HP-IB Compatibility | 9-1 |
| HP-IB Status Display | 9-1 |

| | |
|--|------|
| Remote Mode | 9-1 |
| Local Mode..... | 9-4 |
| Local Lockout | 9-5 |
| Addressing | 9-5 |
| HP-IB Turn-On Default Conditions | 9-6 |
| Data Messages | 9-6 |
| Receiving Data Messages..... | 9-6 |
| Program Order Considerations | 9-7 |
| Program Command Format..... | 9-7 |
| Sending Data Messages | 9-8 |
| Learn and Cal Strings..... | 9-8 |
| Receiving the Clear Message..... | 9-9 |
| Receiving the Trigger Message | 9-9 |
| Receiving the Remote Message | 9-9 |
| Receiving the Local Message..... | 9-9 |
| Receiving the Local Lockout Message..... | 9-9 |
| Receiving the Clear/Set Local Message..... | 9-9 |
| Sending the Require Service Message | 9-10 |
| The Status Word | 9-10 |
| Sending the Status Byte Message..... | 9-10 |
| Receiving the Abort Message..... | 9-11 |

**SECTION 10
COMMAND SET OVERVIEW**

| | |
|--|--------|
| Introduction | 10-1 |
| Command Set Organization | 10-1 |
| Notation Conventions and Definitions | 10-4 |
| Command Abbreviations..... | 10-4 |
| Alpha and Numeric Numeric Arguments..... | 10-5 |
| Data Output (Query) Format | 10-5 |
| Command Order Considerations | 10-5 |
| Default Settings | 10-5 |
| Status Word | 10-6 |
| Programming Examples | 10-6 |
| System Commands | 10-9 |
| Acquire Subsystem..... | 10-33 |
| Channel Subsystem..... | 10-39 |
| Display Subsystem | 10-45 |
| Function Subsystem | 10-61 |
| Graph Subsystem | 10-67 |
| Hardcopy Subsystem | 10-71 |
| Measure Subsystem..... | 10-75 |
| Timebase Subsystem | 10-97 |
| Trigger Subsystem | 10-103 |
| Waveform Subsystem..... | 10-121 |
| Data Movement in the 54100A/D | 10-137 |

**APPENDIX A
EXAMPLE/DEMO PROGRAMS**

| | |
|---|------|
| Introduction | A-1 |
| Vertical Demo Program | A-1 |
| Timebase Demo Program..... | A-2 |
| Hardcopy/Print Demo Program..... | A-4 |
| Hardcopy/Plot Demo Program..... | A-4 |
| Single Shot Demo Program..... | A-5 |
| Learn String Demo Program..... | A-6 |
| Hardcopy/SRQ (Service Request) Demo Program | A-6 |
| Measure Demo Program..... | A-9 |
| Service Request (SRQ) Demo Program | A-11 |

APPENDIX B

| | |
|---|-----|
| Software Delay Calibration and Trigger Delay Optimization..... | B-1 |
|---|-----|

APPENDIX C

| | |
|--|-----|
| Introduction | C-1 |
| Display Mode Considerations..... | C-1 |
| Fine Precision and Coarse Precision Measurements | C-1 |
| Coarse Measurements | C-2 |
| Precise Measurements..... | C-2 |
| Locating the Edge..... | C-2 |

LIST OF TABLES

| | |
|---|-------|
| 1-1. AC Power Cables | 1-4 |
| 2-1. User Table..... | 2-3 |
| 3-1. Specifications | 3-2 |
| 3-2. Supplemental Characteristics..... | 3-6 |
| 9-1. Commonly Used Code Conversions | 9-2 |
| 9-2. HP-IB Message Reference Table..... | 9-3 |
| 10-1. The Lower Byte of the SStatus Word..... | 10-7 |
| 10-2. The Upper Byte of the Status Word | 10-8 |
| 10-3. Error Numbers..... | 10-16 |
| 10-4. 54100A/D Front Panel Key Codes | 10-18 |
| 10-5. Reset Conditions | 10-25 |

LIST OF FIGURES

| FIGURE | | PAGE |
|--------|--|------|
| 1-1 | 54001A 1 GHz Miniature Active Probe | 1-2 |
| 1-2 | 54002A 1 M Ohm, 300 MHz with 10:1 Probe..... | 1-2 |
| 4-1 | HP 54100A/D Rear Panel..... | 4-2 |
| 4-2 | Power Module | 4-2 |
| 4-3 | Front Panel Power Switch | 4-3 |
| 4-4 | HP-IB Interface Connector | 4-4 |
| 4-5 | HP-IB Interface | 4-5 |
| 5-1 | 54100A/D Front Panel | 5-1 |
| 6-1 | Chan 1/2 Menu | 6-2 |
| 6-2 | Timebase Menu..... | 6-5 |
| 6-3 | Trigger Menu..... | 6-7 |
| 6-4 | Display Menu | 6-11 |
| 6-5 | Delta V Menu | 6-13 |
| 6-6 | Vmarkers..... | 6-13 |
| 6-7 | Delta t Menu | 6-16 |
| 6-8 | Wfm Save Menu | 6-19 |
| 6-9 | Wfm Math Menu | 6-19 |
| 6-10 | Measure Menu | 6-23 |
| 6-11 | Plot Menu | 6-23 |
| 6-12 | Print Menu..... | 6-25 |
| 6-13 | Probes Menu | 6-25 |
| 6-14 | Utility Menu..... | 6-25 |
| 6-15 | Cal Menu | 6-28 |
| 6-16 | Trigger Delay | 6-29 |
| 6-17 | Chan to Chan Skew..... | 6-29 |
| 6-18 | HP-IB Menu | 6-31 |
| 7-1 | HP 54100A/D Front Panel | 7-1 |
| 7-2 | Manual Vmarker Measurement..... | 7-2 |
| 7-3 | The Histogram of a Waveform | 7-3 |
| 7-4 | Auto Top-Base Voltage Measurement..... | 7-3 |
| 7-5 | Peak-to-Peak Voltage..... | 7-4 |
| 7-6 | Delta Vmarkers on Split Screen | 7-5 |
| 7-7 | Manual Time Interval Measurement..... | 7-6 |
| 7-8 | Edge Find | 7-7 |
| 7-9 | + Pulse Width | 7-9 |
| 7-10 | Time Jitter in the Averaged Mode | 7-11 |
| 7-11 | Time Jitter in the Normal Mode..... | 7-12 |
| 7-12 | Time Jitter With Normal/Averaged Mode | 7-12 |
| 7-13 | Auto Sweep Mode With Delay 50 ms..... | 7-13 |
| 7-14 | Split Screen With Trigger On Chan 1 | 7-15 |
| 7-15 | Split Screen With Trigger On Chan 2 | 7-16 |
| 7-16 | Pattern When Entered "HHXX" | 7-17 |
| 7-17 | Pattern When Exited | 7-18 |
| 7-18 | Averaged Mode (8 Averages) | 7-20 |

LIST OF FIGURES (Cont'd)

| | | |
|-------|--|--------|
| 7-19 | Normal Mode..... | 7-21 |
| 7-20 | Magnify Window in the Normal Mode..... | 7-22 |
| 7-21 | Magnify Using Normal Mode..... | 7-23 |
| 7-22 | Magnify in the Averaged Mode With 2 Averages..... | 7-24 |
| 7-23 | Magnify in the Averaged Mode With 512 Averages..... | 7-24 |
| 7-24 | Time Delay Chan 1 to Chan 2..... | 7-26 |
| 7-25 | Selecting Func 1..... | 7-27 |
| 7-26 | Func 1..... | 7-27 |
| 7-27 | Waveform Math Func 1&2..... | 7-28 |
| 7-28 | Measuring Func 1 Parameter..... | 7-29 |
| 7-29 | Automated Measurements on Func 1..... | 7-30 |
| 7-30 | Automated Measurements on Func 2..... | 7-30 |
| 7-31 | Precise Timing Resolution on Channels 1 & 2..... | 7-32 |
| 7-32 | Chan 1 Vs Chan 2 with Precise Timing Resolution..... | 7-32 |
| 7-33 | Low Timing Resolution on Channels 1 & 2..... | 7-33 |
| 7-34 | Chan 1 Vs Chan 2 with Low Timing Resolution..... | 7-33 |
| 7-35 | Effects of Ch to Ch SKEW on Waveform Math..... | 7-34 |
| 9-1 | Programming Command Tree..... | 9-12 |
| 9-2 | Alphabetical Command Cross-Reference..... | 9-13 |
| 10-1 | Command Set Syntax Diagram..... | 10-2 |
| 10-2 | System Commands..... | 10-9 |
| 10-3 | Acquire Subsystem Commands..... | 10-32 |
| 10-4 | Channel Subsystem Commands..... | 10-37 |
| 10-5 | Display Subsystem Commands..... | 10-42 |
| 10-6 | Attribute Byte..... | 10-46 |
| 10-7 | Function Subsystem Commands..... | 10-60 |
| 10-8 | Graph Subsystem Commands..... | 10-65 |
| 10-9 | Hardcopy Subsystem Commands..... | 10-68 |
| 10-10 | Measurement Subsystem Commands..... | 10-72 |
| 10-11 | Timebase Subsystem Commands..... | 10-94 |
| 10-12 | Trigger Subsystem Commands..... | 10-99 |
| 10-13 | Waveform Subsystem Commands..... | 10-114 |
| 10-14 | Data Flow..... | 10-130 |

SECTION 1

WHEN YOU RECEIVE YOUR INSTRUMENT

1-1. INTRODUCTION

This Operating and Programming Manual contains information required to install, operate and program the Hewlett-Packard Model 54100A/D Digitizing Oscilloscope. Paragraph 1-3 list the accessories supplied with the instrument. Section 1 covers instrument safety, identification, options, accessories, receiving information and other basic data. Section 2 provides guidelines for using this manual.

1-2. SAFETY CONSIDERATION

The Hewlett-Packard Model 54100A/D is a Safety Class 1 instrument (instrument with an exposed metal chassis that is directly connected to earth via the power supply cable.)

WARNING

Before you apply power to the unit make sure you review this manual and become familiar with the definitions of the safety markings and pertinent instructions. These must be followed to insure safe operation and that the instrument is maintained in a safe condition.

1-3. ACCESSORIES SUPPLIED WITH THE 54100A/D

The 54100A/D Digitizing Oscilloscope is supplied complete with the following accessories:

Three 54002A input pods (54100A). Four 54002A input pods (54100D).

One power cable

One Operating and Programming Manual and one Service Manual.

1-4. ACCESSORIES AVAILABLE

The following accessories are available for the 54100A/D:

54001A 10 M Ω , 1 GHz Miniature Active Probe with an attached 1.5M cable. (see figure 1-1)

54003A 1 M Ω 300 MHz, 10:1 probe.

54100-44104 Front panel protective cover.

11536A 50 Ohm Probing Tee. Used to minimize disturbance of transmission characteristics. Compatible with the 54001A high bandwidth probe (see above). Requires one 54051A probe adapter (see below).

10211A (24 pin) and 10024A (16 pin) Test Clips.

54001-23203 probe adapter. Adapts the 54001A (see above) mini-probe tip (or other HP mini-probes) to the probing accessories included in the 10020A resistive divider probe kit, and to the 11536A probing tee.

10240B BNC Blocking Capacitor. Used to ac couple signals to 54100A/D's inputs.

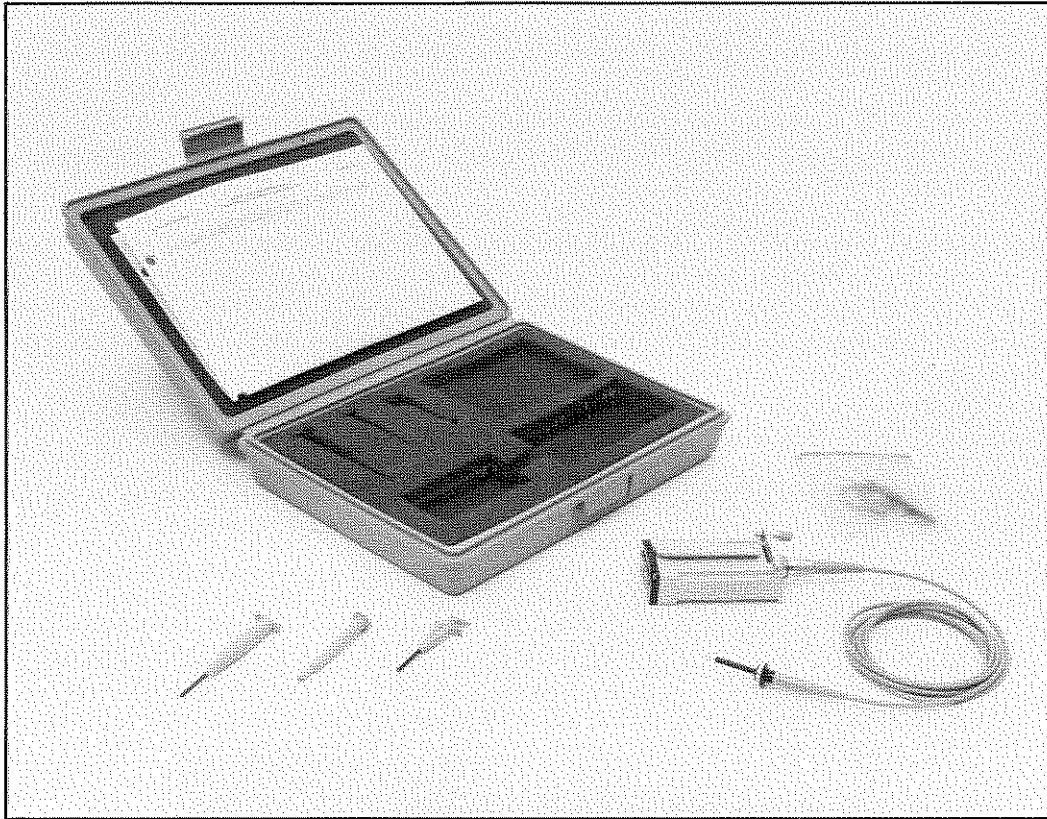

Figure 1-1. 54001A 1 GHz Miniature Active Probe

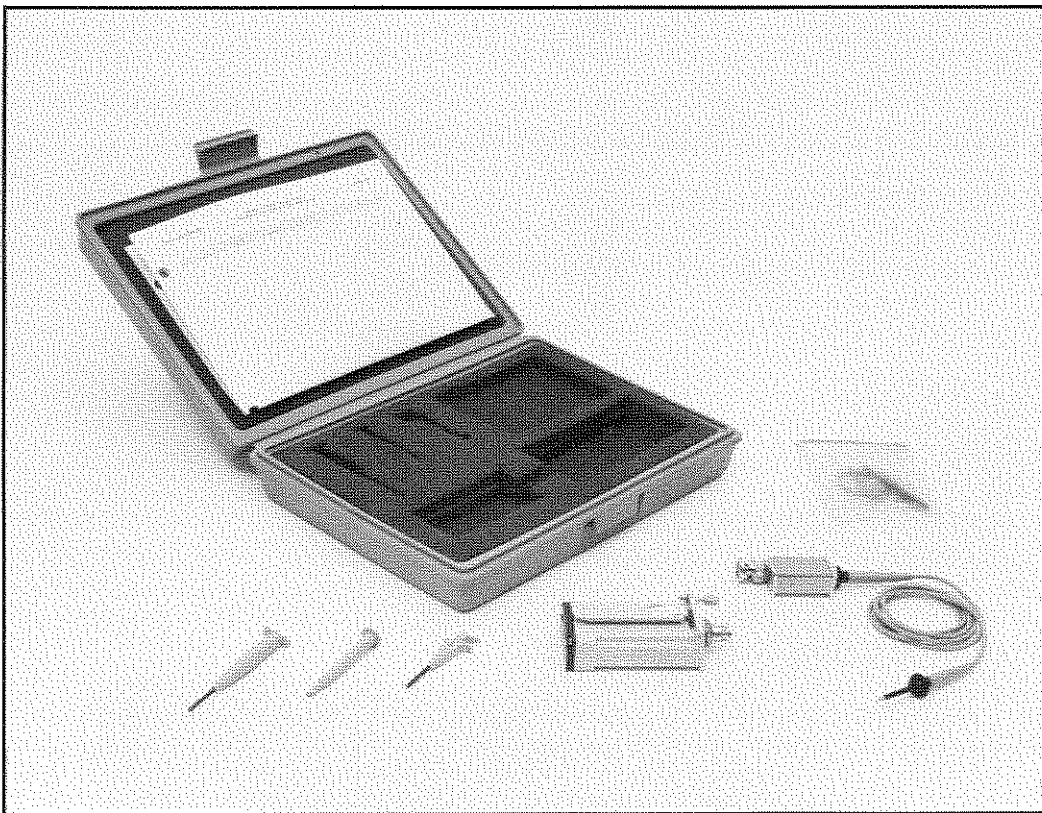

Figure 1-2. 54003A 1 M Ω 300 MHz with 10:1 Probe

1-5. OPTIONS

The 54100A/D Digitizing Oscilloscope has two options available:

Option 908 provides rack ears and associated mounting hardware for rack mounting the 54100A/D. The HP part number is 5061-0078.

Option 910 provides an additional Operating and Programming Manual for the 54100A/D.

1-6. POWER CABLE

WARNING

Before energizing this unit you must insure that the chassis of the instrument is properly grounded. This precaution is to avoid the possibility of injury or death which may result if the protective ground is defeated.

The 54100A/D is provided with a 3 wire power cable. When this cable is connected to an appropriate AC power receptacle it provides a ground for the instrument cabinet. The type of power cable shipped with each instrument depends on the country of destination. See table 1-1 for power cable description and applications.

1-7. INITIAL INSPECTION

WARNING

To avoid hazardous electrical shock, do not perform electrical tests when there are signs of shipping damage to any portion of the instrument.

Inspect the shipping container for damage. If the shipping container or packaging materials are damaged, it should be kept until the contents of the shipment have been checked for completeness and the instrument has been checked mechanically and electrically. The contents of the shipment should be as listed in Paragraph 1-3. If the contents are incomplete, or if there is mechanical damage or defect, notify the nearest Hewlett-Packard office. If either the shipping container is damaged or the packaging material shows signs of stress, notify the carrier as well as the Hewlett-Packard office. Keep the shipping materials for the carrier's inspection. The HP office will arrange for repair or replacement without waiting for claim settlement.

1-8. CLAIMS FOR DAMAGE

If physical damage is evident or if the instrument does not meet specifications when received, notify the carrier and the nearest Hewlett-Packard Sales/Service Office. The sales/service office will arrange for repair or replacement of the unit without waiting for settlement of the claim against the carrier.





1-9. STORAGE AND SHIPMENT

The 54100A/D Digitizing Oscilloscope may be stored and shipped in environments that do not exceed the following limits:

- Temperature.....-40° C to+75° C
- Humidity.....<95% relative
- Altitude <15,300 metres (50,000 feet)

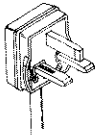
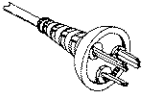
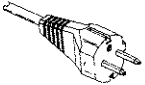
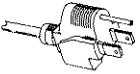
This instrument should also be protected from temperature extremes that would cause condensation in the instrument.

Table 1-1. AC Power Cables

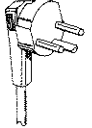
| PLUG TYPE | CABLE PART NO. | PLUG DESCRIPTION | LENGTH IN/CM | COLOR | COUNTRY |
|--|-------------------------------------|---|----------------------------|--------------------------------------|--|
| OPT 900 250V  | 8120-1351 8120-1703 | Straight *BS1363A 90° | 90/228 90/228 | Gray Mint Gray | United Kingdom, Cyprus, Nigeria, Zimbabwe Singapore |
| OPT 901 250V  | 8120-1369 8120-0696 | Straight *NZSS198/ASC 90° | 79/200 87/221 | Gray Mint Gray | Australia, New Zealand |
| OPT 902 250V  | 8120-1689 8120-1692 8120-2857 | Straight *CEE7-Y11 90° Straight (Shielded) | 79/200 79/200 79/200 | Mint Gray Mint Gray Coco Brown | East and West Europe, Saudi Arabia, So Africa, India (Unpolarized in many nations) |
| OPT 903 125V  | 8120-1378 8120-1521 8120-1992 | Straight *NEMA5-15P 90° Straight (Medical UL544) | 90/228 90/228 96/244 | Jade Gray Jade Gray Black | United States, Canada, Japan (100V or 200V), Mexico, Philippines, Taiwan |
| OPT 904 250V  | 8120-0698 | Straight *NEMA6-15P | 90/229 | Black | United States, Canada |
| OPT 905 250V  | 8120-1396 8120-1625 | CEE22-V1 (Systems Cabinet use) 250V | 30/76 96/244 | Black Black | |
| OPT 906 250V  | 8120-2104 8120-2296 | Straight *SEV1011 1959-24507 Type 12 90° | 79/200 79/200 | Mint Gray Mint Gray | Switzerland |
| OPT 912 220V  | 8120-2956 8120-2957 | Straight *DHCK107 90° | 79/200 79/200 | Mint Gray Mint Gray | Denmark |

*Part number shown for plug is industry identifier for plug only. Number shown for cable is HP Part no. for complete cable including plug. E=Earth Ground, L=line, N=Neutral

1-10. PACKAGING

Original packaging i.e., the containers and materials identical to those used in factory packaging are available from Hewlett-Packard. If the unit is being returned to Hewlett-Packard for servicing, attach a tag indicating the type of servicing required, return address, model number, and full serial number. Mark the container FRAGILE. In any correspondence refer to the instrument by model number and full serial number.

If other packaging is to be used the following general instructions for repackaging with commercially available materials should be followed;

- a. Wrap the instrument in heavy paper or plastic. If you are shipping the unit to a Hewlett-Packard office or service center be sure to attach a tag to the instrument indicating the type of service required, return address, model number and full serial number.
- b. Use a strong shipping container. A double wall carton made of 2.4MPa (350psi) test material is adequate.
- c. Use a layer of shock absorbing material 75 to 100mm (3 to 4 inches) thick around all sides of the instrument to provide firm cushioning and prevent movement inside the container. Protect the control panel with cardboard.
- d. Seal the shipping container securely.
- e. Mark the shipping container FRAGILE to insure careful handling.
- f. In any correspondence, refer to instrument by model number and full serial number.

NOTES:



SECTION 2

HOW TO USE THIS MANUAL

2-1. INTRODUCTION

This Operating and Programming Manual has been designed as both a tutorial operating manual and a reference manual for writing programs to operate the oscilloscope remotely.

The first four sections of the manual are concerned with instrument specifications, receiving information and operating environment information for the 54100A/D.

The next four sections (5 through 8) of the manual are concerned with front panel exercises. Sections 9-10 are dedicated to the remote programming of the HP-IB interface.

Here is an overview of what this manual contains:

WHEN YOU RECEIVE YOUR INSTRUMENT, SECTION 1

This section includes installation information, receiving information, warranty data and much more. You should read Section 1 before initial installation and operation.

MEET THE 54100A/D DIGITIZING OSCILLOSCOPE, SECTION 3

This section provides a description of this oscilloscope and complete specifications and operating characteristics. This section also includes a probe selection table.

GETTING READY TO USE THE 54100A/D, SECTION 4

This section contains important data about the required operating environment and power requirements for the 54100A/D. You should review this section prior to initial operation.

GETTING STARTED WITH THE FRONT PANEL, SECTION 5

This section introduces you to the front panel layout and its four functional areas. Section 5 provides vital information for the first time user.

FAMILIARIZE YOURSELF WITH THE MENUS, SECTION 6

Many of the front panel controls on the 54100A/D are multi-functioned. To better understand these controls this section defines all front panel functions and maps the different function groups. This section is formatted so that it can be used as a reference by operators, regardless of skill level.

FRONT PANEL EXERCISES, SECTION 7

This section provides step-by-step exercises that will help you become more familiar with making measurements from the front panel of the 54100A/D. Section 7 builds on the information presented in Section 6.

MAKING A HARDCOPY, SECTION 8

This section provides information concerning the use of graphics printers and plotters with the 54100A/D via HP-IB. This section also provides a list of Hewlett-Packard printers and plotters that are compatible with this instrument.

REMOTE OPERATION, SECTION 9

This section discusses the remote operation of the instrument over the HP-IB. Such topics as HP-IB compatibility, remote/local modes, local lockout, learn and cal strings are dealt with. Review this section before writing programs for the instrument.

COMMAND SET OVERVIEW, SECTION 10

This section contains the instruction set, notation conventions and definitions, syntax diagrams and other detailed programming reference information for the 54100A/D.

APPENDIX A

Appendix A contains example programs for the 54100A/D using the HP 200 series scientific computer using the HP Basic 4.0 operating system.

APPENDIX B

Appendix B provides the advanced user with a discussion of the channel-to-channel timing skew and trigger delay calibration concerns when using the 54100A/D.

APPENDIX C

Appendix C provides the advanced user detailed information concerning the automated measurements that the 54100A/D can perform. This appendix discusses such topics as measurement throughput, accuracy, and resolution.

The following table indicates those chapters which are recommended reading for various types of 54100A/D users. You may fall into more than one category. For example, you may be an inexperienced programmer who installs the 54100A/D.

Table 2-1. User Table

| Reader/User | Chapters | | | | | | | | | | Appendix | | |
|----------------------------------|----------|---|---|---|---|---|---|---|---|----|----------|---|---|
| | 1 | 2 | 3 | 4 | 5 | 6 | 7 | 8 | 9 | 10 | A | B | C |
| Installation Personnel | • | • | | • | | | | | | | | | |
| First Time User (Front Panel) | | | • | • | • | • | | • | | | | | |
| Advanced User (Front Panel) | | | | | | • | • | • | | | | • | • |
| Beginning Programmer | | | • | • | • | • | • | | • | | | | |
| Advanced Programmer | | | | | | | | | | • | • | | |

NOTES:

NOTES:



SECTION 3 SPECIFICATIONS AND SUPPLEMENTAL CHARACTERISTICS

3-1. INTRODUCTION

This section of the manual contains a list of specifications for reference and performance verification. These specifications are listed in Table 3-1. Also included in section three are the supplemental characteristics. Supplemental characteristics are not specifications but are typical parameters and are included in this manual as additional information for the user. Supplemental characteristics are listed in Table 3-2.

NOTES:

Table 3-1. Specifications

VERTICAL (Voltage)

Bandwidth (-3dB):¹

- with HP 54002A: dc to 1 GHz
- with HP 54001A: dc to 700 Mhz₃
- with HP 54003A: dc to 300 Mhz³

Transition Time (10% to 90%):¹

- with HP 54002A: ≤ 350 ps
- with HP 54001A: ≤ 450 ps₃
- with HP 54003A: ≤ 1.2 ns³

Deflection Factor (full-scale = 8 divisions):

- with HP 54002A: 10 mV/div to 1 V/div in 1-2-5 steps
- with HP 54001A: 100 mV/div to 10 V/div in 1-2-5 steps₃
- with HP 54003A: 100 mV/div to 10 V/div in 1-2-5 steps³

DC Accuracy, Single Voltage Marker:

- with HP 54002A: $\pm 3\%$ of full-scale $\pm 2\%$ of offset²
- with HP 54001A: $\pm 6\%$ of full-scale $\pm 2\%$ of offset ± 50 mV₃
- with HP 54003A: $\pm 6\%$ of full-scale $\pm 2\%$ of offset ± 50 mV³

DC Delta Voltage Accuracy (Two Markers On Same Channel):

- with HP 54002A: $\pm 1\%$ of full-scale $\pm 3\%$ of reading²
- with HP 54001A: $\pm 1\%$ of full-scale $\pm 6\%$ of reading₃
- with HP 54003A: $\pm 1\%$ of full-scale $\pm 6\%$ of reading³

DC Offset:

RANGE: ± 1.5 x full-scale (referenced to center screen)

ADJUSTMENT RESOLUTION: adjustable in steps of 0.0025 x full-scale

Dynamic Range: deflection factor and offset should be scaled so that the unmagnified signal remains within the the full-scale display range.

Magnifier: expands displayed signal vertically from 1 to 16 times; adjustable in 0.5% steps.

Inputs: two inputs, configurable with HP 54000-series pods.

Table 3-1. Specifications (Continued)

| | | |
|---|---|---|
| HORIZONTAL (Time) | | |
| Deflection Factor (full-scale = 10 divisions): 100 ps/div to 1 s/div | | |
| ADJUSTMENT RESOLUTION: adjustable in 1-2-5 steps via knob and step keys. Adjustable to three significant figures via keypad or HP-IB command. | | |
| Delay (Time Offset): | | |
| PRE-TRIGGER RANGE: up to -200 ms or -10 divisions, whichever is greater. | | |
| POST-TRIGGER RANGE: up to +1 second or +600,000 divisions, whichever is greater. | | |
| ADJUSTMENT RESOLUTION: adjustable in steps of 10 ps or 10^{-6} x delay setting, whichever is greater. | | |
| Time Base Accuracy: error is: | | |
| SINGLE-CHANNEL: $\leq (100 \text{ ps} \pm 2 \times 10^{-5} \times \text{delta T reading})$ | | |
| DUAL-CHANNEL: $\leq (200 \text{ ps} \pm 2 \times 10^{-5} \times \text{delta T reading})$ | | |
| TRIGGER | | |
| Trigger Source | Vertical Channel 1 or 2 | |
| Input Pod | HP 54002A | HP 54001A HP 54003A ³ |
| Trigger Level Range | $\pm 2 \times \text{full-scale}$ | |
| Trigger Level Adjustment Resolution | $0.0025 \times \text{full-scale}$ | |
| Trigger Sensitivity DC to 100 MHz | $0.12 \times \text{full-scale}$ | |
| Above 100 Mhz (frequency range) | $0.24 \times \text{full-scale}$ (100 MHz to 500 MHz) | $0.24 \times \text{full-scale}$ (100 Mhz to 300 Mhz) |
| Pulse width > 1 ns | $0.24 \times \text{full-scale}$ | |

Table 3-1. Specifications (Continued)

| TRIGGER (Continued) | | | | |
|--|----------------------------|---|--|---|
| Trigger Source | Trigger Input 3 or 4 | | | |
| Input Pod | HP 54002A | HP 54001A | HP 54003A ³ | |
| Trigger Level Range | ±2 V | ±20 V | | |
| Trigger Level Adjustment Resolution | 2 mV | 20 mV | | |
| Trigger Sensitivity DC to 100 MHz | 40 mV | 400 mV | | |
| Above 100 Mhz (frequency range) | 80 mV (100 MHz to 500 MHz) | 800 mV (100 MHz to 500 MHz) | 800 Mv (100 MHz to 300 Mhz) | |
| Pulse width > 1 ns | 80 mV | 800 mV | | |
| <p>RMS Jitter: $\leq(50 \text{ ps} + 5 \times 10^{-7} \times \text{delay setting})$</p> <p>Trigger Source: channel 1, channel 2, trigger 3, trigger 4. Independent trigger level and polarity settings on all sources. Edge trigger on any source. Logical pattern trigger on all sources.</p> <p>Trigger 3 and 4 Input: configurable with HP 54000-series pods.</p> | | | | |
| INPUTS | | | | |
| | HP 54002A 50Ω Input | HP 54001A 1 GHz Miniature Active Probe | HP 54003A 1 MΩ Input, With 10:1 Probe Attached | HP 54003A 1 MΩ Input, With 10:1 Probe Removed |
| Maximum Input Voltage | 5 V rms | 20 V peak | 20 V peak | 2 V peak |

Table 3-1. Specifications (Continued)

| INPUTS (Continued) | | | | |
|---------------------------------------|--------------------------------|---|--|---|
| | HP 54002A 50 Ω Input | HP 54001A 1 GHz Miniature Active Probe | HP 54003A 1 M Ω Input, With 10:1 Probe Attached | HP 54003A 1 M Ω Input, With 10:1 Probe Removed |
| Coupling | dc | dc | dc | dc |
| Input Capacitance (Nominal) | N/A | 2 pF | 8 pF | 10 pF |
| Input Resistance (Nominal) | 50 Ω | 10 k Ω | 1 M Ω | 1 M Ω |
| Bandwidth * (-3dB) | dc to 1 GHz | dc to 1 GHz | dc to 300 MHz | dc to 300 MHz |
| Transition Time * (10% to 90%) | ≤ 350 ps | ≤ 350 ps | ≤ 1.2 ns | ≤ 1.2 ns |
| Division Ratio * | 1:1 | 10:1 $\pm 3\%$ | 10:1 $\pm 3\%$ | 1:1 $\pm 1\%$ |

CATHODE-RAY TUBE

X-RAY EMISSION: CRT emission <0.1 mR/hr; not measurable in background noise using Victoreen Model 440RF/C.

NOTES:

1. These specifications apply over ambient temperature range of +15°C to +35°C.
2. When driven from a 50 Ω source.
3. With the 10:1 divider probe supplied with the 54003A.

* Refer to VERTICAL and TRIGGER specifications for system performance specifications.

Table 3-2. Supplemental Characteristics

DIGITIZER

Resolution: 7 bits (1 part in 128). Effective resolution can be extended up to approximately 10 bits by using magnification and averaging.

Digitizing Rate: up to 40 megasamples/second.

VERTICAL

Input Protection: a relay opens when applied voltage exceeds rated input voltage for input pod in use (see Specifications).

HORIZONTAL

Delay Between Channels: difference in delay between channels can be nulled out in 10 ps steps up to 10 ns to compensate for differences in input cables or probe length.

Reference Location: the reference point can be located at the left edge, center, or right edge of the display. The reference point is that point where the time is offset from the trigger by the delay time.

TRIGGER

Input Protection: a message appears on the display when the applied voltage exceeds rated input voltage for input pod in use (see Specifications).

Holdoff

HOLDOFF-BY-EVENTS: range of events counter is from 2 to 67 million events. Maximum counting rate is 80 MHz. An event is defined as anything that satisfies the triggering conditions selected.

HOLDOFF-BY-TIME: adjustable in 10 ns steps from 70 ns to 670 ms.

Trigger Modes

EDGE TRIGGER: on any source (see Specifications, Trigger Source).

PATTERN TRIGGER: a pattern can be specified for all sources. Each source can be specified as high, low, or don't care. Trigger can occur on the last edge to enter the specified pattern or the first edge to exit the specified pattern.

Table 3-2. Supplemental Characteristics (Continued)

Trigger Modes (Continued)**TIME QUALIFIED PATTERN TRIGGER: (54100D only)**

The trigger occurs on the first edge to exit the specified pattern, only if the pattern was present less than [greater than] the specified time. Filter time is adjustable from 10 ns to 5 s. Filter recovery time is ≤ 8 ns. In the "Pattern Present [time]" mode, the pattern must be present ≥ 1 ns for the trigger to respond.

STATE TRIGGER: (54100D only)

A pattern can be specified for any three sources. The trigger can be set to occur on an edge of either polarity on the source specified as the clock (not one of the pattern sources) when the pattern is present or not present. Setup time for the pattern to be present prior to the clock edge is < 4 ns; hold time is zero.

Delayed Trigger (54100D only)

EVENTS-DELAYED MODE: the trigger can be armed by an edge on any source, then triggered by the n th edge on any other source.

The number of events, n , can be set from 1 to $10^8 - 1$.
Maximum event counting rate is 150 MHz.

TIME-DELAYED MODE: the trigger can be armed by an edge on any source, then triggered by the first edge on any other source after a specified time has elapsed. The delay time can be set from 20 ns to 5 seconds.

DISPLAY

Data Display Resolution: 501 points horizontally (full-scale) by 256 points vertically.

Data Display Formats

SPLIT SCREEN: each channel display is four divisions high.

FULL SCREEN: the two channels are overlaid. Each channel display is eight divisions high.

Display Modes

VARIABLE PERSISTENCE: the time that each data point is retained on the display can be varied from 200 ms to 10 seconds, or it can be displayed indefinitely.

Table 3-2. Supplemental Characteristics (Continued)

Display Modes (Continued)

AVERAGING: the number of averages can be varied from 1 to 2048 in powers of 2. On each acquisition, $1/n$ times the new data is added to $(n-1)/n$ of the previous value at each time coordinate. Averaging operates continuously; the average does not stop after n acquisitions.

GRATICULES: Full grid, axes with tic marks, or frame with tic marks.

MEASUREMENT AIDS

Markers: dual voltage markers and dual time markers are available. Voltage markers can be assigned to either channel or to both channels, memories and functions.

Automatic Edge Finders: the time markers can be assigned automatically to any displayed edge of either polarity on a channel memory, or function or to any combination of the preceding. The voltage markers establish the threshold reference for the time markers in this mode.

Automatic Pulse Parameter Measurements: the following pulse parameter measurements can be performed automatically (as defined by IEEE standard 194-1977, "IEEE Standard Pulse Terms and Definitions").

| | |
|-----------------|----------------|
| Frequency | Top magnitude |
| Period | Base magnitude |
| Pulse duration | Preshoot |
| Rise time | Overshoot |
| Fall time | RMS volts |
| Pulse amplitude | Duty cycle |

Waveform Math: two independent functions are provided for waveform math. The operators are +, -, invert, versus and only. Either of the two vertical channels or any of the four waveform memories can be used as operands for the waveform math. If turned on, Function 1 is displayed in lieu of Channel 1 and Function 2 is displayed in lieu of Channel 2.

Table 3-2. Supplemental Characteristics (Continued)

SETUP AIDS

Presets: vertical deflection factor, offset, and trigger level can be preset independently on each channel for ECL or TTL levels.

Auto-Scale: pressing Auto-Scale causes vertical and horizontal deflection factors and the trigger source to be set for a display appropriate to the signals applied to the inputs. Requires a duty cycle >0.1%, frequency >50Hz, and amplitude >20 mV peak. Operative only for relatively stable input signals.

Save-Recall: ten front panel setups may be saved in non-volatile memory. If Auto-Scale is inadvertently pressed, pressing Recall followed by Auto-Scale, restores the instrument to the state prior to the last Auto-Scale executed.

Waveform Memories: four memories are provided for storage of waveforms. Only one waveform may be stored in each of these memories. These memories can be used as sources for either measurements or functions. Two additional memories are provided to store pictures. Each of these two waveform picture memories is a pixel map of the display. Any number of waveform pictures may be written into each picture memory. Once stored, individual waveforms cannot be accessed from the picture memories. The display of any of the six memories can be turned on or off without affecting their contents.

POWER REQUIREMENTS

Voltage: 115/230 V ac, -25% to +15%, 48-66 Hz.

Power: 290 watts maximum, 500 VA maximum.

DIMENSIONS

Refer to outline drawing.

WEIGHT

Net: approximately 19 kg (42 lb).

Shipping: approximately 23.5 kg (52 lb).

Table 3-2. Supplemental Characteristics (Continued)

ENVIRONMENTAL CONDITIONS

Temperature

OPERATING: 0°C to +55°C (+32°F to +131°F).

Note: see Specification Note 1.

NON-OPERATING: -20°C to +75°C (-4°F to +167°F).

Humidity

OPERATING: up to 90% relative humidity at +40°C (+104°F).

NON-OPERATING: up to 95% relative humidity at +65°C (+149°F).

Altitude

OPERATING: up to 4600 metres (15,000 ft).

NON-OPERATING: up to 15,300 metres (50,000 ft).

Vibration: Vibrated in three orthogonal axes for 15 minutes each axes; 0.38 mm (0.015 in.) peak-to-peak excursion; 5 to 55 Hz; 1 minute/octave sweep.

- NOTES: 1. DIMENSIONS ARE FOR GENERAL INFORMATION ONLY. IF DIMENSIONS ARE REQUIRED FOR BUILDING SPECIAL ENCLOSURES, CONTACT YOUR HP FIELD ENGINEER.
- 2. DIMENSIONS ARE IN MILLIMETRES AND (INCHES).

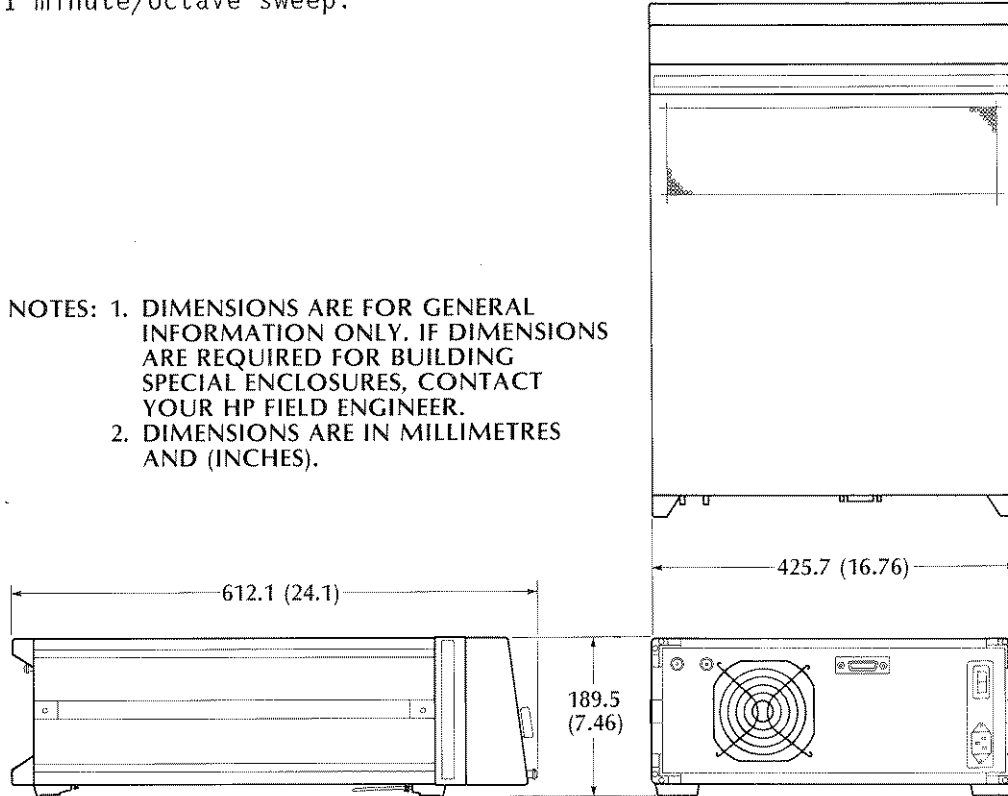

SECTION 4

GETTING READY TO USE THE HP 54100A/D

4-1. HP 54100A/D SPECIFICATIONS

This section provides information concerning the operating environment and the power requirements for the HP 54100A/D Digitizing Oscilloscope. It is important that the user provide the correct power source and operating environment for this instrument. Failure to do so can cause serious damage to the instrument and/or provide a health hazard to the user.

4-2. OPERATING ENVIRONMENT

CAUTION

Insure the instrument has adequate clearance on all surfaces to provide for sufficient air flow for cooling. Do not block any of the vent holes or the fan's air inlet.

The operating environment must be maintained within the following parameters:

Temperature 0° C to 55° C
Humidity <90% up to 40° C
Altitude <4572 metres (15,000 feet)

This instrument should also be protected from temperature extremes that would cause condensation in the instrument.

4-3. POWER REQUIREMENTS

The 54100A/D requires a power source of 115 or 230 Vac +15/-25%; 48-66 Hertz single phase. Power consumption is 290 watts maximum or 500 VA maximum.

CAUTION

Before connecting this instrument to the AC power source, insure that the line select switch on the rear panel of the instrument is set to the appropriate position (see figure 4-1).

A blade-type screwdriver may be used to change the position of this switch. Figure 4-2 shows the line select switch set for 115 Vac operation. If this switch is not set correctly, serious damage to the instrument is likely.

Once the correct setting on the line select switch has been made and the appropriate power cord has been installed and connected to the mains, the unit can be energized (see paragraph 4-4). By selecting the appropriate line voltage with the line select switch, you are also determining the correct circuit breaker trip current. If 115 Vac line voltage is selected, the circuit breaker trip current will be 5 amps. If 230 Vac line voltage is selected, the circuit breaker trip current will be 3 amps.

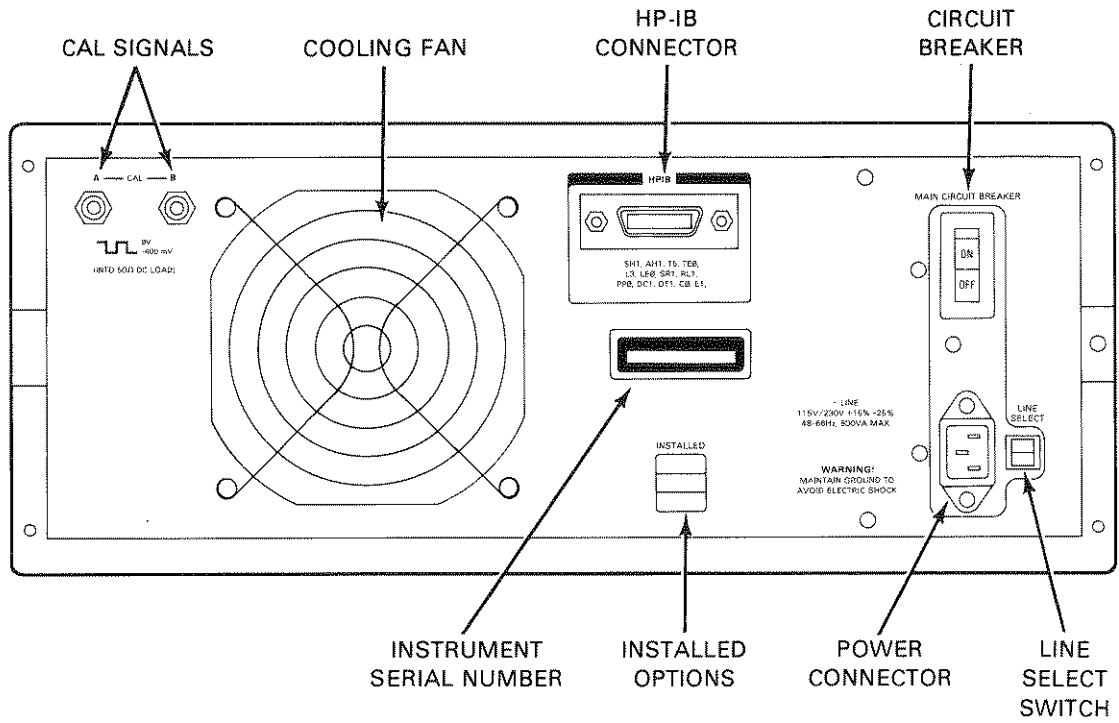

Figure 4-1. HP 54100A/D Rear Panel

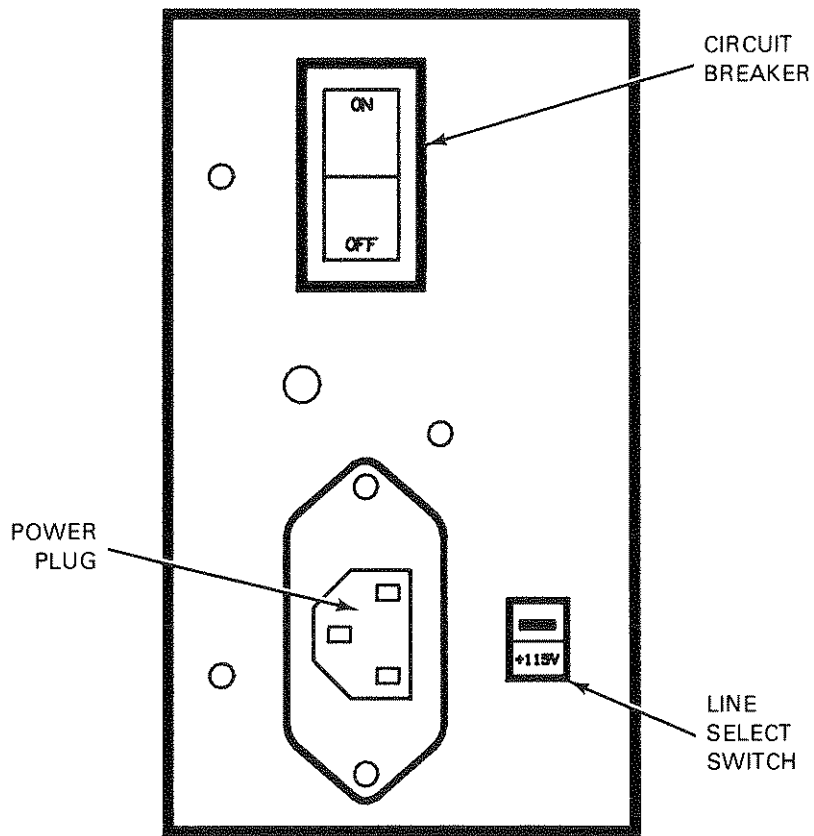

Figure 4-2. Power Module

The 54100A/D has two switches that can interrupt the power for the instrument. The first is the line switch and the second is the mains breaker:

1. The line switch is located on the left side of the instrument just rear of the front bezel at the lower edge (see figure 4-3).
2. The mains breaker is located on the upper right hand corner of the rearpanel (see figure 4-1).

If either the line switch or mains breaker are in the OFF or "0" position, the unit will not function.

4-4. POWER CABLE

WARNING

Before energizing this unit you must insure that the chassis of the instrument is properly grounded. This precaution is to avoid the possibility of injury or death which may result if the protective ground is defeated.

The 54100A/D is provided with a 3-wired power cable. When this cable is connected to an appropriate AC power receptacle, it provides a ground for the instrument cabinet. The type of power cable shipped with each instrument depends on the country of destination. See table 1-1 for power cable description and applications.

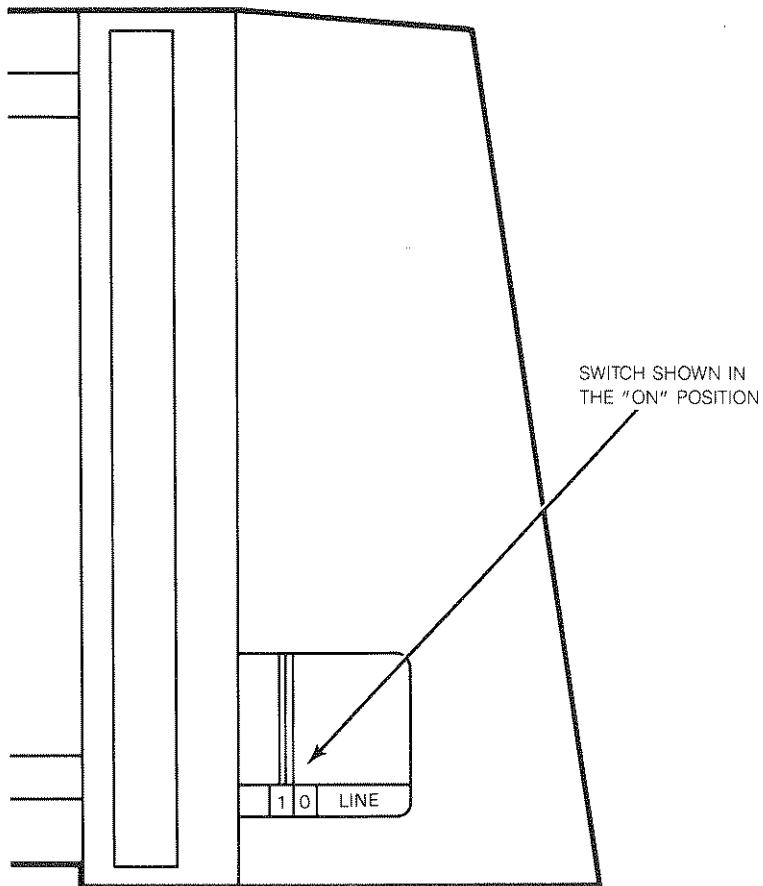

Figure 4-3. Front Panel Power Switch

4-5. HP-IB ADDRESS SELECTION

HP-IB address can be read and selected from the front panel of the 54100A/D with the use of soft keys that are located at the right of the CRT (after pressing the Utility menu select key). In order to set or change the HP-IB address, put the 54100A/D into the TALK/LISTEN mode (soft key selectable), then input the desired address from the front panel. The 54100A/D supports the following HP-IB interface functions: SH1, AH1, T5, TE0, L3, LE0, SR1, RL1, PP0, DC1, DT1, C0, E1. For further information concerning the 54100A/D HP-IB, operation, see Section 9.

4-6. HP-IB INTERCONNECTIONS

Interconnection data concerning the rear panel HP-IB connector is provided in figure 4-4. The HP-IB system allows the interconnection of up to 15 (including controller) HP-IB compatible instruments. The HP-IB cables have identical connectors on both ends so that several cables can be connected to a single source without special connectors or switch boxes. System components and devices may be connected in virtually any configuration (see figure 4-5).

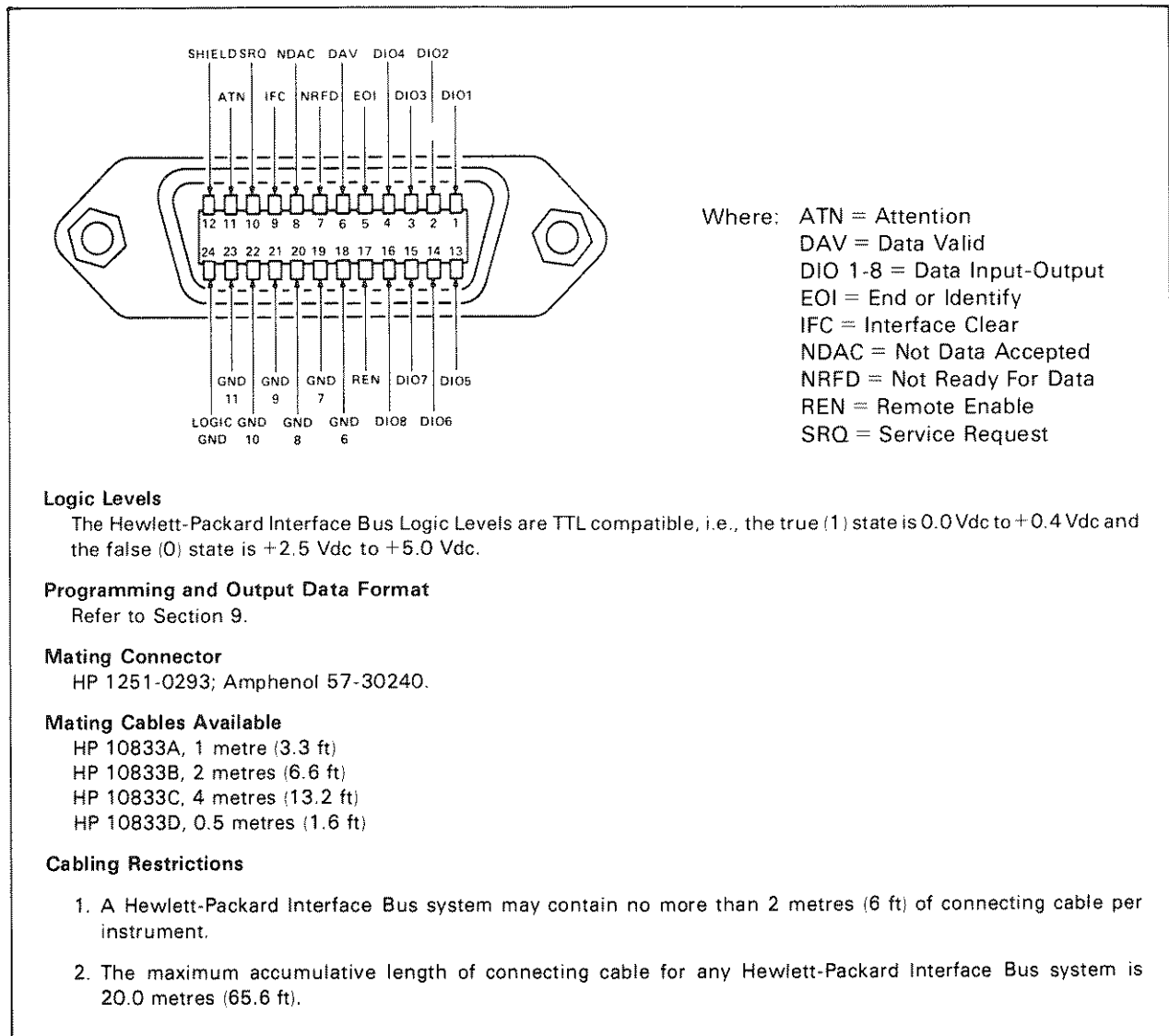

Figure 4-4. HP-IB Interface Connector

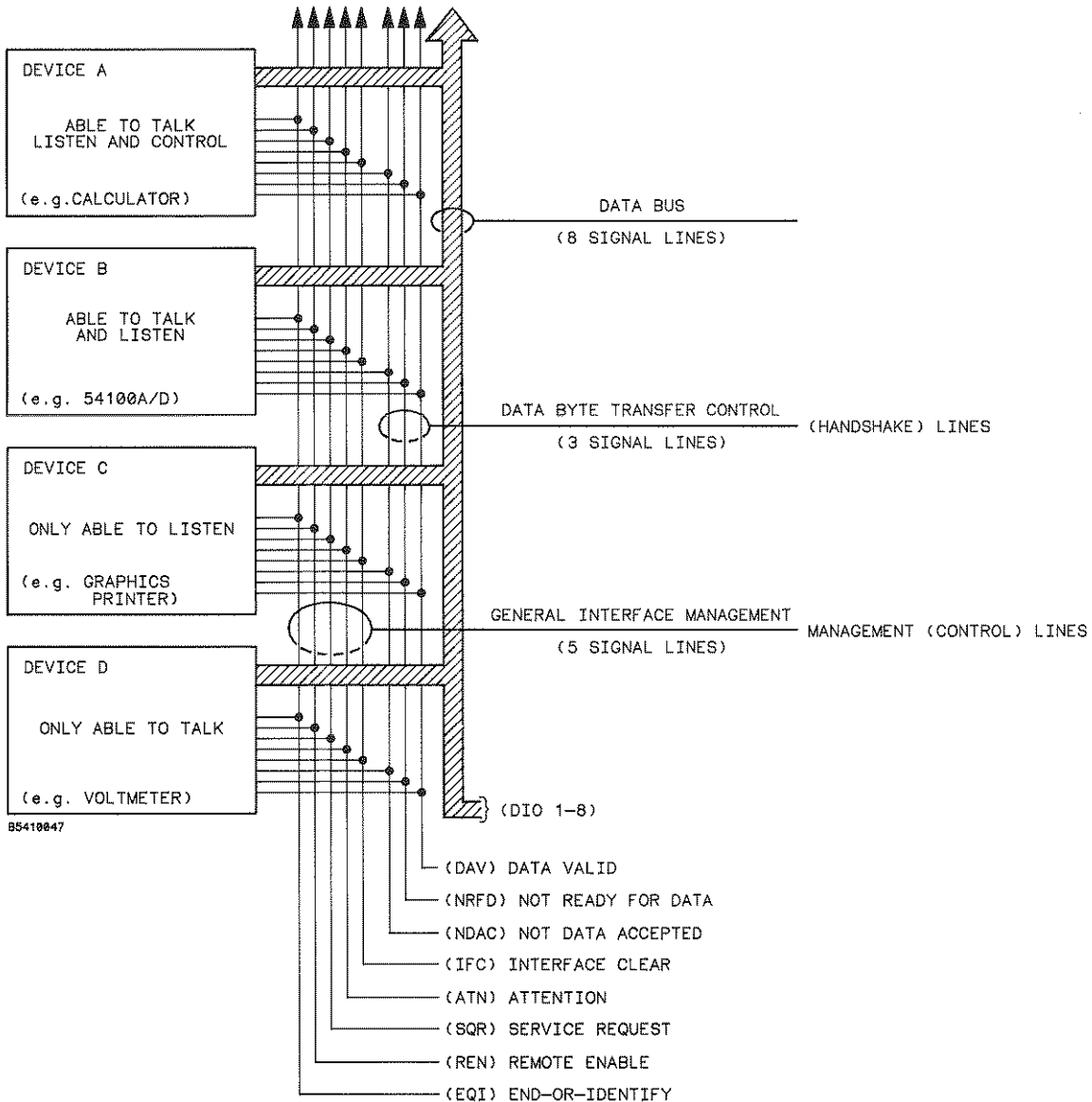

Figure 4-5. HP-IB Interface

NOTES:



SECTION 5 FRONT PANEL

5-1. GETTING STARTED WITH THE FRONT PANEL

This section describes the front panel of the 54100A/D and discusses its four functional areas. The four functional areas of the front panel of the 54100A/D Digitizing Oscilloscope include:

- A. System Control
- B. Entry
- C. Menu Selection
- D. Function

These four groups of keys give the operator complete local control of the instrument. (See Figure 5-1.)

5-2. SYSTEM CONTROL

The SYSTEM CONTROL keys are located on the top right-hand side of the front panel directly under the label, "SYSTEM CONTROL"

The SYSTEM CONTROL keys provide control of acquisition, the dynamic display, SAVE/RECALL registers and automatic display scaling.

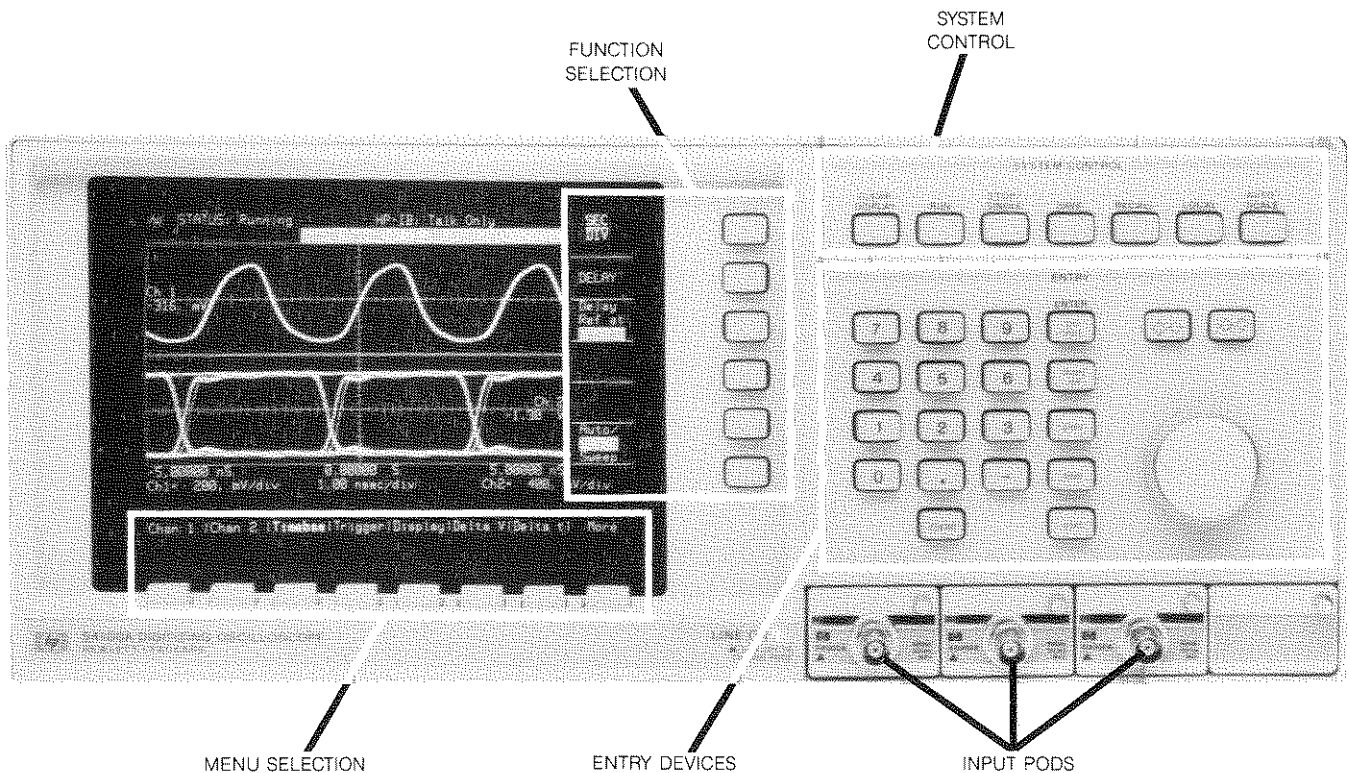

Figure 5-1. 54100A/D Front Panel

The CLEAR DISPLAY key erases the dynamic (active) display. This key will not erase a waveform in memory that is being displayed. When the CLEAR DISPLAY key is pressed the instrument will momentarily stop acquiring data, erase the screen and then resume acquiring data. If the STOP/SINGLE key has previously been pressed, the CLEAR DISPLAY key will erase the displayed waveform and acquisition will not resume unless the RUN key is pressed, or if a single acquisition is desired the STOP/SINGLE key can be pressed for the second time. If you are acquiring a large number of averages and you change the input signal you can quickly reset the average registers by pressing the CLEAR DISPLAY key. This will save the time that the display would normally take to integrate to the new signal levels.

The RUN key causes the 54100A/D to resume acquiring data after acquisition has been stopped by the STOP/SINGLE key. When the STOP/SINGLE key is pressed the instrument will stop acquiring data and display, indefinitely, the last data that was acquired. Each subsequent STOP/SINGLE key press arms the instrument to make a single acquisition that would be started by the next trigger event. To return to the previous operating mode press the RUN key. When the STOP/SINGLE key has been pressed the SEC/DIV, VOLTS/DIV and other front panel controls that would normally cause the displayed waveform to change will erase the active display as if the CLEAR DISPLAY key had been pressed.

5-3. SAVE/RECALL

This instrument allows the user to SAVE and RECALL up to ten different front panel setups in nonvolatile memory.

To SAVE the current front panel setup in one of the ten SAVE/RECALL registers, press SAVE, then press the number (0-9) of the register desired. All front panel functions, modes and Cal factors are saved. Menu selection and input device assignments are not saved. SAVE/RECALL will not cause execution of measurements, edge finders, "Start Print", or other action keys.

To RECALL a previously saved front panel setup press RECALL, then press the number (0-9) of the desired register.

To return to the condition that existed prior to the last AUTO-SCALE, press RECALL then press AUTO-SCALE. This feature allows you to recover if the AUTO-SCALE is accidentally pressed.

5-4. LOCAL

When the LOCAL key is pressed an RTL (return to local) message is sent to the HP-IB interface and the unit will return to local (front panel) control if it had previously been in remote operation and if the HP-IB controller had not invoked a local lockout.

The LOCAL key is the only active front panel key when the unit is in REMS (remote state).

5-5. AUTOSCALE

When the AUTO-SCALE key is pressed the instrument will select the vertical sensitivity, vertical offset, trigger level and sweep speed for a display of the input signal. If input signals are present at both vertical inputs the sweep will be triggered on Chan 1 and the display will go to the split screen mode and the vertical sensitivity for each channel will be scaled appropriately. If only one of the vertical inputs has a signal on it, the split screen function will be turned off. See Operating Characteristics for input signal requirements for proper AUTO-SCALE operation.

When the AUTO-SCALE cycle is complete, the Timebase menu will be selected and the input devices will be assigned to the SEC/DIV function.

5-6. ENTRY DEVICES

Under the SYSTEM CONTROL keys is an area labeled ENTRY. Located in this portion of the front panel is a number pad, a vertical column of 5 ENTER keys, the "knob" and two step keys, (refer to figure 5-1). These four items are referred to, throughout this manual, as the "entry devices".

The entry devices are used to change the value of any of the items in the function menus that are displayed in UPPER CASE letters e.g., VOLTS/DIV and SEC/DIV. The function menus are on the right side of the CRT.

The value of the selected variable function is listed at the top of the waveform display area on the CRT.

5-7. MENU SELECTION

Softkeys provide front panel control of the 54100A/D digitizing oscilloscope.

This instrument has two sets of softkeys, the first set is located at the bottom of the CRT, and the second set is right of the CRT. The keys at the bottom of the CRT are referred to as the "menu selection keys" as they are used to choose a desired function menu. As you press the different function menu selection keys the function menus along the right side of the CRT will change. Pressing the More key at the bottom right-hand corner of the CRT provides an additional seven function menus. If the More key is pressed again the original menu will return.

After you have selected a function menu, notice some of the function menu softkey labels have text shown in inverse video. If the adjacent softkey is pressed the text that is in inverse video will change, e.g., to turn a function On or Off, or to activate an associated function, e.g., pattern trigger, edge trigger, state trigger.

When a softkey with an upper case label is pressed, the label will intensify and the input devices will be slaved to that function.

The third type label for a function softkey will have the first letter of each word in upper case and there will be no inverse video text associated with the label. When a function key with this type of label is pressed the function will execute. This type of label is used primarily in the Measure and Utility menus.

NOTES:



SECTION 6 FAMILIARIZE YOURSELF WITH THE MENUS

6-1. FAMILIARIZE YOURSELF WITH THE MENUS

This section contains a description of the front panel operation of the 54100A/D. Operating details and front panel layout are discussed in detail. You should read this section completely before continuing to Sections 7 and 8.

6-2. VERTICAL

After you have energized the unit, connect one of the cal signals from the rear panel to the channel 1 input. The most convenient method of scaling the vertical and horizontal is to press the AUTO-SCALE key. This key causes the 54100A/D to evaluate the vertical inputs and scale the vertical and timebase for a triggered and appropriately scaled display. See Operating Characteristics in Section 1 for limitations of AUTO-SCALE.

6-3. AUTO-SCALE

When the AUTO-SCALE key is pressed, the DELAY will be set to 0 seconds and referenced to center screen. The instrument will be left in the Timebase menu with SEC/DIV the assigned function for the Entry Devices.

Rotate the "knob" and notice the sweep speed change, enter "1" from the key pad and press the μ sec entry key, the sweep speed will go to 1 μ sec/div. Next alternately press the step keys, the sweep speed will either sweep faster or slower depending on which step key is pressed. These three devices are referred to as the Entry Devices and are used to change variable functions on this instrument.

If no signal is detected on the inputs, a error message will state "No signal found".

If there is a signal present at the inputs of both channels, the 54100A/D will go to the split screen function, that is, channel 1 will be displayed in the top half of the display and channel 2 will be displayed in the bottom half of the display. The unit will be set to trigger on channel 1.

6-4. CHANNEL 1 and CHANNEL 2 MENUS

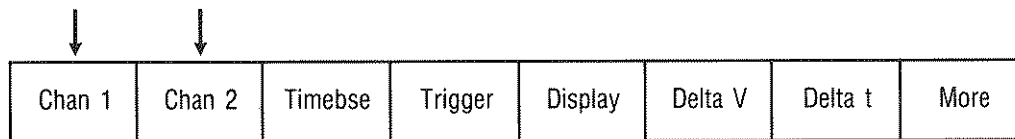

When Chan 1 or 2 is selected, one of three channel modes will appear on the right side of the display, (see Figure 6-1). The first is the Normal mode, the second is the Magnify mode, and the third is the Func 1/2 on. The normal and magnify modes have associated menus, and the func 1/2 modes do not. Func1/2 can be turned off or on in the Wfm Math menu. When they are on, they replace chan 1 and 2 respectively.

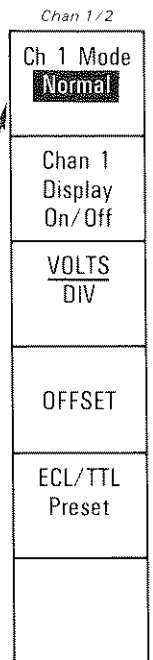

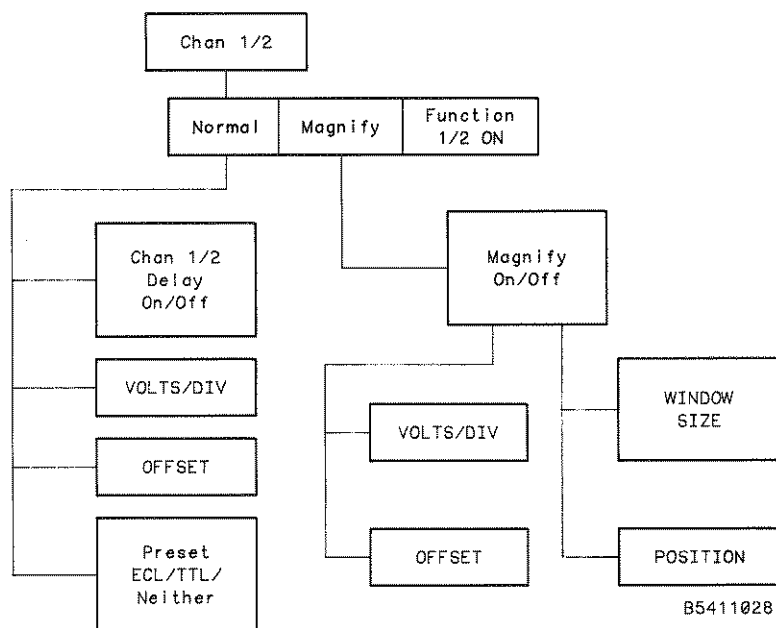

Figure 6-1. Chan 1/2 Menu

6-5. NORMAL MODE

The Normal mode should be selected when the entire vertical magnitude of the input signal needs to be observed. When operating in this mode, you should not adjust VOLTS/DIV or OFFSET in such a fashion that the signal will be off scale vertically as erroneous results may be acquired.

The display On/Off key is the second from the top. Push it and notice that the Chan 1 signal disappears and reappears depending on whether On or Off is selected. This function key turns off the display for a particular channel. It does not stop that channel from acquiring data. Next is the VOLTS/DIV key which when selected will allow the vertical sensitivity to be changed in a 1-2-5 sequence in three ways:

NOTE

A 1-2-4 sequence is used when in the split screen mode.

1. Vertical sensitivity can be changed by using the number pad on the Entry portion of the front panel. After a number on the key pad has been pressed, the appropriate "units" key must be pressed to complete the operation. The units keys are located just to the right of the key pad. Note: In the Normal mode all entries other than 1-2-5 will default to the nearest 1-2-5 range. In the Magnify mode, sensitivity can be entered to 3 digit resolution.
2. The knob may be used to change the vertical sensitivity.
3. The step keys, located just above the knob, may be used to increment or decrement the vertical sensitivity.

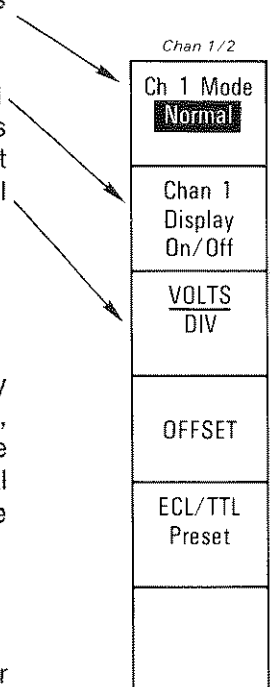

These three entry devices may be used on any function menu item that is written in UPPER CASE letters.

The next function key is OFFSET which when selected allows the trace to be moved up or down by using the number pad, the knob, or the step keys. This function works much the same way as a conventional oscilloscope position control. The OFFSET voltage as referenced to center screen is shown at the top of the waveform display area.

The next function key is the Preset key. This key provides three choices:

1. ECL
2. TTL
3. Neither

When ECL or TTL is selected for a channel the instrument automatically selects the correct OFFSET, VOLTS/DIV, and TRIG LEVEL for the logic family that was selected. If the ECL or TTL function is selected the selection will be highlighted. When neither preset is desired, press the preset key until neither ECL or TTL is highlighted. The OFFSET, VOLTS/DIV, and TRIG LEVEL will then return to their previous settings.

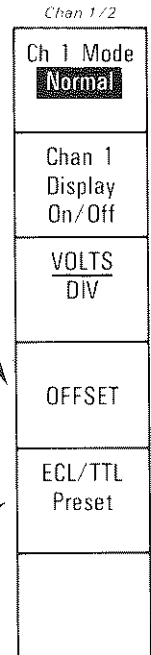

6-6. MAGNIFY MODE

When the magnify mode is selected, Magnify can be turned On/Off by pressing the Magnify On/Off key. When Off is selected there will be two variable functions on the vertical function menu; WINDOW SIZE and POSITION. They can be changed by using any of the entry devices i.e., step keys, the knob, or number pad. The horizontal lines that define the window can be moved closer together or farther apart by manipulating the entry devices. The window defines the range that will be displayed full scale when Magnify is keyed on. When the POSITION function is selected, the user can move the window on the vertical axis by using the input devices. Note, this is different from vertical position, the window moves, not the signal. The Magnify function is easy to demonstrate:

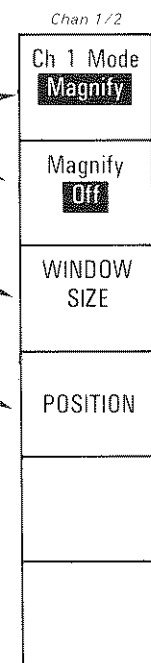

Connect the cal signal to Chan 1 and push AUTO-SCALE.

Select:

- Mode = Magnify
- Magnify = Off
- Display = Averaged
- # of Averages = 64

Alternately select and adjust the WINDOW SIZE and POSITION so the window is about the pulse top. When Magnify is turned On the portion of the signal that was defined by the window will fill the display. The vertical sensitivity or offset for the magnified display is shown at the top of the waveform display area.

The vertical sensitivity and offset can be adjusted in the Magnify mode by selecting the appropriate function key and using one of the entry devices.

You would use the magnify function if you wanted to evaluate a small signal such as a reflection or overshoot that was present on large signal. Magnify can also be used to provide increased vertical sensitivity.

The Magnify mode allows higher vertical resolution, up to 16X magnification in the average mode. Note, the magnify mode is most useful when the instrument is in the average mode.

6-7. TIMEBASE MENU

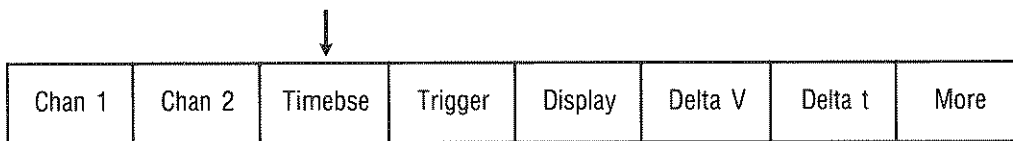

After the AUTO-SCALE system control key is pressed you will notice that the instrument has established itself in the timebase menu and the SEC/DIV function.

The Timebase menu contains two variable functions. Note: Variable functions are identified by UPPER CASE LABELS. (See Figure 6-2.)

The SEC/DIV function allows the time scale on the X-axis to be varied from 1 sec/div to 100 ps/div in a 1-2-5 sequence by using the entry devices. Sweep speeds can be entered from the number pad with up to 3 digits of resolution.

The effect is very similar to turning the time/division switch on a conventional oscilloscope.

For sweep speeds slower than 2.5 μ s/div the sampling rate is changed to provide an appropriate display on the CRT.

The DELAY function controls the pre and post trigger delay and can be varied by the entry devices. The adjustment resolution for DELAY time is equivalent to 0.2% of the time interval represented by 10 horizontal divisions (but not less than 2 ps or 1 ppm whichever is greater). The DELAY function has an effect similar to that of a horizontal position control on a conventional oscilloscope, but with the added advantage of having a range of millions of screen widths.

The Delay Ref. key allows you to reference the delay to the right or left graticule edge or center screen. The time at the Delay ref. is equivalent to the delay time. DELAY = 0 is the trigger point.

When the DELAY function is selected, delay time is displayed at the top of the waveform display area. Maximum pre and post trigger time intervals vary with sweep speed and Delay Ref. location.



Negative DELAY values infer time before the trigger and positive DELAY values infer time after trigger. The trigger point is at DELAY = 0.

The last key on the Timebase menu is the Auto/Triggered (Trg'd) key. When the Auto sweep function is chosen the unit will provide a baseline on the display in the absence of a trigger signal. If a signal is present, but is not triggered, the display will be unsynchronized but will not be a baseline.

If the unit is in Trg'd sweep and no trigger is present the unit will not sweep, and the data acquired on the previous trigger will remain on-screen.

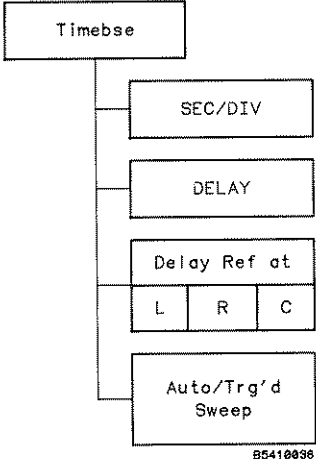

Figure 6-2. Timebase Menu

Always use the Trg'd Sweep function when the trigger rep. rate goes below 20 Hz. to prevent Auto Sweep from generating a sweep prior to the trigger event. The signal on the display that was initiated by Auto Sweep would be asynchronous with the signal on the sweep that was initiated by the trigger event. The oscilloscope will trigger normally if the trigger repetition rate is greater than 20 Hz.

NOTE

The STATUS line in the upper left corner of the screen indicates the current trigger status. It is updated every half second. In the Trg'd sweep mode the STATUS line indicates whether the instrument is "Running" or "Awaiting Trigger". In the Auto Sweep mode the STATUS line indicates whether the instrument is "Running" or "Auto Triggering". Other status indications are "Stopped", "Measuring", "Printing", "Plotting", and "Testing". The 20 Hz auto trigger repetition rate applies even for long DELAY or large SEC/DIV settings.

6-8. TRIGGER MENU

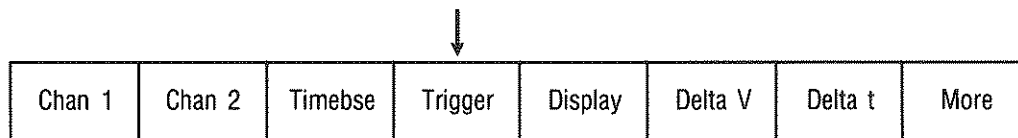

The Trigger menu allows you to select trigger mode, source, slope and holdoff. This menu also is used to invoke the unit's combinatorial triggering capability (logic pattern triggering). (See Figure 6-3).

When previewing the trigger menu notice the five trigger modes: Edge, Pattern, State, Time-Delay, and Event-Delay modes. Let's first discuss the Edge Mode. Edge Mode allows you to select one of four trigger sources (Trig Src), adjust the trigger level (TRIG LEVEL), select the slope of the input signal that is to be used to define the trigger (Pos/Neg), and define the HOLDOFF in Time or Events.

The Trig SRC key permits the selection of one of four possible trigger sources; Chan 1, Chan 2, Trig 3, or Trig 4. (Trig 4 is available only on the 54100D).

If TRIG LEVEL is the selected function and you use Chan 1 or 2 as the Trig Src, a horizontal line will appear on the display. This line shows the TRIG LEVEL with respect to the displayed signal.

Slope selects the Neg or Pos slope of the input signal to be used as the trigger. The trigger slope and level can be set independently for each channel and the settings for the channel will be retained even though another channel is selected as the trigger source, or another trigger mode is selected.

The HOLDOFF circuitry allows you to define the period following a trigger event during which the trigger circuit is disabled. By pressing the HOLDOFF function key you can determine whether the HOLDOFF is to be defined by time or events. An event is defined as a change in the input that satisfies the trigger conditions. If Time is used to define holdoff the range is from 70 ns to 670 ms. HOLDOFF by Events range is from 2 events to 6.7×10^7 events. Maximum counting rate for events is 80 MHz.

Holdoff by events can be used to trigger stably on a complex waveform by counting the number of trigger events that are to be skipped before accepting another for a trigger. By setting the holdoff by events to one less than the number of events occurring over the fundamental period, a stable display will result. Holdoff by events is equivalent to placing a divide-by-N counter in the trigger path where N is one plus the holdoff value.

Unlike conventional oscilloscopes the trigger system in the 54100A/D is completely independent of the timebase. This means that adjusting the DELAY or SEC/DIV functions will not disturb the display synchronization established with holdoff. Also, it should be noted that auto sweep acts on the repetition rate of accepted triggers so holdoff by time values greater than 50 ms or large holdoff by events values can result in a low effective trigger repetition rate. In this case the Trg'd sweep function should be used. Holdoff can be varied by using any of the entry devices and is displayed at the top of the waveform display area.

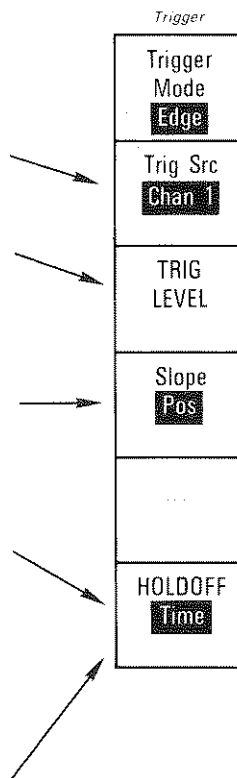

54100A/D
Trigger Menu
Trigger Mode

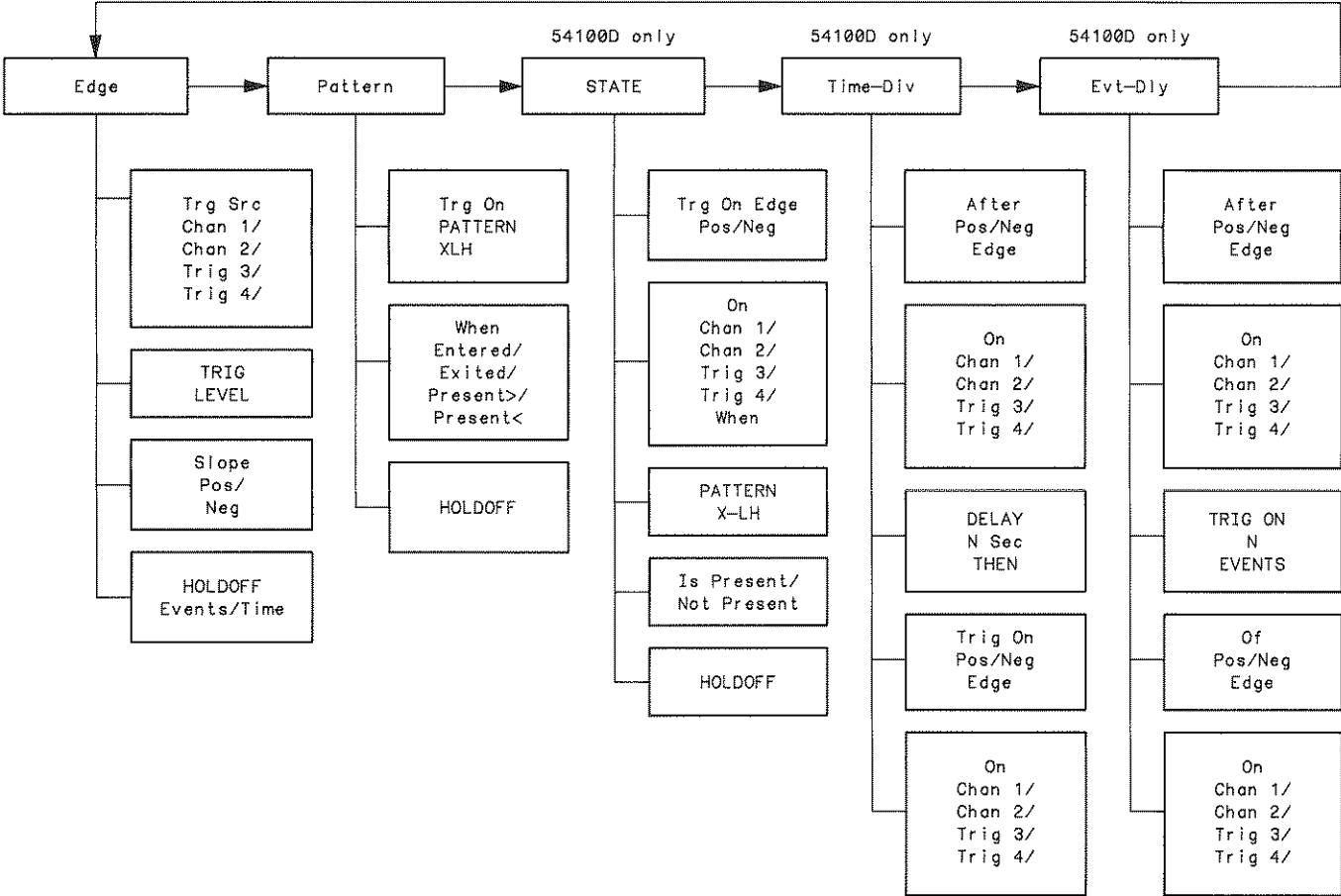

85410038

Figure 6-3. 54100A/D Trigger Menu

6-9. PATTERN MODE

Press trigger mode function key to access the Pattern Mode. In this mode you have 4 bit pattern recognition capability and the instrument can be triggered either when entering or exiting this pattern. (The 54100A uses a 3 bit pattern.) Holdoff can be defined either by events or time.

The label for the Trig On PATTERN function key includes four characters in an inverse video text field. When the Trig On PATTERN key is pressed one of these characters will be highlighted. By using the entry devices you can change this character to one of three letters; X, L, or H. Pressing trig on pattern again will sequence through the character field so each can be edited. X indicates a "don't care condition", L indicates a requirement for an input < the trigger level for that input. H indicates a requirement for an input > the trigger level for that input.

The three characters in this text field determine whether the voltage levels at each of the 3/4 inputs (Chan 1, Chan 2, Trig 3, and Trig 4) (54100A does not use the Trig 4 input) are required to be above or below TRIG LEVEL or are not used as a trigger qualifier. If these characters read "LHXX", Chan 1 would have to be below the trigger level, Chan 2 would have to be above the trigger level to satisfy the pattern condition.

NOTE

Set the TRIG LEVEL for each trigger source while you are in the Edge mode. These trigger levels must be set before going to the Pattern mode or proper Pattern triggering may not occur.

The next key on the function menu is the When Entered/Exited key. When this key is pressed the inverse video text field next to the key will change from Entered to Exited or vice versa. If When Entered is selected, the unit will generate a trigger on the last transition that makes the PATTERN true. If When Exited is selected the unit will generate a trigger on the first transition on any of the inputs that cause the pattern to be false, after it was initially true.

When you are in the pattern mode and you have pressed the Trig On PATTERN key the condition that a particular input must be in to satisfy the pattern requirements will be shown at the top of the waveform display area.

The triggering capabilities that have been discussed to this point are shared by the 54100A and 54100D except where specifically stated otherwise. The remainder of this chapter deals exclusively with the additional triggering capabilities of the 54100D. (See Figure 6-3)

The 54100D has two additional functions on the Pattern Trigger Mode menu; When Present> and When Present<. These functions can be accessed by pressing the When key. These two functions allow time to be used as an additional trigger qualifier.

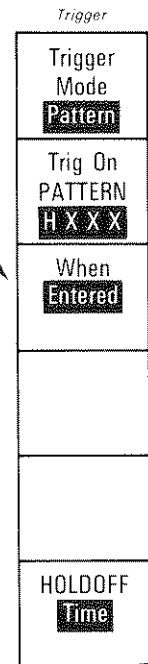
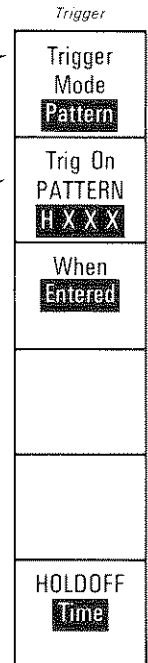

If when Present > is selected, a trigger event will occur if the trigger pattern is true for a minimum time period. This period is listed in the label for the time key and can be varied from 10 ns to 5 sec. by the entry devices.

When the trigger pattern remains true for the required period of time, a trigger will occur when any of the inputs transition to a false state. If the pattern becomes true and then goes false before the specified time, no trigger will occur.

If When Present< is selected, a trigger will occur only if the trigger pattern is satisfied and one of the inputs transitions to a false state before a given time period. In this mode, the pattern must be true for at least 1 ns to be recognized.

This period is listed in the time key label and can be varied from 10 ns to 5 sec. by the entry devices. Only holdoff by time is available within the when present modes.

Press the Trigger Mode key, the label will change to State. In the State mode one of the inputs is selected as a simple edge source, the other three are used to define a pattern.

A trigger will occur on the edge (pos/neg) when the pattern is true and Is Present is selected. A trigger will also occur on the edge (pos/neg) when the pattern is false and Is Not Present is selected. The threshold is set by TRIG LEVEL when you were in the edge mode. Only holdoff by time is available with the state mode.

Press the Trigger Mode key and the label will read "Time Dly", (Time Delay). This menu allows you to arm on a signal edge on any source, wait for a period of time and then trigger on an edge from a different source. The edge polarities, the sources that are used to define the edges, and the delay time are all user definable.

The second and third function keys allow you to select the polarity and source of the arming edge. The delay time range is from 20 ns to 5 sec.

The fourth key allows you to define a waiting period between the arming edge that is used as a trigger qualifier and the edge on which the instrument triggers.

The fifth and sixth function keys allow you to select the polarity and source of the edge that is used as the trigger event.

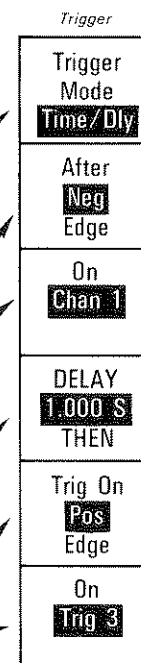
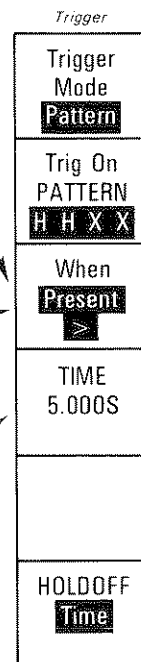

The last trigger mode is Evt-Dly, (event delayed). This menu allows you to define an edge as a trigger qualifier. Once this edge is detected the unit will trigger after a definable number of edges on any other source.

The second and third keys on the menu allow you to select the polarity and source of the arming edge.

The fourth key allows you to determine the number of edges on the trigger source that are to take place before the trigger event.

The fifth and sixth keys allow you to determine the polarity and source of the triggering and counting edge.

In the edge mode TRIG LEVEL is used to specify a threshold for each source independently. It is these thresholds that are in effect in all other modes wherever a source is active in a triggering function. Other than thresholds there is no interaction between the trigger menus. Changing slopes or patterns in one menu will not affect corresponding entries in other mode menus.

In most of the triggering modes it is possible to specify parameters which will reduce the effective trigger repetition rate (display triggers) to below 20 Hz. Since the auto sweep function measures the rate of display triggers the timebase should be put in Trg'd mode to avoid premature automatic triggers with large event delay counts, filter times etc.

Trigger

| |
|---------------------------|
| Trigger Mode Evt - Dly |
| After Neg Edge |
| On Chan 1 |
| TRIG ON 1 EVENTS |
| Of Pos Edge |
| On Trig 3 |

NOTES:

6-10. DISPLAY MENU

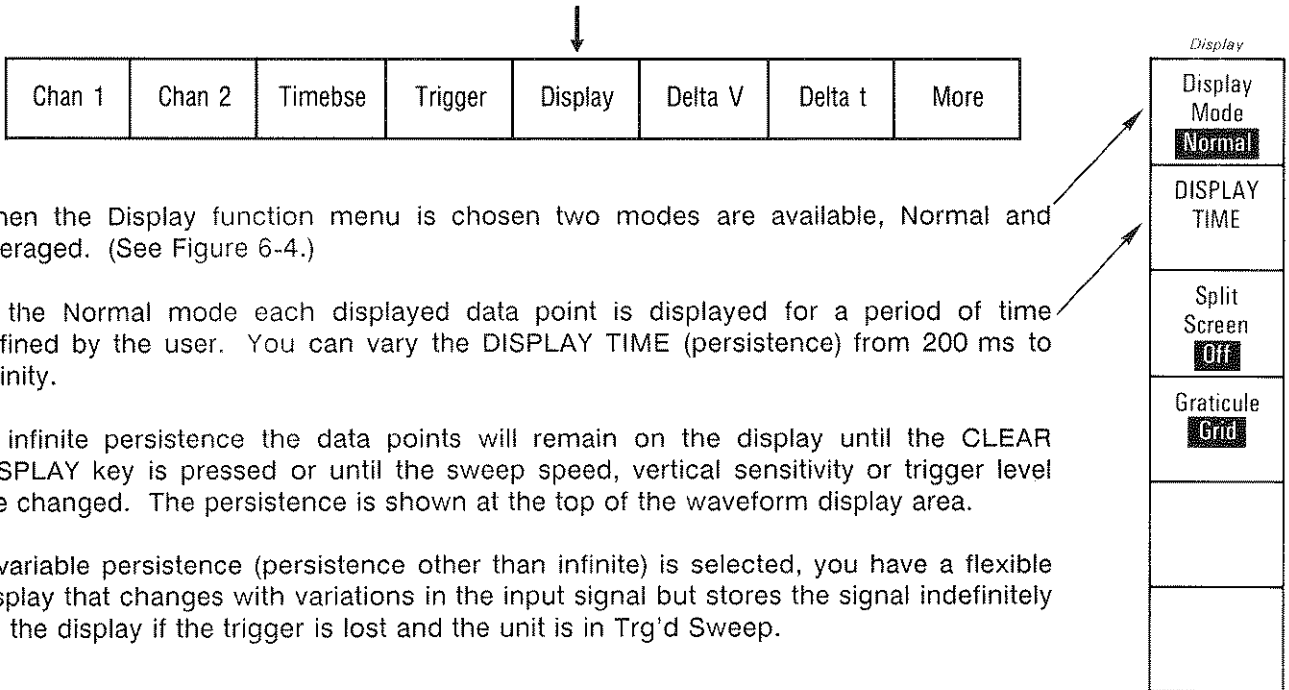

When the Display function menu is chosen two modes are available, Normal and Averaged. (See Figure 6-4.)

In the Normal mode each displayed data point is displayed for a period of time defined by the user. You can vary the DISPLAY TIME (persistence) from 200 ms to infinity.

In infinite persistence the data points will remain on the display until the CLEAR DISPLAY key is pressed or until the sweep speed, vertical sensitivity or trigger level are changed. The persistence is shown at the top of the waveform display area.

If variable persistence (persistence other than infinite) is selected, you have a flexible display that changes with variations in the input signal but stores the signal indefinitely on the display if the trigger is lost and the unit is in Trg'd Sweep.

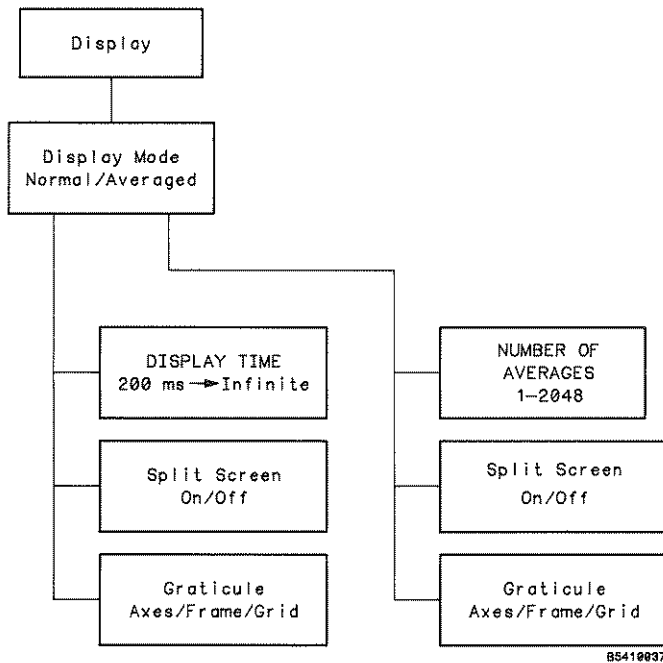

Figure 6-4. Display Menu

A minimum persistence setting is useful when the input signal is changing and the user needs immediate feedback, such as in rapid probing from point-to-point, or setting the amplitude or frequency of a signal source. More persistence is useful when observing long-term changes in the signal or low signal repetition rates. At fast sweep speeds and low trigger rep. rate conditions more persistence is needed to gain an adequate number of data points on the display. Infinite persistence is useful for worst-case characterization of signal noise, jitter, drift, timing, etc.

There is a limit to the number of data points that can be displayed on the screen at any one time in the variable persistence mode. The display time is temporarily reduced whenever the number of points exceeds 5,600. This has the effect of reducing the number of data points on the display. When this happens you might see the display appearing to pulsate, that is, a number of points will accumulate and then the display will fade and build up again, etc.

If Averaged Mode is selected the last acquired data points are averaged with previously acquired data before they are displayed. The number of data points that is averaged is variable from 1 to 2048. The step keys and the knob change the number of averages in powers of 2; however, any number of averages between 1 and 2048 can be entered from the key pad.

Vertical resolution can be extended and displayed noise can be significantly reduced by using the averaged mode. As the number of averages is increased, the display becomes less responsive to changes to the input signal(s); however, noise is reduced, and resolution is improved as more averages are used. By selecting the appropriate number of averages the throughput for the automatic pulse parameters or the precise edge locators can be controlled. Since these automatic measurements use averaging the user can trade off the speed of the measurements against the repeatability of the measured results.

The input signal is digitized and each data point is assigned a time slot relative to the trigger. In the averaging mode the unit calculates the average of the most recent data point with the previous values in the same time slot. You can define the number of data points that are to be averaged from 1 to 2048. Each average is calculated from data acquired for each time slot, data for adjacent time slots is not averaged together.

The current number of averages which have been accumulated is listed on the second line of text in the upper left of the screen. When a precise measurement is made in the average mode, this readout displays the running number of averages for the measurement. Because only data points in the same time slot with respect to the trigger are averaged together, averaging does not reduce the bandwidth or risetime of the acquired waveform.

The next function key on the display menu is the Split Screen key. When split screen is keyed On, Chan 1 or Func 1 will be presented in the upper half of the display and Chan 2 or Func 2 in the lower half. Scaling accuracy is maintained as this function is turned off/on. When the split screen function is keyed off Chan 1 or Func 1 and Chan 2 or Func 2 will be overlaid on the display area.

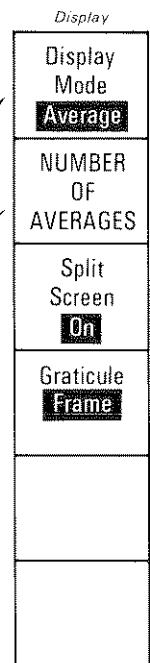

NOTE

In the split screen mode each channel occupies 4 vertical divisions rather than 8 as is the case when split screen is off. This requires the vertical sensitivity in volts/div be doubled.

Three different graticules are available in the display function menu. Press the graticule key and cycle through them to see how they appear. You will find that using the frame graticule makes it easier to see the Delta V and Delta t markers.

6-11. DELTA V (VOLTS) MENU

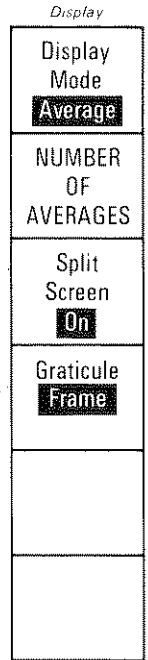
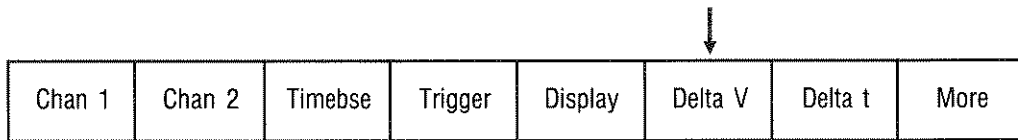

When the Delta V (delta volts) menu is enabled, two markers are displayed. These markers can be used to make absolute voltage measurements on the signal under evaluation or as reference markers when adjusting a signal to a given amplitude. (See Figure 6-5)

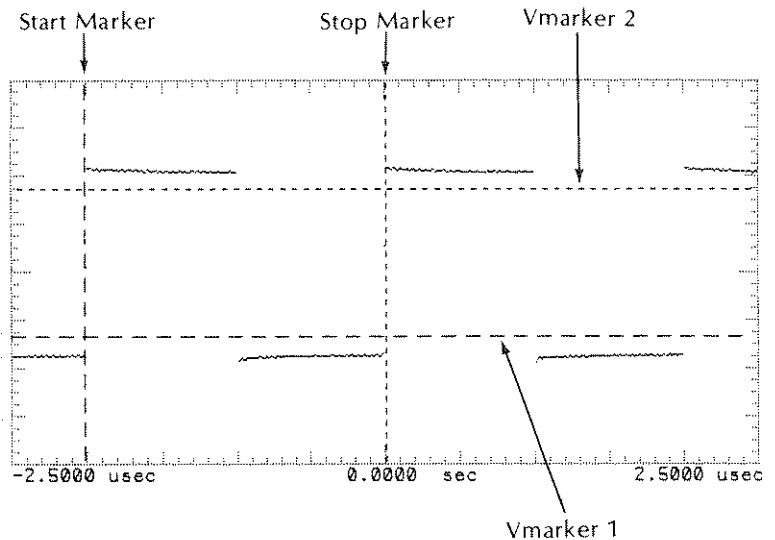
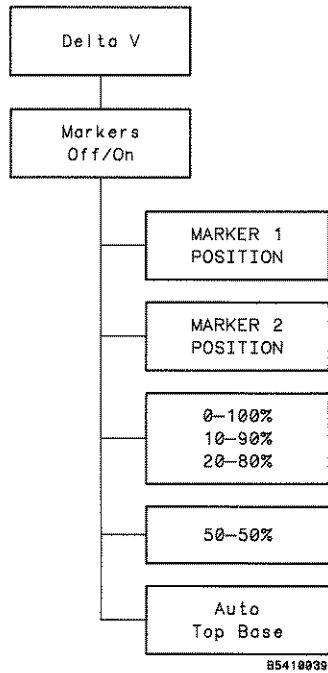

Figure 6-5. Delta V Menu

Figure 6-6. Vmarkers

Once the delta V menu is selected, the markers cannot be activated unless the display for chan 1 or 2 or func 1 or 2 or memory 1-4 is turned on. Choose the source you would like to evaluate and enable the V markers. Observe the next two functions on the delta V menu, MARKER 1 POSITION and MARKER 2 POSITION. (See Figure 6-6.)

After assigning the markers to the desired channel(s), func(s), memory or memories selecting marker 1 position and marker 2 position function keys will allow you to position the markers vertically with the entry devices. The voltage shown at the top of the waveform display area indicates the voltage level of the selected V marker. The difference between the two markers is shown in the factors area at the bottom of the display.

In the lower portion of the display are the "display factors", these factors include the delta V value and the absolute value for each marker. The delta V function simplifies waveform measurements.

The next three keys on the delta V menu automatically position the V markers on the display. The 0-100/10-90/20-80% key causes the instrument to perform some calculations and position the V markers for the user. When the V markers are positioned manually the inverse video field will change to 0-100%. If the key that is showing 0-100% is pressed the label will change to 10-90% and the markers will move to the 10% and 90% points of their previous levels. If the key is pressed again the label will change to 20-80% and the markers will move to the 20% and 80% points of their original levels. The 50-50% key moves both markers to the 50% point of the 0-100% levels.

The Auto Top-Base automatically locates the top and base of the displayed waveform. This is done by evaluating a histogram of the displayed signal.

If either of the V markers are manually repositioned while the function switch is in 10-90%, 20-80%, or 50-50% the original reference will be lost and the label for the key will change to 0-100%.

If two channels/functions/memories are on, the Vmarkers can be assigned to any trace. If you select the Dual Vmarker function you may assign either Vmarker to either channel, or both Vmarkers to a single channel. If Auto 50-50% key is pressed with Vmarkers set to dual, one Vmarker will go to the 50% point of one trace and the second Vmarker will go to the 50% point of the other trace.

Input the cal signal from the rear panel to Chan 1 and press auto-scale. Next select the Delta V function menu and key on the V markers. Now, establish the top-base by pressing auto top-base. To demonstrate the action of the 0-100/10-90/20-80% key, press it several times, notice how it cycles through the three selections and how the V markers move. Press the 50-50% key, this establishes the V markers at the 50% point of the signal.

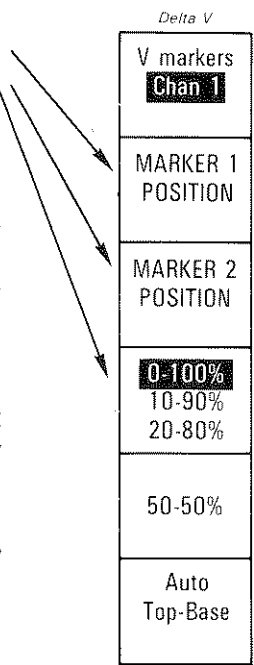
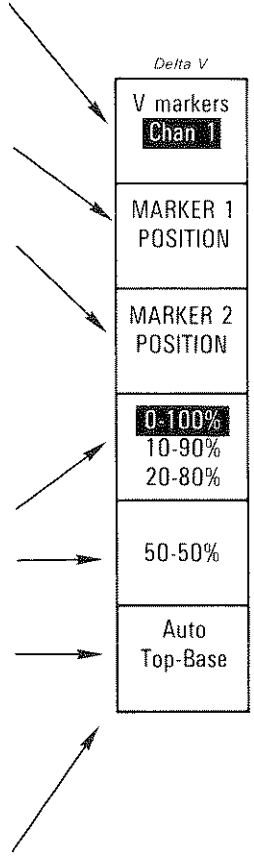

6-12. DELTA T (TIME) MENU

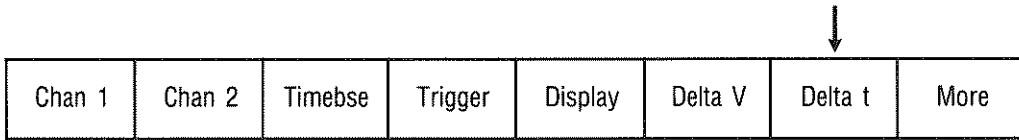

The Delta t function menu provides control for two T (time) markers that can be used to make measurements in the time domain. The display factors include Δt which is the time interval between the two Tmarkers. In Figure 6-6 the Start marker = 2 us and the Stop marker = 0 sec. These times tell you the time between the Tmarkers and the delay ref. (Refer to Figure 6-7 for the Delta t menu).

After the Tmarkers have been enabled, each Tmarker can be moved manually by selecting START MARKER or STOP MARKER and using the entry devices. The time between the selected Tmarker and the trigger event is listed just above the waveform display area on the CRT.

The Delta t menu is extended when the Delta V markers are turned on. START ON EDGE, STOP ON EDGE, and Precise Edge find Functions are available on the Delta t menu when the Delta V markers are on. Try this exercise to demonstrate these capabilities.



Connect the cal signal to Chan 1 and press the AUTO-SCALE control key. Select the delta t menu and turn the t markers on. Manually move the start marker so that it coincides with the first positive leading edge of the cal signal (Figure 6-6). This is one way of making a time interval measurement.

In the display factors, the start marker is approximately 2 us ahead (-2 us) of the trigger event (delay = 0) which was established at center screen when you used AUTO-SCALE. The stop marker is located approximately center screen and the time interval between the t markers (delta t) is approximately 2 us.

Select the delta V menu and turn the V markers on. Press auto top-base then press 50-50%. For this measurement the significant thing is to make sure that the V markers intersect the rising and falling edges of the signal.

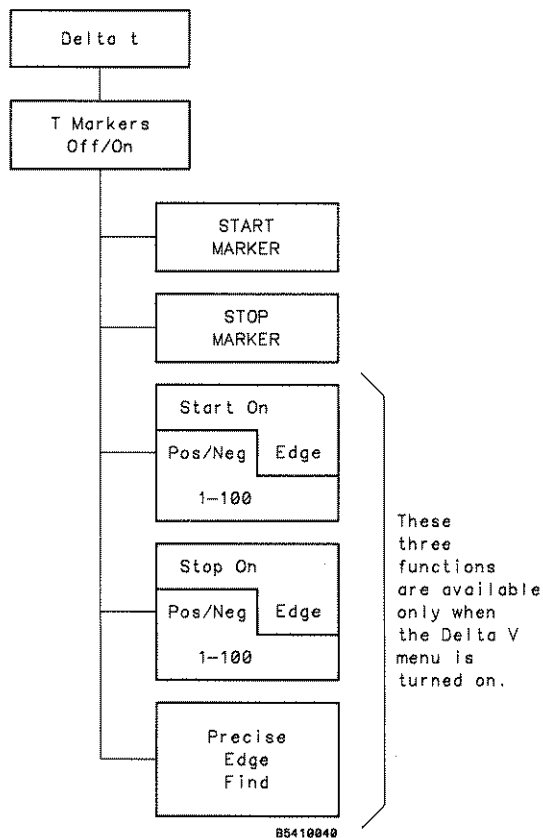

Figure 6-7. Delta t Menu

Return to the delta t menu. Press START ON EDGE function key several times, notice that the pos/neg indicator alternates and the start marker moves from the positive edge of the first pulse to the negative edge of the same pulse. Try using each of the entry devices to move the START EDGE to another pulse. STOP EDGE can be changed in this fashion also. Start on edge and stop on edge are "coarse" edge locators in as much as data already collected on screen is used to locate the edges.

To demonstrate the last delta t menu function, precise edge find, return to the delta V menu and press auto top-base to locate the top and base of the cal signal, then select 10-90%. Now again return to the delta t menu. Set start edge to pos 1 and stop edge to pos 1 and press precise edge find. Δt (in the factors field) will represent the rise time of the pulse, in this case approximately 2 ns. Note that the instrument automatically selects a faster sweep range, to increase the resolution of the edge finder.

The precise edge find function initiates an automatic time interval measurement. The instrument will acquire the data, make the measurement and have the delta t and delta V markers visible on the display so that you can see where the automated measurements were made.

When you use the precise edge find function the unit will expand the selected edges defined by the start on edge and stop on edge functions. This expansion is accomplished with newly acquired data. By expanding the edge in this fashion the horizontal resolution is increased. The speed and repeatability of this measurement is influenced by the number of averages. The more averages the more repeatable and slower the measurement will be. Other items that will influence measurement speed and repeatability are: input signal edge speed, repetition rate, signal jitter, starting sweep speed and delay. If the Vmarkers are set to dual and you press auto 50/50, you may do a semi-automated 2 channel time interval measurement by going to the Delta t menu and pressing precise edge fine key.

6-13. MORE

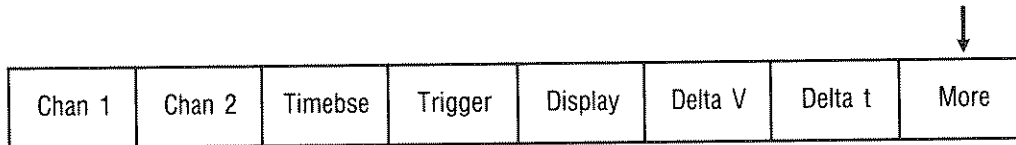

To view the remaining menus press the "More" key. It is located in the lower right hand corner of the display. This key allows you access to seven additional function menus. Pressing the More key again allows you to return to the original set of menu keys.

6-14. WFMSAVE (WAVEFORM SAVE)

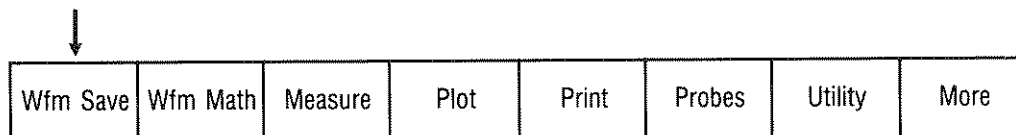

The 54100A/D has 6 waveform memories available from the front panel; Waveform memories 1 through 4 and pixel memories 5 and 6. (See Figure 6-8)

When waveforms are stored to one of the four waveform memories the waveform factors are stored as part of the record. These factors include: vertical sensitivity, vertical offset, sweep speed, and time delay. The fact that these factors are maintained allows you to make measurements on waveforms stored in these memories. These waveform records can store only one waveform at a time. If you store a waveform to a memory that contains a waveform record the first record will be written over and lost.

Pixel memories 5 and 6 are 256 by 501 bit memories and are constructed so that multiple waveforms can be stored in each. If more than one waveform is stored to a pixel memory the waveforms will be superimposed. Waveform factors are not maintained when a waveform is stored to a pixel memory, therefore measurements cannot be made on these waveforms. The first function key on the waveform save menu is the WAVEFORM/PIXEL MEMORY select key. When this key is pressed repeatedly the selected memory will cycle through waveform memories 1, 2, 3, 4, and pixel memories 5 and 6. This function is also slaved to the entry devices, that is, the key pad, step keys and the knob can be used to change the selected memory.

The second key allows you to display or not display the waveform(s) in the selected memory. This key also allows you to select either the upper or lower screen to display the memory when the instrument is in the split screen mode.

When memory 1, 2, 3, or 4 is selected the "Store From" key allows you to select the source of the waveform that is to be stored when the store key is pressed. The potential sources are chan 1, chan 2, func (function) 1 and func 2.

In order for a source to be available for "Store From", it must be turned on. For example, in order to have func 1/2 as a source for Store From, the selected function first must be turned on using the Wfm Math menu.

When func 1 or 2 are turned on they replace chan 1 and chan 2 respectively, both in the chan 1/2 menus and the wfm save menu, therefore only two of the four sources can be active at any one time.

If you have selected one of the waveform memories i.e., 1-4, the last key on this menu will be the Store key. When you press this key the source will be stored in the selected waveform memory.

The four waveform memories are nonvolatile memories, that is, the data in these memories is retained when the instrument is turned off and then turned back on. The data in the two pixel memories is lost when the instrument is turned off.

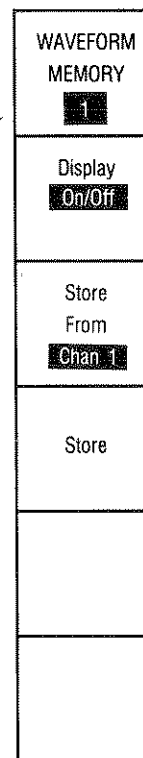

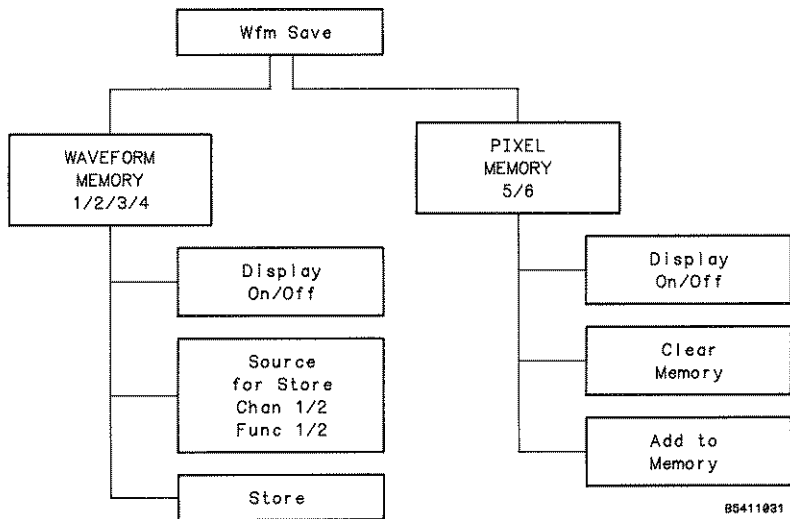

Figure 6-8. Wfm Save Menu

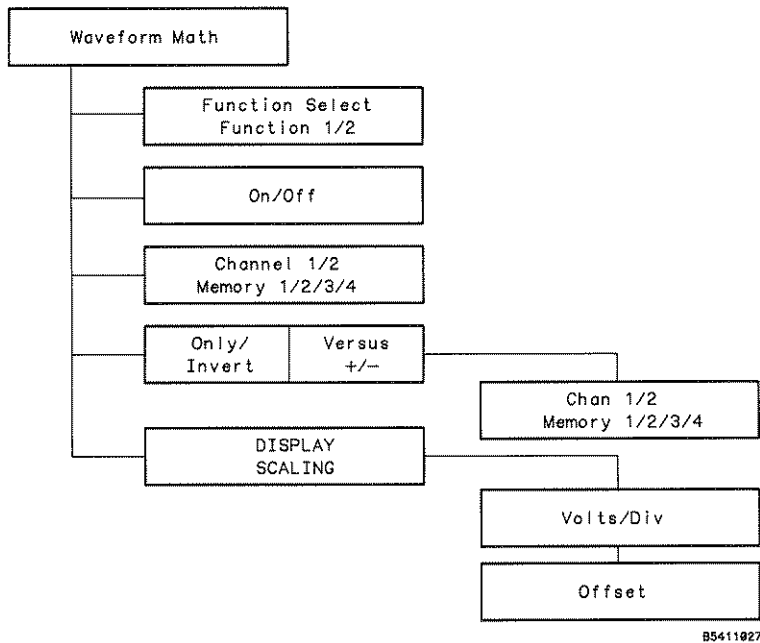

Figure 6-9. Waveform Math Menu

If you select pixel memory 5 or 6 the function menu will change. The third key will change to the Clear Memory key and the fourth key will be the Add to Memory key.

The clear memory key allows you to erase whatever is stored in the selected pixel memory.

When the add to memory key is pressed, whatever data is being displayed in the waveform display area (with the exception of the graticule and markers) will be written to the selected pixel memory, along with whatever data is already there.

6-15. WFM (WAVEFORM) MATH

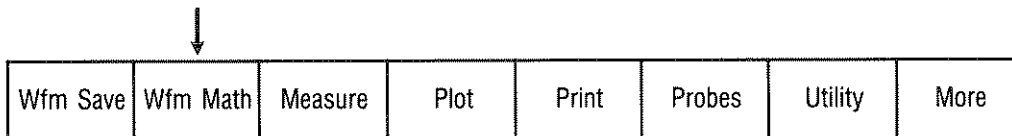

The Wfm Math menu allows you to define two functions (Func 1 and 2) using the channels and waveform memories as operands. The operators are: +, -, Invert, Only, and Versus. This menu also allows you to determine the vertical offset and scaling for the function display. (See Figure 6-9.)

The Function Select key allows you to select Func 1 or Func 2 as the active function.

The next key allows the display of the selected function to be turned on/off. When a function is turned on it takes the place of the associated channel. For example, if func 1 is turned on the trace on the display will change from chan 1 to func 1. If you select chan 1 menu the ch1 mode will indicate func1 on. If this key is pressed the ch1 mode will change to Normal, and func1 display will be replaced by chan 1. You may toggle the ch1 mode switch and cycle back to func1.

The next key allows the selection of the first operand. The fourth key is used to select the function operator. The choices are; +, -, Invert, Only and Versus. If Invert or Only are selected the second operand is not used.

The next key is used to select the second operand. Your choices are the same as for the first operand.

The last key on the wfm math menu is the DISPLAY SCALING key. This key allows you to slave either the vertical sensitivity (volts/div) or the vertical offset to the entry devices for the display of the selected function. The initial DISPLAY SCALING sensitivity and offset are based on the voltage range of the operands that define the function. Whenever the operator or operands are changed the display scaling sensitivity and offset are set to the initial values.

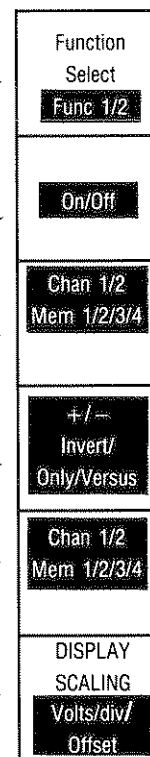

6-16. MEASURE

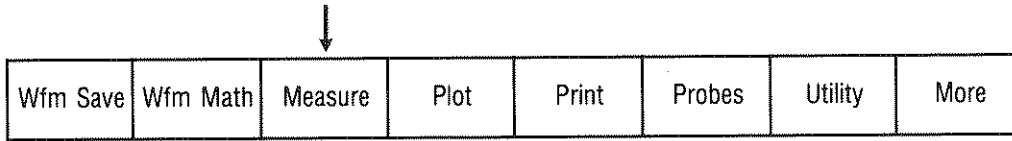

When you press the Measure menu select key, you will have access to three function menus which can be accessed by pressing the more key on the function menu. (See Figure 6-10.) If neither of the channels or the funcs are activated measure will default to chan 1 and measurements will automatically activate the chan 1 display. In order to make automated measurements on chan 2, func 1, 2 or mem 1 through 4 they must be turned on. To make a measurement on a single waveform memory use the Wfm Save menu and turn the desired memory on. The instrument will not make measurements on a function if the operator is "Versus".

The second key in the first measure menu is the Precision Fine/Coarse key. This instrument will perform two types of automatic measurements, fine precision and coarse precision. Coarse measurements are made on displayed data. If there is insufficient data on screen, new data is acquired in order to make the measurement. Fine measurements begin with a coarse measurement to locate the edge(s). Each edge is then expanded to achieve maximum resolution. The coarse measurements take less time to accomplish, this should be considered if through-put is a more important issue than measurement resolution. Peak to peak, preshoot, and overshoot measurements are always coarse measurement and use on screen data. The next two keys automatically measure the frequency and period respectively of the selected source.

The next function key is the All key, when pressed the 54100A/D automatically makes the measurements below and lists the results in the factors area. Each of these automated measurements can be made separately if the appropriate function key is pressed. The More key at the bottom of the menu allows you to select the next measure menu when pressed.

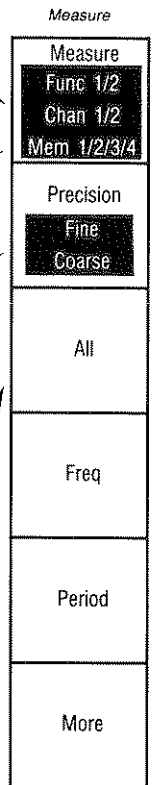

| | | |
|------------------|--------------------|----------------------|
| Freq (Frequency) | + Width | Peak-to-Peak Voltage |
| Period | - Width | Preshoot |
| | Duty Cycle | Overshoot |
| | Rise Time (10-90%) | RMS Voltage |
| | Fall Time (10-90%) | |

The instrument will also make a course measurement, that is, using only data on screen, when the 54100A/D is in the STOP mode. The stop mode can be selected by pressing the STOP/SINGLE system control key. The instrument will only make course measurements on any of the waveform memories or functions that contain a waveform memory as an operand.

6-17. PLOT

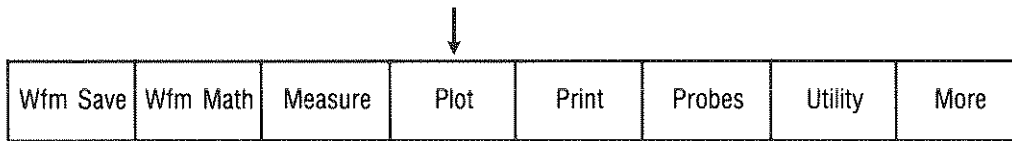

The plot menu allows display data to be output over HP-IB to a digital plotter that is HPGL (Hewlett Packard Graphics language) compatible. (See Figure 6-11) The 54100A/D must be in "Talk Only" and the HP-GL plotter must be in the "Listen Only" mode. The HP-IB mode can be set by using one of the Utility function menus.

The first option on the plot menu is the Auto Pen selection. When this function is On a new pen will be selected when a different function is chosen to be plotted, that is, if the plotter has multi pen capability. If Auto Pen is Off the plotter will not load or change pens when a plot function is selected.

The next plot option is Pen Speed. You may choose Fast or Slow if your plotter has this feature. Use slow when you are making overhead transparencies. For best results use slow for Leroy pens.

When Plot Graticule is selected the displayed graticule, including display factors, will be output to the plotter.

If the Display menu is in the Averaged mode, the output from the 54100A/D will cause the plotter to draw a continuous line plot of the active display.

If the Display menu is in the Normal mode the output from the 54100A/D is formatted such that the plotter will plot the waveform in a pixel format, that is, dot by dot if you are plotting an active display.

Waveform memories will always be plotted with a continuous line and pixel memories are always plotted dot by dot.

While a plot is being accomplished you can stop the plot by pressing the Abort Plot key. If you would like to stop for a moment and then continue press the Pause/Continue key.

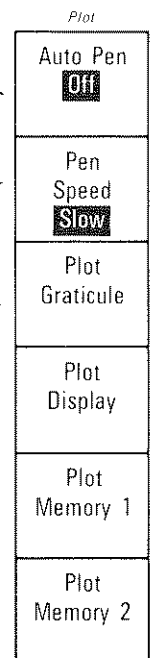

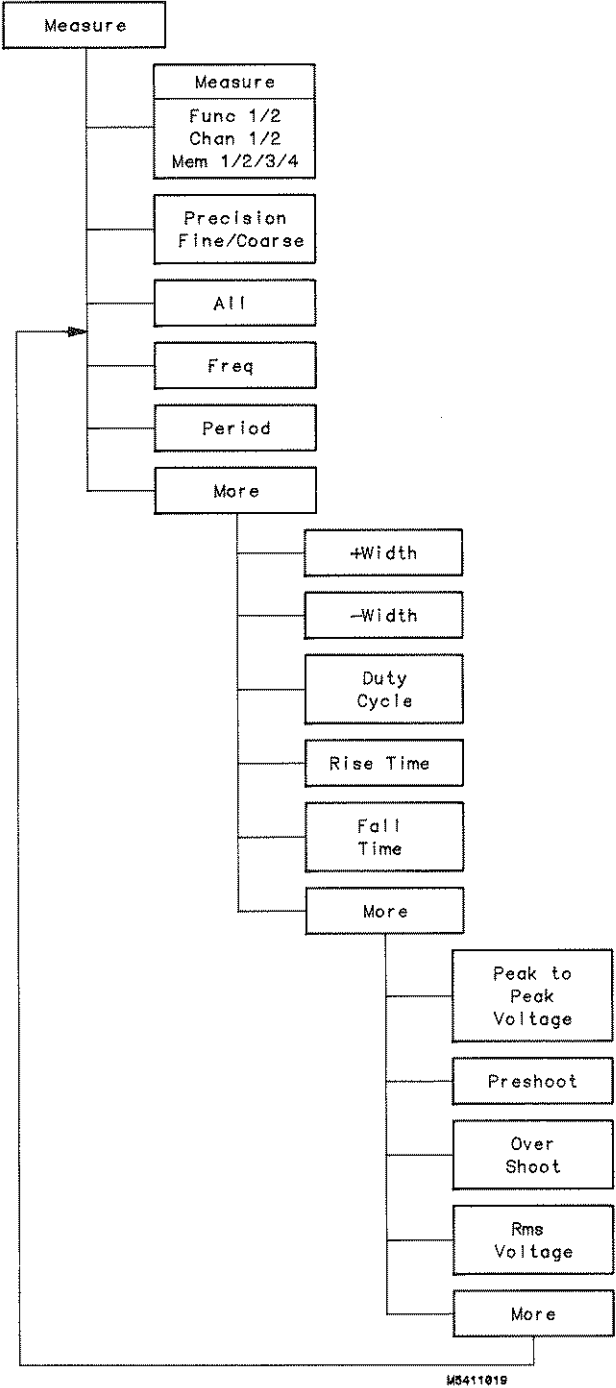

Figure 6-10. Measure Menu

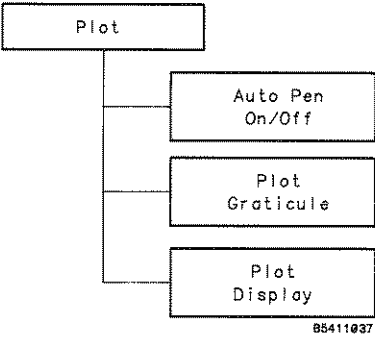
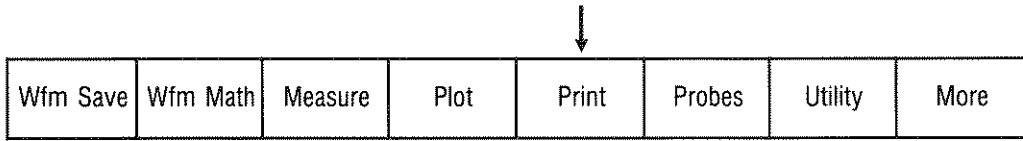

Figure 6-11. Plot Menu

6-18. PRINT



The Print menu allows display data to be output over HP-IB to a graphic printer that is compatible with Hewlett-Packard Raster Scan Standard. (See Figure 6-12.)

The 54100A/D must be in the "Talk Only" mode and the printer must be in the "Listen Only" mode. The 54100A/D can be set to talk only when in one of the Utility function menus.

The print function menu offers you two print options, an automatic form feed option and a Start Print key. The two print options allow the selection of the data that is to be output to the graphics printer. Both sources, factors and display may be output separately or at the same time to the printer. The display data includes the graticule and the active display.

If you desire automatic form feed after a hardcopy, key this function on. After the data has been selected for copying, press the Start Print key to initiate the hardcopy. Signal acquisition stops during printing. To stop printing press the Abort Print key.

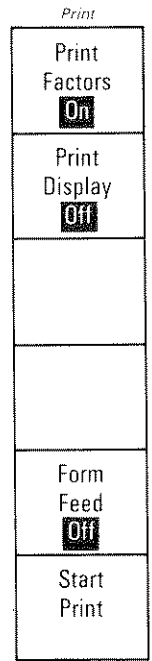

6-19. PROBES

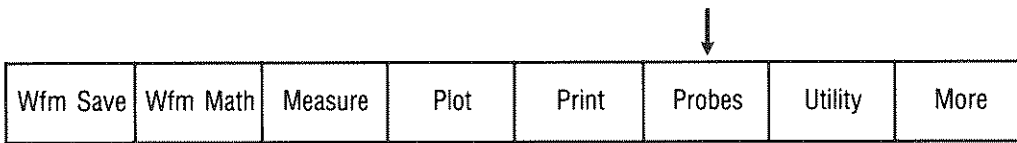

When the Probes menu is selected you can enter any arbitrary attenuation ratio from 1 to 1000 for any of the inputs. Any of the entry devices can be used, however, the key pad allows three digit resolution and can be used as a cal factor for Vmarker measurements. (See Figure 6-13.)

When you define a Probe Attenuation Factor the actual sensitivity at the input of the instrument does not change, all that is changed are the reference constants that are used for scaling the display factors and for automatic measurements, trigger levels, etc.

Attenuation factors can be saved with the rest of the front panel set up in the Save/Recall registers, however, when power is cycled the attenuator factors will automatically be reset to the nominal 1:1 for the 54002A and 10:1 for the 54001A active probe, since the 54100A/D queries the input pod receptacles to determine what pods are installed at power-up.

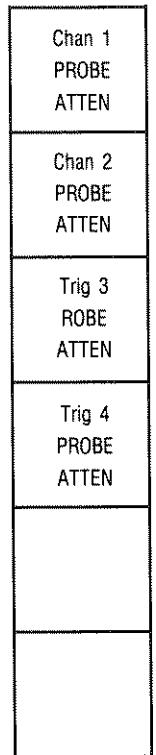

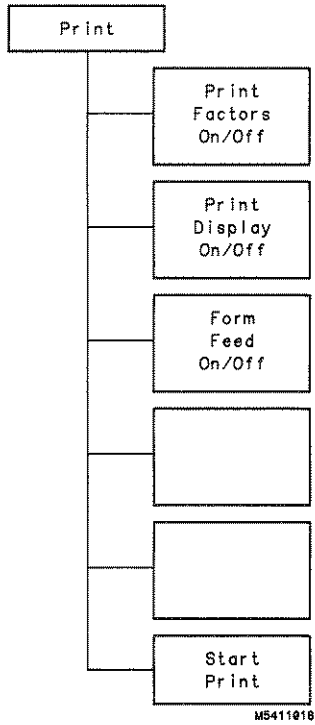

Figure 6-12. Print Menu

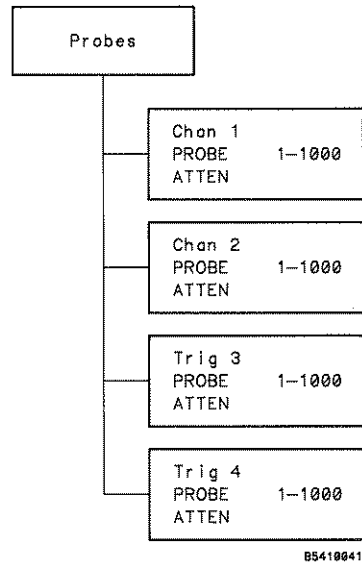

Figure 6-13. Probes Menu

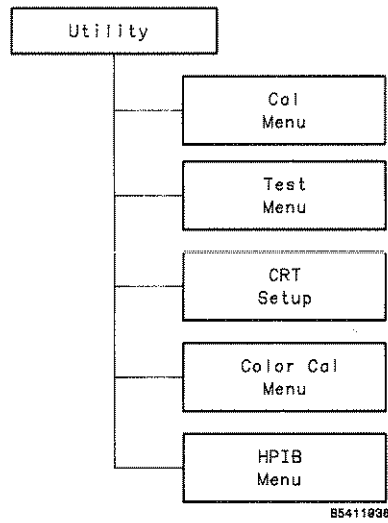
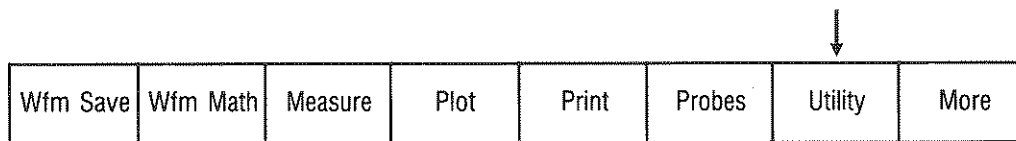

Figure 6-14. Utility Menu

6-20. UTILITY



The Utility menu select key allows access to four submenus that can be selected by pressing the appropriate key at the right of the CRT. These submenus include:

1. Cal Menu
2. Test Menu
3. Crt Setup
4. HP-IB Menu

The Test Menu and the Crt Setup Menu are discussed in the 54100A/D Service Manual and will not be covered here.

6-21. CAL MENU

The Cal menu is provided to so you can null differences between trigger and data acquisition paths. This would include acquisition differences internal and external to the instrument. See Appendix B for a discussion of this topic. (See Figure 6-15.)

In order to obtain the proper cal for a particular system configuration it is necessary to adjust each channel's sensitivity, offset and trigger level as well as the external trigger levels to the values you intend to use. This will establish each input to the configuration that will be used in the actual measurement.

The objective of the cal procedure is to apply a fast edge simultaneously to inputs of the instrument and null out the systematic delay between these inputs. The fastest available edge source should be used (< 1 ns transition time is desirable), however, a signal of the same general characteristics as the signal you intend to measure is a reasonable alternative. For each cal step the inputs should be connected to the calibration source as closely to one another as possible. BNC Tee's and probe adapters are useful to accomplish this.

Be sure to set up all sensitivities, offsets, and trigger levels before beginning the cal menu. The cal menu function allows you to null any differences in propagation delay between signal paths in software in the 54100A/D. This is important so that time-difference measurement results accurately reflect time referenced to the probe tips or the points where the input coaxial cables are connected to the circuit under test.

There are two cal signal outputs on the rear panel. Only one cal source should be used for the cal menu adjustment exercise because the two cal signals are separately buffered and the time differential between the outputs is not characterized.

Connect a BNC Tee to one of the cal signal outputs on the rear of the instrument and connect two equal length 50 ohm cables to the BNC Tee. Connect these two cables to the chan 1 and chan 2 inputs.

For this exercise press AUTO-SCALE and set offset and trig level to equal values for chan 1 & 2 . Move the signal input from chan 2 to trig 3 and then to trig 4 and set the trig level for trig src 3 and trig src 4 as close as possible to the trig level used for chan 1 & 2. Change the Trig Src back to Chan 1. Now move the input cable back to Chan 2.

Press the Utility key and then press the cal menu function key (top key) and follow the instructions on the CRT (but don't AUTO-SCALE again), press the TRIG DELAY-Chan 1 function key, again the top key. As the key is pressed TRIG DELAY will be highlighted and a single channel will be presented on the display.

Press the Expand Waveform function key several times until the waveform is expanded and approximates Figure 6-16. Use the entry devices and adjust the position of the signal on the X-axis so that it intersects the crossing of the graticule at center screen. The value of chan 1 trigger delay is listed at the top of the waveform display area.

Press the top function menu key and the label will change to SKEW Ch to Ch, also the chan 1 & 2 signals will be in the split screen format and should resemble Figure 6-17. The chan 1 signal is in the upper half of the display and chan 2 is in the lower half. The chan 1 signal should be positioned so that it intersects the graticule crossing, this is a result of the previous chan 1 trig delay adjustment. Press the expand waveform key for an appropriate display. Use the entry devices and adjust the chan 2 waveform on the X-axis so that it intersects the graticule crossing at center screen. When you make this adjustment you are nulling the difference in signal acquisition times from chan 1 to chan 2. Chan to chan skew time is listed at the top of the waveform display area.

The next adjustment to be made is the Chan 2 TRIG DELAY. Press the top function menu key, the label for this key will change to TRIG DELAY-Chan 2 and there will be a single signal on the display similar figure to 6-18. Use the entry devices and position the displayed signal on the x-axis so that it intersects the graticule crossing at the center of the display. The ch 2 trigger delay time will be listed at the top of the waveform display area.

Press the top function menu key and the label will change to TRIG DELAY-Trig 3. Connect the cable that has been attached to chan 2 to trig 3. Adjust the entry devices and move the signal on the X-axis so that it intersects the graticule at the center crossing. The value of the trig 3 delay will be listed at the top of the waveform display area.

Press the top function menu key and the label will change to TRIG DELAY-Trig 4. (54100D only). Connect the cable that has been attached to Trig 3 to Trig 4. Adjust the entry devices and move the signal on the X-axis so that it intersects the graticule at the center crossing. The value of trig 4 delay will be listed at the top of the waveform display area. Press the top function menu key again and the label will change to Chan 1. You may now save the cal factors by pressing the Exit Cal Menu key.

Cal factors are kept as part of the SAVE/RECALL setup and different sets of factors may be kept with each front panel setup. When the instrument is powered down these factors will be maintained in nonvolatile memory.

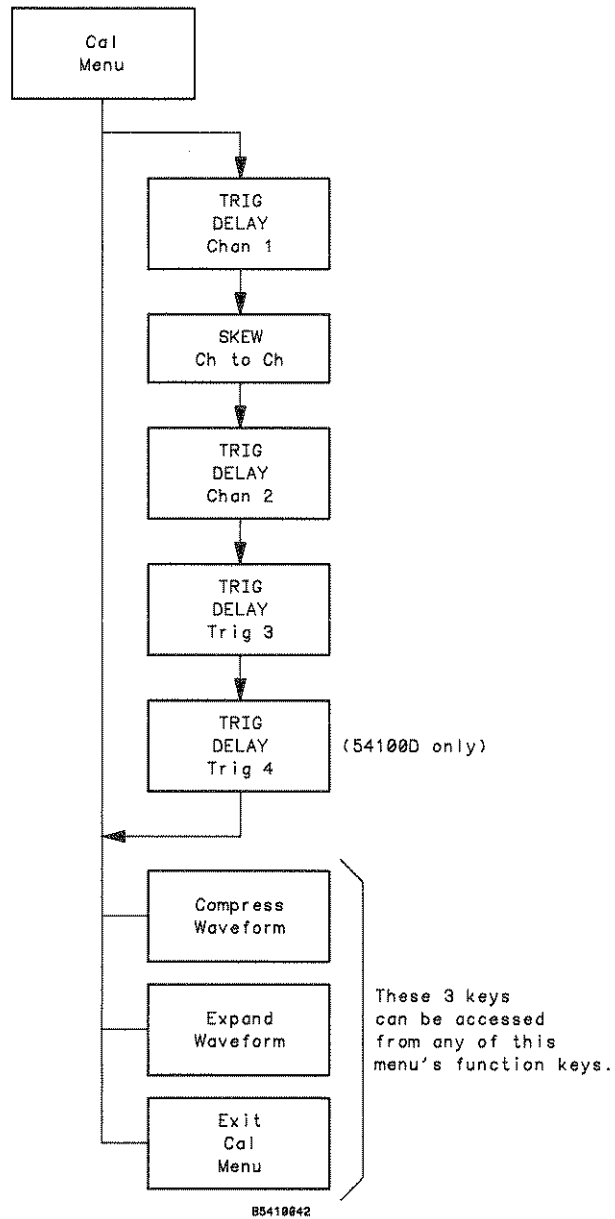

Figure 6-15. Cal Menu

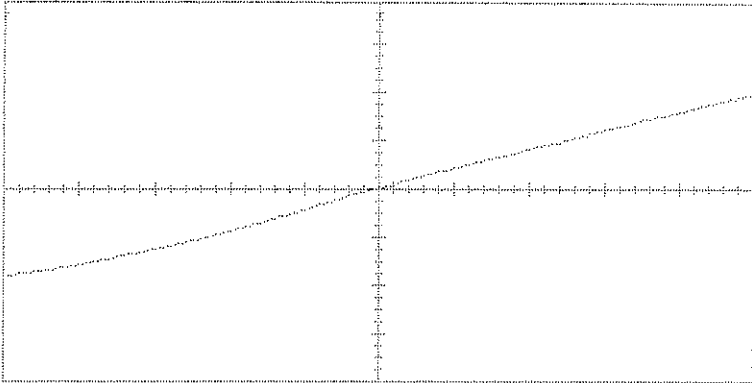

Figure 6-16. Trigger Delay

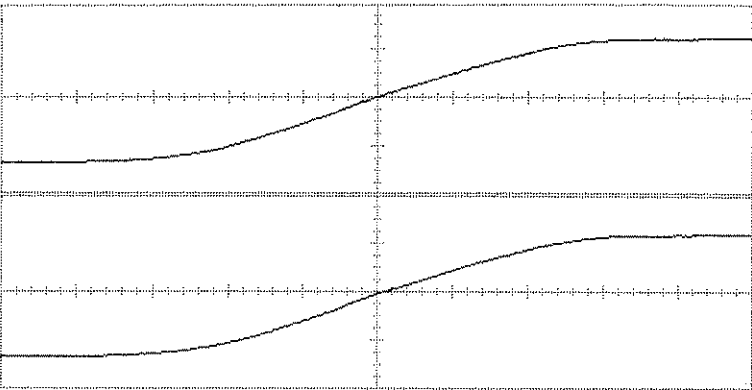

Figure 6-17. Chan to Chan Skew

6-21. HP-IB MENU

When you want to connect the 54100A/D to other HP-IB devices you would select the HP-IB menu. This menu allows you to establish the 54100A/D as a HP-IB talker, listener, or do both.

The EOI instruction can be sent at your discretion for such applications as binary dumps or when required by a controller when under program control.

When the instrument is in the Talk/Listen mode the HP-IB address can be changed by using the Entry devices. Refer to the programming section of this manual for a complete discussion of the HP-IB capabilities of the 54100A/D.

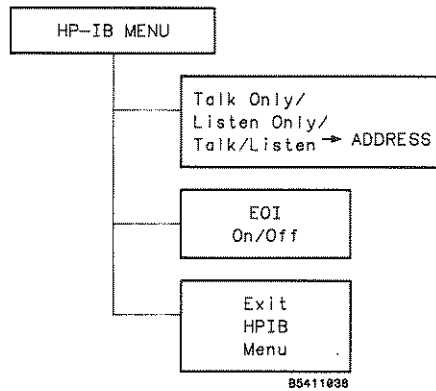
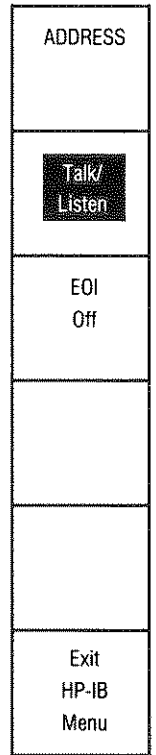

Figure 6-18. HP-IB Menu

SECTION 7

FRONT PANEL EXERCISES

7-1. INTRODUCTION

This section provides exercises that will help you to become more familiar with local (front panel) operation. Section 6 includes a preliminary discussion on front panel operation and should be read before continuing with Section 7.

7-2. INPUTTING A SIGNAL

The 54100A has three inputs, two are vertical signal inputs and the third is an external trigger input. The 54100D has an additional input used as a second external trigger input. The fourth input on the 54100D will be discussed separately later in the section.

For the instrument to accept signals, input pods must be installed. Refer to section 3 for pod specifications. The characteristics of all inputs are dependent on the pod chosen. The appropriate input pod should be chosen after characterizing the source impedance, speed/bandwidth and magnitude of the signal to be measured.

7-3. FRONT PANEL REVIEW

Refer to figure 7-1 for a review of the front panel layout. The keys at the bottom of the CRT are referred to as the menu select keys. When one of these keys is pressed, the appropriate function menu will appear on the right side of the CRT.

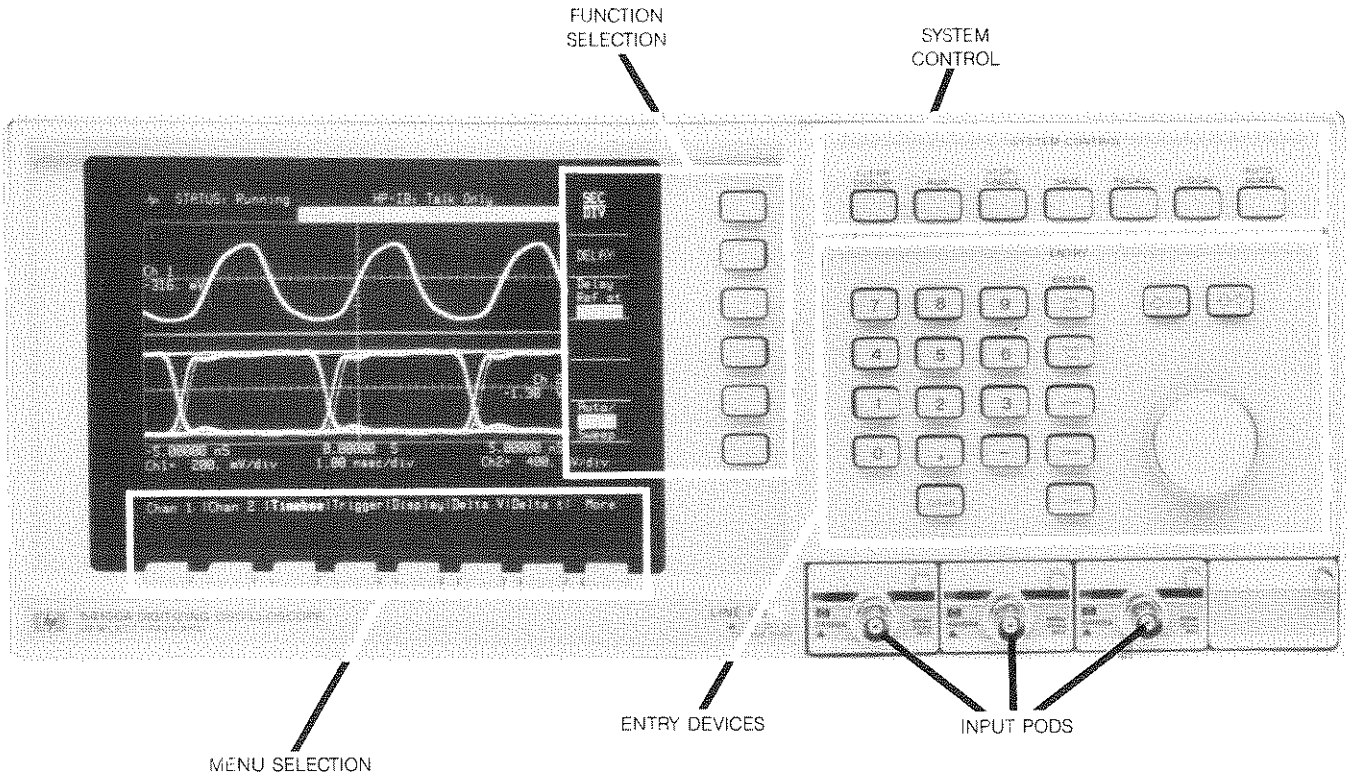

Figure 7-1. HP 54100A/D Front Panel

Additional control of the unit is available through the use of the SYSTEM CONTROL keys which are located at the top of the right side of the front panel. These SYSTEM CONTROL keys give you immediate access to those functions which are appropriate in any menu.

The ENTRY devices are used to input values for variables. The input devices on this instrument include the key pad, step keys and the knob. If you need further information concerning the front panel refer to Section 6.

7-4. MAKE A VOLTAGE MEASUREMENT

This oscilloscope gives you the capability of making either a manual or automatic voltage measurement. In this discussion the instrument's cal signal is used as the signal source. To make a voltage measurement manually you may use this procedure.

1. Connect the cal signal to channel 1.
2. Press AUTO SCALE
3. Select the Display menu.
4. Insure the Display Mode is Averaged.
5. Press the Delta V menu key
6. Key the V markers on.
7. Position MARKER 1 at the base of the cal signal.
8. Position MARKER 2 at the top of the cal signal.

The difference between the voltage levels of the two Vmarkers will be shown in the factors area at the bottom of the CRT labeled ΔV . In this example the cal signal measured 444 mV p-p. The positive delta voltage indicates that MARKER 2 was more positive than MARKER 1. If the markers were reversed ΔV would indicate a negative voltage (see figure 7-2).

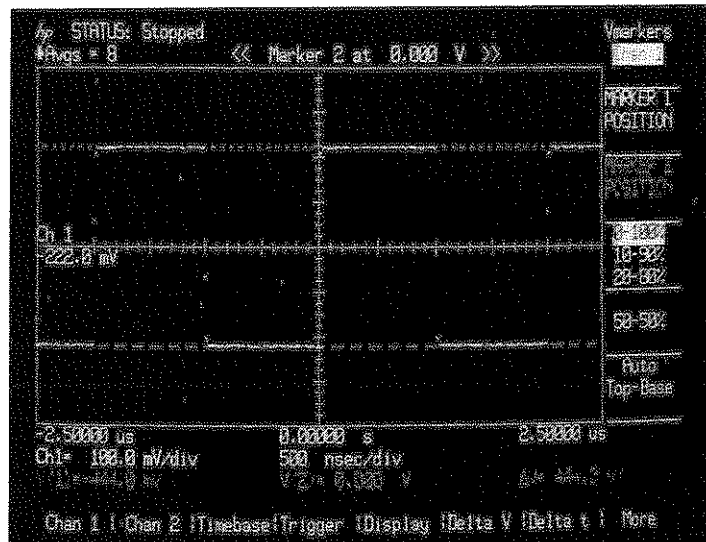

Figure 7-2. Manual Vmarker Measurement

Another method of making this measurement would be to use the Auto Top-Base function on the Delta V menu. The instrument will make an automatic voltage measurement by evaluating a histogram of the data points that are displayed on the CRT (see figure 7-3). When the Auto Top-Base key is pressed, MARKER 2 moves to the top of the Cal signal and MARKER 1 moves to the base. ΔV will indicate approximately 444 mV; this indicates that MARKER 2 is 444 mV more positive than MARKER 1 (see figure 7-4). The results of the manual and the automated measurements in this case turned out to be identical. This is not always the case. The manual measurement is accomplished by using visual resolution and the automated results are acquired mathematically. Cal signals vary slightly from unit to unit; therefore, results may vary accordingly.

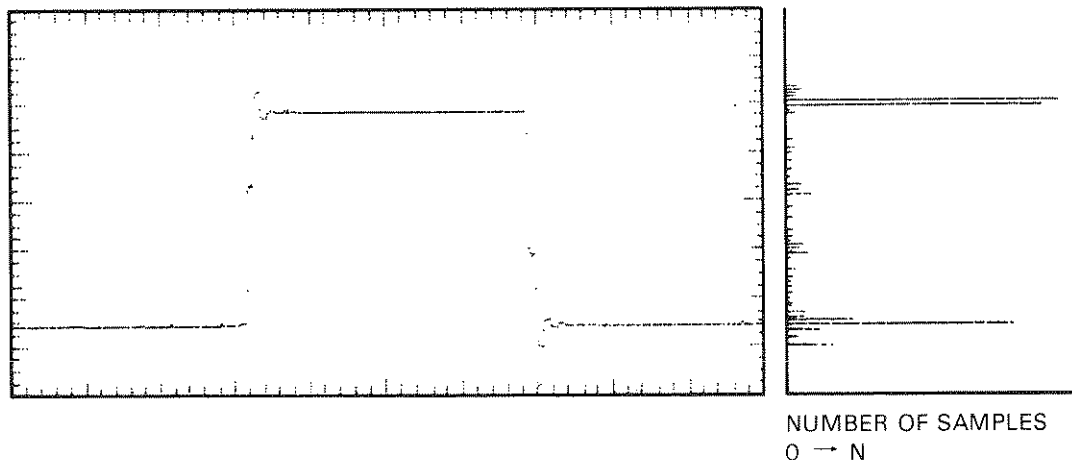

Figure 7-3. The Histogram of a Waveform.

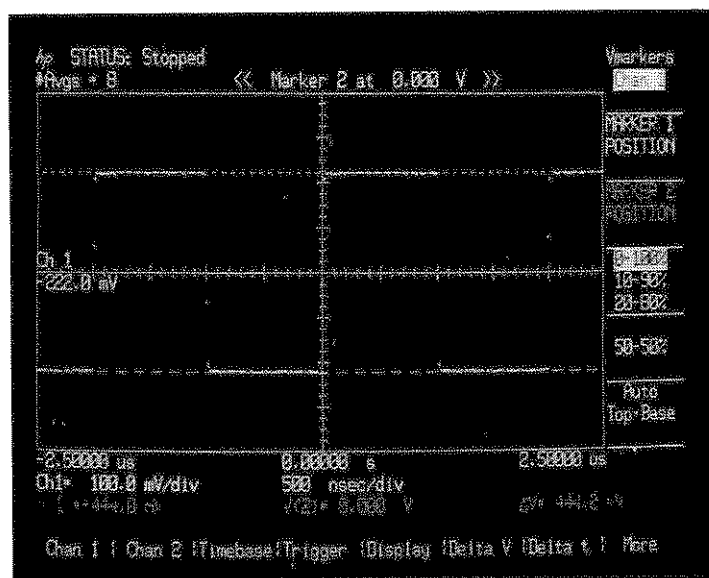

Figure 7-4. Auto Top-Base Voltage Measurement.

Another way to make voltage measurements would be to use the automated capability by using the the Peak-to-Peak Voltage function. When the Peak-to-Peak Voltage key is pressed, the unit determines the minimum and maximum voltage on the CRT, calculates the difference, and provides the answer in the factors area.

1. Press the More menu key (bottom of the CRT).
2. Select the Measure menu.
3. Press the More key (side of CRT) until the Peak-to-Peak label appears.
4. Press the Peak-to-Peak Voltage key.

Note the results in the factors are (P-P Volts). With the example unit the value was 446 mV. This is a slightly greater absolute value than we acquired when we used Auto Top-Base. This would be expected as the peak-to-peak voltage is the difference between the minimum and maximum voltages on the display and the Auto Top-Base measurement is derived from a histogram of the same data (see figure 7-5).

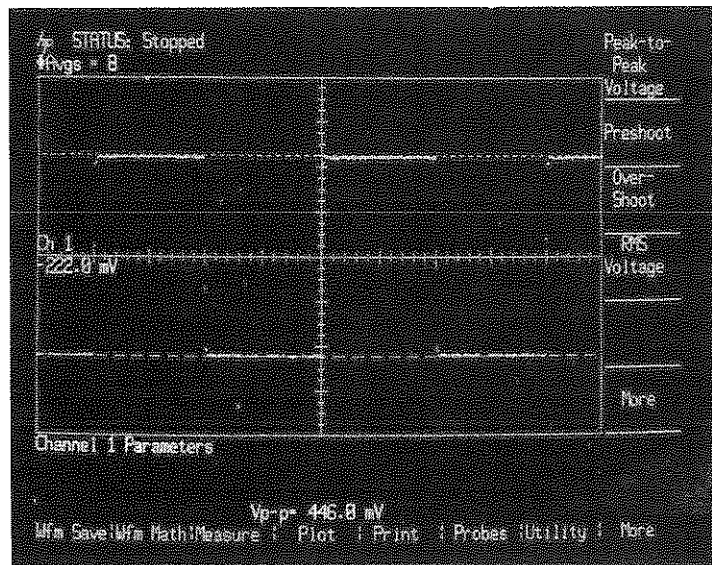

Figure 7-5. Peak-to-Peak Voltage

An important capability of the Vmarkers is that the Vmarkers can be assigned to chan 1 and chan 2 independently, i.e., marker 1 to chan 1 and marker 2 to chan 2. The next exercise will help clarify how this feature works:

1. Connect the cal signal to channel 1 & 2.
2. Press AUTO-SCALE.
3. Select the Delta V menu.
4. Turn the Vmarkers on.
5. Press the top key on the function menu twice. (Vmarkers Dual)
6. Position MARKER 1 and MARKER 2 randomly.

As the markers are moved you notice that MARKER 1 is associated with chan 1 and MARKER 2 is associated with chan 2. The DC voltage level of each marker as well as the difference between them (ΔV) is listed in the factors area. This feature allows comparisons to be made between signals on chan 1 and chan 2. To demonstrate this:

1. Position MARKER 1 level with the top of the cal signal on chan 1.
2. Position MARKER 2 level with the base of the cal signal on chan 2.

NOTE

ΔV in the factors area lists the voltage difference between the two markers (see figure 7-6).

3. Select the Chan 1 menu.
4. Press the OFFSET function.
5. Move Chan 1 display using the entry devices.

As the chan 1 signal is positioned on the display, note that the Vmarker maintains its relative location with respect to the signal on the channel.

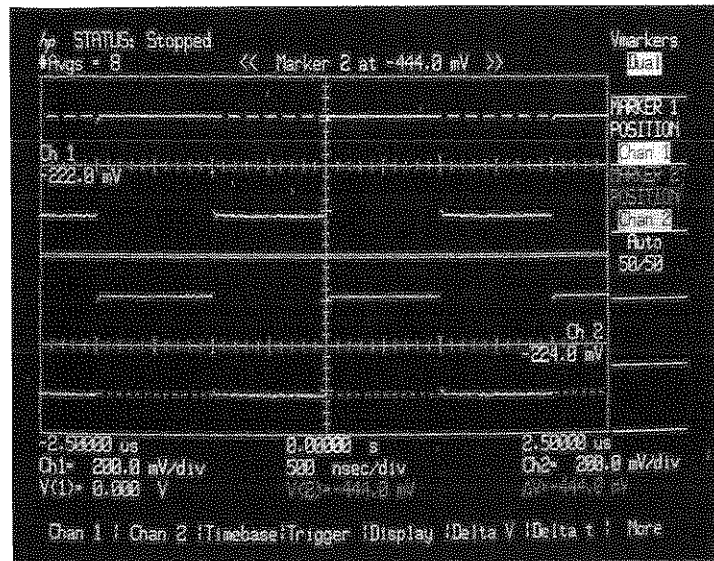

Figure 7-6. Delta V markers on Split Screen.

7-5. TIME DOMAIN MEASUREMENTS

This section provides a discussion and exercises that demonstrate some of the time domain measurement capabilities of the 54100A/D.

The time domain is referenced to the 10 division CRT display with a resolution of 100 ps to 1 sec/div on the horizontal axis. The two time markers can be used as horizontal references to show where an automatic measurement is being made, or to relocate signals on the horizontal axis using the DELAY function; or they can be manually located on the display for timing measurements. To demonstrate the manual time interval measurement capability, complete the following exercise:

1. Connect the cal signal to channel 1.
2. Press AUTO-SCALE.
3. Select the Delta t menu.
4. Key the Tmarkers on.

NOTE

*Both Tmarkers will be located at the "0.00000S" Delay Ref. (trigger event).
Auto-Scale sets the Delay Ref. at center screen.*

5. Move the START MARKER to the leading edge of the first pulse.
6. Move the STOP MARKER to the trailing edge of the first pulse.

The time intervals between each marker and the trigger point as well as the time interval between START MARKER and STOP MARKER to the trailing edge of the first (Δt) are listed in the factors area (see figure 7-7).

In this example the START MARKER is -2.00 us (before trigger) and the STOP MARKER is -1.00 us (before trigger) and Δt is 1 us.

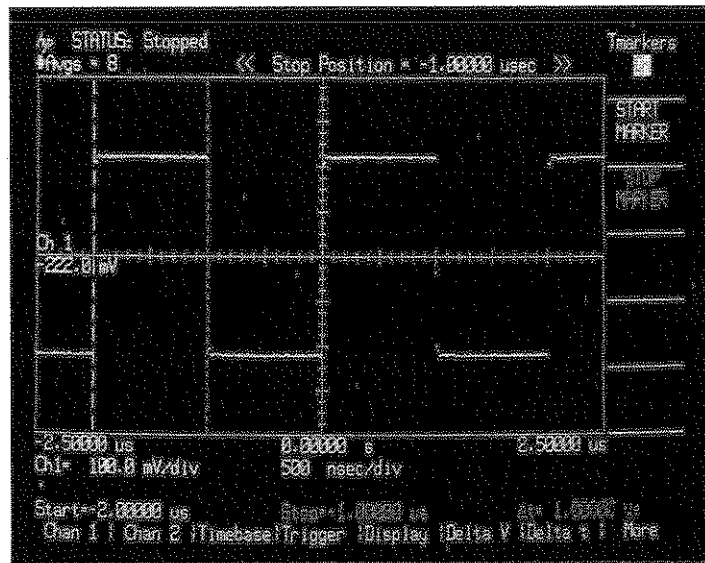

Figure 7-7. Manual Time Interval Measurement

Another method that can be used to make a time interval measurement is to take advantage of the automatic edge finding capability, which requires setting a reference with the Vmarkers for defining edges:

1. Select the Delta V menu.
2. Key Vmarkers on.
3. Press Auto Top-Base.
4. Press 50-50%.

NOTE

Step 4 places the Vmarkers at the 50% level of the cal signal and provides references for the delta t measurements we are about to make, i.e., the unit senses the transition of the cal signal through the Vmarkers.

5. Select the Delta t menu.

NOTE

The Delta t menu has 3 additional functions; START ON EDGE, STOP ON EDGE and Precise Edge Find. These functions require the use of the Vmarkers and are only displayed when Vmarkers are on.

6. Set START ON EDGE to Pos 1.
7. Set STOP ON EDGE to Neg 1.

NOTE

When you select START ON EDGE or STOP ON EDGE as in steps 6 and 7, the first key stroke selects the function and the second changes the polarity of the edge.

The unit will automatically locate the transition level (50-50%) on the first positive and negative edges and measure the time interval between the two and define the +pulse width. Check the factors area of the CRT for the results (Δt)(see figure 7-8).

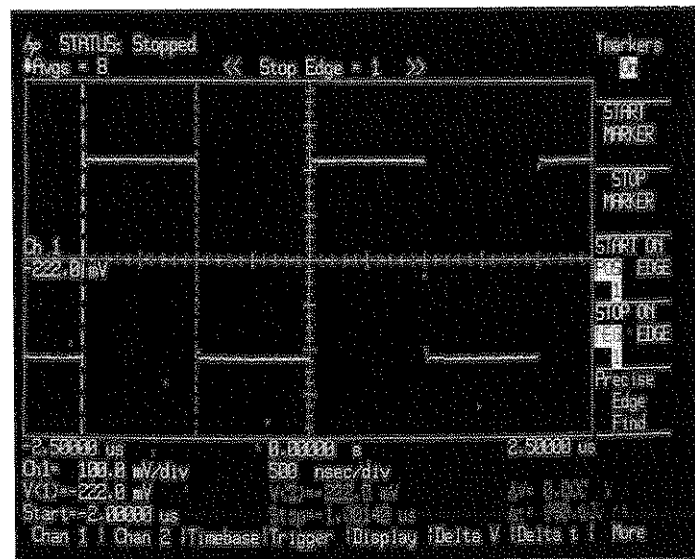

Figure 7-8. Edge Find

When the START and STOP ON EDGE functions are used, the displayed waveform is used as the data base for developing the time interval measurements. This limits the resolution to 1/50th of a division.

Now press Precise Edge Find. This causes the unit to rescale the horizontal axis to a faster sweep speed while it locates the Tmarkers on the edge(s) of interest.

Because of the additional scaling, Precision Edge Find requires a longer period of time to acquire a result than does the START and STOP ON EDGE functions; this should be considered if throughput is a concern.

Precise Edge Find uses averaging, which also makes it take longer. The number of averages selected in the Display menu will be acquired each time the timebase is rescaled to locate the edges. For greater precision, the NUMBER OF AVERAGES can be increased; for a faster result, the NUMBER OF AVERAGES can be reduced. Extremely low repetition rate signals will also slow down the precise edge finders.

To terminate the measurement routine at any time, just press any other front panel key.

Another method of measuring the +pulse width would be to use the automated capabilities available on the Measure menus.

1. Connect the cal signal to chan 1.
2. Press AUTO-SCALE.
3. Press More menu key (bottom of CRT).
4. Select Measure menu.
5. Select Fine Precision.
6. Press More (on the side of the CRT).
7. Press +Width.

The +Width value will be listed in the factors (see figure 7-9).

When any of the automated measurements in the measure menus require a time interval measurement, you have the choice making "Coarse" or "Fine" precision measurement. When a coarse measurement is executed the instrument makes the measurement on previously acquired data. In most cases fine precision measurements, when executed, acquire new data and rescale the timebase for increased resolution.

NOTE

All fine precision measurements require an active signal input.

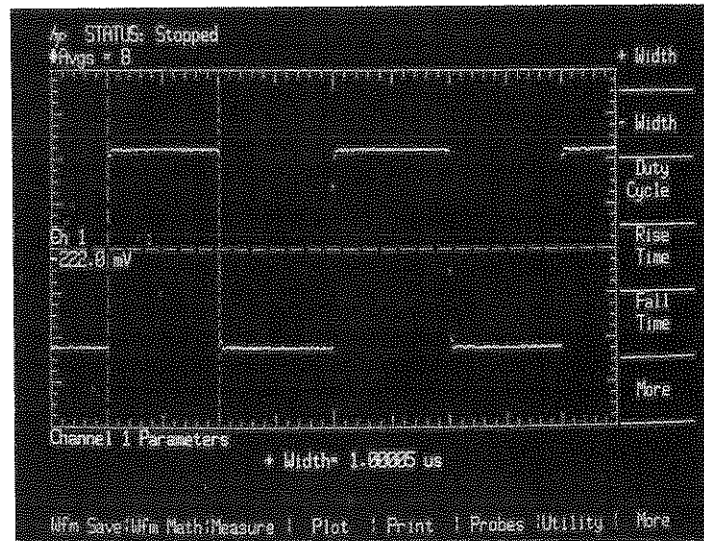

Figure 7-9. +Pulse Width

If measurement speed is a prime concern, you may make automated time interval measurements using coarse precision by setting the Precision key in the Measure menu to Coarse.

For demonstration purposes repeat the + width measurement with precision set to coarse. Notice the difference in time required for a coarse precision measurement vs. a fine precision measurement.

7-6. DELAY

The DELAY function provides horizontal windowing capability as well as calibrated pre and post triggering delays. Negative delay represents time before the trigger event and positive delay represents time after the trigger event. Try the following procedure to familiarize yourself with the DELAY function.

1. Connect the cal signal to channel 1.
2. Press AUTO-SCALE.
3. Select the DELAY function (on the side of the CRT).

NOTE

In this exercise the Delay is referenced to center screen; the left or right side of the graticule could just as easily have been used as the reference.

4. Key in 2 sec delay using the key pad and the sec ENTER key. An error message will display "Value out of range.....Set to limit". The maximum + delay on this sweep speed (500 ns/div) is 1.6 sec.
5. Key in -1 second delay. Again the unit displays the error message and sets the delay to the limit. Maximum - delay on this sweep speed is 200ms.

NOTE

Maximum \pm delays vary depending on sweep speeds and delay reference, e.g., on 1 sec/div sweep speed, maximum positive delay is 6×10^5 seconds, maximum negative delay is -10 seconds.

6. Press AUTO-SCALE.
7. Select DELAY.
8. Vary Delay by rotating the knob. CW rotation moves the signal to the left and provides negative delay and CCW rotation moves the signal to the right and provides positive delay.

The DELAY function allows viewing of the signal before and after the trigger event. In this last example, 1.6 seconds delay and 500 ns/div sweep speed were used. A small amount of time jitter would be obvious when viewing the delayed signal under these conditions, e.g., 1 cm of jitter represents approximately 3.2 ppm. To demonstrate the effect of time jitter, complete the following exercise:

1. Connect the cal signal to channel 1
2. Press AUTO-SCALE.
3. Select the DELAY function.
4. Enter 1.6 sec. Delay using the key pad.
5. Select the display menu.
6. First view the signal in the normal mode with infinite persistence then switch the unit to the averaged mode (top key on the function menu).
7. Set Averages = 8 by using the entry devices.

NOTE

After the unit has been allowed to acquire data for a short period, the rising and falling edges of the pulse appear to slope (see figure 7-10); this is a function of the time jitter on the signal and the fact that the unit is in the averaged mode. In this example where time jitter is present and a relatively long delay is used, the averaged mode does not faithfully reproduce the input signal.

8. Change the display mode to normal.
9. Set the DISPLAY TIME to Infinite using the entry devices. Notice that after several acquisitions, the leading and lagging edges are undefined (see figure 7-11). This is caused by time jitter on the input signal. Unless a signal source is extremely stable it is common to see time jitter of this magnitude when long delays are used. The sample unit that was used demonstrated approximately 500 ns time jitter with 1.6 sec delay. This technique is a perfectly valid measurement of the jitter in the source signal, which you might typically want to measure. This type of jitter measurement is made possible by the extremely stable crystal referenced timebase. See Section 3 for timebase jitter specifications.

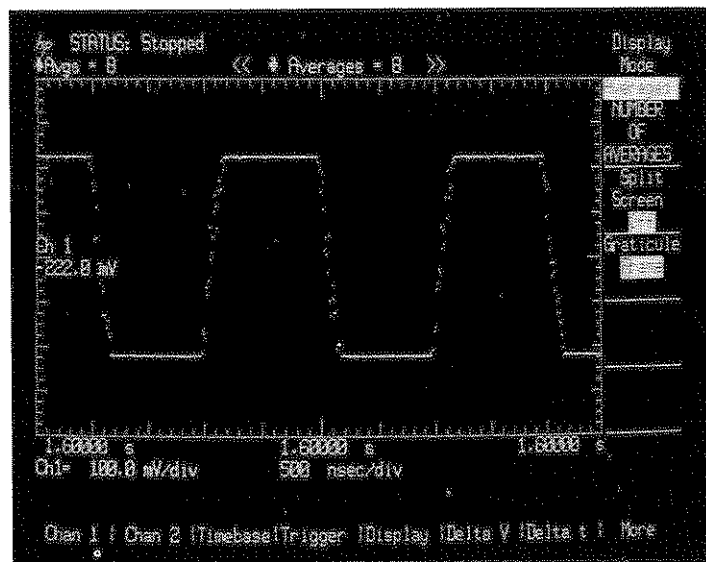

Figure 7-10. Time Jitter in the Averaged Mode

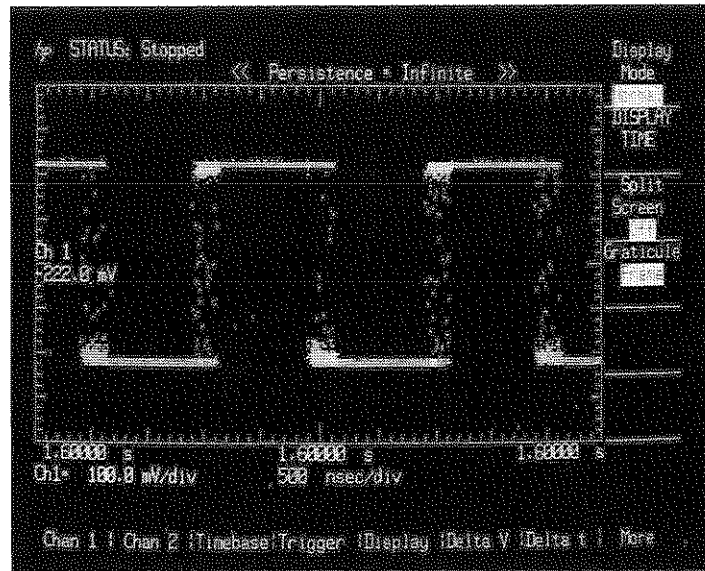

Figure 7-11. Time Jitter in the Normal Mode

Figure 7-12 compares the results obtained with the normal mode and the averaged mode when using a long delay with time jitter present.

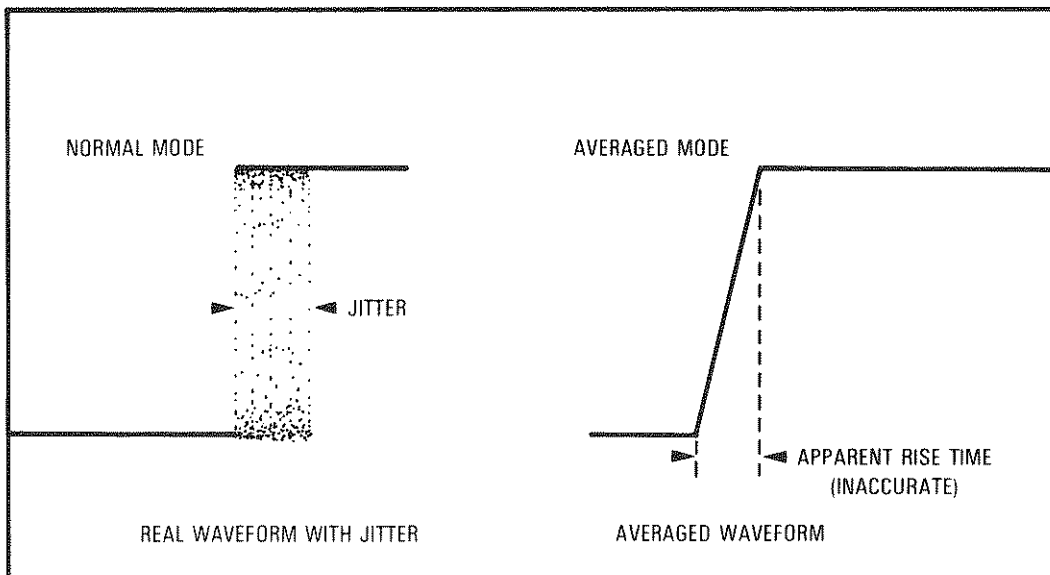

Figure 7-12. Time Jitter with Normal/Averaged Mode.

The 54100D provides two additional techniques of delaying the display window by delaying the actual trigger; Event Delay and Time Delay. These two functions are part of the trigger menu and can be selected by pressing the trigger menu key. They are different from the Timebase delay in that they provide a trigger for the display after the Event/Time delay. This eliminates the time jitter that is seen when the timebase delay is used. Let's first look at event delay.

1. Connect the cal signal to channel 1.
2. Press AUTO-SCALE.
3. Change from Auto to Trg'd sweep.

NOTE

When AUTO-SCALE is pressed, the unit establishes itself in the auto sweep mode. If the trigger is delayed longer than approximately 50 ms, the auto sweep mode will cause the unit to sweep before the delay period has elapsed. The signal will appear untriggered (see figure 7-13). To eliminate this problem put the unit in the Trg'd mode.

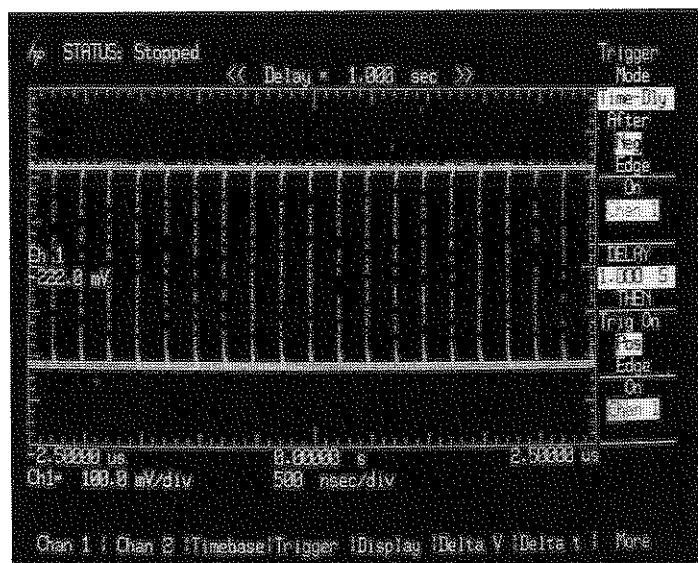

Figure 7-13. Auto Sweep Mode with Delay > 50 ms.

4. Select the Trigger menu.
5. Set the trigger mode to Event-Dly.
6. Using the function keys and entry devices, set the Event-Dly menu to read: "After Neg Edge On Chan 1, TRIG on 1,000,000 events Of Pos Edge on chan 1".
7. Press CLEAR DISPLAY.

NOTE

After a qualifying negative edge on chan 1, the unit will delay the defined number of pulses and then trigger on the last pulse. In this example the 1,000,000th pulse will be presented at center screen (if the delay is referenced to center screen). This mode would be used if it is necessary to look at a specific pulse in a train but the signal is not stable enough to use timebase delay.

The next method of delaying the display window would be Time Dly. To demonstrate time delay, perform the next exercise:

1. Connect the cal signal to channel 1.
2. Press AUTO-SCALE.
3. Select Trg'd sweep.
4. Select the Trigger menu.
5. Select the Time Dly trigger mode.
6. Using the function keys and entry devices, set the Time-Dly menu to read: "After Neg Edge on Chan 1 DELAY 1.000 S THEN Trig On Pos Edge On Chan 1".
7. Press the CLEAR DISPLAY key. In this mode the unit waits a defined period of time after a qualifying event, in this example 1 second, and then triggers on the edge selected.
8. Change the WAIT time to 0.5 sec. Notice that the acquisition rate is influenced by WAIT time because the effective trigger repetition rate is limited by WAIT time.

The Time-Delay mode would be used to view a signal that occurs a relatively long time after a sync signal. This would eliminate the time jitter (induced by the input signal) that would be present if the timebase delay were used. Event-Delay accomplishes essentially the same thing as Time-Delay except that events are used to delay the display window. The effect is similar when using either mode, i.e., the affect of time jitter in the source signal is eliminated.

The timebase delay on the 54100A/D is always referenced to the trigger edge that is generated in a particular trigger mode. Trigger delay, both event and time, should not be confused with the timebase delay as they are independent functions. Event-Delay and Time-Delay modes are a means of selecting which edge on the signal is used as a reference for timebase delay.

7-7. TRIGGER

In this section some of the triggering capabilities of the 54100A/D will be discussed.

The edge mode is similar to the trigger on a conventional oscilloscope. The trigger level can be defined, the polarity of the trigger can be selected and the source of the trigger can be determined. This 54100A has one external trigger input and the 54100D has two. This provides you with three and four trigger sources respectively.

In the pattern mode this instrument provides 4-channel pattern recognition capability. Try this exercise to demonstrate some of the triggering capabilities of the edge mode:

1. Connect the cal signal to channel 1 & 2.
2. Press AUTO-SCALE. The unit will establish itself in the split screen mode with chan 1 at the top and chan 2 at the bottom of the display. Chan 1 will be defined as the trigger source.
3. Select the trigger menu.
4. Select TRIG LEVEL. The trigger level will be indicated by a horizontal line through the chan 1 signal (see figure 7-14).
5. Change the trigger level by rotating the knob.

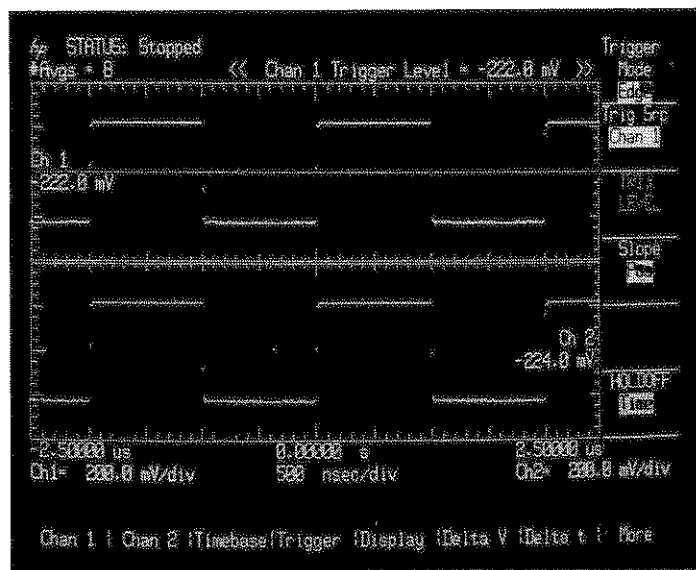

Figure 7-14. Split Screen with Trigger on Chan 1

NOTE

If the trigger level trace is moved above or below the chan 1 signal, the signals on chan 1&2 will loose sync. The step keys and the key pad may also be used to change the trigger level.

6. Select chan 2 as the Trig Src. The unit is now triggering on chan 2. The line showing the trigger level will be on the chan 2 display. The trigger level on chan 2 can be varied by using the input devices (see figure 7-15). The trigger level function is shown at the top of the waveform area and at the bottom of the display in the factors area.
7. Select Trig 3 as the trig src. Notice that the signals are untriggered.
8. Move the chan 1 input to trig 3 (trigger 3 input). Vary trig level 3 until the signal on chan 2 triggers. (Anywhere from 0 V to -.4 V should do it). Trig 3 is now being used as a trigger for the signal on chan 2. You could have used trig 4 as a trigger source in this example. (Trig 4 is provided on the 54100D only).

NOTE

If any of the previously used inputs are selected as the trigger source, the trigger level remains where previously set for that source.

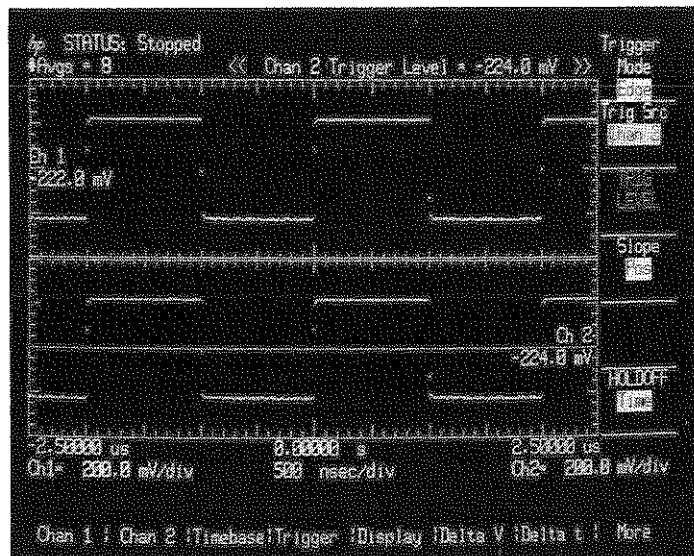

Figure 7-15. Split Screen with Trigger on Chan 2

7-8. PATTERN MODE

The other trigger mode common to the 54100A/D is the Pattern Mode. In this mode each input is converted to a digital signal which is high, or true, when the input signal is above its trigger threshold and is low, or false, when below its trigger threshold. The trigger can then be set to occur when a pattern of signal levels, relative to each inputs' trigger threshold, becomes true or false. The 54100A has 3 inputs and thus a 3-channel wide pattern and the 54100D has 4.

When the Pattern mode is used, insure that the trigger level for each input is adjusted so that the input signals cross each respective trigger level during transition. This is done in the edge mode.

It should be noted that each input has a separately adjustable trigger level and is independent of the other. This feature allows mixing different types of logic signals. Use this example to become more familiar with the pattern mode:

1. Connect one cal signal to channel 1 using a 1 metre BNC cable.
2. Connect the other cal signal to channel 2 using 3 metres of BNC cable. 2 metres will work as well but will not give as much signal delay on channel 2.
3. Press AUTO-SCALE
4. Set the sweep speed to 5 ns/div.
5. Select the display menu and set split screen off.
6. Select the trigger menu.
7. Select the edge trigger mode.
8. Select chan 2 as the trigger source.
9. Adjust TRIG LEVEL for a triggered signal on the display.

NOTE

In figures 7-16 and 7-17, the signal path for chan 2 is approximately 2 meters longer than that of the signal path for chan 1. This provides the time differential between the two signals.

10. Set trigger mode to pattern. Set Trig On PATTERN to read: "HHXX" (54100D). "HHX" for the 54100A.

H = High State (above trigger threshold)

L = Low State (below trigger threshold)

X = Don't Care

11. On the trigger menu insure "When Entered" is set. With the instrument in this configuration it will generate a trigger on the last edge that makes the pattern HHXX (HHX) true. In this example the positive edge on chan 2 is the trigger.

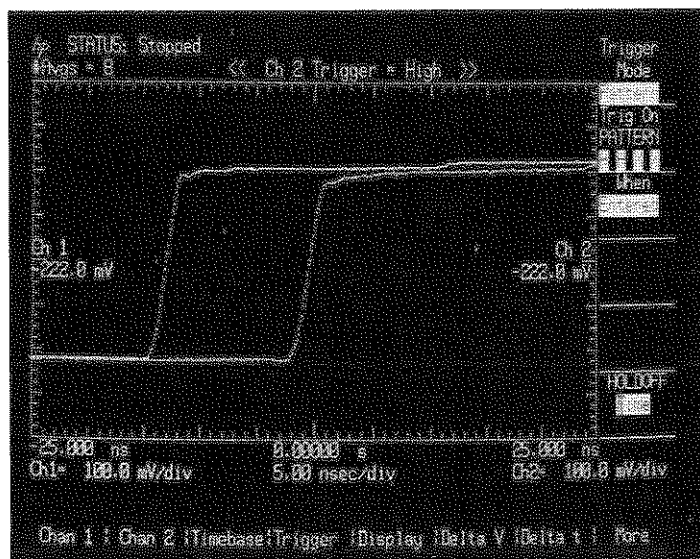

Figure 7-16. Pattern When Entered "HHXX"/"HHX"

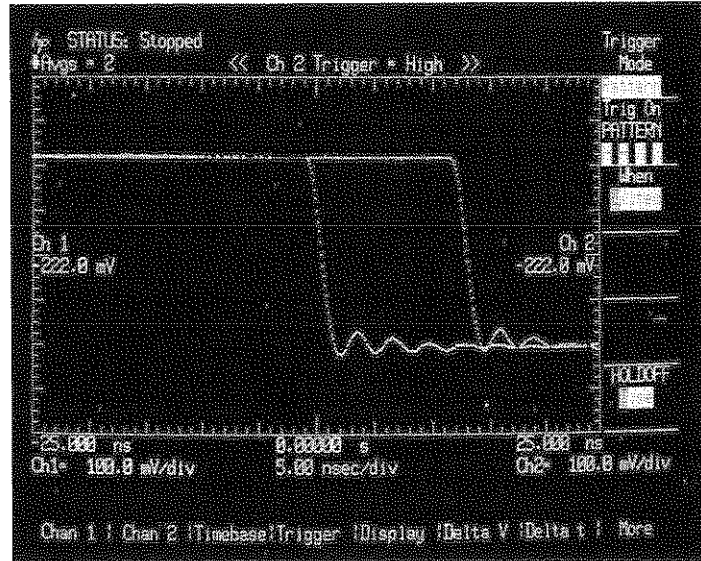

Figure 7-17. Pattern When Exited

This menu allows triggering when entering or exiting a defined logic pattern. If the When Entered function is selected, the unit will trigger on the last pulse edge that makes the pattern true (see figure 7-16). If the When Exited function is selected, the unit will trigger on the first pulse edge that makes the pattern false (see figure 7-17).

This trigger mode would be an advantage while troubleshooting logic circuitry, or any other application where it would be desirable to make parametric measurements while using logic sources for a trigger. In addition to the When Entered/Exited functions, the 54100D provides time qualification for the Pattern mode: When Present> and When Present<. The When Present> mode allows the user to specify that the trigger pattern must be present for a minimum period of time (that the user defines) before being accepted as a trigger. If the pattern does not remain true long enough it will be ignored. The When Present < mode is just the opposite. Here the pattern will generate a trigger only if it remains true for less than the time specified. If the pattern is true longer than this time it will be ignored. If the time qualifier is true both of these modes will generate a trigger when the pattern is exited. The range of the time qualifier is from 10 ns to 5 sec.

For the case of the simplest pattern, HXXX (54100D), the pattern is true when chan 1 is high and it is false when chan 1 is low. The time qualification can then be used to trigger on pulses that are wider than a specified time and ignore shorter ones (When Present>) or it can be used to trigger on pulses that are shorter than the time qualifier and ignore the longer ones (When Present<). Use the this exercise to become familiar with the time qualification feature on the 54100D:

1. Connect the cal signal to channels 1&2.
2. Press AUTO-SCALE
3. Select the Trigger menu.
4. Select the Pattern Trigger mode.
5. Set the Trig On PATTERN to read HHXX.
6. Select the When Present> function

7. Set TIME to 1.5 us. This requires that the pattern be present for greater than 1.5 us to generate a trigger. In this example this will not be true as the + portion of the cal signal is approximately 1 us duration.
8. Set TIME to .5 us. The display will now trigger.

The ability of this unit to qualify the trigger pattern with a min-max time interval provides an excellent technique for glitch detection.

7-9. STATE MODE (54100D only)

The next trigger mode is the State mode. This mode allows using simple edge detection combined with pattern recognition to generate a trigger. When this mode is selected, one of the four inputs is chosen as the edge source and the user determines a 3-bit pattern defined over the remaining three inputs.

A trigger will be generated when an appropriate (\pm) edge occurs only when the pattern is true (When Present) or false (When Not Present) as specified by the user. The State function differs from the Pattern Entered/Exited function in that the trigger is generated from a specified edge source for State, while in the Pattern Entered/Exited mode any input can initiate a trigger if it causes the pattern to be true/false. Complete the following exercise:

1. Connect the cal signal to channels 1&2. For chan 1 use a 1 metre cable; for chan 2 use 2 or 3 metres.
2. Press AUTO-SCALE
3. Select the trigger menu.
4. Set the trigger mode to state.
5. Set Trig On Edge to Pos.
6. Set On Chan When to Chan 1.
7. Set PATTERN to -HXX
 - = Input being used for edge source.
 X = Don't care
 H = High State (above trigger threshold)
 L = Low State (below trigger threshold)
8. Set the Present/Not Present function to Not Present. The display should be triggered.

With the instrument in this configuration it will generate a trigger on a positive edge on chan 1 if chan 2 is low. Change Not Present to Present -- the display will loose it's trigger.

7-10. DISPLAY

The display menu provides control of how data is displayed on the CRT:

1. Whether data on the display is Normal or Averaged.
2. The type of graticule that is to be used, grid, frame or axis.
3. The format of the display, split screen On/Off.

7-11. NORMAL MODE

When the Normal mode is used, high speed A to D converters digitize the incoming signal and write it to a display memory that in turn provides information to the CRT. The data points that are acquired from the A to D converters are displayed on the CRT for a user-defined period of time from 200 ms to Infinity. To become more familiar with the Normal mode functions, complete the following exercise:

1. Connect the cal signal to channel 1.
2. Press AUTO-SCALE.
3. Select the Display menu.
4. Select the Normal mode.
5. Set DISPLAY TIME to 200 ms. Data points written on the CRT will fade shortly thereafter unless they are refreshed by new input data.
6. Select the Timebase menu.
7. Change the sweep speed to 100 ps/div. This faster sweep speed allows the user to more easily see the effects of changing the DISPLAY TIME.
8. Select the display menu.
9. Change DISPLAY TIME to 1 sec. Notice the change in persistence.
10. Change DISPLAY TIME to 11 sec. The unit will now have infinite persistence (any DISPLAY TIME greater than 10 sec defaults to Infinite).

The infinite persistence mode causes all acquired data to remain on the CRT until the function is changed.

Long persistence times work well for capturing low repetition rate, relatively fast or narrow (low duty cycle) signals. Infinite persistence also allows viewing worst case jitter, noise, and timing variations; or to view extremely infrequent glitches or other anomalies.

To see the effect of persistence on a low rep rate signal connect the cal signal to chan 1 and press AUTO-SCALE, go to the timebase menu and use 500 ns/div sweep speed with 1.6 sec DELAY. Return to the display menu and vary the DISPLAY TIME from 200 ms to 11 sec notice the differences.

In the infinite persistence mode the data points will remain on the display until the CLEAR DISPLAY key is pressed or until the display is moved with an instrument control such as, sweep speed, vertical sensitivity, or trigger level. Move one of these controls while in the infinite mode and notice the results.

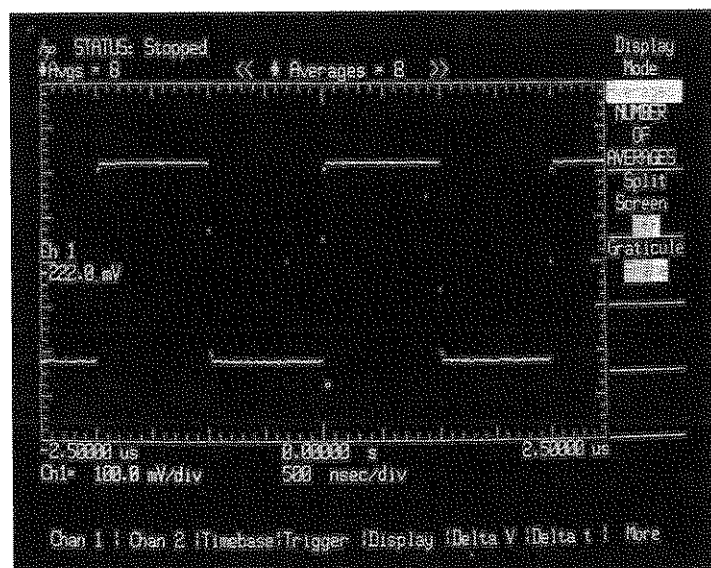

Figure 7-18. Averaged Mode (8 Averages)

7-12. AVERAGED MODE

As the input signal is digitized, each data point is assigned a time coordinate relative to the trigger. In the averaging mode the unit calculates the average of the most recent data point with the previous values in the same time bucket. You can define the number of data points that are to be averaged from 1 to 2048. Each average is calculated from data acquired for each time slot--data for adjacent time slots is not averaged together.

If 8 is chosen for the number of averages, 1/8 of the vertical value of each new data point will be added to 7/8 of the value previously in the time bucket. If 16 averages had been selected, 1/16th of the new data would be averaged with 15/16ths of the previous value.

The effect of using the average mode is to cancel out all phenomena that is not related to the trigger event, i.e., noise and nonrecurring events.

To demonstrate some of the differences between the normal mode and the averaged mode, complete the following exercise:

1. Connect the cal signal to chan 1.
2. Press AUTO-SCALE
3. Select the display menu.
4. Select the averaged mode.
5. Set NUMBER OF AVERAGES to 8. (See figure 7-18).
6. Select the normal mode (see figure 7-19). Compare figures 7-18 and 7-19 and notice the reduction of noise on the averaged display. The larger the number of averages the greater the reduction of the displayed noise and the longer it takes to respond to any change in the input signal.

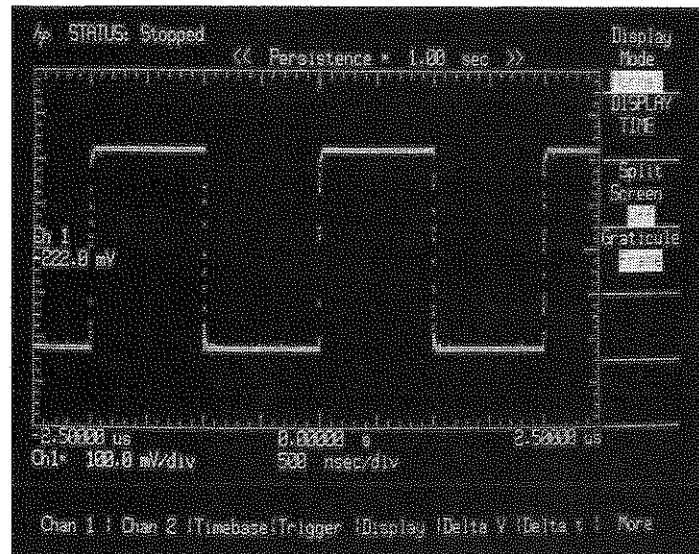

Figure 7-19. Normal Mode

The next exercise shows the effect of the averaged mode and the use of the averaged mode in conjunction with the Magnify mode.

1. Connect the cal signal to chan 1
2. Press AUTO-SCALE.
3. Select the display menu.
4. Select the normal mode.
5. Select chan 1 menu.
6. Select the magnify mode and adjust the WINDOW SIZE and POSITION so that the window is near the top of the cal signal (see figure 7-20).
7. Turn magnify on (see figure 7-21).
8. Select the display menu.
9. Set NUMBER OF AVERAGES = 2 (see figure 7-22).
10. Change NUMBER OF AVERAGES = 512 (see figure 7-23). Notice that with a greater NUMBER OF AVERAGES there will be less noise on the signal and the display will appear to be more stable.

NOTE

With only 1 or a small number of averages, the quantization levels of the A/D converter are also very evident. With a larger number of averages, the actual usable resolution increases as the display fills between quantization levels with averaged data.

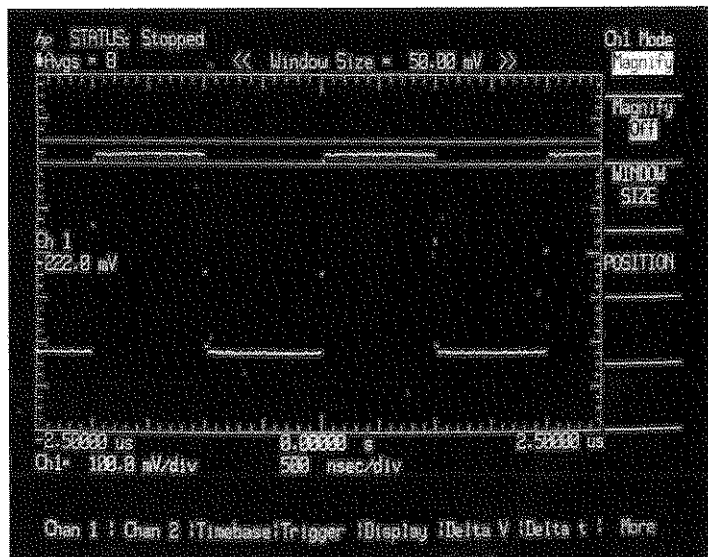

Figure 7-20. Magnify Window in the Normal Mode

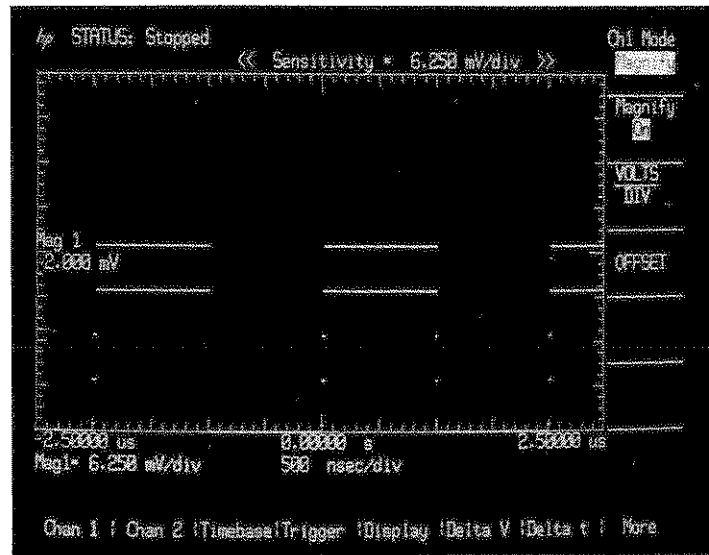

Figure 7-21. Magnify Using Normal Mode

The next exercise will help illustrate how averaging works.

1. Connect the cal signal to chan 1.
2. Press AUTO-SCALE.
3. Select the display menu.
4. Set NUMBER OF AVERAGES to 256.
5. Remove the cal signal from chan 1 and notice the reaction of the display.

As the input signal was removed, the existing values in each time bucket are now being averaged with the new data which is "0". If the number of averages were reduced, the display would converge to the new signal levels in a shorter period of time.

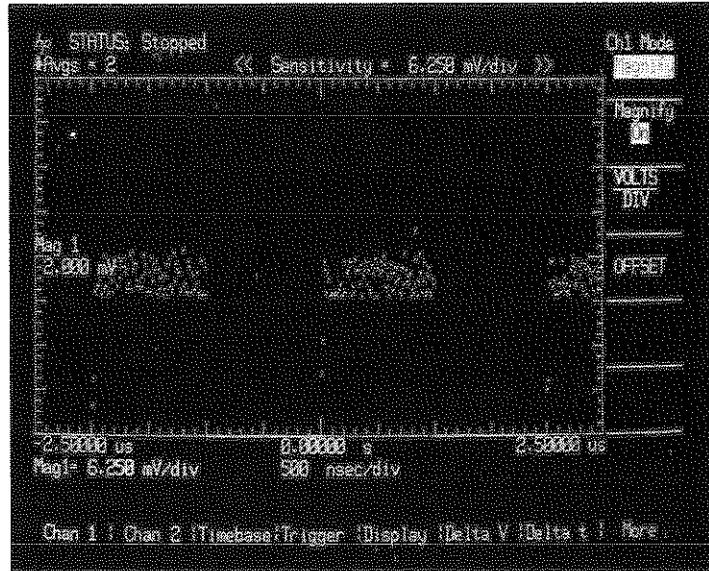

Figure 7-22. Magnify in the Averaged Mode with 2 Averages

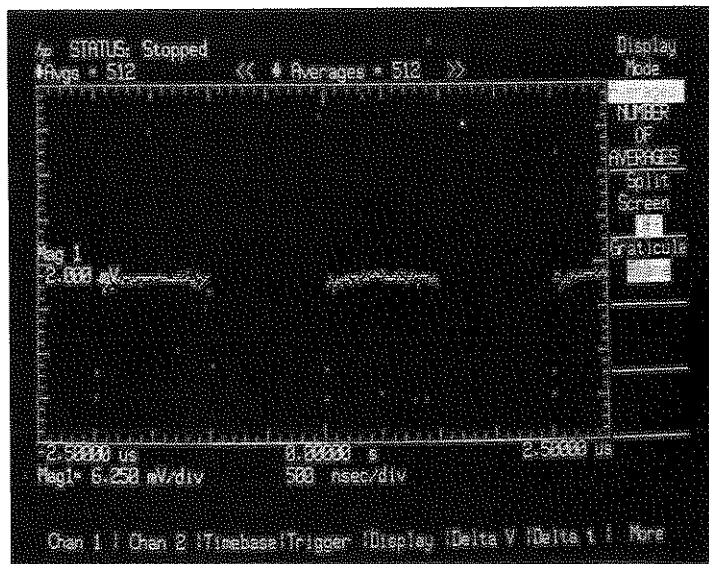

Figure 7-23. Magnify in the Averaged Mode with 512 Averages

7-13. PROBES

This instrument provides you with the capability of changing the attenuation factor on any input. When this attenuation factor is changed, the actual voltage division ratio of the inputs does not change; however, the scale factors in firmware that are used to generate the answers for the automated parametric measurements and voltage related items on the screen are modified appropriately.

The variable Atten (attenuation) factors would be used so that the display factors would accurately reflect the actual voltage levels at the source when accessory probes or voltage dividers are being used.

The Atten factors are saved with the rest of the front panel setup when the Save/Recall registers are used. When the power is cycled the Atten Factors will automatically set themselves to the value appropriate for the input pod that is installed in each input. For the 54002A and the 54003A, the Atten Factors would be set to 1:1. If the 10:1 accessory probe that is supplied with the 54003A is used, you should set the Atten Factor for that input to 10:1. This will insure that the correct answers are provided in the factors area on the screen, and that the vertical scale factors previously set (VOLTS/DIV and OFFSET) are correctly referenced to the probe tip.

When the 54001A active probe is used, the Atten Factors will automatically be set to 10:1 when the instrument power is turned on. Use the following exercise to see the effect of changing the Atten Factors:

1. Connect the cal signal to chan 1 and press AUTO-SCALE.
2. Select the Delta V menu.
3. Select the Vmarkers for Chan 1 and press Auto Top-Base. Notice the voltage readings in the factors area.
4. Select the Probes menu. The Ch1 Atten Factor will be set to 1:1 (if the 54002A or 54003A is used).
5. Set the Ch1 Atten Factor to 10:1 by using the entry devices. Notice that as the Atten Factor is changed, the voltage readings in the factors area will change to reflect the new ratio.
6. Connect the cal signal to chan 1 and trig 3.
7. Select the trigger menu.
8. Set the Trig Src to Trig 3 and the TRIG LEVEL to approximately -200 mV (the signal should be triggered).
9. Return to the probes menu and set the Trig 3 PROBE ATTEN to 10:1.

NOTE

Factors can also be used, if you have a known source, to calibrate out systematic errors in gain and attenuation ratio of the 54001A, 54003A or other divider probes. The Atten Factor could be arbitrarily set to yield the correct answer.

10. Return to the trigger menu and notice that the trig 3 level reflects the new ratio.
11. Select the Measure menu and press the All function key. Notice that all of the voltage related factors reflect the 10:1 ratio that has been chosen.

The range of the Atten Factor is from 1 to 1000. The Knob and the step keys will give you up to 3 digits of resolution and the key pad provides up to 4 digits of resolution for setting Atten Factor.

7-14. WAVEFORM MATH

This oscilloscope gives you the capability of defining the two waveform functions using the signals on channel 1 and/or 2 and/or the four waveform memories. After you have defined a waveform function and displayed it, you can make automated or manual measurements on that function following the same rules as you would use measuring a signal on a channel.

To demonstrate some of these capabilities perform the following exercises:

1. Connect a cal signal to chan 1 using a 1 metre BNC cable; connect the other cal signal to chan 2 using a 2 metre cable. The time delay between the signals that is created by the unequal cables is approximately 6.4 ns. (See figure 7-24)
2. Press the more key.
3. Select the Wfm Math menu.
4. Insure Func 1 (function 1) is the selected function (see figure 7-25).
5. Insure that Func 1 is set to Chan 1 - Chan 2 with Func 1 keyed on.

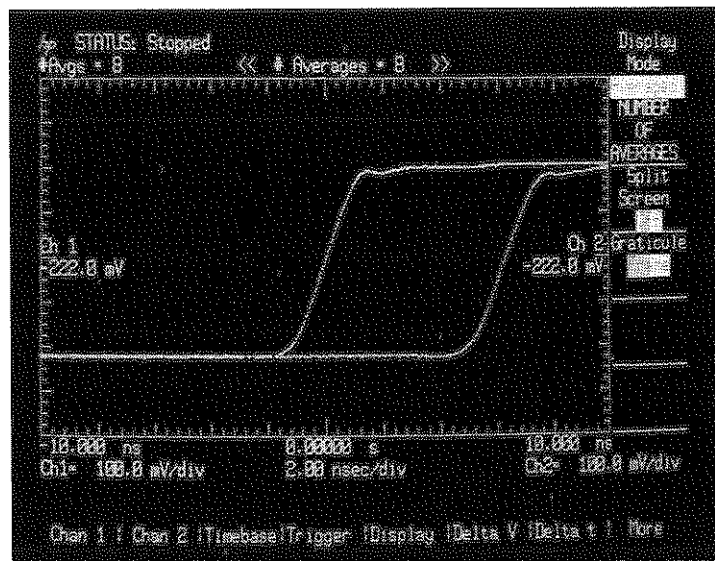

Figure 7-24. Time delay Chan 1 to Chan 2.

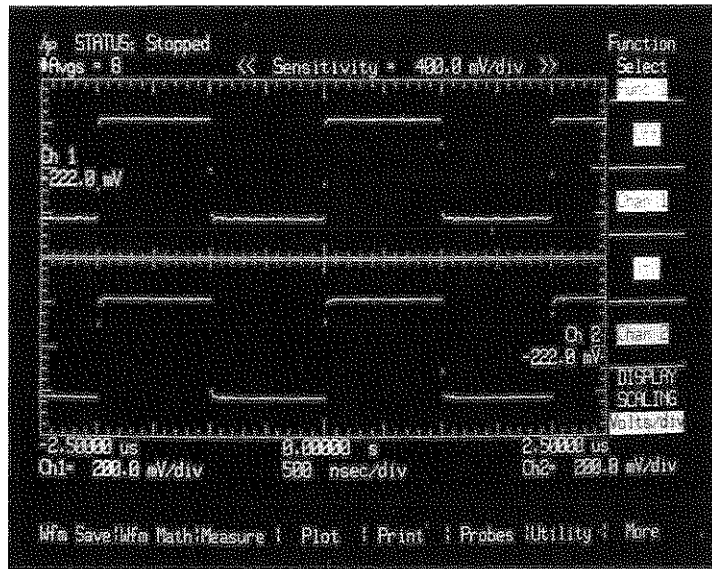

Figure 7-25. Selecting Func 1.

NOTE

Func 1 should be displayed in the top half of the split screen. At this sweep speed Func 1 appears as a narrow voltage spike occurring at the same time as the leading and trailing edges of the cal signal (see figure 7-26). The difference between chan 1 and chan 2 is created by the fact that the signal arrives at the chan 2 input after the signal arrives at chan 1. Remove the input from chan 2 and notice the effect on Func 1. To continue with this exercise reconnect chan 2 to the cal signal.

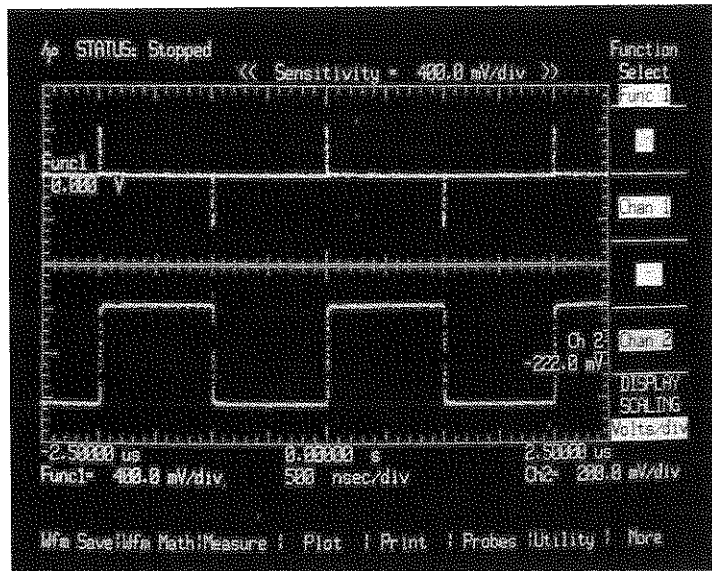

Figure 7-26. Func 1.

6. Set the function select to Func 2.
7. Define func 2 as chan 1 + chan 2 and key Func 2 on
8. Press the more key and select the timebase menu.
9. Set the sweep speed to 5 ns/div.

NOTE

The display should resemble figure 7-27 with func 1 (chan 1 - chan 2) at the top of the display and func 2 (chan 1 + chan 2) at the bottom. If you have stored a waveform in a waveform memory, mem 1-4 could have been used as an operand as well as chan 1 or 2.

This instrument also has the capability of making automated measurements on func 1 & 2. This next exercise demonstrates making automated measurements on these functions. Leave the instrument configured the same as it was for the previous exercise, that is, cal signals connected to chan 1 and 2 with 1 metre cable on chan 1 and a 2 metre cable on chan 2. Func 1 = chan 1 - chan 2 and func 2 = chan 1 + chan 2. The display should resemble 7-27. Do not change any of the instrument settings until you start the next exercise.

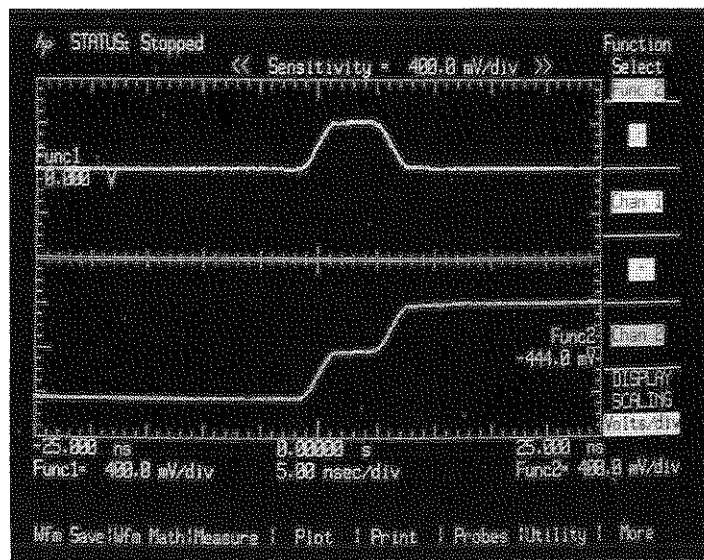

Figure 7-27. Waveform Math Func 1 & 2.

This exercise shows you how to make some of the automated measurements on func 1 & 2.

1. Select the timebase menu and set the sweep speed to 500 ns/div.
2. Press the more key and select the measure function menu.
3. Insure that func 1 is the selected measure source. (top key)
4. Press the more key on the function menu twice, this will place the Peak-to-Peak voltage key at the top of the function menu.
5. Press the peak-to-peak key and notice Vmarkers appear on the func 1 trace. Press this key repeatedly. (see figure 7-28)

NOTE

As you continue to press the peak-to-peak voltage key, notice that the Vmarkers change levels. This is caused by the fact that the voltage measurement is being made on the last acquired data and because of the narrowness of func 1 with respect to the display window. Because of this the sampled data may or may not occur at the actual peak value of the waveform. To increase the accuracy and repeatability you can increase the sweep speed.

6. Press the more key (bottom of CRT).
7. Select the timebase menu and set the sweep speed to 5 ns/div.

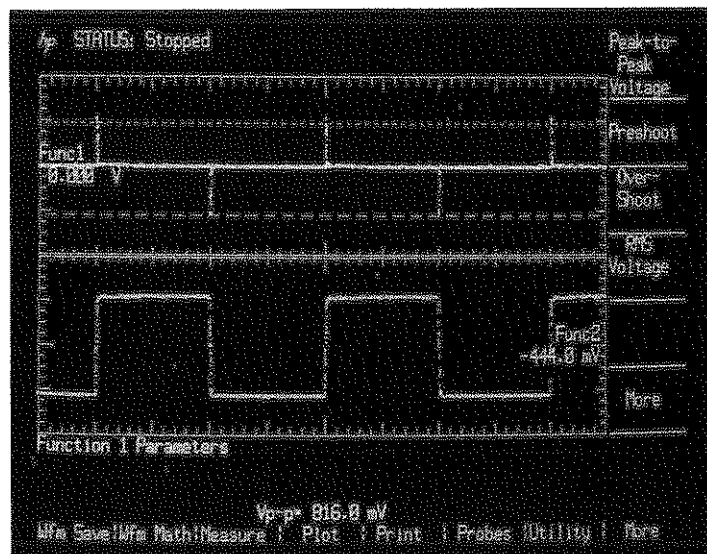

Figure 7-28. Measuring Func 1 Parameters.

8. Return to the measure menu and measure "All" parameters on func 1 (see figure 7-29). The instrument will make the measurements that it can using the the displayed data.
9. Select func 2 and again measure "All" parameters (see figure 7-30).

Notice that after the automated measurements were performed on func 2 that the Delta t and Delta V markers moved from func 1 to func 2.

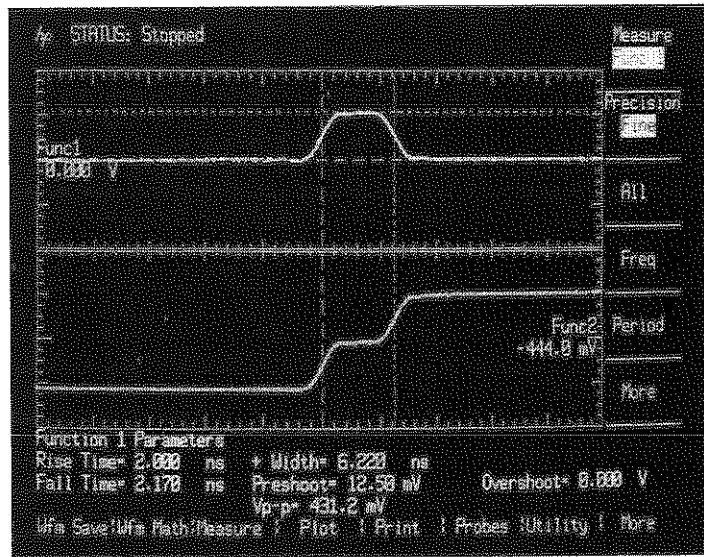

Figure 7-29. Automated Measurements on Func 1.

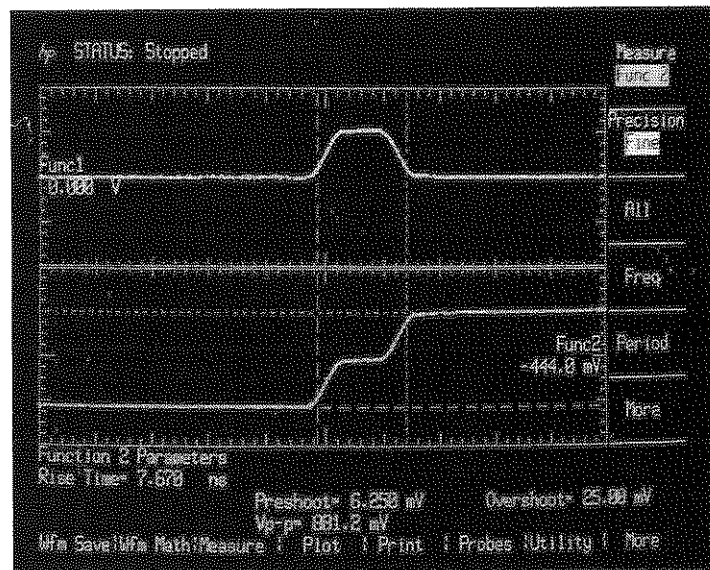

Figure 7-30. Automated Measurements on Func 2.

The 54100A/D also provides the capability of making an X,Y or Versus measurements where channels 1 or 2, or memories 1,2,3 or 4 can be used as operands. In the following exercise, a versus measurement is made between channel 1 and channel 2. NOTICE THE REQUIREMENT FOR PRECISE TIME RESOLUTION ON THE WAVEFORM EDGES WHEN YOU ARE MAKING A VERSUS MEASUREMENT.

1. Place a BNC tee on a cal signal output on the rear panel of the instrument and connect 1 meter BNC cables from the tee to channel 1 and channel 2 inputs. It is important that these BNC cables be of equal length so that the cal signal arrives at the channel 1 & 2 inputs at the same time.
2. Press AUTO-SCALE and perform a front panel calibration on the instrument which nulls the differences between the trigger and data acquisition paths. See Section 6-21 for this procedure. See, also, Appendix B for a discussion of this topic.
3. Select the Display menu and set Mode to Normal, Display Time to Infinite.
4. Select the Timebase menu and set the SEC/DIV to 1 nsec/div (Figure 7-31). Notice the precise time resolution (number of data points) on the edges.
5. Press the More key and select the Wfm Math menu. Turn Func 1 On and select Chan 1 Versus Chan 2. (See Figure 7-32).

If waveform edges are measured with inadequate time resolution, the resulting versus waveform will not look as predicted. For Example:

6. Turn Func 1 off and select the Timebase menu. Set the SEC/DIV to 10 nsec/div (see Figure 7-33). Note the near vertical edges, (this indicates lower time resolution).
7. Return to the Wfm Math menu and turn Func 1 on. The resulting chan 1 versus chan 2 (top of Figure 7-34) shows rectangular steps that occur when insufficient edge resolution is used. This is a result of the random repetitive sampling technique used in the 54100A/D, where by, many voltage points can be taken in the same time interval (as referenced to the trigger). Channel to channel timing skew may further aggravate this situation. To eliminate this phenomena, you should increase time resolution on the edges as shown in figures 7-31 and 7-32. These expanded waveforms allow for more data points on the given waveforms. The increased number of data points on the waveforms reduces the potential for inaccuracies of the displayed waveform.

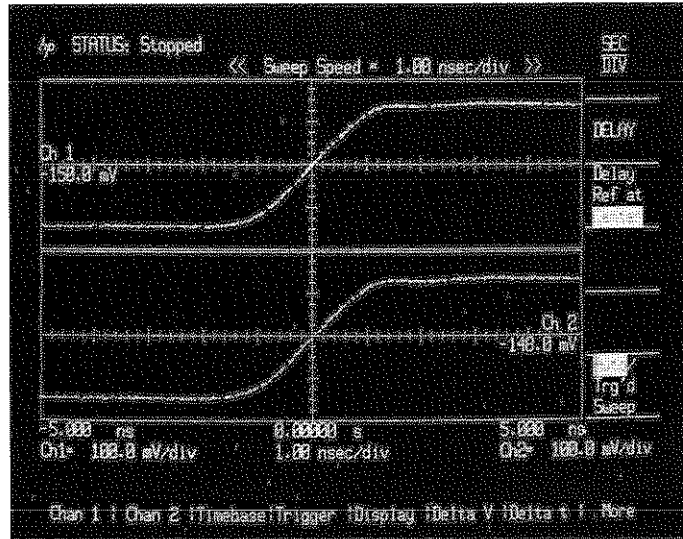

Figure 7-31. Precise Timing Resolution on Channels 1 & 2.

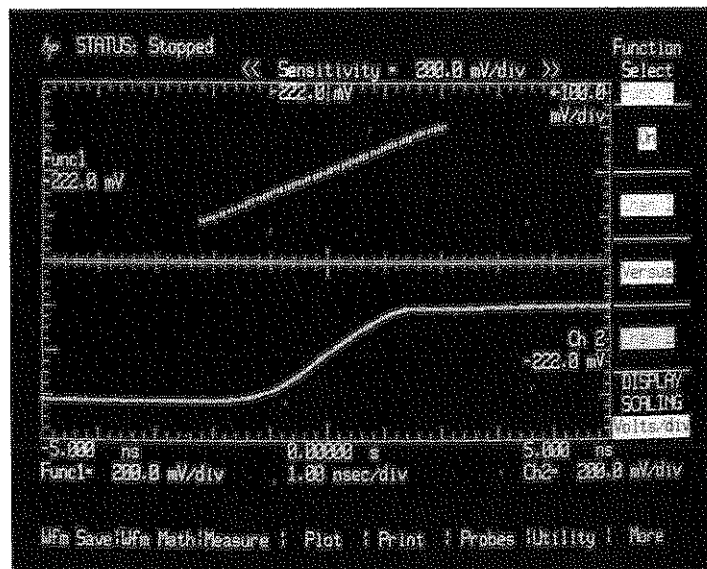

Figure 7-32. Chan 1 Versus Chan 2 with Precise Timing Resolution.

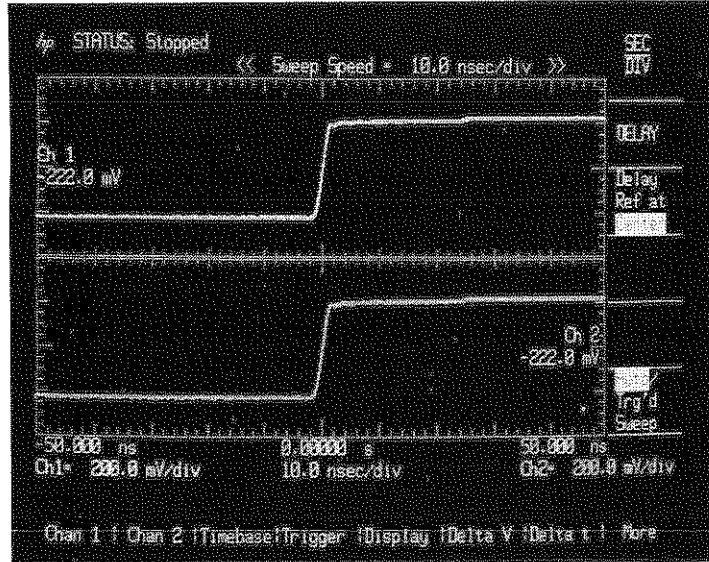

Figure 7-33. Low Timing Resolution on Channels 1 & 2.

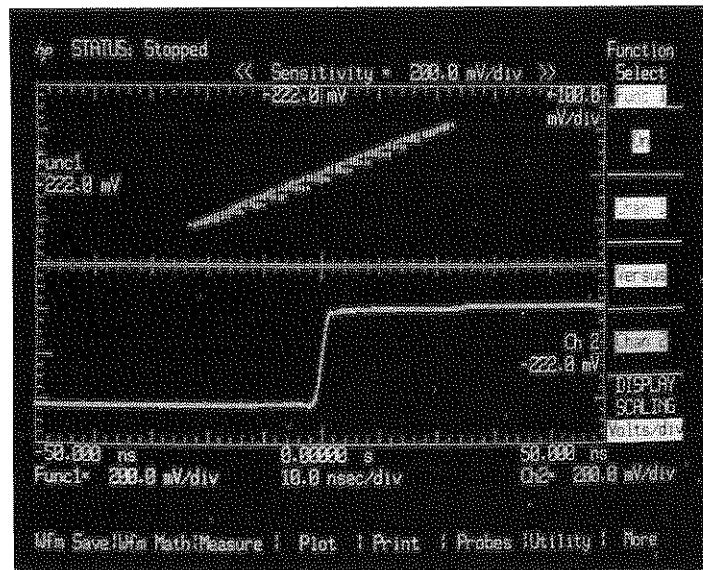

Figure 7-34. Chan 1 Versus Chan 2 with Low Timing Resolution.

The calibration menu contains an adjustment for nulling the timing skew of channel 2 with respect to channel 1. The following exercise demonstrates how the channel-to-channel skew adjustment can effect waveform math functions:

1. Connect a BNC tee to a cal signal output on the rear panel of the instrument and connect 1 metre BNC cables from the tee to channel 1 and channel 2 inputs. It is important that these BNC cables be of equal length so that the cal signal arrives at the channel 1 & 2 inputs at approximately the same time.
2. Press AUTO-SCALE.
3. Select the Utility menu.
4. Press the Cal menu function
5. Press the top function key twice (SKEW Ch to Ch) will be selected.
6. Use the key pad and set the Ch to Ch SKEW to 10 ns.
7. Press the Exit Cal Menu Key.
8. Select the Timebase menu.
9. Set the sweep speed to 25 ns/div.
10. Press the STOP/SINGLE system control key.
11. Press the CLEAR system control key.
12. Press the STOP/SINGLE key to initiate a single acquisition. See Figure 7-35.

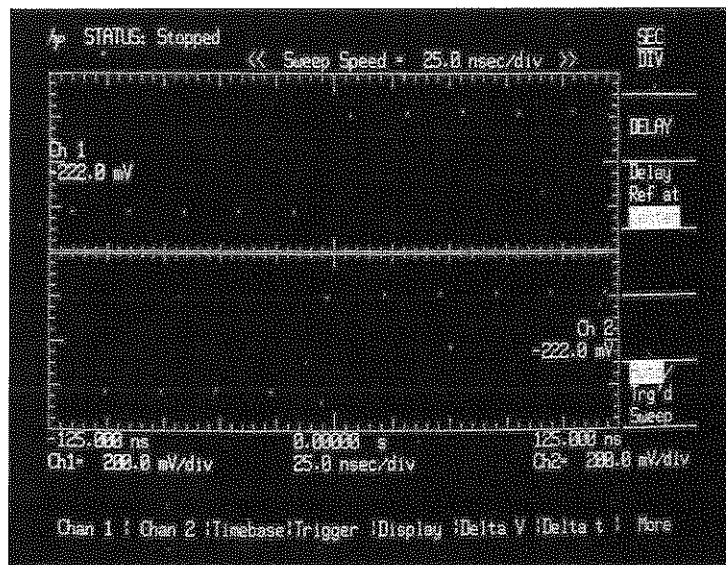

Figure 7-35. Effects of Ch to Ch SKEW on Waveform Math.

The minimum sampling interval is 25 ns therefore will be 10 points displayed there will be 10 data points displayed on each channel and they will be one division apart. The data points for channel 2 were acquired at the same time as the channel 1 data points but are offset by 10 ns because of the channel to channel skew setting. (Press the RECALL key and the 1 key to restore the channel to channel skew cal factor once the display has been evaluated).

When the waveform math functions are used the screen is divided into 500 time buckets. Each pixel column on the screen corresponds to a time bucket. A function which has two operands is performed by matching the data points of one operand with the corresponding data points of the other.

There are several waveform math applications where non-zero channel to channel skew settings can effect the results:

1. A **single shot** measurement on a waveform function using two channels such as Channel 1 + Channel 2 may result in not displaying a waveform. This will occur when the data points acquired for Channel 1 do not correspond in time with the data points acquired for Channel 2.
2. **Common noise on differential signals** may not always cancel when when Channel 1 - Channel 2 function is used. This happens when the Channel 1 data points are matched with Channel 2 data points acquired on another sweep. This effect can be minimized by setting the display mode to Averaged.
3. **An untriggered Channel 1 versus Channel 2** function may result in a misleading display. Again, this happens when data points acquired for Channel 1 on one sweep are matched with data points from Channel 2 acquired on another sweep. In an untriggered mode there is no timing relationship between each sweep.

These effects are less pronounced at slower sweep speeds and disappear at sweep speeds slower than $2 \mu\text{s}/\text{div}$. At $2 \mu\text{s}/\text{div}$ sweep speed and slower more than 500 data points are acquired on each acquisition.

When making these measurements, it may be necessary to set the channel to channel skew to 0. This will allow the data acquired for channel 1 to align with the data acquired for channel 2 for each sweep.

NOTES:

SECTION 8 MAKING A HARDCOPY

8-1. INTRODUCTION

The HP 54100A/D has the capability of making a hardcopy dump to various HP-IB graphics printers and plotters without the use of a controller. This section will show how to use the HP 54100A/D with the graphics printers and plotters.

8-2. SETTING UP THE HP 54100A/D

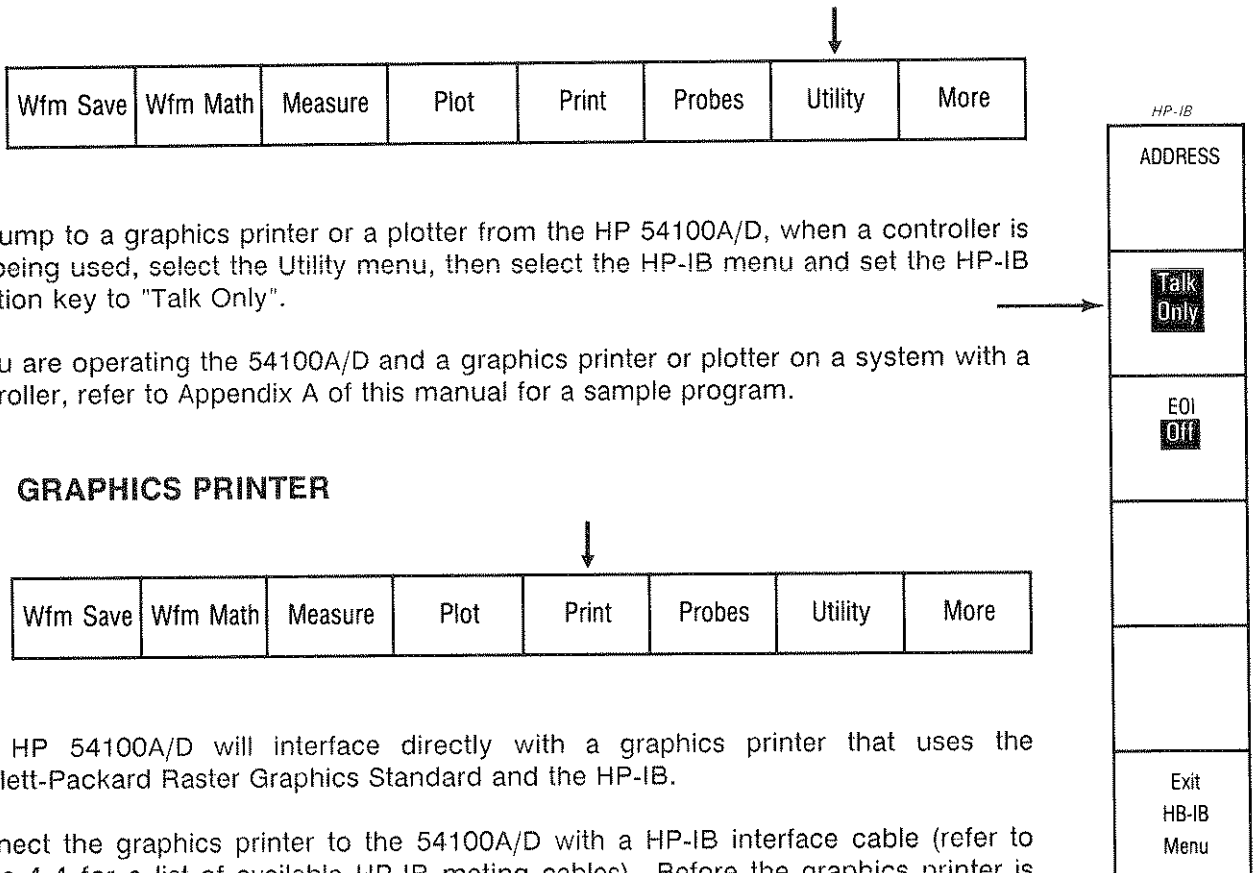

To dump to a graphics printer or a plotter from the HP 54100A/D, when a controller is not being used, select the Utility menu, then select the HP-IB menu and set the HP-IB function key to "Talk Only".

If you are operating the 54100A/D and a graphics printer or plotter on a system with a controller, refer to Appendix A of this manual for a sample program.

8-3. GRAPHICS PRINTER

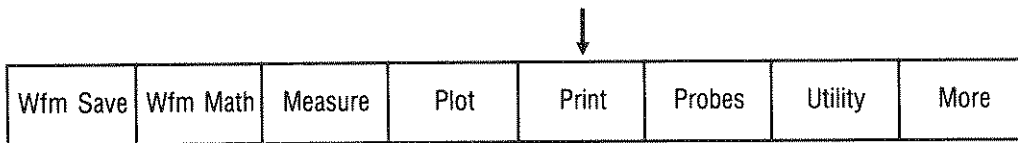

The HP 54100A/D will interface directly with a graphics printer that uses the Hewlett-Packard Raster Graphics Standard and the HP-IB.

Connect the graphics printer to the 54100A/D with a HP-IB interface cable (refer to figure 4-4 for a list of available HP-IB mating cables). Before the graphics printer is energized, refer to the printer manual to locate the HP-IB configuration switch on the printer and set the LISTEN ALWAYS (LISTEN ONLY) switch to the true (1) position. It is important that you set this switch before power is applied to the printer as most printers only read these switch settings when the power is first applied. If the switch settings have been changed, the printer must be turned off for several seconds and then back on before printing.

After the HP 54100A/D has been connected to the graphics printer and the configuration switch has been set to the LISTEN ALWAYS mode, select the Print menu on the HP 54100A/D.

The print menu will be displayed on the right side of the CRT. The factors (listed below the signal display area) and the Display can be printed separately or at the same time depending of whether they are keyed On or Off.

Data from all sources, i.e., the active display, or the the factors area, that have been selected, will be printed when the Start Print key is pressed. Waveform acquisition stops while print data is output to the printer.

If you chose to stop the print while it is in process, press the Abort Print key.

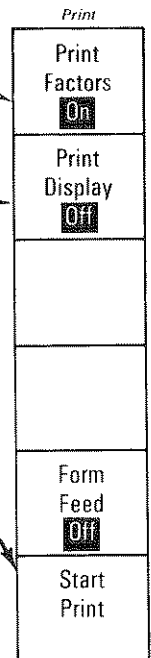

8-4. COMPATIBLE PRINTERS

The Hewlett-Packard printers that are compatible with the 54100A/D include:

- | | | |
|----------|----------|----------|
| HP 2225A | HP 2932A | HP 9876A |
| HP 2671G | HP 2933A | |
| HP 2673A | HP 2934A | |

8-5. PLOTTERS

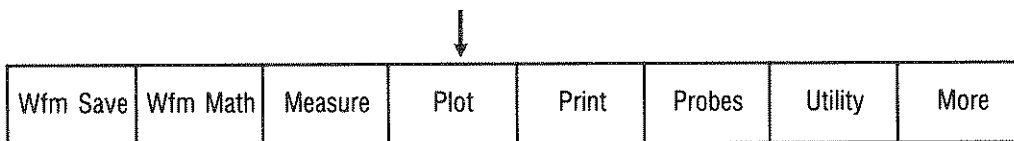

The HP 54100A/D will interface directly with plotters that use the HEWLETT-PACKARD GRAPHICS LANGUAGE (HP-GL) and a HP-IB interface.

The HP 54100A/D must be in the "Talk Only" mode when making a graphics dump to a plotter. The status of the HP-IB on the HP 54100A/D is listed at the top of the display when you are in the HP-IB Utility menu; "Talk Only", "Listen Only", or the HP-IB address will also be listed if the unit is in the Talk/Listen mode.

The plotter must be in the Listen Always (Listen Only) mode. Check the plotter manual for the location of the HP-IB configuration switch and set the Listen Always switch to the true(1) position. Set this switch before the plotter is energized as most plotters read these switch settings when the power is first applied.

Connect the HP 54100A/D and the plotter using one of the HP-IB interface cables listed in Section 4.

After the HP 54100A/D is connected to the plotter and set to the correct HP-IB configuration, select the Plot menu. Once this is done, the Plot function menu will be displayed at the right of the CRT.

When the Auto Pen function is On, a new pen will be selected when a different function is chosen to be plotted, if the plotter has multi-pen capability. If Auto Pen is Off, the plotter will not load or change pens when the Plot function is selected. In this case, it will be necessary for the operator to load a pen before starting the plot.

The next function key, Pen Speed, allows you to select Fast or Slow, if the plotter in use has this feature. Slow is normally chosen when making transparencies. For best results when using Leroy pens use the slow pen speed.

The next key allows you to plot the displayed graticule including the markers and the display factors at the bottom of the CRT.

When Plot Display is selected, all on-screen waveforms will be output to the plotter. This does not include the graticule or the display factors.

If the Display menu is in the Averaged mode, the output from the HP 54100A/D will cause the plotter to draw a continuous line plot of the active display.

If the Display menu is in the Normal mode the output from the HP 54100A/D is formatted such that the plotter will plot the waveform(s) in a pixel format, i.e., dot by dot if you are plotting an active display.

Waveform memories will always be plotted with a continuous line and pixel memories are always plotted dot by dot.

While a plot is being accomplished you can stop the plot by pressing the Abort Plot key. If you would like to stop for a moment and then continue, press the Pause/Continue key.

8-6. COMPATIBLE PLOTTERS

The Hewlett-Packard plotters that are compatible with the 54100A/D include:

| | |
|----------|----------|
| HP 7470A | HP 7580B |
| HP 7475A | HP 7585B |
| HP 7550A | HP 7586A |
| HP 7480A | HP 7090A |
| HP 9872T | |

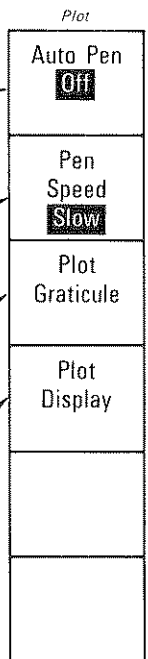

NOTES:

SECTION 9

REMOTE OPERATION

9-1. INTRODUCTION

This section discusses the remote operation of the 54100A/D over the Hewlett Packard Interface Bus (HP-IB). With the exception of the line switch, all the front panel functions and some instrument features that are remote only operations can be controlled by sending the appropriate commands over the HP-IB.

In this manual 54100A/D program codes are listed in ASCII code. Table 9-1 lists ASCII characters and some commonly used equivalent codes.

For additional information concerning HP-IB, refer to IEEE std. 488-1978 or the identical ANSI Standard MC1.1, "IEEE Standard Digital Interface for Programmable Instrumentation".

9-2. HP-IB COMPATIBILITY

The 54100A/D's HP-IB compatibility as defined in the IEEE std. 488-1978 appears in table 9-2.

Twelve HP-IB Meta messages are listed in the left hand column of table 9-2. The most significant of these is the Data message as they contain the program codes that set the instruments mode of operation.

9-3. HP-IB STATUS

The status of the 54100A/D's HP-IB interface is shown on the CRT by the HP-IB status message. This message describes the remote/local status, address status, talk/listen/only and whether or not the instrument is requesting service via the SRQ control line.

9-4. REMOTE MODE

The 54100A/D communicates over HP-IB in both the local and remote modes. In the remote mode, all front panel controls except the LINE switch and the LOCAL key are disabled. When Local Lockout is enforced the LOCAL key is also disabled.

The 54100A/D can be addressed to listen or talk while in the remote mode. When addressed to listen, the instrument automatically stops talking and responds to Data messages. When addressed to talk, the instrument stops listening and sends either a Data message or the Status Byte. Whether addressed or not, The 54100A/D responds to the Local, Local Lockout, Clear Lockout/Set Local, Trigger, and Abort Messages. The instrument may also output a Require Service Message.

The local to remote mode change is accomplished when a remote message is sent to the 54100A/D. This message contains two parts:

- Remote enable (REN) bus control line true.
- Device listen address (MLA) received once while REN is true.

All instrument settings remain unchanged with the local-to-remote transition. The local-to-remote transition disables the front panel with the exception of the power switch and the LOCAL key.

Table 9-1. Commonly Used Code Conversions

| HP-IB | ASCII | Decimal | Binary | Octal | Hexa- decimal | HP-IB | ASCII | Decimal | Binary | Octal | Hexa- decimal | | |
|---|--|------------|------------|------------|------------------|-------|-----------|------------|------------|------------|------------------|-----|----|
| Addressed Command Group (ACG) | GTL | NUL | 0 | 00 000 000 | 000 | 00 | Talk | T0 | @ | 64 | 01 000 000 | 100 | 40 |
| | | SOH | 1 | 00 000 001 | 001 | 01 | Address | T1 | A | 65 | 01 000 001 | 101 | 41 |
| | | STX | 2 | 00 000 010 | 002 | 02 | Group | T2 | B | 66 | 01 000 010 | 102 | 42 |
| | SDC PPC | ETX | 3 | 00 000 011 | 003 | 03 | (TAG) | T3 | C | 67 | 01 000 011 | 103 | 43 |
| | | EOT | 4 | 00 000 100 | 004 | 04 | Note 2 | T4 | D | 68 | 01 000 100 | 104 | 44 |
| | | ENQ | 5 | 00 000 101 | 005 | 05 | | T5 | E | 69 | 01 000 101 | 105 | 45 |
| | | ACK | 6 | 00 000 110 | 006 | 06 | | T6 | F | 70 | 01 000 110 | 106 | 46 |
| | BEL | 7 | 00 000 111 | 007 | 07 | T7 | | G | 71 | 01 000 111 | 107 | 47 | |
| | GET TCT | BS | 8 | 00 001 000 | 010 | 08 | | T8 | H | 72 | 01 001 000 | 110 | 48 |
| | | HT | 9 | 00 001 001 | 011 | 09 | | T9 | I | 73 | 01 001 001 | 111 | 49 |
| | | LF | 10 | 00 001 010 | 012 | 0A | | T10 | J | 74 | 01 001 010 | 112 | 4A |
| | | VT | 11 | 00 001 011 | 013 | 0B | T11 | K | 75 | 01 001 011 | 113 | 4B | |
| | Universal Command Group (UCG) | LLO | FF | 12 | 00 001 100 | 014 | 0C | T12 | L | 76 | 01 001 100 | 114 | 4C |
| | | | CR | 13 | 00 001 101 | 015 | 0D | T13 | M | 77 | 01 001 101 | 115 | 4D |
| | | | SO | 14 | 00 001 110 | 016 | 0E | T14 | N | 78 | 01 001 110 | 116 | 4E |
| SI | | | 15 | 00 001 111 | 017 | 0F | T15 | O | 79 | 01 001 111 | 117 | 4F | |
| DCL PPU | | DC1 | 16 | 00 010 000 | 020 | 10 | T16 | P | 80 | 01 010 000 | 120 | 50 | |
| | | DC2 | 17 | 00 010 001 | 021 | 11 | T17 | Q | 81 | 01 010 001 | 121 | 51 | |
| | | DC3 | 18 | 00 010 010 | 022 | 12 | T18 | R | 82 | 01 010 010 | 122 | 52 | |
| SPE SPD | | DC4 | 19 | 00 010 011 | 023 | 13 | T19 | S | 83 | 01 010 011 | 123 | 53 | |
| | | NAK | 20 | 00 010 100 | 024 | 14 | T20 | T | 84 | 01 010 100 | 124 | 54 | |
| | | SYN | 21 | 00 010 101 | 025 | 15 | T21 | U | 85 | 01 010 101 | 125 | 55 | |
| | ETB | 22 | 00 010 110 | 026 | 16 | T22 | V | 86 | 01 010 110 | 126 | 56 | | |
| FS GS RS US | ETB | 23 | 00 010 111 | 027 | 17 | T23 | W | 87 | 01 010 111 | 127 | 57 | | |
| | CAN | 24 | 00 011 000 | 030 | 18 | T24 | X | 88 | 01 011 000 | 130 | 58 | | |
| | EM | 25 | 00 011 001 | 031 | 19 | T25 | Y | 89 | 01 011 001 | 131 | 59 | | |
| | SUB | 26 | 00 011 010 | 032 | 1A | T26 | Z | 90 | 01 011 010 | 132 | 5A | | |
| | ESC | 27 | 00 011 011 | 033 | 1B | T27 | [| 91 | 01 011 011 | 133 | 5B | | |
| | FS | 28 | 00 011 100 | 034 | 1C | T28 | \ | 92 | 01 011 100 | 134 | 5C | | |
| | GS | 29 | 00 011 101 | 035 | 1D | T29 |] | 93 | 01 011 101 | 135 | 5D | | |
| RS | 30 | 00 011 110 | 036 | 1E | T30 | ^ | 94 | 01 011 110 | 136 | 5E | | | |
| US | 31 | 00 011 111 | 037 | 1F | UNT | _ | 95 | 01 011 111 | 137 | 5F | | | |
| Listen Address Group (LAG) Note 1 | L0 | SP | 32 | 00 100 000 | 040 | 20 | Secondary | S0 | . | 96 | 01 100 000 | 140 | 60 |
| | L1 | ! | 33 | 00 100 001 | 041 | 21 | Command | S1 | a | 97 | 01 100 001 | 141 | 61 |
| | L2 | " | 34 | 00 100 010 | 042 | 22 | Group | S2 | b | 98 | 01 100 010 | 142 | 62 |
| | L3 | # | 35 | 00 100 011 | 043 | 23 | (SCG) | S3 | c | 99 | 01 100 011 | 143 | 63 |
| | L4 | \$ | 36 | 00 100 100 | 044 | 24 | Note 3 | S4 | d | 100 | 01 100 100 | 144 | 64 |
| | | % | 37 | 00 100 101 | 045 | 25 | | S5 | e | 101 | 01 100 101 | 145 | 65 |
| | | & | 38 | 00 100 110 | 046 | 26 | | S6 | f | 102 | 01 100 110 | 146 | 66 |
| | | ' | 39 | 00 100 111 | 047 | 27 | | S7 | g | 103 | 01 100 111 | 147 | 67 |
| | | (| 40 | 00 101 000 | 050 | 28 | | S8 | h | 104 | 01 101 000 | 150 | 68 |
| | |) | 41 | 00 101 001 | 051 | 29 | | S9 | i | 105 | 01 101 001 | 151 | 69 |
| | | * | 42 | 00 101 010 | 052 | 2A | | S10 | j | 106 | 01 101 010 | 152 | 6A |
| | L8 | + | 43 | 00 101 011 | 053 | 2B | S11 | k | 107 | 01 101 011 | 153 | 6B | |
| | | , | 44 | 00 101 100 | 054 | 2C | S12 | l | 108 | 01 101 100 | 154 | 6C | |
| | | - | 45 | 00 101 101 | 055 | 2D | S13 | m | 109 | 01 101 101 | 155 | 6D | |
| | | . | 46 | 00 101 110 | 056 | 2E | S14 | n | 110 | 01 101 110 | 156 | 6E | |
| | | / | 47 | 00 101 111 | 057 | 2F | S15 | o | 111 | 01 101 111 | 157 | 6F | |
| | | 0 | 48 | 00 110 000 | 060 | 30 | S16 | p | 112 | 01 110 000 | 160 | 70 | |
| | | 1 | 49 | 00 110 001 | 061 | 31 | S17 | q | 113 | 01 110 001 | 161 | 71 | |
| | L16 | 2 | 50 | 00 110 010 | 062 | 32 | S18 | r | 114 | 01 110 010 | 162 | 72 | |
| | | 3 | 51 | 00 110 011 | 063 | 33 | S19 | s | 115 | 01 110 011 | 163 | 73 | |
| | | 4 | 52 | 00 110 100 | 064 | 34 | S20 | t | 116 | 01 110 100 | 164 | 74 | |
| | | 5 | 53 | 00 110 101 | 065 | 35 | S21 | u | 117 | 01 110 101 | 165 | 75 | |
| | | 6 | 54 | 00 110 110 | 066 | 36 | S22 | v | 118 | 01 110 110 | 166 | 76 | |
| | | 7 | 55 | 00 110 111 | 067 | 37 | S23 | w | 119 | 01 110 111 | 167 | 77 | |
| | | 8 | 56 | 00 111 000 | 070 | 38 | S24 | x | 120 | 01 111 000 | 170 | 78 | |
| | L24 | 9 | 57 | 00 111 001 | 071 | 39 | S25 | y | 121 | 01 111 001 | 171 | 79 | |
| | | : | 58 | 00 111 010 | 072 | 3A | S26 | z | 122 | 01 111 010 | 172 | 7A | |
| ; | | 59 | 00 111 011 | 073 | 3B | S27 | { | 123 | 01 111 011 | 173 | 7B | | |
| < | | 60 | 00 111 100 | 074 | 3C | S28 | | 124 | 01 111 100 | 174 | 7C | | |
| = | | 61 | 00 111 101 | 075 | 3D | S29 |] | 125 | 01 111 101 | 175 | 7D | | |
| > | | 62 | 00 111 110 | 076 | 3E | S30 | ~ | 126 | 01 111 110 | 176 | 7E | | |
| ? | | 63 | 00 111 111 | 077 | 3F | S31 | DEL | 127 | 01 111 111 | 177 | 7F | | |

NOTES: 1. L<n>#MLA assigned to device number <n>.
 2. T<n> = MTA assigned to device number <n>.
 3. Meaning defined by Primary Command Group code.

Table 9-2. HP-IB Message Reference Table

| HP-IB Meta Message | Applicable | Instrument Response | Related Commands and Control Lines | Interface Functions |
|-------------------------|------------|--|--|---------------------|
| Data | Yes | All front panel, menu, and remote functions except LINE switch. Also, all instrument settings may be read via the HP-IB. | DAB EOI EOS MLA UNL MTA UNT OTA | L3 T5 |
| Trigger | Yes | Responds as if the "RUN" System command were issued. | GET MLA | DT1 |
| Clear | Yes | Responds by: <ul style="list-style-type: none"> • Terminating bus communication • Clearing serial poll bits • Clearing input and output buffers • Clearing error queue and key register • Stopping measurements and acquisitions. | DCL SDC | DC1 |
| Remote | Yes | Enabled to remote mode when the REN bus control line is true. However, it remains in local until it is addressed to listen the first time. | REN MLA | RL1 |
| Local | Yes | Returns from remote to local when it receives the Local message or the LOCAL key is pressed. Settings remain unchanged after the remote-to-local transition. | GTL MLA | RL1 |
| Local Lockout | Yes | When in remote, and local lockout is in effect, the front panel is disabled. Only the system controller can return the instrument to local. | LLO | RL1 |
| Clear Lockout Set/Local | Yes | Returns to local and local lockout is clear when the REN bus control line goes false. | REN | RL1 |
| Pass/Take Control | No | The controller subset is not implemented. | TCT | C0 |
| Require Service | Yes | Sets the SRQ line true when one of the service request conditions occur, if it has been enabled to send the RQS message for that condition. | SRQ | SR1 |

Table 9-2. HP-IB Message Reference Table (continued)

| HP-IB Meta Message | Applicable | Instrument Response | Related Commands and Control Lines | Interface Functions |
|--------------------|------------|---|------------------------------------|---------------------|
| Status Byte | Yes | Responds to a Serial Poll Enable (SPE) bus command by sending an 8-bit byte when it is addressed to talk. Bit 6 (RQS bit) is true if the 54100A/D has set the SRQ bus control line true. The byte is cleared after it is read by the HP-IB controller if the RQS bit was set. | SPE SPD STB | T5 |
| Status Bit | No | Does not respond to a parallel poll. | PPE PPC PPD PPU | PP0 |
| Abort | Yes | Is unaddressed to listen or talk. | IFC | T5 L3 |

The unit must be in the Talk/Listen mode before the local to remote transition can be made.

The 54100A/D supports the following HP-IB interface functions: SH1, AH1, T5, TE0, L3, LE0, SR1, RL1, PP0, DC1, DT1, C0, E1.

9-5. LOCAL MODE

When the 54100A/D is in the local mode all the front panel controls are operational and the instrument will not respond to input data over the bus. If the unit is addressed to talk it can send data messages and the status byte. Whether addressed or not the 54100A/D will respond to the remote, local, local lockout, clear lockout/set local, trigger and abort messages. The unit can also output a require service message in the local mode.

This instrument always switches to local from remote whenever it receives the local message (GTL) or the clear lockout/set local message. The clear lockout/set local message sets the remote enable control line (REN) false. If the unit is in the local lockout mode the LOCAL key on the front panel will be disabled.

The instrument's settings remain unchanged during remote-to-local transition. The "Remote" indication on the HP-IB status line on the CRT will disappear as the remote-to-local change is made.

9-6. LOCAL LOCKOUT

If the unit was under remote (program) control and the front panel LOCAL key were inadvertently pressed the instrument would return to local control. Data and/or settings could be changed. To prevent this you may use the local lockout message. This command allows return-to-local only under program control.

NOTE

Return-to-local can be accomplished by cycling the power switch, however, this technique has two potential disadvantages:

- *The system controller may lose control of the instrument.*
- *Other HP-IB conditions reset to default states at power up.*

9-7. ADDRESSING

If the bus is in the command mode i.e., the attention control line (ATN) is true, the 54100A/D interprets the byte on the eight data lines as an address or as a bus command. When the "Talk/Listen" HP-IB function is selected from the front panel the instrument may be addressed to talk or to listen.

If you address the instrument to listen it will remain configured to listen until it receives an abort message (IFC), its own talk address (MTA), or a universal unlisten command (UNL) from the controller.

If you address the instrument to talk it will remain configured to talk until it receives an abort message (IFC), another instrument's talk address (OTA), its own listen address (MLA), or a universal untalk command (UNT). The HP-IB status line on the CRT will indicate "Talk" when the instrument is addressed to talk and "Listen" when the instrument is addressed to listen.

The 54100A/D is shipped from the factory in the addressable mode, with the talk and listen addresses set to "7", i.e., T7 and L7. Refer to table 9-1 for equivalent address codes. The instrument can also be configured in the talk-only or listen-only mode. These modes enable limited bus operation without an HP-IB controller being connected. The instrument's address and addressing mode may be displayed or changed from the front panel. Refer to Section 6 for complete instructions.

If the instrument is set to the listen-only mode it responds to all data messages sent on the HP-IB. However, it cannot output data messages and is inhibited from responding to the remote, local, local lockout, clear lockout/ set local, or abort messages. In this mode the unit cannot issue the require service message and cannot respond to a serial poll.

NOTE

The front panel is enabled in the listen-only mode. This allows you to change settings while a program is executing.

If the instrument is set to the talk-only mode it does not respond to any of the bus messages. You would select this mode if the 54100A/D was to output data directly to an HP-IB plotter or printer without the aid of a HP-IB controller.

9-8. HP-IB TURN-ON DEFAULT CONDITIONS

Several HP-IB parameters are reset during power-up, however, both the unit's address and addressing mode are saved in nonvolatile memory.

HP-IB default conditions are:

- HP-IB local mode
- Local-lockout cleared
- Unaddressed (if in normal addressing mode)
- RQS mask set to decimal 32546 (bits 1,5,8,-14 set)
- Status byte register cleared
- WAVE FORMAT set to WORD
- EOI is asserted at the end of messages sent by 54100A/D
- LONGFORM is OFF
- HEADER is OFF
- ARGUMENT is NUMERIC

Refer to Section 10 for a complete discussion of the WAVE FORMAT, EOI, LONGFORM, HEADER, and ARGUMENT commands.

9-9. DATA MESSAGES

The 54100A/D communicates on the HP-IB primarily with data messages. The instrument interprets a byte on the eight data lines as a data message when the bus is in the data mode i.e., attention control line (ATN) is false.

This instrument can both receive and send data messages. Input data messages include the instrument's program commands (device dependent commands) used to program front panel functions and all remote functions. Output data messages include instrument status information, the settings of specific functions, measurement results, and the learn and cal strings.

The learn and cal strings are binary data strings that contain a condensed coding of the entire instrument state and the delay cal factors. Refer to paragraph 9-12 and the descriptions of the key words: SETUP, SETUP?, CALIBRATE, and CALIBRATE?, in Section 10.

9-10. RECEIVING THE DATA MESSAGE

The 54100A/D responds to data messages when it is in the remote mode (REN is true) and the unit is addressed to listen or when it is in the listen-only mode.

Input data messages contain a string of device dependent commands (program commands) and an end-of-string message. The program codes within a data message are executed after the EOS message is received. The following format rules must be observed for all input data messages:

- A linefeed (<LF>) or an EOI is used as the EOS message. Each data message must be terminated by a <LF> or by asserting the EOI (end or identify), bus signal line with the last byte in the message.
- The carriage return character (<CR>) is not required before <LF>.
- When more than one command is sent in a data message, a semicolon, colon, or a space must be used to separate the program commands.

- Multiple arguments for a command must be separated by commas.
- The total length of a data message string may not exceed 300 characters.

Syntax errors in a data message are trapped and can be reported over HP-IB. Refer to key words "STATUS?", and "ERR?" in Section 10 for details concerning detecting and reporting format errors.

9-11. PROGRAM ORDER CONSIDERATIONS

Commands are interpreted and setups are changed in the 54100A/D's memory as they are received and found to be syntactically correct. The actual hardware settings are changed at the end of a message (EOS) unless a command to initiate a process is encountered. Process commands are immediate execution commands and include autoscale, system commands such as "DIGITIZE", and measurement commands. In these cases, hardware affected by commands preceding the process command is changed before the process is initiated. Program lines with more than 1 command are executed up to the point where an error is detected. This provides consistent operation whether commands are sent one per message or several per message.

If multiple pulse parameter measurement queries are sent in one message, the answers from those measurements will be queued for output in the order that the queries were received. Outputs in response to other queries are not queued. The last query will determine the message output by the 54100A/D when it is next addressed to talk.

9-12. PROGRAM COMMAND FORMAT

Program commands consist of a header followed by a parameter field. Headers can be of a long or short form. The long form allows easier understanding of program code and the short form allows more efficient use of the computer. Refer to Section 10 for a thorough discussion of short and long forms.

Program command parameters may be of four types:

Strings - Any group of ASCII characters, excluding quotation marks (decimal 34), surrounded by quotation marks.

Blocks - A block of binary data in the #A format as defined in IEEE Std. 728-1982. This format is a binary block with the format:

<#><A><length word><DAB...DAB>

Length word is a 15-bit binary integer representing the number of DABs. DABs are the data bytes. <A> and <#> are ASCII bytes.

Numeric - Any integer, floating point, or exponential value. The characters <E> or <e> are used to delimit the mantissa of exponential parameters. Spaces are allowed between <+>, <->, or <E> and digits, but not between digits or <.> and digits.

Alpha - Some commands require or allow alpha arguments such as "ON", or "OFF". These arguments are ASCII strings that start with an alpha character and are followed by a printable character except a <SP>, <,>, <,>, <#>, <">, or <_> (delete).

The general rules for program command formatting are:

- The 54100A/D sends and receives data messages in standard ASCII code.

- The instrument responds equally to upper and lower case characters.
- Parameter fields containing multiple parameters require a (,) to delimit individual parameters. Syntax errors in data messages are trapped and can be reported via HP-IB. Refer to Section 10 for a discussion of the key words "STATUS?" and "ERROR".

9-13. SENDING DATA MESSAGES

The 54100A/D can send data messages in local or remote mode, when addressed to talk, or when in the talk-only mode.

NOTE

Before the instrument is addressed to talk, the desired output data must be specified with the appropriate input data message. Otherwise, the instrument outputs the over range value "1E38" by default to complete the bus transaction. If the ERR service request is enabled, a service request will be generated with the "Output Buffer Empty" error in the ERRor queue.

Output data messages include the settings of individual functions, instrument status information, and binary learn string or cal string data. Excluding the learn and cal strings there are two output data types; integer and exponential. All output data messages contain a leading space (<SP>) or minus sign (<->) followed by the function value or status data. <CR> and <LF> are sent as the EOS message for all output data. An EOI can be sent with the <LF> if the EOI has been keyed on from the front panel or by the "EOI" program command.

Refer to Section 10 for a description of key words "LONGFORM", "HEADER", and "ARGUMENT".

NOTE

The 54100A/D outputs exponential values with the ASCII character "E" between the mantissa and the exponent e.g., 6.02E12.

9-14. LEARN AND CAL STRINGS

If a "SETUP?" command is sent to the 54100A/D and then the 54100A/D is addressed to talk the unit will output a learn string. The learn string consists of 270, 8-bit bytes containing information about front panel configuration. This binary data can be stored in the controller's memory for future use. The learn string includes only those parameters that determine the front panel setup of the instrument.

If a "CALIBRATE?" command is sent to the 54100A/D and then the unit is addressed to talk, it will output a cal string. The cal string consists of 24, 8 bit bytes containing the delay cal factors. This binary data can be stored in the controller's memory for future use.

The learn string and cal string data comprise the same information that is in the instrument's SAVE/RECALL registers. Refer to Section 6 for additional information concerning these registers.

These binary data blocks i.e., the learn string and the cal string, can be returned to the 54100A/D by preceding the data blocks with the "SETUP" or "CALIBRATE" commands as appropriate. Refer to Section 10 for a discussion of these two key words.

9-15. RECEIVING THE CLEAR MESSAGE

The 54100A/D responds to the clear message <DCL> and selected device clear message <SDC> by:

1. Clearing all serial poll status bits.
2. Clearing the input and output buffers.
3. Clearing the error queue and key register.
4. Stopping any measurement or acquisition processes except the normal background acquire-display cycle.

9-16. RECEIVING THE TRIGGER MESSAGE

The trigger message (GET bus command) causes the 54100A/D to make a single acquisition if the unit was in the STOP/SINGLE mode. If the unit is in the AUTO or TRIGGERED mode the trigger message will cause the instrument to enable the trigger repeatedly and display the data it acquires on the CRT. See the RUN command in Section 10.

9-17. RECEIVING THE REMOTE MESSAGE

The remote message has two parts: The remote enable bus control line (REN) is held true, then the controller sends a device listen address <MLA>. Instrument settings are unchanged during the transition from local to remote. When the unit is in the remote mode the HP-IB status line on the CRT will indicate "Remote".

9-18. RECEIVING THE LOCAL MESSAGE

The local message returns the 54100A/D to front panel control. The local message (GTL bus command) addresses the instrument to listen and then switches it from remote to local. The HP-IB status line on the CRT will be eliminated when you go from remote to local. None of the instrument settings are changed during this transition.

Although the local message returns the instrument to front panel control, it does not clear the local lockout if it has been previously set.

9-19. RECEIVING THE LOCAL LOCKOUT MESSAGE

The local lockout message (LLO bus command) disables the 54100A/D's front panel LOCAL key. Local lockout can be set when the instrument is either in the local or remote modes. After the local lockout is set and the unit is in the remote mode, local lockout will be enforced. While the unit is in remote and the local lockout is set, the remote to local transition can only be made over HP-IB.

9-20. RECEIVING THE CLEAR LOCKOUT/SET LOCAL MESSAGE

The clear lockout/set local message sets the REN control line false and returns the instrument from the remote mode to the local mode and clears the local lockout condition. Instrument settings are not changed by this message. It can be sent when the instrument is either in the remote or local mode. The affect of sending this message when the instrument is in the local mode is to clear the local lockout if it is set.

9-21. SENDING THE REQUIRE SERVICE MESSAGE

The 54100A/D sends the require service message by setting the SRQ bus control line and bit 6 of the status byte true when a previously programmed condition occurs. The instrument can send the require service message in either local or remote mode. The require service message is cleared when a serial poll is executed by the system controller. During serial poll, the SRQ control line is reset immediately before the instrument places the status byte message on the bus. Table 10-1 includes the conditions that can be selected to cause the require service message. If no conditions are selected, the require service message is disabled.

The 54100A/D indicates having sent the require service message by displaying "SRQ" on the HP-IB status line. This indicator is turned off when, during a serial poll, the SRQ control line is reset.

The 54100A/D will not send a require service message unless it is in the Talk/Listen mode.

9-22. THE STATUS WORD

The instrument status word is a 16-bit integer containing information about the instrument condition that set the ready bit in the status byte and/or generate a require service message. Refer to tables 10-1&2 for a description of the bits in the status word. The upper 8 bits of the status word are known collectively as the ready byte and the lower 8 bits correspond to the status byte sent during a serial poll.

The request mask is a 16-bit word that is used to specify both the conditions in the ready byte that set the ready bit in the status byte and the conditions in the status byte that generate the require service message.

The bits in the request mask have the same meaning as those in the instrument status word. The ready bit in the status byte is set when all of the conditions corresponding to bits in the ready mask are true at the same time. This bit is actually set on the transition of the last required condition to become true.

9-23. SENDING THE STATUS BYTE MESSAGE

The status byte message consists of one 8-bit byte. Refer to table 10-1 for the meaning of each bit. The 54100A/D sends the status byte message when it is addressed to talk and it receives the serial poll enable (SPE) bus command from the HP-IB system controller.

The instrument must be in the Talk/Listen mode in order to send the status byte or respond to the SPE or SPD (serial poll disable) commands.

Bits in the status byte are set depending on the state of the instrument. If a condition occurs that causes one of the bits in the status byte to be set and if its corresponding bit in the request mask is set, the require service message will be sent.

If the RQS bit is set, indicating that the instrument sent the require service message, and a serial poll is executed, all bits in the status byte will be cleared. If the RQS bit is clear and a serial poll is executed, the status byte will be left unchanged.

If a condition that causes one of the bits in the status byte to be set is removed and if the corresponding bit in the request mask is clear, the corresponding bit in the status byte will be cleared.

To supplement the information in the status byte, the ERRor query can be used to determine what specific error occurred.

9-24. RECEIVING THE ABORT MESSAGE

The abort message (IFC control line true) halts all bus activity. When the 54100A/D receives the abort message, it becomes unaddressed and stops talking or listening. The require service message and the status byte are unaffected by the abort message.

NOTES:

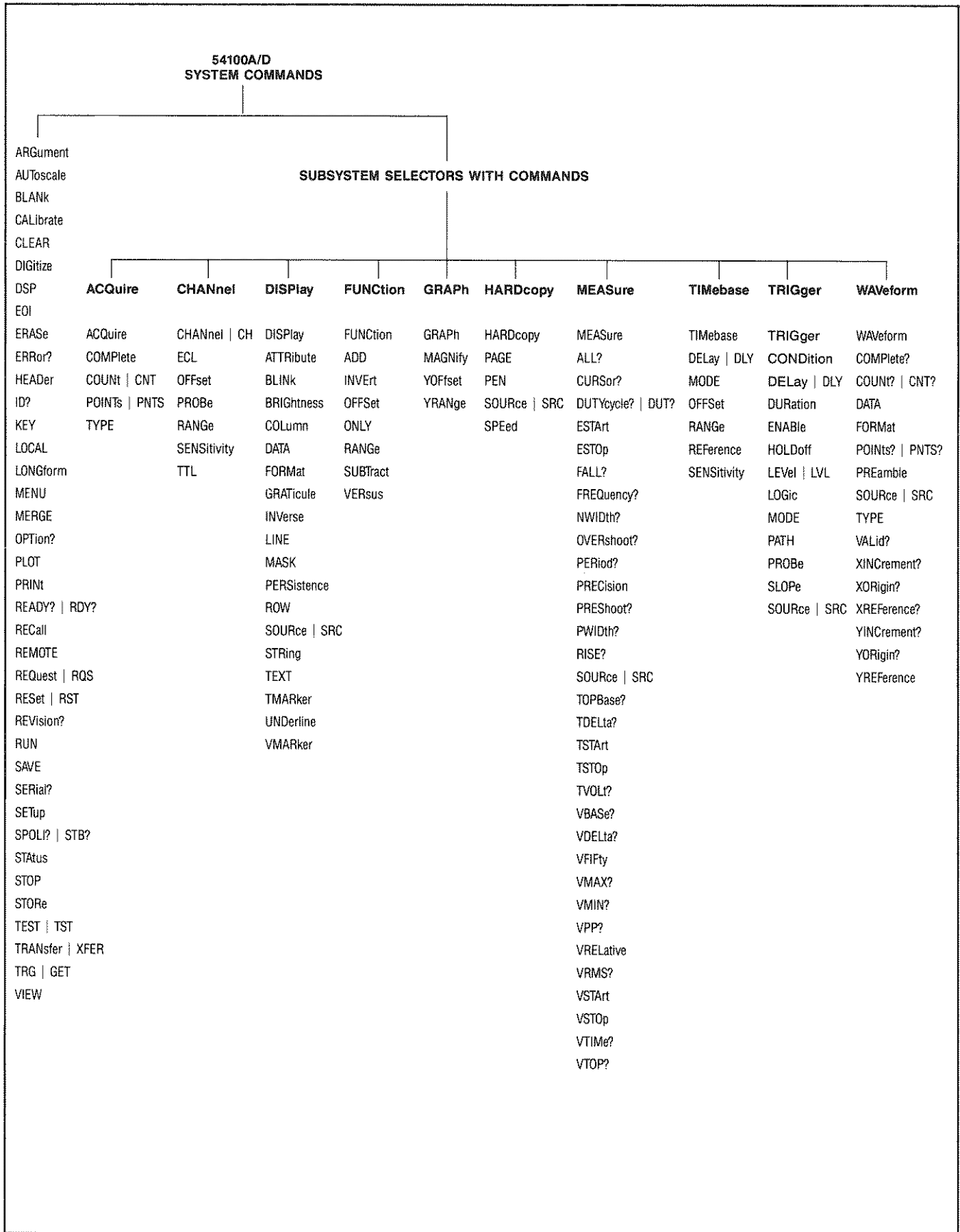

Figure 9-1. Programming Command Tree

| COMMAND | WHERE USED | COMMAND | WHERE USED | COMMAND | WHERE USED |
|--------------------------|--------------------|------------------------|--------------------|------------------------|--------------------|
| ACQuire | Acquire Subsystem | LOCAL | System Command | SPEEd | Hardcopy Subsystem |
| ADD | Function Subsystem | LOGic | Trigger Subsystem | SPOLi? STB? | System Query |
| ARGument | System Command | LONGform | System Command | STAtus | System Command |
| ALL? | Measure Subsystem | | | STOP | System Command |
| ATTRibute | Display Subsystem | | | STORe | System Command |
| AUToscale | System Command | MAGnify | Graph Subsystem | STRing | Display Subsystem |
| | | MASK | Display Subsystem | SUBTract | Function Subsystem |
| BLANK | System Command | MEASure | Subsystem Selector | | |
| BLINk | Display Subsystem | MENU | System Command | TDELta? | Measure Subsystem |
| BRIGHtness | Display Subsystem | MERGE | System Command | TEST TST | System Command |
| | | MODE | Timebase Subsystem | TEXT | Display Subsystem |
| | | MODE | Trigger Subsystem | TIMebase | Subsystem Selector |
| CALibrate | System Command | | | TMARKer | Display Subsystem |
| CHANnel CH | Subsystem Selector | NWIDth? | Measure Subsystem | TOPBase? | Measure Subsystem |
| CLEAR | System Command | | | TRANsfer XFER | System Command |
| COLumn | Display Subsystem | OFFSet | Channel Subsystem | TRG GET | System Command |
| COMPLete | Acquire Subsystem | OFFSet | Function Subsystem | TRIGger | Subsystem Selector |
| COMPLete | Waveform Subsystem | OFFSet | Timebase Subsystem | TSTArt | Measure Subsystem |
| CONDition | Trigger Subsystem | ONLy | Function Subsystem | TSTOp | Measure Subsystem |
| COUNT CNT? | Acquire Subsystem | OPTion? | System Command | TTL | Channel Subsystem |
| COUNTi? CNT? | Waveform Subsystem | OVERshoot? | Measure Subsystem | TVOLT? | Measure Subsystem |
| CURSOr? | Measure Subsystem | | | TYPE | Acquire Subsystem |
| | | PAGE | Hardcopy Subsystem | TYPE | Waveform Subsystem |
| DATA | Display Subsystem | PATH | Trigger Subsystem | | |
| DATA | Waveform Subsystem | PEN | Hardcopy Subsystem | UNDerline | Display Subsystem |
| DELay DLY | Trigger Subsystem | PERiod? | Measure Subsystem | | |
| DELay DLY | Timebase Subsystem | PERSistence | Display Subsystem | VALid? | Waveform Subsystem |
| DISPlay | Subsystem Selector | PLOT | System Command | VBASe? | Measure Subsystem |
| DIGitize | System Command | POINTs PNTS | Acquire Subsystem | VDELta? | Measure Subsystem |
| DSP | System Command | POINTs? PNTS? | Waveform Subsystem | VERsus | Function Subsystem |
| DURation | Trigger Subsystem | PREamble | Waveform Subsystem | VFIfty | Measure Subsystem |
| DUTYcycle? DUT? | Measure Subsystem | PRECision? | Measure Subsystem | VIEW | System Command |
| | | PREshoot? | Measure Subsystem | VMARker | Display Subsystem |
| ECL | Channel Subsystem | PRINt | System Command | VMAX? | Measure Subsystem |
| ENABle | Trigger Subsystem | PROBe | Channel Subsystem | VMIN? | Measure Subsystem |
| EOI | System Command | PROBe | Trigger Subsystem | VPP? | Measure Subsystem |
| ERASE | System Command | PWIDth? | Measure Subsystem | VRELative | Measure Subsystem |
| ERRor? | System Command | | | VRMS? | Measure Subsystem |
| ESTArt | Measure Subsystem | RANGE | Channel Subsystem | VSTARt | Measure Subsystem |
| ESTop | Measure Subsystem | RANGE | Function Subsystem | VSTOp | Measure Subsystem |
| | | RANGE | Timebase Subsystem | VTIME? | Measure Subsystem |
| FALL? | Measure Subsystem | READY? RDY? | System Query | | |
| FORMat | Display Subsystem | RECall | System Command | Waveform | Waveform Subsystem |
| FORMat | Waveform Subsystem | REFerence | Timebase Subsystem | | |
| FREQuency? | Measure Subsystem | REMOtE | System Command | XINCrement? | Waveform Subsystem |
| FUNCTION | Subsystem Selector | REQUest RQS | System Command | XORigin? | Waveform Subsystem |
| | | RESet RST | System Command | XREFerence? | Waveform Subsystem |
| GET TRG | System Command | REVision? | System Query | | |
| GRAPh | Subsystem Selector | RISE? | Measure Subsystem | YINCrement? | Waveform Subsystem |
| GRATICule | Display Subsystem | ROW | Display Subsystem | YOFFset | Graph Subsystem |
| | | RUN | System Command | YORigin? | Waveform Subsystem |
| HEADer | System Command | | | YRANge | Graph Subsystem |
| HARDcopy | Subsystem Selector | SAVE | System Command | YREFerence? | Waveform Subsystem |
| HOLDoff | Trigger Subsystem | SENSitivity | Channel Subsystem | | |
| | | SENSitivity | Timebase Subsystem | | |
| IC? | System Command | SERial? | System Query | | |
| INVerse | Display Subsystem | SETup | System Command | | |
| INVert | Function Subsystem | SLOPe | Trigger Subsystem | | |
| | | SOURce SRC | Display Subsystem | | |
| KEY | System Command | SOURce SRC | Hardcopy Subsystem | | |
| | | SOURce SRC | Measure Subsystem | | |
| LEVel LVL | Trigger Subsystem | SOURce SRC | Trigger Subsystem | | |
| LINE | Display Subsystem | SOURce SRC | Waveform Subsystem | | |

Figure 9-2. Alphabetical Command Cross-Reference

NOTES:

SECTION 10

COMMAND SET OVERVIEW

10-1. INTRODUCTION

With the exception of the line switch, all the front panel controls as well as some instrument features that are remote only operations can be controlled by sending the appropriate commands over the HP-IB.

NOTE

Before you get started programming your 54100A/D make sure to review Section 4 for information concerning HP-IB address selection and HP-IB interconnections. You should also review Section 9 before continuing with this section.

10-2. COMMAND SET ORGANIZATION

The command set for the 54100A/D is conveniently divided into eleven separate groups, ten have been organized into functional groups such as the Trigger Subsystem, which contains all the HP-IB commands that control the instrument's triggering functions.

These subsystems include:

1. Acquire Subsystem

The commands in The Acquire Subsystem determine the conditions for the DIGITIZE command.

2. Channel Subsystem

The commands in the Channel Subsystem are used to control the two vertical inputs. (See the VIEW and BLANK System commands for viewing channels 1 & 2 on the CRT.)

3. Display Subsystem

The commands in the Display Subsystem are used to control how data, time & voltage markers, text, and the graticules are displayed on the CRT.

4. Function Subsystem

The commands in the Function Subsystem are used to control the waveform math features of the instrument.

5. Graph Subsystem

The commands in the Graph Subsystem control the vertical magnifier on the instrument.

6. Hardcopy Subsystem

The Hardcopy Subsystem commands control parameters used during the printing and plotting of waveforms from the 54100A/D.

7. Measure Subsystem

The commands in the Measure Subsystem control the automated measurements that can be made with the 54100A/D.

8. Timebase Subsystem

The commands in the Timebase Subsystem control the timebase section of the 54100A/D.

9. Trigger Subsystem

The commands in the Trigger Subsystem control the trigger modes of the 54100A/D.

10. Waveform Subsystem

The commands in the Waveform Subsystem Control the transfer of data to and from the HP-IB buffer memories in the 54100A/D.

The 11th group is the **System Commands**. They control the HP-IB operations as well as the basic operation of the 54100A/D.

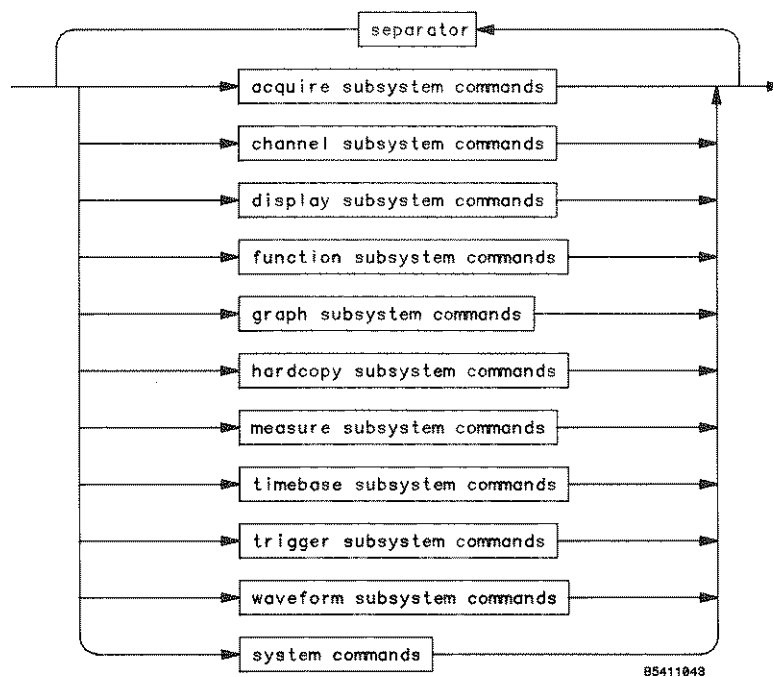
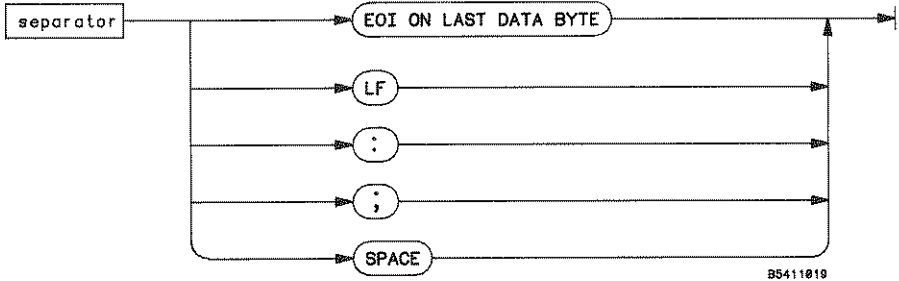

Figure 10-1. Command Set Syntax Diagram.



Command Syntax Diagram (continued).

When programming the 54100A/D you can initially issue a Subsystem Select Command or a System Command from the controller to the 54100A/D. If you have selected a particular subsystem you may execute any number of the commands in that subsystem, call System commands indiscriminately or select another subsystem. Calling a System command does not change the Selected Subsystem. Refer to figure 10-1.

NOTE

System commands can be invoked at any time and do not change the subsystem selection.

NOTES:

10-2. NOTATION CONVENTIONS AND DEFINITIONS

The following conventions are used in this manual in descriptions of remote (HP-IB) operation:

< > Angular brackets enclose words or characters that are used to symbolize a program code parameter or an HP-IB command, e.g., <A> represents the ASCII character "A".

| "or": Indicates a choice of one element from a list. For example, <A> | indicates <A> or but not both.

... Trailing dots (an ellipsis) are used to indicate that the preceding element may be repeated one or more times.

[] Square brackets indicate that the enclosed items are optional.

{ } When several items are enclosed by braces, one, and only one of these statements must be selected.

The following definitions are used:

d:: = A single ASCII character, 0-9.

n:: = A single ASCII character, 1-9.

<LF>:: = ASCII linefeed (decimal 10).

<CR>:: = ASCII carriage return (decimal 13).

<sp>:: = ASCII space (decimal 32).

10-3. COMMAND ABBREVIATIONS

Every command and every alpha parameter has at least two forms, a shortform and a longform, in some cases they will be the same. The shortform is obtained by using the following rule:

If the longform has more than 4 characters,
then if the 4th character is a vowel or the same as the 3rd character,
then truncate to 3 characters,
else truncate to 4 characters.

EXAMPLE - LONGFORM abbreviates to LONG.
SERIAL abbreviates to SER.
YOFFSET abbreviates to YOF.

In the case where two short forms would be identical, one of them will be changed slightly to differentiate between the two. In the command descriptions that follow, each command is given in both long and shortforms. The shortform of a command is highlighted in upper case, lower case characters are added to the short form to complete the longform of the command.

Some commands also have industry standard forms and these have been included in the instruction set. This means that some commands will have three forms.

10-4. ALPHA AND NUMERIC ARGUMENTS

Most of the programming commands that require parameters can use either ALPHA or NUMERIC arguments for their parameters.

EXAMPLE - OFF is the same as 0.
ON is the same as 1.

10-5. DATA OUTPUT (QUERY) FORMAT

When a query command (command followed by a "?") is sent to the 54100A/D, a response message is generated and sent back to the controller the next time the 54100A/D is addressed to talk.

The command header will be returned if the HEADER command has been set ON and will not be returned if set to OFF.

The command argument will be returned as an alpha argument if the ARGUMENT command has been set to ALPHA and will be returned as a numeric argument if set to NUMERIC. Headers and alpha arguments will be returned in the longform if LONGFORM command has been set ON and will be returned in the shortform if set OFF.

All output fields are an even number of bytes in length. There are four types of output arguments; (1)Headers and Alpha arguments, (2) Integers, (3) Real numbers and (4) Enumerated output. The enumerated output may be alpha or integer depending on whether the ARGUMENT command is set to ALPHA or NUMERIC.

10-6. COMMAND ORDER CONSIDERATIONS

Commands are interpreted and setups are changed in the 54100A/D as they are received and found to be syntactically correct. Commands preceding an error in multi-command messages are executed up to the point where the error is detected. This provides consistent operation whether commands are sent one per message or several per message.

When a query is executed the reply is placed in the output buffer of the 54100A/D. Multiple queries on one line result in the last reply overwriting the previous replies. The exception to this is when multiple parameter measurement queries are sent on one command line. In this case the replies to the measurement queries are buffered in the order that the queries occurred in the command line.

10-7. DEFAULT SETTINGS

When power is cycled on the instrument several interface parameters are put in the preset condition. Specifically the request mask (RQS mask) is set to 32546 (bit 1,5,8-14 set).

If you hold a front panel key down at the same time the unit is energized (key down power-up) the unit will initialize a more complete set of parameters. These include selecting arguments to be numeric, headers off and longform off, and EOI to be asserted with the last data byte of a message. This has the same effect as sending a "RESET" command except that the reset command does not change the EOI selection. If a deeper reset is required you may hold TWO front panel keys down at the same time the unit is energized, in addition to initializing the same set of parameters that a single key down power up did, it also erases all available nonvolatile RAM.

10-8. STATUS WORD

The instrument status word is a 16-bit integer containing information about the instrument conditions that set the ready bit in the status byte and/or generate a Require Service message. See Tables 10-1 and 10-2 for a description of the bits in the Status Word. The upper 8 bits of the Status Word are known collectively as the ready byte. The lower 8 bits correspond to the status byte sent during a serial poll.

A companion 16 bit word, the request mask, is used to specify both those conditions in the ready byte that set the ready bit in the status byte, and those conditions in the status byte that generate a Require Service Message. The bits in the request mask have the same meanings as those in the instrument status word. The ready bit in the status byte is set when all of the conditions corresponding to bits in the ready mask are true at the same time. This bit is actually set on the last transition of the last required condition to become true.

The "REQuest" programming command is used to specify the request mask while the "STAtus" programming query can be used to read the instrument status word.

10-9. PROGRAMMING EXAMPLES

All programming examples used in this section were written using an HP 200 Series Desktop Computer with Basic 4.0 operating system. For all examples, the 54100A/D interface select/address code is set to 707.

This diagram shows how commands are sent to the 54100A/D.

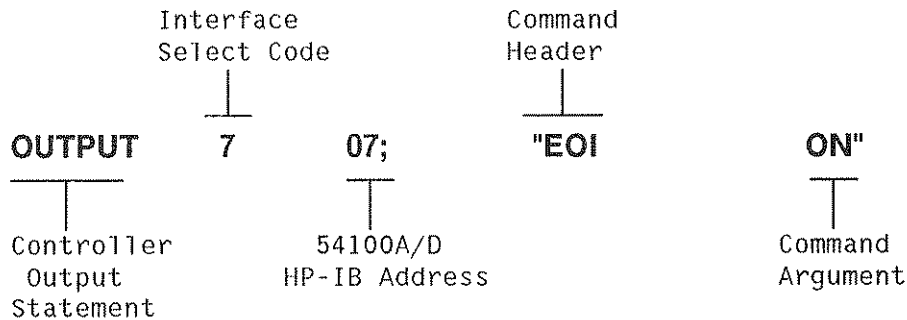

| BIT | MASK WEIGHT | STATUS BIT CONDITION |
|--|-------------|---|
| 7 | 128 | MSG = High indicates that a message was displayed on the advisory line of the display. A DSP query is used to determine the message. |
| 6 | 64 | RQS = Requesting service - High indicates that this instrument requested service. |
| 5 | 32 | ERR = Error - High indicates an error occurred. An ERROR query is used to determine error code. |
| 4 | 16 | RDY = Ready - High indicates the instrument is ready. This is based on the ready mask. A RDY query is used to determine condition. |
| 3 | 8 | LCL = Local switch or power cycle - High indicates that the instrument has been switched to local from the front panel or power was cycled off then on again. |
| 2 | 4 | FPS = Front panel service request - High indicates a front panel key has been pressed. A KEY query is used to determine the key code. |
| 1 | 2 | PWR = Indicates a non-volatile ram error. |
| 0 | 1 | RQC = Request control - Not used, always 0. |
| <p>Notes:</p> <ol style="list-style-type: none"> 1. To set the RQS bit and SRQ bus control line true, the condition must be enabled in the RQS mask. 2. If no condition is enabled, the 54100A/D can not set the SRQ bus control line nor the RQS bit true. However, bits 1-5 and 7 of the status byte are set to indicate which conditions have occurred. 3. The Ready bit (bit 4) is set when all conditions in the Ready Byte (Table 10-2) enabled in the request mask are true. | | |

Table 10-1. The Lower Byte of the Status Word
(The Status Byte)

| BIT | MASK WEIGHT | READY BIT CONDITION |
|--|-------------|--|
| 15 | 32768 | Not used, always 0. |
| 14 | 16384 | Cal = High indicates that self calibration has completed execution. |
| 13 | 8192 | Test = High indicates that the requested self test has completed execution. |
| 12 | 4096 | Hard = Hardcopy complete - High indicates that the last byte of printer or plotter dump has been sent and received |
| 11 | 2048 | Data = Data available - High indicates that something is in the buffer waiting to be read. |
| 10 | 1024 | Acq = Acquisition complete - High indicates that all waveforms are acquired. |
| 9 | 512 | Trig = Triggered - High indicates that the instrument is receiving triggers. This bit will not set RDY. |
| 8 | 256 | Parse = Parse complete - High indicates that the last command has completed parsing. |
| <p>Note: The Ready bit (bit 4) of the Status Byte (Table 10-1) is set if all of the ready conditions specified in the RQS mask are true.</p> | | |

Table 10-2. The Upper Byte of the Status Word
(The Ready Byte)

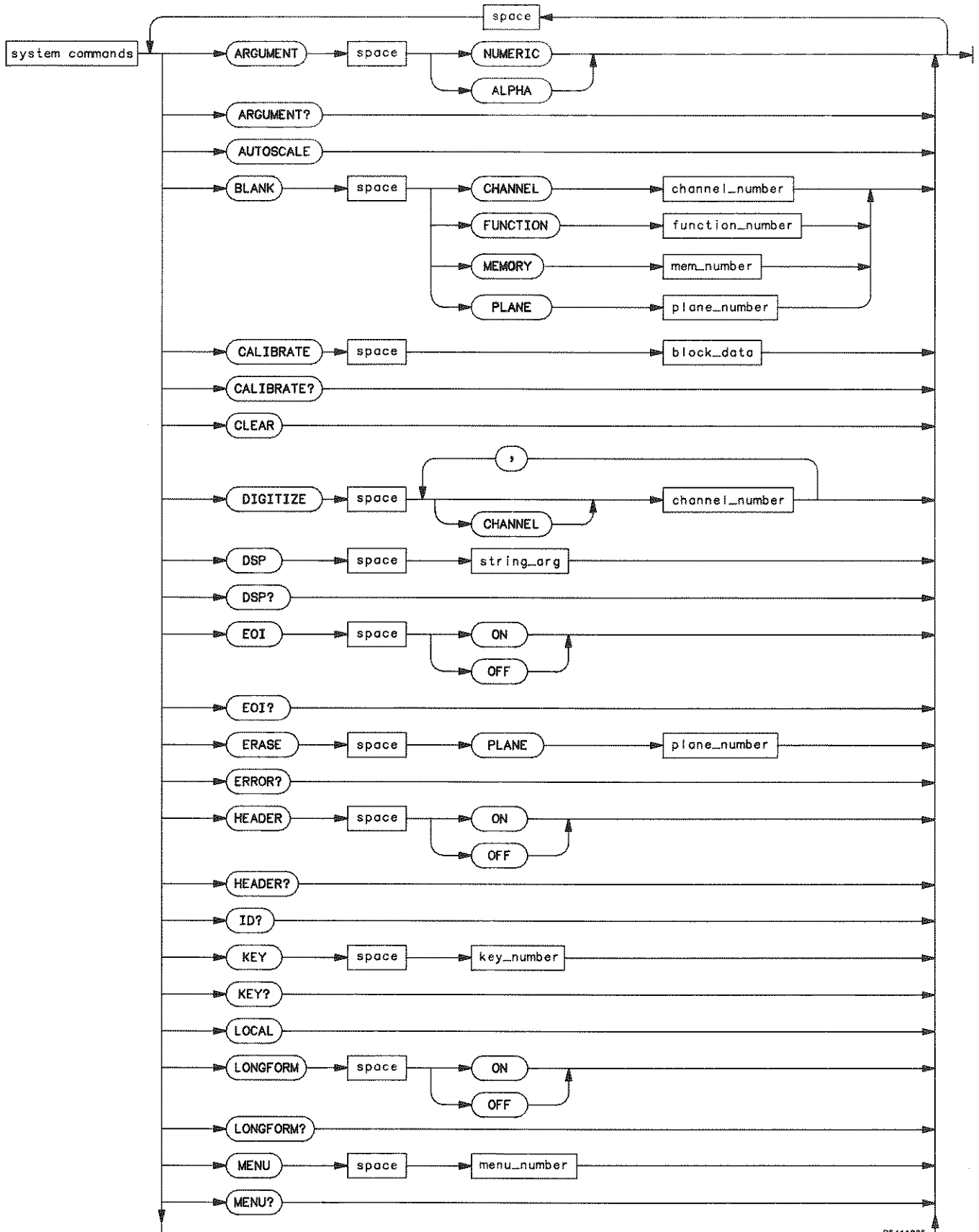

85411005

Figure 10-2. System Commands

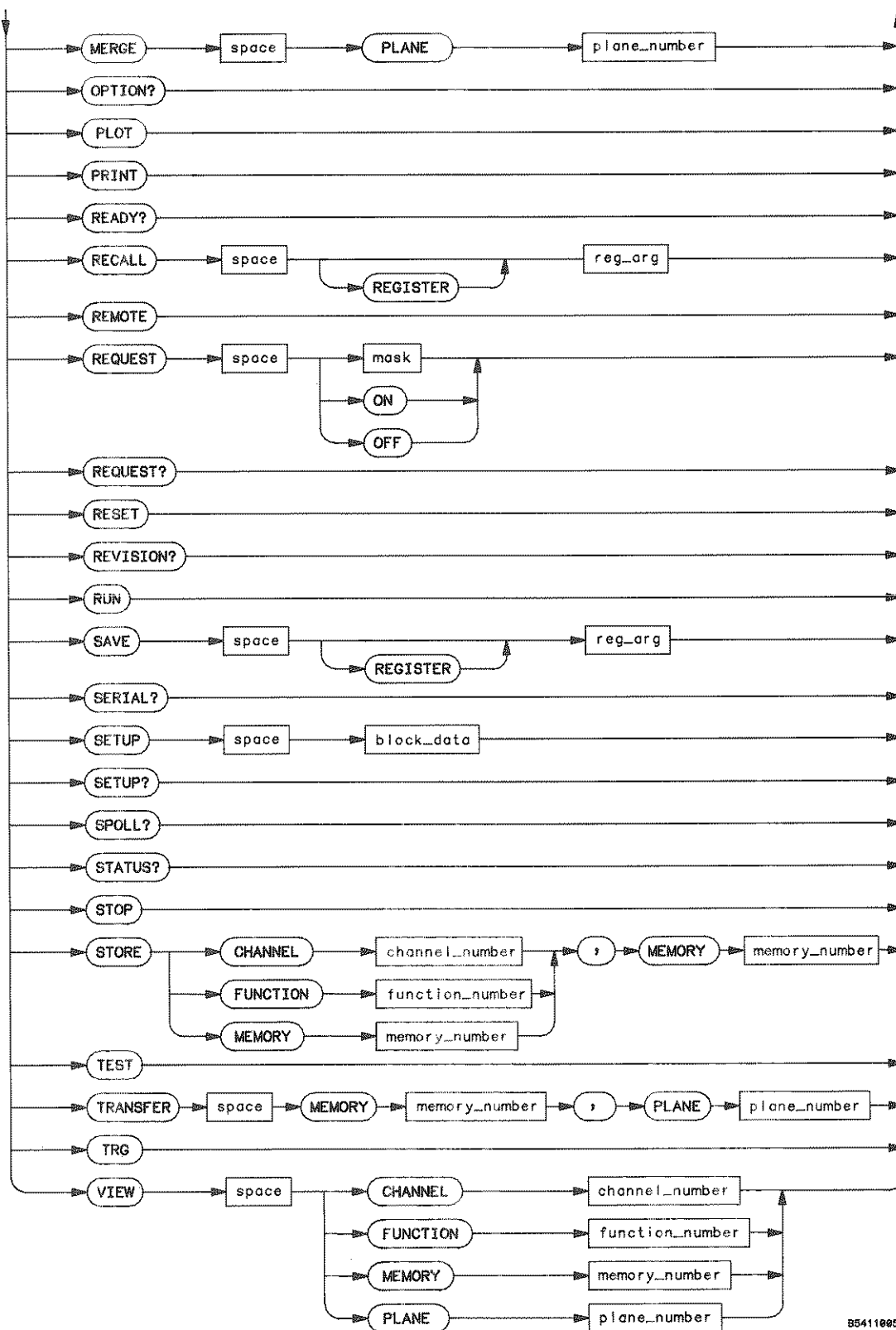

B5411005

Figure 10-2. System Commands

WHERE:

MENU_NUMBER = An integer from 1 to 14.

KEY_NUMBER = An integer from 1 to 63 (see table 10-3 for keycodes)

STRING_ARG = Any collection of ASCII characters excluding quotes, surrounded by quotes.

REG_ARG = An integer from 0-9.

MASK = An integer between 0 and 65535. This number is the sum of all the bits in the request mask corresponding to conditions that are to be enabled. See tables 10-1 and 10-2 for the bit definitions in the request mask.

BLOCK_DATA = A block of data in #A format as defined in IEEE Std 728-1982.

CHANNEL_NUMBER = An integer 1 or 2.

PLANE_NUMBER = An integer from 0 to 2.

MEMORY_NUMBER = An integer from 1 to 4.

FUNCTION_NUMBER = An integer 1 or 2.

Figure 10-2. System Commands (cont'd)

10-9. SYSTEM COMMANDS

System commands control HP-IB operations as well as the basic operation of the oscilloscope. They can be called at anytime and when the system command has been executed the unit will return to the subsystem that it was in before the system command was executed. Refer to Figure 10-2 for syntax of these commands.

ARGument

command/query

This command sets the output mode for the instrument's response to a query for commands that have both alpha and numerical arguments. If the alpha response is selected the arguments are returned in the alpha format and follow the same abbreviation rules as the commands. If the numeric response is selected the arguments are returned in the numeric format. This command does not affect the input data messages to the 54100A/D, that is, arguments maybe in either alpha or numeric form regardless of how the ARGUMENT command is set. The response to a query will be returned in the current argument mode.

(continued on next page)

ARGument (cont'd)

Command Syntax: ARGument { [ALPHa | 1]
[NUMeric | 0] }

Example: OUTPUT 707;"ARGUMENT NUMERIC"

Query Syntax: ARGument?

Returned Format: [ARGument]<argument><crlf>

Example: OUTPUT 707;"ARGUMENT?"
ENTER 707;Argument\$
PRINT Argument\$

AUToscale

command

The AUToscale command causes the instrument to automatically select the vertical sensitivity, vertical offset, trigger level and sweep speed for a display of the input signal. If input signals are present at both vertical inputs the sweep will be triggered on Chan 1 and the display will go to the split screen mode and the vertical sensitivity for each channel will be scaled appropriately. If only one of the vertical inputs has a signal on it, the split screen function will be turned off. See Supplemental Characteristics for input signal requirements for proper AUToscale operation.

When the AUToscale cycle is complete, the Timebase menu will be selected, the input devices will be assigned to the SEC/DIV and the unit will be in the Remote Listen mode.

Command Syntax: AUToscale

Example: OUTPUT 707;"AUTOSCALE"

BLANK

command

The BLANK command causes the instrument to turn off, (stop displaying), an active channel display, function, pixel memory or waveform memory. If you want to turn off an active display channel use the parameter **Channel 1|2**, if you want to turn off a pixel memory use the parameter **Plane 1|2**, where **plane 1 = pixel memory 5** and **plane 2 = pixel memory 6**.

Command Syntax: BLANK { [CHANnel { 1 | 2 }]
[PLANE { 1 | 2 }]
[FUNCTION { 1 | 2 }]
[MEMory { 1 | 2 | 3 | 4 }] }

Example: OUTPUT 707;"BLANK CHANNEL1"

CALibrate

command/query

This command sends a Cal String to the instrument. A Cal String consists of 24 8-bit bytes containing the Delay Calibration factors that are setup in the Cal Menu. These Cal factors are also saved during a front panel SAVE operation and are recalled during a front panel RECALL operation. The CALibrate query sends the Cal String to the controller using the same format as required by the CALibrate command. This means that no modification needs to be made to the string between the time that it is received from the instrument after the query and the time that it is sent back to the instrument.

Command Syntax: CALibrate<Cal String>

Example: OUTPUT 707;"CAL";Ca1\$

Query Syntax: CALibrate?

Returned Format; [CALibrate]<Cal String><crlf>

Example: DIM Ca1\$[24]
OUTPUT 707;"EOI ON; HEADER OFF"
OUTPUT 707;"CAL?"
ENTER 707 USING "-K";Ca1\$
OUTPUT 707;"CAL ";Ca1\$

CLEAR

command

The CLEAR command performs an operation similar to a Device Clear <DCL> or the Selected Device Clear<SDC>. The 54100A/D responds to the CLEAR message by:

1. Terminating all bus communications in process by untalking and unlistening.
2. Clearing all serial poll status bits.
3. Clearing the input and output buffers.
4. Clearing the error queue and key register.
5. Stopping any measurement or acquisition processes except the normal background acquire-display.

Command Syntax: CLEAR

Example: OUTPUT 707;"CLEAR"

DIGitize

command

This command is used to acquire waveform data for transfer over the HP-IB. It causes an acquisition to take place on the specified channel(s) with the resulting data being stored in the corresponding waveform memory i.e., channel 1 data is stored to waveform memory 1 etc. If ACQUIRE TYPE is ENVELOPE, minimum and maximum data for channel 1 will go in waveform memories 1 and 3 respectively. Similarly, minimum and maximum data from channel 2 will go into waveform memories 2 and 4. The ACQUIRE subsystem commands are used to setup conditions such as TYPE, COMPLETION criteria, number of POINTS and the average COUNT for the next DIGITIZE command. See the ACQUIRE subsystem for a description of these commands.

Command Syntax: DIGitize [CHANnel]{ 1 | 2 | 1,2 }

Example: OUTPUT 707;"DIGITIZE CHANNEL 1,2"

DSP

command/query

This command writes a string to the advisory line (line 15) on the CRT. The query returns the string last written to the advisory line. This may be a string written with a DSP command or an internally generated advisory.

Command Syntax: DSP<ASCII string>

Example: OUTPUT 707;"DSP""DIGITAL OSCILLOSCOPE"""

Query Syntax: DSP?

Returned Format: [DSP]<string><crlf>

Example: DIM Dsp\$[40]
OUTPUT 707;"DSP?"
ENTER 707;Dsp\$
PRINT Dsp\$

EOI

command/query

This command specifies whether or not the last byte of a reply from the 54100A/D is to be sent with the EOI bus control line set true or not. The query returns the current status of EOI.

Command Syntax: EOI {[ON | 1] | [OFF | 0]}

Example: OUTPUT 707;"EOI OFF"

Query Syntax: EOI?

Returned Format: [EOI]<argument><crlf>

Example: OUTPUT 707;"EOI?"
ENTER 707;Eoi\$
PRINT Eoi\$

ERASe

command

This command erases a specified display memory plane. Plane 1 is pixel memory 5. Plane 2 is pixel memory 6. Erasing plane 0 is the same as pressing the CLEAR DISPLAY front panel key. If the scope is running and being triggered and ERASe plane 0 is executed the instrument will momentarily stop acquiring data, clear the CRT and then continue with data acquisition.

Command Syntax: ERASe PLANE { 0 | 1 | 2 }

Example: OUTPUT 707;"ERASE PLANE 0"

ERRor?

query

The query causes the 54100A/D to output the next error number in the error queue over HP-IB. This instrument has an error queue that is 16 errors deep and operates on a first-in first-out basis. Successively sending the query, ERRor? returns the error numbers in the order that they occur until the queue is empty. Any further queries then return 0's until another error occurs. See Table 10-2 for a list of ERRor numbers.

Query Syntax: ERRor?

Returned Format: [ERRor]<NR1><crlf>

Example: OUTPUT 707;"ERRor?"
ENTER 707 USING "-K";Error\$
PRINT USING "K";Error\$

The error numbers and definitions below are the ones reported during an ERROR? query.

| ERROR NUMBER | DESCRIPTION |
|--------------|---------------------------------------|
| -100 | Unknown command |
| -101 | Invalid character received |
| -110 | Command header error |
| -119 | Command header expected |
| -120 | Numeric argument error |
| -121 | Numeric data expected |
| -123 | Numeric overflow |
| -125 | Numeric syntax error |
| -130 | Non-numeric argument error |
| -131 | Character data expected |
| -132 | String data expected |
| -133 | Block data (binary data) expected |
| -134 | String length error |
| -135 | Block length error |
| -142 | Too many arguments |
| -143 | Argument delimiter error |
| -144 | Message unit delimiter error |
| -149 | Missing argument |
| -150 | Query expected |
| -151 | Query not allowed |
| -201 | Command not executable in local mode |
| -202 | Setting lost on power up |
| -211 | Settings conflict |
| -212 | Argument out of range |
| -222 | Insufficient capability/configuration |
| -230 | Transmission aborted |
| -231 | Input buffer full or overflow |
| -233 | Output buffer empty |
| -301 | Interrupt fault |
| -302 | System error |
| -311 | RAM failure (hard error) |
| -312 | RAM data loss (soft error) |
| -321 | ROM checksum error |
| -340 | Self test failed |
| -350 | Timer error |
| -360 | Analog hardware error |
| -370 | Digital hardware error |
| -399 | Power supply failure |

Table 10-3. Error Numbers

Positive error numbers are reported after a Self Test Failed error (-340). These refer to the internal self test loops that failed to pass self test.

HEADER

command/query

This command sets the command echo mode for query responses. When HEADER is set to ON query responses will include the command header. The query form of this command tells you whether the echo mode is ON or OFF.

Command Syntax: HEADER {[OFF | 0] [ON | 1] }

Example: OUTPUT 707;"HEADER ON"

Query Syntax: HEADER?

Returned Format: [HEADER]<argument><crlf>

Example: OUTPUT 707;"HEADER?"
ENTER 707;Header\$
PRINT Header\$

ID?

query

This query returns the instrument model number, 54100A/D.

Query Syntax: ID?

Returned Format: [ID]<54100A/D><crlf>

Example: DIM Id\${10}
OUTPUT 707;"ID?"
ENTER 707;Id\$
PRINT Id\$

KEY

command/query

This command simulates the pressing of a specified front panel key. Keys may be pressed over the HP-IB in any order that is legal from the front panel. Use caution to insure that the instrument is in the desired mode before executing the KEY command. The query returns the key code for the last key pressed over the HP-IB. Key codes range from 1 to 63 with 0 representing no key (returned after power-up). See table 10-3 for a list of key codes.

Command Syntax: KEY<keycode>

Example: OUTPUT 707;"KEY 48"

Query Syntax: KEY?

Example: OUTPUT 707;"KEY?"
ENTER 707;Key\$
PRINT Key\$

| KEY | KEYCODE | KEY | KEYCODE |
|-------------------|---------|---------------|---------|
| Menu Select 1 | 1 | "-(minus) | 23 |
| Menu Select 2 | 2 | 0 | 24 |
| Menu Select 3 | 3 | 1 | 25 |
| Menu Select 4 | 4 | 2 | 26 |
| Menu Select 5 | 5 | 3 | 27 |
| Menu Select 6 | 6 | 4 | 28 |
| Menu Select 7 | 8 | 5 | 29 |
| Menu Select 8 | 9 | 6 | 30 |
| Function Select 1 | 15 | 7 | 31 |
| Function Select 2 | 14 | 8 | 32 |
| Function Select 3 | 13 | 9 | 33 |
| Function Select 4 | 12 | CLEAR DISPLAY | 40 |
| Function Select 5 | 11 | RUN | 41 |
| Function Select 6 | 10 | STOP/SINGLE | 42 |
| sec/Volt | 16 | SAVE | 43 |
| msec/mV | 17 | RECAL | 44 |
| μ sec | 18 | LOCAL | 45 |
| nsec | 19 | AUTOSCALE | 48 |
| psec | 20 | ↑→ | 56 |
| CLEAR | 21 | ←↓ | 63 |
| ."(decimal pt.) | 22 | no key | 0 |

NOTE

The Menu Select Keys are located at the bottom of the screen with menu select 1 at the lower left of the screen. The Function Select Keys are located at the right of the screen with function select 1 located at the upper right of the screen.

Table 10-4. 54100A/D Front Panel Key Codes

LOCAL**command**

This command performs a similar operation to the Clear Lockout/Set Local message. It is provided for controllers with limited HP-IB control capability. The HP-IB Clear Lockout/Set Local Message is the preferred method of switching the instrument from Remote to Local and clearing the Local Lockout. See paragraphs 9-6 and 9-18 for more information.

Command Syntax: LOCAL

Example: OUTPUT 707;"LOCAL"

LONGform**command/query**

This command sets the longform for the instrument's responses to queries. If the LONGform command is set OFF command headers and alpha arguments are sent from the 54100A/D in the abbreviated form. If the LONGform command is set ON the whole word will be output. This command does not affect the input data messages to the 54100A/D -- headers and arguments may be input to the 54100A/D in either the long or short form regardless of how the LONGform command is set. The query returns the status of the LONGform command.

Command Syntax: LONGform { [OFF | 0]
[ON | 1] }

Example: OUTPUT 707;"LONG 1"

Query Syntax: LONGform?

Returned Format: [LONGform]<argument><crlf>

Example: OUTPUT 707;"LONGFORM?"
ENTER 707;Long\$
PRINT Long\$

MENU

command/query

This command allows you to select one of the 14 menus on the front panel. The Query returns the current menu.

Command Syntax: MENU {[1] -Channel 1
 [2] -Channel 2
 [3] -Timebase
 [4] -Trigger
 [5] -Display
 [6] -Delta V
 [7] -Delta t
 [8] -Waveform Save
 [9] -Waveform Math
 [10] -Measurements
 [11] -Plot
 [12] -Print
 [13] -Probes
 [14] }

Example: OUTPUT 707;"MENU 4"

Query Syntax: MENU?

Returned Format: [MENU] <menu #><crlf>

Example: OUTPUT 707;"MENU?"
 ENTER 707;Menu\$
 PRINT Menu\$

MERGE

command

This command stores the contents of the active display to the specified pixel memory. Where plane 1 = pixel memory 5 and plane 2 = pixel memory 6.

Command Syntax: MERGE {[PLANE1 | PLANE2]}

Example: OUTPUT 707;"MERGE PLANE2"

OPTion?

query

This query returns a list of options that are installed on your instrument. If no options are installed a "0" will be returned. (There are currently no internal options for the 54100A/D.)

Query Syntax: OPTion?

Returned Format: [OPTion] <0><crlf>

```
Example: OUTPUT 707;"OPT?"
         ENTER 707;Opt$
         PRINT Opt$
```

PLOT

command

This command causes the 54100A/D to make a hardcopy dump of the display and/or the waveform memories to an HPGL compatible plotter as soon as the oscilloscope is next addressed to talk. The context of the output is controlled with the programming commands in the HARDCOPY subsystem, paragraph 10-15. Refer to Section 8 for a partial list of compatible plotters.

Command Syntax: PLOT

Example:

```
CLEAR 707           ! Clear interface buffers.
OUTPUT 707;"PLOT"   ! Starts print buffer.
SEND 7;UNT UNL     ! Clears bus and
!                 ! sets ATN line at controller true.
SEND 7;LISTEN 5    ! Sets plotter at address 5 to listen.
SEND 7;TALK 7      ! Sets 54100A/D to talk mode.
SEND 7;DATA        ! Sets ATN line at controller false so
!                 ! so data can be transferred.
WAIT 50            ! Wait 50 seconds for transfer to complete
```

NOTE

When programming the 54100A/D use the SRQ capabilities to determine if the transfer is complete. Attempting to program the instrument while making a hardcopy dump will cause errors.

PRINT

command

This command causes the 54100A/D to make a hardcopy dump of the display and/or waveform memories in a format compatible with the HP RASTER GRAPHICS STANDARD when the oscilloscope is next addressed to talk. The content of the hardcopy dump is controlled with programming commands in the HARDCOPY subsystem, paragraph 10-15.

Command Syntax: PRINT

Example:

```
CLEAR 707           ! Clears interface buffers.
OUTPUT 707;"PRINT"  ! Starts print buffer.
SEND 7;UNT UNL      ! Clears bus, sets ATN line at controller true.
SEND 7;LISTEN 1     ! Sets printer at address 1 to listen
SEND 7;TALK 7       ! Sets the 54100A/D to talk mode.
SEND 7;DATA         ! Sets ATN line at controller to false
!                   ! so data can be transferred.
WAIT 25             ! Wait 25 seconds for transfer to finish.
```

NOTE

When you are programming the 54100A/D use the SRQ capabilities to determine if the transfer is complete. Attempting to program this instrument while making a hardcopy dump will cause errors.

READY? | RDY?

query

This query returns the ready byte (the upper byte of the status word). See Table 10-2.

Query Syntax: { READY | RDY }?

Returned Format: [READY]<NR1><crlf>

```
Example: OUTPUT 707;"READY?"
         ENTER 707;Ready$
         PRINT Ready$
```

RECall

command

This command recalls an instrument setup from a specified save-recall register.

Command Syntax: RECa11[REGISTER]<d>

Example: OUTPUT 707;"RECALLO"

REMOTE

command

This command performs a similar operation as a Remote message followed by a Local Lockout message. It is provided for use by controllers that have a limited HP-IB control capability. The HP-IB Remote and Local Lockout messages are the preferred method of switching the instrument from Local to Remote and invoking Local Lockout. Refer to paragraphs 9-17 and 9-20. If the REN line is false, the REMOTE command will have no effect.

Command Syntax: REMOTE

Example: OUTPUT 707;"REMOTE"

REQuest | RQS

command/query

The REQuest command sets the request mask (RQS mask). The request mask is a 16 bit integer that determines what combinations of bits in the status register set the ready flag and/or generate a require service message. Setting a bit in the request mask to a 1 enables its corresponding condition in the instrument status word. See paragraph 10-8 and Tables 10-1 and 10-2 for a complete description of the bits in the request mask.

Another form of this command allows you to follow the REQUEST command with ON or OFF. This command enables or disables the ability of the 54100A/D to generate the require service message without changing the request mask. Any unmasked conditions that occur with REQUEST OFF will be saved until the REQUEST ON command is received. At that time, unmasked conditions that occurred before and after the REQUEST ON command will generate the require service message.

Command Syntax: { REQuest | RQS }
{ ON | OFF | SRQ enable code }

Example: OUTPUT 707;"REQUEST 36"

Query Syntax: { REQuest | RQS }?

Returned Format: [REQuest]<SRQ enable code><crlf>

Example: OUTPUT 707;"REQUEST?"
ENTER 707;Request\$
PRINT Request\$

RESet | RST

command

This command presets the instrument to default settings. These settings are the same as those established during a key down power up. See Table 10-5 for a list of the default conditions.

Command Syntax: {RESet | RST}

Example: OUTPUT 707;"RST"

REVision?

query

This query returns an integer corresponding to the revision date of the internal firmware.

Query Syntax: REVision?

Example: OUTPUT 707;"REV?"
ENTER 707;Rev\$
PRINT Rev\$

RUN

command

This command causes the instrument to acquire data for the active waveform display on the CRT based on the timebase mode. If the time base mode is in SINGLE, the RUN command will cause the instrument to enable the trigger once and display the data it acquires on the active on the CRT. This is the same thing that happens when the front panel STOP/SINGLE key is pressed when the instrument is STOPPED. If the timebase mode is AUTO or TRIGGERED, the RUN command will cause the instrument to enable the trigger repeatedly and display the data it acquires continuously on the display. This is the same thing that happens when the front panel RUN key is pressed. See the TIMEbase MODE command for a description of the various modes.

Command Syntax: RUN

Example: OUTPUT 707;"RUN"

RESET CONDITIONS FOR THE 54100A/D

| | |
|---|--|
| Ch1/Ch2 Mode | •Normal |
| Ch1/Ch2 Display | •On |
| Ch1/Ch2 Volts/div. | •1.0 volts/div |
| Ch1/Ch2 Offset | •0.0 volts |
| Ch1/Ch2 Magnify | •Off |
| Ch1/Ch2 Magnify Window Size | •7.0 volts |
| Ch1/Ch2 Magnify Window Position | •0.0 volts |
| Seconds/div | •1.0 μ s/div |
| Delay | •0.0 sec |
| Delay Reference | •Center Screen |
| Auto/Triggered Sweep | •Auto |
| Trigger Mode | •Edge |
| Trigger Source (edge mode) | •Channel 1 |
| Trigger Level (all sources) | •0.0 volts |
| Trigger Slope (all sources) | •Positive |
| Holdoff Mode (edge mode) | •Time |
| Holdoff Events (edge mode) | •2 |
| Holdoff Time (edge mode) | •70.0ns |
| Trigger Pattern(pattern mode) | •Ch1; High •Ch2; Dontcare •Trig3; Dontcare •Trig4; Dontcare |
| Pattern Edge (pattern mode) | •Entering |
| Holdoff Mode (pattern mode) | •Time |
| Holdoff Time (pattern mode) | •70.0ns |
| Holdoff Events (pattern mode) | •2 |
| Display Mode | •Normal |
| Display Time/Persistence | •0.5s |
| Number of Averages | •8 |
| Split Screen | •Off |
| Graticule | •Axes |
| Completion Criteria (For HP-IB DIGitize command) | •100% |
| Voltage Markers | •Off |
| Marker1 Position | •-2.5 volts |
| Marker2 Position | •+2.5 volts |
| Topbase Reference | •100% |

Table 10-5. Reset Conditions