User and Service Guide

Publication Number 54645-97012
December 1997 (pdf version Nov 1998)

For Safety Information, Warranties, and Regulatory information,
see the pages behind the Index.

© Copyright Hewlett-Packard Company 1996-1997
All Rights Reserved



HP 54645A Oscilloscope and HP 54645D Mixed-Signal Oscilloscope

The HP 54645A/D at a Glance

Display shows current input signals

- Eighteen (18) channels in main mode; 2 scope and 8 timing channels in delayed mode (HP 54645D)
- Indicators for peak, avg, or normal acquisition, time base, channel activity, trigger and acquisition status
- Softkey labels
- Measurement results

Channel Controls select, position, and label inputs

- Turn channels on or off individually or in groups of 8 (HP 54645D)
- Rearrange order of channels to group related signals (HP 54645D)
- Create and display labels to identify channels (HP 54645D)

General Controls measure, save and restore results, and configure the oscilloscope

- Make automatic time and frequency measurements
- Use cursors to make manual measurements
- Save or recall measurement configurations or previous results
- Autoscale performs simple one-button setup of the oscilloscope

Horizontal Controls select sweep speed and delay parameters

- Sweep speeds from 5 ns to 50 s/div (2 ns to 50s/div for HP 54645A)
- Delay control moves waveform display to point of interest
- Delayed mode and delay allow zooming in to show a portion of waveform in detail (split screen)

Storage Keys begin and end data acquisition

- Run/Stop starts and stops continuous acquisitions
- Single performs one acquisition
- Autostore accumulates and displays the results of multiple acquisitions
- Erase clears the current acquisition and all accumulated data

Trigger Keys define what data the oscilloscope will trigger on

- Source key (HP 54645A) allows conventional oscilloscope triggering
- Edge mode allows triggering on a positive or negative edge of any single channel (HP 54645A/D)
- Pattern mode allows triggering on a pattern of channels either high, low, or don't care, with an optional single edge qualifier (HP 54645D)
- Advanced mode allows sequential triggers, combined patterns, patterns and edges, pattern durations, glitch (HP 54645A/D), and TV (HP 54645D)

Softkeys extend the functionality of command keys

Select measurement types, operating modes, trigger specifications, label data, and more

Channel Inputs through a flexible probing system

- Sixteen channels through a dual 8-channel cable with micro-grabbers (HP 54645D)
- Set logic levels as TTL, CMOS, ECL, or to a user-definable voltage (HP 54645D)

In This Book

This manual will guide you in using and servicing the HP 54645A Oscilloscope and the HP 54645D Mixed-Signal Oscilloscope. This manual is organized in chapters as shown in the bleeder tab titles to the right.

1	Getting Started	
2	Front-Panel Overview	
3	Triggering HP 54645A/D Oscilloscopes	
4	MegaZoom Concepts and Oscilloscope Operation	
5	Making Measurements with HP 54645A/D Oscilloscopes	
6	Using Option 005 Enhanced TV/Video Trigger	
7	Testing, Adjusting, and Troubleshooting	
8	Replacement Parts	
9	Performance Characteristics	
10	Messages	
	Glossary	
	Index	

Contents

1 Getting Started

Preparing the Oscilloscope 1-4

Check package contents 1-5

Adjust the handle 1-9



Connect the cables 1-9

Power-on the oscilloscope 1-10

Using the digital probes to probe a circuit 1-11

Using the oscilloscope probes 1-13

Adjust display brightness 1-13

2 Front-Panel Overview

Important Oscilloscope Considerations 2-2

HP 54645A/D Front Panels 2-6

Description of Front-Panel Areas 2-8

Front-Panel Operation 2-16

To use oscilloscope channels to view a signal 2-17

To use digital channels to view a signal 2-18

To display signals automatically using Autoscale 2-19

To apply the default factory configuration 2-20

To adjust oscilloscope vertical scaling 2-21

To turn analog channels on and off 2-24

To rearrange the analog channels 2-24

To turn digital channels on and off (HP 54645D) 2-25

To rearrange the digital channels (HP 54645D) 2-26

To operate the time base controls 2-27

To start and stop an acquisition 2-28

To use the Entry and Select knobs 2-29

To make cursor measurements 2-30

To use delayed sweep 2-32

To modify the graticule 2-33

To print the display 2-34

3 Triggering HP 54645A/D Oscilloscopes

Selecting Trigger Modes and Conditions 3-3

To select a trigger mode: Auto Lvl, Auto, Normal 3-3

To use holdoff 3-5

To trigger on a complex waveform 3-6

Triggering the HP 54645A Oscilloscope 3-7

To use external triggering 3-7

To trigger on an edge 3-8

To use glitch triggering 3-9

To use line triggering 3-10

To use TV triggering 3-10

Triggering the HP 54645D Mixed-Signal Oscilloscope 3-11

Trigger types 3-12

To define an edge trigger 3-16

To use line triggering 3-16

To define a pattern trigger 3-17

To use glitch triggering 3-18

To define an advanced pattern trigger 3-19

4 MegaZoom Concepts and Oscilloscope Operation

MegaZoom Concepts 4-3

Deep Memory 4-4

Oscilloscope Responsiveness 4-5

Display Update Rate 4-6

Display Modes 4-7

Pan and Zoom 4-18

Recovering the waveform on the screen 4-21

Changing the time reference position 4-22

Run/Stop/Single/Autostore/Erase Operation 4-29

Acquiring Data 4-30

Memory Depth/Record Length 4-31

To run and stop an acquisition 4-33

To take a single trace 4-33

To capture a single event 4-34

To use Autostore 4-36

To Autostore Multiple Single Events 4-37

To erase the waveform display 4-38

Using Digital Channels to Probe Circuits 4-39

Saving and Recalling the Configuration 4-43

Using memories to save and recall configurations 4-43

To save, recall, and clear traces 4-46

To save or recall front-panel setups 4-48

To reset the HP 54645A/D instrument setup 4-48

Configuring the Mixed-Signal Oscilloscope 4-51

To change the logic threshold for input signals 4-51

Using Labels on the Mixed-Signal Oscilloscope 4-53

To turn the label display on or off 4-53

To assign a predefined label to a channel 4-54

To define a new label 4-56

To initialize the label list 4-58

5 Making Measurements with HP 54645A/D Oscilloscopes

Capturing Data 5-3

To use delayed sweep 5-4

To view asynchronous noise on a signal 5-6

To reduce the random noise on a signal 5-8

To capture glitches or narrow pulses with peak detect 5-11

To use channel math 5-12

To use the Roll display mode 5-13

Contents

To use the XY display mode 5-14

To analyze video waveforms 5-18

Measuring Waveform Data 5-22

To make cursor measurements 5-22

To make frequency measurements automatically 5-26

To make time measurements automatically 5-28

To make voltage measurements automatically 5-32

6 Using Option 005 Enhanced TV/Video Trigger (HP 54645A)

To autoscale on a video signal 6-4

To trigger on a specific line of video 6-5

To trigger on all TV line sync pulses 6-7

To trigger on a specific field of the video signal 6-8

To trigger on all fields of the video signal 6-9

To trigger on odd or even fields 6-10

To analyze video waveforms with Option 005 6-12

7 Testing, Adjusting, and Troubleshooting

Testing, Adjusting, and Troubleshooting 7-2

Solving Problems with HP 54645A/D Oscilloscopes 7-3

If there is no trace display 7-4

If the trace display is unusual or unexpected 7-5

If you can't see a channel 7-5

If you can't get any response from the oscilloscope 7-6

Getting Service 7-7

To return the oscilloscope to Hewlett-Packard 7-8

Verifying Oscilloscope Performance 7-9

To construct test connectors for digital channels 7-9

To test the digital channels 7-11

Testing Threshold Accuracy 7-12

- To set up and connect the equipment 7-13
- To verify threshold accuracy 7-14
- To check the output of the CALIBRATOR 7-15
- To verify voltage measurement accuracy 7-16
- To verify bandwidth 7-19
- To verify horizontal Δt and $1/\Delta t$ accuracy 7-22
- To verify trigger sensitivity 7-24
- To verify vertical output on Option 005 7-27

Adjusting the Oscilloscope 7-29

- To adjust the power supply 7-30
- To perform the self-calibration 7-33
- To adjust the low-frequency compensation 7-35
- To adjust the high-frequency pulse response 7-36
- To adjust the display 7-38
- To adjust the Option 005 offset (R15) (HP 54645A) 7-40

Troubleshooting the Oscilloscope 7-41

- To construct your own dummy load 7-42
- To check out the oscilloscope 7-43
- To clear error messages 7-46
- To check the Low Voltage Power Supply 7-48
- To run the internal self-tests 7-50
- To troubleshoot Option 005 7-52

8 Replacement Parts

Removing and Replacing Assemblies 8-3

- To remove the cabinet 8-4
- To remove the fan 8-4
- To remove the front panel 8-5
- To remove the display 8-6
- To remove the system board 8-6
- To remove the front-panel BNC connectors 8-7

Contents

To remove the power supply 8-8
To remove the keyboard 8-9
To remove the handle 8-9
Replacing the Option 005 board 8-10

Replaceable Parts 8-11

To order a replacement part 8-12

9 Performance Characteristics



HP 54645A/D Oscilloscopes 9-3
HP 54645D Digital Channels 9-4
HP 54645A/D Oscilloscope Digitizing System 9-5
HP 54645D Logic Digitizing System 9-5
HP 54645A/D Time Base 9-6



HP 54645A/D Oscilloscope Trigger System 9-7
HP 54645A Oscilloscope Trigger System 9-8
HP 54645D Mixed-Signal Oscilloscope Trigger System 9-8
HP 54645A/D Setup Functions 9-9
HP 54645A/D Power Requirements 9-9
HP 54645A/D General Characteristics 9-10
Option 005 General Performance Characteristics 9-11
Option 005 Trigger System 9-11

10 Messages

Messages 10-3

Glossary

Index



Getting Started

Getting Started

When you use the HP 54645A/D Oscilloscopes to help test and troubleshoot your systems, you will do the following:

- Prepare the oscilloscope by connecting it to power and setting up the handle and screen brightness as desired.
- Define the measurement problem by understanding the parameters of the system you wish to test and the expected system behavior.
- Set up channel inputs by connecting the probes to the appropriate signal and ground nodes in the circuit under test.
- Define the trigger to reference the waveform data to a specific event of interest.
- Use the oscilloscope to acquire data, either in continuous or single-shot fashion.
- Examine the data and make measurements on it using various features.
- Save the measurement or configuration for later re-use or comparison with other measurements.

Repeat the process as necessary until you verify correct operation or find the source of the problem.

MegaZoom Technology Operates with Untriggered Data

With the MegaZoom technology built into the HP 54645A/D, you can operate the oscilloscope with untriggered data. All you do is press Run or Single while in Auto trigger mode, then examine the data to set up a trigger.

The HP 54645A/D high-speed display can be used to isolate infrequently changing signals. You can then use the characteristics of these signals to help refine the trigger specification. See figure 1-2 below. For more information on triggering, data acquisition, data examination and measurement, and configuration, see chapters 3 and 4.

Figure 1-1

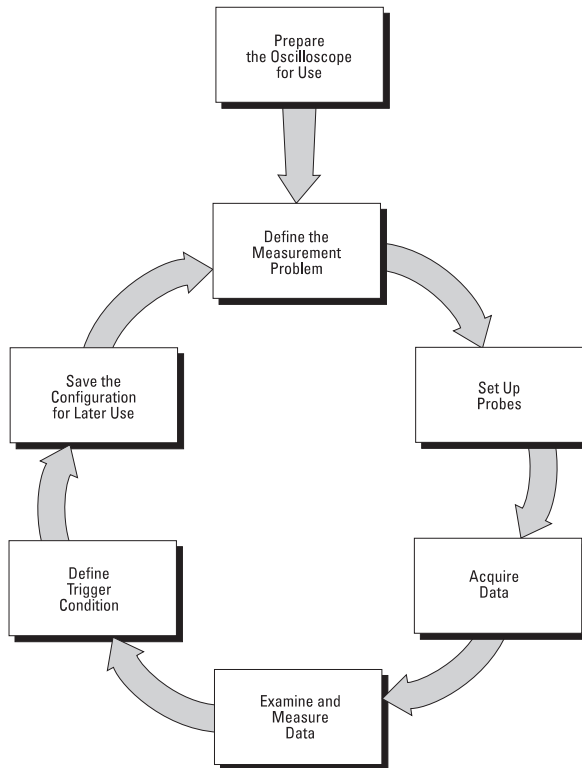
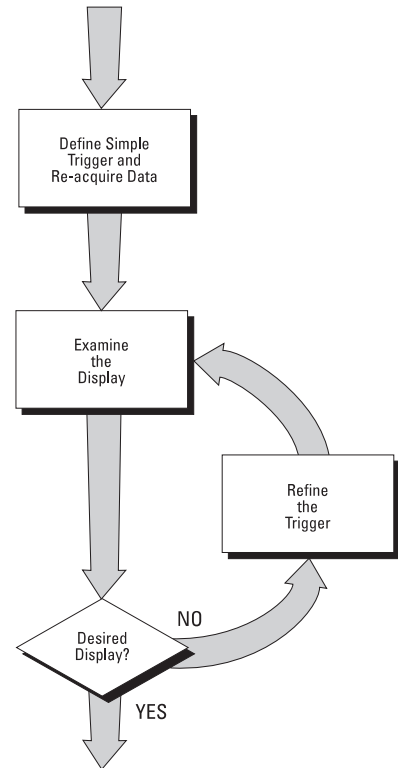

Figure 1-2



Using the HP 54645A/D Oscilloscopes, and Refining the Trigger Specification

Preparing the Oscilloscope

To prepare your HP 54645A Oscilloscope or HP 54645D Mixed-Signal Oscilloscope for use, you need to do the following tasks. After you have completed them, you will be ready to use the oscilloscope.

In the following topics you will:

- Check package contents
- Adjust the handle
- Connect the cables
- Power-on the oscilloscope
- Use the digital probes to probe a circuit (with HP 54645D)
- Use the oscilloscope probes
- Adjust display brightness

Check package contents

- Verify that you received the following items and any optional accessories in the HP 54645A/D packaging.

If anything is missing, contact your nearest Hewlett-Packard Sales Office. See figure 1-3. If the shipment was damaged, contact the carrier, then contact the nearest Hewlett-Packard Sales Office.

Accessories Supplied

Power cord (see the following table)
HP 54620-61801 16-channel probe cable (HP 54645D only)
HP 10074A 1.5-meter, 10:1 Probe with readout (qty 2)
HP 5090-4356 grabbers (in resealable plastic bag; qty 20)
(HP 54645D only—supplied with 16-channel cable)
HP 5959-9334 2" ground lead set (qty 5)
(HP 54645D only—supplied with 16-channel cable)
HP 54645A/D User & Service Guide
HP 54645A/D Programmer's Guide
HP 54645A/D Programmer's Reference (3.5" diskette)
(disk is packaged with Programmer's Guide)
1252-7310 Banana ground plug (for HP 54645D)

Options Available

Option 001 RS-03 Magnetic Interference Shielding Added to CRT
Option 002 RE-02 Display Shield Added to CRT
Option 101 Accessory Pouch and Front-Panel Cover
Option 103 Operator's Training Kit (HP 54654A)
Option 104 Carrying Case (HP 5041-9409)
Option 106 BenchLink Software (HP 34810B)
Power Cords (see the following table or the
"Replacement Parts" chapter)

Accessories Available

HP 54650A HP-IB Interface Module
HP 54652B RS-232/Parallel Interface Module
HP 54654A Operator's Training Kit
HP 54657A Meas./Storage Module (HP-IB)
HP 54659B RS-232/Parallel/Meas./Storage Module
HP 34810B BenchLink Software for Windows
HP 5041-9409 Carrying Case
HP 5062-7345 Rackmount Kit
HP 10070A 1.5-meter, 1:1 Probe
HP 10100C 50- Ω Termination

Getting Started
Check package contents

Figure 1-3

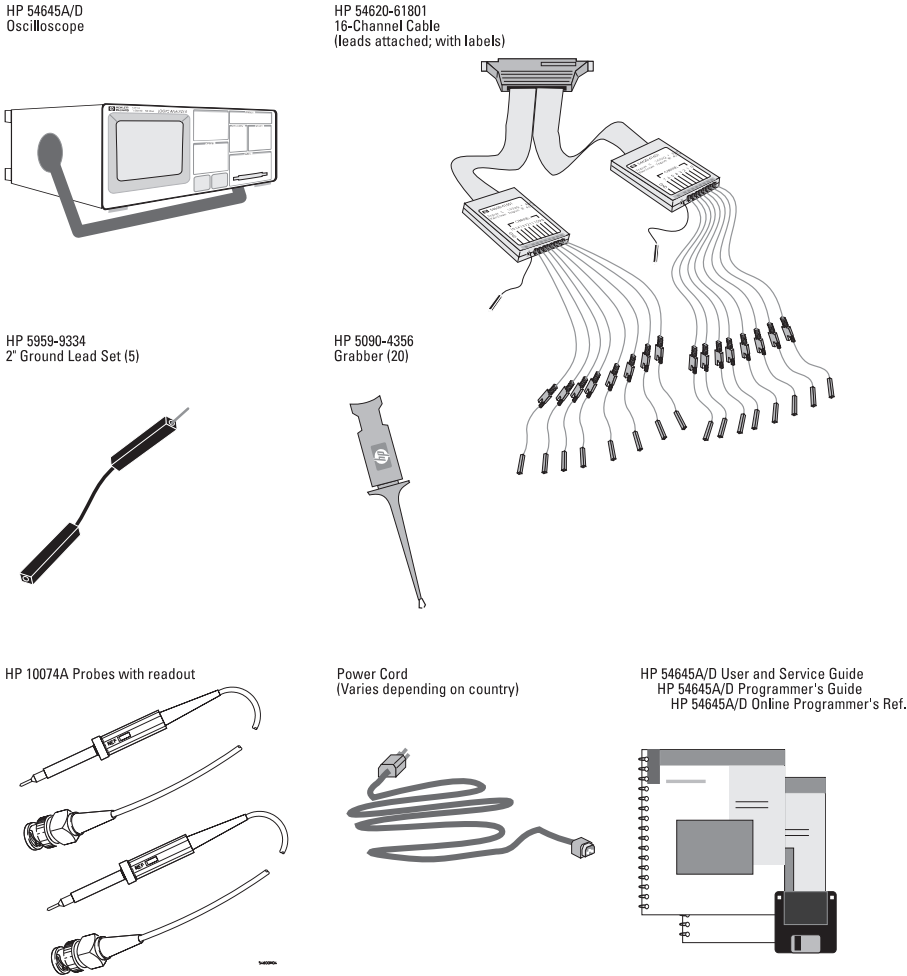

Items Supplied with the HP 54645A/D Oscilloscopes

Figure 1-4

Option 101
Accessory Pouch and Front Panel Cover

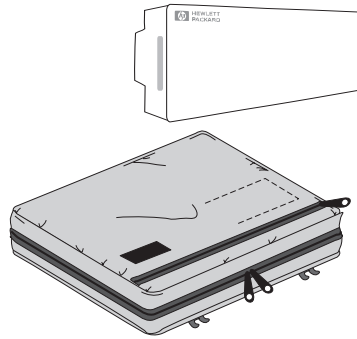

Option 103
HP 54654A Self-Paced Training Kit

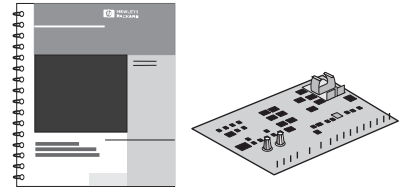

Option 104
Carrying Case

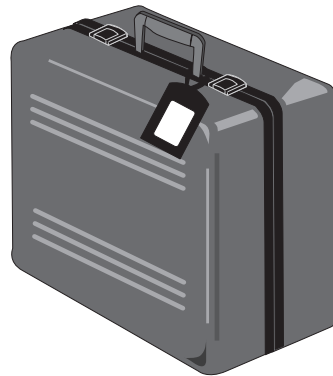

Option 106
BenchLink/Scope Software for Microsoft Windows











Optional Accessories for the HP 54645A/D Oscilloscopes

Getting Started
Check package contents

Table 1-1

Power Cords

Plug Type		Cable Part No.	Plug Description	Length in/cm	Color
Opt 903 (U.S.A.) 124V **		8120-1378	Straight (NEMA5-15P*)	90/228	Jade Gray
Opt 900 (U.K.) 250V		8120-1351	Straight (BS136A*)	90/228	Gray
Opt 901 (Australia) 250V		8120-1369	Straight (NZSS198/ASC*)	79/200	Gray
Opt 902 (Europe) 250V		8120-1689 8120-2857	Straight (CEE7-Y11*) Straight (Shielded)	79/200 79/200	Mint Gray Coco Brown
Opt 906 (Switzerland) 250V		8120-2104	Straight (SEV1011*)	79/200	Mint Gray
Opt 912 (Denmark) 220V		8120-2957	Straight (DHCK107*)	79/200	Mint Gray
Opt 917 (Africa) 250V		8120-4600	Straight (SABS164)	79/200	Jade Gray
Opt 918 (Japan) 100V		8120-4753	Straight Miti	90/230	Dark Gray

* Part number shown for plug is industry identifier for plug only.

Number shown for cable is HP part number for complete cable including plug.

** These cords are included in the CSA certification approval for the equipment.

Adjust the handle

- 1 Grasp the handle pivot points on each side of the instrument and pull the pivot out until it stops.

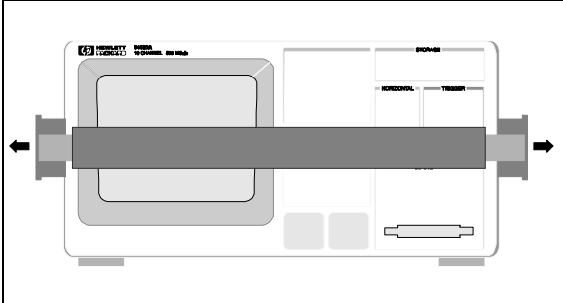

- 2 Without releasing the pivots, swivel the handle to the desired position. Then release the pivots.

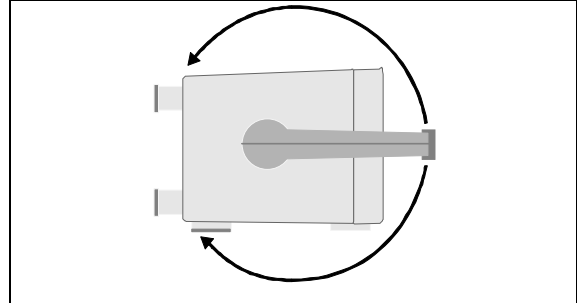

Connect the cables

- 1 Check to ensure that you received everything that is supplied with the oscilloscope.
- 2 Connect the oscilloscope to power and turn it on.
- 3 Connect the cables:

If you are using this model:

HP 54645A Oscilloscope

HP 54645D Mixed-Signal Oscilloscope

Do this:

Connect the oscilloscope probe cables to oscilloscope channels 1 and 2.

Connect the oscilloscope probe cables to oscilloscope analog channels A1 and A2.

Connect the digital probe cable to oscilloscope digital channels D0-D15.

- 4 Then, connect the scope and/or digital probes to the circuit of interest. Be sure to connect the ground leads.

You can use the front-panel calibration point as a stimulus while learning to use the oscilloscope.





Power-on the oscilloscope

- 1 Connect the power cord to the rear of the HP 54645A/D, then to a suitable ac voltage source.

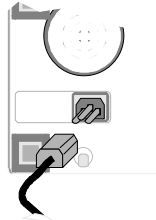

The HP 54645A/D power supply automatically adjusts for input line voltages in the range 100 to 240 VAC. Therefore, you do not need to adjust the input line voltage setting. The line cord provided is matched by HP to the country of origin. Ensure that you have the correct line cord. See table 1-1.

- 2 Press the power switch.

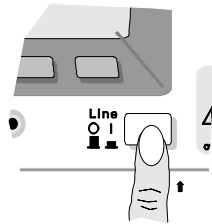

The HP 54645A/D performs a self-test, then shows the display. The instrument is ready to use.

Using the digital probes to probe a circuit

- 1** If you feel it's necessary, turn off the power supply to the circuit under test.

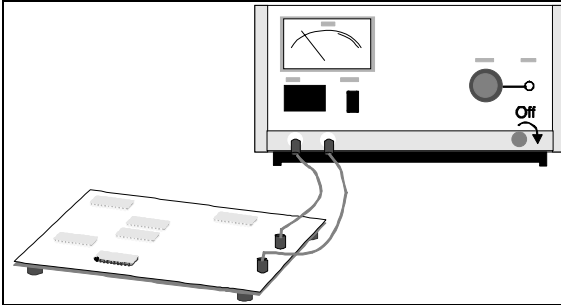

Turning off power to the circuit under test would only prevent damage that might occur if you accidentally short two lines together while connecting probes. You can leave the HP 54645A/D powered on because no voltage appears at the probes.

- 2** Connect the digital probe cable to HP 54645D. The digital probe cable is indexed so you can connect it only one way. You do *not* need to power-off the HP 54645A/D.

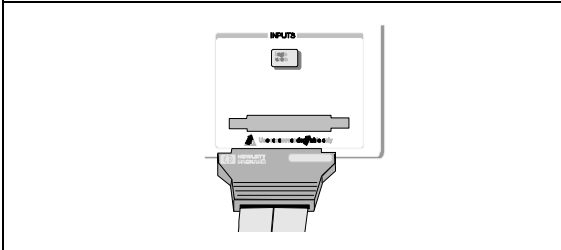

- 3** Connect a grabber to one of the probe leads. Be sure to connect the ground lead. (Other probe leads are omitted from the figure for clarity.)

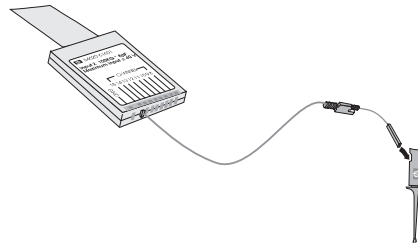

- 4** Connect the grabber to a node in the circuit you want to test.

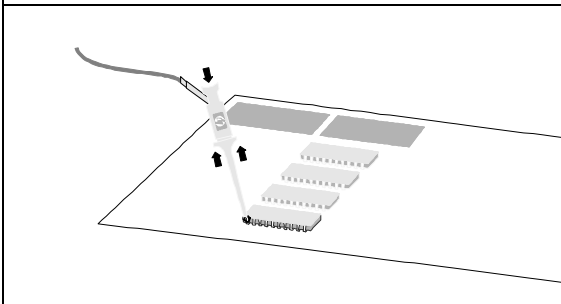

- 5** For high-speed signals, connect a ground lead to the probe lead, connect a grabber to the ground lead, and attach the grabber to ground in the circuit under test.

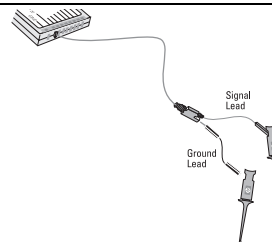

Getting Started

Using the digital probes to probe a circuit

6 Connect the ground lead on each set of channels, using a probe grabber. The ground lead improves signal fidelity to the instrument, ensuring accurate measurements.

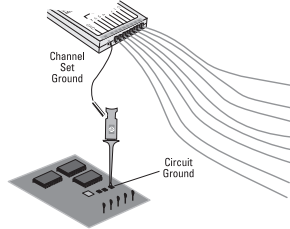

7 Repeat steps 3 through 6 until you have connected all points of interest.

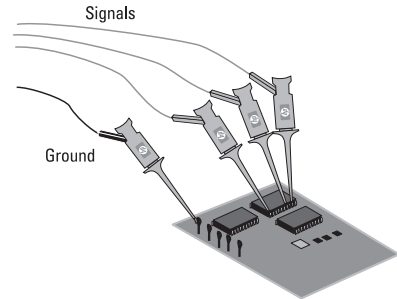

8 If you need to remove a probe lead from the cable, insert a paper clip or other small pointed object into the side of the cable assembly, and push to release the latch while pulling out the probe lead.

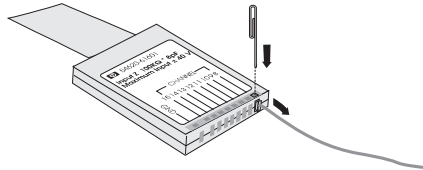

Replacement parts are available. See the “Replacement Parts” chapter for details.

Using the oscilloscope probes

- 1 Connect the HP 10074A 1.5-meter, 10:1 oscilloscope probe BNC connector to the channel 1 or 2 input on the HP 54645A or to channel A1 or A2 on the HP 54645D.
- 2 Connect the probe grabber to the circuit point of interest. Be sure to connect the ground lead to a ground point.

Adjust display brightness

The brightness control is at the lower left corner of the display.

- To decrease display brightness, rotate the brightness control counter-clockwise.
- To increase display brightness, rotate the brightness control clockwise.

Figure 1-5

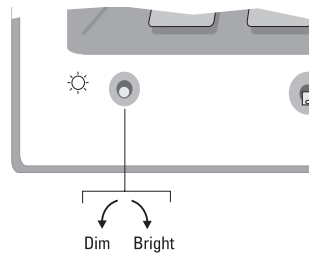

HP 54645A/D Brightness Control



Front-Panel Overview

Front-Panel Overview

Before you make measurements using the HP 54645A Oscilloscope and HP 54645D Mixed-Signal Oscilloscope, you must first set up the instrument using front-panel controls. Then, make the measurement and read the display results. See the following pages for descriptions of controls.

The HP 54645A/D operates much like an analog scope, but it can do much more. Spending a few minutes to learn some of this capability will take you a long way toward more productive troubleshooting. The “MegaZoom Concepts and Oscilloscope Operation” chapter has more detail on the things to consider while operating your oscilloscope.

The grey keys on the front panel bring up softkey menus on the display that allow access to oscilloscope features. The white keys are instant action keys and menus are not associated with them.

Throughout this book, the front-panel keys are denoted by a box around the name of the key, and softkeys are denoted by a change in the text type. For example, **Display** is the grey front-panel key on the front panel, and **Normal** is a softkey appearing at the bottom of the display directly above its corresponding softkey.

Important Oscilloscope Considerations

IMPORTANT: Read This Information!

It is extremely important that you read and understand the following information!

Using Single versus Run/Stop

The HP 54645A/D both have a Single key and a Run/Stop key. When you press Run, the trigger processing and screen update rate are optimized over the memory depth. Single acquisitions always use the maximum memory available—at least twice as much memory as acquisitions captured in Run mode—and the scope stores at least twice as many samples. At slow sweep speeds, the oscilloscope operates at a higher sample rate when Single is used to capture an acquisition, as opposed to running, due to the increased memory available.

Viewing Signal Detail with Display Mode

Remember how you had to constantly adjust the brightness on old analog scopes to see a desired level of detail in a signal, or to see the signal at all? With the HP 54645A/D, this is not necessary. The HP 54645A/D brightness knob operates much like the brightness knob on your computer screen, so you should set it to a level that makes for comfortable viewing, given the room lighting, and leave it there. Then you can control the “detail” by selecting a Display Mode: Normal, Peak Detect, or Average, as described in the following paragraphs.

Normal Mode

Normal mode is the display mode that you will probably use for acquired samples most of the time. It compresses up to 1 million acquisition points per channel into a 4,000-point display record with vectors off, or a 2,000-point record with vectors on.

The scope’s 200 MSa/s sampling speed specification means that samples are taken every 5 ns. At the faster sweep speeds, the running display is built from many individual triggers. If you press the Stop key, and pan and zoom through the waveform, only the last trigger’s acquisition will be displayed.

Whether the scope is stopped or running, you see more detail as you zoom in, and less as you zoom out. To keep from losing detail as you zoom out, switch to the Peak Detect display mode. “Zoom” means you expand the waveform using either the main or delayed sweep window. “Panning” the waveform means you use the Delay knob to move it horizontally.

Peak Detect Mode

In Peak Detect display mode, any noise, peak, or signal wider than 5 ns will be displayed, regardless of sweep speed. In Normal display mode, at faster than 2 us/div, you would see a 5-ns peak, so peak detect has no effect at sweep speeds faster than 2 us/div. Note that in this case the Pk status indicator on the top line of the display is not highlighted.

Using Peak Detect and Autostore together is a powerful way to find spurious signals and glitches.

Average Mode

Averaging is a way to pull the signal out of noise. Averaging works better than either a bandwidth limit or a brightness control because the bandwidth is not reduced.

The simplest averaging is “smoothing.” For example, the sample rate at a Time/Div setting of $\geq 2 \mu\text{s}/\text{div}$ allows the extra 5-ns samples to be smoothed together, smoothing the data into one sample, which is then displayed. As with Peak Detect, smoothing has no effect at less than $2 \mu\text{s}/\text{div}$. Smoothing works on a single acquisition (even untriggered and single-shot). Averaging (4, 8, 16, 32, 64, 128, and 256) needs a stable trigger, because in this mode multiple acquisitions are averaged together. See the chapter “MegaZoom Concepts and Oscilloscope Operation” for more information about smoothing.

Auto Single

As in Normal run mode, auto-trigger will generate a trigger for you if one is not found in the predetermined time from when the trigger system is armed. To take a single-shot acquisition, if you are not particularly interested in triggering the acquisition (for example, if you are probing a known signal), use Auto Single mode. If a trigger exists, it will be used; if a trigger does not exist, an untriggered or auto-triggered acquisition will be taken for later analysis.

Using Vectors

One of the most fundamental choices you must make about your display is whether to draw vectors (connect the dots) between the samples, or simply let the samples fill in the waveform. To some degree, this is a matter of personal preference, but it also depends on the waveform.

- You will probably operate the oscilloscope most often with vectors on. Having vectors on slows the display of the oscilloscope, thus works better for slower sweep speeds, peak detect, or average displays, and signals with stable triggers.
- Having vectors off works better for fast sweep speeds, normal displays, or unstable triggers. Complex analog signals like video and eye diagrams show more intensity information with vectors off. Turn vectors off when the maximum display rate is required, or when highly complex or multi-valued waveforms are displayed.

Delayed Sweep

Delayed sweep on the HP 54645A/D is a simultaneous display of the waveform at two different sweep speeds. Because of the deep memory in the MegaZoom technology, it is possible to capture the main display at 1 ms/div, and redisplay the same trigger in the delayed display at any desired faster time base.

There is no limit imposed on the zoom ratio between the main and delayed displays. There is, however, a useful limit—when the samples are spaced so far apart that they are of little value. See the chapter “MegaZoom Concepts and Oscilloscope Operation” for more information about delayed sweep and time reference.

Post Acquisition Processing

In addition to changing display parameters after the acquisition, you can do all of the measurements and math functions after the acquisition.

Measurements and math functions will be recalculated as you pan and zoom and turn on and off channels. As you zoom in and out on a signal, you affect the resolution of the display. Because measurements and math functions are performed on displayed data, you affect the resolution of functions and measurements.

The two scope channels are always acquired, so you can turn them on and look at them even if they were off during the acquisition. See “To turn digital channels off (HP 54645D)” later in this chapter for more information about the combination of events and displayed channels.

The XY horizontal display mode changes the oscilloscope display to volts-versus-volts. The Roll horizontal display mode causes the waveform to move across the screen from right to left.

HP 54645A/D Front Panels

Figure 2-1

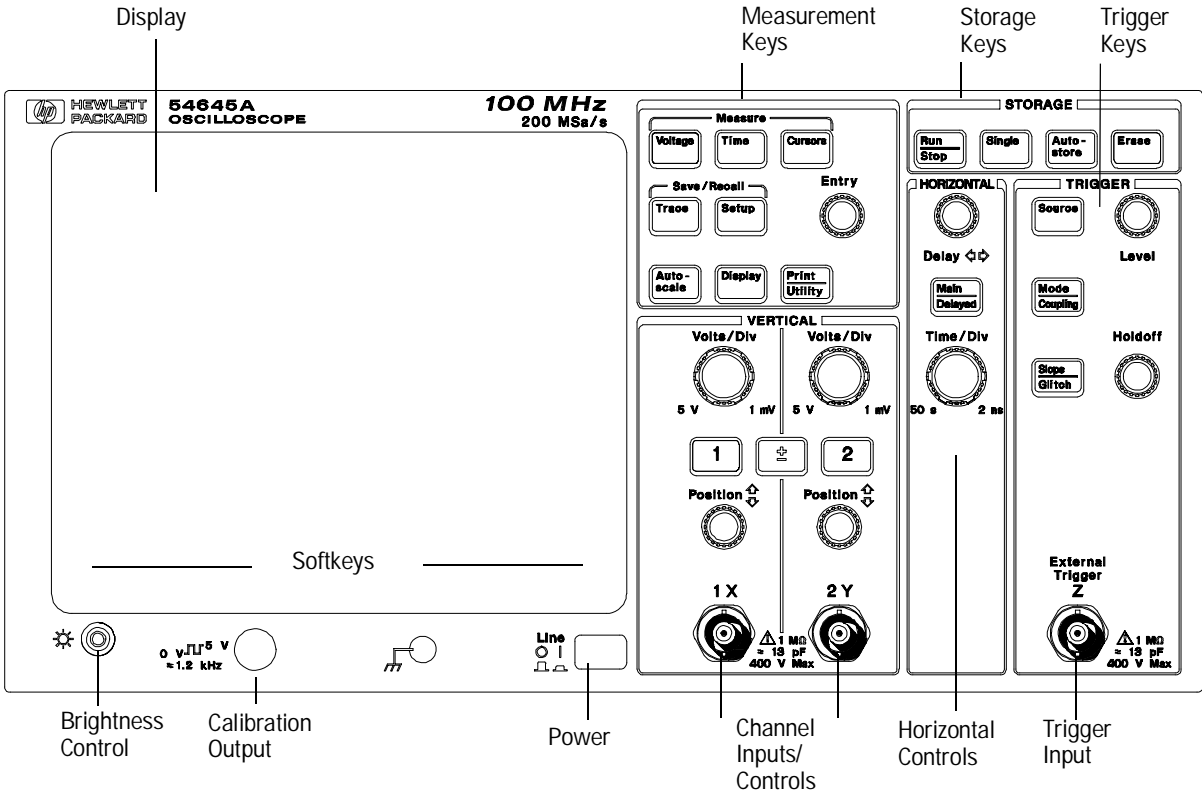

HP 54645A Oscilloscope Front Panel

Figure 2-2

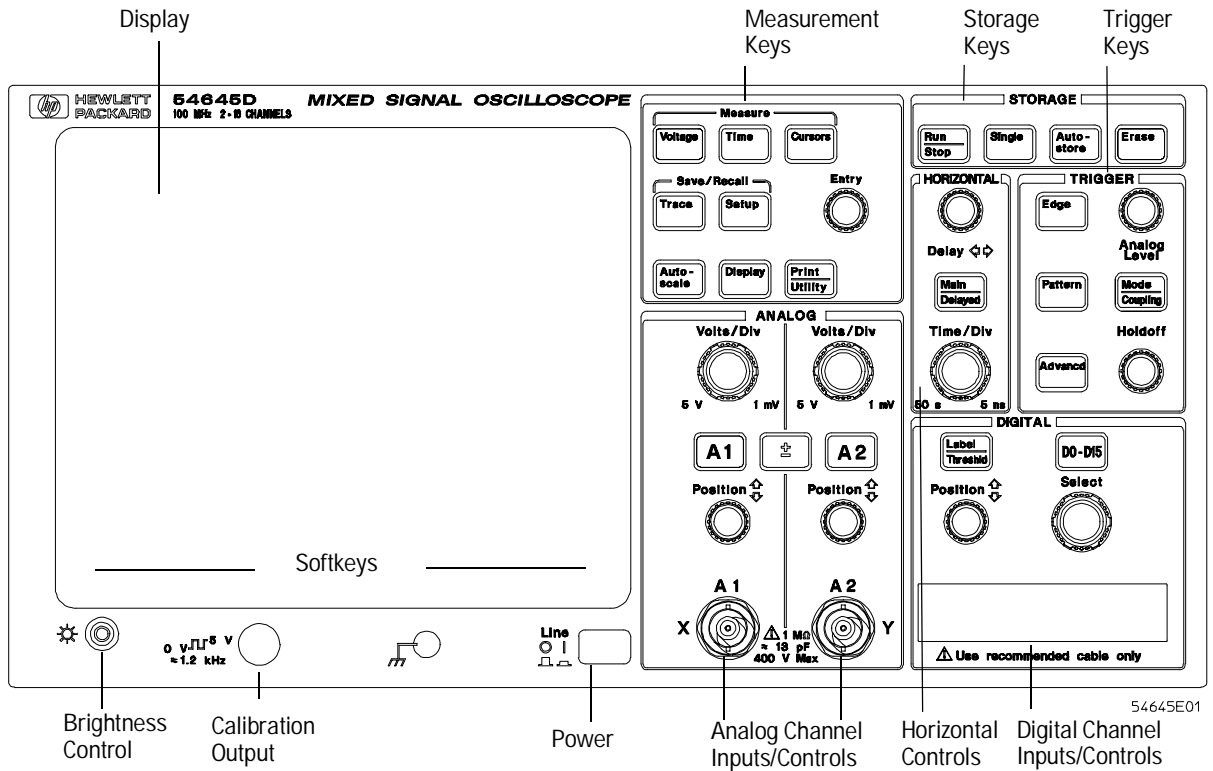

HP 54645D Mixed-Signal Oscilloscope Front Panel

Description of Front-Panel Areas

Table 2-1

HP 54645A Front-Panel Areas

Front-Panel Areas	Functions	Control Knobs
Display	Shows waveforms, measurement results and instrument configuration settings.	
Softkeys	Set up various options for each major function, varying dynamically depending on the required function.	
General Controls	Include various measurement functions, configuration, screen and measurement results, cursors, save/recall, printing, and Autoscale functions.	Entry
VERTICAL Channel Controls and Signal Inputs	Move or rearrange scope channels, and turn them on or off; set coupling, inversion, and probe factors; and connect the acquisition system to the probes.	Volts/Div, Position (Channel 1) Volts/Div, Position (Channel 2)
STORAGE Keys	Control start and stop of acquisition, single trace, persistent acquisition, and screen erasure.	
HORIZONTAL Controls	Adjust the time base, horizontal mode, and main and delayed sweep functions.	Delay, Time/Div
TRIGGER Controls and External Input	Set up trigger mode and trigger conditions.	Level, Holdoff
External Trigger Input	Triggers the oscilloscope from external instruments or non-viewable signals.	
Brightness Control (Display Intensity Knob)	Adjusts display brightness.	Display Intensity

Table 2-2

HP 54645D Front-Panel Areas

Front-Panel Areas	Functions	Control Knobs
Display	Shows waveforms, measurement results and instrument configuration settings.	
Softkeys	Set up various options for each major function, varying dynamically depending on the required function.	
General Controls	Include various measurement functions, configuration, screen, and measurement results, save/recall, printing, and Autoscale functions.	Entry
ANALOG Channel Controls and Signal Inputs	Move or rearrange analog channels A1 and A2, turn them on or off, set coupling and inversion, and connect the acquisition system to the probes.	Volts/Div, Position (Channel A1) Volts/Div, Position (Channel A2)
STORAGE Keys	Control start and stop of acquisition, single trace, persistent acquisition, and screen erasure.	
HORIZONTAL Controls	Adjust the time base, horizontal mode, and main and delayed sweep functions.	Delay, Time/Div
TRIGGER Controls	Set up trigger mode and trigger conditions.	Analog Level, Holdoff
DIGITAL Channel Inputs/Controls	Move or rearrange digital channels D0-15, turn them on or off, set threshold, define labels, and connect the acquisition system to the probes.	Position, Select
Brightness Control (Display Intensity Knob)	Adjusts display brightness.	Display Intensity

Front-Panel Overview
Description of Front-Panel Areas

Table 2-3

HP 54645A/D Front-Panel Specifics

General Front-Panel Areas	Description	Applies to Unit:
Waveform Display	The waveform display area shows all acquisition results. You can change the graticule or turn it off entirely using the Display menu.	HP 54645A/D
Softkeys	<p>Softkeys are shown along the bottom of the display. Some softkeys have an immediate action, such as taking you to another menu or initiating a measurement.</p> <p>Other softkeys allow you to scroll through a list of choices, such as channels or trigger operators. You can scroll through the choices by pressing the softkey repeatedly or by using the Entry knob. For some softkeys, you can use the Entry knob to scroll through the choices. For channel lists, you can always use the Select knob or Entry knob to scroll through the choices.</p> <p>Occasionally a softkey label is displayed with two or more choices below it, one of which is highlighted. The highlighted choice is the one that is currently active. Pressing the softkey toggles the highlight to the other choice.</p> <p>When several softkeys are displayed with a labeled bar over them, it means that either the softkeys are related and/or that the choices are mutually exclusive.</p>	HP 54645A/D

General Front-Panel Areas	Description	Applies to Unit:
Keypad and Softkeys	Some keys, such as On/Off and Label also have special functions while in the menus that they activate. Keys on the HP 54645A/D front panels include the following:	
	White keys have an immediate action, such as starting or stopping the instrument. No menus are associated with white keys.	HP 54645A/D
	Gray keys display softkey menus, allowing you to modify the instrument's measurement configuration.	HP 54645A/D
	Softkeys below the display dynamically change to indicate currently valid menu selections. A blank softkey has no function in the selected menu.	HP 54645A/D
Control Knobs	Control knobs on the HP 54645A/D front panels include the following:	
	The Time/Div knob changes the current time base setting (sweep speed) of the oscilloscope in Main or Delayed sweep. The setting of the time base affects sample rate and other instrument functions as well. This control knob allows you to zoom the waveform when the acquisition is stopped.	HP 54645A/D
	The Delay knob sets the delay time with respect to the time reference in either Main or Delayed sweep. This control knob allows you to pan through the waveform when the acquisition is stopped.	HP 54645A/D
	The Select knob chooses the digital channel on which the next action will operate.	HP 54645D only

Front-Panel Overview

Description of Front-Panel Areas

General Front-Panel Areas	Description	Applies to Unit:
	The Position knob moves the selected channel to a new vertical position on the display. The HP 54645D has an additional Position knob for the DIGITAL channels.	HP 54645A/D
	The Entry knob selects from multiple choices in menus. It also occasionally duplicates the function of the Select knob.	HP 54645A/D
	The Trigger Level knob (HP 54645A) and Trigger Analog Level knob (HP 54645D) sets the trigger level for stabilizing a waveform on the screen.	HP 54645A/D
	The Trigger Holdoff knob keeps the oscilloscope from triggering for a specified amount of time.	HP 54645D
	The display intensity knob adjusts display brightness.	HP 54645A/D
Display Regions	The display is divided into the following regions:	
	Activity/status indicators are along the top of the display. These include channel status when selecting the Pattern and Advanced trigger menus, and show whether digital channels are turned on or off.	HP 54645D
	Channel numbers and labels are on the left edge of the display.	HP 54645A/D
	Waveforms are in the center of the display.	HP 54645A/D
	Measurement results and messages are just below the waveform display area.	HP 54645A/D
	Softkey labels are along the bottom of the display.	HP 54645A/D

Front-Panel Areas	Description	Applies to Unit:
Status Indicators	<p>Status indicators include the following:</p> <p>Channels that are turned off are visible only if you select a channel that is off by using the Select knob.</p> <p>Average mode is indicated by "Av". Peak detect mode is indicated by "Pk". These indicators are active when displayed in inverse video on the line above the display. When Time/Div is set to 5 ns, and Peak Detect display mode is selected, <i>Pk</i> is displayed at the top of the display, but has no effect, and is not highlighted.</p> <p>Delay includes the time reference indicator, the offset markers, and the delay measurement. The solid triangle marker (▼) points to the trigger event in both the main and delayed sweep; it moves with the Delay knob. The ∇ symbol indicates the time reference point. The time reference indicator is a left arrow (←) if the trigger event is at the beginning of acquisition memory, a right arrow (→) if the event is at the end of acquisition memory, and a down arrow (↓) if it is at the center. The offset markers and delay measurement work together when you adjust the Delay knob and Horizontal Mode is set to Main, to indicate how far you have delayed the trigger event from the initial time reference position.</p> <p>Time/Div shows the time base setting. Time per division is variable from 2 ns/div to 50 s/div for HP 54645A, and from 5 ns/div to 50 s/div for HP 54645D.</p> <p>When Coupling is set to AC, a small sine wave is included in the top left area of the status line.</p>	<p>HP 54645D</p> <p>HP 54645A/D</p> <p>HP 54645A/D</p> <p>HP 54645A/D</p> <p>HP 54645A/D</p>

Front-Panel Overview
Description of Front-Panel Areas

Front-Panel Areas	Description	Applies to Unit:
	Trigger condition shows the current trigger mode. The Auto Level and Auto trigger modes display the "Auto" indicator. For Edge trigger mode, it also shows the trigger condition and channel number.	HP 54645A/D
	In normal trigger mode, when the TV trigger mode is selected, "TV" is displayed; when in Auto level or Auto modes, "TV" is replaced by the "Auto" indicator. Glitch trigger mode displays a positive or negative glitch signal next to the channel number.	HP 54645A/D
	Pattern trigger mode displays "Pat" and Advanced Pattern trigger mode displays "Adv".	HP 54645D
	If the last acquisition was initiated by pressing the Single key, the letters "Sngl" appear in this position (unless the last single acquisition was auto triggered).	HP 54645A/D
	The acquisition indicator shows the current acquisition condition, that is, whether the acquisition system is running, stopped, or in Autostore mode.	HP 54645A/D
	When the instrument is in Normal trigger mode, the Trigger condition indicators flash while the instrument is searching for the trigger condition, which occurs after the pre-trigger buffer is full. When the instrument is in Auto trigger mode, the word "Auto" flashes to the left of the Trigger condition indicator if the instrument did not find the trigger and was therefore triggered automatically after a time-out.	HP 54645A/D
	When the delayed horizontal mode is selected, a square symbol appears at the top center of the activity indicator line. The Time/Div next to this symbol is the delayed sweep s/div value. When you press the Main/Delayed key, the delay value is displayed briefly at the bottom of the display.	HP 54645A/D

Front-Panel Areas	Description	Applies to Unit:
Channel Numbers	The channel numbers are always shown along the left edge of the display.	HP 54645A/D
Channel Labels	You can assign channel labels to help you remember the function of each channel in your circuit, or disable the labels to increase the waveform display area.	HP 54645D only
Analog channel voltage levels	Voltages for channels 1 and 2 (analog channels 1 and 2 on HP 54645D) are set to 100 mV by default, and range from 1.0 mV to 5.0 V.	HP 54645A/D

Front-Panel Operation

By now you should be somewhat familiar with the VERTICAL or ANALOG, STORAGE, HORIZONTAL, TRIGGER, and DIGITAL groups of front-panel keys and knobs. You should also know how to determine the setup of the oscilloscope by looking at the status line. If you are unfamiliar with this information, we recommend that you read the introductory material at the start of this manual.

HP 54645A and HP 54645D Channels

Because both the HP 54645A Oscilloscope and the HP 54645D Mixed-Signal Oscilloscope have analog channels, the analog channel topics in this chapter apply to both instruments. Whenever a topic discusses the digital channels, that information applies only to the HP 54645D Mixed-Signal Oscilloscope.

Oscilloscope Channels are Labeled Differently

On the HP 54645A Oscilloscope, the analog channels are labeled 1 and 2 since there are no digital channels. On the HP 54645D Mixed-Signal Oscilloscope, the analog channels are labeled A1 and A2 to distinguish them from the digital channels.

To use oscilloscope channels to view a signal

- To configure the instrument quickly, press **Autoscale** .
- To undo the effects of autoscale, press **Setup** , then press **Undo Autoscale**.
- To set the instrument to the factory-default measurement configuration, press **Setup** , then press **Default Setup**.

Example

Connect the oscilloscope probes for channels 1 and 2 for HP 54645A (or A1 and A2 for HP 54645D) to the calibrator output on the front panel of the instrument. Set the instrument to the factory default configuration by pressing **Setup** , then **Default Setup**. Then press **Autoscale** . You should see a display similar to the following.

Figure 2-3

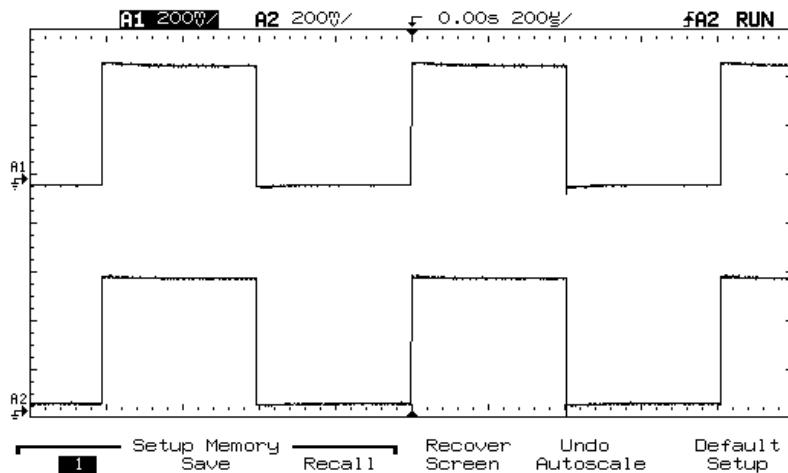

HP 54645D Sample Autoscale Measurement

To use digital channels to view a signal

- To configure the instrument quickly, press **Autoscale** .
- To undo the effects of autoscale, press **Setup** , then press **Undo Autoscale**.
- To set the instrument to the factory-default measurement configuration, press **Setup** , then press **Default Setup**.

Example

Install grabbers on channels D0 and D1. Connect the probes for digital channels D0 and D1 to the calibrator output on the front panel of the instrument. Be sure to connect the ground lead. Set the instrument to the factory default configuration by pressing **Setup** , then **Default Setup**. Then press **Autoscale** . You should see a display similar to the following.

Figure 2-4

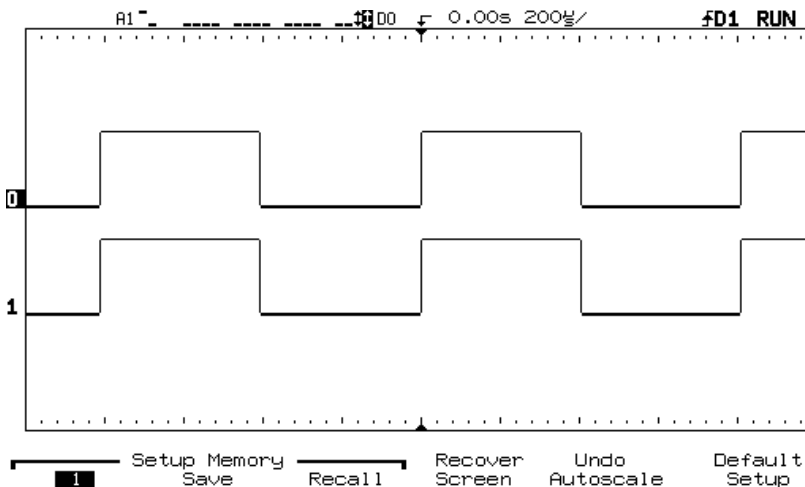

HP 54645D Sample Autoscale Measurement

To display signals automatically using Autoscale

- To configure the instrument quickly, press **Autoscale** .
Autoscale displays all connected signals that have activity.
- To undo the effects of autoscale, press **Setup** , then press **Undo Autoscale**.

How Autoscale Works

If there is at least one oscilloscope or digital channel with an active signal, the instrument turns off all other channels having no activity, and turns on all channels having activity.

A scope channel is active if it is at least 10 mVp-p. Autoscale finds dc (> 50 mV) on the HP 54645A/D scope channels. The scope channels that are on are scaled vertically to best fit the screen.

For testing for digital channel activity, TTL, ECL, and variable thresholds are used (in that order). Digital channels not previously displayed will be added below those channels already displayed, with the lowest-numbered channel at the top. Higher-numbered channels will be displayed in order down the display.

The instrument checks for activity using a time window of 20 ms, allowing it to recognize signals as slow as 50 Hz for autoscaling. If the instrument does not find any channel with an active signal, it restores the setup to the pre-autoscale state.

To apply the default factory configuration

During Autoscale, the delay is set to 0.0 seconds, the Time/Div setting is a function of the input signal (about 2 periods of the triggered signal on the screen), and the triggering mode is set to edge. The instrument stays in Normal or Peak Detect display mode, depending on what was selected when Autoscale was performed. Vectors remain in the state they were before the Autoscale.

Autoscale sets the trigger to a rising edge on a channel, checking the channels in this priority: A2, A1, D15...D0.

Undo Autoscale

The Undo Autoscale function returns the instrument to the setup that existed prior to Autoscale being activated.

To apply the default factory configuration

- To set the instrument to the default factory measurement configuration, press **Setup** , then press **Default Setup**.

The default configuration returns the instrument to the factory settings. Refer to chapter 4, “MegaZoom Concepts and Oscilloscope Operation,” for specific details.

To adjust oscilloscope vertical scaling

This exercise guides you through the vertical keys, knobs, and status line.

1 Center the signal on the display using the Position knob.

The Position knob moves the signal vertically; the signal is calibrated. Notice that as you turn the Position knob, a voltage value is displayed for a short time, indicating how far the ground reference is located from the center of the screen. Also notice that the ground symbol moves with the Position knob.

Measurement Hints

If the channel is DC coupled, you can quickly measure the DC component of the signal by simply noting its distance from the ground symbol. If the channel is AC coupled, the DC component of the signal is removed, allowing you to use greater sensitivity to display the AC component of the signal.

2 Change the vertical setup and notice that each change affects the status line differently. You can quickly determine the vertical setup from the status line in the display.

- Change the vertical sensitivity with the Volts/Div knob and notice that it causes the status line to change.
- Press **1** (for HP 54645A) or **A1** (for HP 54645D).

A softkey menu appears on the display, and the channel turns on (or remains on if it was already turned on).

To adjust oscilloscope vertical scaling

- Toggle each softkey and notice which keys cause the status line to change. Channels 1 and 2 have a vernier softkey that allows the Volts/Div knob to change the vertical step size in smaller increments. These smaller increments are calibrated, which result in accurate measurements, even with the vernier turned on.
- To turn the channel off, either press **1** (for HP 54645A) or **A1** (for HP 54645D) a second time or press the left-most softkey.

Invert Operating Hint

Inversion affects how a channel is displayed, but it does not affect triggering. The trigger does not see the inversion, and thus is not affected. If the trigger is set to a rising edge, it remains rising after inversion.

Bandwidth Limit

The displayed bandwidth limit of the selected channel is 20 MHz, and is available for channels 1 and 2.

To Expand the Vertical Signal

When changing the Volts/Div for analog channels, you can have the signal expand (or compress) about the signal offset or the ground point. This works well with two signals displayed, because you can position and see them both on the screen while you change the amplitude.

- To expand the signal about the offset, press **Print/Utility** . Then select **System Config** and **Expand Vertical Center**.

When you increase the Volts/Div to expand the signal about center, the top of the waveform stays at the same level, while the bottom of the waveform adjusts to fill the Volts/Div setting.

- To expand the signal about ground, press **Print/Utility** . Then select **System Config** and **Expand Vertical Ground**.

When you increase the Volts/Div to expand the signal about ground, the bottom of the waveform stays at the same level, while the top of the waveform adjusts to fill the Volts/Div setting.

Oscilloscope Probes

The HP 54645A/D Oscilloscopes have automatic probe sensing. If you are using the probes supplied with the oscilloscope, or other probes with probe sensing, the probe attenuation factor will be automatically set up by the oscilloscope when automatic probe sensing is turned on. The default setting is to have automatic probe sensing turned on. This is indicated by the selection **Auto n** under the **Probe** softkey, where **n** is 1, 10, or 100.

If you are not using automatic probe sensing, toggle the **Probe** softkey to change the attenuation factor to match the probe you are using.

To turn analog channels on and off

- To turn off analog channel #1, press **[1]** (on the HP 54645A), or **[A1]** (on the HP 54645D), then press the leftmost softkey until **Off** is highlighted.
- To turn off analog channel #2, press **[2]** (on the HP 54645A), or **[A2]** (on the HP 54645D), then press the leftmost softkey until **Off** is highlighted.

If you are already accessing the channel menu, you can press the On/Off key or the channel key (1 or 2 for HP 54645A; A1 or A2 for HP 54645D) to toggle a particular channel on or off.

To rearrange the analog channels

- Rotate the channel 1 or 2 Position knob to choose a new location for the analog channel.

Turning the Position knob counter-clockwise moves the channel down; turning the knob clockwise moves the channel up.

To turn digital channels on and off (HP 54645D)

- To turn digital channels 0 through 7 on, press **D0-D15**, then press the **D0 - D7 On** softkey. To turn these channels off, press the **Off** softkey.
- To turn digital channels 8 through 15 on, press **D0-D15**, then press the **D8 - D15 On** softkey. To turn these channels off, press the **Off** softkey.
- To turn on an individual channel, press **D0-D15**. Rotate the Select knob until the channel is selected. Then, press **On** or press **D0-D15** again to turn on the channel.

You can assign labels to channels that are off, or use them in a trigger specification.

The two analog channels are always acquired, so you can turn them on and look at them even if they were off during the acquisition. The combination of events and displayed channels are:

Running—Before Acquisition		After Stopping Acquisition	
D0-D7	D8-D15	D0-D7	D8-D15
Off	Off	Can be viewed	Cannot be viewed
Off	Any On	Cannot be viewed	Can all be viewed
Any On	Off	Can all be viewed	Cannot be viewed
Any On	Any On	Can all be viewed	Can all be viewed

To rearrange the digital channels (HP 54645D)

- 1 Turn the Select knob to choose the digital channel you want to move. Only channels that are currently on may be moved.
- 2 Turn the Position knob to move the selected channel to a new position.
Turning the Position knob counter-clockwise moves the channel down; turning the knob clockwise moves the channel up.
The combination of the Select and Move knobs gives you a feature similar to that of a waveform position control on an oscilloscope, except that you can only move the waveform to certain discrete locations.
- 3 To change the general order in which channels are displayed, press **D0-D15**. Then press the **Off/On** softkey or the **Reorder D15-D0** softkey.

When **Reorder D15-D0** is pressed, the digital channels are displayed in descending order, and the **Reorder** softkey is relabeled **D0-D15**. When the **D0-D15** softkey is pressed, the digital channels are displayed in ascending order, and the **Reorder** softkey is relabeled **D15-D0**.

Figure 2-5

Channel activity indicators appear temporarily when you access the D0-D15 menu, pattern menu, and advanced pattern menu.

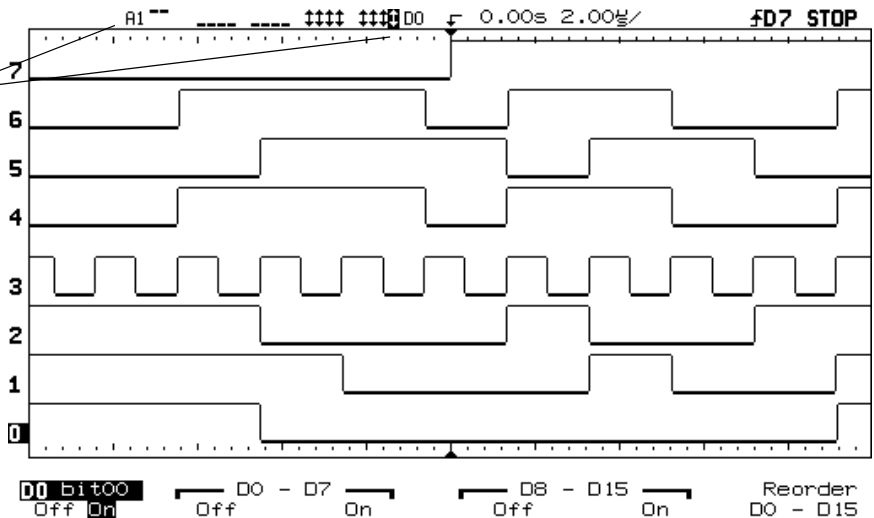

HP 54645D Digital Channels in Order

To operate the time base controls

The following exercise guides you through the time base keys, knobs, and status line.

- Turn the Time/Div knob and notice the change it makes to the status line.

The Time/Div knob changes the sweep speed from 2 ns to 50 s (HP 54645A) and from 5 ns to 50 s (HP 54645D) in a 1-2-5 step sequence, and the value is displayed in the status line.

- You can access the horizontal **Vernier** softkey by pressing the **Main/Delayed** key.

The **Vernier** softkey allows you to change the sweep speed in smaller increments with the Time/Div knob. These smaller increments are calibrated, which result in accurate measurements, even with the vernier turned on.

- You can check the sample rate by pressing the **Main/Delayed** key when the instrument is running, during a single run, or when the instrument is stopped. The sample rate is also displayed when the acquisition stops or ends.
- Turn the Delay knob and notice that its value is displayed in the status line.

The Delay knob moves the main sweep horizontally, and it pauses at 0.00 s, mimicking a mechanical detent. At the top and bottom of the graticule is a solid triangle (▼) symbol and an open triangle (∇) symbol. The ▼ symbol indicates the trigger point and it moves with the Delay knob. The ∇ symbol indicates the time reference point. If the time reference softkey is set to left, the ∇ is located one graticule in from the left side of the display. If the time reference softkey is set to center, the ∇ is located at the center of the display. The delay number tells you how far the reference point ∇ is located from the trigger point ▼.

All events displayed left of the trigger point ▼ happened before the trigger occurred, and these events are called pre-trigger information. You will find this feature very useful because you can now see the events that led up to the trigger point. Everything to the right of the trigger point ▼ is called post-trigger information. The amount of delay range (pre-trigger and post-trigger information) available depends on the sweep speed selected.

To start and stop an acquisition

- To begin an acquisition, press the **Run/Stop** key.
- To begin a single acquisition, press the **Single** key.

The instrument begins acquiring data while searching for a trigger condition. The RUN indicator is shown in the upper-right corner of the display. If a trigger occurs, the acquired data is shown in the display.

- To stop an acquisition in process, press the **Run/Stop** key.

The instrument stops acquiring data, and the STOP indicator is shown in the upper-right corner of the display. If the instrument was triggered (even by auto triggering) and the pre-trigger and post-trigger buffers are full, the results are displayed on the screen. If the buffers are not full, the waveform display area will show nothing.

To use the Entry and Select knobs

The Select knob (HP 54645D only) always changes the selected channel. In most menus, its order is screen-oriented. In the simple pattern and advanced pattern definition menus, it moves from the lowest to highest number on clockwise rotation.

The Entry knob increments and decrements the selected field—for example, glitch time and setup memory number. It also moves the selected cursor when cursors are on. In menus where it doesn't need to do these things (for example, there is no field to increment or decrement, or cursors are turned off), it adjusts the selected channel increment/decrement in a non-screen but numerical order.

The Entry knob also occasionally duplicates the function of the Select knob. Use the Entry knob to select channels, set trigger durations (ranges), and select labels (HP 54645D only).

To make cursor measurements

The following steps guide you through the front-panel Cursors key. You can use the cursors to make custom voltage or time measurements on scope signals, and timing measurements on digital channels.

- 1 Connect a signal to the oscilloscope and obtain a stable display.
- 2 Press **Cursors**. View the cursor functions in the softkey menu:

Source selects a channel for the voltage cursor measurements (1 and 2 for HP 54645A and A1 and A2 for HP 54645D). If a Measurement/Storage module is installed in the oscilloscope, and Function 2 is set to FFT and is turned on, you can select f1 or f2 for the source.

Active Cursor includes voltage cursors V1 and V2, and time cursors t1 and t2. Pressing the voltage cursors alternates between V1 or V2, or both V1 and V2. Pressing the time cursors alternates between t1 or t2, or both t1 and t2. When both voltage cursors or both time cursors are highlighted, they are selected, and they will move together on the screen.

Voltage cursors do not apply to the HP 54645D digital channels.

If a Measurement/Storage module is installed in the oscilloscope, and you select F2 as the source with F2 set to FFT, the active cursors include f1 and f2. Use the Entry knob to change the active cursor.

Clear Cursors erases the cursor readings and removes the cursors from the display.

On HP 54645D, the **Readout** softkey gives a reading of the time or voltage cursor measurement.

- For the time cursor readout, you can select Time, Hex, Binary, or Degrees. Binary displays all digital channels by channel number. Hex shows only the displayed channels, with the top channel displayed as the most significant bit. When **Active Cursor** is **t1/t2**, the **Readout Time** softkey sets the display to show the cursor positions in seconds, and the **Readout Degrees** softkey shows the cursor positions in relative number of degrees.
- For the voltage cursor readout, you can select Volts or %. When **Active Cursor** is **V1/V2**, the **Readout Volts %** softkey sets the display to show the cursor positions in volts when **Volts** is highlighted, and as a percentage when **%** is highlighted.

You can expand the display with delayed sweep, then characterize the event of interest with the cursors.

Pressing the **Active Cursor** softkey until both time cursors or both voltage cursors are highlighted allows you to move them together when rotating the Entry knob. You can move the cursors together to check for pulse width variations in a pulse train.

To use delayed sweep

Delayed sweep is a magnified portion of the main sweep. You can use delayed sweep to locate and horizontally expand part of the main sweep for a more detailed (high-resolution) analysis of signals.

The following steps show you how to use delayed sweep. Notice that the steps are very similar to operating the delayed sweep in analog oscilloscopes.

- 1** Connect a signal to the oscilloscope and obtain a stable display.
- 2** Press **Main/Delayed**.
- 3** Press the **Delayed** softkey.

The screen divides in half. The top half displays the main sweep, and the bottom half displays an expanded portion of the main sweep. This expanded portion of the main sweep is called the delayed sweep. Since both the main and delayed sweeps are displayed, there are half as many vertical divisions so the vertical scaling is doubled. Notice the changes in the status line. The top half also has two solid vertical lines called markers. These markers show what portion of the main sweep is expanded in the lower half. The size and position of the delayed sweep are controlled by the Time/Div and Delay knobs. The Time/Div next to the  symbol is the delayed sweep sec/div. The delay value is displayed temporarily at the bottom of the display.

- To display the delay value of the delayed time base temporarily at the bottom of the screen, press **Main/Delayed**.
- To change the delay for the delayed sweep window, turn the Delay knob.
- To change the Time/Div for the delayed sweep window, turn the Time/Div knob.
- To change the Time/Div for the main sweep window, select the main sweep mode. Then turn the Time/Div knob.

To modify the graticule

- 1 Press **Display** .
- 2 Press one of the **Grid** softkeys to define the graticule used for the waveform area on the display.
 - **Frame** has a set of hash marks along the top and bottom of the display only. Major divisions are indicated by longer hash marks.
 - **Full** has a set of hash marks through the center of the waveform display area, with major divisions indicated by a full-height dotted line through the waveform display.
 - **None** has only a border around the waveform display area.

Each major division in the graticule corresponds to the time given by the Time/Div setting shown to the right of the delay value on the display.

To print the display

You can print the waveform display and status line to an HP printer or Epson-compatible printer attached to one of these optional interface modules:

- HP 54650A HP-IB Interface Module
- HP 54652A Parallel Interface Module
- HP 54652B RS-232/Parallel Interface Module
- HP 54657A Measurement/Storage Module (HP-IB)
- HP 54659B Measurement/Storage Module (RS-232/Parallel)

- 1** If you have one of these modules installed, configure the module first. If necessary, refer to documentation supplied with the module.
- 2** Press **Print/Utility**.
- 3** Press **Print Screen**.

The current display is copied to the attached printer. You can stop printing by pressing the **Cancel Print** softkey.

See the documentation for the interface module for information on installing and configuring module interface parameters.



Triggering HP 54645A/D Oscilloscopes

Triggering HP 54645A/D Oscilloscopes

The HP 54645A/D Oscilloscopes provide a full set of features to help automate your measurement tasks, including MegaZoom technology to help you capture and examine the stored waveforms of interest, even untriggered waveforms. With these oscilloscopes you can:

- Modify the way the oscilloscope acquires data.
- Set up simple or complex trigger conditions, as needed, to capture only the sequence of events you want to examine.

The HP 54645A and HP 54645D have common triggering functionality:

- Trigger modes (Auto Lvl, Auto, Normal)
- Line triggering
- Glitch triggering
- TV triggering
- Mode/Coupling (including frequency and noise rejection—see chapter 5)
- Holdoff and Trigger Level
- Slope/Edge Triggering

This chapter explains how to do all these things and more. If you are not familiar with basic operations, see chapter 1, “Getting Started.” See also “Triggering the HP 54645D Mixed-Signal Oscilloscope” in this chapter for additional triggering functionality.

Glitch Trigger

In digital system design, a *glitch* is an unintentional or unexpected signal transition, which may or may not pass through the logic threshold.

The advanced glitch trigger menu lets you select the analog (A1 or A2 on HP 54645D) or digital (D0-D15 on HP 54645D) channel on which to capture a glitch event. You specify the polarity and duration qualifier—either less than (<), greater than (>), or a range—for the glitch. The HP 54645D can capture glitches >8 nanoseconds and <100 seconds.

Selecting Trigger Modes and Conditions

The trigger mode affects the way in which the oscilloscope searches for the trigger. Figure 3-1 shows the conceptual representation of acquisition memory. Think of the trigger event as dividing acquisition memory into a pre-trigger and post-trigger buffer. The position of the trigger event in acquisition memory is defined by the time reference point and the delay setting.

Figure 3-1

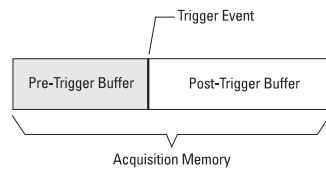

Acquisition Memory

To select a trigger mode: Auto Lvl, Auto, Normal

- 1 Press **Mode/Coupling** .
- 2 Select the **Auto Lvl**, **Auto**, or **Normal** trigger softkey.

Auto Lvl and Auto modes

Use the Auto modes for signals other than low-repetitive-rate signals. To display a dc signal, you must use the auto trigger mode since there are no edges on which to trigger.

Auto Lvl mode is the same as Auto mode with an automatic trigger level adjustment. The oscilloscope looks at the signal level on the signals, and if the trigger level is out-of-range with respect to the signal, the scope adjusts the trigger level back to the middle of the signal.

When you select Run, the oscilloscope operates by first filling the pre-trigger buffer. It continues to flow data through this buffer while it searches for the trigger. When a trigger is found, the pre-trigger buffer will contain the events that occurred just before the trigger. If no trigger is found, the oscilloscope generates a trigger and displays the data as though a trigger had occurred.

Triggering HP 54645A/D Oscilloscopes

To select a trigger mode: Auto Lvl, Auto, Normal

When you select Single, the oscilloscope will fill acquisition memory, and continue flowing data through the pre-trigger buffer until the auto trigger overrides the searching and commands a trigger. At the end of the trace, the scope will stop and display the results.

Normal mode

Use Normal trigger mode for low repetitive-rate signals. In this mode, the oscilloscope has the same behavior whether the acquisition was initiated by pressing Run/Stop or Single.

When the trigger event is found, the oscilloscope will fill the post-trigger buffer and display the acquisition memory. If the acquisition was initiated by **Run/Stop**, the process repeats. The waveform data will be scrolled onto the display as it is being acquired.

The oscilloscope begins filling the pre-trigger buffer with data. As soon as that buffer is full, the oscilloscope will begin searching for the trigger event, and will flash the trigger condition indicator on the status line to indicate it is doing so. While searching for the trigger, the oscilloscope overflows the pre-trigger buffer; the first data put into the buffer is the first pushed out (FIFO).

In either Auto or Normal mode, the trigger may be missed completely under certain conditions. This is because the oscilloscope will not recognize a trigger event until the pre-trigger buffer is full. Suppose you set the Time/Div knob to a slow sweep speed, such as 500 ms/div. If the trigger condition occurs before the oscilloscope has filled the pre-trigger buffer, the trigger will not be found. If you use Normal mode and wait for the trigger condition indicator to flash before causing the action in the circuit, the oscilloscope will always find the trigger condition correctly.

Some measurements you want to make will require you to take some action in the circuit under test to cause the trigger event. Usually, these are single-shot acquisitions, where you will use the Single key.

To use holdoff

By setting the Holdoff, you can synchronize triggers. The oscilloscope will trigger on one edge of the waveform, and ignore further edges until the holdoff time expires. The oscilloscope will then re-arm the trigger circuit to search for the next edge trigger. This allows the oscilloscope to trigger on a repeating pattern in a waveform.

- Turn the holdoff knob in the trigger section to increase and decrease trigger holdoff time.

Holdoff Operating Hints

Holdoff keeps a trigger from occurring until after a certain amount of time has passed since the last trigger. This feature is valuable when a waveform crosses the trigger level multiple times during one period of the waveform. Without holdoff, the scope could trigger on each of the crossings, producing a confusing waveform.

With holdoff set correctly, the scope always triggers on the same crossing. The correct holdoff setting is typically slightly less than one period. Set the holdoff to this time to generate a unique trigger point. This action works even though many waveform periods pass between triggers, because the holdoff circuit operates on the input signal continuously.

The HP 54645A/D uses digital holdoff independent of time base settings. The advantage of digital holdoff is that it is a fixed number. As a result, changing the time base settings does not affect the holdoff number; so, the oscilloscope remains triggered. In contrast, the holdoff in analog oscilloscopes is a function of the time base setting, making it necessary to re-adjust the holdoff each time you change the time base setting.

The rate of change of the holdoff adjustment knob depends on the time base setting you have selected. If you need a lengthy holdoff setting, increase the time/div setting on the time base, then make your coarse holdoff adjustment. Now switch back to the original time/div setting and make the fine adjustment to reach the exact amount you want.

With HP's MegaZoom technology, you can press Stop, then pan and zoom through the data to find where it repeats. Measure this time using the cursors, then set this number to the holdoff.

To trigger on a complex waveform

The difficulty in viewing a complex waveform is triggering on the signal. The simplest trigger method is to trigger the oscilloscope on a sync pulse that is associated with the waveform. If there is no sync pulse, use these steps to trigger on a periodic complex waveform.

- 1** Connect a signal to the oscilloscope.
- 2** Set the trigger level to the middle of the waveform.
- 3** Adjust the Holdoff knob to synchronize the trigger of the oscilloscope with the complex waveform.

Triggering the HP 54645A Oscilloscope

The HP 54645A Oscilloscope allows you to synchronize the display to the actions of the circuit under test by defining a trigger condition. The triggering modes include Auto Lvl, Auto, and Normal. Triggering types include Glitch, TV, and Slope/Edge and you can use channels 1 or 2, Line, or the External Trigger BNC for the source.

MegaZoom Technology Simplifies Triggering

With the built-in MegaZoom technology, you can simply Autoscale the waveforms, then stop the scope to capture a waveform. You can then pan and zoom through the data to find a stable trigger point. Autoscale often produces a triggered display.

To use external triggering

The external trigger input is only available on the HP 54645A Oscilloscope.

1 Connect a signal to the BNC labeled “External Trigger”.

The external trigger input has an input impedance of 1 M Ω , and can accept a maximum signal of ± 400 V (dc + peak ac) with a range of ± 18 V. You can connect the trigger output of other instruments to this external trigger input, or use an oscilloscope probe, such as the HP 10074A.

2 Press **Slope/Glitch**. Then select the rising or falling edge, or Glitch.

If TV is selected, you cannot use the external trigger, and you must select either channel 1 or channel 2. If you select glitch, define the polarity and duration qualifier for the glitch.

3 Press **Source**. Then select Ext.

The external trigger is always dc coupled. If you select ac coupling or low-frequency reject, these functions are not active until you change the trigger source to channel 1, channel 2, or line. Notice that the status line and softkeys reflect this.

To trigger on an edge

- 1 Press **Source** .
- 2 Select **1**, **2**, **Ext**, or **Line** as the trigger source.
You can choose a channel that is turned off as the source for the edge trigger.
You cannot select the Line trigger source when Glitch trigger mode is selected.
- 3 Press **Slope/Glitch** to set the trigger condition.
- 4 Select either the rising edge or falling edge softkey to choose whether the trigger will occur on the rising or falling edge of the input signal.

Figure 3-2

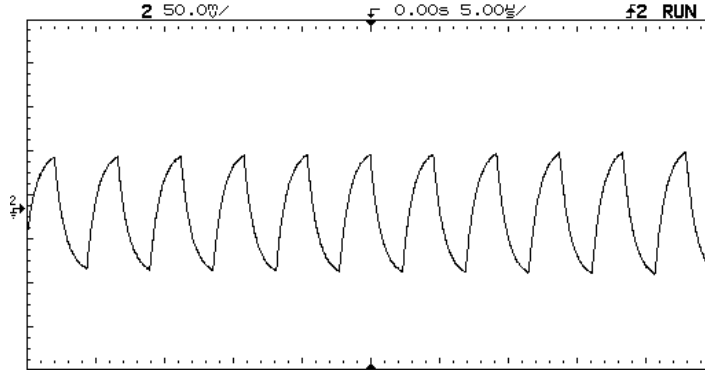

HP 54645A Triggered on Rising Edge of Channel 2

To use glitch triggering

- 1 Press **Slope/Glitch** . Then select **Glitch**.
- 2 Select **Glitch Menu**.
- 3 Define the polarity, duration qualifier, and duration time for the glitch.

Figure 3-3

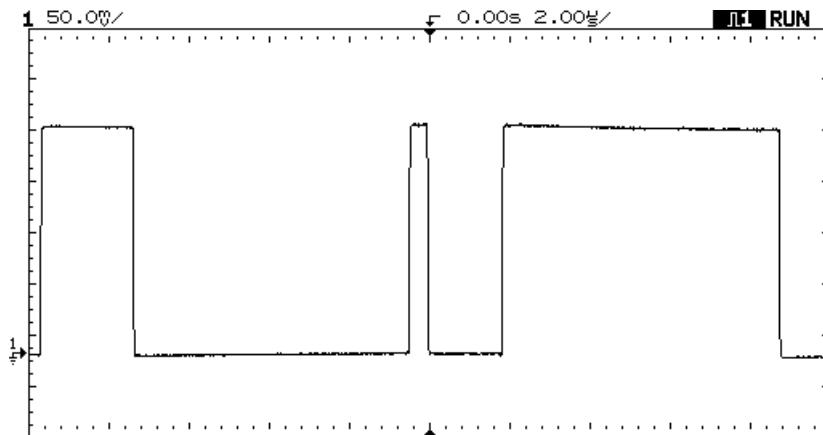

HP 54645A Triggered on Glitch on Channel 1

To use line triggering

- Press **Source** . Then select **Line**.
-

To use TV triggering

- 1 Press **Source** . Select **1** or **2** for the Trigger Source channel.
- 2 Press **Slope/Glitch** . Then select **TV**.
- 3 Select **TV Menu**.
- 4 Select positive or negative polarity.
- 5 Select the TV mode.
 - Pressing **Field 1** triggers on the video signal field 1 portion (odd fields).
 - Pressing **Field 2** triggers on the video signal field 2 portion (even fields).
 - Pressing **Line** triggers on the start of the first line that occurs after the scope starts.
 - Pressing **Vertical** provides vertical triggering—at the beginning of both Field 1 and Field 2.

Triggering the HP 54645D Mixed-Signal Oscilloscope

The HP 54645D Mixed-Signal Oscilloscope allows you to synchronize the oscilloscope display to the actions of the circuit under test by defining a trigger condition.

The trigger types include edge, pattern, and advanced, allowing you to match the complexity of the trigger to that of the data you want to capture. The triggering modes include Auto Lvl, Auto, and Normal. Advanced triggering consists of Glitch, Advanced Pattern, and TV. Depending on the trigger selections and conditions, you can use analog channels A1 or A2, Line, or D0-D15 for the trigger source.

MegaZoom Technology Simplifies Triggering

With the built-in MegaZoom technology, you can simply Autoscale the waveforms, then stop the scope to capture a waveform. You can then pan and zoom through the data to find a stable trigger point. Autoscale often produces a triggered display.

Trigger types

These trigger types are available:

- Edge trigger
- Pattern trigger
- Advanced trigger

Changes to the trigger specification are applied when you make them. If the oscilloscope is stopped when you change a trigger specification, the scope will use the new specification when you press Run/Stop, Single, or Autostore. If the oscilloscope is running when you change a triggering specification, it uses the new trigger definition when it starts the next acquisition. You select the trigger type by pressing the key associated with the desired trigger type.

Edge Trigger

In *edge trigger*, you define a single rising or falling edge that must be recognized on any input channel to satisfy the trigger condition.

Edge trigger is best when there is a unique waveform edge that defines the events you want to capture. For example, a pulse that defines the beginning of a pulse train on another channel will often make a good edge trigger.

Edge triggering is the simplest trigger mode, and the easiest to use. However, its simplicity can lead to situations where more triggering power is needed. Often the device under test needs more than a single rising or falling edge to locate a specific point in its operation.

Glitch Trigger

The advanced glitch trigger menu lets you select the analog (A1 or A2) or digital (D0-D15) channel on which to capture a glitch event. You specify the polarity and duration qualifier—either less than (<), greater than (>), or a range—for the glitch. The HP 54645D can capture glitches >8 nanoseconds and <100 seconds.

Pattern Trigger

In *pattern trigger*, you define a pattern of highs, lows, and don't care levels that must be recognized across the input channels. The pattern may be combined with one edge on any one input channel to form the complete trigger specification.

A Pattern trigger is best when there is a unique pattern that occurs across a group of signals, and the pattern defines the events you want to capture. For example, suppose you have a state machine that outputs a series of hex digits, and only outputs the digit "A" once in every sequence. You can use a pattern trigger to capture this event, perhaps qualified with the state machine clock.

Pattern trigger is less useful when the same pattern occurs many times, and most of those occurrences have little to do with the events you want to capture. For example, suppose that this same state machine generates hundreds of states, and the state "C" occurs several times in the sequence, with a different sequence of states after each occurrence. A pattern trigger will not provide a stable waveform display.

The pattern trigger occurs when the pattern is entered; that is, the trigger condition is satisfied as soon as the input waveforms have transitioned from a condition not matching the pattern to a condition matching the pattern. You can use an edge to further qualify the trigger condition. For example, you may want the oscilloscope to trigger when a certain pattern is present and a clock edge occurs.

The trigger pattern can include high and low values on the oscilloscope A1 and A2 channels. You control the trigger level with the Analog Level knob.

Logical Combination within Terms

In the pattern trigger, all settings within the pattern are logically ANDed; that is, all conditions on the pattern, and the edge if specified, must be satisfied before the oscilloscope will trigger.

Specifying a Logic Threshold

You can specify a threshold for the logic channels. See “To change the logic threshold for input signals” in chapter 4 for information about setting a threshold on the HP 54645D.

Advanced Pattern Trigger

In *advanced pattern trigger*, you define a maximum of two pattern and edge sources that are combined with a variety of operators to form the complete trigger specification.

Advanced pattern trigger is best when the events you want to capture are defined by a series of waveform events in the system, and neither pattern mode nor edge mode are capable of clearly resolving the necessary sequence. For example, suppose the events you want to capture are defined by a pattern with a certain minimum duration, or by a pattern followed by another pattern. Advanced pattern trigger gives you this and more.

Figure 3-4

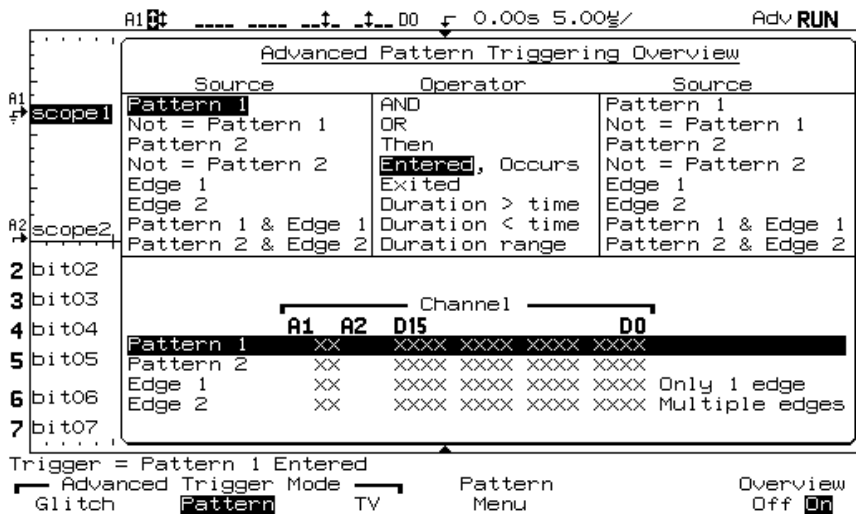

HP 54645D Advanced Pattern Triggering Overview Menu

Sharing of Sources

The source definitions for the simple pattern trigger are shared with the Pattern 1 and Edge 1 sources of the advanced pattern trigger specification. Thus, changes to the simple pattern trigger will affect that specification, and changes to Pattern 1 and Edge 1 in the advanced pattern trigger specification will affect the simple pattern trigger.

Logical Combinations

In advanced trigger, settings within pattern terms are logically ANDed. Settings within the second edge term are logically ORed with the first edge term. Thus, only one of those edge specifications must be satisfied to satisfy the edge term.

TV Trigger

The TV trigger only operates on the analog channels. The TV trigger can be set to trigger on the vertical interval, Field 1, Field 2, or Line. In Line mode, the oscilloscope will trigger on the start of the first line that occurs after the scope starts.

The advanced TV trigger requires two vertical divisions of display amplitude. On HP 54645D, you must specify either analog channel (A1 or A2) as the trigger source. You specify the polarity—either positive or negative sync pulses—and the TV mode. The Field 1 TV mode triggers on the field 1 portion of the video signal, Field 2 triggers on the field 2 portion of the video signal, and Line triggers on all the TV line sync pulses.

On HP 54645D, pressing Field 1 and Field 2 simultaneously gives vertical triggering.

You can select the high-frequency reject in the Mode/Coupling menu to control a 500-kHz, low-pass filter in the trigger path.

To define an edge trigger

- 1 Press **Edge** .
- 2 Select a channel as the trigger source using either the Select knob or by pressing a **Trigger Source** softkey.
You can choose a channel that is turned off as the source for the edge trigger.
- 3 Press one of the **Edge** softkeys to choose whether the trigger will occur on the rising or falling edge.

Rotating the Select Knob does not Affect Trigger Channel

When selecting a digital channel as the source, after you have set the edge trigger condition, and selected another menu, continuously rotating the Select knob will not affect the channel used for the trigger condition. The trigger edge is not changed until you select a slope. This frees up the Select knob for other operations, such as measurements.

To use line triggering

This power line edge triggering, when selected, overrides any other settings. Do not confuse the power line triggering with TV line triggering.

- 1 Press **Edge** . Then select **Line**.
- 2 Select the rising or falling edge softkey.

To define a pattern trigger

- 1 Press **Pattern** .
- 2 For each analog channel (A1 or A2) or digital channel (D0-D15) you want to include in the desired pattern, press the **Source** softkey to select the channel, or rotate the Entry knob or the Select knob.
- 3 Then, press one of these softkeys to set the condition the oscilloscope will recognize as part of the pattern for that channel:
 - **L** for a logic low
 - **H** for a logic high
 - **X** to ignore this channel
 - Rising or falling edge

Specifying an Edge in a Pattern

You are allowed to specify only one rising or falling edge term in the pattern. If you define an edge term, then select a different channel in the pattern and define another edge term, the previous edge definition is changed to a don't care.

Source Definitions for Simple Pattern Trigger Affect Advanced Trigger

The source definitions for the simple pattern trigger are shared with the Pattern 1 and Edge 1 source definitions of the advanced pattern trigger specification. Thus, changes to the simple pattern trigger will affect that specification, and changes to Pattern 1 and Edge 1 in the advanced trigger specification will affect the regular pattern trigger. Defining patterns for the two trigger types differs. See "To define an advanced pattern trigger."

To use glitch triggering

- 1 Press **Advanced** . Then select **Glitch**.
- 2 Select **Glitch Menu**.
- 3 Select the analog channel (A1 or A2) or digital channel (D0-D15) source for the trigger by pressing the **Source** softkey until the desired source is highlighted.
- 4 Select positive or negative polarity for the glitch to capture.
- 5 Select the time qualifier (<, less than a specified width; >, greater than a specified width; or ><, within minimum and maximum limits) for the glitch, and rotate the Entry knob or press the softkey to increase the duration time.

To define an advanced pattern trigger

The advanced triggering operation depends on previous selections in the Advanced Trigger menu.

- 1 Press **Advancd** . Then select **Pattern**.
- 2 Press the **Overview** softkey to turn on the trigger overview, if desired.
The trigger overview display shows all the choices available in this menu.
- 3 Select **Pattern Menu**.
- 4 Choose the trigger operator by pressing the **Operator** softkey until the desired operator is shown.

The following table lists the trigger operators and the sources with which they can be used. The sources you specify later in this procedure can limit your choice of trigger operators, and your choice of trigger operators can limit which sources are available. For example, the operator “Exited” applies only to Pattern 1, Not Pattern 1, Pattern 2, and Not Pattern 2 individually, but not to all of them at once.

Table 3-1

Trigger Operators and Sources

Operator	# of Sources	Valid Sources
Duration (> time, < time, Range)	One	Pat 1, Not = Pat 1 Pat 2, Not = Pat 2
Entered, Exited	One	Pat 1, Not = Pat 1 Pat 2, Not = Pat 2
AND, OR, Then	Two	Pat 1, Not = Pat 1 Pat 2, Not = Pat 2 Edge 1, Edge 2 Pat 1 & Edge 1 Pat 2 & Edge 2

- 5 Select the source(s) for the trigger operator by pressing the leftmost **Source** softkey until the desired source is highlighted.

Refer to the table of trigger operators and sources to see the sources and operators with which they can be used.

The oscilloscope will allow you to choose combinations of sources that are redundant, such as “Pattern 1 AND Pattern 1”, or combinations that will create a null trigger condition, such as “Pattern 1 AND Not Pattern 1”.

- 6 Define the source pattern(s) by pressing the **Source Define** softkey.

If you combined patterns and edges in the same source term, you must separately select each as the source, set up the source, then select the combined pattern and edge again.

- 7 Set the parameters for the trigger operator, if necessary.

For the Duration operators (> time, < time, range), press/hold the duration value softkey or rotate the Entry knob to set the duration.

Duration > time

When this operator is selected, you have two choices for trigger:

Trigger At: Timeout (default) – trigger when > time criteria is met after you enter the pattern. This is useful for conditions where the pattern occurs and you want to see the waveform, but no edge follows immediately.

Trigger At: Pat Exit – trigger when you exit the pattern.

- 8 To set up an edge trigger source, do the following:

- a Select a channel for the source.

- To choose whether the trigger will occur on the rising or falling edge, press one of the **Edge Select** softkeys.
- To set a channel to a don't care trigger state, press the **X** softkey.
- To clear all edge settings, press the **Clear Edge(s)** softkey.

In Edge1, you can select only one edge. You may select multiple edges in Edge2; those edges are logically ORed.

- b Repeat step a for all channel sources you want to define.
- c Press **Previous Menu** to return to the Advanced Pattern Trigger menu.

- 9** To set up a pattern trigger source, do the following:
- a** Select a channel for the source.
 - To set the condition for that channel, press the **L**, **H**, or **X** softkey.
 - To clear the conditions for all channels, press **Clear Pattern**.
 - b** Repeat step **a** for all channel sources you want to define.
 - c** Press **Previous Menu** to return to the Advanced Pattern Trigger menu.

Entered and Exited

In the table of trigger operators and sources:

- *Entered* means that the trigger qualifier is satisfied as soon as the input waveforms have transitioned from a state not matching the pattern to a state matching that pattern. In an edge term, or a pattern and edge term, the edge transition is where "entered" is defined.
- *Exited* means that the trigger qualifier is satisfied when the input waveforms transition out of a state matching the pattern to a state not matching the pattern.

Advanced pattern trigger can help you solve difficult data acquisition problems. When setting up an advanced trigger, remember:

- Follow the setup rules.
- Have a clear picture of the event sequence you are trying to capture, and understand how the advanced trigger capabilities relate to those events. The MegaZoom technology's deep memory and pan and zoom capabilities greatly simplify this.

Setup rules

Remembering the following rules will make it easier to work with the advanced triggering capabilities:

- Duration operators are valid when only pattern terms are involved. Duration is *not* selectable when any edge term is selected as a source.
- When you have selected a combination source, like Pattern 1 AND Edge 1, you cannot directly define the pattern or edge. You must instead select Pattern 1 as the source, define the pattern, then select Edge 1 as the source and define the edge. The softkeys change to reflect this.

Understand and relate waveform events to oscilloscope capabilities

The key to setting up a useful waveform display is choosing a known sequence of waveform events to which you can apply the advanced trigger capabilities. The HP MegaZoom technology greatly simplifies this task. You simply press Stop, then pan and zoom through the waveform to find a good trigger event.

To find these events, you can also ask questions about the waveform, keeping in mind the capabilities of the oscilloscope.

- Does the input data always repeat with respect to a particular waveform's high or low period of constant duration?
- Is there a sequence of waveform events that define the data of interest? For example, is there a state machine, where the hypothetical sequence "ac" leads to the events of interest, where "ab" does not?

Example

Suppose you have a pulse train where one of the pulses is of constant duration (4 μ s) and all other signals of interest are repeated with that pulse train, as shown in the following figure.

Figure 3-5

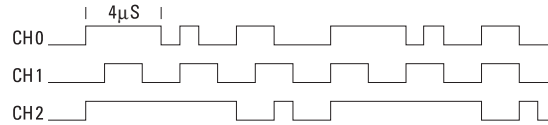

Pulse Train with Constant Duration Pulse

To trigger the oscilloscope on that pulse, you can use one of the trigger setup in the following table:

Source	Operator and Parameters	Pattern/Edge
Pattern 1	Duration > 3.9 μ s	H on channel 0, others don't care
Glitch on channel 1	Duration > 3.9 μ s, < 4.1 μ s	

Example

Suppose you have a state machine whose three outputs, Q0 through Q2, output the decimal sequence 0-1-6-0-6-1-0-1-6-0-6-1. Q2 is the most significant bit, as shown in the following figure.

Figure 3-6

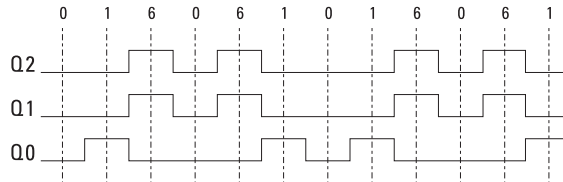

Sequential Output from State Machine

If you try to trigger on any of the single output patterns 0, 1, or 6, the display will not be stable. However, you can use the “Then” operator to trigger on the sequence of pattern “0” followed by pattern “1.” If Q2, Q1, and Q0 are connected to channels D2, D1, and D0 respectively, you can use the setup in the following table to trigger the oscilloscope.

Triggering HP 54645A/D Oscilloscopes To define an advanced pattern trigger

Source	Operator and Parameters	Pattern/Edge
Pattern 1	Then	L on channels D2, D1, and D0, others don't care
Pattern 2		L on channels 2 and 1, H on channel 0, others don't care

All Qualifiers must be Satisfied to Trigger the Oscilloscope

When setting up an advanced trigger, remember that all required events must be satisfied to trigger the oscilloscope.

Pattern 1 and Edge 1 are Shared Sources

Source definitions for Pattern 1 and Edge 1 are shared with the pattern trigger specification. Thus, source changes will affect that specification, and changes to the simple pattern trigger specification will affect the definitions of Pattern 1 and Edge 1.

High-Frequency Pattern Reject

When you set a pattern that contains more than one digital channel, and no edges or analog channels, it is possible that false patterns may occur when two digital channels change at the same time, due to minor skew differences.

In the previous example, when Q2-Q0 change from 1 to 6, Q2 and Q1 rise at the same time. This provides potential for seeing a false "10" or "01" on those two channels. In the HP 54645D, we require the pattern to be present long enough to be sampled at least twice at 400 MHz to eliminate this possibility. This method prevents false triggers on simultaneous edges.



MegaZoom Concepts and Oscilloscope Operation

MegaZoom Concepts and Oscilloscope Operation

This chapter gives an overview of some oscilloscope concepts that will help you make better measurements. It discusses the relationship between the time base setting and other time-dependent oscilloscope functions, explains how to achieve the most accurate signal fidelity through good probing practices, and describes how glitch detection works.

Oscilloscopes with HP's MegaZoom Technology

The information in this chapter applies to both the HP 54645A and HP 54645D Oscilloscope models because both are based on HP's MegaZoom technology.

MegaZoom Concepts

MegaZoom technology combines the advantages of conventional deep-memory digital oscilloscopes with the responsiveness and update rate of traditional analog oscilloscopes. Conventional deep-memory digital oscilloscopes are known for their ability to capture long time intervals while still maintaining high sample rates. MegaZoom technology keeps the deep-memory advantages, without the conventional deep-memory disadvantages of an unresponsive user interface (while panning and zooming through the data) and poor signal update rate.

MegaZoom technology incorporates a multi-processor architecture in the signal data path between the scope probe and the scope display. This yields an instrument that responds instantly to pan and zoom controls while exploring the acquired data. MegaZoom technology combines update rate, instant control response, and deep-memory innovations to allow you to capture long time periods with high sample rates, and instantly zoom in on the signal details of interest either while stopped or running. Deep-memory, front-panel responsiveness and display update rate are combined into one oscilloscope, with no special mode or memory depth selection.

MegaZoom Technology's Deep Memory Improves Timing Resolution

The HP MegaZoom technology used in the HP 54645A/D oscilloscopes keeps the sampling rate at the maximum for all sweep speeds of 500 $\mu\text{s}/\text{div}$ and faster in Single mode, and 200 $\mu\text{s}/\text{div}$ and faster in Run mode.

Deep Memory

The primary advantage of a deep-memory oscilloscope is sustained sample rate, allowing you to capture at the maximum sample rate and capture a much longer time window. For example, you may want to capture a fast digital event, such as an interrupt line being asserted, while being able to look far out in time to see when the line was de-asserted. This may require a fast sample rate to examine the signal fidelity of the interrupt edge, and also long-time capture to determine how long the interrupt line was asserted.

Another advantage is the ability to capture relatively longer periods of time or slow time-per-division settings at an adequate sample rate. This allows you to capture a long event, such as an oscillator starting up, or two events separated by a long time, such that you can see the entire time frame of interest. To see the event, the scope must have captured the information at a fast enough sample rate so that you can see the signal details of interest.

Oscilloscope Responsiveness

An important element of an oscilloscope is how responsive it is to control changes. After a control is changed, such as the time/division, if you must wait for the test instrument to respond, the feedback loop between the instrument and you can become difficult. You could confuse adjustments because of the delay between making a change to the instrument and seeing the effect of that change take place.

MegaZoom Technology

In MegaZoom technology, the primary task of processing acquisition memory into scope waveforms using proprietary display techniques is distributed to waveform translator hardware. The processor's primary responsibility is to scan the keyboard and manage I/O ports. Because the dedicated waveform translator can draw waveforms quickly, as opposed to a general-purpose processor, the other processor is dedicated to the user interface tasks. User input is acted upon immediately and the scope screen very quickly reflects the user's changes. This results in the highly-responsive MegaZoom scope display.

Display Update Rate

In analog oscilloscopes, the scope is “blind” while the electron beam is reset to the left side of the screen. Thus, the update rate of an analog scope seems high because the blind or dead time of the analog scope is low.

High update rate is advantageous because infrequent or random events that happen while the scope is blind are missed, and thus not displayed. Scope users often assume that their scope is capturing the entire waveform and that the update rate is perfect, when the scope display is actually missing some waveforms.

MegaZoom technology maintains high update rate by using parallel processing and memory segmentation. The MegaZoom oscilloscope flows samples into one area of acquisition memory, and in another area they are read out and processed into displayed samples. By doing this, the processing part of the update cycle does not miss any waveforms. This results in very fast update rate and a responsive user interface.

Display Modes

Remember how when using your analog oscilloscope you had to constantly adjust the brightness? You did this to see the desired level of detail in a signal, or sometimes to see the signal at all!

The brightness knob on the HP 54645A/D operates much like the brightness knob on your computer screen. You should set it to a level that makes for comfortable viewing, given the room lighting, and keep it there.

In the HP 54645A/D, you control the “detail” by selecting a display mode: Normal, Peak Detect, or Average. While you may want to change the display mode now and then, rest assured that you will not have to change it nearly as often as you adjusted the brightness of an analog scope. The waveform will never dim with low trigger rates or fast sweep speeds.

A discussion of display modes is best begun with a simple sample. Let’s assume that your digital scope is sampling at 200 MSa/s, yet is storing the samples at a 1-MSa/s rate. In this case, the scope can only store one out of every 200 samples.

- In a traditional digital scope system, HP uses a simple sample rate decimation algorithm: store the first sample, ignore 199, store a sample, ignore 199, etc.
- In dithered systems (HP 54600-family scopes), HP uses a powerful anti-aliasing display technique: one sample is chosen randomly from the first 200 and is displayed, then another sample is chosen randomly from the next 200 samples and is displayed, etc.
- In peak detect, the traditional scope searches the 200 samples for a maximum and minimum voltage value. Both the maximum and the minimum are displayed, and then the next 200 samples are searched. This method displays signal extremes.
- In smoothing, the average value of the 200 samples is stored into memory and displayed. Then the average value of the next 200 samples is displayed. This technique keeps track of the mean value of the signal over the sample interval.

With this background information, let’s examine the display modes of the HP 54645A/D Oscilloscopes.

Normal Mode

Normal mode is the display mode that you will use most of the time. For the majority of use models and signals, normal mode yields the best scope picture of the waveform.

In the case of the HP 54645A/D, the analog channels can have up to 1 million samples behind the 4,000-point scope display. Some compression of samples to display points is obviously necessary.

Normal mode follows the model of the dithered system described earlier. In this case, random sample decimation is used to determine which points will be displayed. At many sweep speeds, the HP 54645A/D captures many more points than can be displayed—in these cases, some points will not be displayed. This can present a problem if you are interested in capturing a narrow event relative to the time window of interest. Keep in mind that this narrow pulse may not be displayed, through it has been captured, because of the sample compression. Consider the following example.

In this example, we are attempting to capture a pulse with a width of ~50 ns, and the scope is sampling at 200 MSa/s (5 ns/sample). We should get about 10 samples on the pulse of interest. We have captured 1,000,000 sample points and are displaying a 4,000-point display record. This means that the dithering scheme is required to pick 1 out of 250 points to display ($1,000,000 / 4,000$). In the following figure, note that the narrow pulse is not displayed.

Figure 4-1

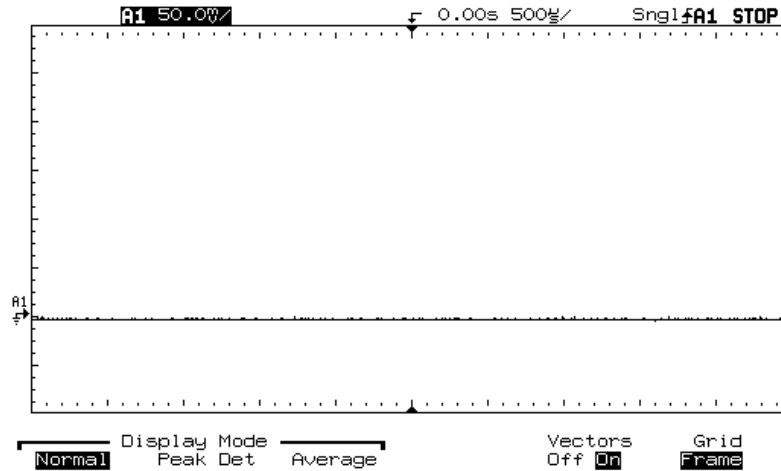

Attempting to Capture Narrow Pulse

As you change the Time/Div setting (zoom in), and look at a smaller time window around the trigger, the percentage of the acquired samples to the percentage of the displayed samples increases. For example, at 2 µs/div (20 µs/div across the screen), we now display every sample acquired in that time window (20 µs / 5 ns = 4,000 samples). By zooming in to this range, we can see the pulse of interest.

Figure 4-2

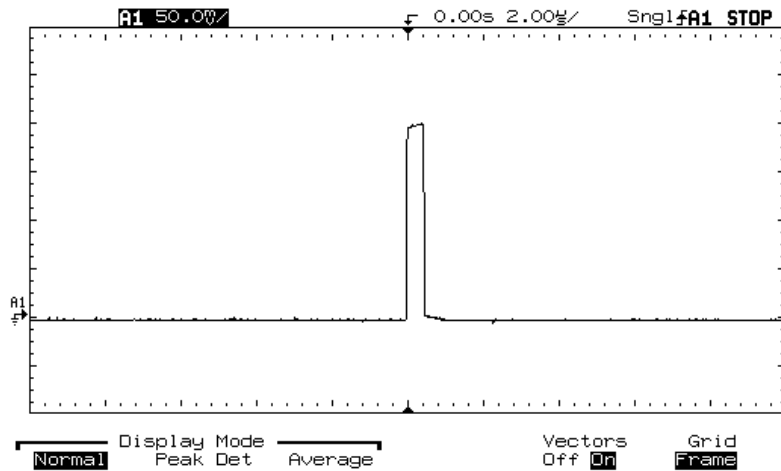

Zooming the Waveform to View Narrow Pulse

Between the 500- μ s/div picture (figure 4-1), and the 2- μ s/div picture (figure 4-2), whether or not the pulse or some part of the pulse is displayed is simply a statistical problem. For every new sweep speed, a new ratio of displayed-versus-sample points is necessary to provide the “best” representative picture. Thus, you may see part of the pulse at one sweep speed, and it may disappear at the next sweep speed.

Whether the scope is stopped or running, you see more detail as you zoom in. As you zoom out, you see less detail. To keep from losing detail as you zoom out, switch to peak detect.

Peak Detect

In peak detect display mode, it's as though the brightness knob is set to infinity. Any noise, peak, or signal wider than 5 ns will be displayed, regardless of the Time/Div setting. In Normal display mode, at faster than 2 μ s/div, you would see a 5-ns peak, so Peak Detect has no effect at faster than 2 μ s/div. Note that the **Pk** status indicator is not highlighted in this case.

Consider our previous example, with the scope now in peak detect display mode. The narrow pulse would always be displayed because the narrow pulse samples would be considered the maximum value for the given set of samples. Also note that as we zoom out or in, the narrow pulse would always be displayed.

Traditionally, in peak detect mode, the only data displayed on the screen has been the peaks. This can be a disadvantage because all noise or peaks wider than the minimum peak detect time are always displayed on the scope screen. This tends to make the signal look noisier than it really is because emphasis is given to the peaks.

Peak Detection Prevents Aliasing

Aliasing produces misleading information. The peak detection circuitry in the HP 54645A/D helps to prevent aliasing by identifying additional transitions that occur between logic samples. Because of the high sample rate of the HP 54645A/D MegaZoom technology, you should not see aliasing.

Consider the following example.

The following picture shows a simple square wave with the scope in peak detect mode at $1 \mu\text{s}/\text{div}$.

Figure 4-3

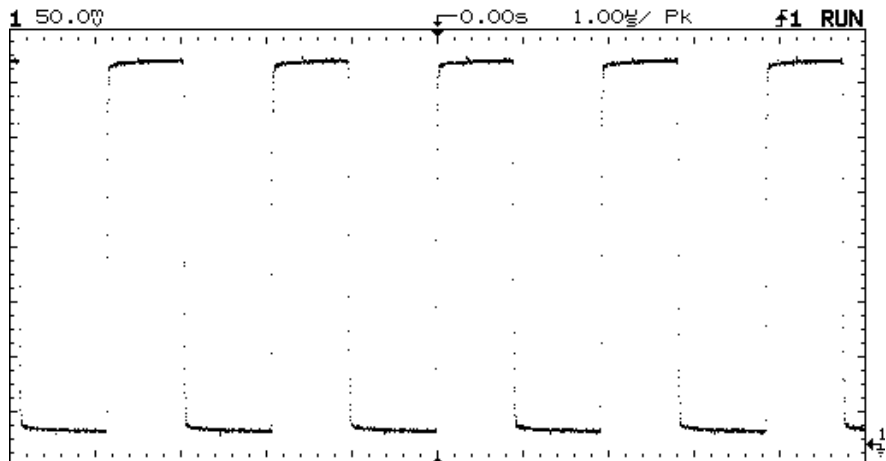

Simple Square Wave in Peak Detect Mode on HP 54600

Now consider the same waveform at 200 $\mu\text{s}/\text{div}$. All that remains is the signal's maximum and minimum values. This could lead you to believe the signal transitioned very infrequently because of the lack of any intermediate signal values.

Figure 4-4

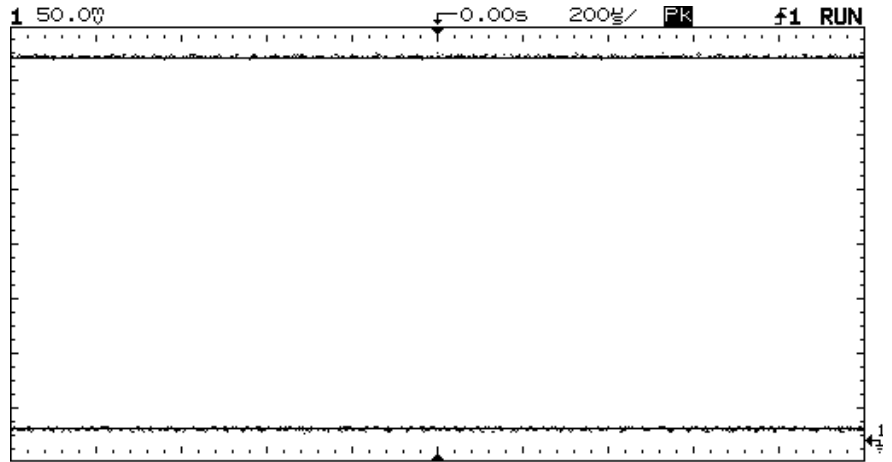

Same Square Wave in Peak Detect Mode at 200 $\mu\text{s}/\text{div}$ on HP 54600

The HP 54645A/D goes one step further in peak detect mode. In addition to the maximum and minimum values, the HP 54645A/D includes some “normal” or dithered samples. Note the same picture at 200 $\mu\text{s}/\text{div}$ on the HP 54645A/D as shown above.

Figure 4-5

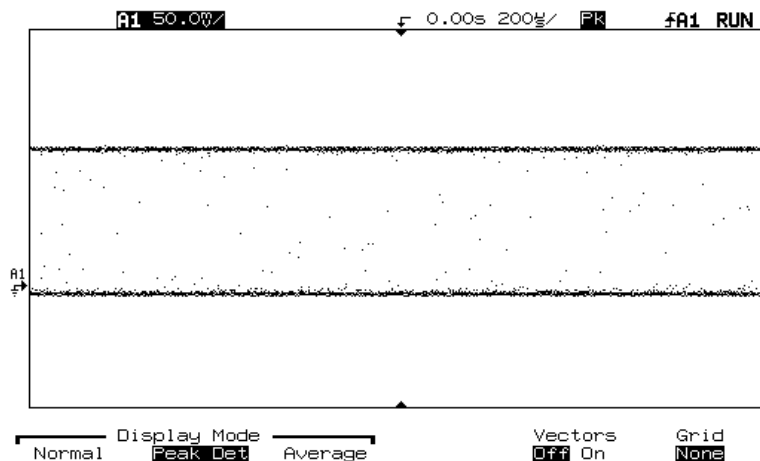

Same Square Wave on HP 54645D

The maximum and minimum values are displayed in addition to some normal samples. The additional normal samples here give you a better understanding of the actual waveform by showing you the signal transitions in addition to the maximum and minimum values.

Changing Display Modes While Stopped

One of the benefits of the HP 54645A/D is that you can change display modes after you acquire data. You can switch from peak detect to normal display mode. If you acquire data in normal mode, then switch to peak detect, you will see all the peaks in memory. However, you are not guaranteed to see every 5-ns peak. This allows you to view the data differently, without having to re-acquire the information.

Using Peak Detect and Autostore

Peak Detect includes both normal and peak detect samples. Using Peak Detect and Autostore together is a powerful way to find spurious signals and glitches.

Peak Detect versus Normal on HP 54645D Digital Channels

In a digital system design, a glitch is an unintentional or unexpected signal transition which may or may not pass through the logic threshold. The HP 54645D supports capturing glitches on digital channels during data acquisition. However, because the scope cannot determine whether the transition was valid, it defines the concept of a glitch differently. The scope considers a glitch to be any set of two or more edges that pass through the logic threshold and fall between logic samples.

Digital channels are not affected by the peak detect display mode. Digital channels will always display glitches—multiple logic transitions between logic samples—as shown in the following figure.

Figure 4-6

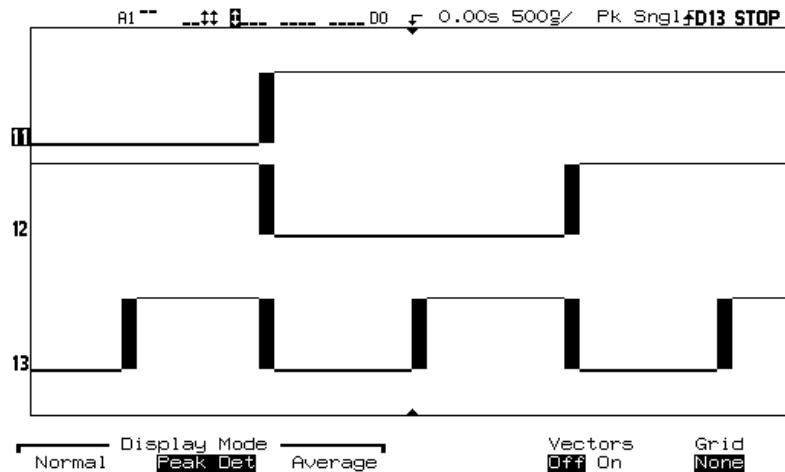

HP 54645D Shows Glitches

Note that the glitches are indicated by the filled-in boxes of the waveform. You can often get more timing resolution on these channels by re-acquiring the data at a faster sweep speed.

Average Mode

Averaging is a way to pull the signal out of the noise. Averaging works better than either a bandwidth limit or a brightness control. The averages you can select include "Smoothing", 4, 8, 16, 32, 64, 128, and 256.

Smoothing is an oversampling technique, and operates as described in the "Display Modes" section in this chapter. Smoothing is the opposite of peak detect: as the sweep speed slows, the samples are averaged together to form a single sample, effectively suppressing noise. Smoothing also allows averaging on a single trigger.

When smoothing is used, the slower the sweep speed, the greater the number of samples that are averaged together for each display point. The slower the sweep speed, the smoother the trace is on the scope display.

Recall that in normal display mode, at sweep speeds faster than 2 $\mu\text{s}/\text{div}$, you see all the 5-ns samples, and thus peak detect has no effect. The same is true of smoothing. It will have no effect at sweep speeds of 2 $\mu\text{s}/\text{div}$ and faster. Note that the Av status indicator is not highlighted.

Averaging: 4, 8, 16, 32, 64, 128, 256 lets you average multiple triggers together to reduce even more noise than can be achieved on the scope display. The number indicates the number of triggers to be averaged together. The higher the number, the more noise reduction that will be accomplished. This will average a number of "smoothed" triggers together.

The average displayed on the scope screen is a "display average." This means that all the data used to obtain the average display is not retained by the scope. Thus, if you want to pan and zoom the averaged waveform, only the last smoothed data is displayed. See "Recovering the Waveform on the Screen" in this chapter for more information.

Vectors On/Off

One of the most fundamental choices you must make about your display is whether to draw vectors between the samples, or simply let the samples fill in the waveform. To some degree, this is a matter of personal preference, but it also depends on the waveform.

- Having vectors on slows the display of the oscilloscope. This works better for slower sweep speeds, peak detect or average displays, and signals with stable triggers.
- Having vectors off works better for fast sweep speeds, normal displays, or unstable triggers. Complex analog signals like video and eye diagrams show more intensity information with vectors off.

One of the benefits of the HP 54645A/D is that you can change display modes after you acquire data. You can turn vectors on and off, or switch from peak detect to normal display modes. If you acquire data in normal mode, then switch to peak detect, you will see all the peaks in memory. You are not guaranteed, however, of seeing every 5-ns peak.

Digital channels on the HP 54645D are not affected by the display menu. They are always displayed with peak detect and vectors on. They also only contain one trigger worth of information.

Vectors On considerations

When using single shot or when using pan and zoom, and data has been acquired at 200 Ms/s, Vectors On uses a modified sinc/x digital filter to connect samples. This filter gives the oscilloscope a single-shot bandwidth of 50 MHz (1/4th of the sample rate.) The memory depth of the HP 54645A/D gives you this sample rate at single-shot sweep speeds of 200 us/division and faster.

For data sampled slower than 200 Ms/s with Vectors On, simple linear connection of the samples is used.

Displaying Analog Channels After the Acquisition

The two scope channels are always acquired, so you can turn them on and look at them even if they were off during the acquisition. You can do math functions on channels that are turned off, but you cannot make measurements on them. If you are using cursors to make measurements manually, be sure you have the correct channel selected; it is easy to mistakenly measure the peak voltage of channel 1 with the Volts/Div and Position of channel 2.

The combination of events and displayed digital channels is described in the topic “To turn digital channels on and off (HP 54645D)” in chapter 2.

Pan and Zoom

The ability to pan (move horizontally) and zoom (expand or compress horizontally) an acquired waveform is important because of the additional insight it can reveal about the captured waveform. This additional insight is often gained from seeing the waveform at different levels of abstraction. You may want to view both the big picture and the specific little picture details.

The ability to examine scope waveform detail after the waveform has been acquired is a benefit generally associated with digital oscilloscopes. Often this is simply the ability to freeze the display for the purpose of measuring with cursors or printing the screen. Some digital scopes go one step further by including the ability to further examine the signal details after acquiring them by panning and zooming through the waveform.

There is no limit imposed on the zoom ratio between the sweep speed used to acquire the data and the sweep speed used to view the data. There is, however, a useful limit. This useful limit is somewhat a function of the signal you are analyzing.

In normal or average display mode, with vectors (connect-the-dots) off, you can zoom in to the point where there are no samples on the screen.

Obviously, this is far beyond the useful limit. Likewise, with vectors on, you can see the linear interpolation between the points, but again, this is of very limited value.

Zoom

The screen will contain a relatively good display if you zoom in horizontally by a factor of 1000 and zoom in vertically by a factor of 10 to display the information from where it was acquired. Remember that you can only make automatic measurements on displayed data.

In peak detect display mode, the useful limit is more apparent from the display. As we zoom in on peak detected data, we eventually see the resolution of the peak detected information. The appearance of the resolution limit differs based on whether vectors are on or off. With vectors on, the resolution limit in peak detect appears as shown in the following figure.

Figure 4-7

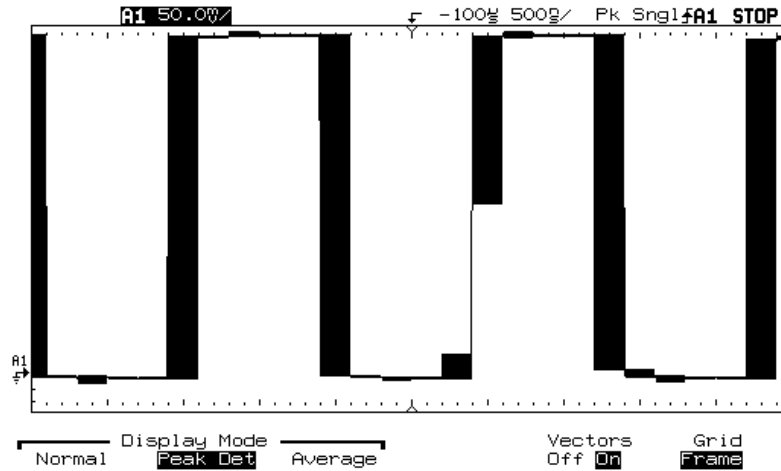

Resolution Limit in Peak Detect with Vectors On

In the display, the “boxes” indicate the peak detect uncertainty.

- Horizontally, the box indicates the time over which peak detect searched for minimum and maximum values.
- Vertically, the box indicates the maximum and minimum value.

These boxes apply to both digital channels on the HP 54645D and analog channels on the HP 54645A/D. These boxes also indicate that the scope could get better timing resolution if you re-acquired the data at a faster sweep speed.

With vectors off, the resolution limit appears as shown in the following figure.

Figure 4-8

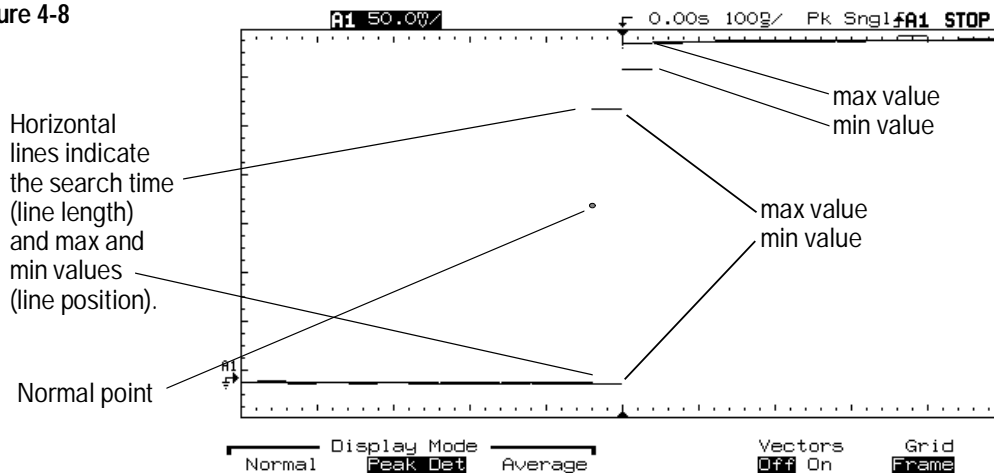

Resolution Limit in Peak Detect with Vectors Off

Recall that in peak detect, the HP 54645A/D shows both peak detect information and some “normal” points. In this figure, horizontal lines indicate both the time over which the max and min values were searched (line length) and the max and min values (line position—the upper line corresponds to the lower line in the same set of pixels). The normal points in the display show individual samples also acquired at the same time.

Recovering the waveform on the screen

In the HP 54645A/D, pressing **Run/Stop** freezes the screen. When either of the following occur, there will be several triggers of information on the screen.

- The scope is running at fast sweep speeds (1 μ s/div and faster).
For example, at 5 ns/div, the scope acquires 10 samples per trigger, and the display record will contain many different triggers.
- The scope is in average display mode, with averaging set to 4, 8, 16, 32, 64, 128, or 256.
The screen displays the set number of triggers averaged together, and the acquisition data for each trigger is not maintained. Only a screen representation exists.

In these two cases, you are still allowed to pan and zoom the waveform in acquisition memory. However, as you first pan or zoom, you may see your scope picture change to reflect the fact that only one trigger of acquired data is available on which to pan and zoom. You can re-display the original stopped screen by pressing **Setup** and **Recover Screen**.

At very slow sweep speeds of 200 ms/div and greater, if you press **Stop**, you may have two different partial acquisitions on the scope display. One of these is the last record, and the other is the partial newly-acquired record. If you then pan and zoom through the waveform, the pan and zoom occurs only on the newly-acquired record, not on the last record. Pressing **Recover Screen** here will only recover the newly-acquired record.

Changing the time reference position

1 Press Main/Delayed .

2 Choose the time reference position from the **Time Reference** softkeys:

- To set the time reference so that most of the acquired data follows the trigger, press **Left**.

The time reference indicator will be one division in from the left side of the display. The trigger event will be at the same location unless the delay is set to a value other than 0.

- To set the time reference so that the acquired data is centered around the trigger, press **Center**.

The time reference indicator will be at the middle of the display. The trigger event will be at the same location unless the delay is set to a value other than 0.

- To set the time reference so that most of the acquired data precedes the trigger, press **Right**.

The time reference indicator will be one division in from the right side of the display. The trigger event will be at the same location unless the delay is set to a value other than 0.

The time reference position sets the initial position of the trigger event within acquisition memory and on the display, with delay set to 0. The delay setting sets the specific location of the trigger event with respect to the time reference position. The time reference setting affects the delayed sweep as described in the following ways.

When the horizontal mode is set to Main, the delay positions the main sweep relative to the trigger. This delay is a fixed number. *Changing this delay value does not affect the sampling interval or sweep speed.* When the horizontal mode is set to Delayed, the delay controls the position of the delayed sweep window inside the main sweep display. This delayed delay value is independent of sampling interval and sweep speed.

The time reference indicates where the delay value is on the screen, and is the point about which the screen is expanded when you change the time per division. The delay setting sets the specific location of the trigger event with respect to the time reference position. *Thus, because the delay can be adjusted in the positive direction to greater than the depth of acquisition memory, the trigger event may or may not be stored in acquisition memory.* The range of available negative delay is less, and the trigger will always be in acquisition memory.

MegaZoom Concepts
Changing the time reference position

At 5 $\mu\text{s}/\text{div}$, we are sampling at 200 MSA/s (scope), and 400 MSA/s (digital).
When no delay value is set, and the time reference is set to Center, the trigger point is displayed at the center of the screen.

Consider a measurement where we want to view a signal from 30 μs before the trigger point, and 30 μs after the trigger point. In this measurement, we have the time reference set to Center, the sweep speed set to 5 $\mu\text{s}/\text{div}$, and the positive delay set to 30 μs . Setting a positive delay lets us look at the part of the signal that is to the right of the trigger point. When a single acquisition is performed, the result resembles:

Figure 4-9

The trigger event is off the screen to the left. Center screen shows the part of the signal to the right of the trigger.

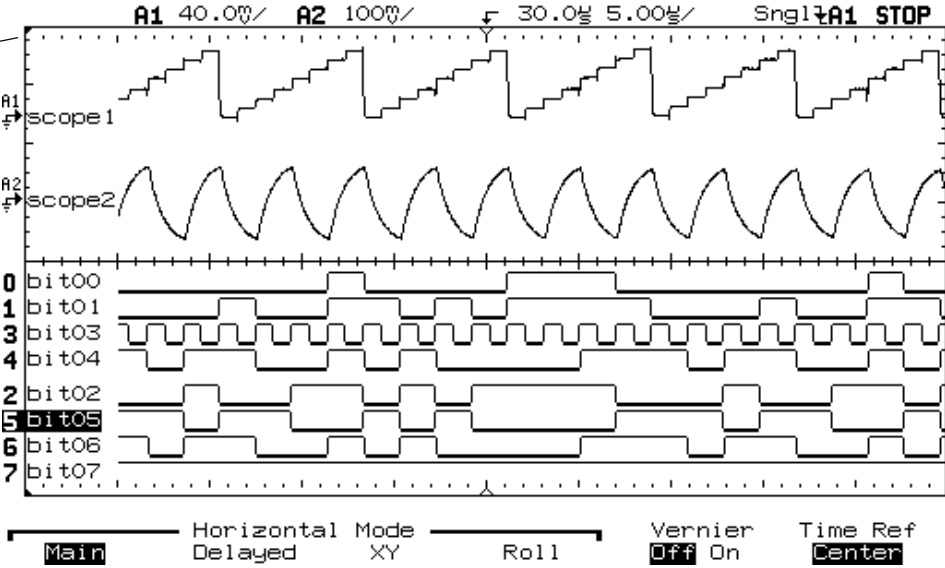

Single Acquisition, Time Reference Center, Positive Delay

When we pan the display (move it horizontally) back and set the delay to 15 μs , the trigger point is displayed on the screen. The part of the signal we see displayed at the center of the screen is to the right of the trigger point. The result resembles:

Figure 4-10

The trigger event is displayed on the screen. Center screen still shows part of the signal to the right of the trigger.

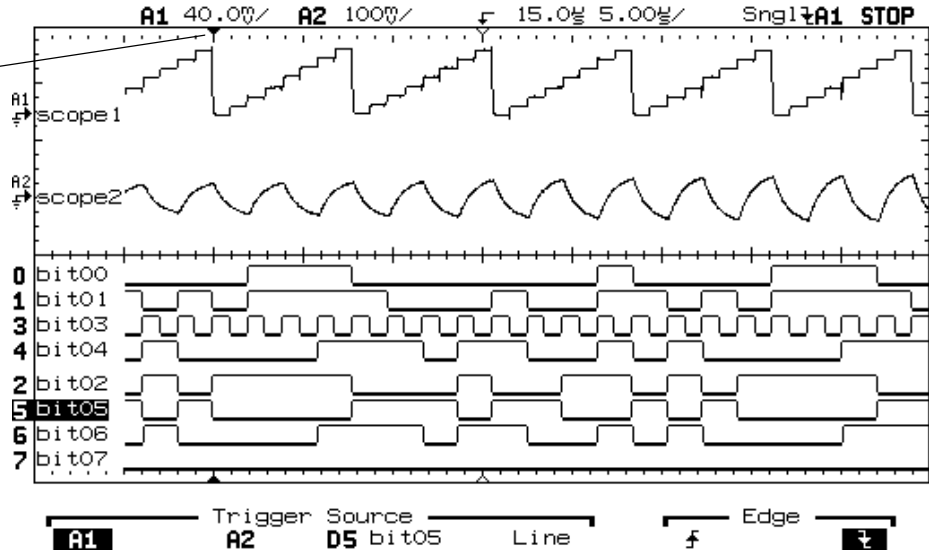

Panning the Display to View the Start of Acquisition

Notice the signal on A2 changing as we pan through the waveform. Panning through the waveform *is* a useful way to see the relationship between the trigger point and relative locations in acquisition memory. If you start a new acquisition after stopping and panning, the delay value to which you panned will be used in determining the trigger location for the new acquisition. For example, if you acquire data with a delay value of 100 μs , then stop and pan the display to 50 μs , the new acquisition will position the trigger 50 μs before the time reference point.

MegaZoom Concepts
Changing the time reference position

Setting a negative delay lets us look at the part of the signal to the left of the trigger point. Suppose we set the time reference to Right, with a sweep speed of $5 \mu\text{s}$, and a delay value of $-30 \mu\text{s}$. When we perform a single acquisition, the display resembles:

Figure 4-11

The trigger event is off the screen to the right. Center screen shows part of the signal to the left of the trigger.

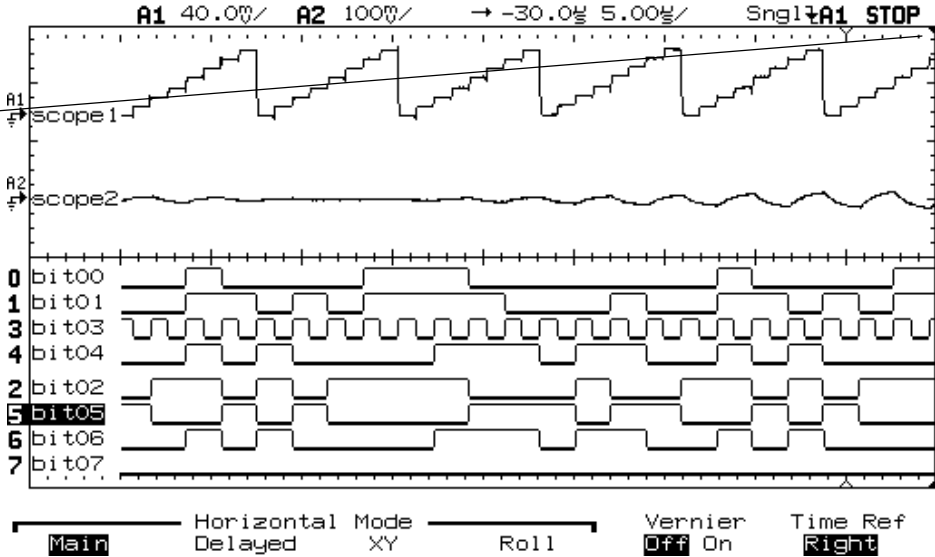

Single Acquisition, Time Reference Right, Negative Delay

If we set the time reference to center, then pan the display back to set the delay to 0 μ s, the trigger point is displayed at center screen, and the result resembles:

Figure 4-12

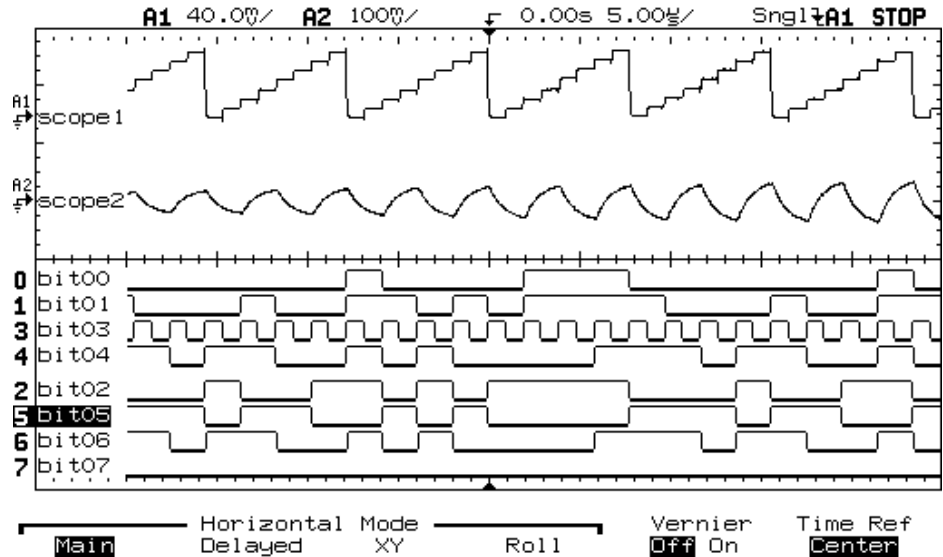

Panning the Display to View the Trigger Point

Here, the trigger point is in memory. For more information on the specific limits available under delayed sweep, see the chapter “Performance Characteristics.”

Varying the Time/Div Setting

When you vary the Time/Div setting during Run mode, remember that the sample period may also be adjusted. If, for example, you rapidly change the Time/Div setting to a higher value (slower sweep speed), the sample period is also lengthened, and it will take longer to fill acquisition memory. The previous acquisition is first redrawn on the screen at the new Time/Div setting before starting a new acquisition. Thus, there may be a short delay before a complete screen of data is displayed.

To determine the sample rate, press .

Post Acquisition Processing

In addition to changing display parameters after the acquisition, all of the measurements and math functions can be done after the acquisition. The measurement and math functions will be re-calculated as you pan/zoom and turn on/off channels.

As you zoom in and out on the signal, you affect the resolution of the display, and the resolution of functions and measurements. For example, if you do an FFT on a channel, it is done on the points on the screen. As you pan through the waveform (change the delay), you can look at the spectrum as a function of time. As you zoom in on the signal, the effective sample rate increases and the frequency span increases (the resolution decreases). As you zoom out, the effective sample rate decreases, and the frequency span decreases (the resolution increases).

One of the benefits of the HP 54645A/D is that you can change display modes after you acquire data. You can turn vectors on/off, or switch from peak detect to normal display modes. If you acquire data in normal mode, then switch to peak detect, you will see all the peaks in memory. You are not guaranteed to see every 5-ns peak.

Run/Stop/Single/Autostore/Erase Operation

During an acquisition, the oscilloscope examines the input voltage at each input probe.

- For analog channels on HP 54645A/D, the input voltage is determined by the Volts/Div settings.
- For digital channels in the HP 54645D, at each sample, the scope compares the input voltage to the logic threshold. If the voltage is above the threshold, the oscilloscope stores a “1” in sample memory; otherwise, it stores a “0.”

To control the HP 54645A/D acquisition process, you can do the following:

- Perform continuous acquisitions by pressing the Run/Stop key, and stop the acquisitions by pressing Run/Stop again.
- Take exactly one acquisition, then stop, by pressing the Single key.
- Store the results of several acquisitions by pressing Autostore.
- Erase the results of all acquisitions by pressing Erase.

Acquiring Data

The HP 54645A/D operates like an analog scope, but it can do much more. Spending a few minutes to learn some of this capability will take you a long way toward more productive troubleshooting.

Single versus Run/Stop

The HP 54645A/D both have a Single key and a Run/Stop key. When you press Run/Stop, the trigger processing rate is optimized over memory depth. Single always uses the maximum memory available. When you press Single, the oscilloscope has at least twice as much memory as when running repetitively. Because more memory is available when using Single at slow sweep speeds, the scope will have a greater sample rate.

When running, then pressing Stop, the oscilloscope simply stops, and several triggers of information could be displayed on the screen. This will happen in several cases:

- At very fast sweep speeds ($2 \mu\text{s}/\text{div}$ and faster), you might see less than a full screen of data per trigger. In this case, we build a picture from several triggers. Doing this provides a more accurate and responsive display than mathematically interpolating between points.
- With Average display mode on, several triggers are averaged together to reduce noise.
- When using Autostore, all triggers remain on the screen.
- At very slow sweep speeds ($1 \text{ s}/\text{div}$), part of the last trigger may still be on the screen when you press Stop.

Memory Depth/Record Length

Run/Stop versus Single

The HP 54645A/D both have a Single key and a Run/Stop key. When you press Run, the trigger processing or update rate is optimized over memory depth. When you press Single, memory depth is maximized.

Single

For a single acquisition, all available memory is filled with each acquisition, regardless of sweep speed. To acquire data with the longest possible record length, use Single.

Running

When running, versus taking a single acquisition, the 1M of memory is divided in half. This allows the acquisition system to acquire one record while processing the next acquisition, dramatically improving the number of waveforms per second processed by the scope. While running, maximizing the rate at which waveforms are drawn on the display provides the best picture of your input signal.

At fast sweep speeds, not all of the acquired points fit on the screen. Numerically, $500,000 \text{ points} * 1 / 200 \text{ MSa/s} = 2.5 \text{ ms}$ of data, or divided by 10 divisions = $250 \mu\text{s/div}$. This means that at time base settings of $200 \mu\text{s/div}$ and faster, the 500,000-point acquisition memory can hold an acquired record that is wider than the time across the screen.

Given that this is the case, we now have two options:

- We could acquire a full 500,000 points for every acquisition, resulting in some samples being “off screen.”
- We could decrease the acquired record size, only filling a fraction of the available 500,000 points.

When continuously running, the scope will automatically decrease the record sizes at the faster time base settings to further increase screen update rate. Acquiring off-screen data takes time and decreases the number of waveforms per second to the screen.

Unfortunately, this approach would result in smaller records for subsequent pan-and-zoom explorations. To address this shortcoming, when the Stop key is pressed, the scope reconfigures itself to take one last acquisition using all of the available memory (500,000 points) if another trigger is found. If, indeed, one more trigger is found within a short period of time (~ 100 ms), the scope can use the longer record for pan/zoom. If a trigger is not found, the shorter record must be used.

In summary:

- Single acquisitions always acquire 1M of points.
- Running acquisitions that are aborted by pressing Stop will usually result in 500,000 points. To have a smaller record, the instrument would have to be set to a sweep speed of 200 $\mu\text{s}/\text{div}$ or faster, and have a trigger rate of less than 10 Hz.

To run and stop an acquisition

- To begin an acquisition, press the **Run/Stop** key.

The instrument begins acquiring data while searching for a trigger condition. The RUN indicator is shown in the upper-right corner of the display. If a trigger occurs, the acquired data is shown in the display.

- To stop an acquisition in process, press the **Run/Stop** key.

The instrument stops acquiring data, and the STOP indicator is shown in the upper-right corner of the display. If the instrument was triggered (even by auto triggering) and the pre-trigger and post-trigger buffers are full, the results are displayed on the screen. If the buffers are not full, the waveform display area will show nothing.

To take a single trace

- Press **Single**.

The oscilloscope starts the acquisition system and begins searching for the trigger condition.

When the oscilloscope is in Autostore mode (see “To use Autostore”) pressing Single adds the results of the new acquisition to the current display contents.

Auto Single

Auto-trigger will generate a trigger for you if one is not found in the predetermined time from when the trigger system is armed. To take a single-shot acquisition, and you are not particularly interested in triggering the acquisition (for example, if you are probing a DC level), set **Trigger Mode** to **Auto** and press the **Single** key. If a trigger exists, it will be used; if a trigger does not exist, an untriggered acquisition will be taken.

To capture a single event

To capture a single event, you need some previous knowledge of the signal to set up the trigger level and slope. For example, if the event is derived from TTL logic, a trigger level of 2 volts should work on a rising edge. These steps show you how to use the oscilloscope to capture a single event.

- 1 Connect a signal to the oscilloscope.
- 2 For HP 54645A, set up the trigger.
 - a Press **Source** . Select a trigger source.
 - b Press **Mode/Coupling** . Set **Trigger Mode** to **Normal**.
 - c Turn the trigger Level knob to the trigger threshold where you think the trigger should work.
- 3 For HP 54645D, set up the trigger.
 - a Define an edge, pattern, or advanced trigger.
 - b Press **Mode/Coupling** . Set **Trigger Mode** to **Normal**.
 - c If you are using the analog channels to capture the event, turn the trigger Analog Level knob to the trigger threshold where you think the trigger should work.

4 Press **Single** .

Pressing **Single** arms the trigger circuit. When the trigger conditions are met, data appears on the display, representing the data points that the oscilloscope obtained with one acquisition. Pressing the **Single** again re-arms the trigger circuit and erases the display.

Operating Hints

When **Trigger Mode** is set to **Auto** or **Auto Lvl** (auto-single mode), each time **Single** is pressed the oscilloscope will wait for a valid trigger. If no trigger is found after about 40 ms, the oscilloscope will force a trigger, acquiring whatever signal is present. This is a handy mode to look for totally unknown situations.

When **Trigger mode** set to **Normal**, pressing **Single** will arm the trigger circuit and do a single acquisition when a valid trigger is seen.

You can use trace/pixel memories to compare several single-shot events. See the "Saving and Recalling Configuration" section later in this chapter.

To use Autostore

With Autostore or infinite persistence, the scope updates the display with new acquisitions, but does not erase the results of previous acquisitions. Rather than being erased by subsequent acquisitions, each pixel memory location turned on by a previous acquisition is turned into a pixel in half-bright. Thus, the results of all previous acquisitions are displayed in half-bright, with the latest acquisition in full-bright.

Autostore is useful in a number of applications, including these:

- Display the worst-case extremes of varying waveforms.
- Capture and store waveforms.
- Measure noise and jitter.
- Capture events that occur infrequently.

The “Store” indicator is displayed at the right end of the status line when Autostore is selected.

To Autostore Multiple Events

- To turn on Autostore, press the key.
- To turn off Autostore while in run mode, press again.

To Autostore Multiple Single Events

To Autostore single events, you first need to configure the instrument to do single Autostores.

- 1 Press **Autostore** to put the instrument in Autostore mode.

This causes the instrument to run.

- 2 Press **Single** to take a single autostored acquisition.

After the single acquisition, the scope will stop.

- 3 You may want to press **Erase** to display a clean screen.

- 4 Now pressing the **Single** key will result in an autostored single trigger.

Each single trigger will be added to the accumulated Autostore results on the screen.

To erase the waveform display

- Press **Erase** .

Acquisition memory and the current display are immediately erased. If the instrument is in Run or Autostore mode, however, and the oscilloscope finds a trigger condition, the display will be quickly updated after the erasure.

Summary of Oscilloscope Storage Keys

Run—acquires data and displays the most recent trace.

Stop—freezes the display.

Single—acquires a single trace.

Autostore—acquires data, displaying the most recent trace in full-bright and previously acquired waveforms in half-bright.

Erase—clears the display.

Using Digital Channels to Probe Circuits

You may encounter problems when using the HP 54645D that are related to probing. These problems fall into two categories: probe loading and probe grounding. Probe loading problems generally affect the circuit under test, while probe grounding problems affect the accuracy of the data to the measurement instrument. The design of the HP 54645D probes minimizes the first problem, while the second is easily addressed by good probing practices.

Input Impedance

The logic probes used in the HP 54645D are passive probes, which offer high input impedance and high bandwidths. They usually provide some attenuation of the signal to the oscilloscope. This is typically 20 dB.

Passive probe input impedance is generally specified in terms of a parallel capacitance and resistance. The resistance is the sum of the tip resistor value and the input resistance of the test instrument (see the following figure). The capacitance is the series combination of the tip compensating capacitor and the cable plus instrument capacitance in parallel with the stray tip capacitance in parallel with the stray tip capacitance to ground. While this results in an input impedance specification that is an accurate model for DC and low frequencies, the high-frequency model of the probe input is more useful (see the following figure). This high-frequency model takes into account pure tip capacitance to ground as well as series tip resistance, and the cable's characteristic impedance (Z_0).

Figure 4-13

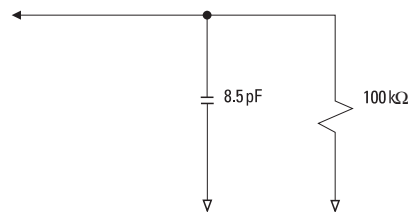

DC and Low-Frequency Probe Equivalent Circuit

Figure 4-14

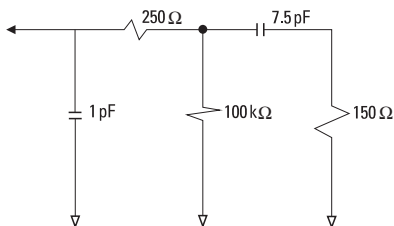

High-Frequency Probe Equivalent Circuit

The impedance plots for the two models are shown in these figures. By comparing the two plots, you can see that both the series tip resistor and the cable's characteristic impedance extend the input impedance significantly. The stray tip capacitance, which is generally small ($1\ \text{pF}$), sets the final break point on the impedance chart.

Figure 4-15

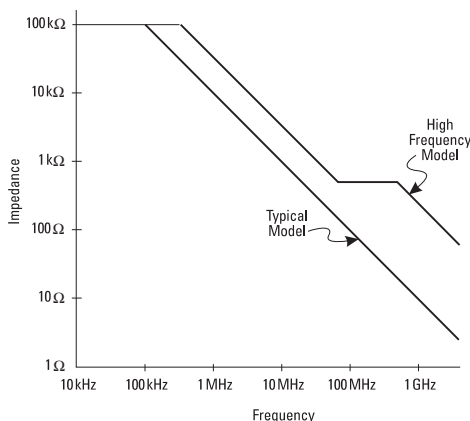

Impedance versus Frequency for Both Probe Circuit Models

The HP 54645D logic probes are represented by the high-frequency circuit model shown above. They are designed to provide as much series tip resistance as possible. Stray tip capacitance to ground is minimized by the proper mechanical design of the probe tip assembly. This provides the maximum input impedance at high frequencies.

Probe Grounding

A probe ground is the low-impedance path for current to return to the source from the probe. Increased length in this path will, at high frequencies, create large common mode voltages at the probe input. The voltage generated behaves according to the equation:

$$V = L \frac{di}{dt}$$

Increasing the ground inductance (L), increasing the current (di) or decreasing the transition time (dt), will all result in increasing the voltage (V). When this voltage exceeds the threshold voltage defined in the oscilloscope, a false data measurement will occur.

Sharing one probe ground with many probes forces all the current that flows into each probe to return through the same common ground inductance of the probe whose ground return is used. The result is increased current (di) in the above equation, and, depending on the transition time (dt), the common mode voltage may increase to a level that causes false data generation.

Figure 4-16

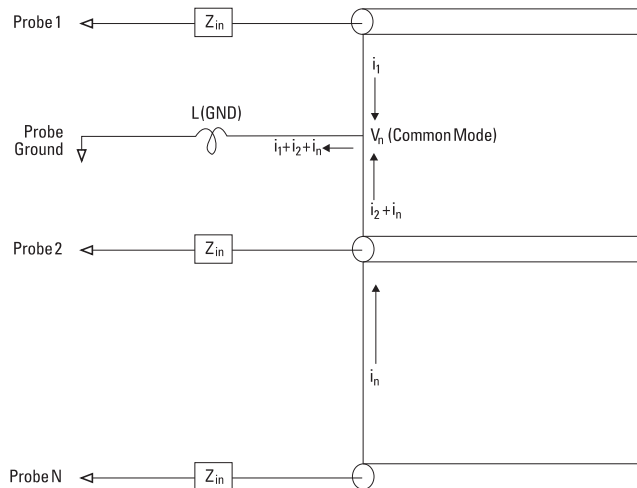

Common Mode Input Voltage Model

In addition to the common mode voltage—*ground bounce*—longer ground returns also degrade the pulse fidelity of the probe system. Risetime is increased, and ringing, due to the undamped LC circuit at the input of the probe, is also increased. Because the HP 54645D digital channels display reconstructed waveforms, they do not show ringing and perturbations. You will not find ground problems through examination of the waveform display. In fact, it is likely you will discover the problem through random glitches or inconsistent data measurements. Use the analog channels to view ringing and perturbations.

Best Probing Practices

Because of the variables L , di , and dt , you may be unsure how much margin is available in your measurement setup. The following are guidelines for good probing practices:

- The ground lead from each digital channel group (0-7 and 8-15) should be attached to the ground of the circuit under test if any channel within the group is being used for data capture.
- When capturing data in a noisy environment, every third digital channel probe's ground should be used in addition to the channel group's ground.
- High-speed timing measurements ($T_R < 3$ ns) should make use of each digital channel probe's own ground.

When designing a high-speed digital system, you should consider designing dedicated test ports that interface directly to the instrument's probe system. This will ease measurement setup and ensure a repeatable method for obtaining test data.

Saving and Recalling the Configuration

With the HP 54645A/D Oscilloscopes, you can save traces and the oscilloscope setup. Traces are stored in trace memories, and front-panel setups are stored in setup memories.

Using memories to save and recall configurations

Trace memory

Two trace memories, also called pixel memories, are available in the HP 54645A/D. These allow you to save the visible portion of the acquisition—the displayed waveform—for later recall and comparison with other measurements. To ensure repeatability of the measurement, should you decide to repeat it after recalling a result from trace memory, the setup is saved with the waveform, and can be independently recalled. The two setup memories associated with the trace memories are independent of the 10 regular setup memories.

The normal application for trace memory is quick comparison of measurement results. For example, you might make a measurement on a known good system, save the result in trace memory, then make the same measurement on a known bad system and recall trace memory to see the differences.

Add an Interface Module to Make Memory Non-Volatile

Trace memory is normally volatile—saved data will be lost when you turn the oscilloscope off. Adding an interface module, such as the HP 54650A HP-IB Interface, or HP 54652A/B or HP 54651A RS-232 Interface, makes the trace memory non-volatile—data is saved, even with the oscilloscope turned off.

The following figure shows the trace memory softkey menu on the HP 54645D Mixed-Signal Oscilloscope with the Measurement/Storage Module (HP 54659B) installed. Without the module, two trace memories are available, and the softkey labels show Trace Mem 1 and Trace Mem 2.

Figure 4-17

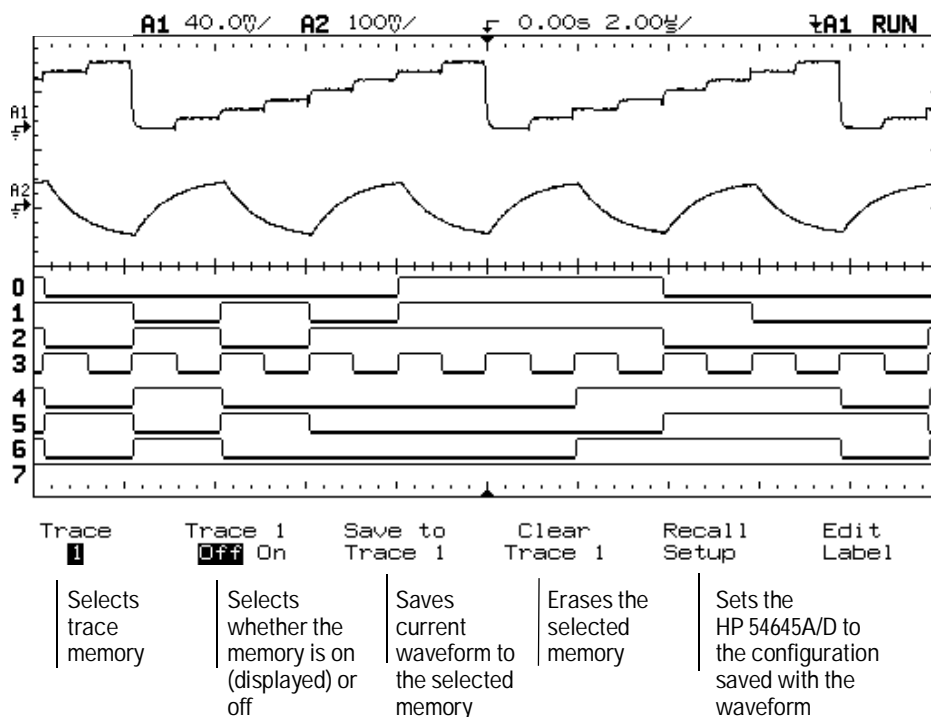

Trace Memory Softkeys on HP 54645D with HP 54659B Measurement/Storage Module Installed

Setup memory

The HP 54645A/D has 10 separate setup memories that allow you to save the current configuration of the instrument, including time base, threshold, channel settings, measurement definitions, and, for the HP 54645D, labels (not as independent label lists). These memories are non-volatile. They are best used for saving instrument configurations that you need later to verify the results of a change, or need regularly for test and troubleshooting.

For example, suppose that you use the HP 54645A/D in field testing of a system where ten separate tests are used. You can predefine the test configurations and save them in setup memories 1-10. You might also record the expected results as part of field test documentation. Then, a field service engineer can take the instrument, connect it to a customer system, recall each setup in turn, and compare the results to the expected results. This will save test time and will increase accuracy, because preconfiguration minimizes the chance for error.

The current acquisition results are not saved in the setup memory. To save acquisition results for later review and comparison, use the trace memory. The following figure shows the setup memory softkey menu on the HP 54645D Mixed-Signal Oscilloscope.

Figure 4-18

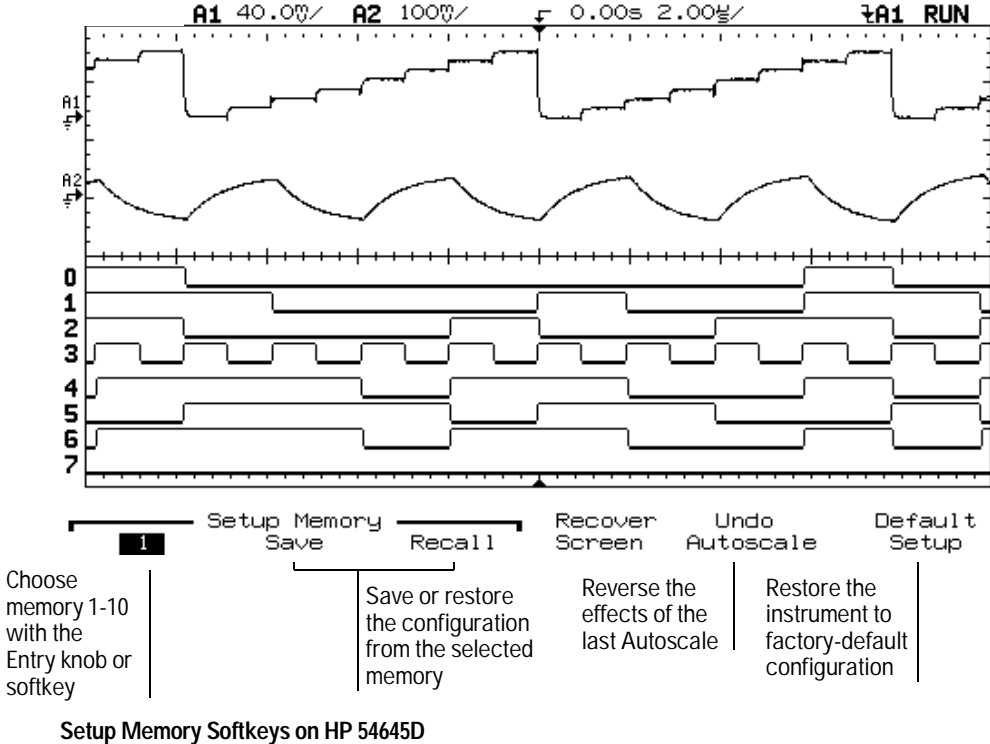

To save, recall, and clear traces

To save traces, two trace memories are available. The following exercise shows you how to store and recall waveforms from pixel memories.

- 1 Connect a signal to the oscilloscope and obtain a stable display.
- 2 Press **Trace** .

A softkey menu appears with trace memory selections.

Trace selects trace memories Mem1 or Mem2 (Trace 1 - Trace 100 if the oscilloscope has a Measurement/Storage module installed).

Trace Mem<N> turns on or off the selected trace memory.

<N> is the trace memory number.

Save to Mem<N> saves the displayed waveform to the selected trace memory. (Front-panel setups are saved to separate memory locations.)

Clear Mem<N> erases the selected trace memory.

Recall Mem<N> Setup recalls the front-panel setup that was saved with the waveform.

If a Measurement/Storage module is attached to the oscilloscope, 100 non-volatile trace memories are available.

Editing Trace Labels when Measurement/Storage Module is Attached

If a Measurement/Storage module is attached to the oscilloscope, an **Edit Label** softkey appears and allows you to change the trace memory labels.

- 3** Select a trace memory by pressing the **Trace** softkey.
- 4** Press the **Save to Mem<N>** softkey.
The current oscilloscope screen and setup are copied to the selected trace memory.
- 5** Press the **Trace Mem On** softkey to display memory.
The trace is displayed in half-bright video.
Automatic measurements do not operate on stored traces because stored waveforms are pictorial information, rather than stored data.
- 6** If you have not yet changed the oscilloscope setup, and want to make measurements, use the cursors.
- 7** If you changed the oscilloscope setup since you saved the display and setup to trace memory, press the **Recall Setup** softkey. Then, use the cursors to make the measurements.
- 8** To clear a trace memory, press the **Clear Mem<N>** softkey.

Trace Memory Operating Hint

The standard oscilloscope has volatile trace memories—saved data will be lost when you turn the oscilloscope off. Adding an interface module, such as the HP 54650A HP-IB Interface, or HP 54652A/B or HP 54651A RS-232 Interface, makes the trace memory non-volatile—data is saved, even with the oscilloscope turned off.

To save or recall front-panel setups

Ten memories are available to store front-panel setups. Saving front-panel setups can save you time in situations where several setups are repeated many times.

- 1 Press **Setup** .
 - 2 To change the selected memory location, press either the left-most softkey or turn the Entry knob.
 - 3 Press the **Save** softkey to save a front-panel setup, then press the **Recall** softkey to recall a front-panel setup.
-

To reset the HP 54645A/D instrument setup

- 1 To reset the instrument to the default factory-preset configuration, press **Setup** .
- 2 Press the **Default Setup** softkey.
- 3 To reset the instrument to the configuration that was present before pressing **Autoscale**, press the **Undo Autoscale** softkey.

Table 4-1

HP 54645A Factory-Preset Default Configuration Settings

Configuration Item	Setting
Cursors	Cursors off; time readout is selected; all cursors are set to time/voltage zero.
Trace memories	Both trace memory 1 and 2 are off; trace 1 memory is selected.
Graticule	Grid set to Full
Autostore	Off
Time base	Time reference center; main, not delayed sweep; vernier off; main and delay value 0; 100 μ s/div main time base; 500 ns/div delayed time base; sample rate is 200 MSa/s.
Display	Vectors On, Display Mode Normal.
Channels	Channel 1 on, Position 0 V, Volts/Div 100 mV.
Trigger Mode	Auto Level, Coupling DC, Reject Off, Noise Reject Off.
Trigger Condition	Rising edge of channel 1

Saving and Recalling the Configuration
To reset the HP 54645A/D instrument setup

Table 4-2

HP 54645D Factory-Preset Default Configuration Settings

Configuration Item	Setting
Cursors	Cursors off; time readout is selected; all cursors are set to time/voltage zero
Trace memories	Both trace memory 1 and 2 are off; trace 1 memory is selected
Graticule	Grid set to Full
Autostore	Off
Time base	Time reference center; main, not delayed sweep; vernier off; main and delay value 0; 100 μ s/div main time base; 500 ns/div delayed time base
Display	Vectors On, Display Mode Normal
Channels	Channel A1 on, Position 0 V, Volts/Div 100 mV
Labels	Labels off
Threshold	TTL (1.4 V) for all channels and external trigger input; channel 0-7 threshold is selected when menu is entered
Trigger Mode and Condition	Normal Trigger Mode with edge trigger, Coupling DC, Reject Off, Noise Reject Off
Edge Trigger	Rising edge on channel A1
Pattern Trigger	All channels don't care
Advanced Trigger	Default selection is Glitch, positive polarity, < 16 ns; overview menu off

Configuring the Mixed-Signal Oscilloscope

This section describes how to configure the following items for the HP 54645D Mixed-Signal Oscilloscope, including changing the logic threshold for input signals.

To change the logic threshold for input signals

- 1 Press **Label/Threshold** .
- 2 Press the **Threshold Menu** softkey to display the range of channels for which you want to set the logic threshold, and the available logic thresholds.
- 3 Press the **Set** softkey to select a group of digital channels.
You can set thresholds for digital channels **D0-D7** and **D8-D15**.
- 4 Press the **TTL**, **CMOS**, or **ECL** softkey to choose a preset threshold.
- 5 To set a different threshold, press the softkey just to the right of the **ECL** softkey (see the following figure). Then, vary the threshold voltage from -6.00 V to 6.00 V with the Entry knob.
- 6 If you want to set the threshold for the other group of channels, select the other group and do steps 4 and 5 again.
You can exit the threshold setting menu by pressing **Previous Menu** or another front-panel key.

Configuring the Mixed-Signal Oscilloscope
To change the logic threshold for input signals

Figure 4-19

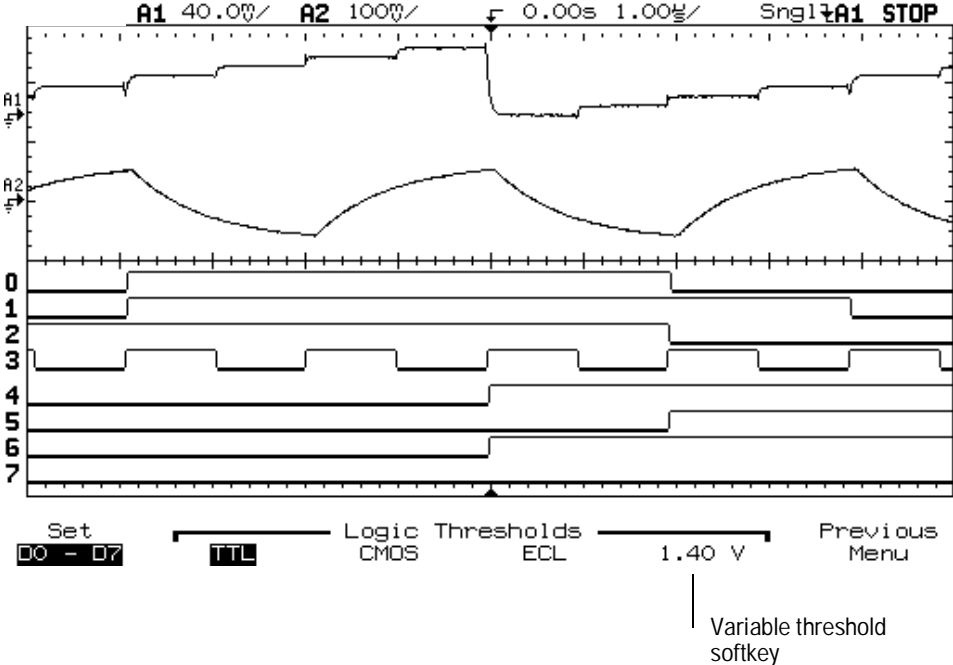

Logic Threshold Setup

The threshold voltage setting is used by the input comparators to determine whether an input signal is a logic low or logic high. The settings for each option are shown in the following table.

Table 4-3

Threshold Voltage Settings

Option	Voltage
TTL	1.40 V
CMOS	2.50 V
ECL	-1.30 V
Variable	Variable from -6.00 V to +6.00 V

Using Labels on the Mixed-Signal Oscilloscope

The HP 54645D Mixed-Signal Oscilloscope allows you to define and assign labels to each input channel. Or, you can turn labels off to increase the waveform display area.

To turn the label display on or off

- To display channel labels, press **Label/Threshold** , then press the **Labels On** softkey.
- To turn off channel labels display, press **Label/Threshold** , then press the **Labels Off** softkey.
- You can press **Label/Threshold** repeatedly to toggle the channel labels display.

To assign a predefined label to a channel

1 Press **Label/Threshold** .

2 Press the **Define Labels** softkey.

The following figure shows the label maker. A label definition menu is shown on the right-hand side of the display.

3 Select the channel for which you want to assign a label using the **Select** knob.

You can assign labels to channels that are off and to channels that are on.

4 Use the **Entry** knob to choose the label you want to assign from the **list of labels**.

The **Entry** knob moves the cursor through the label list, then through the character list. You can also define custom labels. The label list includes all predefined labels, and custom labels you have defined, unless it is re-initialized. See “To define a new label.”

5 Press the **Copy** softkey.

The selected label is transferred to the entry field.

6 Press the **Assign Label** softkey.

The label is assigned to the selected channel. If you have selected a predefined label, and the copy buffer is empty, pressing **Assign** again will assign the new label to the selected channel.

Label display is automatically enabled when you enter the **Define Labels** menu. Thus, if the labels were off, they are turned on while you define labels. If you exit the **Define Labels** menu, and the labels were off before you entered the menu, they are turned off when you exit.

Label Assignment Auto-Increment Features

When you assign a label ending in a digit, such as ADDR0 or DATA0, the oscilloscope automatically increments the digit and displays the modified label in the entry field. Then, the instrument changes the selected channel to the next channel turned on and displayed on the screen. Therefore, you only need to press the **Assign Label** key again to assign the label to the channel. Only the original label is saved in the label list. This feature makes it easier to assign successive labels to numbered control lines and data bus lines.

Using Labels on the Mixed-Signal Oscilloscope
To assign a predefined label to a channel

If you defined a new label, it is added to the non-volatile label list and will be saved with the oscilloscope configuration.

Figure 4-20

Scroll through the label and character lists using the Entry knob.

The entry field shows you what will be assigned to the channel.

Shows what will be put in the entry field when you press Copy.

Select the channel with the Select knob.

ALE	Cont	Load	Recv
AS_	DO	NMI	Reset
Ack	DS_	OE	STB
Addr0	DT/R_	Out	Send
BHE_	Data0	Pin_	Shift
BLE_	Dtack	Q0	Strobe
CAS_	EN	Q_	U_:_
CE	Enable	R/W_	U_P_
N	CNT	Halt	RAS
_P	CP	IO	RD
1MHz	CS_	IRQ	RDY
1kHz	CTL	In	REQ
A0	Clear	Int	RST
AD0	C1k	L	Read
ADS_	Clr	Latch	Ready
			scope1

ABCDEF GHIJ KLMNOPQRSTU VWXYZ
0123456789 !#/:<>[\]*+~`-
abcdefghijklmnopqrstuvwxyz

Copy Assign to 00

'Entry' Knob selects from both Label List and Characters List

Delete Character	Insert Space	Copy	Position	Assign Label	Previous Menu
Press to delete the character at the cursor in the entry field.	Press to insert a space in the entry field at the cursor.	Press to copy the label or character to the entry field.	Press to move the cursor through the entry field.	Press to assign the label to the channel.	

HP 54645D Label Definition Display

Label List Management

The label list contains 75 of the most recently used labels. The list does not save duplicate labels, nor does it save multiple labels that differ by, at most, two trailing numeric characters.

The label list is non-volatile. Thus, after you use the label list for a while, your labels will predominate, making it easier to customize the instrument display for your needs.

When you first begin using the instrument, there are some blank entries at the end of the label list. As you define custom labels, these spaces are filled. One blank space is always retained at the beginning of the list to allow entry of a new label. When you initialize the label list, all of your custom labels will be cleared, and the label list will be returned to its factory configuration.

To define a new label

1 Press **Label/Threshold** .

2 Press the **Define Labels** softkey.

A label definition menu is shown on the right-hand side of the display.

3 To use an existing label as the basis for the new label, use the **Entry** knob to choose a label from the list of labels. Then press the **Copy** softkey.

The Entry knob moves the cursor through the label list, then through the character list. The label list includes all predefined labels, and custom labels you have defined, unless it is re-initialized. When you press the Copy softkey, the selected label is transferred to the entry field.

4 To enter characters into the new label:

- a** Press the **Position** softkey until the cursor position in the entry field corresponds to the point where you want to replace a character.
- b** Enter or delete a character.
 - To enter a character, use the Entry Knob to choose a character from the character list. Then press the **Copy** softkey.
 - To insert a space, press the **Insert Space** softkey.
 - To delete the current character, press the **Delete Character** softkey. **Delete Character** deletes the character under the cursor and moves successive characters forward by one position.

5 Press the Assign Label softkey.

The label is assigned to the selected channel.

Label display is automatically enabled when you enter the Define Labels menu. Thus, if the labels were off, they are turned on while you define labels. If you exit the Define Labels menu, and the labels were off before you entered the menu, they are turned off when you exit.

To initialize the label list

1 Press **Label/Threshold** .

2 Press the **Initialize Label List** softkey.

A message appears, warning you that this operation will overwrite the current label list.

- To confirm the operation, press the **Yes** softkey. You will be prompted to press Yes again to initiate the operation.
- To cancel the operation, press the **No** softkey.

When you first begin using the oscilloscope, there are some blank entries at the beginning of the label list. As you define custom labels, these spaces are filled. One blank space is always retained to allow entry of a new label. When you initialize the label list, all of your custom labels will be cleared.

Making Measurements with
HP 54645A/D Oscilloscopes

Making Measurements with HP 54645A/D Oscilloscopes

By now you are familiar with the VERTICAL/ANALOG, HORIZONTAL, and TRIGGER groups of the front-panel keys. You should also know how to determine the setup of the oscilloscope by looking at the status line.

We recommend you perform all of the following exercises so you become familiar with the powerful measurement capabilities of the oscilloscope.

Concepts about the HP 54645A/D Oscilloscopes

Conceptual information about the HP 54645A/D Oscilloscopes is in the chapter “MegaZoom Concepts and Oscilloscope Operation.”

In the HP 54645A Oscilloscope, an 8-bit A/D converter converts the input waveform into an evenly-spaced series of voltage readings. These readings are made once for each sample, and are stored into memory in time-voltage pairs.

Main and Delayed Sweep

The delayed sweep display function magnifies the contents of sample memory—data used by the main and delayed sweep windows is acquired on a single acquisition; the data corresponds to the same trigger event. Using the delayed sweep window, you can zoom in on a portion of the waveform and examine it in greater detail. In delayed sweep, with HP 54645D, if scope channels are on, 8 logic channels can also be on. If scope channels are off, 16 logic channels can be on.

The delayed sweep operation in the HP 54645A/D is based on HP MegaZoom technology. Unlike analog oscilloscopes, the MegaZoom oscilloscope's delayed sweep is not a second acquisition, but an expansion of the same data displayed in the main sweep. MegaZoom technology makes this possible because of its deep memory. Also because of the deep memory in MegaZoom technology, it is possible to capture the main display at 1 ms/div, and redisplay the same trigger in the delayed display at 1 μ s/div—a 1000:1 zoom ratio.

When you enable the delayed sweep view, the oscilloscope divides the window into two portions. The upper part shows the waveform according to the main time base; the lower shows a small portion of the waveform magnified according to a second time base (the delayed sweep window). In the delayed sweep window, the Time/Div knob adjusts the magnification of the delayed sweep portion. The delayed sweep time base must be at least twice as fast the main time base, and can vary up to the maximum sweep speed of 2 ns/div for HP 54645A and 5 ns/div for HP 54645D. For example, at a main time base setting of 500 μ s/div, the delayed sweep time base will be adjustable from 200 μ s/div to 5 ns/div.

To use delayed sweep

To use delayed sweep

You can use the delayed sweep window to locate and horizontally expand part of the main sweep for a more detailed (high-resolution) analysis of signals. The following steps show you how to use delayed sweep. These steps are similar to operating the delayed sweep in analog oscilloscopes.

- 1 Connect a signal to the oscilloscope and obtain a stable display.
- 2 Press **Main/Delayed** .
- 3 Press the **Delayed** softkey.

Figure 5-1

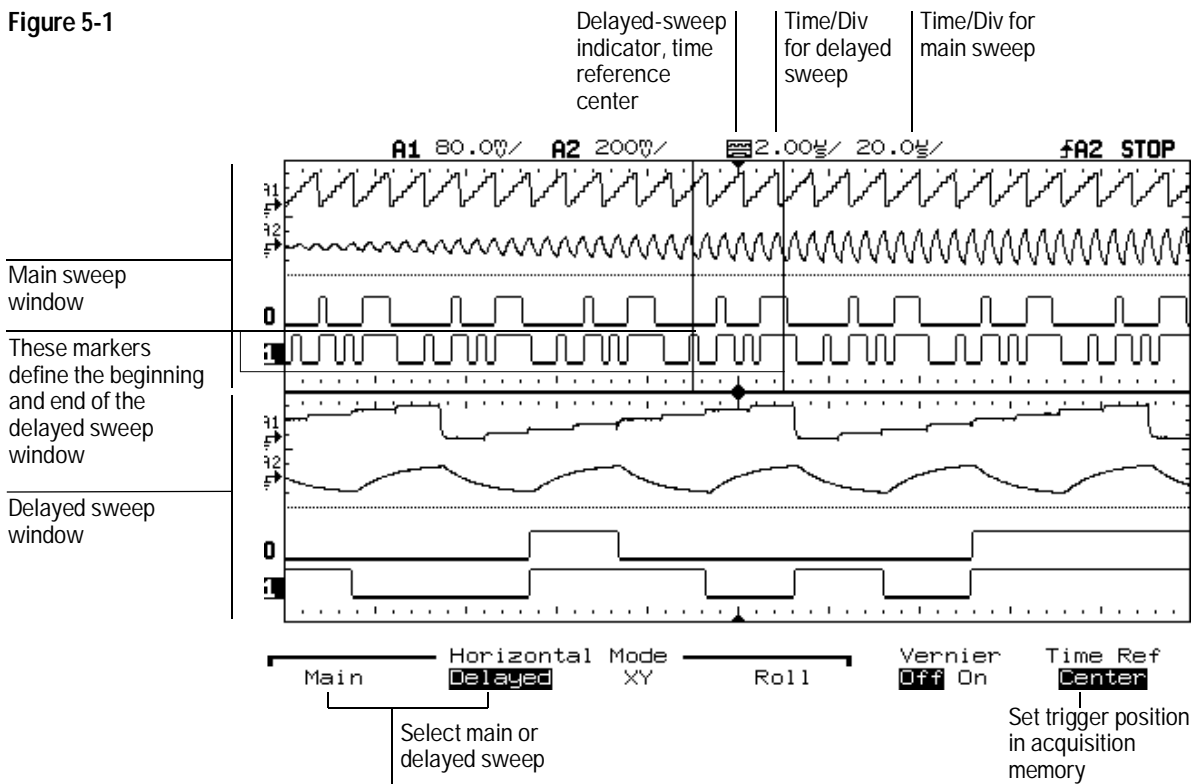

HP 54645D Showing Delayed Sweep

The screen divides in half. The top half displays the main sweep, and the bottom half displays an expanded portion of the main sweep. This expanded portion of the main sweep is called the delayed sweep. The top half also has two solid vertical lines called markers. These markers show what portion of the main sweep is expanded in the lower half. The size and position of the delayed sweep window are controlled by the Time/Div and Delay knobs.

The Time/Div next to the  symbol is the delayed sweep sec/div. The delay value is displayed for a short time at the bottom of the display.

Because both the main and delayed sweeps are displayed, there are half as many vertical divisions so the vertical scaling is doubled. Notice the changes in the status line.

- To display the delay value of the delayed time base temporarily at the bottom of the screen, press **Main/Delayed** .
- To change the delay for the delayed sweep window, turn the Delay knob.
- To change the Time/Div for the delayed sweep window, turn the Time/Div knob.
- To change the Time/Div for the main sweep window, select the main sweep mode. Then turn the Time/Div knob.

The point about which the delayed sweep window is expanded changes as Time/Div is varied:

- For a time reference setting of Left, the sweep expands from the left-hand side of the display.
- For a time reference setting of Center, the sweep expands about the center of the display.
- For a time reference setting of Right, the sweep expands from the right-hand side of the display.

To view asynchronous noise on a signal

The following exercise shows how to use the oscilloscope to view asynchronous noise on a signal that is not synchronous to the period of the waveform.

- 1 Connect a noisy signal to the oscilloscope and obtain a stable display.
This shows a waveform with asynchronous noise in the pulse.

Figure 5-2

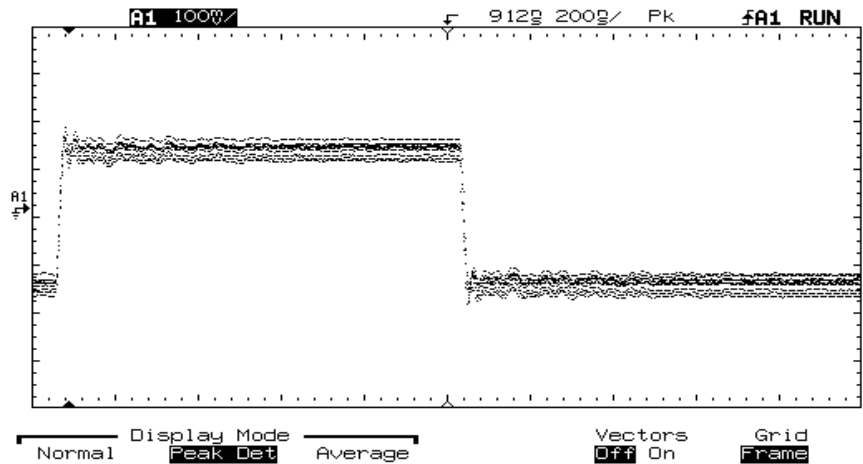

Asynchronous Noise in Pulse

- 2 Press **Autostore** .

Notice that **STORE** is displayed in the status line.

- 3 Set the trigger mode to normal, then adjust the trigger level into the noise region of the signal.
- 4 Decrease the sweep speed for better resolution of the asynchronous noise. Pan and zoom the waveform to view signal details.

To characterize the asynchronous noise signal, use the cursors.

The following figure shows a triggered view of asynchronous noise shown in the previous figure.

Figure 5-3

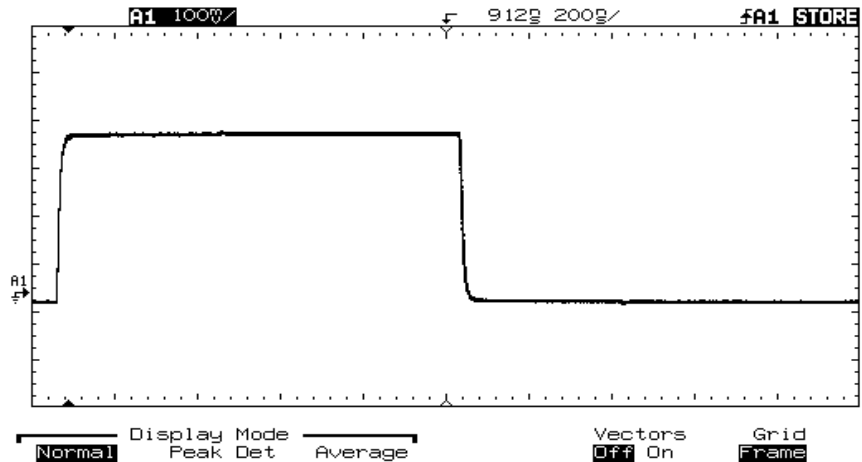

Triggered View of Asynchronous Noise

To reduce the random noise on a signal

If the signal you are applying to the oscilloscope is noisy, you can set up the oscilloscope to reduce the noise on the waveform. First, you stabilize the displayed waveform by removing the noise from the trigger path. Second, you reduce the noise on the displayed waveform.

- 1 Connect a signal to the oscilloscope and obtain a stable display.
- 2 Remove the noise from the trigger path by turning on either high-frequency reject or noise reject.

High-frequency reject (HF reject) adds a low-pass filter with the 3-dB point at 50 kHz. You use HF reject to remove high-frequency noise, such as AM or FM broadcast stations, from the trigger path.

Figure 5-4

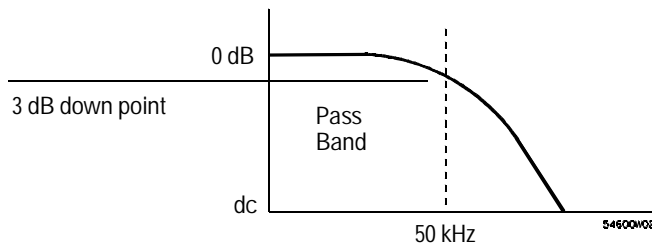

HF Reject

Refer to chapter 2, “Front-Panel Overview,” for more information.

Low-frequency reject (LF reject) adds a high-pass filter with the 3-dB point at 50 kHz. Use LF reject to remove low-frequency signals, such as power line noise, from the trigger path.

Figure 5-5

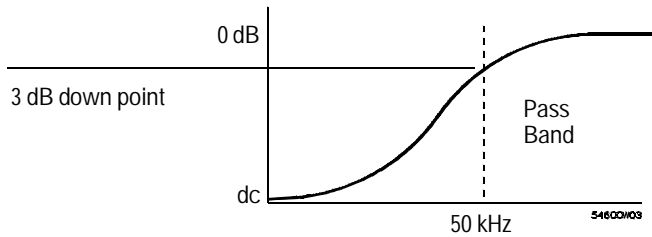

LF Reject

Noise reject increases the trigger hysteresis band. By increasing the trigger hysteresis band, you reduce the possibility of triggering on noise. However, this also decreases the trigger sensitivity so that a slightly larger signal is required to trigger the oscilloscope.

Figure 5-6

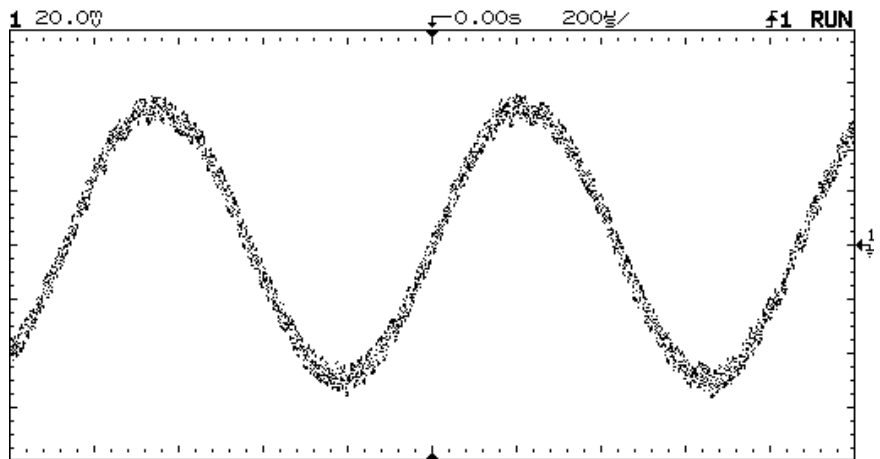

Random Noise on the Displayed Waveform

3 Use averaging to reduce noise on the displayed waveform.

- Press **Display**, then press **Average**.

Notice that **Av** appears in the status line.

- Toggle the **# Average** softkey to select the number of averages that best eliminates the noise from the displayed waveform.

Av in the status line indicates how much of the averaging process is finished, by turning to inverse video as the oscilloscope performs averaging. When the number of averages is higher, more noise is removed from the display. However, the higher the number of averages, the slower the displayed waveform responds to waveform changes. You must choose between how quickly the waveform responds to changes and how much you want to reduce the displayed noise on the signal.

Smoothing

The term “smoothing” is an oversampling technique used when the digitizer sampling rate (200 MSa/s) is faster than the rate at which we’re storing samples into acquisition memory. For example, if the scope is sampling at 200 MSa/s, yet storing the samples at 1 MSa/s, it needs to store only 1 out of every 200 samples. When smoothing is used, the slower the sweep speed, the greater the number of samples that are averaged together for each display point. This tends to reduce random noise on the input signal, which produces a “smoother” trace on the screen.

Figure 5-7

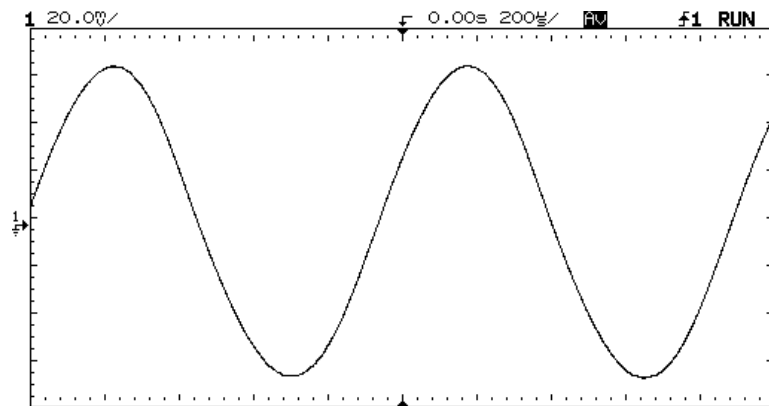

256 Averages Used to Reduce Noise

To capture glitches or narrow pulses with peak detect

A glitch is a rapid change in the waveform that is usually narrow as compared to the waveform.

Peak detect mode displays any signal wider than 5 ns, allowing you to find glitches and narrow spikes regardless of the sweep speed.

To capture glitches or narrow pulses:

- 1 Connect a signal to the oscilloscope and obtain a stable display.
- 2 Find the glitch. To select peak detect, press **Display**. Then, press the **Peak Det** softkey.

Peak detect operates at sweep speeds from 50 s/div to 2 ns/div. When operating, the initials Pk are displayed in the status line in inverse video. At sweep speeds faster than 2 ns/div, the Pk initials are not displayed in inverse video, which indicates that peak detect is not operating.

Use Autostore to:

- View waveforms that are changing.
- View and compare waveforms with stored waveforms.
- View narrow pulses or glitches that occur infrequently but require the use of sweep speeds outside the range of peak detect.
- Press **Autostore**.

Autostore retains the glitch on the display in half-bright video.

To use channel math

3 Characterize the glitch with delayed sweep.

To characterize the glitch with delayed sweep, follow these steps:

- Press **Main/Delayed** . Press the **Delayed** softkey.
- To obtain a better resolution of the glitch, expand the time base.
- Use the Delay knob to pan through the waveform to set the expanded portion of the main sweep over the glitch.

To characterize the glitch, use the cursors or the automatic measurement capabilities of the oscilloscope.

To use channel math

- 1 Press **±** . Then press either the **1+2** or **1-2** softkey.
- 2 To turn off the channel math function, press the **Off** softkey.

Additional Math Functions

For the HP 54645A/D Oscilloscopes, without a Measurement/Storage module installed, the available math options are addition and subtraction. Each of these functions is performed on the pixel position of the data on the screen.

With the Measurement/Storage module installed, two functions define these operations that create mathematically altered waveforms (not pixel math):

- Function 1 will add, subtract, or multiply the signals acquired on vertical inputs 1 and 2, then will display the result as F1.
- Function 2 will integrate, differentiate, or perform an FFT on the signal acquired on input 1, input 2, or the result in F1. It will then display the result in F2.

You can adjust the vertical range and offset of each function for ease of viewing and measurement considerations. Each function can be displayed, measured with cursors, stored in trace memory, or output over the interface. For more information about using math functions 1 and 2, refer to the *Measurement/Storage Module User's Guide*.

Mask Testing

When a Measurement/Storage module is installed in the oscilloscope, mask testing is available by pressing the **Mask Test** softkey. For more information about mask testing, refer to the *Measurement/Storage Module User's Guide*.

To use the Roll display mode

The horizontal Roll display mode causes the waveform to move across the screen from right to left. It only operates on time base settings of 200 ms/div and slower. If the current time base setting is faster than the 200 ms/div limit, it will be set to that limit when entering Roll display mode.

- Press **Main/Delayed**. Then press the **Roll** softkey.

To use the XY display mode

The XY display mode converts the oscilloscope from a volts-versus-time display to a volts-versus-volts display. You can use various transducers so the display could show strain versus displacement, flow versus pressure, volts versus current, or voltage versus frequency. This exercise shows a common use of the XY display mode by measuring the phase shift between two signals of the same frequency with the Lissajous method.

- 1 Connect a signal to channel 1, and a signal of the same frequency but out of phase to channel 2.
- 2 Press **Autoscale** , press **Main/Delayed** , then press the **XY** softkey.
- 3 Center the signal on the display with the Vertical Position (HP 54645A) or Analog Position (HP 54645D) knobs, and use the Volts/Div knobs and the vertical Vernier softkeys to expand the signal for convenient viewing.

$$\sin \theta = \frac{A}{B} \text{ or } \frac{C}{D}$$

Figure 5-8

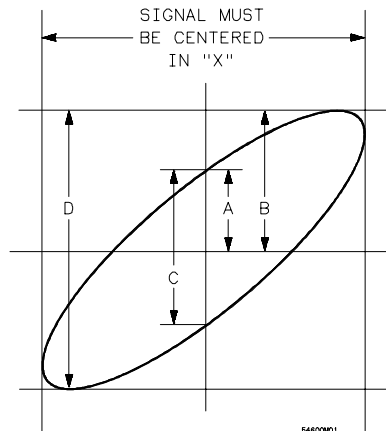

Example of Centering a Signal on the Display

Figure 5-9

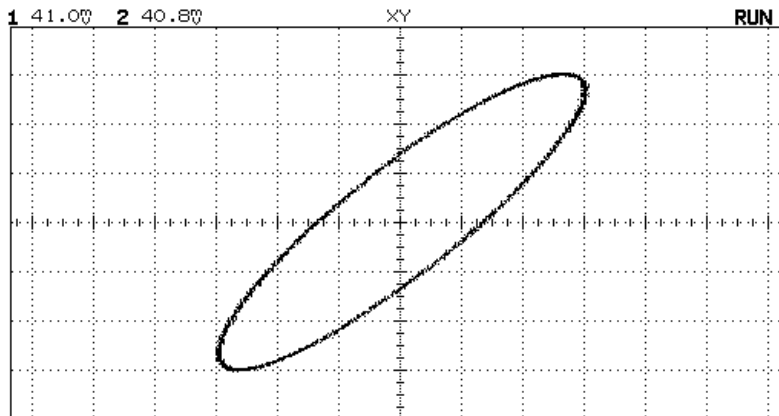

Signal Centered on the Display

- 4 Press **Cursors**.
- 5 Set the Y2 cursor to the top of the signal, and set Y1 to the bottom of the signal.

Note the ΔY value at the bottom of the display. In this example, we are using the Y cursors, but you could have used the X cursors instead. If you use the X cursors, make sure you center the signal in the Y axis.

Figure 5-10

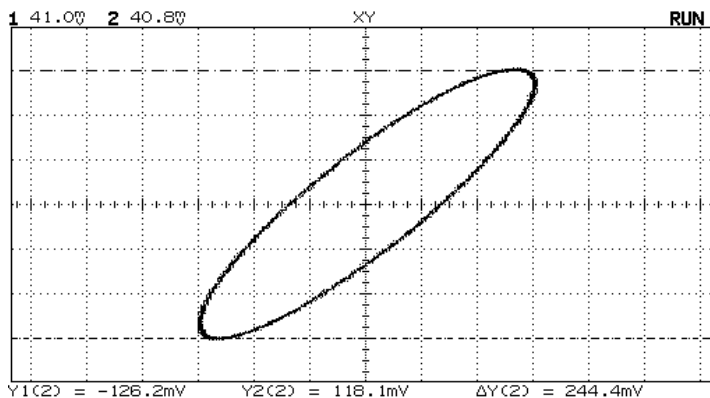

Cursors Set on Displayed Signal

Figure 5-11

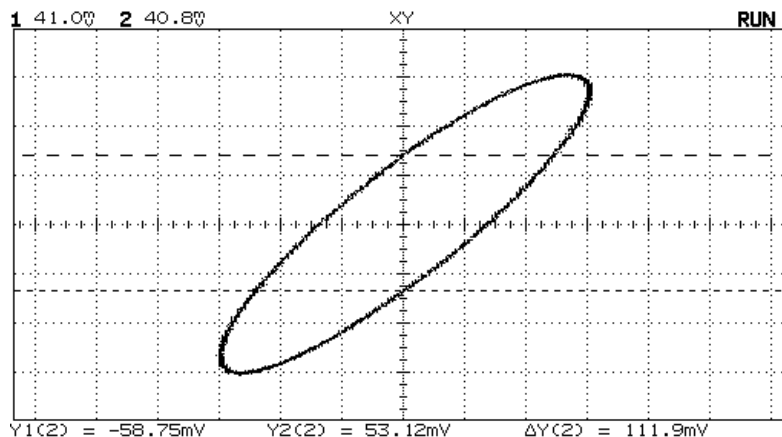

Cursors Set to Center of Signal

- 6** Move the Y1 and Y2 cursors to the center of the signal.

Again, note the ΔY value.

- 7** Calculate the phase difference using the formula below.

$$\sin \theta = \frac{\text{second } \Delta Y}{\text{first } \Delta Y} = \frac{111.9}{244.4} = 27.25 \text{ degrees of phase shift.}$$

XY Display Mode Operating Hint

When you select the XY display mode, the time base is turned off. Channel 1 is the X-axis input, channel 2 is the Y-axis input, and the external trigger in the HP 54645A is the Z-axis input. If you only want to see portions of the Y versus X display, use the Z-axis input. Z-axis turns on and off the trace (analog oscilloscopes called this Z-blanking because it turned the beam on and off). When Z is low (<1.4 V), Y versus X is displayed; when Z is high (>1.4 V), the trace is turned off.

Figure 5-12

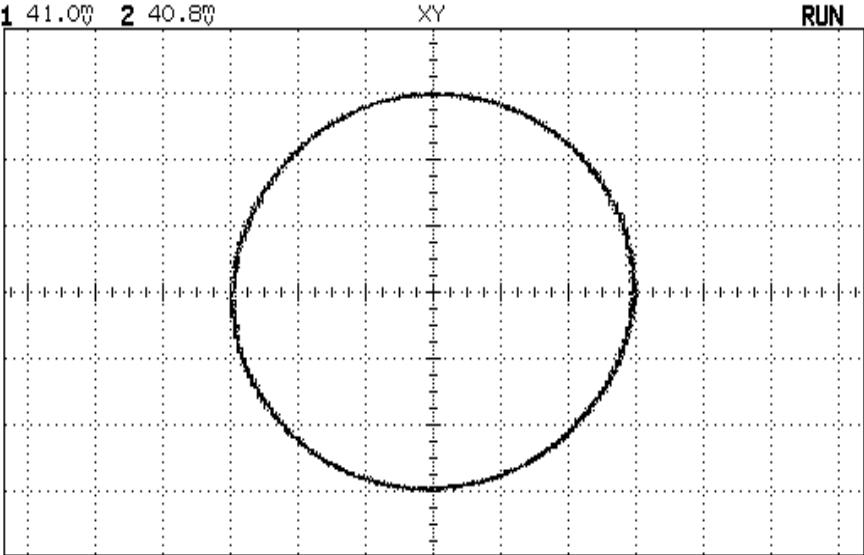

Signals are 90° Out of Phase

Figure 5-13

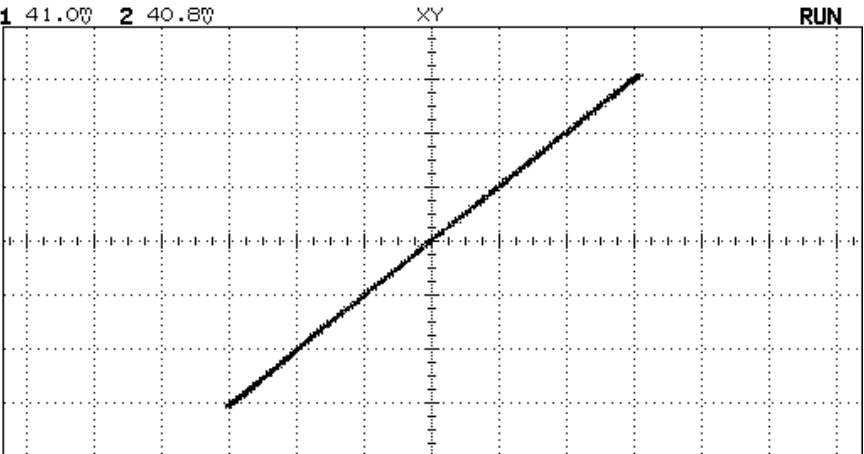

Signals are In Phase

To analyze video waveforms

The TV sync separator in the oscilloscope has an internal clamp circuit. This removes the need for external clamping when you are viewing unclamped video signals. TV triggering requires two vertical divisions of display, either channel 1 or channel 2 as the trigger source, and the selection of internal trigger. Turning the trigger level knob in TV trigger does not change the trigger level because the trigger level is automatically set to the sync pulse tips.

For this exercise we connected the oscilloscope to the video output terminals on a television. Then we set up the oscilloscope to view these parts of a TV signal: the second vertical interval with delayed sweep windowed on the vertical interval test signals (VITS) and the IRE displayed full screen.

- 1 Connect a TV signal to channel 1, then press **Autoscale** .
- 2 Press **Display** , then press the **Peak Det** softkey.
- 3 On HP 54645A, press **slope/Glitch** , then press the **TV** softkey if it is not selected, and **TV Menu**. In the TV menu, select the TV Mode to be **Field 2**.
- 4 On HP 54645D, press **Advanced** , then press the **TV** softkey if it is not selected, and **TV Menu**. In the TV menu, select the TV Mode to be **Field 2**.

Polarity Selects either positive or negative sync pulses.

Field 1 Triggers on the field 1 portion of the video signal.

Field 2 Triggers on the field 2 portion of the video signal.

Line Triggers on all the TV line sync pulses.

HF Rej Controls a 500-kHz, low-pass filter in the trigger path.

- 5 Set the time base to $200\ \mu\text{s}/\text{div}$, then center the signal on the display with the Delay knob (delay about $800\ \mu\text{s}$).
- 6 Press **Main/Delayed**, then press the **Delayed** softkey. Pan and zoom the waveform to view signal details.
- 7 Set the delayed sweep to $20\ \mu\text{s}/\text{div}$, then set the expanded portion over the VITS (delay about $900\ \mu\text{s}$).

Figure 5-14

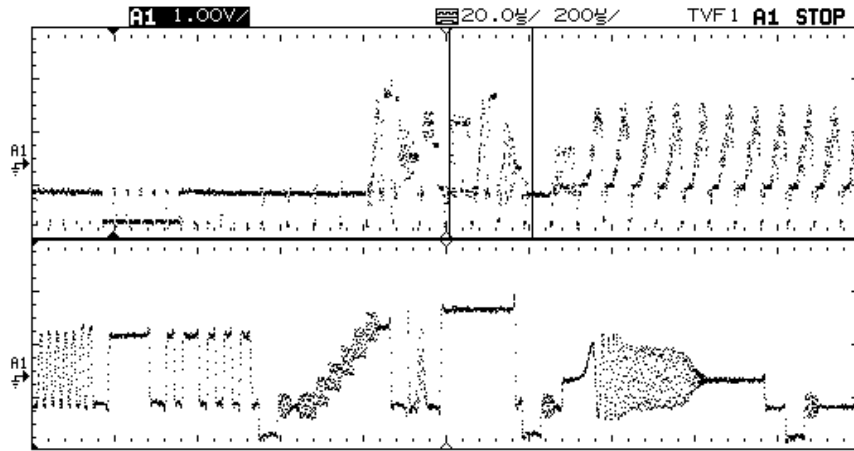

Field 1 Vertical Interval Windowed on the VITS

- 8 Press **Main/Delayed** , then press the **Main** softkey.
- 9 Use the horizontal vernier to change the time base to $1\ \mu\text{s}/\text{div}$, then center the signal on the display with the Delay knob (delay about $901\ \mu\text{s}$).

Figure 5-15

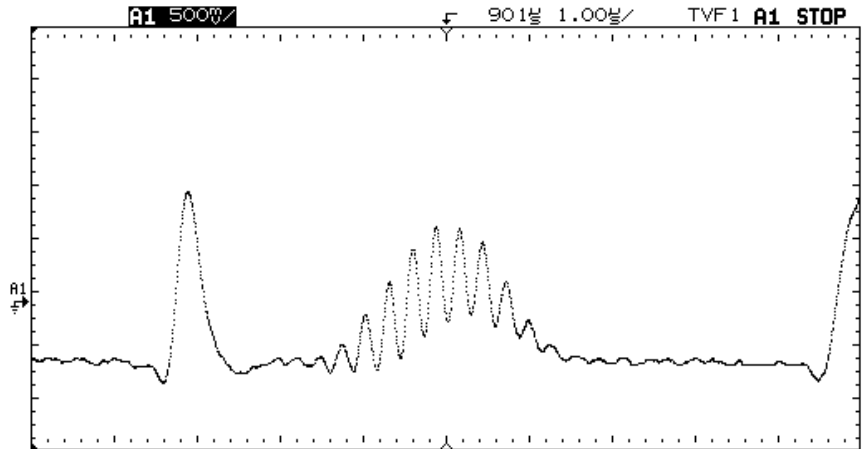

Modulated 12.5T Pulse on the FCC Composite Test Signal

Triggering on both TV Fields at the Same Time

The HP 54645A/D Oscilloscopes can trigger on the vertical sync pulse in both TV fields at the same time. This allows you to view noninterlaced video signals which are common in today's computer monitors. To trigger on both sync pulses, press Field 1 and Field 2 at the same time, or press Vertical (HP 54645A).

TV Trigger Operating Hints

The color burst never really changes phase, it just looks doubled triggered because its frequency is an odd multiple of one half the line frequency.

When looking at live video (usually a field), use peak detect to improve the appearance of the display.

When making cursor measurements, use Autostore since you are usually looking for pulse flatness and extremes.

When using line trigger, use minimum holdoff to display all the lines. Due to the relationship between the horizontal and vertical sync frequencies the display looks like it is untriggered, but it is very useful for TV waveform analysis and adjustment because all of the lines are displayed.

Measuring Waveform Data

With the HP 54645A/D Oscilloscopes, you can measure waveform data using Voltage, Time, and Cursor keys. This section shows you how.

To make cursor measurements

The following steps guide you through the front-panel Cursors key. You can use the cursors to make custom voltage or time measurements on the signal.

- 1 Connect a signal to the oscilloscope and obtain a stable display.
- 2 Press **Cursors**. View the cursor functions in the softkey menu:

Source selects a channel for the voltage cursor measurements. If a Measurement/Storage module is installed in the oscilloscope, and Function 2 is selected, you can select F1 or F2 for the source.

Active Cursor includes voltage cursors V1 and V2, and time cursors t1 and t2. Pressing the voltage cursors alternates between V1 or V2, or both V1 and V2. Pressing the time cursors alternates between t1 or t2, or both t1 and t2.

If a Measurement/Storage module is installed in the oscilloscope, and you select F2 as the source with FFT turned on, the active cursors include f1 and f2. Use the Entry knob to change the active cursor.

Clear Cursors erases the cursor readings and removes the cursors from the display.

On HP 54645D, the **Readout** softkey gives a reading of the time or voltage cursor measurement.

- For the time cursor readout, you can select Time, Hex, Binary, or Degrees. Binary displays all digital channels by channel number. Hex shows only the displayed channels, with the top channel displayed as the most significant bit. When **Active Cursor** is t1/t2, the **Readout Time** softkey sets the display to show the cursor positions in seconds, and the **Readout Degrees** softkey shows the cursor positions in relative number of degrees.
- For the voltage cursor readout, you can select Volts or %. When **Active Cursor** is V1/V2, the **Readout Volts %** softkey sets the display to show the cursor positions in volts when **Volts** is highlighted, and as a percentage when **%** is highlighted.

Use the Entry knob to move the cursors. You can toggle the active cursor by pressing the cursor key while in the cursors menu.

Cursor measurements are not bound to the edge of the screen. If you set a cursor, then pan and zoom the waveform until that cursor is off the screen, when you set the other cursor, the measurement will still be accurate.

Figure 5-16

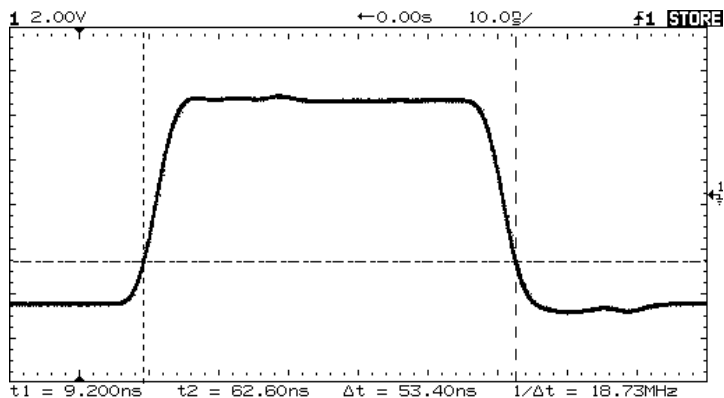

Cursors Measure Pulse Widths other than 50% Points

Figure 5-17

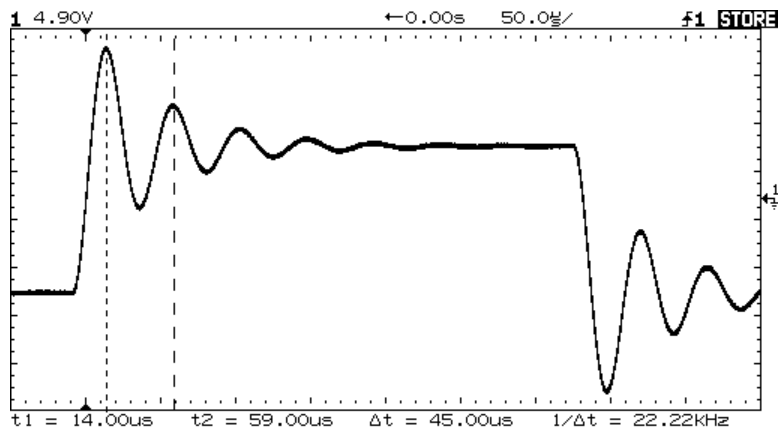

Cursors Measure Frequency of Pulse Ringing

Figure 5-18

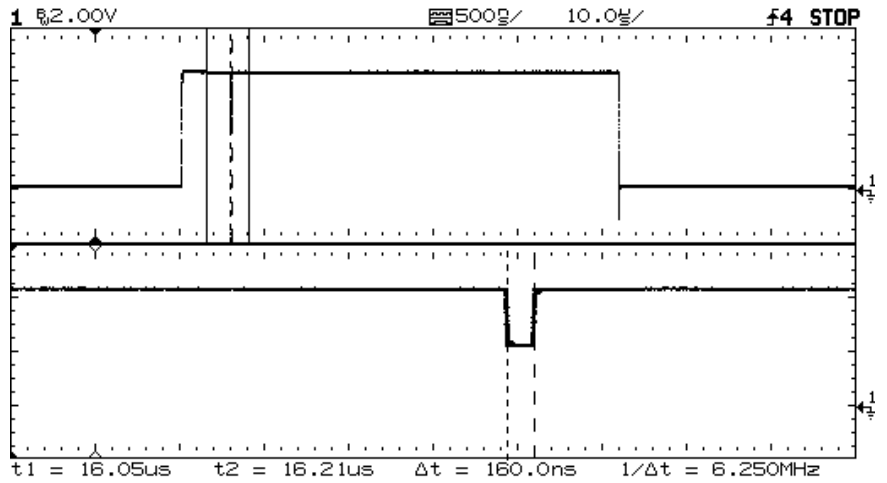

Cursors Track Delayed Sweep

Expand the display with delayed sweep, then characterize the event of interest with the cursors.

Figure 5-19

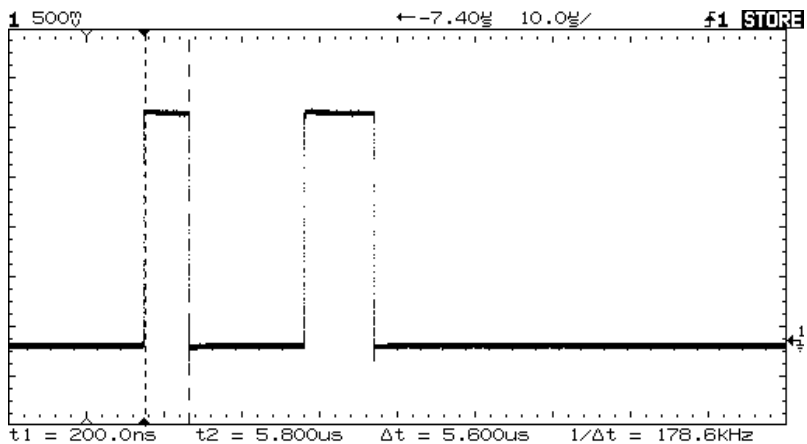

Moving Cursors Together

Pressing the time cursor softkey until both time cursors are highlighted allows you to move them together when rotating the Entry knob.

Figure 5-20

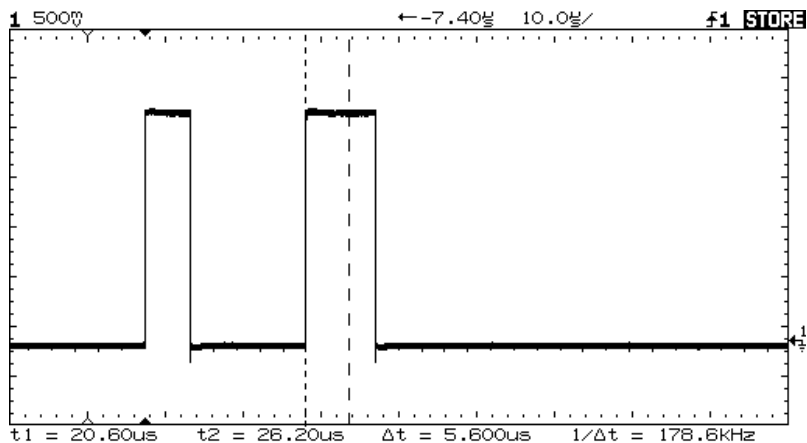

Checking Pulse Width Variations

Move the cursors together to check for pulse width variations in a pulse train.

To make frequency measurements automatically

The automatic measurement capability of the HP 54645A/D Oscilloscopes allows you to easily make frequency measurements.

- 1 Connect a signal to the oscilloscope and obtain a stable display.
- 2 Press **Time** .

The first softkey menu appears with frequency, period, and duty cycle measurement choices.

- 3 Toggle the **Source** softkey to select analog channels (1 or 2 on HP 54645A or A1 or A2 on HP 54645D) for the frequency measurement. On HP 54645D, you can also select any of the digital channels that are displayed for the frequency measurement.
- 4 Press the **Freq** softkey.

The oscilloscope automatically measures the frequency and displays the result on the lower line of the display. The number in parentheses after the word **Freq**, for example Freq(1) for HP 54645A, or Freq(A1) for HP 54645D, shows the channel number (1 or A1) used for the measurement.

- To find the **Show Meas** softkey, press the **Next Menu** softkey key.
When the **Show Meas** softkey is turned on, cursors are displayed on the waveform, and show measurement points for the measurement result displayed on the right-most part of the status line. If you select more than one measurement, you can show a previous measurement by reselecting the measurement.

Automatic Measurements

The oscilloscope makes automatic measurements on the first displayed event.

The following figure shows how to use delayed sweep to isolate an event for a frequency measurement. If the measurement is not possible in the delayed time base mode, then the main time base is used. If the waveform is clipped, it may not be possible to make the measurement.

Figure 5-21

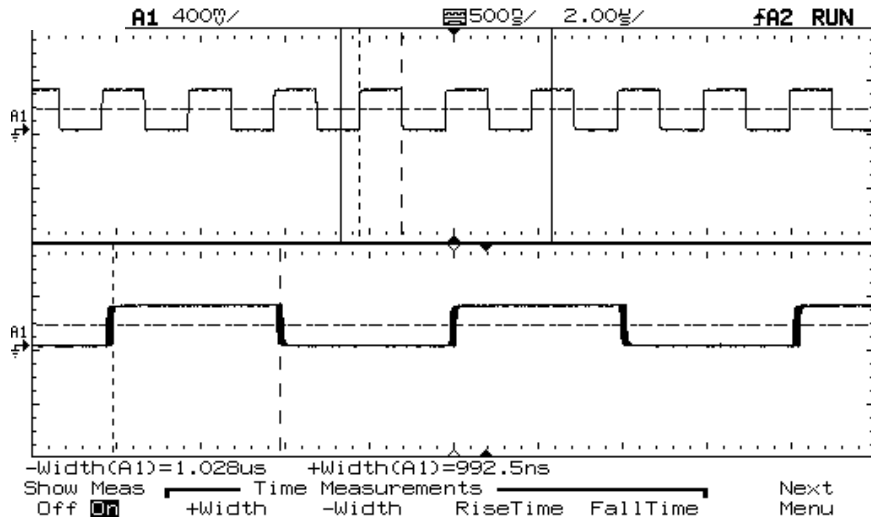

Isolating Event for Frequency Measurement

To make time measurements automatically

You can measure the following time parameters with the oscilloscope: frequency, period, duty cycle, positive and negative widths, rise time, and fall time. The following exercise guides you through the time keys by making a rise-time measurement. Steps for making other measurements are included at the end of the procedure.

1 Connect a signal to the oscilloscope and obtain a stable display.

When the signal has a well-defined top and bottom, the rise time and fall time measurements are made at the 10% and 90% levels. If the oscilloscope cannot find a well-defined top or bottom, the maximum and minimum levels are used to calculate the 10% and 90% points from. These levels are shown in the section on making voltage measurements automatically.

The following figure shows a pulse with some time measurement points.

Figure 5-22

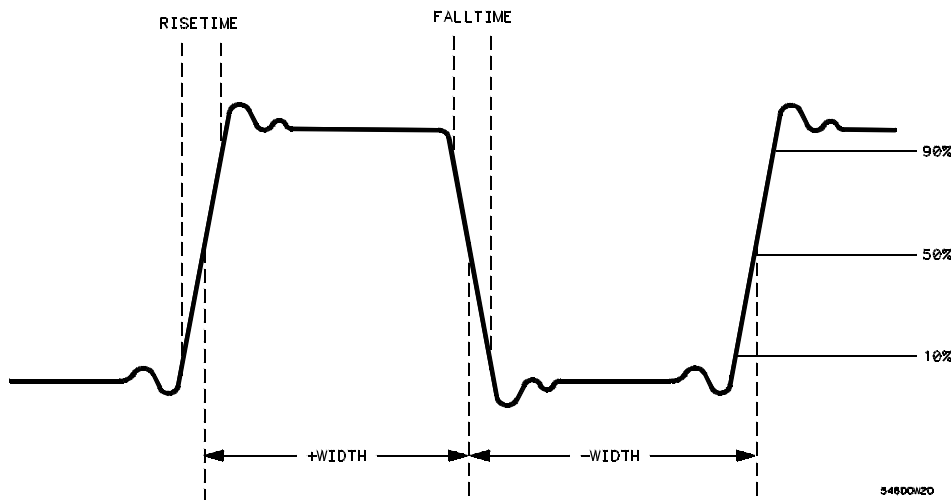

Pulse with Time Measurement Points

2 Press **Time** .

The first softkey menu appears with frequency, period, and duty cycle measurement choices.

Source selects channel 1 or 2 for the time measurement.

Time Measurements include frequency, period, and duty cycle. These measurements are made at the 50% levels.

Clear Meas (clear measurement) erases the measurement results and removes the cursors from the display.

Next Menu displays the next softkey menu with additional time measurement choices.

3 Press the **Next Menu** softkey.

Another menu appears with positive and negative pulse width, and rise time and fall time measurement choices.

Show Meas (show measurement) places the horizontal and vertical cursors to show where the measurement was taken.

Time Measurements include positive width, negative width, rise time, and fall time. Pulse width measurements are made at the 50% levels. Rise time and fall time measurements are made at the 10% to 90% levels, and *apply only to the analog channels (not the digital channels on HP 54645D)*.

Previous Menu Returns to the previous softkey menu.

To make time measurements automatically

4 Press the Rise Time softkey.

The oscilloscope automatically measures the rise time of the signal and displays the result on the display.

Automatic Measurements

The oscilloscope makes automatic measurements on the first displayed event.

The following figure shows how to use delayed sweep to isolate an edge for a rise-time measurement.

Figure 5-23

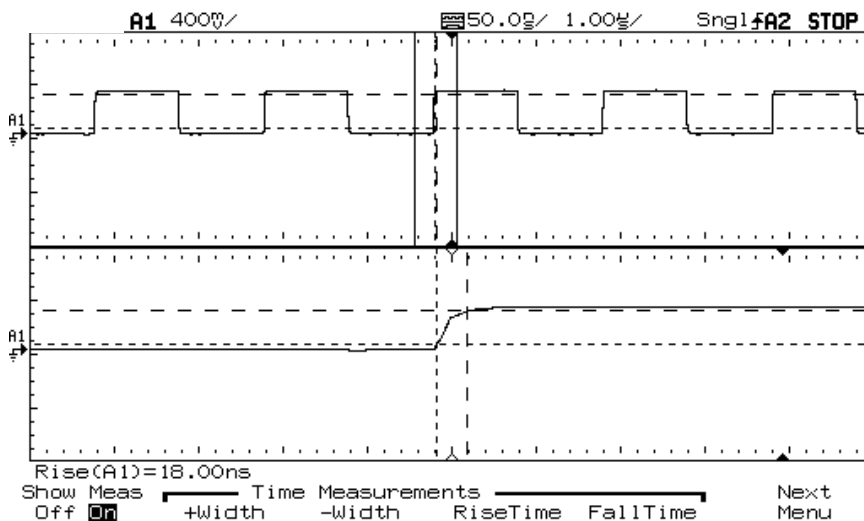

Isolating Edge for Rise-Time Measurement

5 To measure the fall time, press the Fall Time softkey.

Rise Time and Fall Time Measurements

Rise-time and fall-time measurements do not work on digital channels on HP 54645D.

To measure the duty cycle

- Press **Next Menu** until you find the **Duty Cy** softkey, and press it.

To measure the pulse widths

- 1 To measure the positive pulse width, press **Next Menu** until you find the **+Width** softkey, and press it.

Figure 5-24

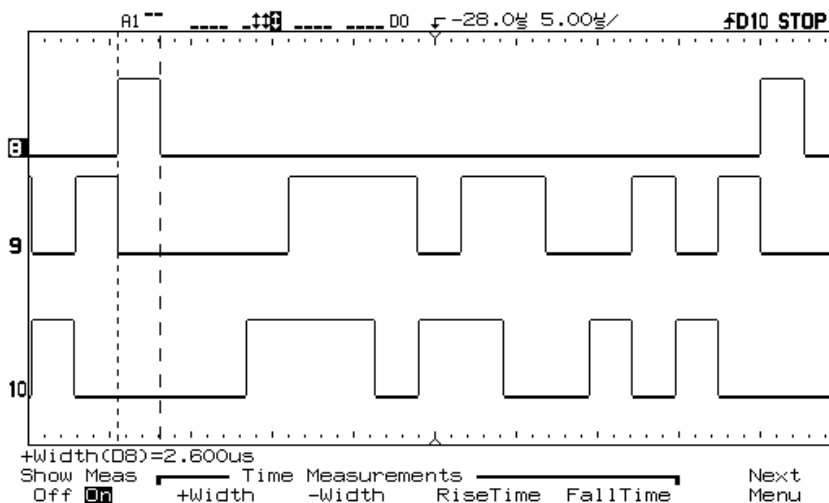

Positive Width Measurement on HP 54645D Digital Channels

- 2 To measure the negative pulse width, press **Next Menu** until you find the **-Width** softkey, and press it.

To make voltage measurements automatically

To make voltage measurements automatically

You can measure the following voltage parameters automatically with the oscilloscope: peak-to-peak, average, rms, maximum, minimum, top, base, amplitude, overshoot, and preshoot. The following exercise guides you through the Voltage keys by making an rms voltage measurement. Steps for making other voltage measurements are included at the end of the procedure. The following figures show pulses with some of the voltage measurement points.

Figure 5-25

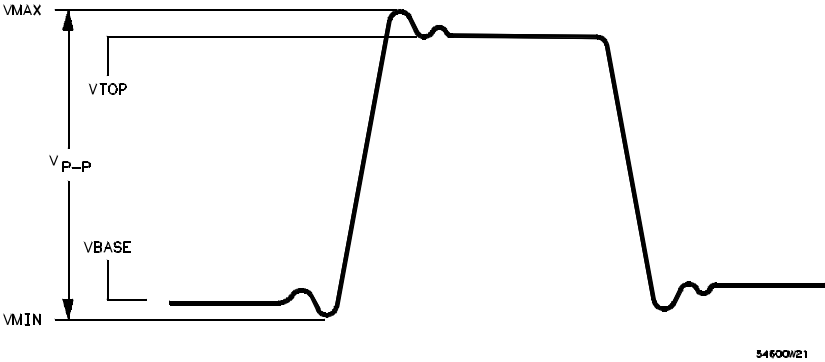

Pulse with Well-Defined Top and Bottom

Figure 5-26

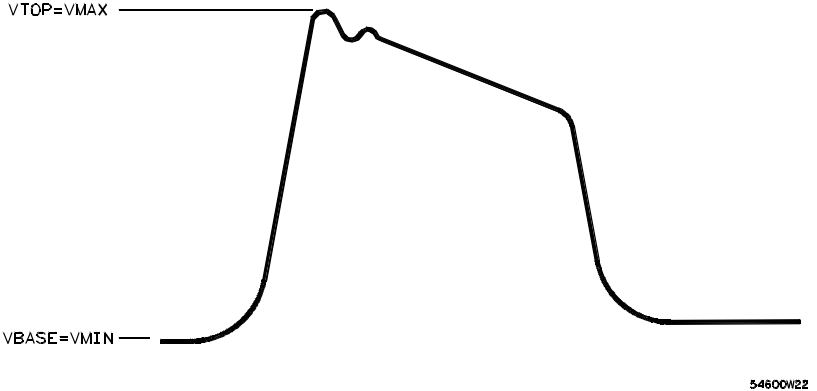

Pulse with Top and Bottom not Well-Defined

Voltage Measurements

Voltage measurements do not work on digital channels on HP 54645D.

- 1 Connect a signal to the oscilloscope and obtain a stable display.
- 2 Press **Voltage** .

A softkey menu appears with voltage measurement choices.

Source selects a channel for the voltage measurement.

Voltage Measurements include peak-to-peak (V_{p-p}), average (V_{avg}), and root mean square (V_{rms}). Measurements are determined by voltage histograms of the signal.

Clear Meas (clear measurement) erases any measurement results from the display, and removes the horizontal and vertical cursors from the display.

Next Menu displays the next softkey menu with additional voltage measurement choices.

- 3 Press the **V top** softkey.

The oscilloscope automatically measures the top voltage and displays the result on the screen.

Automatic Measurements

The oscilloscope makes automatic measurements on the first displayed event.

The following figure shows how to use delayed sweep to isolate a pulse for a V_{top} measurement.

To make voltage measurements automatically

Figure 5-27

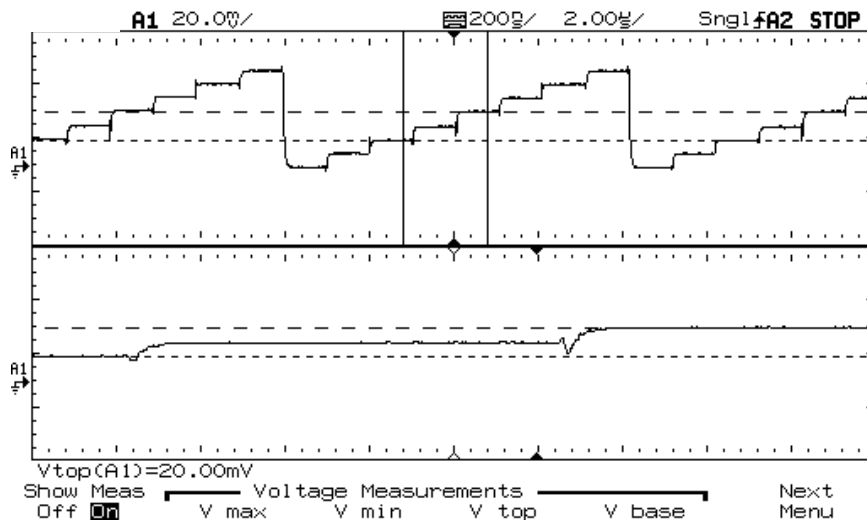

Isolating Area for Vtop Voltage Measurement

4 Press the **Next Menu** softkey.

A softkey menu appears with additional voltage measurement choices.

Show Meas (show measurement) displays the horizontal and vertical cursors showing where the measurement was taken.

Voltage Measurements include choices for measuring the maximum (V_{max}), minimum (V_{min}), top (V_{top}), and base (V_{base}) voltages.

Next Menu displays the next softkey menu.

With the Measurement/Storage module attached to the oscilloscope, you can also measure amplitude (V_{amp}), overshoot (V_{over}), and preshoot (V_{pre}) voltages.

Using Option 005 Enhanced
TV/Video Trigger (HP 54645A)

Using Option 005 Enhanced TV/Video Trigger

You can use the Option 005 Enhanced TV/Video trigger with the HP 54645A Oscilloscope. One of the first things you will want to do with your oscilloscope's new Option 005 Enhanced TV/Video trigger is to become acquainted with its menu choices. Therefore, we have written the exercises in this chapter to familiarize you with its basic controls.

To use the TV/Video trigger, you must be familiar with your oscilloscope. In summary, the front panel of the oscilloscope has knobs, grey keys, and white keys. The knobs are used most often and are similar to the knobs on other oscilloscopes. The grey keys bring up softkey menus on the display that allow you access to many of the oscilloscope features. The white keys are instant action keys and menus are not associated with them. The status line of the oscilloscope, located at the top of of the display, lets you quickly determine the setup of the oscilloscope.

When Option 005 is installed in the HP 54645A Oscilloscope, the Display menu has the extra graticule (Grid) choice of TV.

Use NTSC Instead of PAL-M

To trigger on a PAL-M signal, use NTSC. The line and field rates are identical.

Option 005 gives you an Enhanced TV/Video Trigger for the HP 54645A Oscilloscope, allowing highly detailed analysis of TV waveforms. This option offers:

- NTSC, PAL, PAL-M, SECAM and generic video formats
- Video autoscale
- IRE graticule and IRE cursor readout
- Full bandwidth rear panel output
- Trigger output
- Windowed FFT measurements (with Measurement/Storage module)

Now, in one easy-to-use instrument, you can measure your system's video performance as well as use your oscilloscope for troubleshooting and precision measurements. The HP 54645A Oscilloscope's MegaZoom technology gives you bright, easily viewed displays of any part of the video waveform. No longer do you need to use a viewing hood or to be constantly adjusting intensity and focus controls.

Analysis of video waveforms is simplified by the oscilloscope's ability to trigger on any selected line of the video signal. You can make additional measurements using the **All lines, Field 1, Field 2, All fields** (Vertical in GENERIC), or **Line** triggering modes. In addition, you can use the rear-panel, full-bandwidth signal and trigger outputs with a spectrum instrument or frequency counter for additional measurement power.

To autoscale on a video signal

- 1 Use a cable to connect a TV signal to channel 1.
- 2 Press **Slope/Glitch** in the TRIGGER section of the front panel, and select the **TV** softkey as your trigger mode.
- 3 To select a TV standard, press the **TV Menu** softkey, then press the **Standard** softkey to select the TV standard. Your choices are **NTSC**, **PAL**, **SECAM**, and **GENERIC**. **GENERIC** is used for other TV/Video standards. If your TV standard has been previously selected, you may skip this step.
- 4 Press **Slope/Glitch** , then press the **Video Autoscale** softkey.

Provide Correct Matching

Many TV signals are produced from 75- Ω sources. To provide correct matching to these sources, an HP 11094B 75- Ω load is included as an accessory. For oscilloscopes that have selectable input impedance, the 1-M Ω input should be used with the 75- Ω load.

The **Undo Autoscale** softkey in the Setup menu resets the instrument to the configuration that was present before pressing **Video Autoscale**.

To trigger on a specific line of video

TV triggering requires greater than 1/4 division of sync amplitude, either channel 1 or channel 2 as the trigger source. Turning the trigger level knob in TV trigger does not change the trigger level because the trigger level is automatically set to the sync pulse tips.

One example of triggering on a specific line of video is looking at the vertical interval test signals (VITS), which are typically in line 18. Another example is closed captioning, which is typically in line 21.

- 1 Select the TV display, TV as the trigger mode, and the appropriate TV standard.
- 2 Press **Slope/Glitch** in the TRIGGER section of the front panel, then press the TV and TV Menu softkeys. Press Line. Select the number of the line you want to examine.
- 3 Press the **Trigger On Field** softkey to select the TV field of the line you want to trigger on. Your choices are **Field 1**, **Field 2**, and **Alt Fld** (Alternate Fields).

Alternate Triggering

If **Alt Fld** is selected, the oscilloscope will alternately trigger on the selected line number in Field 1 and Field 2. This is a quick way to compare the Field 1 VITS and Field 2 VITS or to check for the correct insertion of the half line at the end of Field 1.

When using **GENERIC** as the TV standard, the Trigger On Field softkey gives you the choices of Field 1, Field 2 and Vertical.

To trigger on a specific line of video

Figure 6-1

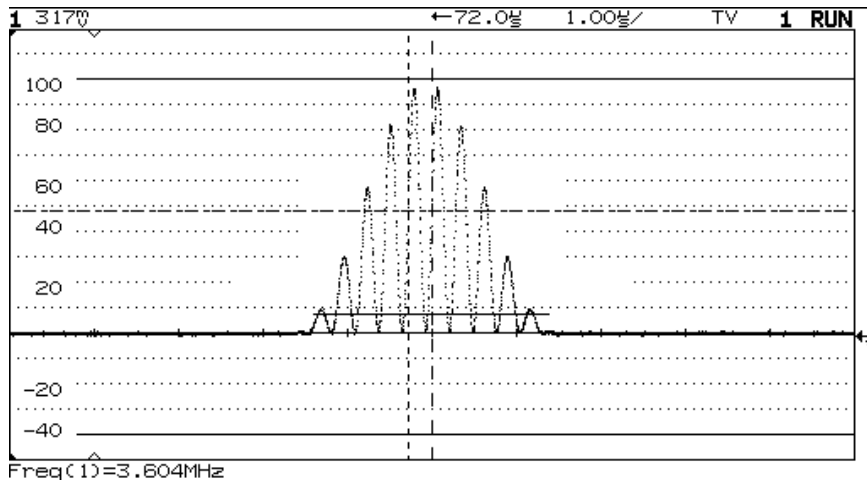

Triggering on Line 71

Note the TV Grid displayed (selected from the Display menu).

Table 6-1

Line Numbers per Field for Each TV Standard

TV Standard	Field 1	Field 2	Alt Fld
NTSC	1 to 263	1 to 262	1 to 262
PAL	1 to 313	314 to 625	1 to 313
SECAM	1 to 313	314 to 625	1 to 313
GENERIC	1 to 1024	1 to 1024	1 to 1024 (Vertical)

Line Number Represents Count

In **GENERIC** mode, the line number represents the number of a count instead of a real line number. This is reflected in the label above the softkey changing from **Line** to **Cnt**. In the **Trigger On** selections, **Field 1**, **Field 2** and **Vertical** are used to indicate where the counting starts. For an interlaced TV system, the counting starts from the rising edge of the first vertical serration pulse of Field 1 and/or Field 2. For a non-interlaced TV system, the counting starts after the rising edge of the vertical sync pulse.

To trigger on all TV line sync pulses

To quickly find maximum video levels, you could trigger on all TV line sync pulses. When All Lines is selected as the TV trigger mode, the oscilloscope will trigger on the first line that it finds when the acquisition starts.

- 1 Select the TV display, TV as the trigger mode, and the appropriate TV standard as described in the previous section, "To autoscale on a video signal."
- 2 Press **Slope/Glitch** in the TRIGGER section of the front panel, then press the TV and TV Menu softkeys. Press All Lines.

Vertical Interval can be Blocked

The 21 lines in the Vertical Interval can be blocked from this display if the **Vert Rej On** mode is selected. The three color sync bursts being displayed inside the white bars are on vertical interval lines. These could be removed by selection of **Vert Rej On**.

Figure 6-2

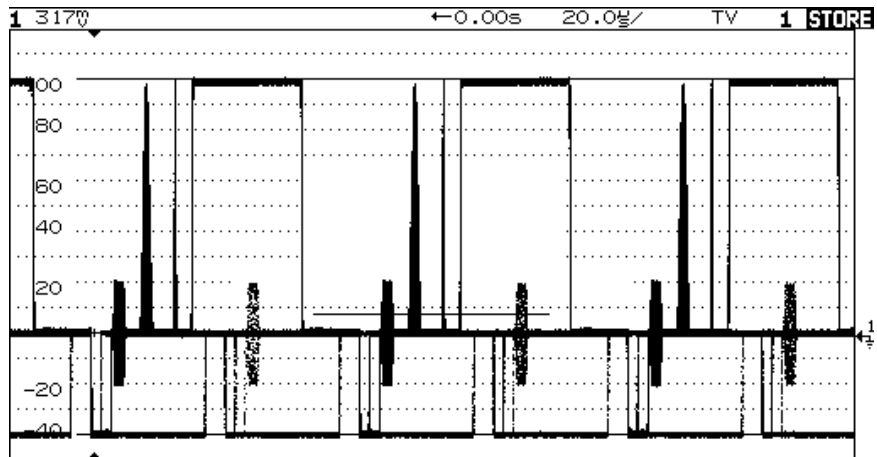

Triggering on All Lines

To trigger on a specific field of the video signal**To trigger on a specific field of the video signal**

To examine the components of a video signal, trigger on either Field 1 or Field 2. When a specific field is selected, the oscilloscope triggers on the rising edge of the first serration pulse in the vertical sync interval in the specified field (1 or 2).

- 1 Select the TV display, TV as the trigger mode, and the appropriate TV standard as described in the section, “To autoscale on a video signal.”
- 2 Press **Slope/Glitch** in the TRIGGER section of the front panel, then press the TV and TV Menu softkeys. Press Field 1 or Field 2.

Figure 6-3

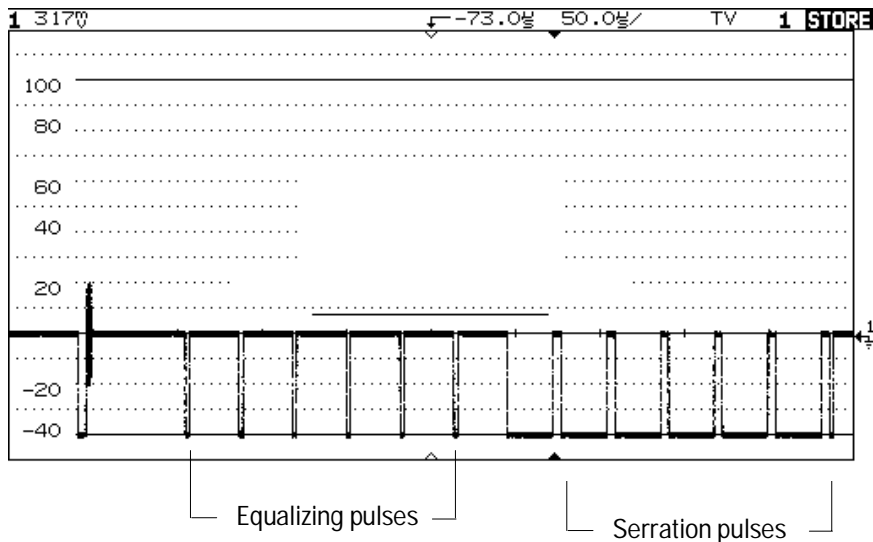
**Triggering on Field 1**

To trigger on all fields of the video signal

To quickly and easily view transitions between fields, or to find the amplitude differences between the fields, use the All Fields trigger. The oscilloscope will trigger on the first field it finds at the start of acquisition.

- 1 Select the TV display, TV as the trigger mode, and the appropriate TV standard as described in the section, "To autoscale on a video signal."
- 2 Press **Slope/Glitch** in the TRIGGER section of the front panel, then press the TV and TV Menu softkeys. Press **All Fields**.

Figure 6-4

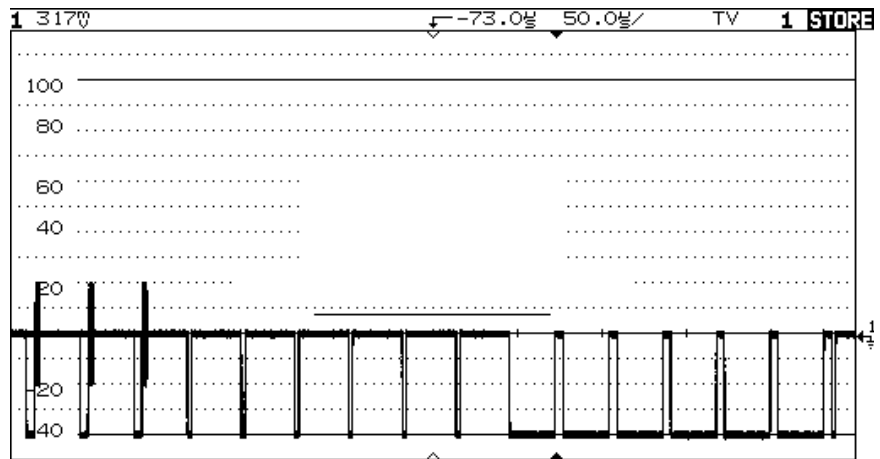

Triggering on All Fields

To trigger on odd or even fields**To trigger on odd or even fields**

To check the envelope of your video signals, or to measure worst case distortion, trigger on the odd or even fields. When Field 1 is selected, the oscilloscope triggers on color fields 1 or 3. When Field 2 is selected, the oscilloscope triggers on color fields 2 or 4.

- 1 Select the TV display, TV as the trigger mode, and the appropriate TV standard as described in the section, "To autoscale on a video signal."
- 2 Press **Slope/Glitch** in the TRIGGER section of the front panel, then press the TV and TV Menu softkeys. Press **Field 1** or **Field 2**.

The trigger circuits look for the position of the start of Vertical Sync to determine the field. But this definition of field does not take into consideration the phase of the reference subcarrier. When Field 1 is selected, the trigger system will find any field where the vertical sync starts on Line 4. In the case of NTSC video, the oscilloscope will trigger on color field 1 alternating with color field 3 (see the following figure). This setup can be used to measure the envelope of the reference burst.

Figure 6-5

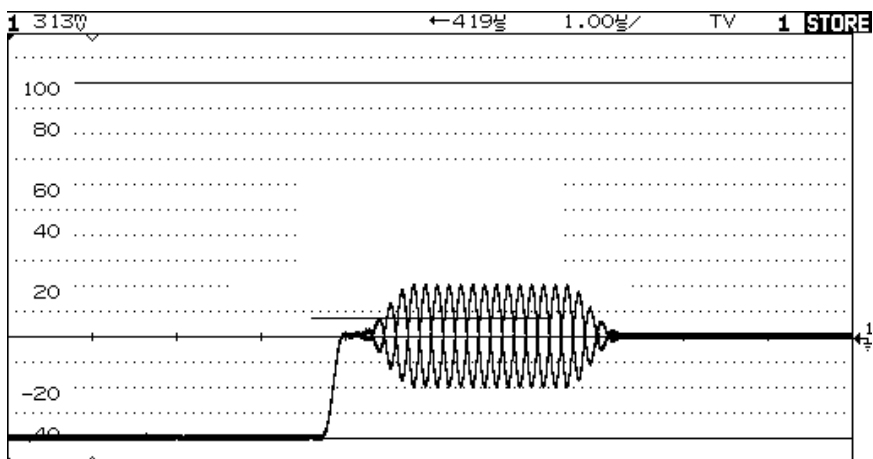
**Triggering on Color Field 1 Alternating with Color Field 3**

If a more detailed analysis is required, then only one color field should be selected to be the trigger. You can do this by using the oscilloscope's holdoff control. Using the holdoff settings shown in the following table, the oscilloscope will now trigger on color field 1 OR color field 3 when Field 1 is selected. This is known as odd field selection. Even fields will be selected with Field 2.

Table 6-2

Holdoff Settings

Video Standard	Fields/Picture	Holdoff Range
NTSC	4	33.5 ms to 50.0 ms
PAL	8	80.7 ms to 120 ms
SECAM	4	40.4 ms to 60 ms
PAL-M	8	80.4 ms to 120 ms

The holdoff can be more easily set if the sweep speed is set to 5 ms/div. Once you have established your desired holdoff time, return to the desired time base setting. The holdoff setting will remain unchanged.

Figure 6-6

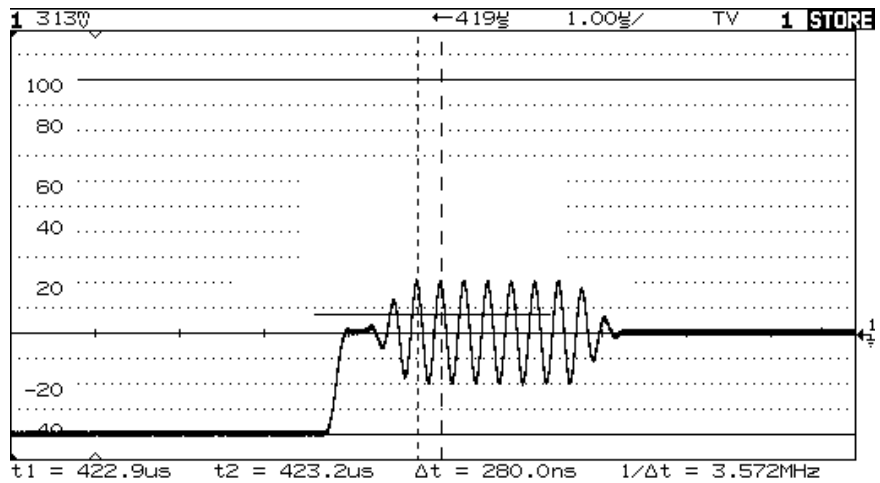

Triggering on Color Field 1 using Holdoff

To analyze video waveforms with Option 005

The combination of the TV trigger, delayed sweep, and automatic measurements allow this oscilloscope to precisely analyze video waveforms. There is no need for external clamping to obtain a stable trigger when you are viewing unclamped video signals. This is because the TV sync separator in the oscilloscope has an internal clamp circuit in the trigger path. Because there is no clamp in the vertical path of the HP 54600-Series Oscilloscopes, you will be able to observe any DC level shifts in the video on the oscilloscope display. To eliminate this position shifting as the DC component of the video changes, select AC coupling.

For this exercise, we connect the oscilloscope to the video output terminals on a television. We set up the oscilloscope to view the second vertical interval with delayed sweep windowed on the vertical interval test signals (VITS). Then we make windowed measurements with the delayed sweep.

- 1 Connect a TV signal to channel 1, and select channel 1 as your trigger source.
- 2 Press **Slope/Glitch** in the TRIGGER section of the front panel, then press the TV and TV Menu softkeys.
- 3 Select the desired TV Standard, such as NTSC, PAL, or SECAM.

Use NTSC instead of PAL-M

To trigger on a PAL-M signal, use NTSC. The line and field rates are identical.

- 4 Press **Slope/Glitch** , then press the **Video Autoscale** softkey.

- 5 Set the time base to $200\ \mu\text{s}/\text{div}$, then center the signal on the display with the delay knob (delay about $800\ \mu\text{s}$).
- 6 Press **Main/Delayed** , then press the **Delayed** softkey.
- 7 Set the delayed sweep to $20\ \mu\text{s}/\text{div}$, then set the expanded portion over the VITS (delay about $988.8\ \mu\text{s}$).

Figure 6-7

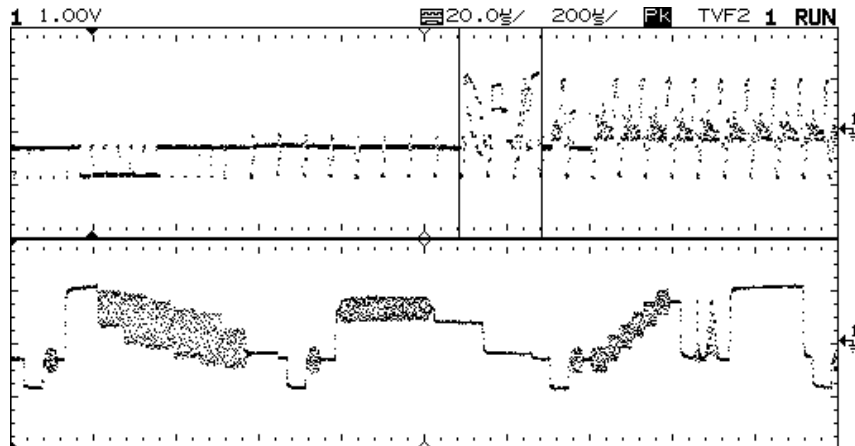

Second VITS Displayed

This figure shows the second vertical interval test signals displayed with delayed sweep.

Testing, Adjusting, and Troubleshooting

Testing, Adjusting, and Troubleshooting

This chapter explains the general procedures for solving problems, verifying correct oscilloscope operation, adjusting the oscilloscope display and power supply, correcting malfunctions in the oscilloscope, and performing tests to ensure that the oscilloscope meets performance specifications. It also describes how to verify operation of the Option 005 Enhanced TV/Video Trigger board, along with information for adjusting the offset, and troubleshooting.

The sections in this chapter include:

- Solving Problems
- Getting Service
- Verifying Oscilloscope Performance

- Adjusting the Oscilloscope
- Troubleshooting the Oscilloscope

Solving Problems with HP 54645A/D Oscilloscopes

This chapter describes possible solutions if you encounter problems while making measurements with HP 54645A/D Oscilloscopes. If you need to replace parts, refer to chapter 8, “Replacement Parts.”

If there is no trace display

- Check that the power cord is connected to the oscilloscope and to a live power source.
- Check that the front-panel power switch is set to 1 (on).
- Check that the display is illuminated and that the brightness is adjusted correctly.

If there is no display, see the troubleshooting procedures in this chapter.

- Check that the oscilloscope probe lead wires are securely inserted into the connector assembly and that the grabbers make good contact with the probe lead wires.
- Check that the grabbers are securely connected to the nodes of the circuit under test, and that the ground is connected.
- Check that the circuit under test is powered on.
- Press Autoscale.
- Reset the oscilloscope.
 - To reset the entire oscilloscope, press and hold any softkey and switch the oscilloscope power on. Release the softkey when the measurement display appears.
- Obtain HP service, if necessary.

If the trace display is unusual or unexpected

- Check that the Time/Div setting is correct for the expected frequency range of the input signals.

The sampling speed of the oscilloscope depends on the Time/Div setting. Thus, when the Time/Div setting is slower than 1 $\mu\text{s}/\text{div}$, the oscilloscope may be sampling too slowly to capture all the transitions on the waveform.

- Check that all oscilloscope probes are connected to the correct signals in the circuit under test.
- Check to see that the ground lead from the cable is securely connected to ground in the circuit under test. For high-speed measurements, each probe's individual ground should also be connected to a ground point closest to the signal point in the circuit under test.

See chapter 1 for more information on probing considerations.

- Check that the trigger setup is correct.

A correct trigger setup is probably the most important factor in helping you capture the desired data. See the chapter "Triggering HP 54645A/D Oscilloscopes" for information on triggering, particularly pattern and advanced triggers and information on logic oscilloscope triggering concepts.

- Check that Autostore is turned off, then press Erase.
- Press Autoscale.

If you can't see a channel

- Check that the oscilloscope probe cable is securely connected to the input connector.
- Check that the oscilloscope probe lead wires are securely inserted into the connector assembly and that the grabbers make good contact with the probe lead wires. Check that the grabbers are securely connected to the nodes in the circuit under test.

Testing, Adjusting, and Troubleshooting

If you can't get any response from the oscilloscope

- Check that the grabbers are securely connected to the nodes in the circuit under test.
- Check that the circuit under test is powered on.

You may have pressed Autoscale with no input signal available. Performing the checks described above ensures that the signals from the circuit under test are seen by the oscilloscope.
- Check that the desired channels are on.
 - 1 Press On/Off.
 - 2 Make sure the selected desired channels are on by using the Entry knob or Select knob to scroll through the channels. Then press On for each channel that should be on, but is off.
- Use Autoscale to obtain an automatic setup for all channels.

If you can't get any response from the oscilloscope

- On the HP 54645D, press the Label key on the front panel and the power switch at the same time. Release the Label key when the measurement display appears.
- Set the calibration switch on the back of the scope to UNPROTECTED. Press and hold the two right-most softkeys (5 and 6) simultaneously, and switch the oscilloscope power on. Release the softkeys when the measurement display appears.

CAUTION

The two-key-down powerup procedure will default the self-cal factors. Perform the self-calibration procedure described in this section to restore the calibration.

Getting Service

If the oscilloscope is under warranty, you must return it to Hewlett-Packard for all service work covered by the warranty. See "To return the oscilloscope to Hewlett-Packard."

If the warranty period has expired, you can still return the oscilloscope to Hewlett-Packard for all service work. Contact your nearest Hewlett-Packard Sales Office for additional details on service work.

If the warranty period has expired and you decide to service the oscilloscope yourself, the instructions in this chapter can help you keep the oscilloscope operating at optimum performance.

To return the oscilloscope to Hewlett-Packard

Before shipping the oscilloscope to Hewlett-Packard, contact your nearest Hewlett-Packard Sales Office for additional details.

1 Write the following information on a tag and attach it to the oscilloscope.

- Name and address of owner
- Model number
- Serial number
- Description of service required or failure indications

2 Remove all accessories from the oscilloscope.

The accessories include the power cord, probes, cables, and any modules attached to the rear of the oscilloscope. Do not ship accessories back to Hewlett-Packard unless they are associated with the failure symptoms.

3 Protect the control panel with cardboard.

4 Pack the oscilloscope in styrofoam or other shock-absorbing material and place it in a strong shipping container.

You can use either the original shipping containers, or order materials from an HP Sales Office. Otherwise, pack the oscilloscope in 3 to 4 inches of shock-absorbing material to prevent movement inside the shipping container.

5 Seal the shipping container securely.

6 Mark the shipping container as FRAGILE.

Verifying Oscilloscope Performance

To completely test and troubleshoot the oscilloscope, you will need to fabricate two test accessories:

- The test connectors make it easy to hook the oscilloscope probes to function generators and measurement equipment with minimum electrical distortion. These connectors are used in the threshold and time interval tests.
- The dummy load is used to troubleshoot the power supply. Refer to “To construct your own dummy load” later in this chapter.

This section explains how to build the test connectors.

To construct test connectors for digital channels

Instructions for HP 54645D

These instructions apply only to the HP 54645D Mixed-Signal Oscilloscope.

The test connectors connect the oscilloscope to the test equipment.

Table 7-1

Materials Required

Description	Recommended Part	Qty
BNC (f) Connector	HP 1250-1032	2
Berg Strip, 8-by-2		1
Berg Strip, 1-by-2		1
100 Ω 1% resistor	HP 0698-7212	2
Jumper wire		

- 1 Build the first test connector using a BNC connector and an 8-by-2 section of Berg strip.
 - a Solder a jumper wire to all pins on one side of the Berg strip.
 - b Solder a jumper wire to all pins on the other side of the Berg strip.
 - c Solder the center of the BNC connector to the center pin of one row on the Berg strip.
 - d Solder the ground tab of the BNC connector to the center pin of the other row on the Berg strip.

Figure 7-1

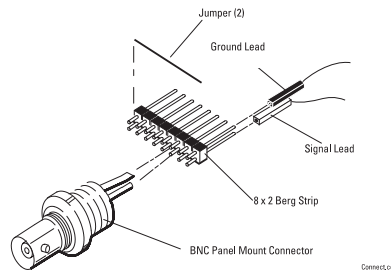

8-by-2 Connector Setup

- 2 Build the second test connector using a BNC connector and a 1-by-2 section of Berg strip.
 - a Solder two resistors to the Berg strip, in parallel across the two pins.
 - b Solder the center of the BNC connector to the center pin of one row on the Berg strip.
 - c Solder the ground tab of the BNC connector to the center pin of the other row on the Berg strip.

Figure 7-2

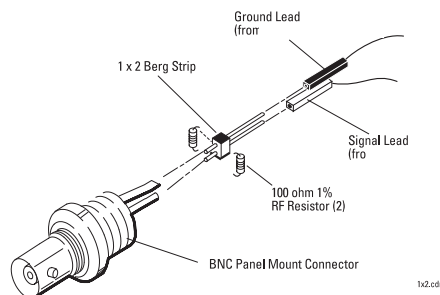

1-by-2 Connector Setup

To test the digital channels

Instructions for HP 54645D

These instructions apply only to the HP 54645D Mixed-Signal Oscilloscope.

Testing the acquisition system does not check a specification, but does provide confidence that the system is functioning correctly.

- 1** Disconnect probes from the circuit under test or other input source.
- 2** Connect digital channels D0, D1, D2, and D3 to the calibration point on the HP 54645D front panel, using probe leads and grabbers.
- 3** Press **Autoscale** .

If four square waves appear, the acquisition system is functioning correctly.

- 4** Repeat steps 2 and 3 with the following sets of digital channels.
 - 4, 5, 6, 7
 - 8, 9, 10, 11
 - 12, 13, 14, 15

Be sure to disconnect each set of digital channels from the calibration point before connecting the next.

Testing Threshold Accuracy

Instructions for HP 54645D

These instructions apply only to the HP 54645D Mixed-Signal Oscilloscope.

Testing the threshold accuracy verifies the data channel threshold accuracy specification. You should perform this test every 24 months or 4000 hours of operation, whichever comes first.

These instructions include detailed steps for testing the threshold settings of digital channels D0-D7. After testing digital channels D0-D7, connect and test digital channels D8-D15. Use the detailed steps for digital channels D0-D7, substituting digital channels D8-D15 for digital channels D0-D7 in the instructions.

Each threshold test tells you to record the voltage reading in the Performance Test Record located at the end of this chapter. To check if each test passed, verify that the voltage reading you record is within the limits listed on the Performance Test Record.

Table 7-2

Equipment Required

Equipment	Critical Specifications	Recommended Model/Part
Digital Multimeter	0.1 mV resolution, 0.005% accuracy	HP 34401A
Function Generator	DC offset voltage ± 6.3 V	HP 3325B Option 002
BNC-Banana Cable		HP 11001-60001
BNC Tee		HP 1250-0781
BNC Cable		HP 10503A
BNC Test Connector, 8-by-2		

To verify threshold accuracy

Instructions for HP 54645D

These instructions apply only to the HP 54645D Mixed-Signal Oscilloscope.

- 1 Press **Label/Threshold** . Select **Threshold Menu**, and select **D0-D7** under the **Set** softkey. Then, select the variable threshold softkey just to the right of **ECL**.
- 2 For each of the threshold levels shown in the following table:
 - a Use the Entry knob on the oscilloscope to select the threshold voltage shown in the table.
 - b On the function generator front panel, enter the DC offset voltage shown in the table. Use the multimeter to verify the voltage.
Activity indicators for D0-D7 should show all at a digital high. These activity indicators appear on the status line at the top of the display for several seconds after pressing the variable threshold softkey.
 - c Using the Modify down arrow on the function generator, decrease offset voltage in 10-mV increments until all activity indicators for digital channels D0-D7 show the digital channels at a digital low. Record the function generator voltage in the performance test record.
 - d Using the Modify up arrow on the function generator, increase offset voltage in 10-mV increments until all activity indicators for digital channels D0-D7 show the digital channels at a digital high. Record the function generator voltage in the performance test record.
- 3 Using the 8-by-2 test connector, connect digital channels D8-D15 to the output of the function generator. Connect the D0-D7 ground lead to the ground side of the 8-by-2 connector.
- 4 Repeat steps 1 and 2, using digital channels D8-D15 for D0-D7.

Table 7-3

Threshold Test Settings

Threshold Voltage	DC Offset Voltage
+5.0	+5.252 V \pm 1 mV DC
-5.0	-4.748 V \pm 1 mV DC
0.0	+0.102 V \pm 1 mV DC

To check the output of the CALIBRATOR

In this test, you measure the output of the rear-panel DC CALIBRATOR OUTPUT with a multimeter. The CALIBRATOR is used for self-calibration of the HP 54645A/D. The accuracy of the CALIBRATOR is not specified, but it must be within the test limits to provide for accurate self-calibration.

The CALIBRATOR output produces DC voltages between 0 and 5V during vertical calibration.

Test limits:

DC calibrator: 5.000 V \pm 10 mV and 0.000 V \pm 500 μ V

Table 7-4

Equipment Required

Equipment	Critical specifications	Recommended Model/Part
Digital Multimeter	0.1 mV resolution, better than 0.01% accuracy	HP 34401A
Cable	BNC	HP 10503A

- 1 Connect a multimeter to the rear-panel CALIBRATOR connector.
- 2 Press **Print/Utility**.
- 3 Press the **Service Menu** softkey, then the **Self Test** softkey, and then the **DAC** softkey.

The multimeter should measure 0.00 V dc \pm 500 μ V. If the result is not within the test limits, see "Troubleshooting the Oscilloscope."

- 4 Press any key once to advance the test.

The multimeter should read 5.000 V \pm 10 mV. If the result is not within the test limits, see "Troubleshooting the Oscilloscope."

- 5 Press any key once to end this test.

To verify voltage measurement accuracy

In this test, you verify the voltage measurement accuracy by measuring the output of a power supply using dual cursors on the oscilloscope, and comparing the results with a multimeter.

Test limits: $\pm 1.5\%$ of full scale ± 1 LSB*

Full scale is defined as 16 mV on the 1 mV/div range. Full scale on all other ranges is defined as 8 divisions times the V/div setting.

* 1 LSB = 0.4% of full scale

Table 7-5

Equipment Required

Equipment	Critical specifications	Recommended Model/Part
Power supply	14 mV to 35 Vdc, 0.1 mV resolution	HP 6114A
Digital multimeter	Better than 0.01% accuracy	HP 34401A
Cable	BNC, Qty 2	HP 10503A
Shorting cap	BNC	HP 1250-0774
Adapter	BNC (f) to banana (m)	HP 1251-2277
Adapter	BNC tee (m) (f) (f)	HP 1250-0781

- 1 Set up the oscilloscope.
 - a Press **Setup** , then press the **Default Setup** softkey.
 - b Adjust the channel 1 Position knob to place the baseline at approximately 0.5 division from the bottom of the display.
Channel 1 is labeled "1" on HP 54645A and "A1" on HP 54645D.
 - c Set the Volts/Div to the first line of the following table.
 - d Press **Display** . Then press the **Average** softkey and set # **Average** to **64**. Wait a few seconds for the measurement to settle; the **Av** letters in the status line indicate how much of the averaging process is finished by turning to inverse video as the oscilloscope performs averaging.
- 2 Press **Cursors** , then press the **V1** softkey.
- 3 Using the Entry knob, set the V1 cursor on the baseline of the signal.
- 4 Connect the power supply to the oscilloscope and to the multimeter, using the BNC tee and cables.
- 5 Adjust the power supply output so that the multimeter reading displays the first Power supply setting value in the following table.
Wait a few seconds for the measurement to settle.
- 6 Press the **V2** softkey, then position the V2 cursor to the center of the trace.

The ΔV value on the lower line of the display should be within the test limits of the following table. If a result is not within the test limits, see "Troubleshooting the Oscilloscope."

- 7** Continue checking the voltage measurement accuracy with the remaining power supply setting lines in the following table.

Table 7-6

Voltage Measurement Accuracy

Volts/Div setting	Power supply setting	Test limits		
5 V/Div	35 V	34.24 V	to	35.76 V
2 V/Div	14 V	13.696 V	to	14.304 V
1 V/Div	7 V	6.848 V	to	7.152 V
0.5 V/Div	3.5 V	3.424 V	to	3.576 V
0.2 V/Div	1.4 V	1.3696 V	to	1.4304 V
0.1 V/Div	700 mV	684.8 mV	to	715.2 mV
50 mV/Div	350 mV	342.4 mV	to	357.6 mV
20 mV/Div	140 mV	136.96 mV	to	143.04 mV
10 mV/Div	70 mV	68.48 mV	to	71.52 mV
5 mV/Div	35 mV	34.24 mV	to	35.76 mV
2 mV/Div	14 mV	13.696 mV	to	14.304 mV
1 mV/Div*	7 mV	6.696 mV	to	7.304 mV

*Full scale is defined as 16 mV on the 1 mV/div range. Full scale on all other ranges is defined as 8 divisions.

- 8** Disconnect the power supply from the oscilloscope, then repeat steps 1 to 7 for channel 2.

Channel 2 is labeled "2" on HP 54645A and "A2" on HP 54645D.

To verify bandwidth

In this test you verify bandwidth by using a power meter and power sensor to set output of a signal generator at 1 MHz and at 100 MHz. You use the peak-to-peak voltage at 1 MHz and at 100 MHz to verify the bandwidth response of the oscilloscope. The test is repeated at 5 mV/div (75-MHz bandwidth).

Test limits at 10 mV/div to 5 V/div:

- all channels (± 3 dB)
- dc to 100 MHz
- ac coupled 10 Hz to 100 MHz

Test limits at <10 mV/div:

- all channels (± 3 dB)
- dc to 75 MHz
- ac coupled 10 Hz to 75 MHz

Table 7-7

Equipment Required

Equipment	Critical specifications	Recommended Model/Part
Signal generator	1 to 100 MHz at 200 mV	HP 8656B opt 001
Power meter and Power Sensor	1 to 100 MHz $\pm 3\%$ accuracy	HP 436A and HP 8482A
Power splitter	Outputs differ by < 0.15 dB	HP 11667B
Cable	Type N (m), 24 inch	HP 11500B
Adapter	Type N (m) to BNC (m)	HP 1251-0082
Feedthrough	50 Ω , BNC (m) and (f)	HP 11048C

Testing, Adjusting, and Troubleshooting
To verify bandwidth

- 1 Connect the equipment.
 - a Connect the signal generator to the input of the power splitter.
 - b Connect the power sensor to one output of the power splitter, and connect channel 1 of the oscilloscope to the other power splitter output. Put a 50- Ω feedthrough at the input of the oscilloscope.
Channel 1 is labeled "1" on HP 54645A and "A1" on HP 54645D.
- 2 Set up the oscilloscope.
 - a Press **Setup** , then press the **Default Setup** softkey.
 - b Set the time base to 500 ns/div.
 - c Set the Volts/Div for channel 1 to 200 mV/div.
 - d Press **Display** , then press the **Average** softkey.
 - e Toggle the # **Average** softkey to select **8** averages.
- 3 Set the signal generator for 1 MHz at about +11.6 dBm.
Notice that the signal on the display is about 5 cycles and six divisions of amplitude.
- 4 Press **Voltage** , then press the **Vp-p** softkey.
Wait a few seconds for the measurement to settle (averaging is complete), then note the V_{p-p} reading from the bottom of the display.
 $V_{p-p} = \underline{\hspace{2cm}}$ V.
- 5 Set the calibration factor percent of the power meter to the 1 MHz value from the calibration chart on the probe, then press dB (REF) on the power meter to set a 0 dB reference.
- 6 Change the frequency of the signal generator to 100 MHz.
- 7 Set the calibration factor of the power meter to the 100 MHz percent value from the chart on the probe (interpolate the value between two frequencies, if necessary).
Adjust the amplitude of the signal generator for a power reading as close as possible to 0.0 dB (REL). Power meter reading = $\underline{\hspace{2cm}}$ dB.

8 Change the time base to 5 ns/div.

Wait a few seconds for the measurement to settle (the **Av** letters in the status line indicate how much of the averaging process is finished by turning to inverse video as the oscilloscope performs averaging), then note the V_{p-p} reading from the bottom of the display.

$V_{p-p} = \text{_____ mV.}$

9 Calculate the response using the following formula.

$$20 \log_{10} \left[\frac{\text{step 8 result}}{\text{step 4 result}} \right]$$

10 Correct the result from step 9 with any difference in the power meter reading from step 7. Make sure you observe all number signs.

Example

Result from step 9 = -2.3 dB

Power meter reading from step 7 = -0.2 dB (REL)

True response = (-2.3) - (-0.2) = -2.1 dB

The true response should be $\leq \pm 3$ dB.

If the result is not $\leq \pm 3$ dB, see "Troubleshooting the Oscilloscope."

11 Repeat steps 1 to 10 for channel 2.

Channel 2 is labeled "2" on HP 54645A and "A2" on HP 54645D.

12 Repeat steps 1 to 11 for 5 mV/div.

a Substitute -20.5 dBm in step 3.

b Substitute 75 MHz in steps 6 and 7.

To verify horizontal Δt and $1/\Delta t$ accuracy

In this test, you verify the horizontal Δt and $1/\Delta t$ accuracy by measuring the output of a time mark generator with the oscilloscope.

Test limits: $\pm 0.01\%$ $\pm 0.2\%$ of full scale ± 40 ps (same channel)

Table 7-8

Equipment Required

Equipment	Critical specifications	Recommended Model/Part
Time marker generator	Stability 5 ppm after 1/2 hour	TG 501A and TM 503B
Cable	BNC, 3 feet	HP 10503A
Termination	50 Ω , BNC connectors (m) and (f)	HP 11048C

- 1 Connect the time mark generator to channel 1 using the 50- Ω feedthrough at the oscilloscope input. Then, set the time mark generator for 0.1-ms markers.

Channel 1 is labeled "1" on HP 54645A and "A1" on HP 54645D.

- 2 Set up the oscilloscope.
 - a Press **Setup**, then press the **Default Setup** softkey.
 - a Press **Display**, then press the **Vectors Off** softkey.
 - c Press **Autoscale**.
 - d Set the time base to 20 $\mu\text{s}/\text{div}$.
 - e Press **Main/Delayed**, then press the **Time Ref Left** softkey.
 - f Adjust the trigger level to obtain a stable display.
- 3 Press **Time**, then press the **Freq** and **Period** softkeys.

You should measure the following:

Frequency 10 kHz, test limits are 9.96 kHz to 10.04 kHz.

Period 100 μs , test limits are 99.59 μs to 100.41 μs .

If the measurements are not within the test limits, see "Troubleshooting the Oscilloscope."

- 4 Change the time mark generator to 1 μs , and change the time base to 200 ns/div. Adjust the trigger level to obtain a stable display.

- 5** Press **Time** , then press the **Freq** and **Period** softkeys.

You should measure the following:

Frequency 1 MHz, test limits are 995.9 kHz to 1.0042 MHz.

Period 1 μ s, test limits are 995.9 ns to 1.0041 μ s.

If the measurements are not within the test limits, see "Troubleshooting the Oscilloscope."

- 6** Change the time mark generator to 10 ns, and change the time base to 5 ns/div. Adjust the trigger level to obtain a stable display.
- 7** Press **Time** , then press the **Freq** and **Period** softkeys.

You should measure the following:

Frequency 100 MHz, test limits are 98.61 MHz to 101.43 MHz.

Period 10 ns, test limits are 9.86 ns to 10.14 ns.

If the measurements are not within the test limits, see "Troubleshooting the Oscilloscope."

To verify trigger sensitivity

In this test, you verify the trigger sensitivity by applying 25 MHz to the oscilloscope. The amplitude of the signal is decreased to the specified levels, then you check to see if the oscilloscope is still triggered. You then repeat the process at the upper bandwidth limit.

Test limits:

Internal trigger

1 mV/div to < 10 mV/div

dc to 25 MHz: 1.0 div or 2.0 mV_{p-p}

25 MHz to 100 MHz: 1.5 div or 3.0 mV_{p-p}

10 mV/div to 5 V/div

dc to 25 MHz: 0.35 div or 3.5 mV_{p-p}

25 MHz to 100 MHz: 1.0 div or 10.0 mV_{p-p}

External trigger

dc to 25 MHz: 50 mV_{p-p}

25 MHz to 100 MHz: 100 mV_{p-p}

Table 7-9

Equipment Required

Equipment	Critical specifications	Recommended Model/Part
Signal generator	25-MHz and 100-MHz sine waves	HP 8656B Option 001
Power splitter	Outputs differ < 0.15 dB	HP 11667B
Cable	BNC, Qty 3	HP 10503A
Adapter	N (m) to BNC (f), Qty 3	HP 1250-0780
Feedthrough	50Ω, BNC connectors (m) and (f)	HP 11048C

**Internal Trig
Sensitivity**

- 1** Press **Setup** , then press **Default Setup**.
- 2** Connect the signal generator to channel 1 using a 50-Ω feedthrough at the oscilloscope input.
Channel 1 is labeled "1" on HP 54645A and "A1" on HP 54645D.
- 3** Verify the trigger sensitivity at 25 MHz and 0.35 divisions.
 - a** Set the signal generator to 25 MHz and about 100 mV.
 - b** Press **Autoscale** .
 - c** Set the time base to 50 ns/div.
 - d** Set channel 1 to 100 mV/div.
 - e** Decrease the output of the signal generator until there is 0.35 vertical divisions of the signal displayed.
The trigger should be stable. If the triggering is not stable, try adjusting the trigger level. If adjusting the trigger level makes the triggering stable, the test still passes. If adjusting the trigger does not help, see "Troubleshooting the Oscilloscope."
 - f** Record the result on the Performance Test Record as Pass or Fail.
- 4** Verify the trigger sensitivity at 100 MHz and 1 division.
 - a** Change the output of the signal generator to 100 MHz and set amplitude to about 100 mV.
 - b** Set the time base to 10 ns/div.
 - c** Decrease the output of the signal generator until there is 1 vertical division of the signal displayed.
The trigger should be stable. If the triggering is not stable, try adjusting the trigger level. If adjusting the trigger level makes the triggering stable, the test still passes. If adjusting the trigger does not help, see "Troubleshooting the Oscilloscope."
 - d** Record the result on the Performance Test Record as Pass or Fail.
- 5** Repeat steps 1 through 4, substituting channel 2 for channel 1 in the procedure.
Channel 2 is labeled "2" on HP 54645A and "A2" on HP 54645D.

**External Trig
Sensitivity**

- 6** Verify the external trigger sensitivity at 100 MHz, 100 mV_{p-p} and at 25 MHz, 50 mV_{p-p}.

Instructions for HP 54645A Only

This procedure applies only to the HP 54645A Oscilloscope.

- a** Using the power splitter, connect the signal generator to the channel 1 input and to the external trigger input. Use the 50-Ω feedthroughs at the oscilloscope inputs.
- b** Change the output of the signal generator to 100 MHz and 70.7 mV_{rms} (200 mV_{p-p}).
The power splitter divides the 200 mV_{p-p} so that 100 mV_{p-p} is applied to each of the oscilloscope inputs.
- c** Press **Autoscale**.
- d** Press **Source**. Set the trigger source to **Ext**.
- e** Check for stable triggering, and adjust the trigger level if necessary.
- f** Record results in the Performance Test Record as Pass or Fail.
If test fails, refer to "Troubleshooting the Oscilloscope."
- g** Change the output of the signal generator to 25 MHz and 35.4 mV_{rms} (100 mV_{p-p}).
- h** Check for stable triggering, and adjust the trigger level if necessary.
- i** Record results in the Performance Test Record as Pass or Fail.
If test fails, refer to "Troubleshooting the Oscilloscope."

To verify vertical output on Option 005

This section applies only to the Option 005 Enhanced TV/Video Trigger.

In this test, we will use the oscilloscope's channel 2 to measure the amplitude of the vertical output signal.

Test limits: approximately 90 mV_{p-p} into 50 Ω with a full-screen input.

Table 7-10

Equipment Required

Equipment	Critical Specifications	Recommended Model/Part
Signal generator	1 to 500 MHz at 200 mV (only 100 MHz needed)	HP 8656B opt 001
Cable	BNC, 48-inch	HP 10503A
Cable	Type N (m), 24-inch	HP 11500B
Adapter	Type N (m) to BNC (f)	HP 1251-0780
Feedthrough	50Ω, BNC (m) and (f)	HP 10100C

- 1** Connect the signal generator to the channel 1 input of the oscilloscope.
- 2** Set the signal generator to equal the full bandwidth of your oscilloscope, and set the output level to 0 dBm.
- 3** Connect the signal generator to the oscilloscope's channel 1. Use a 50-Ω feedthrough to correctly terminate the signal generator.
- 4** Press Autoscale .
- 5** Adjust the oscilloscope controls and signal generator to obtain an 8-division-high display.
- 6** Connect the vertical output to channel 2. Use a 50-Ω feedthrough.
- 7** Measure the peak-to-peak amplitude of channel 2. It should be greater than or equal to 63.6 mV_{p-p}.

Because the measurement is being made at the full bandwidth of the oscilloscope's channel, the peak-to-peak measurement is corrected for the oscilloscope's high-frequency rolloff.



Serial No. _____
 Test Interval _____
 Recommended Next Testing _____

Test by _____
 Work Order No. _____
 Temperature _____

Threshold Accuracy \pm (100 mV + 3% of threshold setting)			Ch D0-D7	Ch D8-D15
Test	Specification	Limits		
	+5 V - 250 mV	+4.750 V	_____	_____
	+5 V + 250 mV	+5.250 V	_____	_____
	-5 V - 250 mV	-5.250 V	_____	_____
	-5 V + 250 mV	-4.750 V	_____	_____
	0 V - 100 mV	-100 mV	_____	_____
	0 V + 100 mV	+100 mV	_____	_____

Calibrator Output	Nominal	Test Limits	Results
dc	0 μ V	-500 μ V to +500 μ V	_____
	5 V	4.990 V to 5.010 V	_____

Voltage measurement accuracy				
Range	Power Supply Setting	Test Limits	Channel 1	Channel 2
5 V/Div	35 V	34.24 V to 35.76 V	_____	_____
2 V/Div	14 V	13.696 V to 14.304 V	_____	_____
1 V/Div	7 V	6.848 V to 7.152 V	_____	_____
500 mV/Div	3.5 V	3.424 V to 3.576 V	_____	_____
200 mV/Div	1.4 V	1.3696 V to 1.4304 V	_____	_____
100 mV/Div	700 mV	684.8 mV to 715.2 mV	_____	_____
50 mV/Div	350 mV	342.4 mV to 357.6 mV	_____	_____
20 mV/Div	140 mV	136.96 mV to 143.04 mV	_____	_____
10 mV/Div	70 mV	68.48 mV to 71.52 mV	_____	_____
5 mV/Div	35 mV	34.24 mV to 35.76 mV	_____	_____
2 mV/Div	14 mV	13.696 mV to 14.304 mV	_____	_____
1 mV/Div	7 mV	6.696 mV to 7.304 mV	_____	_____

Bandwidth	Test Limits	Channel 1	Channel 2
	$\leq \pm 3$ dB at 100 MHz	_____	_____
	$\leq \pm 3$ dB at 75 MHz	_____	_____

Horizontal Δt and $1/\Delta t$ accuracy			
	Generator Setting	Test Limits	Results
Frequency	10 kHz	9.96 kHz to 10.04 kHz	_____
Period	100 μ s	99.59 μ s to 100.41 μ s	_____
Frequency	1 MHz	995.9 kHz to 1.0042 MHz	_____
Period	1 μ s	995.9 ns to 1.0041 μ s	_____
Frequency	100 MHz	98.61 MHz to 101.43 MHz	_____
Period	10 ns	9.86 ns to 10.14 ns	_____

Trigger sensitivity	Test Limits	Channel 1	Channel 2
Internal trigger	25 MHz at 0.35 divisions	_____	_____
	100 MHz at 1 division	_____	_____
External trigger	100 MHz at 100 mV _{p-p}	_____	_____
	25 MHz at 50 mV _{p-p}	_____	_____

Option 005 Voltage measurement accuracy	Test Limits	Channel 1	Channel 2
Amplitude peak-to-peak	≥ 63.6 mV _{p-p}	_____	_____

Adjusting the Oscilloscope

This section explains how to adjust the oscilloscope so that it is at optimum operating performance. You should perform the hardware adjustments and Self Cal periodically as indicated in this section.

- Perform hardware adjustments at 12 months or 2,000 hours of operation.
- Perform Self Cal at 6 months or 1000 hours of operation, or if ambient temperature is greater than 10 °C from the calibration temperature, or if the user wants to maximize the measurement accuracy.

The amount of use, environmental conditions, and your past experience with other instruments can help you determine if you need a shorter adjustment interval. Make sure you allow the oscilloscope to warm up for at least 30 minutes before you start the adjustments.

WARNING

The maintenance described in this section is performed with power supplied to the oscilloscope and with the protective covers removed. Only trained service personnel who are aware of the hazards involved should perform the maintenance. Whenever possible, perform the procedures with the power cord removed from the oscilloscope. *Read the safety summary at the back of this book before proceeding.*

CAUTION

Do not disconnect any cables or remove any assemblies with the power applied to the oscilloscope, or damage to the oscilloscope can occur.

CAUTION

Do not operate the oscilloscope, with its cover removed, without using an external fan. Air flow over the samplers is reduced which leads to operating temperatures that are higher than normal. The fan should blow air across the system PC board where the heat sinks are located.

CAUTION

ELECTROSTATIC DISCHARGE (ESD) can damage electronic components. When using any of the procedures in this chapter you should use proper ESD precautions. As a minimum, you should place the instrument on a properly grounded ESD mat and wear a properly grounded ESD strap.

To adjust the power supply

The power supply has a +5.1 V adjustment and a -5.25 V adjustment. The other voltages are based on the +5.1 V adjustment. In this procedure you use a multimeter to measure the +5.1 V and -5.25 V, and if necessary, adjust the power supplies to within tolerance.

Table 7-11

Equipment Required

Equipment	Critical specifications	Recommended Model/Part
Digital multimeter	0.1 mV resolution, accuracy $\pm 0.05\%$	HP 34401A

- 1 Set up the oscilloscope for the voltage adjustment.
 - a Turn off the oscilloscope and disconnect power cable.
 - b Remove the cover from the oscilloscope. See chapter 8, "Replacement Parts."
 - c Place the oscilloscope on its side.
 - d Connect the negative lead of the digital multimeter to a ground point on the oscilloscope chassis.
 - e Reconnect power cable.
 - f Turn on the oscilloscope.

2 Measure the power supply voltages at E1 through E6 on the system board.

The test points are not marked on the system board; see the following figure for the location of test points.

Make sure that the voltage measurements are within the following tolerances.

Table 7-12

Power Supply Voltage Tolerances

Supply Voltage	Tolerance
+5.1 V	±153 mV (+4.947 V to +5.253 V)
-5.25 V	±158 mV (-5.092 V to -5.408 V)
+15.75 V	+1.260 V, -787 mV (+14.963 V to +17.010 V)
-15.75 V	±787 mV (-14.963 V to -16.537V)

Figure 7-4

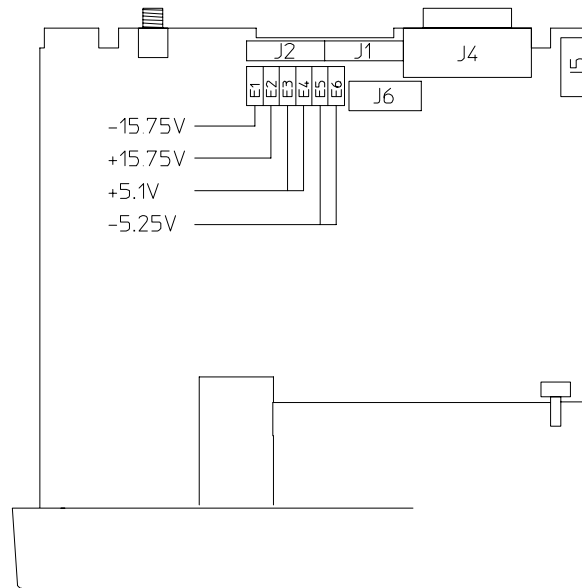

**Low Voltage Power Supply Voltage Test Points
 (bottom side of oscilloscope)**

Testing, Adjusting, and Troubleshooting To adjust the power supply

If the +5.1 V measurement is out of tolerance, adjust the +5.1 V adjustment on the power supply; if the -5.25 V measurement is out of tolerance, adjust the -5.25 V adjustment on the power supply (see the following figure). The ± 15.75 V supplies are not adjustable and are dependent upon the +5.1 V supply. If adjusting the power supply does not bring all the voltages within tolerance, see "Troubleshooting the Oscilloscope" in this chapter.

Figure 7-5

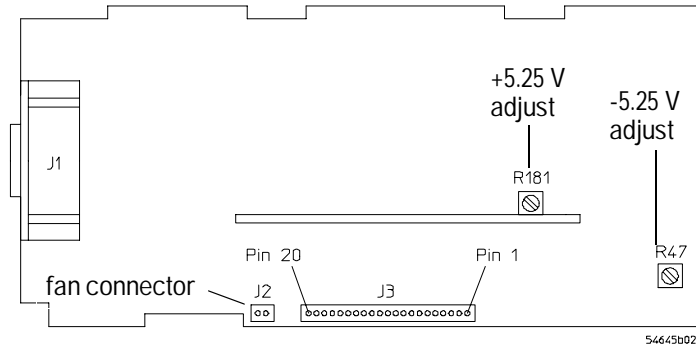

**Low Voltage Power Supply Adjustment Locations
(top side of oscilloscope)**

To perform the self-calibration

In this procedure, you load the default calibration factors to give a known starting point for the firmware calibration. *However, once the default calibration factors are loaded, you must perform the remainder of the firmware calibration to maintain the accuracy of the oscilloscope.*

Table 7-13

Equipment Required

Equipment for HP 54645A	Critical specifications	Recommended Model/Part
Pulse generator	100 kHz, 1 V _{p-p} , rise time 10 ns	HP 8112A
Cable	BNC, 3 feet	HP 10503A
Cable	BNC, 9 inches, Qty 2	HP 10502A
Adapter	BNC tee (m) (f) (f)	HP 1250-0781
Adapter	BNC (f-f)	HP 1250-0080
Feedthrough	50Ω, BNC (m) and (f)	HP 11048C
Equipment for HP 54645D	Critical specifications	Recommended Model/Part
Cable	BNC, 3 feet	HP 10503A
Probe, 10x1	100 MHz	HP 10074A, Qty 2
Cable	16-channel	HP 54620-61801
Banana Ground Plug		HP 1252-7310

Testing, Adjusting, and Troubleshooting
To perform the self-calibration

- 1** Check the rear panel CALIBRATOR output level.
If you are not sure how to check the CALIBRATOR, see "To check the output of the CALIBRATOR."
- 2** Load the default calibration factors.
 - a** Set the rear-panel CALIBRATION switch to the UNPROTECTED position.
 - b** Press **Print/Utility** . Then press **Service Menu** and **Self Cal Menu**.
 - c** Press the **Load Defaults** softkey.
- Vertical self cal**
 - 3** After the message "Default scope calibration factors have been loaded" is displayed on the lower side of the display, press **Vertical**.
 - 4** Follow the instructions on the display, then press **Continue**.
 - 5** After the message "Press Continue to return to calibration menu" appears on the display, press the **Continue** softkey
- Delay self cal for HP 54645A Only**
 - 6** Connect a pulse generator set to 100 kHz and 1 V_{p-p}, with a rise time of less than 10 ns, to channels 1 and 2. Place the feedthrough at the BNC tee. Make sure you use the HP 10502A cables to ensure equal cable lengths.
 - 7** Press the **Delay** softkey, then follow the instructions on the display.
 - 8** Set the rear-panel CALIBRATION switch to **PROTECTED**.
- Delay self cal for HP 54645D Only**
 - 9** Connect channels A1 and A2 to the front-panel probe adjust signal (5 V_{p-p}, 1.2 kHz) using two 10:1 probes (HP 10074A). Connect the ground leads on the 10:1 probes to the front-panel ground lug using the banana ground plug (HP 1252-7310).
 - 10** Connect digital channel D0 to the front-panel probe adjust signal (5 V_{p-p}, 1.2 kHz) using the 16-channel cable (HP 54620-61801). Connect the ground lead of this cable to the front-panel ground lug.
 - 11** Press the **Delay** softkey, then follow the instructions on the display.
 - 12** Set the rear-panel CALIBRATION switch to **PROTECTED**.

To adjust the low-frequency compensation

In this procedure, you adjust the low-frequency compensation adjustment for each channel.

Table 7-14

Equipment Required

Equipment	Critical specifications	Recommended Model/Part
Square wave generator	30 kHz at about 3 V _{p-p}	HP 8112A
Feedthrough	50 Ω, BNC (m) and (f)	HP 11048C
Cable	BNC	HP 10503A

- 1 Using the BNC cable and 50-Ω feedthrough, connect the square wave generator to channel 1. Use the 50-Ω feedthrough at the oscilloscope input.

Channel 1 is labeled "1" on HP 54645A and "A1" on HP 54645D.

- 2 Adjust the generator for about 30 kHz at about 3 V_{p-p}.

- 3 Press **Autoscale** .

- 4 Set channel 1 to 500 mV/div.

You must perform this adjustment on the 500-mV range.

Channel 1 is labeled "1" on HP 54645A and "A1" on HP 54645D.

- 5 Adjust the output of the generator until you obtain about 5 to 6 divisions of vertical deflection.

Testing, Adjusting, and Troubleshooting
To adjust the high-frequency pulse response

- 6** Adjust the channel 1 low-frequency compensation adjustment for as flat a pulse top as possible.

Channel 1 is labeled "1" on HP 54645A and "A1" on HP 54645D.

- 7** Repeat steps 1 through 6 for channel 2.

Channel 2 is labeled "2" on HP 54645A and "A2" on HP 54645D.

Figure 7-6

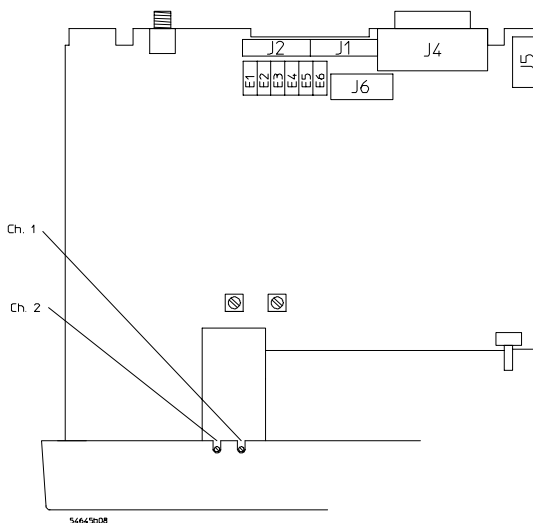

Variable Capacitor Reference Designators

To adjust the high-frequency pulse response

In this procedure, you adjust the high-frequency pulse response for each channel.

Table 7-15

Equipment Required

Equipment	Critical specifications	Recommended Model/Part
Pulse generator	Rise time <875 ps	PSPL 1107B TD and PSPL 1110B Driver
Adapter	SMA (f) to BNC (m)	HP 1250-1787
Feedthrough	50Ω, BNC (m) and (f)	HP 11048C

- 1 Connect the pulse generator to channel 1, using a 50- Ω feedthrough at the oscilloscope input.
Channel 1 is labeled "1" on HP 54645A and "A1" on HP 54645D.
- 2 Press **Autoscale** .
- 3 Change the time base to 10 ns/div.
- 4 Press **1** on the HP 54645A, or **A1** on the HP 54645D, then toggle the **Vernier** softkey to **On**.
- 5 Adjust the Volts/Div until there are about 6 divisions of vertical deflection.
- 6 Adjust the channel 1 high-frequency response for 1.0 minor division of overshoot (4%).
- 7 Repeat steps 1 through 6 for channel 2.
Channel 2 is labeled "2" on HP 54645A and "A2" on HP 54645D.

Figure 7-7

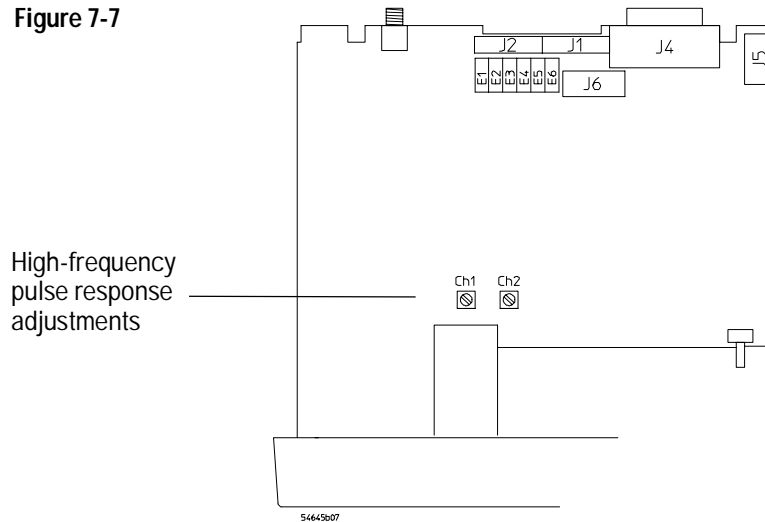

High-Frequency Pulse Response Adjustment Locations

To adjust the display

The display adjustments are optional and normally do not require adjustment. You should use this procedure only for the few cases when the display is obviously out of adjustment.

Table 7-16

Equipment Required

Equipment	Critical specifications	Recommended Model/Part
Digital multimeter	Accuracy $\pm 0.05\%$, 1 mV resolution	HP 34401A

- 1 Connect the digital multimeter to the end of R901, which is closest to the fuse.
- 2 Adjust +B for +14.00 V.
- 3 Press **Print/Utility**. Press **Service Menu**, then **Self Tst Menu** and **Display**.
- 4 Adjust V.HO (vertical hold) for vertical synchronization.
- 5 Set the intensity control (on the front panel) to mid-range.
- 6 Adjust Sub Bri (sub bright) to the lowest setting so that the half-bright blocks on the display are visible.
- 7 Increase the intensity control to a comfortable viewing level.
This is usually about 3/4 of its maximum range.

- 8 Adjust HB Cont (half-bright contrast) for the best contrast between the half-bright and full-bright blocks.**
You can re-adjust Sub Bri, intensity control, and HB Cont to suit your preference.
- 9 Press any key to continue to the next test pattern. Then, adjust H.Hold (horizontal hold) to center the display horizontally.**
- 10 Adjust Focus for the best focus.**
- 11 Press any key to continue to the normal display pattern. Then adjust V.Lin (vertical linearity) for equal sizing of all four corner squares.**
- 12 Adjust V.Size (vertical size) to center the display vertically at the maximum allowable size without losing the text.**
Adjustments V.Lin and V.Size interact so you may need to re-adjust sizing and vertical centering of the display.

Figure 7-8

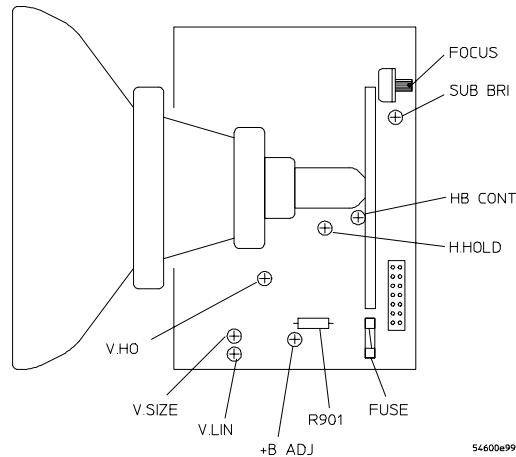

Display Board Adjustment Locations

To adjust the Option 005 offset (R15) (HP 54645A)

On the Option 005 board, there is only one adjustment. You must calibrate the oscilloscope before performing this adjustment. You must also remove the cabinet to access R15. Refer to chapter 8, “Replacement Parts,” for instructions on how to remove the cabinet to gain access to R15.

Table 7-17

Equipment Required

Equipment	Critical specifications	Recommended Model/Part
Digital multimeter	0.1-mV resolution, accuracy $\pm 0.05\%$	HP 34401A
Adapter	BNC (m) to dual-banana post	HP 10110B

- 1 Set up the oscilloscope for the voltage adjustment.
 - a Turn off the oscilloscope.
 - b Remove the cabinet from the oscilloscope.
 - c Connect the negative lead of the digital multimeter to a ground point on the oscilloscope.
 - d Connect the oscilloscope’s vertical output to the voltage inputs of the digital multimeter (DMM) using the DMM’s test leads and the BNC-to-dual-banana post adapter.
 - e Turn on the oscilloscope.
 - f Set up the digital multimeter for a DC voltage measurement.
 - g Press **Setup**.
 - h Press **Default Setup**.
- 2 Adjust R15 on the Option 005 PC board so that the measured voltage on the digital multimeter is 0 volts ± 1 mV.

If adjusting R15 does not bring the voltage within tolerance, see “To troubleshoot Option 005” later in this chapter.

Troubleshooting the Oscilloscope

The service policy for this instrument is replacement of defective assemblies. The following procedures can help isolate problems to the defective assembly.

WARNING

The maintenance described in this section is performed with power supplied to the oscilloscope and with the protective covers removed. Only trained service personnel who are aware of the hazards involved should perform the maintenance. Whenever possible, perform the procedures with the power cord removed from the oscilloscope. Read the safety summary at the back of this book before proceeding.

CAUTION

Do not disconnect any cables or remove any assemblies with the power applied to the oscilloscope, or damage to the oscilloscope can occur.

CAUTION

ELECTROSTATIC DISCHARGE (ESD) can damage electronic components. When doing any of the procedures in this chapter you should use proper ESD precautions. As a minimum, you should place the instrument on a properly grounded ESD mat and wear a properly grounded ESD strap.

The following equipment is needed to troubleshoot the oscilloscope.

Table 7-18

Equipment Required

Equipment	Critical specifications	Recommended model/part
Digital multimeter	Accuracy $\pm 0.05\%$, 1 mV resolution	HP 34401A
Oscilloscope	100 MHz, 1-M Ω input R	HP 54600
Dummy load ¹	Compatible with power supply	See "To construct your own dummy load"

To construct your own dummy load

- 1 Obtain a connector that is compatible with the connector J3 on the Low Voltage Power Supply.
- 2 Connect the following load resistors to the connector:
 - +5.1 V requires a 4-A load, 1.3 Ω and 20.4 W on pins 9–12.
 - 5.25 V requires a 3-A load, 1.75 Ω and 15.8 W on pins 15–18.
 - +15.75 V requires a 1.3-A load, 12.2 Ω and 20.5 W on pins 5–6.
 - 15.75 V requires a 0.8 A-load, 19.7 Ω and 13 W on pin 3.
- 3 Connect the other end of the resistors to ground pins 2, 4, 7, 8, 13, 14, 19, and 20.

Figure 7-9

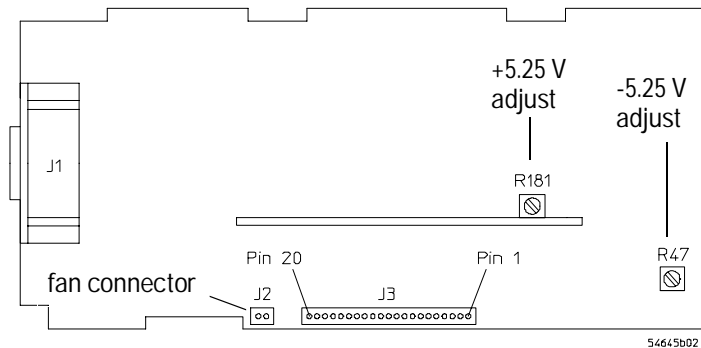

Low Voltage Power Supply Connector

To check out the oscilloscope

- 1 Is there an interface module connected to the rear panel of the oscilloscope?
If yes, do the following steps. If not, go to step 2.
 - a Turn off the oscilloscope.
 - b Remove the module.
 - c Turn on the oscilloscope, then check for the failing symptom.
If the failing symptom disappears, replace the module. If not, go to step 2.

- 2 Turn off the oscilloscope for 30 seconds minimum and then turn it on again.
If an error message (for example, **Vertical cal factors failed checksum test-defaults loaded**) appears within the waveform display area, go to "To clear error messages." If error messages do not appear, go to step 3.

- 3 Disconnect any external cables from the front panel.
- 4 Disconnect the power cord, then remove the cabinet.

CAUTION

If you operate the oscilloscope without the cabinet, use an external fan to blow air across the system board. This air flow is necessary to cool the heat sinks on the system board.

- 5 Connect the power cord, then turn on the oscilloscope.
If the display comes on after a few seconds, (HP logo and copyright text, followed by a graticule with text at top of the display) go to "To check the Low Voltage Power Supply." If, after checking the Low Voltage Power Supply, the voltages are within the test limits, go to step 9. If not, go to step 7. If the display did not come on, do the steps listed here.
 - a Check the intensity knob to see if it is set too low for viewing.
 - b If there is still no display, disconnect the power cord.
 - c Check all cable connections.
 - d Go to "To check the Low Voltage Power Supply."
If the voltages are within the limits go to step 6. If not, go to step 7.

- 6** Disconnect the ribbon cable from the display board, then check the following signals on the system board.

Table 7-19

Display Signals				
Signal	Name	Frequency	Pulse width	Voltage
U5 Pin 36	DE	19.72 kHz	38.0 μ s	2.6 V _{p-p}
U76 Pin 1 (HP 54645A)	Hsync	19.72 kHz	3.0 μ s	5.0 V _{p-p}
U77 Pin 1 (HP 54645D)				
U5 Pin 2	Vsync	60.00 Hz	253.5 μ s	5.2 V _{p-p}

If the signals are good, replace the display assembly. If not, replace the system board.

- 7** Disconnect the ribbon cable from the display board.

- 8** Go to "To check the Low Voltage Power Supply."

If the voltages are within the test limits, replace the display assembly. If not, do the steps below.

- a** Disconnect the power cord.
- b** Disconnect the ribbon cable from the power supply.
- c** Connect the dummy load to the power supply connector.
- d** Connect the power cord, then measure the power supply voltages again (see new tolerances below).

If the voltages are now within the test limits, replace the system board. If not, replace the power supply.

Table 7-20

Low Voltage Power Supply Voltage Tolerances	
Supply Voltage	Tolerance
+5.1 V	\pm 153 mV (+4.947 V to +5.253 V)
-5.25 V	\pm 158 mV (-5.092 V to -5.408 V)
+15.75 V	+1.260 V, -787 mV (+14.963 V to +17.010 V)
- 15.75 V	\pm 787 mV (-14.963 V to -16.537V)

9 Is the fan running?

If yes, go to "To run the internal self-tests." If not, do the steps below.

The Low Voltage Power Supply has a thermal cut-out circuit. If the fan is defective, the Low Voltage Power Supply shuts down when it gets too hot for safe operation.

- a Disconnect the fan cable from the power supply.
- b Measure the fan voltage at the connector on the power supply.

See the following figure for location of the fan connector. If the fan voltage is approximately +8 Vdc, replace the fan. If not, replace the power supply.

Figure 7-10

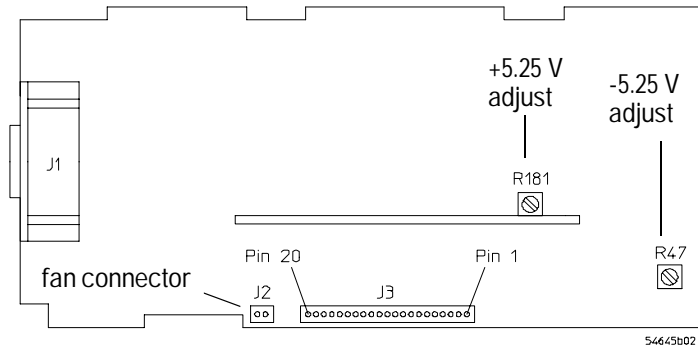

Fan Connector

To clear error messages

One or more of the following error messages may appear on the display (within the graticule space) as a result of internal NVRAM (non-volatile random access memory.)

- 1** If the message "**Vertical Cal factors failed checksum test-defaults loaded**" appears on the screen, go to "To perform the self-calibration," perform steps 1 through 5, then continue the steps below.

This message means that the vertical calibration factors, which were stored in NVRAM along with a checksum, have been corrupted. This information is written into NVRAM when a vertical self-calibration is run. During powerup, the checksum is recomputed and compared to the one saved when the vertical calibration factors were saved. If the checksums do not match, the error message is displayed.

- a** Cycle the power on the oscilloscope.
- b** If default vertical calibration factors are loaded, and error messages remain, contact your HP service center for diagnosis and repair.

- 2** If the message "**Horizontal cal factors failed checksum-defaults loaded**," appears on screen, go to "To perform the self-calibration" and perform the self-calibration for your instrument, then continue to steps below.

This message means that the horizontal delay calibration factors which were stored in NVRAM along with a checksum have been corrupted. This information is written into NVRAM when the horizontal delay calibration is run. During powerup, the checksum was recomputed and compared against the one saved when the horizontal delay calibration factors were saved. If the checksums do not match, the error message is displayed.

- a** Cycle the power of the oscilloscope.
- b** If default horizontal delay calibration factors are loaded, and error messages remain, contact your HP service center for diagnosis and repair.

- 3** If any Fail message appears on the display after cycling power:
 - a** Press any menu key and cycle the power on the oscilloscope again.
 - b** Hold the menu key down until the message "Key-down power-up executed" is displayed.
 - c** If the original fail message still appears, contact your HP Service Center for diagnosis and repair.
- 4** Continue with "To check out the oscilloscope."

To check the Low Voltage Power Supply

- 1 Disconnect the power cord, remove the cover and set the oscilloscope on its side.

CAUTION

If you operate the oscilloscope without the cabinet, use an external fan to blow air across the system board. This air flow is necessary to cool the heat sinks on the system board.

- 2 Connect the negative lead of the multimeter to a ground point on the oscilloscope. Connect the power cord and turn on the oscilloscope.
- 3 Measure the power supply voltages at E1 through E6 on the system board. See the following figure.

Table 7-21

Power Supply Voltage Tolerances

Supply Voltage	Tolerance
+5.1 V	±153 mV (+4.947 V to +5.253 V)
-5.25 V	±158 mV (-5.092 V to -5.408 V)
+15.75 V	+1.260 V, -787 mV (+14.963 V to +17.010 V)
-15.75 V	±787 mV (-14.963 V to -16.537V)

Figure 7-11

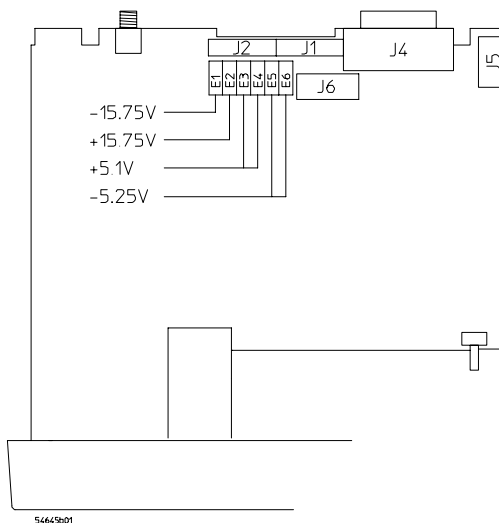

Low Voltage Power Supply Voltage Test Points

If the +5.1 V measurement is out of tolerance, adjust the +5.1 V adjustment on the power supply; if the -5.25 V measurement is out of tolerance, adjust the -5.25 V adjustment on the power supply. The ± 15.75 V supplies are not adjustable and are dependent upon the +5.1 V supply.

Blown fuse

If the power supply fuse is blown, the power supply is defective. Replace the power supply.

CAUTION

Be careful when performing component-level repair. Voltages greater than 300 Vdc can cause injury.

To run the internal self-tests

- 1** Perform the display test.
 - a** Press **Print/Utility** .
 - b** Press **Service Menu**, then **Self Tst Menu** and **Display**.
 - c** Do the half-bright and full-bright squares appear?
If yes, continue with the steps below. If not, replace the display.
 - d** Press any key to continue.
 - e** Do squares appear in the four corners?
If yes, the display is good. If not, replace the display.
 - f** Press any key to end the test.
 - g** If you still have the failing symptom, replace the system board.
- 2** Perform the keyboard test.
 - a** Press the **Keyboard** softkey.
A pictorial diagram of the front panel will appear on the display.
 - b** Press each key, and notice that when you press a key a corresponding block on the display fills in.
 - c** Rotate the knobs (except the intensity) and notice that an arrow appears on the display that points in the direction you rotate the knob.
 - d** Do all the keys and knobs work?
If yes, press **Stop** two or three times (the display indicates how many times), then go to step 3. If not, replace the keyboard.
- 3** Check the output level of the DAC.
 - a** Press the **DAC** softkey.
 - b** Connect a multimeter to the rear panel **CALIBRATOR** connector.
The multimeter should read $0\text{ V} \pm 500\ \mu\text{V}$.
 - c** Press any key to continue.
The multimeter should read $5\text{ V} \pm 10\text{ mV}$.
 - d** Are the DAC voltages correct?
If yes, press any key to continue. If not, replace the system board.

- 4 Perform the ROM test
 - a Press the **ROM** softkey.
 - b Does the display message say "**Scope self-test passed**"?
If yes, press any key to continue. If not (the display message says **Scope self-test Failed**), replace the system board.
- 5 Perform the RAM test.
 - a Press the **RAM** softkey.
 - b Does the display message say "**Scope self-test passed**"?
If yes, press any key to continue. If not (the display message says "**Scope self-test Failed**"), replace the system board.

To troubleshoot Option 005

To isolate a malfunction to the Option 005 board, do the following:

- 1** Disconnect the three cables that connect the Option 005 board to the system board.
- 2** Verify proper oscilloscope operation, as described in this chapter.
- 3** If the oscilloscope passes the performance verification and the malfunction still occurs when the Option 005 board is reconnected, then you should replace the Option 005 board.



Replacement Parts

Replacement Parts

This chapter contains instructions for removing and ordering replaceable assemblies. Also included is a parts list for the assemblies and hardware of the oscilloscope that you can order from Hewlett-Packard.

Before working on the oscilloscope, read the safety summary at the back of this book.

WARNING

Hazardous voltages are on the CRT, power supply, and display sweep board. To avoid electrical shock, disconnect the power cord from the oscilloscope. Wait at least three minutes for the capacitors in the oscilloscope to discharge before you begin disassembling the oscilloscope. Read the Safety Summary at the back of this manual before beginning disassembly.

CAUTION

Do not replace assemblies with the oscilloscope turned on, or damage to the components can occur.

CAUTION

ELECTROSTATIC DISCHARGE (ESD) can damage electronic components. When using any of the procedures in this chapter, you should use proper ESD precautions. As a minimum, you should place the instrument on a properly grounded ESD mat and wear a properly grounded ESD strap.

Removing and Replacing Assemblies

Refer to the exploded view of the oscilloscope in this chapter for details on how the oscilloscope fits together. To install an assembly, follow the instructions in reverse order.

You will need the following tools to disassemble the oscilloscope:

- T15 TORX driver to remove the oscilloscope from the cabinet and to remove the fan.
- T10 TORX driver to remove the assemblies from the deck.
- Flat-blade screwdriver to remove the front panel and power shaft and the optional interface modules and pouch.

You can remove any of the following assemblies: fan, front panel, display, system board, power supply, keyboard, and handle.

To remove the cabinet

- 1 Turn off the oscilloscope and disconnect the power cable.
- 2 If a module is installed, remove it from the oscilloscope.
- 3 Using the T15 TORX driver, remove the two screws from the rear of the cabinet.
- 4 Using your thumbs, gently push on the rear-panel connector to slide the oscilloscope out of the cabinet.

To remove the fan

- 1 Disconnect the fan cable from the power supply board.
- 2 Using the T15 TORX driver, remove the three screws that hold the fan to the deck.

To remove the front panel

- 1 Remove the intensity knob by pulling it straight out.
- 2 Disconnect the keyboard ribbon cable from the system board.
- 3 Remove the External Trigger nut from the BNC (HP 54645A only).
- 4 Use a screwdriver to release retainer tab A, and your finger to release retainer tab B. See the following figure.

Releasing Front Panel from Deck of Instrument

When tab B is released, be careful that the sheet metal tab of the front-panel ground input clears the softkey circuit board. The circuit board may be depressed slightly with a screwdriver to avoid damage to the circuit board.

- 5 Rotate the front panel out until the bottom clears the rear of the assembly, then lift the front panel to free the hooks on top.

When installing the front panel, make sure that the power switch shaft is aligned with its mating hole in the front panel.

The front panel swings in to engage the two retainer tabs. Before attempting to engage the retainer tabs, make sure that the six hooks on top of the front panel are fully engaged with their mating holes in the sheet metal.

Figure 8-1

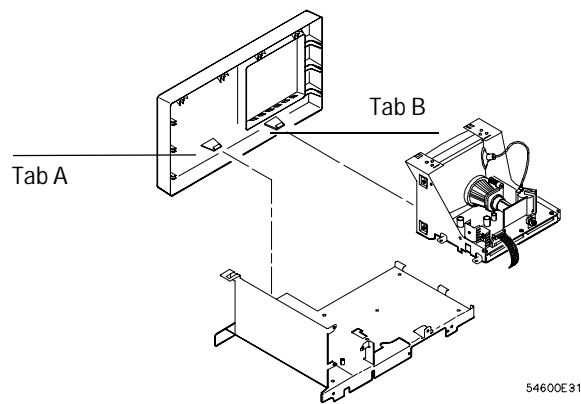

Front Panel Removal

To remove the display

- 1 Remove the front panel on the HP 54645A/D.
 - 2 Disconnect the ribbon cable and the calibration cable from the display.
 - 3 Using the T10 TORX driver, remove the two screws that hold the display to the deck.
Make sure that when you re-install these screws that you use the correct parts. If longer screws are used, they can short the system board to ground.
 - 4 As you lift the display, rotate it off the two tabs on the side of the deck.
-

To remove the system board

- 1 Using the T10 TORX driver, remove the eight screws that hold the system board to the deck.
- 2 Remove the two screws from the rear-panel interface connector.
- 3 Remove the hex nut and washer from the rear BNC (HP 54645A/D).
- 4 Disconnect the three ribbon cables and the calibration cable.
- 5 As you remove the system board, rotate the system board so that the BNCs clear the front panel.

To remove the front-panel BNC connectors

This procedure applies to channel 1 and 2 BNC connectors on HP 54645A, and to channel A1 and A2 BNC connectors on HP 54645D.

- 1** Remove the system board.
- 2** De-solder the center conductor wire and the probe readout wire from the board.
- 3** Using the T10 Torx driver, remove the screw holding the BNC to the housing.

To remove the power supply

- 1 Remove the fan.
- 2 Disconnect the ground wire (green wire with the yellow stripe) from the deck.
- 3 Disconnect the ribbon cable from the power supply board.
- 4 Use a screw driver to gently unhook the latch that holds the white shaft to the power switch, then disconnect the shaft from the power switch. After you disconnect the shaft, make sure you position it in the recess along the side of the display bracket.
- 5 Using the T10 TORX driver, remove the screw holding the power supply board to the deck.
- 6 Slide the power supply board toward the front panel about half an inch. Slip the keyhole slots on the power supply board off of the pins on the deck.

Figure 8-2

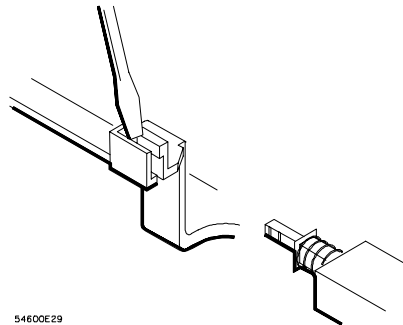

54600E29

Unhooking the Power Switch Shaft

To remove the keyboard

- 1 Remove the front panel.
- 2 Remove all the knobs by pulling straight out.
- 3 Flex the bezel of the front panel to unsnap the small keyboard under the display opening.
- 4 Using the T10 TORX driver, remove the three screws from the large keyboard.
Make sure that when you re-install these screws that you use the correct parts. If longer screws are used, they can damage the front-panel label.
- 5 Press down on the top of the keyboard, and rotate the bottom of the keyboard out.

To remove the handle

- Rotate the handle down until it is just past the last detent position (about 1/2 inch before the handle touches the bottom of the oscilloscope), then pull the sides of the handle out of the cabinet.

Replacing the Option 005 board

*The Option 005 board is only serviceable at the board level.
No component level information is available.*

WARNING

Hazardous voltages are on the CRT, power supply, and display sweep board. To avoid electrical shock, disconnect the power cord from the oscilloscope. Wait at least three minutes for the capacitors in the instrument to discharge before you begin disassembling the oscilloscope to remove Option 005.

CAUTION

Do not replace assemblies while the oscilloscope is turned on, or damage to the components can occur.

Refer to the exploded diagram view later in this chapter for details on how the Option 005 board fits in the oscilloscope. After you remove the defective board, follow the instructions in reverse order to install the new Option 005 board.

- 1** Remove the oscilloscope from the cabinet.
 - a** Turn off the oscilloscope and disconnect the power cable.
 - b** If a module is installed in the oscilloscope, remove it.
 - c** Using the T15 TORX driver, remove the two screws from the rear of the cabinet.
 - d** Using your thumbs, gently push on the two rear-panel connectors to slide the oscilloscope out of the cabinet.
- 2** Remove the faulty Option 005 board.
 - a** Using a T10 TORX driver, remove the two screws that lock the Option 005 board to the chassis.
 - b** Slide the board back away from the front panel to release it from the keyholes.
 - c** Disconnect the three cables attached to the Option 005 board.
 - d** Remove the board from the keyholes, and from the oscilloscope.

Replaceable Parts

The Hewlett-Packard exchange program allows you to exchange a faulty assembly with one that has been repaired and performance verified by Hewlett-Packard. The system board is part of this exchange program with Hewlett-Packard.

After you receive the exchange assembly, return the defective assembly to Hewlett-Packard.

- Customers in the United States have 30 days to return the defective assembly. If you do not return the faulty assembly within the 30 days, Hewlett-Packard will charge you an additional amount. This amount is the difference in price between a new assembly and that of the exchange assembly.
- For orders not originating in the United States, contact your nearest Hewlett-Packard Sales Office for information.

To order a replacement part

- To order a part in the material list, quote the Hewlett-Packard part number, indicate the quantity desired, and address the order to your nearest Hewlett-Packard Sales Office.
- To order a part not listed in the material list, include the model number and serial number of the oscilloscope, a description of the part (including its function), and the number of parts required. Address the order to your nearest Hewlett-Packard Sales Office.
- To order using the direct mail order system, contact your nearest Hewlett-Packard Sales Office.

Within the USA, Hewlett-Packard can supply parts through a direct mail order system. The advantages to the system are direct ordering and shipment from the HP Parts Center in Mountain View, California. There is no maximum or minimum on any mail order. (There is a minimum amount for parts ordered through a local Hewlett-Packard Sales Office when the orders require billing and invoicing.) Transportation costs are prepaid (there is a small handling charge for each order) and there are no invoices.

For Hewlett-Packard to provide these advantages, a check or money order must accompany each order. Mail-order forms and specific ordering information are available through your local Hewlett-Packard Sales Office. Addresses and telephone numbers are located in a separate document shipped with the instrument.

Figure 8-3

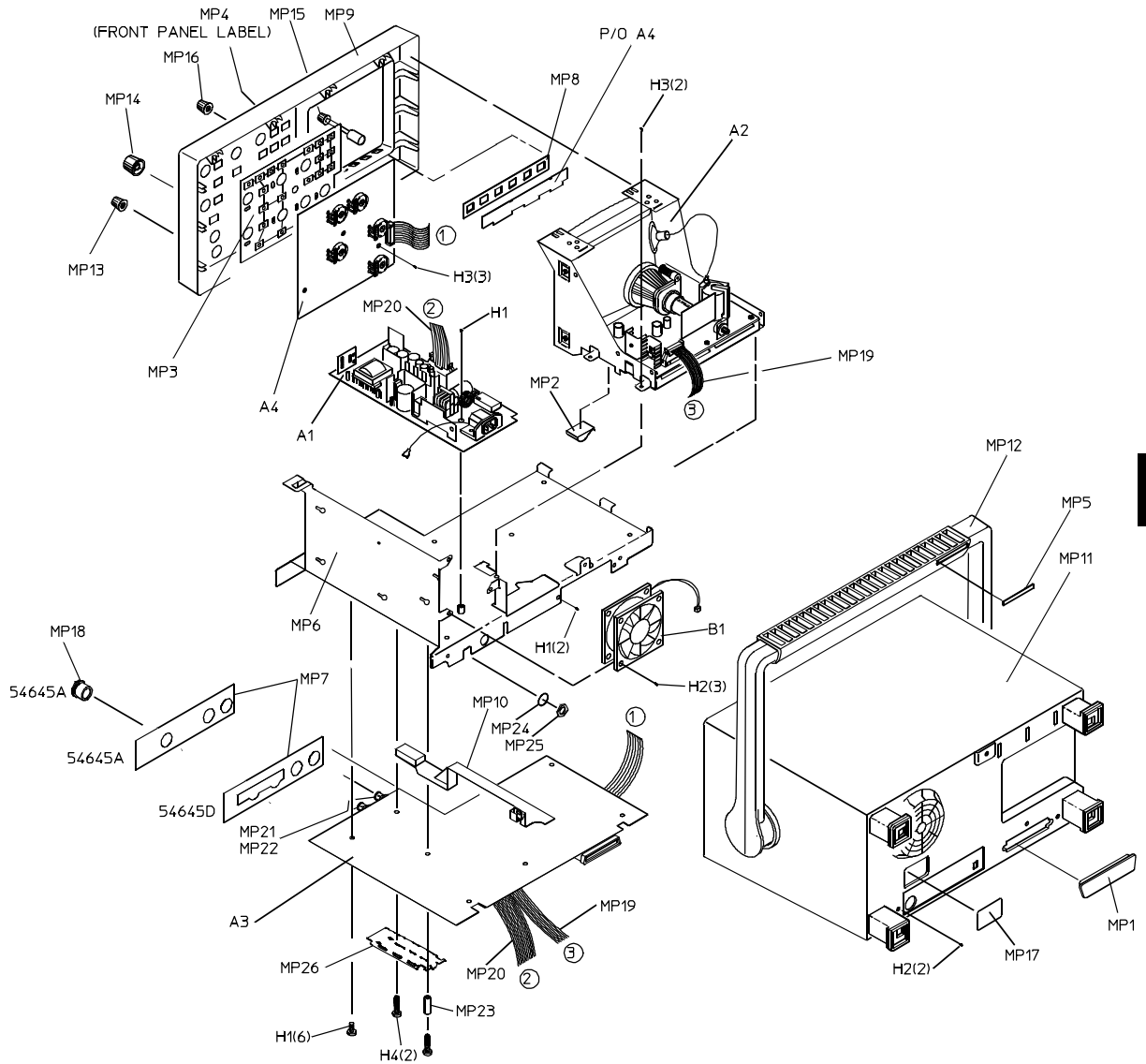

Exploded View of HP 54645A/D Oscilloscope

Replacement Parts
To order a replacement part

Table 8-1

HP 54645A/D Oscilloscope Replaceable Parts

Reference Designator	HP Part Number	Qty	Description
A1	0950-2735	1	Power supply assembly
A2	2090-0316	1	Display assembly
A3 (HP 54645A)	54645-66503	1	System board
A3 (HP 54645A)	54645-69503	1	Exchange system board
A3 (HP 54645D)	54645-66501	1	System board
A3 (HP 54645D)	54645-69501	1	Exchange System board
A4 (HP 54645A)	54600-66502	1	Keyboard
A4 (HP 54645D)	54645-66502	1	Keyboard
B1	3160-1006	1	Fan
H1	0515-0372	9	Machine screw M3X8
H2	0515-0380	5	Machine screw M4X10
H3	0515-0430	5	Machine screw M3X6
H4	0515-0667	2	Machine screw M3X25
MP1	1251-2485	1	Connector dust cover
MP2	1400-1581	1	Cable clamp
MP3 (HP 54645A)	54645-41902	1	Large keypad
MP3 (HP 54645D)	54645-41901	1	Large keypad
MP4 (HP 54645A)	54645-94302	1	Front-panel label
MP4 (HP 54645D)	54645-94301	1	Front-panel label
MP5 (HP 54645A)	54645-94303	1	Handle Label
MP5 (HP 54645D)	54645-94304	1	Handle Label
MP6	54601-00102	1	Deck
MP7 (HP 54645A)	54645-09102	1	EMI gasket
MP7 (HP 54645D)	54645-09104	1	EMI gasket
MP8	54601-41902	1	Small rubber keypad
MP9 (HP 54645A)	54645-42202	1	Front panel
MP9 (HP 54645D)	54645-42201	1	Front panel
MP10	54601-43701	1	Power switch shaft
MP11	54601-64401	1	Cabinet (comes with handle and feet installed)
MP12	54601-44901	1	Handle
MP13 (HP 54645A)	54601-47401	5	Small knob
MP13 (HP 54645D)	54601-47401	6	Small knob
MP14 (HP 54645A)	54601-47402	3	Large knob
MP14 (HP 54645D)	54601-47402	4	Large knob
MP15	54601-47403	1	Intensity knob
MP16	54601-47404	1	Small knob (dark)

Reference Designator	HP Part Number	Qty	Description
MP17	54630-94605	1	Rear-panel label
MP18 (HP 54645A)	54645-42501	1	External trigger nut
MP19	54630-61601	1	Ribbon cable—display
MP20	54630-61602	1	Ribbon cable—power supply
MP21	54645-27601	2	BNC
MP22	54645-09101	2	RFI spring
MP23	0380-0912	1	Spacer
MP24	2190-0068	1	Washer—calibrator output
MP25	1250-2075	1	Nut—calibrator output
MP26	54601-04101	1	Attenuator lid
W1	8120-1521	1	Standard power cord
W1	8120-1703		Power cord option 900, United Kingdom
W1	8120-0696		Power cord option 901, Australia
W1	8120-1692		Power cord option 902, Europe
W1	8120-0698		Power cord option 904, 250 V, USA/Canada
W1	8120-2296		Power cord option 906, Switzerland
W1	8120-2957		Power cord option 912, Denmark
W1	8120-4600		Power cord option 917, Africa
W1	8120-4754		Power cord option 918, Japan
	Option 101		Accessory pouch and front-panel cover (also orderable as HP P/N 54600-68701)
	5041-9482		Pouch
	54601-44101		Front-panel cover
	Probes		
	10074A	2	X1 passive probe
	Input Cable (HP 54645D only)		
	54620-61801	1	Cable, Woven (includes probe leads)
	5959-9333		Package replacement probe leads (quantity 5)
	5959-9334		Package replacement probe grounds (quantity 5)
	5959-9335		Package replacement pod grounds (quantity 5)
	5090-4356		Package replacement grabbers (quantity 20, includes 1 5959-9334)
	01650-94309		Package of probe labels

Replacement Parts
To order a replacement part

Figure 8-4

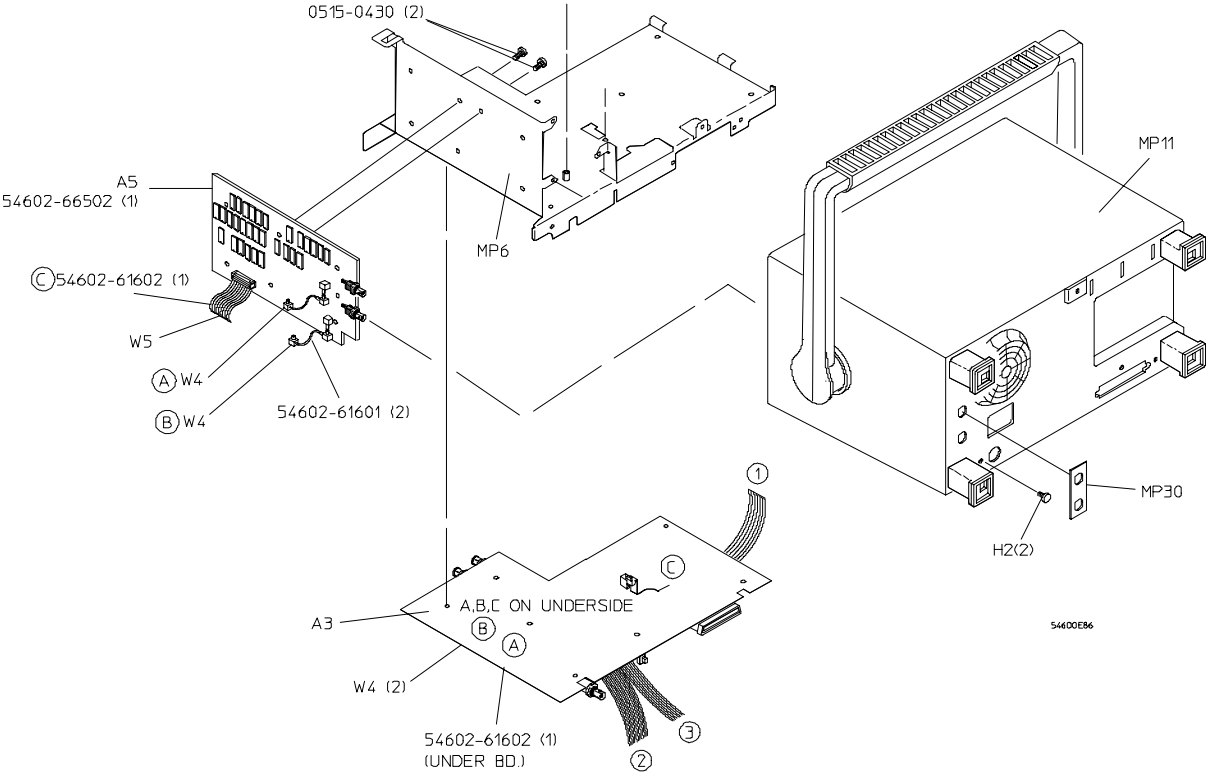

Exploded View of Option 005 and Related Oscilloscope Parts

Table 8-2

Option 005 Replaceable Parts

Reference Designator	HP Part Number	Qty	Description
A3	*	1	System Board (part of standard instrument)
A5	54602-66502	1	Video Trigger Board
H2	0515-0380	5	Machine screw M4 X 10 (part of standard instrument)
H3	0515-0430	7	Machine screw M3 X 6 (+2 screws for Option 005)
MP6	54601-00101	1	Deck (part of standard instrument)
MP11	54602-64402	1	Cabinet (comes with handle and feet installed – replaces standard cabinet)
MP30	54602-94305	1	Label, rear panel video trigger
W4	54602-61601	2	RF cable
W5	54602-61602	1	Ribbon cable
	HP 11094B	1	75-Ω Termination

* See the HP 54645A/D Oscilloscope Replaceable Parts table for this part number.

Performance Characteristics

Performance Characteristics

This chapter lists the operating characteristics and performance specifications for both the HP 54645A and HP 54645D Oscilloscopes.

HP 54645A/D Oscilloscopes

Number of Channels	2 Analog—labeled 1 and 2 on HP 54645A, A1 and A2 on HP 54645D
Probes	10074A
Range	1 mV/div - 5 V/div
Vernier calibrated	± 3%
Position (offset) range	± 8 divisions minimum ± 2V on ranges < 200 mV/div ± 40V on ranges > 200 mV/div Lesser of ± 8 div or ± 32 V
Dynamic Input Range	
DC Vertical Gain Accuracy	
1, 2, 5 sequences	± 1.5% of full scale
Vernier	± 3% of full scale
DC Vertical Offset Accuracy	
serial prefix < US3707	± 1% of full scale ± 0.5% of position value
serial prefix ≥ US3707	± 1% of full scale ± 0.5% of position value (≥ 10 mV/div) ± 2% of full scale ± 0.5% of position value (< 10 mV/div)
Single-Cursor Accuracy	DC vertical gain accuracy + DC vertical offset accuracy ± 1/2 LSB (LSB=0.4% of full scale)
Dual-Cursor Accuracy	DC vertical gain accuracy ± 1 LSB
Bandwidth (3dB)	
Repetitive	100 MHz @ ≥ 10 mV/div (75 MHz @ < 10 mV/div)
Single shot	50 MHz
Bandwidth limit	(~ 20 MHz)
Rise Time (calculated)	~3.5 ns @ > 10 mV/div ~3.9 - 4.6 ns @ < 10 mV/div
Coupling	AC, DC, GND
AC Coupling Corner Frequency	~1.5 Hz
Input Impedance	1 MΩ, ± 1%, ~13 pF
Maximum Input	400 V (DC + peak AC)
Probe ID (HP & Tek compatible)	1X, 10X, 20X, 100X
ESD Tolerance	± 2 kV
Channel Isolation (with channels at the same v/div)	DC to 20 MHz > 40 dB 20 MHz to 100 MHz > 30 dB
Noise Peak-to-Peak	≤3Q levels or 1 mV, whichever is greater
Common Mode Rejection Ratio	20 dB @ 50 MHz
XY Bandwidth	
Bandwidth	100 MHz
Phase error @ 1 MHz	1.8 degrees



HP 54645D Digital Channels

Number of Channels	16 Digital—labeled D0-D15
Threshold Selections	D0-D7, D8-D15
Maximum Input Voltage	± 40 V peak
Threshold Range	± 6.0 V in 50-mV increments
Threshold Accuracy ¹	±(100 mV + 3% of threshold setting)
Input Dynamic Range	± 10 V about threshold
Minimum Input Voltage Overdrive	Greater of 250 mV or 30% of input amplitude. Assumes threshold accuracy is perfect. Input voltage ≥ (threshold value + 30% * Input Voltage) when threshold > 0.84 V or < -0.84 V.
Minimum Input Voltage Swing	500 mV peak-to-peak
Input Capacitance	~8 pF
Input Resistance	100 k Ω, ± 2% at probe tip
Channel-to-Channel Skew	2 ns typical, 3 ns maximum
Predefined Thresholds	TTL=1.4 V, CMOS=2.5 V, ECL=-1.3V
Cable Specifications	Input Z 100 kΩ, ~8 pF, maximum input ± 40 V

¹Performance specification, tested by threshold test. See "Testing, Adjusting, and Troubleshooting."

HP 54645A/D Oscilloscope Digitizing System

Vertical Resolution	8 bits on all settings except 7 bits on < 2 mV/div to 1 mV/div
Horizontal Resolution	500 (displayed points)
Sample Rate	200 MSa/s maximum per channel
Sample Rate Accuracy	0.01%
Peak Detection	5 ns digital
Averages	4, 8, 16, 32, 64, 128, 256, Smoothing—selectable
Memory Depth	1 M maximum
Data Throughput	Up to 3.0 million samples per second with sufficient trigger rate, and not using averaging, time base vernier, waveform math, or vectors.

HP 54645D Logic Digitizing System

Vertical Resolution	1 bit
Maximum Horizontal Resolution	500 (displayed points)
Sample Period	2.5 ns maximum
Glitch Detection	5 ns
8 channels	2.5 ns
16 channels	5 ns
Memory Depth per Channel	2 M maximum
Sample Period Accuracy	0.01%
Simultaneous Capture	Available on all channels.
≤8 channels on same pod	400 MSa/s
> 8 channels	200 MSa/s
any 2 channels on 2 pods	200 MSa/s
Acquire	
All channels off	channels 0-7 @ 400 MSa
0-7 on, 8-15 off	channels 0-7 @ 400 MSa
8-15 on, 0-7 off	channels 8-15 @ 400 MSa
All on	channels 0-15 @ 200 MSa
Data Throughput	Up to 1.5 million samples per second with sufficient trigger rate, and not using time base vernier.

HP 54645A/D Time Base

Range	2 ns/div to 50 s/div (HP 54645A) 5 ns/div to 50 s/div (HP 54645D)
Resolution	40 ps
Vernier	1-2-5 increments when Off, 25 minor increments between major settings when On
Reference Positions	Left, Center, Right
Random Repetitive	Stop freezes display
Pan and Zoom (Random Repetitive)	Shows only 1 trigger
Delay Range	
Pre-trigger (negative delay)	1 screen or 2.5 ms (the greater running repetitively)
Post-trigger (positive delay)	500 seconds
Scope delta t accuracy	(non-vernier ranges)
Same channel	$\pm 0.01\%$ reading $\pm 0.2\%$ screen width ± 40 ps
Channel-to-Channel	$\pm 0.01\%$ reading $\pm 0.2\%$ screen width ± 80 ps
Logic delta t accuracy	(non-vernier ranges)
Same channel	$\pm 0.01\%$ reading $\pm 0.2\%$ screen width \pm (1 logic sample period, 2.5 or 5 ns) \pm chan-to-chan skew
Channel-to-channel	$\pm 0.01\%$ reading $\pm 0.2\%$ screen width \pm (1 logic sample period, 2.5 or 5 ns) \pm chan-to-chan skew
Delay Jitter	10 ppm
RMS Jitter	0.025% screen width + 100 ps pp
Entrance to Delayed Sweep	Not allowed when using any analog channels and > 8 digital channels.

HP 54645A/D Oscilloscope Trigger System

Sources	Channels 1 and 2, line, and EXT (on HP 54645A only)
Range (Internal)	± 6 div
Edges	Either rising or falling
Sensitivity	
< 10 mV/div, DC to 25 MHz	≤ 1 div or 2 mV
< 10 mV/div, 25 MHz to 100 MHz	≤ 1.5 div or 3 mV
> 10 mV/div, DC to 25 MHz	$\leq .35$ div or 3.5 mV
> 10 mV/div, 25 MHz to 100 MHz	≤ 1 div or 10 mV
Coupling	AC, DC, HF reject (~ 50 kHz), LF reject (~ 50 kHz), noise reject
Maximum Input	400 V (DC + peak AC)
Range (External)	± 18 V
Sensitivity	dc to 25 MHz, < 50 mV 25 MHz to 100 MHz, < 100 mV
Coupling	DC, HF reject (~ 50 kHz), noise reject
Modes	Auto, Auto level, Triggered (normal), Basic TV (Line, Field), pattern/logic (on HP 54645D only).
Holdoff Time	~ 200 ns to ~ 25 seconds



HP 54645A Oscilloscope Trigger System

Trigger System	Source, Mode/Coupling, Slope/Glitch Holdoff, Level Channels 1 and 2, Line, EXT (no trigger out) Either rising or falling (not both) Enhanced TV/Video Trigger, Basic TV (Line, Field)
Glitch Triggering	< and > duration, in range, out of range,
Minimum duration time	8 ns
Maximum duration time	100 seconds

HP 54645D Mixed-Signal Oscilloscope Trigger System

Trigger System	Edge, Pattern, Advanced, Mode/Coupling Holdoff, Analog Level Channels A1 and A2, and D0-D15 (no trigger out)
Edge Trigger	Edge on any one source, not multiple sources. Oscilloscope channels: rising or falling edge. Digital channels: rising or falling edge.
Pattern Trigger	High, Low, Don't Care on all sources; optionally combined with simple edge on one source. The simple edge is ANDed with highs, lows, and don't cares. If no edge is present, trigger is on entrance to pattern.
Advanced Trigger Support	Glitch, Adv Pattern, and TV types Basic TV (Line, Field)
Glitch Triggering	< and > duration, in range, out of range,
Minimum duration time	8 ns
Maximum duration time	100 seconds
Advanced Pattern	2 patterns and 2 edge terms. Logic operators AND, OR, Then Pattern entered, exited Edge occurs Pattern duration <, >, range

HP 54645A/D Setup Functions

Save/Recall	10 front-panel setups can be stored and recalled from non-volatile memory.
Trace Memory	Two volatile pixel memories allow storage of Autostore waveforms.
Channel Labels (HP 54645D only)	Each channel may be identified with a six-character label. Labels can be created from a front-panel label generator and a library of up to 75 preset and user-defined labels.
Probe Calibrator	Amplitude 5.0 V, Frequency ~1.2 kHz

HP 54645A/D Power Requirements

Line Voltage Range	88 to 250 Vac
Line Frequency	45 to 440 Hz
Power Usage	~90 W

HP 54645A/D General Characteristics

Environmental Characteristics	Meets the requirements of MIL-T-28800D for Type III, Class 3, Style D equipment as described here.	
	Safety	CSA Certification & IEC 1010
	Ambient Temperature	Operating: -10°C to +55°C Non operating: -51°C to +71°C
	Humidity ¹	Operating: 95% RH at 40°C for 24 h Non operating: 90% RH at 65°C for 24 h
	Altitude	Operating to 4,570 m (15,000 ft) Non-operating to 15,244 m (50,000 ft)
	Vibration	Operating 15 min along each of the three major axes; 0.025-in peak-to-peak displacement, 10 Hz to 55 Hz in 1-minute cycles. Held for 10 min at 55 Hz (4 g at 55 Hz).
	Shock	HP class B1 and MIL-T-28800 Style D, Class 3. Operating 30 g, 1/2 sine, 11-ms duration. 3 shocks/axis along major axis. Total of 18 shocks.
Physical	Size	35.26 cm wide x 17.27 cm high x 31.75 cm deep (without handle)
	Display	Viewable area: ~10 cm V x ~13 cm H
	Resolution	313 V x 512 H (pixels)
	Weight	~7.5 kg
EMI Commercial EMI, Military	Meets FTZ 1046 class B.	
	MIL-T-28800D	Meets the requirements in accordance with paragraph 3.8.3 EMI Type III, and MIL-STD-461C as modified by table XII.
	CE01, CE03, CS01, CS02, CS06	
	RE01	15 dB relaxation to 0 kHz; exceptioned from 20 kHz to 50 kHz.
	RE02 (with Opt 2)	Full limits of class A1c and A1f.
	RE02 (no Opt 2)	10 dB relaxation from 14 kHz to 100 kHz
	RS02	Exceptioned
	RS03 (with Opt 1)	Slight trace shift from 80 MHz to 200 MHz

¹Tested to Hewlett-Packard environmental specification section 758 for class B-1 products.

Option 005 General Performance Characteristics

Video Standards	NTSC, PAL, PAL-M, SECAM, Generic
Video Trigger Modes:	
Line	Field 1, Field 2, Alternate Fields
All Lines	
Field 1	Defined as that field with the 3 lines of vertical sync starting at line 4. Is actually color field 1 or color field 3.
Field 2	Defined as that field with the 3 lines of vertical sync starting at the midpoint of line 3. Is actually color field 2 or color field 4.
All Fields	

Option 005 Trigger System

Internal trigger	
Sensitivity	Performance remains unchanged
Coupling	Performance remains unchanged
Modes	Performance remains unchanged
Holdoff	Performance remains unchanged
TV triggering	Available on channels 1 and 2 only
TV line and field	0.5 division of composite sync for stable display
External trigger	Performance remains unchanged
Vertical output	
Connector	Rear panel BNC (f)
Source Impedance	50 Ω (nominal)
Signal source	Selected by internal trigger source
Amplitude	Approximately 90 mV _{p-p} into 50 Ω for a full-scale display at full bandwidth of the oscilloscope
TV Trigger output	Active only in TV mode
Connector	Rear panel BNC (f)
Amplitude	TTL
Pulse width	A function of TV trigger mode. Minimum approximately 5 μ s in line modes to the width of a field in field modes
Delay from Vertical Output	Approximately 400 ns



Messages

Messages

This chapter presents the various messages displayed by the instrument, explains what they mean, and gives instructions for corrective action if necessary.

All messages in this chapter are presented in alphabetical order.

Other messages may be self-explanatory

There may be other messages that appear on the HP 54645A/D display that are self-explanatory, or clear enough that they are not described in this chapter.

Messages

Address Error

A processing fault occurred during operation. Cycle power to the oscilloscope, or perform a hard reset by cycling power with the two rightmost softkeys depressed. If this does not correct the problem, contact your HP Sales Office for assistance.

Are you REALLY Sure?? Overwrite ALL 75 labels, YES to proceed

This message appears when you press Yes to confirm initialization of the label list. (HP 54645D only)

- To initialize the label list, press the Yes softkey.
- To cancel initialization, press the No softkey.

Autostore data is on screen: Press 'Erase' to clear the screen

This message appears when you try to turn off a trace memory while Autostore data is on the display. To clear the display, press Erase.

Copying screen for printing: Please wait...

This message appears while the display is being buffered into spool memory before printing.

Delay at limit - use delayed sweep to view large negative time

This message appears when you set the oscilloscope to a much faster sweep speed after a single acquisition, where the delay setting is large, but the delayed sweep window is off (main only). To see the desired part of the waveform, change the sweep speed to a slower setting, turn the delayed sweep on, or do both.

Delay is at limit

You have exceeded either the positive or negative time limit for the sweep delay. The limits depend on the current Time/Div setting, sampling rate, and whether the Horizontal Mode is Main or Delayed. See Chapter 4, "MegaZoom Concepts and Oscilloscope Operation," for more information on interaction between time functions in the oscilloscope.

Delay time =

When the Horizontal Mode is Delayed, this message appears while you are adjusting the Delay knob, to inform you of the current delay time setting.

Digital channels are not available in XY or Roll mode

When setting the Horizontal Mode to XY or Roll, you cannot select digital channels D0-D15 on HP 54645D.

Digital channels cannot be moved in XY or Roll mode

When setting the Horizontal Mode to XY or Roll, you cannot change the position of channels D0-D15 on HP 54645D.

Display and setup are saved to memory

This message appears when you save the current display and setup using the Trace memory menu.

Duration time is at limit

This message appears when, in the Advanced Trigger menu, you try to adjust the duration setting for a pattern to a value less than the minimum or greater than the maximum. The minimum and maximum values are determined by the Time/Div and sampling interval, so you may be able to work around the problem by changing the Time/Div setting. See Chapter 4, “MegaZoom Concepts and Oscilloscope Operation,” for more information on the interaction between various oscilloscope time base functions.

Illegal Instruction

A processing fault occurred during operation. Cycle power to the oscilloscope, or perform a hard reset by cycling power with the two rightmost softkeys depressed. If this does not correct the problem, contact your HP Sales Office for assistance.

Key not used in this menu

This message appears when you press a softkey that is not valid for the current menu.

Measurement already active

This message appears when you press the Measure key for a measurement that is already defined and is being updated in the message line.

Measurement already selected

This message appears when you select a single-channel measurement that is already running. Note that measurement results for the selected measurement are displayed on the message line, but are temporarily overwritten by this message.

No active signal was found: Please check connections

This message appears when you select Autoscale, but the oscilloscope was unable to find an input signal on any channel at any threshold setting.

- Check that the input cable is correctly connected to the oscilloscope.
- Check that the probes are connected to valid signal lines in the circuit under test.
- Check power to the circuit under test.
- Check the activity indicators.

No cursor is selected: Please select one in the Cursors menu

This message appears when you turn the Entry knob while using a menu that has no field selectable via Entry. Normally, for those menus, the softkeys, Select, or Move are the only valid choices.

No printer interface is installed: Refer to manual for help

You selected Print Screen from the Print/Utility menu. However, there is no printer interface module installed. You must install an HP interface module (Centronics, HP-IB, or RS-232, as appropriate) for the oscilloscope to connect to the printer.

Printing is in process: Please cancel print first

This message appears when you try to reconfigure the interface parameters for the I/O module while printing. You must either cancel printing with the Cancel Print softkey or wait until printing has completed before reconfiguring the interface.

Printer is not responding: Check configuration & connections.

You selected Print Screen in the Print/Utility menu, and there is an interface installed, but the printer is not responding.

- Check that the printer is turned on and has paper.
- Check that the interface module is connected to the printer and that the correct interface type is being used.

Privilege Violation

A processing fault occurred during operation. Cycle power to the oscilloscope, or perform a hard reset by cycling power with one of the softkeys depressed. If this does not correct the problem, contact your HP Sales Office.

Scope self-test passed

This message appears when one of the oscilloscope self-tests passes.

The selected channel is not displayed: Please select another

The channel you selected with the Select knob is off. These channels appear highlighted in the upper-left corner of the measurement display. Either turn on the channel before moving it, or select a different channel to move. To turn on the channel (HP 54645D only):

- 1 Select the channel using the DIGITAL Position knob.
- 2 Press the On softkey under the labeled channel on the softkey line.
If necessary, press the D0-D15 key first.

To select a different channel to move, use the Select knob.

Selected channel is positioned at the bottom

This message appears when you turn the HP 54645D DIGITAL Position knob counterclockwise and the selected channel is already at the bottom of the display.

Selected channel is positioned at the top

This message appears when you turn the HP 54645D DIGITAL Position knob clockwise and the selected channel is already at the top of the display.

The front panel is locked via the computer interface

This message appears when an instrument controller, such as a PC or workstation, has locked the oscilloscope's front panel using the SYSTem:LOCK command.

The Label List has been initialized to default labels

This message appears after the oscilloscope reinitializes the label list. (HP 54645D only)

The Label List has not been changed

This message appears when you press the No softkey during any step of label list reinitialization. Initialization of the label list is canceled, and the top-level label list menu reappears. (HP 54645D only)

The Printing is canceled

This message appears when you press the Cancel Print softkey to stop printing.

The printing is complete

This message appears when the oscilloscope has finished copying the screen to the printer.

The Setup is recalled

This message appears after the oscilloscope restores the configuration from the specified memory location.

The Setup is saved

This message appears when you press the Save key in the Setup menu, indicating that the oscilloscope setup was saved to the selected memory location (1 through 10).

The test failed with error code

This message appears if one of the oscilloscope self-tests fails. See Chapter 7, “Testing, Adjusting, and Troubleshooting,” for more information on how to run self-test and what to do if self test fails.

The Trace memory is cleared

This message appears when you press the Clear Mem softkey for either Memory 1 or Memory 2 while in the Trace memory menu. It confirms that the selected memory was cleared.

This will overwrite ALL 75 current labels, YES to proceed

This message appears when you select the HP 54645D Initialize Label List softkey in the Label menu.

- To proceed with initialization, press the Yes softkey.
- To cancel initialization, press the No softkey.

Threshold is at limit

The threshold setting is used by the HP 54645D oscilloscope digital channel input comparators to decide whether a signal is a logic high or logic low. The threshold must be set to a value between -6.00 V and +6.00 V inclusive.

Time/Div is at limit

The time per division must be set to a value between 50 s/div and 2 ns/div inclusive.

Use 'Recover Screen' in Setup menu to restore the display

If you inadvertently change the Volts/Div on a given analog channel, that analog channel will disappear from the display. If you change the Volts/Div back to the original setting, the last scope display of that channel re-appears on the screen. You can also choose to recover the screen by pressing Setup , then the **Recover Screen** softkey.

Glossary

This glossary is organized into two parts: logic and scope terms. Logic terms apply only to the HP 54645D MSO (Mixed-Signal Oscilloscope), and scope terms apply to both the HP 54645A/D Oscilloscopes.

HP 54645D Logic Terms

Acquisition is the process by which the MSO collects data. The oscilloscope acquires data by sampling the voltage on each analog and digital input channel and comparing it to the trigger condition. In Normal trigger mode, the oscilloscope begins filling the pre-trigger buffer with data. When that buffer is full, the oscilloscope will begin searching for the trigger event. In Auto trigger mode, the oscilloscope fills the pre-trigger buffer, then searches for the trigger event for a predetermined interval.

Acquisition memory depth is 2M when only one pod is active and the sampling speed is 400 MSa/s. When both pods are active, the sampling speed is reduced to 200 MSa/s and the memory depth is reduced to 1M. Acquisition memory is located in the acquisition subsystem sample RAM.

Advanced trigger consists of two pattern and two edge sources combined with a variety of operators to form the complete Advanced trigger specification. Advanced trigger is best used when the events you want to capture are defined by a complex series of waveform events in the system, and neither pattern mode nor edge mode are capable of clearly resolving the necessary sequence.

Channel controls allow you to move or rearrange channels, turn them on or off, and add descriptive labels.

Duration is the time or signal width measured using the advanced pattern and glitch triggers. In an advanced pattern and glitch triggers, you can set the minimum duration by pressing a softkey or rotating the Entry knob.

Duration trigger operators in advanced pattern and glitch triggers, you can specify a duration on which the oscilloscope should trigger. Duration greater-than and less-than operators are available, and are valid when only pattern terms are involved, and are not selectable when any edge terms are selected as a source.

Glossary

Entered trigger operator is used in the advanced pattern trigger. “Entered” means that the trigger qualifier is satisfied as soon as the input waveforms have transitioned from a state that does not match the pattern to a state that does match the pattern.

Graticule refers to the hash marks on the display. These marks can be set to full, frame, or none.

Labels are terms defined or chosen from a predefined list to associate input channels with their functions in the system under test. When you assign a label ending in a digit, such as D0, the oscilloscope inserts the label into the non-volatile label list, automatically increments the digit, displays the modified label in the entry field, and selects the next channel.

Memory See “Display memory,” “Setup memory,” or “Trace memory.”

Minimum detectable pattern width is the minimum time for which an input pattern must remain stable for the oscilloscope to recognize it as matching a pattern trigger specification. At very fast sweep speeds (small Time/Div settings), the pattern width is nearly a constant value. At time base settings of 2 $\mu\text{s}/\text{div}$ and

slower, this is approximately a constant value plus one sample period.

Minimum duration trigger setting specifies the shortest duration setting that the oscilloscope can accurately verify against the incoming pattern. The minimum duration trigger setting is two sample periods or 16 ns, whichever is greater.

Negative width is the time for which a signal is low.

Pattern trigger defines a set of pattern of highs, lows, and don't care inputs that must be recognized across the input channels during any given input sample. The pattern may be combined with one edge on any input channel to form the complete trigger specification. The pattern trigger occurs when the pattern is entered.

Period is calculated by selecting the first and third transitions from the left side of the visible display and measuring the delta time between these two transitions.

Positive width is the time of a signal or glitch that is high.

Signal inputs connect the MSO acquisition system to the probes.

Sweep speed (time base) is the amount of time per division on the display, and is shown on the status line. When you vary the Time/Div setting while running an acquisition, the sample period is also being adjusted.

Thresholds define the voltage at which there is a change from low to high. Thresholds specified can be TTL, CMOS, or ECL, or variable from -6.0 V to +6.0 V.

Time base See “Sweep speed.”

Trigger is the point that causes the oscilloscope to begin storing acquisition data. The trigger can be a signal edge, a pattern, or a combination of edges, patterns, and durations. See “Edge trigger,” “Pattern trigger,” or “Advanced trigger.”

Width refers to positive and negative duration of a signal. The signal width can be measured using time measurements. In doing so, the oscilloscope measures the time between the first set of transitions at the left side of the visible display that begin and end the logic high or low value. See also “Minimum detectable pattern width.”

HP 54645A/D Oscilloscope Terms

Acquisition memory stores the acquired sample. This memory is part of the acquisition subsystem, and is located in the sample RAM.

Aliasing is occurring whenever the waveform display changes more than expected, as you expand the time base. Aliasing is due to under sampling.

Auto is a trigger mode that produces a baseline display if the trigger conditions are not met. If the trigger frequency is less than 25 Hz, even if the level and slope conditions are met, a free-running display will result.

Auto Level sets the trigger point to the 50% amplitude point on the displayed waveform. If there is no signal present, a baseline is displayed.

Autoscale performs a simple one-button setup of the oscilloscope, including setting the time base and thresholds and displaying waveforms for channels connected to active signals.

Glossary

Autostore records the result of every acquisition on the display in half-bright tone. When Autostore is on, the oscilloscope updates pixel (display) memory with new acquisitions, but does not erase the results of previous acquisitions.

Auto trigger mode causes the oscilloscope to fill the pre-trigger buffer, then searches for the trigger event for a predetermined interval. If no trigger is found, the oscilloscope forces a trigger and displays the data as though the trigger had occurred.

Baseline is a free-running trace on the display when no signal is applied and the trigger mode is set to auto or auto level.

BW Lim (bandwidth limit) limits the displayed bandwidth of the selected channel to 20 MHz, and is available for channels 1 and 2. This feature is useful for viewing noisy signals.

Control knobs include the Volts/Div, Time/Div, Delay, Select, Position, Entry, and display intensity knob.

Coupling changes the input coupling. Channels 1 and 2 allow dc, ac, or ground. In the trigger menu, it

toggles between dc and ac for trigger coupling.

Cursors are horizontal and vertical markers used for making custom voltage and time measurements, such as measuring time between particular points on the display or numeric values of the currently displayed waveforms. The HP 54657A module also provides access to frequency cursors when FFT is active.

Data acquisition See “Acquisition.”

Deep Stop describes the last acquisition taken when you press the STOP key. During this acquisition, all available memory (1M) is filled, regardless of the sweep speed.

Delay in main sweep, the Delay knob moves the sweep horizontally, and indicates how far the time reference is from the trigger point. In delayed sweep the Delay knob moves the starting point of the portion of the main sweep to be expanded by the delayed sweep.

Delay time in Main sweep is the time between the current trigger and the time reference point. In delayed sweep, it is the time between the center of the delayed sweep window and the time reference position.

Delayed a horizontal mode that gives an expanded view of the main sweep.

Delayed sweep is the oscilloscope display function that magnifies the contents of sample memory. Use delayed sweep to zoom in on a portion of the waveform and pan and zoom through it to examine it in greater detail.

Display allows selection of either normal, peak detect, or averaged display modes. It also allows selection of vectors on/off and provides grid choices.

Display memory is also called pixel memory. The display memory is part of the display subsystem, and is located in the waveform RAM. A data-to-waveform conversion gate array is provided to convert the data and display the acquisition. Also see "Autostore."

Duty cycle can be measured using time measurements. The oscilloscope measures the period and positive width, and then calculates the duty cycle by dividing the period into the pulse width and multiplying the result by 100%.

Edge trigger is a single rising or falling edge (or either) that must be

recognized on an input channel to satisfy the trigger condition.

Erase clears the current display and acquisition memory.

External Trigger is a non-viewable input to the HP 54645A used only as a trigger source.

External trigger input allows you to trigger the HP 54645A oscilloscope from another instrument or another signal in the circuit under test.

Field 1 triggers on the field 1 portion of the video signal.

Field 2 triggers on the field 2 portion of the video signal.

Frequency can be measured using time measurements. The oscilloscope selects the first and third transitions at the left side of the visible display, measures the period as the delta time between these two transitions, then calculates the frequency as the reciprocal of the period.

Glitch Detection See Peak Detection.

Glitch trigger mode is indicated by a positive or negative pulse on the status line. In glitch capture mode, the oscilloscope uses memory resources to record an event where at least two transitions occurred between sample periods. The oscilloscope can capture pulses as narrow as 3.5 ns and as long as the sample period—1 ns at any sweep speed.

HF Reject (high-frequency reject) adds a low-pass filter with a 3 dB point at 50 kHz to the trigger path.

Holdoff keeps the trigger from rearming for an amount of time set by the holdoff knob.

Horizontal controls adjust the time base, horizontal mode, and delayed sweep functions.

Invert shifts the displayed waveform 180 degrees, and is available for channels 1 and 2. When the oscilloscope is triggered on the signal to be inverted, the trigger is also inverted.

Level changes the trigger level.

LF Reject (low-frequency reject) adds a high pass filter with a 3 dB point at 50 kHz to the trigger path.

Line in TV trigger mode, the oscilloscope triggers on the TV line sync pulses. As a trigger source, the oscilloscope triggers off of the power line frequency.

Main/Delayed allows you to select the horizontal mode (Main, Delayed, XY, and Roll), and set the vernier and time reference.

Measurement algorithms are used to calculate input frequency, input period, duty cycle, positive and negative widths on logic channels, and rise time and fall time.

Measurement field is used to display results for measurements, trigger settings, error messages, and status messages.

MegaZoom technology is HP's technology that combines the advantages of conventional deep-memory digital oscilloscopes with the responsiveness and update rate of traditional analog oscilloscopes. See the chapter "MegaZoom Concepts and Oscilloscope Operation" for more information.

Mode/Coupling allows you to select a trigger mode (Auto level, Auto, Normal), Coupling, Reject, and Noise Reject.

Noise Rej (noise reject) decreases the trigger sensitivity to reduce triggering on signal noise.

Normal allows a waveform to be displayed if a trigger signal is present and the trigger conditions are met. If there is no trigger signal, the oscilloscope does not trigger and the display is not updated.

Normal trigger mode causes the oscilloscope to begin filling the pre-trigger buffer with data. When the buffer is full, the oscilloscope will begin searching for the trigger event. When the trigger event is found, the oscilloscope fills the post-trigger buffer and displays the acquisition memory. Until the oscilloscope finds the trigger, the acquisition will not be displayed, and the oscilloscope will search for the trigger indefinitely.

Pan the display means the acquisition moves horizontally on screen when you rotate the Delay knob. Panning the display adjusts the amount of time between the trigger event and the time reference point on the display.

Peak Detection allows detection of analog signal extremes as the sample rate is decreased in the 5 s to 50 ms/div time base settings.

Pixel memory See “Display memory.”

Polarity selects either positive or negative TV sync or Glitch pulses.

Position is a knob that moves a selected signal vertically on the display.

Print copies the current display to the attached printer. You must have either an HP-IB, RS-232, or Centronics/parallel Interface module to use the print capability.

Print/Utility allows access to the module menus, system config menus, and service menus.

Probe allows selection of 1, 10, 20, or 100 to match a probe's division ratio so that the vertical scaling and voltage measurements reflect the actual voltage levels at the tip of the probe.

Recall Setup brings up a selected front-panel setup that you saved to one of the trace memories. Memory selection is done with either a soft-key or the Entry knob.

Roll mode is a horizontal display mode that causes the waveform to move across the screen from right to left.

Glossary

Run acquires data and displays the most recent trace.

Run indicator is displayed at the right end of the status line when the acquisition is running.

Sample period is the interval at which the input is sampled. The oscilloscope acquires data by sampling the voltage on each input channel and comparing it to the threshold voltage to determine whether the input was a logic high or logic low. The acquisition mode, trigger functions, delayed sweep, and measurement functions depend on the sample period. The sample period, in turn, depends on the Time/Div setting.

Save stores the current front-panel setup to one of the Setup memory locations. Memory selection is done with either a softkey or the Entry knob.

Setup allows access to the setup memory and front-panel setup keys.

Setup memory allows you to save the current configuration of the instrument, including time base, threshold, channel settings, measurement definitions, and labels. You can use these later to verify the results of a change, or you can use them regularly for testing and trou-

bleshooting. These memories are non-volatile.

Single (single shot) triggers once when the trigger conditions are met. The oscilloscope must be rearmed before the oscilloscope retriggers by pressing either the Run or Autostore front-panel keys.

Single indicator is shown as the letters “Sngl” in the top line of the display and indicates that the current display was captured by pressing the Single key (a single acquisition was performed, then the oscilloscope stopped).

Slope selects either the rising or falling edge of the signal to trigger the oscilloscope.

Slope/Glitch allows access to the trigger slope, glitch, and TV trigger condition controls.

Smoothing is an oversampling technique used when the digitizer sampling rate (200 MSa/s) is faster than the rate at which samples are stored into memory. Smoothing produces a smooth trace on the screen.

Softkeys set up various options for major functions. The softkeys change depending on the function you select. Some softkeys have an immediate action, and others allow you to scroll through a list of choices. Some softkeys are labeled with two choices below; the highlighted choice is currently active. When several softkeys are displayed with a labeled bar over them, they are either related, or the choices are mutually exclusive.

Source allows you to select a trigger source.

Status indicators are at the top line of the display and show channels turned off, the sampling interval, glitch mode, delay, time base setting, trigger condition, and acquisition mode.

Stop freezes the display.

STOP indicator is displayed at the right end of the status line when the acquisition has been stopped.

Storage keys control start and stop of acquisition, persistent acquisition, and screen erasure.

STORE indicator is displayed at the right end of the status line when Autostore is selected.

Time allows access to the automatic time measurement keys.

Time/Div changes the time base in a 1-2-5 step sequence from 2 ns to 50 s (for HP 54645A) and from 5 ns to 50 s (for HP 54645D).

Time Ref sets the time reference to either one graticule in from the left or right edge of the display, or to center of the display.

Trace allows access to the trace storage keys.

Trace Mem (trace memory) refers to one of two pixel memory locations used for storing traces. If you use the Measurement/Storage module, additional trace memories are available.

Trace memory is also called pixel memory. Trace memories allow you to save the visible portion of the acquisition (the displayed waveform) for later recall and comparison with other measurements. Trace memory is normally volatile. However, adding an interface module makes the trace memory non volatile. Trace memory also saves the current configuration, separate from the 10 setup memories.

Glossary

Trigger mode can be set to Auto Level, Auto, or Normal. See “Normal trigger mode” or “Auto trigger mode.”

TV allows access to the TV mode and polarity keys.

Vernier is a softkey for both HP 54645A/D in the Main/Delayed and Analog channel menus that gives finer increments of the sweep speed and Volts/Div.

Voltage allows access to the automatic voltage measurement keys.

Volts/Div Changes the vertical scaling in a 1-2-5 step sequence from 2 mV to 5 V.

Waveform parameters are measured using cursors.

XY Changes the display to a volts-versus-volts display.

Zoom means to expand the waveform on the screen. You can use delayed sweep to zoom in on a portion of the waveform to examine it in greater detail.

Index

A

accessories
 optional, 1-7
 supplied, 1-5 to 1-9
accuracy
 testing thresholds, 7-12
acquisition
 and channels off, 2-24
 buffer, 2-28
 indicator for, 2-13 to 2-14
 setting up with Autoscale, 2-18 to 2-19
 single, 4-33
 starting, 2-28
 stopping, 2-28
acquisition memory
 location of trigger event, 4-22 to 4-28
 setting time reference in, 4-22 to 4-28
 time base affects time to fill, 4-27
acquisition results
 save in trace memory, 4-45
acquisition system
 performance characteristics, 9-6
 self-tests, 7-11
action to cause trigger, 3-4
Active Cursor, 2-30, 5-22
activity check during Autoscale, 2-20
activity indicators
 for threshold test, 7-14
adjusting
 display brightness, 1-4, 1-13
 handle, 1-9
 oscilloscope, 7-2
adjustments
 display, 7-38 to 7-39
 high-frequency, 7-29
 low-frequency, 7-29
 power supply, 7-30 to 7-32
Adv, 3-19 to 3-24
advanced trigger, 3-19 to 3-24
 applications of, 3-14
 setting up, 3-21
 setup rules, 3-22
 solve data acquisition problems, 3-21
aliasing
 misleading information, 4-11
All Fields, 6-9
Alt Fld
 See alternate fields
alternate fields, 6-5

ambient temperature, 7-29
analog channels
 acquired, 2-25
applications of trigger
 to complex situations, 3-14
 to edges, 3-12
 to patterns, 3-13
assemblies
 ordering, 8-12 to 8-17
 replacing on exchange program, 8-11
assigning labels, 4-54 to 4-57
associating circuit signals and input
 channels, 4-53 to 4-58
attenuation factor
 for probes, 2-23
Auto Single mode, 4-35, 4-38
auto-increment
 in labels, 4-54
automatic measurements
 time, 5-28 to 5-31
 voltage, 5-32 to 5-34
automatic probe sensing, 2-23
Autoscale, 2-18 to 2-19
 operation of, 2-20
 performance characteristics, 9-9
 try to display channels, 7-5 to 7-6
 try to display trace, 7-4 to 7-5
 undo, 2-18 to 2-19, 4-48
 video, 6-4, 6-12
Autostore
 and Erase, 4-38
 and Single, 4-33
 message, 10-3
average mode, 2-13
averaging, 5-10
 Av indicator, 5-10
 Average softkey, 5-10

B

bandwidth
 to verify, 7-19 to 7-21
BenchLink for Microsoft Windows, 1-7
Berg strip, 7-9 to 7-10
best probing practices, 4-42
bezel
 flexing on front panel, 8-9
BNC
 cable assembly, 7-13
 connector, 7-10

boards

 removing the system board, 8-6
 replaceable parts, 8-2
 training, 1-7

brightness

 adjusting display, 1-4, 1-13

C

cabinet

 removing, 8-4
 removing the handle, 8-9

cable

 removing probe leads, 1-12

cables

 calibration, to display, 8-6
 calibration, to system board, 8-6
 part number for, 1-5 to 1-9
 probe, 1-11 to 1-12
 ribbon, to display, 8-6
 ribbon, to power supply, 8-8
 ribbon, to system board, 8-5 to 8-6

calibration

 adjustments, 7-29
 self, 7-33 to 7-34
 calibration cable
 disconnect to remove display, 8-6
 disconnect to remove system board, 8-6
 take care when removing keyboard, 8-9

 calibration point, 7-11

 calibrator, 7-15, 7-34

 cancel printing, 2-34

 capacitance of impedance, 4-39 to 4-42

 capture single-shot events, 4-33

 carrying case, 1-7

center

 time reference position, 4-22 to 4-28

 changing channel order, 2-26

 changing time reference, 4-22 to 4-28

 channel problems, 7-5 to 7-6

channels

 assigning labels to, 4-54 to 4-57
 attach ground leads, 4-42
 connecting to test, 7-13
 enabled/disabled by Autoscale, 2-20
 list of those off, 2-13 to 2-14
 message, 10-7
 order of, 2-26
 performance characteristics, 9-3
 positioning, 2-26

-
- preset configuration, 4–48
 - selecting, 2–26
 - selecting for edge trigger, 3–16
 - selecting for pattern trigger, 3–17
 - test thresholds, 7–14
 - testing acquisition system, 7–11
 - testing threshold accuracy, 7–12
 - turning labels on or off, 4–53
 - turning on and off, 2–24
 - characteristics
 - Option 005, 9–11
 - See performance characteristics
 - probe input impedance, 4–39 to 4–42
 - checking
 - package contents, 1–5 to 1–9
 - checklist
 - for solving problems, 7–4 to 7–6
 - circuit ground
 - connecting oscilloscope, 1–11 to 1–12
 - circuit signals
 - associating with input channels, 4–53 to 4–58
 - circuit under test
 - action to cause trigger, 3–4
 - concepts of probing, 4–39 to 4–42
 - clamp circuit
 - internal, 6–12
 - clamping
 - external, 6–12
 - Clear Cursors softkey, 2–30, 5–22
 - Clear Meas softkey, 5–29
 - clear measurement, 5–29
 - Clear softkey, 4–46
 - clearing labels, 4–58
 - clock channel
 - threshold accuracy, 7–12
 - CMOS threshold, 4–51 to 4–52
 - color burst, 5–21
 - comparators
 - input, 4–51 to 4–52
 - comparing measurement results, 4–43
 - complex waveforms, 3–6
 - components
 - See replaceable parts
 - concepts
 - input impedance, 4–39 to 4–42
 - making accurate measurements, 4–2
 - probe grounding, 4–40
 - probing circuit under test, 4–39 to 4–42
 - probing practices, 4–42
 - configuration
 - default, 2–18 to 2–19
 - preset default settings, 4–48
 - saving and recalling, 4–44
 - using Autoscale, 2–18 to 2–19
 - connecting
 - grabbers, 1–11 to 1–12
 - to circuit ground, 1–11 to 1–12
 - to function generator, 7–13
 - connecting to circuit ground, 1–11
 - contents of oscilloscope package, 1–6, 1–9
 - contents of scope package, 1–5 to 1–8
 - controls
 - front panel, 2–6
 - creating labels, 4–56 to 4–57
 - cursor measurements, 2–30 to 2–31, 5–22 to 5–25
 - cursors
 - active, 2–30, 5–22
 - clear, 2–30, 5–22
 - Cursors key, 2–30, 5–22
 - message, 10–6
 - preset configuration, 4–48
 - custom labels, 4–54 to 4–57
- D**
- DAC softkey, 7–15
 - damaged shipment, 1–5 to 1–9
 - data acquisition
 - See acquisition
 - data channel
 - threshold accuracy, 7–12
 - DC level shifts, 6–12
 - deep memory, 5–3
 - default
 - configuration, 2–19
 - default configuration, 2–18
 - default setup, 4–48 to 4–50
 - defective assemblies, 8–11
 - defining
 - labels, 4–56 to 4–57
 - defining edge trigger, 3–20
 - defining sources, 3–20
 - delay, 2–13 to 2–14, 2–27
 - Delay knob, 2–32, 5–5
 - introduced by time base, 4–27
 - message, 10–4
 - Delayed softkey, 2–32
 - delayed sweep, 2–32, 6–13
 - characteristics, 2–32, 5–4 to 5–5
 - operation, 2–32, 5–4 to 5–5, 5–11
 - window indicator, 5–4
 - window Time/Div setting, 5–4
 - delta t/delta V
 - See cursor measurements
 - design of probe tip, 4–40
 - design test ports, 4–42
 - digital channels
 - acquired, 2–25
 - disassembly, 8–3
 - display
 - adjusting brightness of, 1–4, 1–13
 - and labels, 4–53 to 4–58
 - and trigger, 3–3
 - Display key, 7–38
 - erasing, 4–38
 - flashing, 2–13
 - of acquired data, 2–28
 - recovering, 4–21
 - removing, 8–6
 - sample rate, 2–27
 - to adjust, 7–38 to 7–39
 - to erase, 4–35
 - turning labels on or off, 4–53 to 4–55
 - display flashing, 2–14
 - display modes
 - average, 2–13
 - peak detect, 2–13
 - roll, 5–13
 - distortion
 - worst case, 6–10
 - divisions on graticule, 2–33
 - duplicate labels, 4–56
 - duration
 - and advanced pattern trigger, 3–14
 - message, 10–4
 - duration operators
 - for advanced trigger, 3–22
 - duration trigger, 3–19 to 3–24
 - dust cover, 1–7
 - Duty Cy softkey, 5–29
-

E

ECL threshold, 4-51 to 4-52
 Edge, 3-16
 edge and pattern triggers combined, 3-22
 edge qualifier in pattern trigger, 3-17
 edge trigger, 3-16
 applications of, 3-12
 qualifying a pattern, 3-13
 edges
 defining for trigger, 3-20
 Edit Label softkey, 4-46
 entered (pattern trigger), 3-13
 Entry knob, 3-17
 choosing edge trigger channel, 3-16
 choosing labels from list, 4-54 to 4-55
 equation
 for voltage behavior, 4-41
 equipment
 for testing threshold accuracy, 7-12
 set up to test threshold accuracy, 7-13
 Erase, 4-38
 labels, 4-58
 erasing the display, 4-35
 error messages, 10-2
 errors in operation
 See solving problems
 even field, 6-10 to 6-11
 events
 and pattern trigger, 3-13
 capturing single-shot, 4-33
 exchange program, 8-11
 exploded view, 8-13
 external trigger, 9-11
 external trigger input
 testing threshold accuracy, 7-12

F
 factory-default settings, 2-18 to 2-19
 failing self-tests
 acquisition system, 7-11
 fall time, 5-28 to 5-29
 fan
 remove to remove power supply, 8-8
 removing, 8-4
 Field 1, 6-8
 Field 2, 6-8
 fields
 all, 6-9

 alternate, 6-5
 even, 6-10 to 6-11
 Field 1, 6-5, 6-10 to 6-11
 Field 1 softkey, 5-18
 Field 2, 6-5, 6-10 to 6-11
 Field 2 softkey, 5-18
 Field 3, 6-10 to 6-11
 Field 4, 6-10
 odd, 6-10 to 6-11
 firmware calibration, 7-33 to 7-34
 flashing
 of indicators on display, 2-13 to 2-14
 forced trigger, 3-3
 Freq softkey, 5-26
 frequency
 measurements, 5-26 to 5-27, 5-29
 reject, 5-8 to 5-9, 5-18
 front panel
 dust cover, 1-7
 flex bezel to remove keyboard, 8-9
 functions, 2-6
 hooks, 8-5
 message, 10-4
 removing, 8-5
 retainer tabs, 8-5
 front-panel keys
 See keys listed by name
 function generator, 7-13
 set DC offset voltage, 7-14
 functional controls, 2-6

G

GENERIC, 6-4 to 6-6
 GENERIC mode, 6-6
 glitch
 capture, 5-11
 trigger, 3-2
 glitch mode, 2-14
 good uses
 for advanced trigger, 3-14
 for edge trigger, 3-12
 for pattern trigger, 3-13
 grabbers
 connect ground lead, 1-11 to 1-12
 connect probe lead, 1-11 to 1-12
 connecting to circuit ground, 1-11
 connecting to ground lead, 1-11
 part number for, 1-5 to 1-9

graticule

 modifying settings, 2-33
 preset configuration, 4-48
 settings for hash marks, 2-33
grid
 softkeys, 2-33, 6-2
ground
 bounce, 4-41
 inductance, 4-41
 probes to make measurements, 4-42
ground lead
 connect probe cable, 1-11 to 1-12
 part number for, 1-5 to 1-9

H

half-bright contrast, 7-39
 handle
 adjusting, 1-9
 removing from cabinet, 8-9
 hash marks
 in waveform display, 2-33
 high-frequency
 HF Rej softkey, 5-18
 probe circuit, 4-40
 pulse response, 7-36 to 7-37
 reject, 5-8, 5-18
 high-speed timing measurements
 use probe ground, 4-42
 holdoff, 3-6, 6-11
 hooks on front panel, 8-5
 horizontal
 hold, 7-39
 mode, 2-13
 vernier, 2-27
 horizontal system
 performance characteristics, 9-5
 HP service
 component info packets, 8-2
 exchanging assemblies, 8-11
 mail order system, 8-12 to 8-17
 obtain to solve problems, 7-4
 HP-IB Interface module, 4-43

I
 impedance of probes, 4-39 to 4-42
 incorrect trace display, 7-5
 indicators, 2-13 to 2-14
 flashing, 2-13 to 2-14

-
- status, 2-13 to 2-14
 - initializing label list, 4-58
 - input
 - setting signal thresholds, 4-51
 - signals setting threshold, 4-51 to 4-52
 - input channels
 - performance characteristics, 9-3
 - input comparators, 4-51 to 4-52
 - interface modules
 - documentation, 2-34
 - make trace memory non-volatile, 4-43
 - interface parameters, 2-34
 - interfaces
 - message, 10-6
 - interlaced TV system, 6-6
 - internal trigger, 9-11
 - interval
 - of auto trigger, 3-3
 - vertical, 6-8
 - K**
 - keyboard
 - removing, 8-9
 - kit
 - training, 1-7
 - L**
 - Label, 4-56 to 4-58
 - Label key, 4-53 to 4-58
 - use to reset scope, 7-4
 - label list
 - don't initialize during reset, 7-4
 - labeling inputs, 4-53 to 4-58
 - labels
 - and waveform display, 4-53 to 4-58
 - assigning, 4-54 to 4-57
 - auto-increment feature, 4-54
 - defining, 4-56 to 4-57
 - duplicates, 4-56
 - initializing, 4-58
 - list management, 4-56
 - message, 10-3
 - preset configuration, 4-48
 - turning on or off, 4-53
 - Left
 - time reference position, 4-22 to 4-28
 - level shifts
 - DC, 6-12
 - LF reject, 5-9
 - limitations
 - only one edge in pattern trigger, 3-17
 - line
 - trigger, 9-11
 - trigger (TV), 5-21
 - Line softkey
 - TV, 5-18
 - list
 - of channels that are off, 2-13 to 2-14
 - of disabled channels, 2-24
 - of replaceable parts, 8-14
 - of supplied accessories, 1-5 to 1-9
 - Load Defaults softkey, 7-34
 - logic levels, 3-17, 4-51 to 4-52
 - key use to test thresholds, 7-14
 - logic threshold, 4-51 to 4-52
 - logical operators
 - and advanced trigger, 3-19 to 3-24
 - low-frequency
 - compensation, 7-35
 - probe circuit, 4-39 to 4-42
 - reject, 5-9, 5-18
 - M**
 - mail order system
 - use to replace parts, 8-12 to 8-17
 - main sweep, 2-32
 - Time/Div for window, 5-4
 - Main/Delayed key, 2-32
 - making
 - test connectors, 7-9 to 7-10
 - manuals
 - supplied, 1-5 to 1-9
 - marker
 - See cursor measurements
 - markers, 2-32
 - for delayed sweep window, 5-4
 - material list, 1-5 to 1-9
 - materials
 - for making test connectors, 7-9 to 7-10
 - list, 1-6
 - measurement
 - automatic, 2-32, 5-28 to 5-34
 - clear, 5-29
 - duty cycle, 5-28 to 5-29
 - fall time, 5-28 to 5-29
 - frequency, 5-26 to 5-27, 5-29
 - period, 5-28 to 5-29
 - phase, 5-14 to 5-16
 - rise time, 5-28
 - show, 5-27, 5-29
 - time, 5-28 to 5-29
 - width, 5-28
 - windowed, 6-12
 - measurement process, 1-2
 - oscilloscope setup, 1-4
 - measurements
 - and channels off, 2-24
 - concepts for making accurate, 4-2
 - preset configuration, 4-48
 - MegaZoom technology, 4-2, 4-5, 5-3
 - memory
 - deep, 5-3
 - preset configuration, 4-48
 - messages, 10-2
 - Microsoft Windows
 - BenchLink software, 1-7
 - missing trigger, 3-4
 - modes
 - Auto Single, 4-35
 - glitch, 2-14
 - peak detect, 2-13, 5-11
 - trigger, 2-13 to 2-14
 - modify graticule, 2-33, 4-51
 - moving channels, 2-26
 - multimeter
 - use to monitor function generator, 7-13
 - N**
 - names
 - assigning to channels, 4-54 to 4-55
 - defining, 4-56 to 4-57
 - naming
 - input signals, 4-53 to 4-58
 - narrow pulses, 5-11
 - new labels, 4-56 to 4-57
 - Next Menu softkey, 5-27, 5-29, 5-33
 - no trigger, 3-4
 - noise
 - asynchronous signal, 5-6 to 5-7
 - reject, 5-8
 - noisy signals
 - to remove from display, 5-8 to 5-10
 - to view, 5-6, 5-8 to 5-10
 - non-interlaced TV system, 6-6
-

-
- non-volatile settings
 - label list, 4-56
 - non-volatile setup memory, 4-44
 - NTSC, 6-4, 6-6, 6-10 to 6-11

 - O**
 - odd field, 6-10 to 6-11
 - On/Off
 - "Off" channels, 2-24
 - measurements and channels, 2-24
 - operation of Autoscale, 2-20
 - operators
 - for trigger, 3-19 to 3-24
 - Option 005, 6-2
 - characteristics, 9-11
 - triggering, 6-5
 - troubleshooting, 7-52
 - optional accessories, 1-7
 - order of channels, 2-26
 - ordering new assemblies, 8-11 to 8-17
 - oscilloscope, 1-2
 - accessories supplied with, 1-5 to 1-9
 - configuration preset, 4-48 to 4-50
 - configure with Autoscale, 2-18
 - configuring with Autoscale, 2-19
 - deep memory, 5-3
 - performance characteristics, 9-2
 - preset configuration, 4-48
 - resetting, 7-4
 - starting acquisition, 2-28
 - stopping acquisition, 2-28
 - using, 1-2
 - oscilloscopes
 - accessories supplied with, 1-6
 - BenchLink for Microsoft Windows, 1-7
 - carrying case for, 1-7
 - circuit probing concepts, 4-39 to 4-42
 - connect to test threshold, 7-13
 - controls, 2-6
 - does not display ringing, 4-41
 - functional controls, 2-6
 - making measurements, 4-2
 - messages, 10-2
 - optional accessories, 1-7
 - preparing for use, 1-4
 - process of using, 1-3
 - removing power supply, 8-8
 - removing system board, 8-6
 - removing the cabinet, 8-4
 - removing the display, 8-6
 - removing the fan, 8-4
 - removing the front panel, 8-5
 - removing the handle, 8-9
 - removing the keyboard, 8-9
 - replaceable parts, 8-2
 - setup, 1-4
 - test channel thresholds, 7-14
 - testing and troubleshooting, 7-2
 - view of parts, 8-13, 8-16
 - oversampling technique, 5-10
 - overview
 - advanced trigger, 3-19 to 3-24

 - P**
 - PAL, PAL-M, 6-4, 6-6, 6-11
 - pan the waveform, 2-3, 4-18, 4-28
 - parameters
 - for trigger operator, 3-19 to 3-24
 - parameters for interface, 2-34
 - part numbers
 - cable, 1-5 to 1-9
 - grabbers, 1-5 to 1-9
 - ground lead, 1-5 to 1-9
 - parts
 - for test connectors, 7-9 to 7-10
 - removing and ordering, 8-2
 - parts list for oscilloscopes, 8-14
 - passive probe impedance, 4-39 to 4-42
 - Pattern, 3-17
 - pattern trigger, 3-17
 - adding edge qualifier, 3-17
 - and edge trigger combined, 3-22
 - applications of, 3-13
 - entered, 3-13
 - qualifying with edge, 3-13
 - patterns
 - defining for trigger, 3-21
 - entered, 3-19
 - exited, 3-19
 - satisfying trigger qualifier, 3-19
 - triggering on sequence of, 3-23
 - Peak Det softkey, 5-11
 - peak detect
 - display mode, 2-13, 5-11
 - peak detect mode, 2-13
 - peak detection, 4-11
 - peak-to-peak voltage, 5-33
 - performance characteristics, 9-2
 - acquisition system, 9-6
 - horizontal system, 9-5
 - input channels, 9-3
 - power requirements, 9-9
 - setup functions, 9-9
 - trigger system, 9-7
 - Performance Test Record
 - verify voltage readings, 7-12
 - period measurements, 5-28 to 5-29
 - phase measurement, 5-14 to 5-16
 - pivoting handle, 1-9
 - pixel memory, 4-43
 - poor uses
 - for edge trigger, 3-12
 - for pattern trigger, 3-13
 - Position knob, 2-26
 - position of time reference
 - in acquisition memory, 4-22 to 4-28
 - positioning channels, 2-26
 - pouch, 1-7
 - power requirements
 - performance characteristics, 9-9
 - power supply
 - of circuit under test, 1-11 to 1-12
 - removing, 8-8
 - to adjust, 7-30 to 7-32
 - voltage measurements, 7-31
 - power switch shaft
 - removing, 8-8
 - predefine test configurations, 4-44
 - predefined labels, 4-54 to 4-57
 - preset configuration, 4-48
 - Previous Menu softkey, 5-29
 - print
 - cancel or stop, 2-34
 - message, 10-6
 - waveform display, 2-34
 - probe
 - attach every third ground, 4-42
 - circuit models, 4-40
 - grounding, 4-40
 - grounding concepts, 4-39 to 4-42
 - high-frequency circuit, 4-40
 - inductance, 4-41
 - loading concepts, 4-39 to 4-42
 - low-frequency circuit, 4-39 to 4-42
-

-
- sensing, 2-23
 - tip design, 4-40
 - probe cable, 1-11 to 1-12
 - probe calibrator
 - performance characteristics, 9-9
 - probe leads
 - removing from cable, 1-12
 - probes
 - connect grabbers, 1-11 to 1-12
 - short together, 1-11 to 1-12
 - probing
 - circuit under test
 - practices, 4-42
 - problems
 - obtain HP service, 7-4
 - solving, 7-3
 - trace display, 7-4 to 7-5
 - with channels, 7-5 to 7-6
 - procedures
 - to test threshold accuracy, 7-12
 - to verify correct operation, 7-2
 - pulse
 - measurements, 5-28 to 5-31
 - sync, 6-7
 - pulse parameters
 - See time measurements
- R**
- rackmount kit, 1-7
 - re-ordering channels, 2-26
 - Readout cursor key, 5-22
 - rearming trigger, 4-34
 - recall
 - trace memory, 4-43
 - Recall Setup softkey, 4-46
 - recall waveforms, 4-46 to 4-47
 - recover screen, 4-21
 - removing
 - cabinet, 8-4
 - display, 8-6
 - fan, 8-4
 - front panel, 8-5
 - handle, 8-9
 - keyboard, 8-9
 - power supply, 8-8
 - system board, 8-6
 - removing probe leads, 1-12
 - repetitive waveforms
 - and edge trigger, 3-12
 - replaceable parts, 8-2
 - descriptions and part numbers, 8-14
 - exploded view, 8-13, 8-16
 - list, 8-14
 - list for oscilloscopes, 8-14
 - mail order, 8-12 to 8-17
 - ordering, 8-12 to 8-17
 - reset setup, 4-48 to 4-50
 - resetting the oscilloscope, 7-4
 - resistance of impedance, 4-39 to 4-42
 - resistors
 - for test connectors, 7-9 to 7-10
 - reversing Autoscale, 2-18 to 2-19
 - ribbon cable
 - disconnect to remove display, 8-6
 - disconnect to remove front panel, 8-5
 - disconnect to remove power supply, 8-8
 - disconnect to remove system board, 8-6
 - Right
 - time reference position, 4-22 to 4-28
 - ringing in voltage model, 4-41
 - rise time in voltage model, 4-41
 - rise time measurement, 5-28
 - RiseTime softkey, 5-30
 - Roll display mode, 5-13
 - RS-232 Interface module, 4-43
 - run
 - and Erase, 4-38
 - Run key, 2-28
 - self-tests, 7-11
- S**
- sampling
 - period, 2-13
 - sampling period, 2-14
 - sample rate display, 2-27
 - save
 - configuration, 4-44
 - setups, 4-48
 - waveforms, 4-46 to 4-47
 - Save to softkey, 4-46
 - screen
 - erasing, 4-38
 - recovering, 4-21
 - SECAM, 6-4, 6-6, 6-11
 - select knob, 2-26, 3-17
 - choosing edge trigger channel, 3-16
 - using to select channels, 2-24
 - selecting
 - channels for pattern trigger, 3-17
 - time reference position, 4-22 to 4-28
 - self-calibrations, 7-33 to 7-34
 - self-tests
 - acquisition system, 7-11
 - sequential output patterns
 - triggering on, 3-23
 - setting
 - pattern trigger, 3-17
 - DC offset for threshold test, 7-14
 - function generator, 7-13
 - oscilloscopes, 1-4
 - settings
 - default configuration, 4-48
 - for graticule, 2-33
 - setup
 - factory default, 2-18 to 2-19
 - message, 10-7
 - reset, 4-48 to 4-50
 - setup functions
 - performance characteristics, 9-9
 - setup memory, 4-43 to 4-44
 - setup saving, 4-48
 - shipment, damaged
 - See damaged shipment
 - shorting probes, 1-11 to 1-12
 - Show Meas softkey, 5-27, 5-29
 - signal
 - noise, 5-6, 5-10
 - single, 4-33
 - and auto trigger, 3-4
 - event, 4-34 to 4-35
 - trigger, 4-34
 - single-shot
 - acquisition, 3-4, 4-33
 - bandwidth, 4-35
 - smoothing, 5-10
 - softkey
 - See keys listed by name
 - softkeys
 - Adv, 3-19 to 3-24
 - edge trigger, 3-16
 - Edit Label, 4-46
 - Label, 4-53 to 4-58
 - Logic levels, 4-51 to 4-52
-

-
- On/Off, 2-24
 - Pattern, 3-17
 - software
 - BenchLink for Microsoft Windows, 1-7
 - solutions to problems
 - channels, 7-5 to 7-6
 - trace display, 7-4 to 7-5
 - solving problems
 - See Service section
 - Source softkey, 5-26, 5-29, 5-33
 - sources
 - defining patterns and edges, 3-20
 - for trigger, 3-19 to 3-24
 - specifications
 - performance, 9-2
 - threshold accuracy, 7-12
 - starting an acquisition, 2-28
 - state machine
 - triggering on outputs, 3-23
 - status indicators, 2-13 to 2-14
 - status line, 2-32, 6-2
 - Stop, 2-28
 - Stop key, 4-38
 - stop printing, 2-34
 - stopping an acquisition, 2-28
 - storage, 4-33
 - sub bright, 7-38
 - supplied accessories
 - See accessories, supplied
 - sweep
 - delayed, 2-27, 2-32, 5-4, 6-13
 - main, 2-27, 2-32, 5-4
 - speed, 2-27
 - sweep speed, 2-13 to 2-14
 - and missed trigger, 3-4
 - See also time base
 - switch
 - power, 8-8
 - sync
 - amplitude, 6-5
 - burst color, 6-7
 - pulse vertical, 6-6
 - pulses, 6-7
 - system board
 - removing, 8-6
 - replacing/exchanging, 8-11
- T**
- temperature
 - warm up, 7-29
 - test
 - acquisition system, 7-11
 - configurations (save, recall), 4-44
 - connectors, 7-9 to 7-10
 - design ports, 4-42
 - oscilloscope, 7-2
 - record, 7-28
 - setup for thresholds, 7-13
 - threshold accuracy, 7-12
 - thresholds, 7-14
 - vertical interval signal, 6-5
 - things to check
 - for channel problems, 7-5 to 7-6
 - for trace display problems, 7-4 to 7-5
 - Performance Test Record, 7-12
 - threshold
 - accuracy, 7-12
 - message, 10-8
 - preset configuration, 4-48
 - test settings, 7-14
 - test setup, 7-13
 - voltage setting, 4-51 to 4-52
 - threshold voltage
 - setting, 4-51
 - time base
 - preset configuration, 4-48
 - range, 2-27
 - setting, 2-13 to 2-14
 - setting during Autoscale, 2-20
 - setup, 2-27
 - varying during run, 4-27
 - time interval
 - of auto trigger, 3-3
 - Time key, 5-26
 - time measurements
 - duty cycle, 5-28 to 5-31
 - fall time, 5-28 to 5-31
 - frequency, 5-28 to 5-31
 - period, 5-28 to 5-31
 - rise time, 5-28 to 5-31
 - width, 5-28 to 5-31
 - time reference
 - indicator, 2-13 to 2-14
 - setting position of, 4-22 to 4-28
 - Time/Div, 2-13 to 2-14, 2-32, 5-5
 - and missed trigger, 3-4
 - graticule divisions, 2-33
 - timebase
 - and missed trigger, 3-4
 - trace
 - display problems, 7-4 to 7-5
 - memory, 4-46 to 4-47
 - recall, 4-46 to 4-47
 - softkey, 4-46
 - to save, 4-46 to 4-47
 - Trace Mem softkey, 4-46
 - trace memory, 4-43
 - message, 10-8
 - training board
 - See training kit
 - training kit, 1-7
 - transition time, 4-41
 - trigger
 - action to cause, 3-4
 - advanced, 3-14, 3-19 to 3-24
 - and acquisition, 2-28
 - AND, OR, then operators, 3-19
 - characteristics, 9-11
 - complex waveforms, 3-6
 - defining edges, 3-20
 - defining patterns, 3-21
 - duration operator, 3-19
 - edge, 3-16
 - entered and exited operators, 3-19
 - level, 4-34
 - missed, 3-4
 - on sequential patterns, 3-23
 - operators, 3-19 to 3-24
 - pattern, 3-13, 3-17
 - point, 2-27
 - post-trigger information, 2-28
 - preset configuration, 4-48
 - pretrigger information, 2-28
 - rearming, 4-35
 - setting during Autoscale, 2-20
 - single, 4-34 to 4-35
 - slope, 4-34
 - source, 4-34
 - sources, 3-19 to 3-24
 - to verify, 7-24 to 7-26
 - TV, 5-18, 5-21, 6-12
 - TV mode, 5-18
-

-
- trigger event
 - position in acquisition memory, 4-22 to 4-28
 - trigger mode
 - Auto, 2-13 to 2-14
 - Normal, 2-13 to 2-14
 - trigger not found
 - and auto trigger, 3-3
 - trigger system
 - Option 005 characteristics, 9-11
 - performance characteristics, 9-7
 - troubleshooting
 - oscilloscope, 7-2, 7-17
 - TTL threshold, 4-51 to 4-52
 - turning channels on and off, 2-24
 - TV
 - trigger, 5-18, 5-21, 6-12
 - trigger mode, 5-18
 - trigger-both fields, 5-21
 - vertical sync, 5-21
- U**
- undo Autoscale, 2-18 to 2-19, 4-48, 6-4
 - unexpected trace display, 7-5
 - unhooking power switch shaft, 8-8
 - unique states in waveform and pattern trigger, 3-13
 - user interface
 - overview of, 2-6
 - user-defined threshold, 4-51 to 4-52
 - using
 - Auto trigger mode, 3-22
 - Normal trigger mode, 3-22
 - oscilloscope, 1-2 to 1-3
- V**
- variables in probing, 4-42
 - vectors 2-4, 4-16
 - vernier
 - horizontal, 2-27
 - vertical, 2-21 to 2-22
 - Vernier softkey, 2-22, 2-27
 - Vert Rej, 6-7
 - vertical
 - expand about center screen, 2-23
 - expand about ground, 2-23
 - interval, 6-7 to 6-8
 - interval reject, 6-7
 - interval test signal (VITS), 6-5, 6-12 to 6-13
 - linearity, 7-39
 - reference, 2-23
 - reject, 6-7
 - scaling, 2-21
 - sensitivity, 2-21
 - size, 7-39
 - step size, 2-22
 - sync, 5-21
 - sync interval, 6-8
 - Vertical Sync, 6-10
 - video
 - autoscale, 6-4, 6-12
 - signal, 6-4
 - signal components, 6-8
 - signal envelope, 6-10
 - signal unclamped, 6-12
 - trigger, 5-18, 5-21, 6-12
 - waveforms, 5-18 to 5-21, 6-12 to 6-13
 - VITS, 5-18
 - voltage
 - adjustment, 7-30
 - behavior in probe grounding, 4-41
 - logic threshold, 4-51 to 4-52
 - measurement accuracy, 7-16 to 7-18
 - measurements, 5-32 to 5-34
 - models, 4-41
 - peak-to-peak, 5-33
 - Vavg, 5-33
 - Vbase, 5-34
 - vernier, 2-22
 - Vmax, 5-34
 - Vmin, 5-34
 - Vrms, 5-33
 - Vtop, 5-33 to 5-34
 - volts versus time, 5-14
 - volts versus volts, 5-14
 - Volts/Div knob, 2-21
- W**
- warm up
 - oscilloscope before testing, 7-13
 - test equipment, 7-13
 - waveform
 - complex, 3-6
 - does not show grounding problems, 4-41
 - saving, 4-46 to 4-47
 - width, 5-28 to 5-29
 - waveform display
 - and labels, 4-53 to 4-58
 - erasing, 4-38
 - waveform events
 - and pattern trigger, 3-13
 - apply advanced trigger, 3-22
 - picking known sequence, 3-22
 - questions to find sequence, 3-22
 - setting up display, 3-22
- X**
- XY**
- cursors, 5-14 to 5-17
 - display mode, 5-14 to 5-17
 - measurements, 5-16
 - softkey, 5-14
- Z**
- zoom the waveform, 4-18, 4-28, 5-3

DECLARATION OF CONFORMITY

according to ISO/IEC Guide 22 and EN 45014

Manufacturer's Name: Hewlett-Packard Company

Manufacturer's Address: Colorado Springs Division
1900 Garden of the Gods Road
Colorado Springs, CO 80907 USA

declares, that the product

Product Name: Digitizing Oscilloscope

Model Number(s): HP 54645A/D

Product Option(s): All

conforms to the following Product Specifications:

Safety: IEC 1010-1:1990+A1 / EN 61010-1:1993
UL 3111
CSA-C22.2 No. 1010.1:1993

EMC: CISPR 11:1990 / EN 55011:1991 Group 1 Class A
IEC 555-2:1982 + A1:1985 / EN 60555-2:1987
IEC 555-3:1982 + A1:1990 / EN 60555-3:1987 + A1:1991
IEC 801-2:1991 / EN 50082-1:1992 4 kV CD, 8 kV AD
IEC 801-3:1984 / EN 50082-1:1992 3 V/m, {1kHz 80% AM, 27-1000 MHz}
IEC 801-4:1988 / EN 50082-1:1992 0.5 kV Sig. Lines, 1 kV Power Lines

Supplementary Information:

The product herewith complies with the requirements of the Low Voltage Directive 73/23/EEC and the EMC Directive 89/336/EEC and carries the CE marking accordingly.

This product was tested in a typical configuration with Hewlett-Packard test systems.

Colorado Springs, 05/16/96

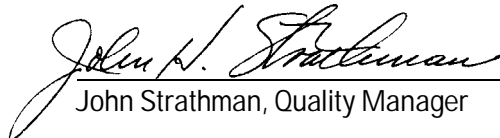
John Strathman, Quality Manager

European Contact: Your local Hewlett-Packard Sales and Service Office or Hewlett-Packard GmbH, Department ZQ / Standards Europe, Herrenberger Strasse 130, D-71034 Böblingen Germany (FAX: +49-7031-14-3143)

Product Regulations

Safety IEC 1010-1:1990+A1 / EN 61010-1:1993
UL 3111
CSA-C22.2 No.1010.1:1993

EMC This Product meets the requirement of the European Communities (EC)
EMC Directive 89/336/EEC.



Emissions EN55011/CISPR 11 (ISM, Group 1, Class A equipment)



Immunity EN50082-1

Code¹ Notes²

IEC 555-2	1
IEC 555-3	1
IEC 801-2 (ESD) 4kV CD, 8kV AD	2
IEC 801-3 (Rad.) 3 V/m	1
IEC 801-4 (EFT) 0.5 kV, 1kV	2

¹ Performance Codes:

- 1 PASS - Normal operation, no effect.
- 2 PASS - Temporary degradation, self recoverable.
- 3 PASS - Temporary degradation, operator intervention required.
- 4 FAIL - Not recoverable, component damage.

² Notes: (none)

Sound Pressure Level Less than 60 dBA

© Copyright Hewlett-Packard Company 1996-1997
All Rights Reserved.

Reproduction, adaptation, or translation without prior written permission is prohibited, except as allowed under the copyright laws.

Microsoft is a registered trademark of Microsoft Corporation.

Document Warranty

The information contained in this document is subject to change without notice.

Hewlett-Packard makes no warranty of any kind with regard to this material, including, but not limited to, the implied warranties of merchantability or fitness for a particular purpose.

Hewlett-Packard shall not be liable for errors contained herein or for damages in connection with the furnishing, performance, or use of this material.

Safety

This apparatus has been designed and tested in accordance with IEC Publication 1010, Safety Requirements for Measuring Apparatus, and has been supplied in a safe condition. This is a Safety Class I instrument (provided with terminal for protective earthing). Before applying power, verify that the correct safety precautions are taken (see the following warnings). In addition, note the external markings on the instrument that are described under "Safety Symbols."

Warning

- Before turning on the instrument, you must connect the protective earth terminal of the instrument to the protective conductor of the (mains) power cord. The mains plug shall only be inserted in a socket outlet provided with a protective earth contact. You must not negate the protective action by using an extension cord (power cable) without a protective conductor (grounding). Grounding one conductor of a two-conductor outlet is not sufficient protection.
- Only fuses with the required rated current, voltage, and specified type (normal blow, time delay, etc.) should be used. Do not use repaired fuses or short-circuited fuseholders. To do so could cause a shock of fire hazard.

- Service instructions are for trained service personnel. To avoid dangerous electric shock, do not perform any service unless qualified to do so. Do not attempt internal service or adjustment unless another person, capable of rendering first aid and resuscitation, is present.

- If you energize this instrument by an auto transformer (for voltage reduction), make sure the common terminal is connected to the earth terminal of the power source.

- Whenever it is likely that the ground protection is impaired, you must make the instrument inoperative and secure it against any unintended operation.

- Do not operate the instrument in the presence of flammable gasses or fumes. Operation of any electrical instrument in such an environment constitutes a definite safety hazard.

- Do not install substitute parts or perform any unauthorized modification to the instrument.

- Capacitors inside the instrument may retain a charge even if the instrument is disconnected from its source of supply.

- Use caution when exposing or handling the CRT. Handling or replacing the CRT shall be done only by qualified maintenance personnel.

Safety Symbols



Instruction manual symbol: the product is marked with this symbol when it is necessary for you to refer to the instruction manual in order to protect against damage to the product.



Hazardous voltage symbol.



Earth terminal symbol: Used to indicate a circuit common connected to grounded chassis.

WARNING

The Warning sign denotes a hazard. It calls attention to a procedure, practice, or the like, which, if not correctly performed or adhered to, could result in personal injury. Do not proceed beyond a Warning sign until the indicated conditions are fully understood and met.

CAUTION

The Caution sign denotes a hazard. It calls attention to an operating procedure, practice, or the like, which, if not correctly performed or adhered to, could result in damage to or destruction of part or all of the product. Do not proceed beyond a Caution symbol until the indicated conditions are fully understood or met.

Product Warranty

This Hewlett-Packard product has a warranty against defects in material and workmanship for a period of three years from date of shipment. During the warranty period, Hewlett-Packard Company will, at its option, either repair or replace products that prove to be defective. For warranty service or repair, this product must be returned to a service facility designated by Hewlett-Packard.

For products returned to Hewlett-Packard for warranty service, the Buyer shall prepay shipping charges to Hewlett-Packard and Hewlett-Packard shall pay shipping charges to return the product to the Buyer. However, the Buyer shall pay all shipping charges, duties, and taxes for products returned to Hewlett-Packard from another country.

Hewlett-Packard warrants that its software and firmware designated by Hewlett-Packard for use with an instrument will execute its programming instructions when properly installed on that instrument. Hewlett-Packard does not warrant that the operation of the instrument software, or firmware will be uninterrupted or error free.

Limitation of Warranty

The foregoing warranty shall not apply to defects resulting from improper or inadequate maintenance by the Buyer, Buyer-supplied software or interfacing, unauthorized modification or misuse, operation outside of the environmental specifications for the product, or improper site preparation or maintenance.

No other warranty is expressed or implied. Hewlett-Packard specifically disclaims the implied warranties of merchantability or fitness for a particular purpose.

Exclusive Remedies

The remedies provided herein are the buyer's sole and exclusive remedies. Hewlett-Packard shall not be liable for any direct, indirect, special, incidental, or consequential damages, whether based on contract, tort, or any other legal theory.

Assistance

Product maintenance agreements and other customer assistance agreements are available for Hewlett-Packard products.

For any assistance, contact your nearest Hewlett-Packard Sales Office.

Certification

Hewlett-Packard Company certifies that this product met its published specifications at the time of shipment from the factory. Hewlett-Packard further certifies that its calibration measurements are traceable to the United States National Institute of Standards and Technology, to the extent allowed by the Institute's calibration facility, and to the calibration facilities of other International Standards Organization members.

About this edition

This is the *HP 54645A/D Oscilloscopes User and Service Guide*.

Publication number
54645-97012, December 1997
Printed in USA.

Print history is as follows:

54645-97012, December 1997
54645-97011, February 1997
54645-97001, June 1996

New editions are complete revisions of the manual. Many product updates do not require manual changes; and, conversely, manual corrections may be done without accompanying product changes. Therefore, do not expect a one-to-one correspondence between product updates and manual updates.