

# **Installation and Verification Manual**

**HP 70000 Series Modular  
Spectrum Analyzer System**

**HP 70900B Local Oscillator  
Source-Controlled Modules**



**HP Part No. 70900-90314  
Printed in USA December 1996**

**Edition A.0.0**

**Notice**

The information contained in this document is subject to change without notice.

Hewlett-Packard makes no warranty of any kind with regard to this material, including, but not limited to, the implied warranties of merchantability and fitness for a particular purpose. Hewlett-Packard shall not be liable for errors contained herein or for incidental or consequential damages in connection with the furnishing, performance, or use of this material.

**Restricted Rights Legend.**

Use, duplication, or disclosure by the U.S. Government is subject to restrictions as set forth in subparagraph (c) (1) (ii) of the Rights in Technical Data and Computer Software clause at DFARS 252.227-7013 for DOD agencies, and subparagraphs (c) (1) and (c) (2) of the Commercial Computer Software Restricted Rights clause at FAR 52.227-19 for other agencies.

©Copyright Hewlett-Packard Company 1990—1994, 1996

All Rights Reserved. Reproduction, adaptation, or translation without prior written permission is prohibited, except as allowed under the copyright laws.  
1400 Fountaingrove Parkway, Santa Rosa, CA 95403-1799, USA

---

## Certification

Hewlett-Packard Company certifies that this product met its published specifications at the time of shipment from the factory. Hewlett-Packard further certifies that its calibration measurements are traceable to the United States National Institute of Standards and Technology, to the extent allowed by the Institute's calibration facility, and to the calibration facilities of other International Standards Organization members.

---

## Warranty

This Hewlett-Packard instrument product is warranted against defects in material and workmanship for a period of one year from date of shipment. During the warranty period, Hewlett-Packard Company will, at its option, either repair or replace products which prove to be defective.

For warranty service or repair, this product must be returned to a service facility designated by Hewlett-Packard. Buyer shall prepay shipping charges to Hewlett-Packard and Hewlett-Packard shall pay shipping charges to return the product to Buyer. However, Buyer shall pay all shipping charges, duties, and taxes for products returned to Hewlett-Packard from another country.

Hewlett-Packard warrants that its software and firmware designated by Hewlett-Packard for use with an instrument will execute its programming instructions when properly installed on that instrument. Hewlett-Packard does not warrant that the operation of the instrument, or software, or firmware will be uninterrupted or error-free.

### LIMITATION OF WARRANTY

The foregoing warranty shall not apply to defects resulting from improper or inadequate maintenance by Buyer, Buyer-supplied software or interfacing, unauthorized modification or misuse, operation outside of the environmental specifications for the product, or improper site preparation or maintenance.

NO OTHER WARRANTY IS EXPRESSED OR IMPLIED. HEWLETT-PACKARD SPECIFICALLY DISCLAIMS THE IMPLIED WARRANTIES OF MERCHANTABILITY AND FITNESS FOR A PARTICULAR PURPOSE.

### EXCLUSIVE REMEDIES

THE REMEDIES PROVIDED HEREIN ARE BUYER'S SOLE AND EXCLUSIVE REMEDIES. HEWLETT-PACKARD SHALL NOT BE LIABLE FOR ANY DIRECT, INDIRECT, SPECIAL, INCIDENTAL, OR CONSEQUENTIAL DAMAGES, WHETHER BASED ON CONTRACT, TORT, OR ANY OTHER LEGAL THEORY.

---

## Assistance

*Product maintenance agreements and other customer assistance agreements are available for Hewlett-Packard products.*

*For any assistance, contact your nearest Hewlett-Packard Sales and Service Office.*

---

## Safety Symbols

The following safety symbols are used throughout this manual. Familiarize yourself with each of the symbols and its meaning before operating this instrument.

---

**CAUTION** The *CAUTION* sign denotes a hazard. It calls attention to a procedure which, if not correctly performed or adhered to, could result in damage to or destruction of the product or the user's work. Do not proceed beyond a *CAUTION* sign until the indicated conditions are fully understood and met.

---

**WARNING** The *WARNING* sign denotes a hazard. It calls attention to a procedure which, if not correctly performed or adhered to, could result in injury to the user. Do not proceed beyond a *WARNING* sign until the indicated conditions are fully understood and met.

---

**DANGER** The *DANGER* sign denotes an imminent hazard to people. It warns the reader of a procedure which, if not correctly performed or adhered to, could result in injury or loss of life. Do not proceed beyond a *DANGER* sign until the indicated conditions are fully understood and met.

---

---

## General Safety Considerations

---

- WARNING**
- The instructions in this document are for use by qualified personnel only. To avoid electrical shock, do not perform any servicing unless you are qualified to do so.
  - The opening of covers or removal of parts is likely to expose dangerous voltages. Disconnect the instrument from all voltage sources while it is being opened.
  - The power cord is connected to internal capacitors that may remain live for five seconds after disconnecting the plug from its power supply.
  - This is a Safety Class 1 Product (provided with a protective earthing ground incorporated in the power cord). The mains plug shall only be inserted in a socket outlet provided with a protective earth contact. Any interruption of the protective conductor inside or outside of the instrument is likely to make the instrument dangerous. Intentional interruption is prohibited.
  - For continued protection against fire hazard, replace fuse only with same type and ratings, (type nA/nV). The use of other fuses or materials is prohibited.
- 

- WARNING**
- Before this instrument is switched on, make sure it has been properly grounded through the protective conductor of the ac power cable to a socket outlet provided with protective earth contact.  
  
Any interruption of the protective (grounding) conductor, inside or outside the instrument, or disconnection of the protective earth terminal can result in personal injury.
  - Before this instrument is switched on, make sure its primary power circuitry has been adapted to the voltage of the ac power source.  
  
Failure to set the ac power input to the correct voltage could cause damage to the instrument when the ac power cable is plugged in.
-



# Contents

---

## 1. General Information

Manual Conventions . . . . .	1-1
Before Operation . . . . .	1-2
Initial Inspection . . . . .	1-3
HP 70900B Local Oscillator Source . . . . .	1-3
HP 70900B Local Oscillator Source Front-Panel Features . . . . .	1-4
HP 70900B Local Oscillator Source Rear-Panel Features . . . . .	1-6
HP 70900B Local Oscillator Source Options . . . . .	1-8
HP 70900B Local Oscillator Source Accessories . . . . .	1-8
Preparing an HP 70000 System for Use . . . . .	1-9
System Operating Requirements . . . . .	1-9
Initial System Power-On . . . . .	1-10
System Calibration Certification . . . . .	1-10
Instrument Keypad for a Spectrum Analyzer . . . . .	1-11
System Rack-Mount and Cabinet Interconnect Installation . . . . .	1-13
Rack-Mounting . . . . .	1-13
Rack-Mounting with Slides . . . . .	1-13
Interconnecting Instrument Cabinets . . . . .	1-15
Line Voltage Selection . . . . .	1-16
400 Hz Option for the Mainframe and Stand-Alone Display . . . . .	1-17
System Line Fuse Replacement . . . . .	1-18
Optional Mainframe Rear-Fan Filter . . . . .	1-19
System Power Cables . . . . .	1-19
Display Screen Cleaning . . . . .	1-21
External Power Pack for the HP 70310A Precision Frequency Reference . . . . .	1-21
Preparing a Static-Safe Work Station . . . . .	1-22
If You Need to Contact Hewlett-Packard . . . . .	1-24
Returning Your Instrument to Hewlett-Packard . . . . .	1-26

## 2. Installation

HP-MSIB/HP-IB Addressing . . . . .	2-1
Modular Measurement System Terms . . . . .	2-2
Functional Terms . . . . .	2-2
Structural Terms . . . . .	2-2
Address Map Protocol . . . . .	2-3
Address Matrix . . . . .	2-3
Display-Response Area . . . . .	2-4
HP-IB Access . . . . .	2-4
Addressing Elements . . . . .	2-4
Master Elements . . . . .	2-4
Sub-Master Elements . . . . .	2-5
Slave Elements . . . . .	2-5
Slave Area Boundaries . . . . .	2-6
Independent Elements . . . . .	2-6
Addressing Order Requirements for HP 70000 Systems . . . . .	2-7
Default Addressing for Configured HP 70000 Systems . . . . .	2-7

Addressing Criteria . . . . .	2-8
Row Addressing Priority . . . . .	2-10
Address Switches . . . . .	2-10
Master Address Switches . . . . .	2-11
Slave Address Switches . . . . .	2-12
Display Address Switches . . . . .	2-13
Module Removal and Installation . . . . .	2-15
Module Removal . . . . .	2-15
Installation . . . . .	2-15
Connecting the MSIB Cables on a “A” and “C” System . . . . .	2-16
Connecting the MSIB Y-Cable on a “P” System . . . . .	2-17
System Configurations for “A” and “C” Systems . . . . .	2-18
HP 71100C Modular Spectrum Analyzer . . . . .	2-20
HP 71100C Modular Spectrum Analyzer with HP 70903A IF Section . . . . .	2-22
HP 71100C Modular Spectrum Analyzer with HP 70700A Digitizer . . . . .	2-24
HP 71100C Modular Spectrum Analyzer with HP 70903A IF Section and HP 70700A Digitizer . . . . .	2-26
HP 71100C Modular Spectrum Analyzer with HP 70300A RF Tracking Generator . . . . .	2-28
HP 71200C Modular Spectrum Analyzer . . . . .	2-30
HP 71200C Modular Spectrum Analyzer with HP 70903A IF Section . . . . .	2-32
HP 71200C Modular Spectrum Analyzer Deleting HP 70902A IF Section, with HP 70903A IF Section and HP 70907B External Millimeter Interface Module . . . . .	2-34
HP 71200C Modular Spectrum Analyzer Deleting HP 70905A RF Section, with HP 70905B RF Section/HP 70600A Preselector . . . . .	2-36
HP 71200C Modular Spectrum Analyzer Deleting HP 70905A RF Section, with HP 70905B RF Section/HP 70600A Preselector/HP 70301A Microwave Tracking Generator . . . . .	2-38
HP 71209A Microwave Spectrum Analyzer . . . . .	2-40
HP 71210C Microwave Spectrum Analyzer . . . . .	2-42
HP 71400C Lightwave Signal Analyzer . . . . .	2-44
HP 71400C Lightwave Signal Analyzer with HP 70300A RF Tracking Generator and HP 70301A Microwave Tracking Generator . . . . .	2-46
HP 71401C Lightwave Signal Analyzer . . . . .	2-49
HP 71401C Lightwave Signal Analyzer with an HP 70300A RF Tracking Generator . . . . .	2-51
System Configurations for “P” Systems . . . . .	2-53
General Guidelines for Module Placement . . . . .	2-53
HP 71100P Modular Spectrum Analyzer . . . . .	2-56
HP 71100P Modular Spectrum Analyzer with HP 70903A IF Section . . . . .	2-58
HP 71100P Modular Spectrum Analyzer with HP 70700A Digitizer . . . . .	2-60
HP 71100P Modular Spectrum Analyzer with HP 70903A IF Section and HP 70700A Digitizer . . . . .	2-62
HP 71100P Modular Spectrum Analyzer with HP 70300A RF Tracking Generator . . . . .	2-64
HP 71200P Modular Spectrum Analyzer . . . . .	2-66
HP 71200P Modular Spectrum Analyzer with HP 70903A IF Section . . . . .	2-68
HP 71200P Modular Spectrum Analyzer Deleting HP 70902A IF Section, with HP 70903A IF Section and HP 70907B External Millimeter Interface Module . . . . .	2-70
HP 71200P Modular Spectrum Analyzer Deleting HP 70905A RF Section, with HP 70905B RF Section/HP 70600A Preselector . . . . .	2-72
HP 71200P Modular Spectrum Analyzer Deleting HP 70905A RF Section, with HP 70905B RF Section/HP 70600A Preselector/HP 70301A Microwave Tracking Generator . . . . .	2-74
HP 71209P Microwave Spectrum Analyzer . . . . .	2-77
HP 71210P Microwave Spectrum Analyzer . . . . .	2-79



HP 71210P Microwave Spectrum Analyzer with HP 70907B external millimeter interface module Added . . . . .	2-81
System Replaceable Parts . . . . .	2-83
Ordering Information . . . . .	2-83
Direct Mail-Order System . . . . .	2-83

### 3. Specifications and Characteristics

System Specifications . . . . .	3-1
System Components . . . . .	3-2
HP 71100C Modular Spectrum Analyzer Specifications and Characteristics . . . . .	3-3
HP 71200C Modular Spectrum Analyzer Specifications and Characteristics [Including Option 001] . . . . .	3-10
HP 71209A Microwave Spectrum Analyzer Specifications and Characteristics . . . . .	3-18
HP 71209A Microwave Spectrum Analyzer Specifications and Characteristics with External Mixers . . . . .	3-26
HP 71210C Microwave Spectrum Analyzer Specifications and Characteristics . . . . .	3-31
System Specification Changes with HP 70620B Preamplifier/HP 70621A Preamplifier . . . . .	3-40
System Specification and Characteristic Changes with HP 70903A IF Section . . . . .	3-48
System Specification and Characteristic Changes with HP 70907A External Millimeter Interface Module (EMIM) . . . . .	3-50
System Specification and Characteristic Changes with HP 70907B External Millimeter Interface Module (EMIM) . . . . .	3-55
System Specification and Characteristic Changes with HP 70905B RF Section/HP 70600A Preselector or HP 70906B RF Section/HP 70601A Preselector . . . . .	3-62
HP 71400C Lightwave Signal Analyzer Specifications and Characteristics . . . . .	3-67
HP 71400C Option 850 Lightwave Signal Analyzer Specifications and Characteristics . . . . .	3-71
HP 71401C Lightwave Signal Analyzer Specifications and Characteristics . . . . .	3-75
HP 71401C Option 850 Lightwave Signal Analyzer Specifications and Characteristics . . . . .	3-79
Physical Dimensions of the HP 70004A Color Display and HP 70001A Mainframe Module Input and Output Characteristics . . . . .	3-83
HP 70310A Precision Frequency Reference . . . . .	3-85
HP 70600A Preselector/HP 70601A Preselector . . . . .	3-87
HP 70810B Lightwave Section and HP 70810B Option 850 Lightwave Section . . . . .	3-88
HP 70900B Local Oscillator Source . . . . .	3-89
HP 70902A IF Section . . . . .	3-90
HP 70903A IF Section . . . . .	3-91
HP 70904A RF Section . . . . .	3-92
HP 70905A RF Section . . . . .	3-93
HP 70906A RF Section . . . . .	3-95
HP 70905B RF Section and HP 70906B RF Section . . . . .	3-97
HP 70907A External Millimeter Interface Module . . . . .	3-98
HP 70907B External Millimeter Interface Module . . . . .	3-99
HP 70908A RF Section . . . . .	3-100
HP 70909A RF Section and HP 70910A RF Section . . . . .	3-102

<b>4. System Operation Verification</b>	
Shipment Contents . . . . .	4-1
Software Version . . . . .	4-2
Software/Hardware Compatibility . . . . .	4-2
Computer Hardware Compatibility . . . . .	4-2
Computer Language Compatibility . . . . .	4-2
Printer Compatibility . . . . .	4-3
Typographic Conventions . . . . .	4-4
Required Test Equipment . . . . .	4-5
Operation Verification Test Software Overview . . . . .	4-6
Testing Multiple Systems . . . . .	4-6
Types of Error Messages or Warnings Defined . . . . .	4-7
Limited Cal Defined . . . . .	4-7
Single Tests Defined . . . . .	4-7
Test Results . . . . .	4-7
Printing Test Results . . . . .	4-7
Start-Up Procedures . . . . .	4-8
Configuring the Hardware . . . . .	4-8
Installing Operation Verification Software . . . . .	4-9
Menus . . . . .	4-11
Menu Structure . . . . .	4-11
Common Edit and Command Screen Menu Keys . . . . .	4-11
Edit Screen Menu keys . . . . .	4-11
Command Screen Menu Keys . . . . .	4-11
Main Menu . . . . .	4-13
Mass Storage Menu . . . . .	4-14
Mass Storage Menu Volume Labels . . . . .	4-14
Editing Mass Storage Menu Information . . . . .	4-14
Parameter Menu . . . . .	4-15
Equipment Menu . . . . .	4-17
Equipment Menu Edit Screen . . . . .	4-17
Equipment Menu Command Screen . . . . .	4-18
Editing Calibration Data . . . . .	4-18
HP-MSIB Address Menu . . . . .	4-19
Test Menu . . . . .	4-20
Test Descriptions . . . . .	4-27
Test Description List . . . . .	4-28
Calibrator Frequency Accuracy (for HP 70900A/B Local Oscillator Source) . . . . .	4-29
Calibrator Amplitude Accuracy (for HP 70900A/B Local Oscillator Source) . . . . .	4-30
Frequency Response (for HP 70904A RF Section) . . . . .	4-31
Frequency Response (for HP 70905A RF Section, HP 70906A RF Section) . . . . .	4-32
Frequency Response (for HP 70600A Preselector/HP 70601A Preselector, HP 70905B RF Section/HP 70906B RF Section) . . . . .	4-33
Frequency Response (for HP 70908A RF Section) . . . . .	4-35
Frequency Response (for HP 70908A RF Section and HP 70620B Preamplifier) . . . . .	4-36
Frequency Response (for HP 70909A or HP 70910A RF Section ) . . . . .	4-38
Frequency Response (for HP 70600A Preselector/HP 70601A Preselector, HP 70905A/B RF Section or HP 70906A/B RF Section, and HP 70620B Preamplifier) . . . . .	4-40
Frequency Response (for HP 70904A RF Section and HP 70621A Preamplifier) . . . . .	4-42
GSM System Calibration (for HP 71150C GSM Transmitter Tester or HP 71250C GSM Transmitter Tester) . . . . .	4-44
Frequency Span Accuracy . . . . .	4-45
Displayed Average Noise (using HP 70902A IF Section or HP 70903A IF Section) . . . . .	4-46
GSM System Displayed Average Noise Level (using HP 70902A IF Section) . . . . .	4-47

Log Fidelity (for HP 70902A IF Section or HP 70903A IF Section) . . . . .	4-48
Resolution Bandwidth Tests (for HP 70902A IF Section or HP 70903A IF Section)	4-49
Calibrator Amplitude Accuracy (using HP 70907A External Millimeter Interface Module) . . . . .	4-50
Calibrator Amplitude Accuracy (using HP 70907B External Millimeter Interface Module) . . . . .	4-51
LO Output Amplitude (from HP 70907A/B External Millimeter Interface Module)	4-52
Log Fidelity — Using HP 70907A/B External Millimeter Interface Module (for HP 70902A IF Section and HP 70903A IF Section) . . . . .	4-53
Resolution Bandwidth — Using HP 70907A External Millimeter Interface Module (for HP 70902A IF Section or HP 70903A IF Section) . . . . .	4-54
Resolution Bandwidth — Using HP 70907B External Millimeter Interface Module (HP 70902A IF Section or HP 70903A IF Section) . . . . .	4-56
Test Limit Changes . . . . .	4-58
Error and Status Messages . . . . .	4-59

**5. Error Messages**

User Application Errors 0001 - 0999 . . . . .	5-2
Operating Errors 2000 - 2999 . . . . .	5-13
Hardware Warning Errors 6000 - 6999 . . . . .	5-22
Hardware Broken Errors 7000 - 7999 . . . . .	5-25
Computation Errors 8000 - 8999 . . . . .	5-35
Factory-Use Only Errors 9000 - 9999 . . . . .	5-36

**Index**

# Figures

---

1-1. HP 70900B Local Oscillator Source Front-Panel Features . . . . .	1-5
1-2. HP 70900B Local Oscillator Source Rear-Panel Features . . . . .	1-7
1-3. Spectrum Analyzer Instrument Keypad . . . . .	1-12
1-4. Front Handle Removal and Rack Mounting . . . . .	1-14
1-5. Interconnecting System II Cabinets . . . . .	1-15
1-6. Line Voltage Selector . . . . .	1-16
1-7. Line Fuse Removal and Replacement . . . . .	1-18
1-8. Rear-Fan Filter Installation . . . . .	1-19
1-9. AC Power Cords . . . . .	1-20
1-10. External Power Pack . . . . .	1-21
1-11. Static-Safe Work Station . . . . .	1-22
1-12. Typical Serial Number Label . . . . .	1-24
2-1. Address Matrix . . . . .	2-3
2-2. Master/Slave Address Matrix . . . . .	2-5
2-3. Sub-Master Address Matrix . . . . .	2-5
2-4. HP 70900B Local Oscillator Source Address Switch . . . . .	2-12
2-5. Slave Element Address Switches . . . . .	2-12
2-6. HP 70206A System Graphics Display Address Switches . . . . .	2-13
2-7. HP 70004A Color Display Address Switches . . . . .	2-14
2-8. Module Removal/Replacement . . . . .	2-15
2-9. HP 70001A Mainframe to HP 70004A Color Display Cabling . . . . .	2-16
2-10. Address Map for HP 71100C Modular Spectrum Analyzer . . . . .	2-20
2-11. HP 71100C Modular Spectrum Analyzer Rear Panel Cabling . . . . .	2-21
2-12. Address Map for HP 71100C Modular Spectrum Analyzer with HP 70903A IF Section . . . . .	2-22
2-13. HP 71100C Modular Spectrum Analyzer Rear Panel Cabling with HP 70903A IF Section . . . . .	2-23
2-14. Address Map for HP 71100C Modular Spectrum Analyzer with HP 70700A Digitizer . . . . .	2-24
2-15. HP 71100C Modular Spectrum Analyzer Rear Panel Cabling with HP 70700A Digitizer . . . . .	2-25
2-16. Address Map for HP 71100C Modular Spectrum Analyzer with HP 70903A IF Section and HP 70700A Digitizer . . . . .	2-26
2-17. HP 71100C Modular Spectrum Analyzer Rear Panel Cabling with HP 70903A IF Section and HP 70700A Digitizer . . . . .	2-27
2-18. Address Map for HP 71100C Modular Spectrum Analyzer with HP 70300A RF Tracking Generator . . . . .	2-28
2-19. HP 71100C Modular Spectrum Analyzer Rear Panel Cabling with an HP 70300A RF Tracking Generator . . . . .	2-29
2-20. Address Map for HP 71200C Modular Spectrum Analyzer . . . . .	2-30
2-21. HP 71200C Modular Spectrum Analyzer Rear Panel Cabling . . . . .	2-31
2-22. Address Map for HP 71200C Modular Spectrum Analyzer with HP 70903A IF Section . . . . .	2-32
2-23. HP 71200C Modular Spectrum Analyzer Rear Panel Cabling with HP 70903A IF Section . . . . .	2-33

2-24. Address Map for HP 71200C Modular Spectrum Analyzer Deleting HP 70902A IF Section, with HP 70903A IF Section and HP 70907B External Millimeter Interface Module . . . . .	2-34
2-25. HP 71200C Modular Spectrum Analyzer Deleting HP 70902A IF Section, with HP 70903A IF Section and HP 70907B External Millimeter Interface Module Cabling . . . . .	2-35
2-26. Address Map for HP 71200C Modular Spectrum Analyzer Deleting HP 70905A RF Section, with HP 70905B RF Section/HP 70600A Preselector . . . . .	2-36
2-27. HP 71200C Modular Spectrum Analyzer Deleting HP 70905A RF Section, with HP 70905B RF Section/HP 70600A Preselector Cabling . . . . .	2-37
2-28. Address Map for HP 71200C Modular Spectrum Analyzer Deleting HP 70905A RF Section, with HP 70905B RF Section/HP 70600A Preselector/HP 70301A Microwave Tracking Generator . . . . .	2-38
2-29. HP 71200C Modular Spectrum Analyzer Deleting HP 70905A RF Section, with HP 70905B RF Section/HP 70600A Preselector/HP 70301A Microwave Tracking Generator Cabling . . . . .	2-39
2-30. Address Map for HP 71209A Microwave Spectrum Analyzer . . . . .	2-40
2-31. HP 71209A Microwave Spectrum Analyzer Rear Panel Cabling . . . . .	2-41
2-32. Address Map for HP 71210C Microwave Spectrum Analyzer . . . . .	2-42
2-33. HP 71210C Microwave Spectrum Analyzer Rear Panel Cabling . . . . .	2-43
2-34. Address Map for HP 71400C Lightwave Signal Analyzer . . . . .	2-44
2-35. HP 71400C Lightwave Signal Analyzer Rear Panel Cabling . . . . .	2-45
2-36. Address Map for HP 71400C Lightwave Signal Analyzer with HP 70300A RF Tracking Generator and HP 70301A Microwave Tracking Generator . . . . .	2-46
2-37. HP 71400C Lightwave Signal Analyzer with HP 70300A RF Tracking Generator and HP 70301A Microwave Tracking Generator Rear Panel Cabling . . . . .	2-48
2-38. Address Map for HP 71401C Lightwave Signal Analyzer . . . . .	2-49
2-39. HP 71401C Lightwave Signal Analyzer Rear-Panel Cabling . . . . .	2-50
2-40. Address Map for HP 71401C Lightwave Signal Analyzer with an HP 70300A RF Tracking Generator . . . . .	2-51
2-41. HP 71401C Lightwave Signal Analyzer Rear-Panel Cabling with an HP 70300A RF Tracking Generator . . . . .	2-52
2-42. Address Map for HP 71100P Modular Spectrum Analyzer . . . . .	2-56
2-43. HP 71100P Modular Spectrum Analyzer Rear Panel Cabling . . . . .	2-57
2-44. Address Map for HP 71100P Modular Spectrum Analyzer with HP 70903A IF Section . . . . .	2-58
2-45. HP 71100P Modular Spectrum Analyzer Rear Panel Cabling with HP 70903A IF Section . . . . .	2-59
2-46. Address Map for HP 71100P Modular Spectrum Analyzer with HP 70700A Digitizer . . . . .	2-60
2-47. HP 71100P Modular Spectrum Analyzer Rear Panel Cabling with HP 70700A Digitizer . . . . .	2-61
2-48. Address Map for HP 71100P Modular Spectrum Analyzer with HP 70903A IF Section and HP 70700A Digitizer . . . . .	2-62
2-49. HP 71100P Modular Spectrum Analyzer Rear Panel Cabling with HP 70903A IF Section and HP 70700A Digitizer . . . . .	2-63
2-50. Address Map for HP 71100P Modular Spectrum Analyzer with HP 70300A RF Tracking Generator . . . . .	2-64
2-51. HP 71100P Modular Spectrum Analyzer Rear Panel Cabling with an HP 70300A RF Tracking Generator . . . . .	2-65
2-52. Address Map for HP 71200P Modular Spectrum Analyzer . . . . .	2-66
2-53. HP 71200P Modular Spectrum Analyzer Rear Panel Cabling . . . . .	2-67
2-54. Address Map for HP 71200P Modular Spectrum Analyzer with HP 70903A IF Section . . . . .	2-68

2-55. HP 71200P Modular Spectrum Analyzer Rear Panel Cabling with HP 70903A IF Section . . . . .	2-69
2-56. Address Map for HP 71200P Modular Spectrum Analyzer Deleting HP 70902A IF Section, with HP 70903A IF Section and HP 70907B External Millimeter Interface Module . . . . .	2-70
2-57. HP 71200P Modular Spectrum Analyzer Deleting HP 70902A IF Section, with HP 70903A IF Section and HP 70907B External Millimeter Interface Module Cabling . . . . .	2-71
2-58. Address Map for HP 71200P Modular Spectrum Analyzer Deleting HP 70905A RF Section, with HP 70905B RF Section/HP 70600A Preselector . . . . .	2-72
2-59. HP 71200P Modular Spectrum Analyzer Deleting HP 70905A RF Section, with HP 70905B RF Section/HP 70600A Preselector Cabling . . . . .	2-73
2-60. Address Map for HP 71200P Modular Spectrum Analyzer Deleting HP 70905A RF Section, with HP 70905B RF Section/HP 70600A Preselector/HP 70301A Microwave Tracking Generator . . . . .	2-74
2-61. HP 71200P Modular Spectrum Analyzer Deleting HP 70905A RF Section, with HP 70905B RF Section/HP 70600A Preselector/HP 70301A Microwave Tracking Generator Cabling . . . . .	2-76
2-62. Address Map for HP 71209P Microwave Spectrum Analyzer . . . . .	2-77
2-63. HP 71209P Microwave Spectrum Analyzer Rear Panel Cabling . . . . .	2-78
2-64. Address Map for HP 71210P Microwave Spectrum Analyzer . . . . .	2-79
2-65. HP 71210P Microwave Spectrum Analyzer Rear Panel Cabling . . . . .	2-80
2-66. Address Map for HP 71210P Microwave Spectrum Analyzer with HP 70907B external millimeter interface module Added . . . . .	2-81
2-67. HP 71210P Microwave Spectrum Analyzer with HP 70907B External Millimeter Interface Module Rear Panel Cabling . . . . .	2-82
3-1. HP 70004A Color Display Physical Dimensions . . . . .	3-83
3-2. HP 70001A Mainframe Physical Dimensions . . . . .	3-83
4-1. Main Menu keys . . . . .	4-23
4-2. Mass Storage Menu and Parameter Menu Keys . . . . .	4-24
4-3. Equipment Menu and HP-MSIB Map Screen Menu Keys . . . . .	4-25
4-4. Test Menu Keys . . . . .	4-26
4-5. Frequency Response Test Setup . . . . .	4-38

# Tables

---

1-1. HP 70900B Local Oscillator Source Front-Panel Feature Descriptions . . . . .	1-4
1-2. HP 70900B Local Oscillator Source Rear-Panel Feature Descriptions . . . . .	1-6
1-3. Accessories Shipped When Module is Ordered Separately . . . . .	1-8
1-4. Instrument Keypad Function Keys . . . . .	1-11
1-5. Interconnect Hardware . . . . .	1-15
1-6. Static-Safe ESD Accessories . . . . .	1-23
1-7. Hewlett-Packard Sales and Service Offices . . . . .	1-25
1-8. Packaging for a 1/8 Module (Instrument) . . . . .	1-27
1-9. Packaging for a 2/8 Module (Instrument) . . . . .	1-28
1-10. Packaging for a 3/8 Module (Instrument) . . . . .	1-29
1-11. Packaging for an 8/8 Module (Instrument) . . . . .	1-30
2-1. Decimal Equivalent of Binary Address . . . . .	2-3
2-2. Default Address Map . . . . .	2-7
2-3. System Replacement Parts Listing . . . . .	2-84
3-1. Model Numbers, Modules, and System Options . . . . .	3-2
3-2. HP 71100C Modular Spectrum Analyzer Specifications and Characteristics . . . . .	3-3
3-3. HP 71200C Modular Spectrum Analyzer Specifications and Characteristics . . . . .	3-10
3-4. HP 71209A Microwave Spectrum Analyzer Specifications and Characteristics . . . . .	3-18
3-4. HP 71209A Specifications and Characteristics (continued) . . . . .	3-19
3-4. HP 71209A Specifications and Characteristics (continued) . . . . .	3-20
3-4. HP 71209A Specifications and Characteristics (continued) . . . . .	3-21
3-4. HP 71209A Specifications and Characteristics (continued) . . . . .	3-22
3-4. HP 71209A Specifications and Characteristics (continued) . . . . .	3-23
3-4. HP 71209A Specifications and Characteristics (continued) . . . . .	3-24
3-5. HP 71209A Specifications and Characteristics (continued) . . . . .	3-25
3-6. HP 71209A Microwave Spectrum Analyzer Specifications and Characteristics When Used with HP 11970 and HP 11974 External Mixers . . . . .	3-26
3-7. HP 71210C Microwave Spectrum Analyzer Specifications and Characteristics . . . . .	3-31
3-8. Specifications Affected When an HP 70620B Preamplifier Is Added . . . . .	3-40
3-8. Specifications Affected When an HP 70620B Preamplifier Is Added (continued) . . . . .	3-42
3-8. Specifications Affected When an HP 70620B Preamplifier Is Added (continued) . . . . .	3-43
3-9. Specifications Affected When an HP 70620B Option 001 Preamplifier Is Added . . . . .	3-44
3-9. Specifications Affected When an HP 70620B Option 001 Preamplifier Is Added (continued) . . . . .	3-45
3-9. Specifications Affected When an HP 70620B Option 001 Preamplifier Is Added (continued) . . . . .	3-46
3-10. Specifications Affected When an HP 70621A Preamplifier Is Added . . . . .	3-47
3-11. System Specifications and Characteristics Affected by an HP 70903A IF Section . . . . .	3-48
3-12. System Specifications Affected When RF Section is Replaced by HP 70907A External Millimeter Interface Module . . . . .	3-50
3-13. System Specifications Affected When One HP 70907A EMIM Is Added . . . . .	3-54
3-14. System Specification Changes for Each Additional HP 70907A EMIM Added . . . . .	3-54
3-15. System Specifications Affected When an RF Section Is Replaced by HP 70907B external millimeter interface module . . . . .	3-56
3-16. System Specifications Affected When One HP 70907B EMIM Is added . . . . .	3-61
3-17. System Specification Changes for Each Additional HP 70907B EMIM . . . . .	3-61

3-18. HP 70905B RF Section/HP 70600A Preselector or HP 70906B RF Section/ HP 70601A Preselector Specifications and Characteristics . . . . .	3-63
3-19. HP 71400C Lightwave Signal Analyzer Specifications and Characteristics . . . . .	3-68
3-20. HP 71400C Option 850 Lightwave Signal Analyzer Specifications and Characteristics . . . . .	3-72
3-21. HP 71401C Lightwave Signal Analyzer Specifications and Characteristics . . . . .	3-76
3-22. HP 71401C Option 850 Lightwave Signal Analyzer Specifications and Characteristics . . . . .	3-80
4-1. External Test Equipment . . . . .	4-5
4-2. Required Accessories . . . . .	4-6
4-3. Operation Verification Tests . . . . .	4-28



## General Information

---

The *HP 70000 Modular Spectrum Analyzer Installation and Verification Manual* contains information specific to the HP 70900B local oscillator source as well as information needed to prepare an HP 70000 Series modular spectrum analyzer system for use.

This manual contains the following five chapters:

- Chapter 1 contains module-specific information about the HP 70900B local oscillator source, compatibility information, and information needed to prepare an HP 70000 Series modular spectrum analyzer system for use. This chapter also contains general information, such as system rack-mounting, line-voltage selector location, electrostatic discharge precautions, packaging requirements, and Hewlett-Packard sales and service offices locations.
- Chapter 2 provides information about module addressing and installation, as well as addressing and cable connection examples for various configurations of HP 70000 Series modular spectrum analyzer systems.
- Chapter 3 lists system specifications and characteristics, as well as module input and output characteristics for modules in HP 70000 Series modular spectrum analyzer systems.
- Chapter 4 contains tests required to verify system operation.
- Chapter 5 identifies the error messages that are displayed when the system encounters an error. The cause of the error message and a solution to the problem is included where practical.

---

## Manual Conventions

The following descriptions are used throughout this manual:

Keys physically on an instrument are represented in the following way:

Key ..... **KEY**

Softkeys, keys defined by software or firmware, are represented in the following way:

Softkey ..... **softkey**

Text that appears on the display screen is represented in the following way:

Screen text ..... **screen text**

---

## Before Operation

Before operating this module, familiarize yourself with any safety markings on the module and read the following cautions and warnings. This module has been manufactured and tested according to international safety standards.

Cautions and warnings must be followed to ensure the safe operation of the module and protection of personnel. Refer to the summary of safety considerations at the front of this manual and below before using the instrument.

- 
- DANGER**
- **Before turning the system on, make sure it is grounded through the protective conductor of the power cable to a socket outlet with protective earth contact. Any interruption of the protective (grounding) conductor inside or outside the instrument, or disconnection of the protective earth terminal, can result in personal injury.**
  - **Before turning the system on, be sure the line voltage selector is set to the correct voltage for the power source. Failure to do this may cause damage (a blown fuse) to the system when the power cable is plugged in.**
  - **Do not operate a 400 Hz Option instrument on a 400 Hz power line without the attached in-line isolation transformer. Failure to follow this precaution can result in personal injury.**
- 

- Note**
- Do not use hand or laboratory paper towels to clean the display screen. These abrasive materials may scratch the screen coating. (Refer to “Display Screen Cleaning”.)
  - Do not place labels on the back side of the front panel door. Damage may result to labels due to opening and closing the front panel door. Labels should be attached to the frame inside the door.
-

---

## Initial Inspection

Inspect the shipping containers for damage. If a shipping container or cushioning material is damaged, it should be kept until the contents of the shipment have been checked for completeness and the module has been checked mechanically and electrically. To determine what accessories should have been shipped with the module, refer to “HP 70900B Local Oscillator Source Accessories”. Run the operation verification tests to check electrical performance. (Refer to Chapter 4.)

If the shipping contents are incomplete, or the module does not satisfy the verification procedures, notify the nearest Hewlett-Packard Sales and Service Office. Hewlett-Packard will arrange for repair or replacement of the equipment without waiting for a claim settlement. Retain the shipping materials for the carrier to inspect.

Undamaged shipping materials should be kept. Original Hewlett-Packard shipping materials, or equivalent, are required for system or module reshipment. Substandard packaging may damage the instrument. For more information, refer to “If You Need to Contact Hewlett-Packard”.

---

## HP 70900B Local Oscillator Source

The HP 70900B local oscillator source (LO) is a 1/4-width module that fulfills three functions: local oscillator, controller, and video processor.

- The local oscillator circuitry supplies a swept signal that has a frequency range of 3.0 to 6.6 GHz. This signal is used by various modules and devices, including front-ends (RF sections), tracking generators, and the external mixer interface module. For spans that are less than or equal to 10 MHz, the sweep is fully synthesized using fractional-N techniques; for spans that are greater than or equal to 10 MHz, lock-and-roll tuning is used.
- The controller circuitry contains the system firmware. This firmware controls and coordinates measurements between other system modules which are slave modules to the LO module. Examples of slave modules are the RF sections, IF sections, and tracking generator modules.
- The video processor circuitry digitizes the video signal received from the IF section and processes this signal using normal (rosenfell), positive peak, negative peak, or sample detection.

If the HP 70900B local oscillator source was ordered separately, not as part of a preconfigured system, refer to Chapter 2 for addressing and installation information and examples of rear panel cable connections. Refer to the *HP 70004A Color Display User's Guide* for instructions on installing the spectrum analyzer instrument keypad into the HP 70004A color display. Then, refer to “Preparing an HP 70000 System for Use”.

## HP 70900B Local Oscillator Source Front-Panel Features

**Note** It is normal for the ERR and ACT LEDs to flash on, then off, during the module self-test. Self-test occurs each time the instrument is turned on.

The numbers in the “Item” column of Table 1-1 refer to the callouts in Figure 1-1.

**Table 1-1.**  
**HP 70900B Local Oscillator Source Front-Panel Feature Descriptions**

Item	Description
1	The RMT LED lights if the analyzer is addressed by a computer. In addition, depending on the instructions received from the computer, the LSN, TLK, or SRQ indicators will also light.
2	The LSN LED lights when the analyzer is receiving data or instructions over HP-IB.
3	The TLK LED lights when the analyzer is sending data or instructions over HP-IB.
4	The SRQ LED lights when the analyzer has requested computer service.
5	The ACT LED lights when a module is making a measurement and its master has keyboard control of the display. The ACT LED of a module is only operative when there is a display in the system and when the instrument is performing a measurement.
6	The ERR LED lights when there is a problem (error) related to one or more modules in the system. To learn the nature of the error and its source, press <b>(DISPLAY)</b> , <b>(REPORT ERRORS)</b> . The screen displays the error code and identifies the module where the error originated.
7	The MEASURE LED lights as the analyzer sweeps each band and blanks during retrace and between frequency bands.
8	The SELF TEST LED lights whenever the analyzer is testing itself.
9	The YTO Loop Unlock LED lights when a YTO hardware failure occurs.
10	IDL Loop Unlock LED lights when an idler hardware failure occurs.
11	FFS Loop Unlock LED lights when a fractional-N hardware failure occurs.
12	The 300 MHz CALIBRATOR Output provides a –10 dBm signal for the use as a reference during spectrum analyzer calibration. Using this signal and internal calibration routines the analyzer can correct for frequency errors in the resolution bandwidth circuits and amplitude errors throughout the signal path.
13	The module hex-nut latch secures the module in an HP 70000 Series mainframe. When the module is being installed or removed from a mainframe, an 8 mm hex-ball driver is used to turn the module latch. For information on module installation, refer to Chapter 2.

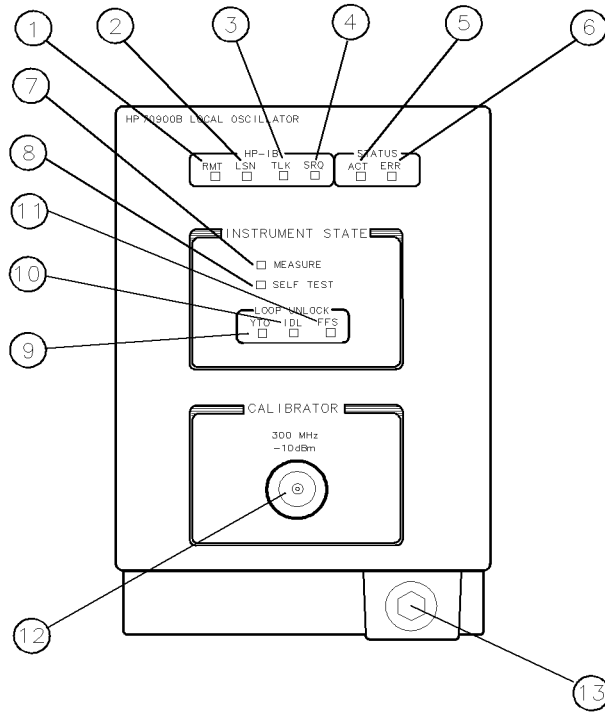

DUA43

**Figure 1-1. HP 70900B Local Oscillator Source Front-Panel Features**

## HP 70900B Local Oscillator Source Rear-Panel Features

The numbers in the “Item” column of Table 1-2 refer to callouts in Figure 1-2.

**Table 1-2.**  
**HP 70900B Local Oscillator Source Rear-Panel Feature Descriptions**

<b>Item</b>	<b>Description</b>
1	300 MHz OUT 1 and 2 provide 300 MHz, 0 dB signals that are used by other modules in the system for reference and phase-locking.
2	EXT TRIG IN is a TTL input that is used for the external trigger functions of the spectrum analyzer. When in external trigger mode, the spectrum analyzer begins a sweep upon receipt of this signal.
3	HSWP IN/OUT has a TTL signal that is high any time the LO is sweeping. This port works both as an output and an input, allowing other modules in the system to interrupt the sweep.
4	100 MHz IN receives the 100 MHz, 0 dB signal input that is used by the LO for all frequency synthesis and phase-locking. If this signal is not present, the LO will use an internally generated 100 MHz signal which will result in reduced performance.
5	VIDEO IN receives a 0 to 2 V signal input that is the post-detected signal that will be displayed on the screen. This signal is processed by the LO.
6	SWEEP provides a signal that is a linear 0 to 10 V ramp corresponding to the sweep of the analyzer. There is no tuning information available from this signal. It represents the <i>x</i> -axis of the display.
7	LO OUT provides the 3.0 to 6.6 GHz swept LO signal that is used for RF conversion (heterodyning). The signal amplitude can vary from +7 to 15 dBm.
8	TUNE + SPAN OUT provides a signal that is proportional to the frequency of the LO signal. The tune span signal varies 1.5 V per GHz with a range of 4.5 to 9.9 V.
9	The mainframe/module interconnect is a multiple-pin connector that plugs into the mainframe when the module is installed in the mainframe. This connector provides power-supply voltages and HP-MSIB connections for module communication and control.

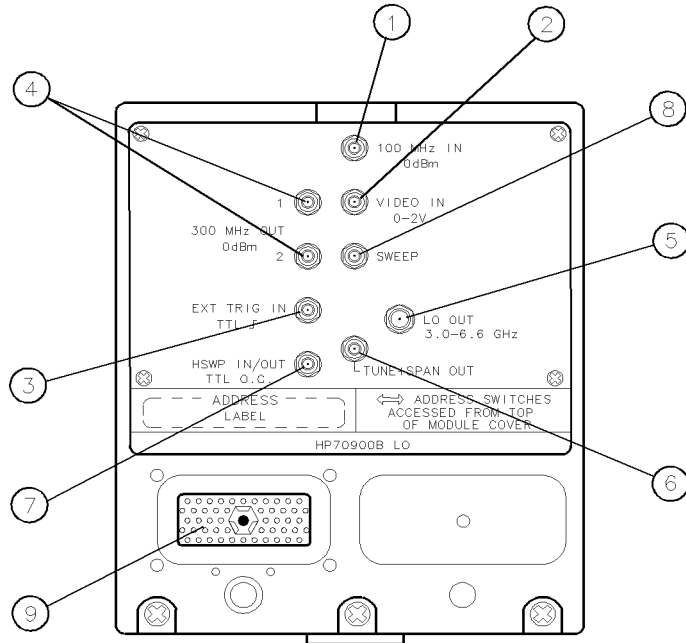

DUA44

**Figure 1-2. HP 70900B Local Oscillator Source Rear-Panel Features**

## HP 70900B Local Oscillator Source Options

The HP 70900B local oscillator source has the following module options available.

- Option 910** This option adds another set of the user documentation that normally ship with the module.
- Option 915** This option adds the module service documentation and module verification software.

## HP 70900B Local Oscillator Source Accessories

The HP 70900B local oscillator source may be ordered separately or as part of an HP 70000 Series modular spectrum analyzer system. When ordered separately, accessories are supplied for the most common system configurations. Table 1-3 lists cables included with the module when ordered separately. When ordered with an HP 70000 Series modular measurement system, cables are supplied to connect the module in that configuration. Refer to Chapter 2 for cables available to configure other module arrangements.

**Table 1-3. Accessories Shipped When Module is Ordered Separately**

Description	Span	HP Part Number
Flexible cable, SMB(f) to SMB(f), 9 cm (3.5 in.)	1/8	5061-9015
Flexible cable, SMB(f) to SMB(f), 39 cm (15.4 in.)	7/8	5061-9021
Semirigid LO cable, SMA(m) to SMA(m)	2/8	5021-5449
Flexible LO cable, SMA(m) to SMA(m), 52 cm (20 in.)	N/A	5061-9038



---

## Preparing an HP 70000 System for Use

### System Operating Requirements

Refer to Chapter 3 for the following information:

- operating and storage temperature ranges
- weights and dimensions of each system or module
- power requirements of the HP 70001A mainframe or HP 70004A color display

Before running the HP 11990A system performance test software, refer to “System Calibration Certification” for warm-up requirement information.

- 
- DANGER**
- **Before turning the system on, make sure it is grounded through the protective conductor of the power cable to a socket outlet with protective earth contact. Any interruption of the protective (grounding) conductor inside or outside the instrument, or disconnection of the protective earth terminal, can result in personal injury.**
  - **Before turning the system on, be sure the line voltage selector is set to the correct voltage for the power source. Failure to do this may cause damage (a blown fuse) to the system when the power cable is plugged in.**
  - **Do not operate a 400 Hz Option instrument on a 400 Hz power line without the attached in-line isolation transformer. Failure to follow this precaution can result in personal injury.**
-

## Initial System Power-On

The HP 70000 Series modular spectrum analyzer system is shipped as a preconfigured system model (for example, HP 71100C modular spectrum analyzer), with most rear panel inter-module cables connected. (Some cables are removed for shipping.) The following procedure may be used to ensure that proper initial conditions exist at power-on.

1. Locate the cables shipped with the system.
2. Inspect socket ends and cables for damage.
3. If the loose inter-module cables are intact, connect them. For information on rear panel cabling examples, refer to Chapter 2. Make sure each rear panel inter-module cable is connected securely.
4. Make sure the system line-voltage selectors are set to the same voltage as the power source.
5. Connect the power cables to the instruments first, then plug the cables into the power outlet.
6. If the LO module is located in the HP 70004A color display, perform the steps below in the order shown. If the LO module is located in the HP 70001A mainframe, perform Step b first and then Step a.
  - a. Set the HP 70001A mainframe line switch to the on position and listen to verify that the ventilation fan starts up.
  - b. Set the HP 70004A color display line switch to the on position and listen to verify that the ventilation fan starts up.
7. Observe that the indicator lights flash on the front panels of each module. (Refer to “HP 70900B Local Oscillator Source Front-Panel Features”.)
8. Check to see that the STATUS indicator light labeled ACT on the modules in the selected system remain lit. When two IF sections are in the system, only the one that is selected will have its ACTIVE light on.

If the system responds properly, make sure that the system is allowed to warm-up before running any system verification tests. Refer to “System Calibration Certification” and Chapter 3 for warm-up time requirements.

## System Calibration Certification

To qualify a modular spectrum analyzer for calibration certification, *allow the instrument to warm up for at least 1 hour*, then load and run the HP 11990A system performance test software. The HP 11990A system performance test software is available through your local Hewlett-Packard sales or service offices.

If all tests pass, a certification label may be applied to the front panel of the modular spectrum analyzer system. The certification label indicates that the system has met certain specifications. All test routines must be passed before the system can qualify for a certification label. The customer’s own label may be applied, or an Hewlett-Packard service office may perform the calibration and apply a Hewlett-Packard certification label to the front panel of the system.

---

## Instrument Keypad for a Spectrum Analyzer

A spectrum analyzer instrument keypad (see Figure 1-3) is shipped with each HP 70900B local oscillator source. This keypad, designed to plug into the front of an HP 70004A color display, allows the operator to access or activate spectrum analyzer control functions from the front of the HP 70004A color display. The spectrum analyzer instrument keypad can be used with the current LO module and HP 70004A color display firmware.

Each spectrum analyzer control function is enabled by pressing the function key that controls that function. Once enabled, the function (along with its current data value) is displayed both in the active function area of the display and outside the graticule border. To change the value of the active function use the display's data knob, step keys, or numeric keyboard. Table 1-4 lists the function keys that are on the spectrum analyzer instrument keypad.

Refer to the *HP 70000 Modular Spectrum Analyzer Operating Manual* or the *HP 70004A Color Display User's Guide* for additional information.

**Table 1-4. Instrument Keypad Function Keys**

Function Key	Description of Function
(CENTER)	Activates the center frequency function, which can then be tuned continuously over the range of the spectrum analyzer using the data controls.
(SPAN)	Changes the total display frequency range symmetrically about the center frequency.
(REF LEVEL)	Changes the absolute amplitude power or voltage represented by the top graticule on the screen.
(START FREQ)	Sets the frequency at the left side of the graticule.
(STOP FREQ)	Sets the frequency at the right side of the graticule.
(SIGNAL TRACK)	Allows the analyzer to automatically maintain drifting signals at the center of the screen. As the signal drifts, the spectrum analyzer is retuned to bring the signal and marker to the center of the screen. This allows real-time monitoring of the change.
(NORMAL)	Activates a frequency marker at the center of the screen on the active trace. The data controls are used to position the marker. An annotation in the active function area and in the upper-right corner indicate the frequency and amplitude of the marker.
(PEAK SEARCH)	Places a marker on the highest peak.
( $\Delta$ )	Provides a means of finding and displaying the frequency and amplitude differences (delta) between the two signals with the highest amplitude.
(NEXT PEAK)	Places the marker on the next highest peak.
(SAVE)	Saves the spectrum analyzer states to the state registers.
(RECALL)	Retrieves spectrum analyzer states from the state registers.

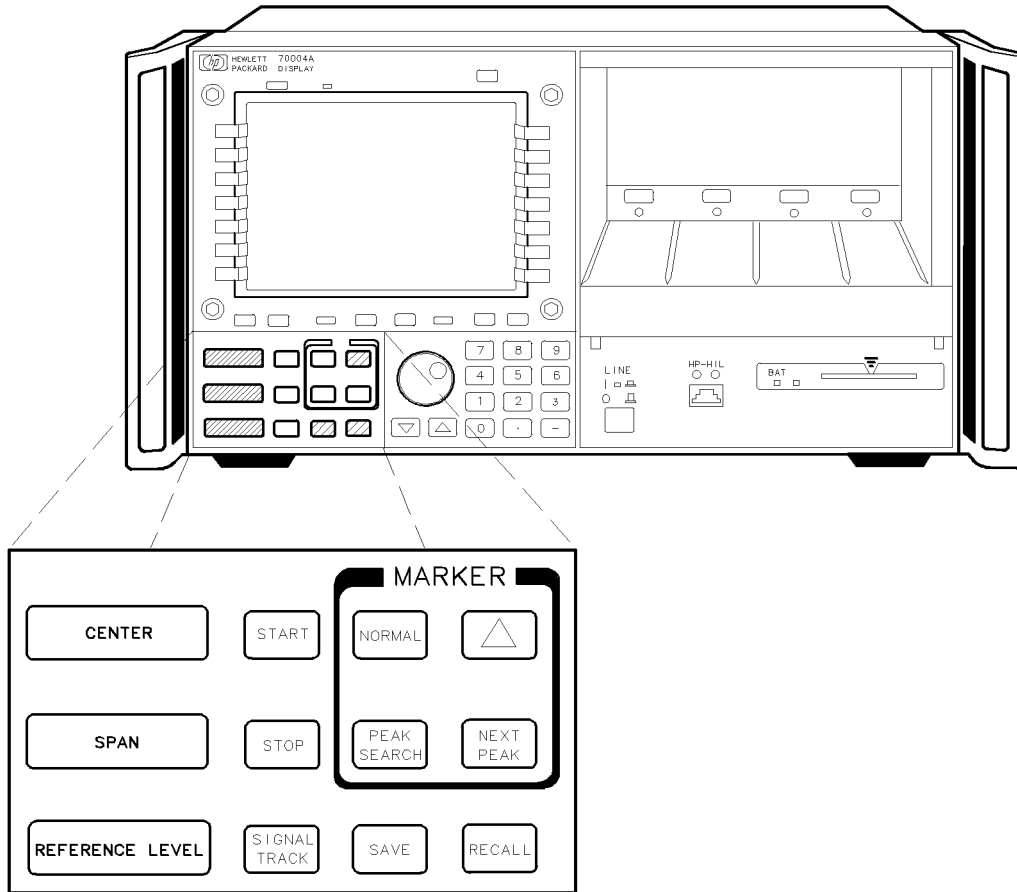

DUA45

**Figure 1-3. Spectrum Analyzer Instrument Keypad**

---

## System Rack-Mount and Cabinet Interconnect Installation

To make bench operation of the system easier, HP 70000 Series modular measurement system mainframes and stand-alone models (for example, HP 70206A system graphics display) have fold-away tilt stands and plastic feet that are designed to be self-aligning when systems are stacked. Use the following information when modifying your system for rack-mounting or when connecting two system cabinets.

---

**CAUTION** Be sure to use the correct hardware when replacing parts. Both Metric and English hardware are used with these instruments. Using incorrect screw sizes may damage the instrument cabinet.

---

### Rack-Mounting

Front handles must be removed before installing system rack-mounting options. Refer to Figure 1-4.

---

**CAUTION** Do not rack mount multiple mainframes or stand-alone models with one rack-mount hardware kit. One rack-mount hardware kit must be ordered for each stand-alone model or mainframe.

---

System Option 908, rack flange kit without handles, and System Option 913, rack flange kit with handles, contain the necessary hardware for mounting the HP 70004A color display and the HP 70001A mainframe.

Figure 1-4 provides rack-mount option screw sizes, and handle or bracket-positioning for proper rack-mount installation. Angle brackets (HP 12679C) may be ordered to provide the additional rear or side support required of a mounted instrument.

### Rack-Mounting with Slides

System Option 810, rack mount with slides is for a system with an HP 70004A color display and an HP 70001A mainframe. This option contains the necessary hardware to attach slides to both the display and the mainframe and mount them in a rack.

System Option 811, Rack Mount with Slides is for a system with an HP 70206A system graphics display stand-alone display and an HP 70001A mainframe. This option contains the necessary hardware to attach slides to both the stand-alone display and the mainframe and mount them in a rack.

Table 2-3 identifies the part numbers of slide rack-mount kits. Installation instructions are included with each kit.

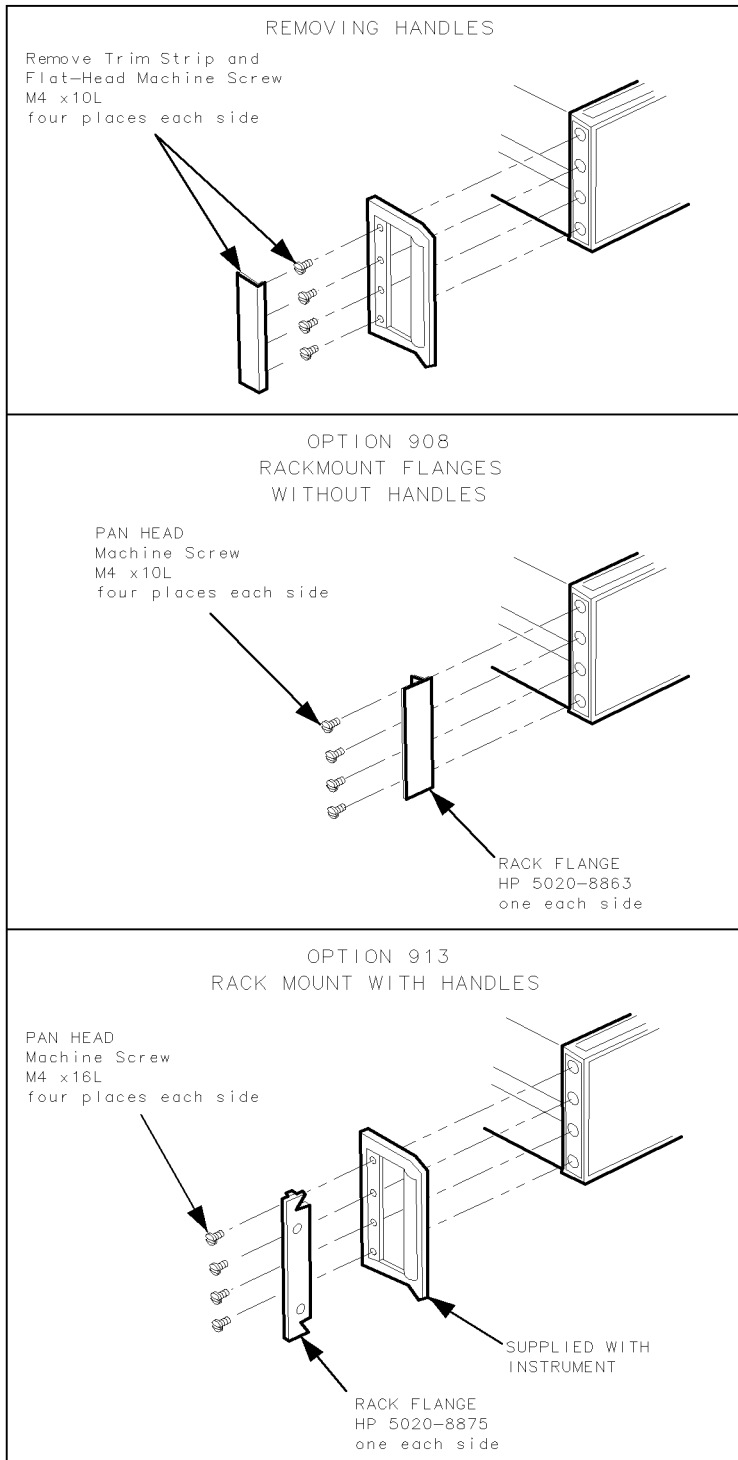

NOTE: LEFT FRONT IS SHOWN IN EACH EXAMPLE.

DUA46

**Figure 1-4. Front Handle Removal and Rack Mounting**

## Interconnecting Instrument Cabinets

**CAUTION** The HP 70001A mainframe and HP 70206A system graphics display use Metric 4.0 screws. Other System II cabinets use Metric 3.5 or English 6-32 screws. Using incorrect screw sizes may damage the instrument cabinet.

Kit hardware used for vertically interconnecting System II cabinets is illustrated in Figure 1-5. The kit contains both Metric and English screws to cover all mainframe and System II cabinet combinations.

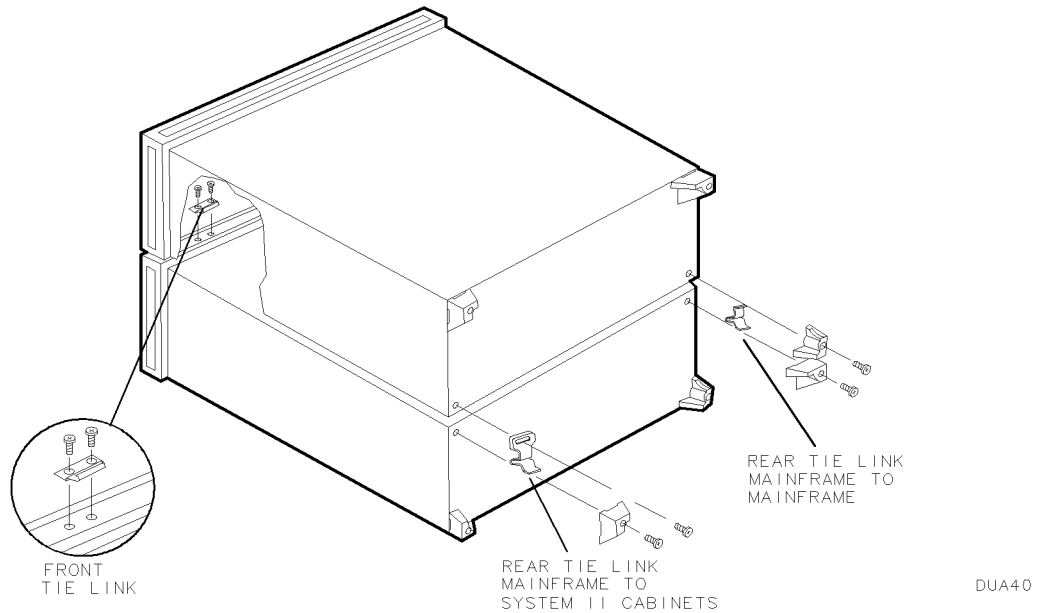

**Figure 1-5. Interconnecting System II Cabinets**

**Table 1-5. Interconnect Hardware**

Qty	Description	HP Part Number	CD
HP 70001A mainframe to HP 70001A mainframe interlock kit (HP part number 70001-60059, CD = 9)			
2	Front Tie Link	1600-0367	7
2	Rear Tie Link	70001-00037	7
4	M4 X 6L Screw	0515-0898	7
HP 70001A mainframe to System II cabinet interlock kit (HP part number 5061-9061, CD = 6)			
4	Front Tie Link	1600-0367	7
2	Rear Tie Link	70001-00036	6
4	M4 X 6L Screw	0515-0898	7
10	M3.5 X 6L Screw	0515-0887	4
10	#6-32 X 3/166 Screw	2360-0330	5

---

## Line Voltage Selection

Use the line-voltage selectors to select the appropriate voltage setting for each mainframe or display in the system. The line-voltage selector is located on the bottom of the mainframe, on the rear panel of the stand-alone display, or on the right side of the HP 70004A color display. See Figure 1-6.

- 
- DANGER**
- Before turning the system on, make sure it is grounded through the protective conductor of the power cable to a socket outlet with protective earth contact. Any interruption of the protective (grounding) conductor inside or outside the instrument, or disconnection of the protective earth terminal, can result in personal injury.
  - Before turning the system on, be sure the line voltage selector is set to the correct voltage for the power source. Failure to do this may cause damage (a blown fuse) to the system when the power cable is plugged in.
  - Do not operate a 400 Hz Option instrument on a 400 Hz power line without the attached in-line isolation transformer. Failure to follow this precaution can result in personal injury.
- 

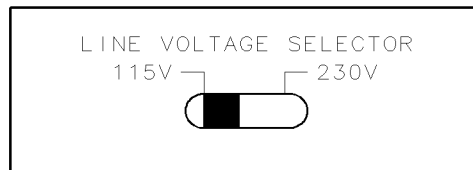

DUA54

**Figure 1-6. Line Voltage Selector**



---

## 400 Hz Option for the Mainframe and Stand-Alone Display

Both the HP 70001A mainframe and the HP 70206A system graphics display are available with an option that allows them to run on a power-line frequency of 400 Hz.

---

**Note** The HP 70004A color display does not require an option to operate on 400 Hz.

---

The modular spectrum analyzer 400 Hz Options come with an external in-line isolation transformer for use with a 400 Hz power source. Refer to “System Replaceable Parts” in Chapter 2 for specific option number information. For 400 Hz Option specifications, refer to Chapter 3.

- 
- DANGER**
- **Before turning the system on, make sure it is grounded through the protective conductor of the power cable to a socket outlet with protective earth contact. Any interruption of the protective (grounding) conductor inside or outside the instrument, or disconnection of the protective earth terminal, can result in personal injury.**
  - **Before turning the system on, be sure the line voltage selector is set to the correct voltage for the power source. Failure to do this may cause damage (a blown fuse) to the system when the power cable is plugged in.**
  - **Do not operate a 400 Hz Option instrument on a 400 Hz power line without the attached in-line isolation transformer. Failure to follow this precaution can result in personal injury.**
- 

The in-line isolation transformer must be removed from the 400 Hz Option for 60 Hz power-source operation. Failure to remove the in-line transformer may result in a blown fuse. When the isolation transformer is removed, a standard power cord must be used. Reinstall the in-line isolation transformer for use with a 400 Hz power source. This protects the user from shock hazard.

---

## System Line Fuse Replacement

The system line fuse is in the line-module housing, which is located at the rear of the system mainframe and the display. The Metric 6.3 A fuse (HP part number 2110-0703) can be used with both 120 V and 230 V power sources. A spare fuse is included with the line fuse in the line-module housing. Figure 1-7 illustrates removal and replacement of the system line fuse.

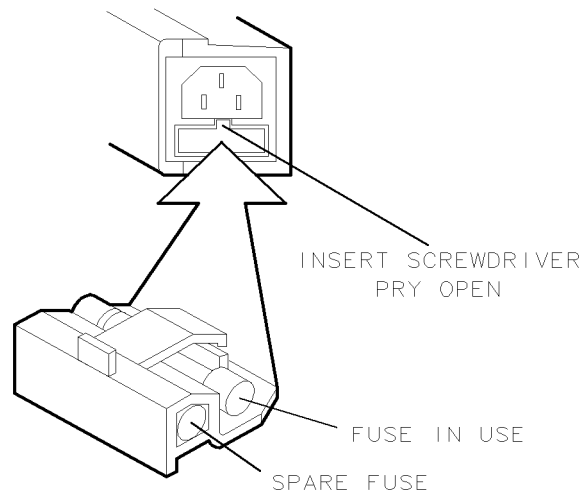

DUA48

**Figure 1-7. Line Fuse Removal and Replacement**

---

## Optional Mainframe Rear-Fan Filter

An optional rear-fan filter may be ordered for the HP 70001A mainframe. This filter is not included as part of the standard system. Refer to Figure 1-8 for the part number and installation information for the rear-fan filter.

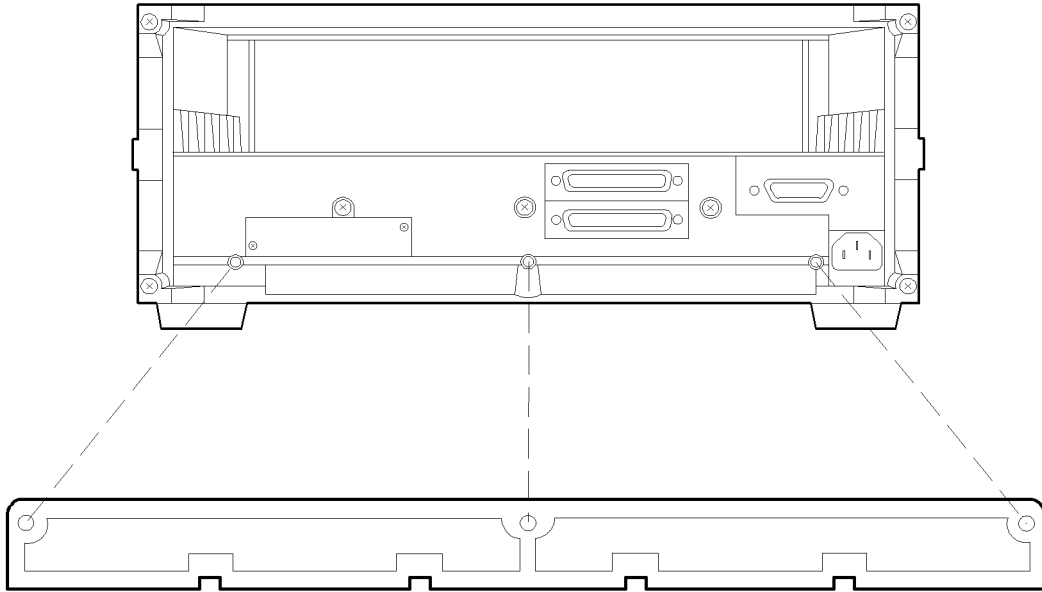

HP 70001-40017

DUA49



**Figure 1-8. Rear-Fan Filter Installation**

---

## System Power Cables

In accordance with international safety standards, this instrument is equipped with a three-wire power cable. When this cable is connected to a properly grounded power receptacle, the instrument cabinet is grounded.

A suitable cable for systems shipped to international customers is included with each system. If additional cables need to be ordered, refer to Figure 1-9 for part numbers.

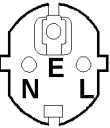
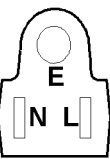
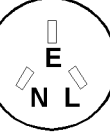
PLUG TYPE **	CABLE HP PART NUMBER	PLUG DESCRIPTION	CABLE LENGTH CM (INCHES)	CABLE COLOR	FOR USE IN COUNTRY
<b>250V</b> 	8120-1351 8120-1703	Straight* BS1363A 90□	229 (90) 229 (90)	Mint Gray Mint Gray	Great Britain, Cyprus, Nigeria, Singapore, Zimbabwe
<b>250V</b> 	8120-1369 8120-0696	Straight* NZSS198/ ASC112 90□	201 (79) 221 (87)	Gray Gray	Argentina, Australia, New Zealand, Mainland China
<b>250V</b> 	8120-1689 8120-1692	Straight* CEE7-Y11 90□	201 (79) 201 (79)	Mint Gray Mint Gray	East and West Europe, Central African Republic, United Arab Republic (unpolarized in many nations)
<b>125V</b> 	8120-1348 8120-1538	Straight* NEMA5-15P 90□	203 (80) 203 (80)	Black Black	United States, Canada, Japan (100V or 200V), Brazil, Colombia, Mexico, Philippines, Saudia Arabia, Taiwan
	8120-1378 8120-4753 8120-1521 8120-4754	Straight* NEMA5-15P Straight 90□ 90□	203 (80) 230 (90) 203 (80) 230 (90)	Jade Gray Jade Gray Jade Gray Jade Gray	
<b>250V</b> 	8120-5182 8120-5181	Straight* NEMA5-15P 90□	200 (78) 200 (78)	Jade Gray Jade Gray Jade Gray Jade Gray	Israel
<p>* Part number for plug is industry identifier for plug only. Number shown for cable is HP Part Number for complete cable, including plug.</p> <p>** E = Earth Ground: L = Line: N = Neutral.</p>					

plugsig.cdr

Figure 1-9. AC Power Cords

---

## Display Screen Cleaning

To avoid damaging the coating on the display screen, use a thin film cleaner such as Hewlett-Packard Display Cleaner (HP part number 8500-2163). This should be used with an abrasion-free cleaning tissue or soft cloth.

---

**CAUTION** Do not use hand or laboratory paper towels to clean the display screen. These abrasive materials may scratch the screen coating. (Refer to “Display Screen Cleaning”.)

---

---

## External Power Pack for the HP 70310A Precision Frequency Reference

An external power pack (see Figure 1-10) provides standby power for the oscillator oven in the HP 70310A precision frequency reference when the mainframe is off. If an HP 70310A Option 002 precision frequency reference is ordered, the ovenized oscillator and accessory power pack are deleted. For the placement of the accessory power pack on the system mainframe, refer to “System Configurations for “A” and “C” Systems” in Chapter 2.

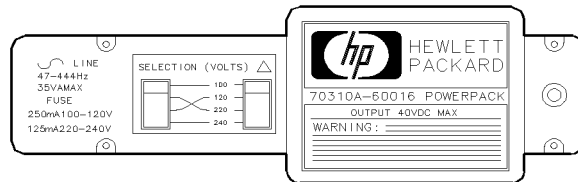

DUA50

**Figure 1-10. External Power Pack**

---

## Preparing a Static-Safe Work Station

Electrostatic discharge (ESD) can damage or destroy electronic components. Therefore, all work performed on assemblies consisting of electronic components should be done at a static-safe work station.

Figure 1-11 shows an example of a static-safe work station. Two types of ESD protection are shown:

- a conductive table mat and wrist strap combination
- a conductive floor mat and heel strap combination

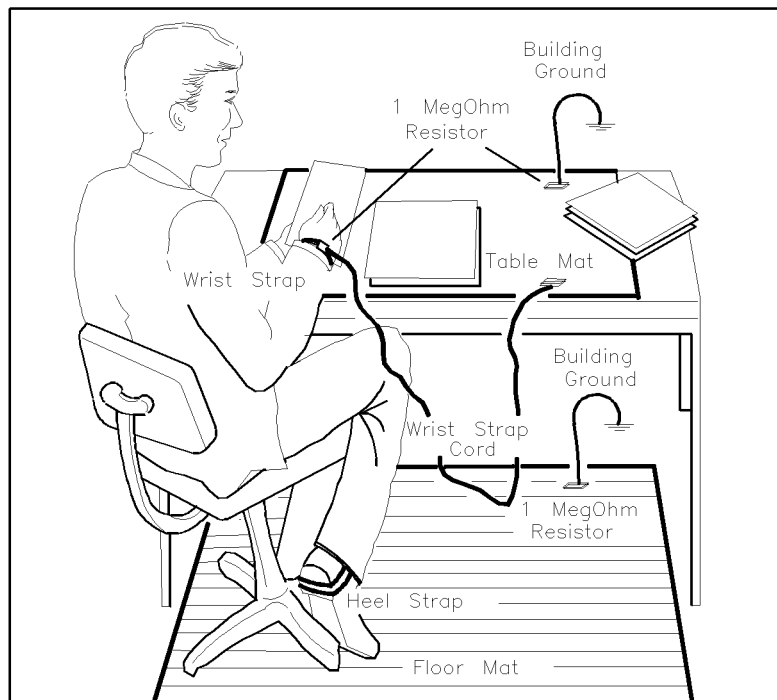

ESDPARTS

**Figure 1-11. Static-Safe Work Station**

These two types of ESD protection must be used together. Refer to Table 1-6 for a list of static-safe accessories and their HP part numbers.

- 
- CAUTION**
- Do not touch the edge-connector contacts or trace surfaces with bare hands. Always handle board assemblies by the edges.
  - Do not use erasers to clean the edge-connector contacts. Erasers generate static electricity and degrade the electrical quality of the contacts by removing the thin gold plating.
  - Do not use paper of any kind to clean the edge-connector contacts. Paper or lint particles left on the contact surface can cause intermittent electrical connections.
-

## Reducing ESD Damage

To help reduce the amount of ESD damage that occurs during testing and servicing use the following guidelines:

- Be sure that all instruments are properly earth-grounded to prevent buildup of static charge.
- Personnel should be grounded with a resistor-isolated wrist strap before touching the center pin of any connector and before removing any assembly from a piece of equipment.

Use a resistor-isolated wrist strap that is connected to the HP 70000 Series modular spectrum analyzer system mainframe's chassis. If you do not have a resistor-isolated wrist strap, touch the chassis frequently to equalize any static charge.

- Before connecting any coaxial cable to an instrument connector for the first time each day, *momentarily* short the center and outer conductors of the cable together.
- Handle all PC board assemblies and electronic components only at static-safe work stations.
- Store or transport PC board assemblies and electronic components in static-shielding containers.
- PC board assembly edge-connector contacts may be cleaned by using a lintfree cloth with a solution of 80% electronics-grade isopropyl alcohol and 20% deionized water. This procedure should be performed at a static-safe work station.

## Static-Safe ESD Accessories

**Table 1-6. Static-Safe ESD Accessories**

HP Part Number	Description
9300-0797	Set includes: 3M static control mat 0.6 m × 1.2 m (2 ft × 4 ft) and 4.6 m (15 ft) ground wire. (The wrist-strap and wrist-strap cord are not included. They must be ordered separately.)
9300-0865	Ground wire, 4.6 m (15 ft)
9300-0980	Wrist-strap cord 1.5 m (5 ft)
9300-1383	Wrist-strap, color black, stainless steel, without cord, has four adjustable links and a 7 mm post-type connection.
9300-1169	ESD heel-strap (reusable 6 to 12 months).
Order the above by calling HP DIRECT at (800) 538-8787 or through any Hewlett-Packard Sales and Service Office.	

---

## If You Need to Contact Hewlett-Packard

Before calling Hewlett-Packard or returning your instrument, please read your warranty information. Warranty information is printed at the front of this document.

In any correspondence or telephone conversations, refer to the instrument by its full model number and full serial number. With this information, the Hewlett-Packard representative can determine whether your unit is still within its warranty period.

## Determining Your Instrument's Serial Number

When a module is manufactured by Hewlett-Packard, it is given a unique serial number. This serial number is attached to a label on the front frame or front panel of the module. A serial number label is in two parts. (Refer to Figure 1-12.)

The first part makes up the serial number prefix and consists of four digits and a letter. The second part makes up the serial number suffix and consists of the last five digits on the serial number label. The serial number prefix is the same for all identical modules; it only changes when a change in the electrical or physical functionality is made. The serial number suffix, however, changes sequentially and is different for each module.

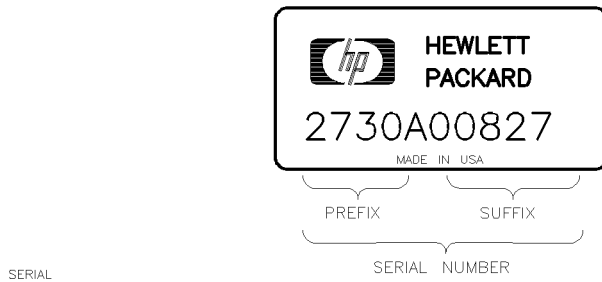

**Figure 1-12. Typical Serial Number Label**



Table 1-7. Hewlett-Packard Sales and Service Offices

<b>US FIELD OPERATIONS HEADQUARTERS</b>	<b>EUROPEAN OPERATIONS HEADQUARTERS</b>	<b>INTERCON OPERATIONS HEADQUARTERS</b>
Hewlett-Packard Company 19320 Pruneridge Avenue Cupertino, CA 95014, USA (800) 752-0900	Hewlett-Packard S.A. 150, Route du Nant-d'Avril 1217 Meyrin 2/Geneva Switzerland (41 22) 780.8111	Hewlett-Packard Company 3495 Deer Creek Rd. Palo Alto, California 94304-1316 (415) 857-5027
<b>California</b> Hewlett-Packard Co. 1421 South Manhattan Ave. Fullerton, CA 92631 (714) 999-6700	<b>France</b> Hewlett-Packard France 1 Avenue Du Canada Zone D'Activite De Courtaboeuf F-91947 Les Ulis Cedex France (33 1) 69 82 60 60	<b>Australia</b> Hewlett-Packard Australia Ltd. 31-41 Joseph Street (P.O. Box 221) Blackburn, Victoria 3130 (61 3) 895-2895
Hewlett-Packard Co. 301 E. Evelyn Mountain View, CA 94041 (415) 694-2000	<b>Germany</b> Hewlett-Packard GmbH Hewlett-Packard-Strasse 61352 Bad Homburg Germany (+49 6172) 16-0	<b>Canada</b> Hewlett-Packard (Canada) Ltd. 17500 South Service Road Trans-Canada Highway Kirkland, Quebec H9J 2X8 Canada (514) 697-4232
<b>Colorado</b> Hewlett-Packard Co. 24 Inverness Place, East Englewood, CO 80112 (303) 649-5000	<b>Great Britain</b> Hewlett-Packard Ltd. Eskdale Road, Winnersh Triangle Wokingham, Berkshire RG11 5DZ England (44 734) 696622	<b>Japan</b> Yokogawa-Hewlett-Packard Ltd. 1-27-15 Yabe, Sagamihara Kanagawa 229, Japan (81 427) 59-1311
<b>Georgia</b> Hewlett-Packard Co. 2124 Barrett Park Drive Kennesaw, GA 30144 (404) 955-1500		<b>China</b> China Hewlett-Packard, Co. 38 Bei San Huan X1 Road Shuang Yu Shu Hai Dian District Beijing, China (86 1) 256-6888
<b>Illinois</b> Hewlett-Packard Co. 5201 Tollview Drive Rolling Meadows, IL 60008 (708) 342-2000		
<b>New Jersey</b> Hewlett-Packard Co. 150 Green Pond Road Rockaway, NJ 07866 (201) 586-5400		<b>Singapore</b> Hewlett-Packard Singapore Pte. Ltd. Alexandra P.O. Box 87 Singapore 9115 (65) 271-9444
<b>Texas</b> Hewlett-Packard Co. 930 E. Campbell Rd. Richardson, TX 75081 (214) 231-6101		<b>Taiwan</b> Hewlett-Packard Taiwan 8th Floor, H-P Building 337 Fu Hsing North Road Taipei, Taiwan (886 2) 712-0404

---

## Returning Your Instrument to Hewlett-Packard

Hewlett-Packard has sales and service offices around the world to provide complete support for your instrument. To obtain servicing information or to order replacement parts, contact the nearest Hewlett-Packard sales and service office listed in Table 1-7.

Use the following procedure to return your instrument to Hewlett-Packard:

1. Fill out a service tag (available at the end of this document) and attach it to the instrument. Please be as specific as possible about the nature of the problem. Send a copy of any or all of the following information:
  - any error messages that appeared on the HP 70000 Series display
  - a completed Performance Test record
  - any other specific data on the performance of the instrument

---

**CAUTION** Damage can result if the original packaging materials are not used. Packaging materials should be anti-static and should cushion the instrument on all sides.

Never use styrene pellets in any shape as packaging materials. They do not adequately cushion the instrument or prevent it from moving in the shipping container. Styrene pellets can also cause equipment damage by generating static electricity or by lodging in fan motors.

---

2. Place the instrument in its original packaging materials.

If the original packaging materials are not available, you can contact a Hewlett-Packard sales and service office to obtain information on packaging materials or you may use an alternative packing material referred to as “bubble-pack”. One of the companies that makes bubble-pack is Sealed Air Corporation of Hayward, California, 94545.

3. Surround the instrument with at least 3 to 4 inches of its original packing material or bubble-pack to prevent the instrument from moving in its shipping container.
4. Place the instrument, after wrapping it with packing material, in its original shipping container or a strong shipping container that is made of double-walled corrugated cardboard with 159 kg (350 lb) bursting strength.

The shipping container must be both large enough and strong enough to accommodate your instrument and allow at least 3 to 4 inches on all sides for packing material.

5. Seal the shipping container securely with strong nylon adhesive tape.
6. Mark the shipping container “FRAGILE, HANDLE WITH CARE” to help ensure careful handling.
7. Retain copies of all shipping papers.

Returning Your Instrument to Hewlett-Packard

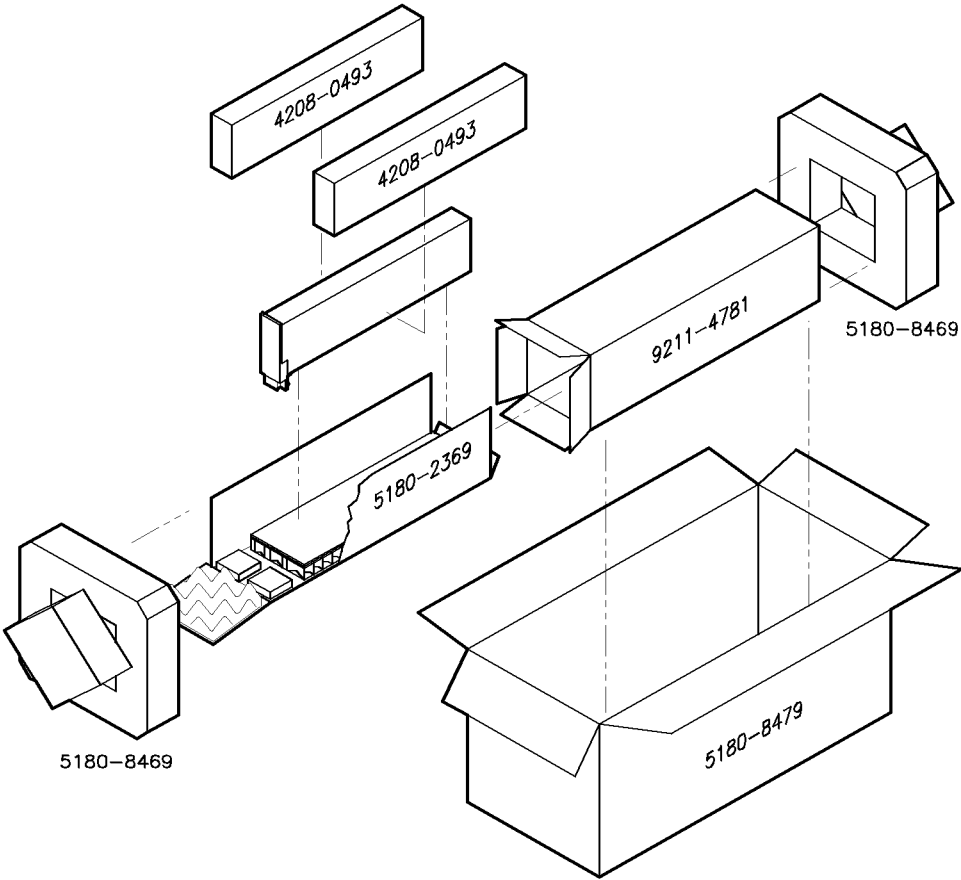

packing1

Table 1-8. Packaging for a 1/8 Module (Instrument)

Item	Description	HP Part Number	Qty
1	Carton-outer	5180-8479	1
2	Carton-inner	9211-4781	1
3	Carton-sliders	5180-2369	1
4	Foam inserts	4208-0493	2
5	Foam pads	5180-8469	2

## Returning Your Instrument to Hewlett-Packard

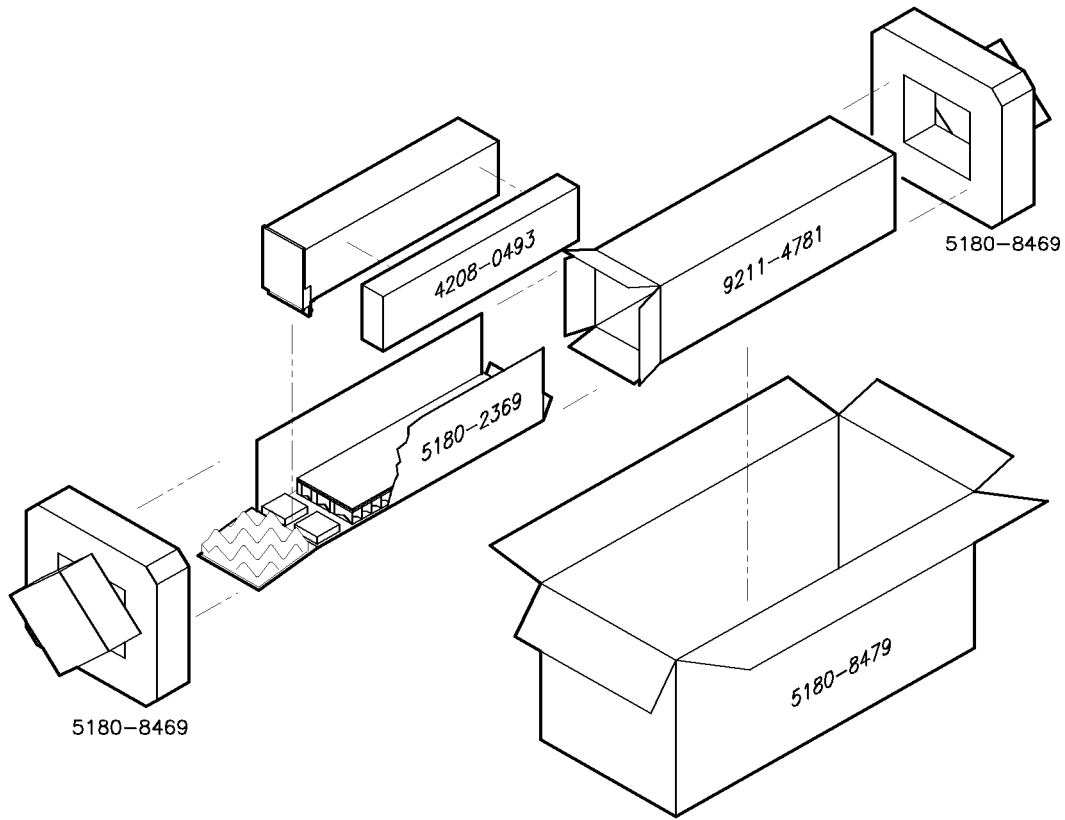

packing2

**Table 1-9. Packaging for a 2/8 Module (Instrument)**

Item	Description	HP Part Number	Qty
1	Carton-outer	5180-8479	1
2	Carton-inner	9211-4781	1
3	Carton-sliders	5180-2369	1
4	Foam inserts	4208-0493	1
5	Foam pads	5180-8469	2

## Returning Your Instrument to Hewlett-Packard

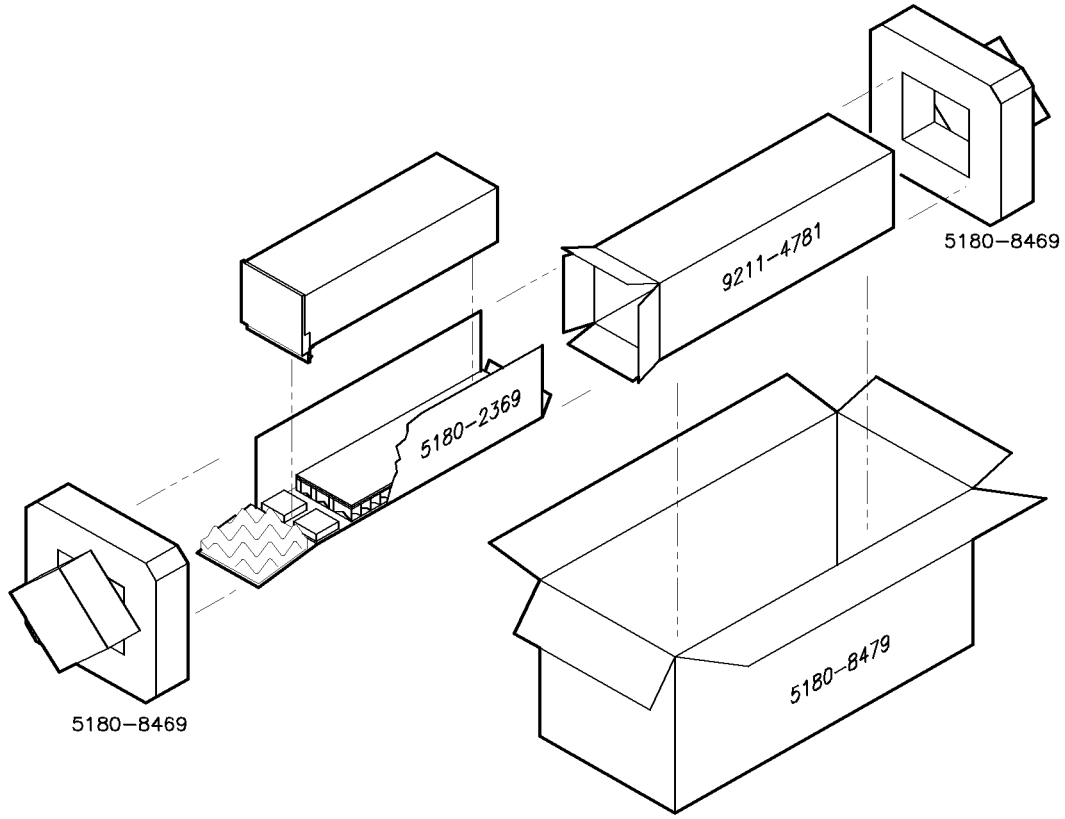

packing3

**Table 1-10. Packaging for a 3/8 Module (Instrument)**

Item	Description	HP Part Number	Qty
1	Carton-outer	5180-8479	1
2	Carton-inner	9211-4781	1
3	Carton-sliders	5180-2369	1
4	Foam pads	5180-8469	2

## Returning Your Instrument to Hewlett-Packard

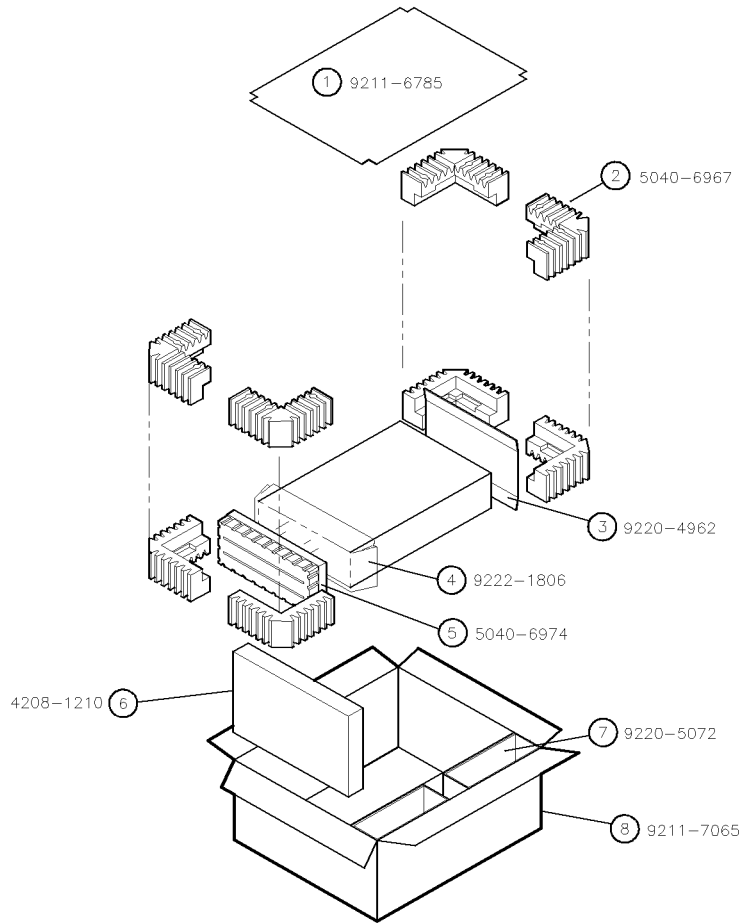

packing8

**Table 1-11. Packaging for an 8/8 Module (Instrument)**

Item	Description	HP Part Number	Qty
1	Corrugated Carton (Top)	9211-6785	1
2	Foam Corner-Pads	5040-6967	8
3	Flat End-Cap	9220-4962	1
4	Static Sheet	9222-1806	1
5	Front Cover	5040-6974	1
6	Foam Plastic	4208-1210	1
7	Corrugated Pad	9220-5072	1
8	Corrugated Carton (Outer)	9211-7065	1

## Installation

---

This chapter contains information necessary for installing the components of an HP 70000 Series modular spectrum analyzer system. The factory ships HP 70000 Series modular spectrum analyzer systems with all system components installed and addressed. All cables, however, are subject to removal for shipment.

The following information is included in this chapter.

- “HP-MSIB/HP-IB Addressing” provides information for setting the HP-MSIB address of each module, explains how HP-IB and HP-MSIB addresses interrelate, and illustrates examples of address switches.
- “Module Removal and Installation” describes how to remove or install modules.
- “System Configurations for “A” and “C” Systems” give examples of common system configurations. The information given in each example includes an HP-MSIB address map, a listing of cables needed, and cable connection information.
- “System Replaceable Parts” lists model and HP part numbers for system-level replaceable parts, system cables, and service accessories.

---

### HP-MSIB/HP-IB Addressing

An **element** in an HP 70000 Series modular measurement system is a **system component** able to communicate with other modules over HP-MSIB. Element addresses must adhere to the set of rules defined in this section.

HP-MSIB addressing is different from HP-IB addressing, and is explained in more detail in this section. The topics listed below include definitions and information about the HP-MSIB and HP-IB address of an element. Correct addressing requires an understanding of the following concepts:

- Modular Measurement System Terms
- Address Map (Matrix) Protocol
- Addressing Elements
- Addressing Order Requirements
- Address Switches

## Modular Measurement System Terms

Understanding the following terms is essential to understanding HP-MSIB addressing and the structural relationship of modular measurement system devices.

### Functional Terms

The devices of a modular system may be combined in such a way to allow them to communicate and operate as an instrument. The following terms identify the interrelationship among devices within a modular instrument.

<b>Element</b>	Any device that communicates over the HP-MSIB (for example, HP 70902A IF section). In contrast, the HP 70001A mainframe controls all HP-MSIB communication, but does not communicate over the HP-MSIB and therefore is not an element.
<b>Master</b>	An element that controls other elements.
<b>Sub-master</b>	An element that simultaneously controls other elements and is controlled by another element.
<b>Slave</b>	An element that is controlled by another element.
<b>Independent element</b>	An element that is neither a master nor a slave (for example, HP 70004A color display).
<b>Instrument</b>	A module, or group of modules, that performs an independent function (for example, HP 71100C modular spectrum analyzer).

### Structural Terms

Modular systems consist of hardware structures dedicated to specific functions. The structural terms used in reference to these functions are described below.

<b>Mainframe</b>	A housing for modules which also provides power, cooling, interconnection for HP-MSIB and HP-IB, and HP-MSIB communications control for up to eight 1/8-width modules. The HP 70004A color display also provides the same functions for up to four 1/8-width modules.
<b>Module</b>	Modules are devices that plug into an HP 70001A mainframe or HP 70004A color display. Modules cannot function without these independent elements.
<b>Stand-Alone Instrument</b>	An HP-MSIB element capable of performing its functions without a mainframe or HP 70004A color display (for example, HP 70206A system graphics display).



## Address Map Protocol

Protocol for master, sub-master, slave, and independent element addressing is explained in this section. The factors governing proper system communication and system function are based on adherence to the addressing protocol of modular spectrum analyzers.

By definition, a master is an element addressed to control another element, or is the controlling element of a system. Slave elements are addressed within the area a master controls, called the slave area. Independent elements are addressed so that they are neither masters nor slaves, though they may have functions that appear to control other elements. For example, the graphics display front panel keys are used to select LO functions, but the LO is not a slave to the display.

## Address Matrix

The address matrix is a graphic representation of assigned and available HP-MSIB addresses. The address assigned to each element appears on the matrix and indicates the relationship among master, sub-master, slave, and independent elements. Module function, access to HP-IB communication, and error reporting are all based on the location of the module address on the matrix. See Figure 2-1. The 8-row by 32-column matrix implies that 256 addresses are available; however, there are actually 255 legal addresses plus an illegal address at row 0, column 31.

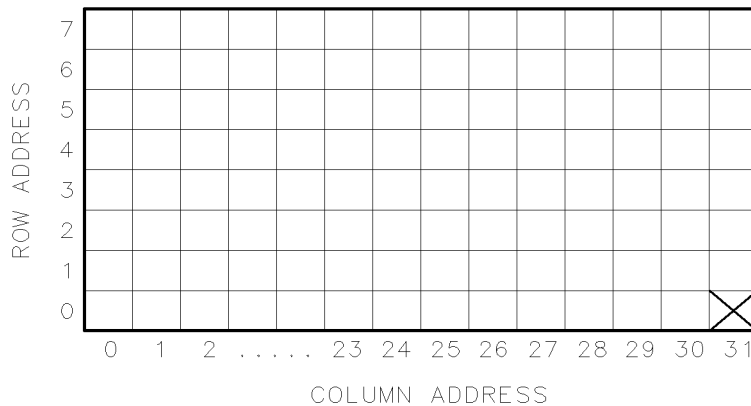

DUA33

**Figure 2-1. Address Matrix**

Each element must have a unique 8-bit binary HP-MSIB address correctly placed on the address matrix. The three most significant bits (MSB) determine the row address; the five least significant bits (LSB), the column address. This manual refers to the decimal equivalent of a binary address.

**Table 2-1. Decimal Equivalent of Binary Address**

	Row MSB	Column LSB
<b>Binary</b>	010	11000
<b>Decimal</b>	2	24

## Display-Response Area

A display-response area exists at row 0. The display's **REPORT ERRORS** menu key function can only access a module addressed at row 0. A display must be assigned to an instrument before communication between the two is initiated. This can be done automatically or manually. The automatic assignment function (**SELECT INSTRUMENT** menu key) searches the display-response area (row 0) when it assigns itself to an instrument. The display can be assigned to a module at any other row, but this assignment must be done manually using the **ASSIGN KEYBOARD** and **ASSIGN WINDOW** menu keys.

---

**Note** To be addressed at row 0, a module must be designed to interface with the display and report errors. If a module that does not have these capabilities is addressed at row 0, the system will cease to communicate.

---

## HP-IB Access

The HP-IB access area is at row 0 of the address matrix. Address row 0, column 31, however, is an illegal address location for any element. Modules that have been designed for HP-IB access are able to use HP-IB only if their addresses are in the HP-IB access area (row 0, columns 0 through 30).

---

**Note** Address row 0, column 31 is an illegal address for any element.

---

## Addressing Elements

### Master Elements

The address switches set an element's HP-MSIB address. If the element is a master or an independent element, the column switches also determine the default HP-IB address. (Displays do not have row address switches, so they are always set to row address 0.) A master is typically placed at any legal row 0 address. This row address location allows error reporting and access to HP-IB. If neither error reporting nor HP-IB access are required, a master may be placed at any legal address.

Modules controlled by another module are called slaves. To be controlled by a master, slave modules must be addressed within the slave area defined by that master. Refer to Figure 2-2 for examples of modules in a slave area. For proper system function and communication, slaves must be addressed within the boundaries set by the defining elements.

A defining element is any element, residing to the right and in the same row or lower than a master.

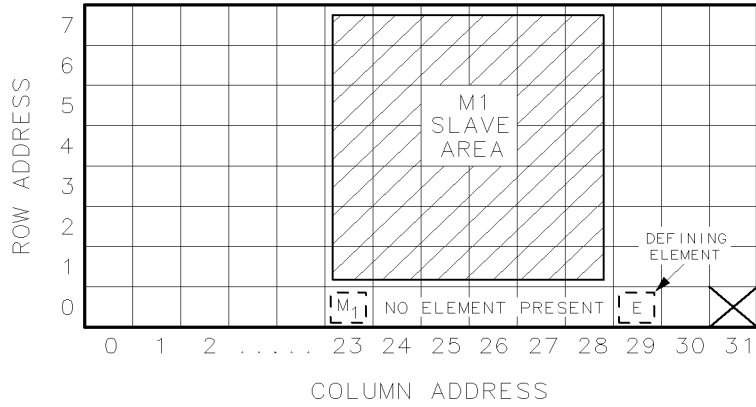

DUA34

**Figure 2-2. Master/Slave Address Matrix**

**Sub-Master Elements**

A sub-master is an element that can function as both master and slave at the same time. Sub-masters are located at a row address other than 0, are controlled by another master, and control a slave area of their own. For example, Figure 2-3 illustrates sub-master M2 at address 3, 24. M2 is a slave to M1. M2 also has a slave area that lies within the slave area of M1. M1 does not communicate directly with M2 slaves; it can only communicate with them through M2.

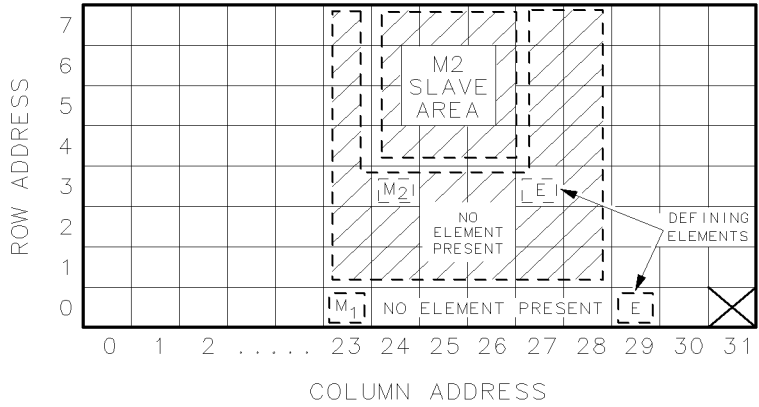

DUA35

**Figure 2-3. Sub-Master Address Matrix**

**Slave Elements**

For an instrument to function properly, the master must determine the slave area it controls on the address matrix. Master modules establish their slave area by determining the location of the defining element on the address matrix. The defining element establishes the boundaries of the slave area. Any module located within this area is a slave to the master module.

The HP-MSIB address requirements of a defining element are as follows:

- The column address of a defining element must be greater than the column address of the master. In Figure 2-2, for the master addressed in column 23, the defining element must be addressed in column 24 or above. In Figure 2-3, for M2 addressed in column 24, the defining element must be addressed in column 25 or above.
- The row address of a defining element must be equal to or less than the row address of a master. In Figure 2-2 the address of the master at row 0 has a defining element addressed at row 0. Figure 2-3 shows two masters, M1 and M2. The defining element for M1 is located at row 0 and the defining element for M2 is located at row 3.

### **Slave Area Boundaries**

The master determines its slave-area boundaries by first searching upward in its own column starting in the master's row, then in each higher column starting in the master's row. The search stops at the boundary column or, if there is no defining element, after searching column 31.

After a master locates the defining element of its slave area, the slave area boundaries are set by using the following criteria:

- The column address of the master is the left-hand boundary of the slave area. In Figure 2-2, the left-hand boundary is column 23.
- The right-hand boundary of the slave area is equal to one less than the column address of the defining element. For the master at column 23 in Figure 2-2, the right-hand boundary is at column 28. If there is no defining element, the right-hand boundary of the slave area extends through column 31.
- The lower boundary of the slave area is one row greater than the row address of the master. For the master in row 0 in Figure 2-2, the lower boundary is at row 1.
- The upper boundary of the slave area is the top row of the matrix (row 7).

If a new module is added to the area labeled "No Element Present" in Figure 2-2, this module becomes the new defining element and the right-hand boundary moves toward the master.

### **Independent Elements**

An independent element, such as a display, is neither a master nor a slave. Displays are considered independent elements and separate instruments. Because they do not have row address switches, displays automatically are at row address 0. The typical address for a display is row 0, column 4.

## Addressing Order Requirements for HP 70000 Systems

HP-MSIB addresses are set by switches located on each module. The address consists of two parts: a row number and a column number. A module's address can be determined by viewing the address map or selecting the configuration screen.

Measurement systems are composed of more than one module. When this is true, the modules will assume master/slave relationships to simplify the user interface. Each master has specific slave addressing requirements and expectations.

The HP 70900B local oscillator source is the master of many possible spectrum analyzer system configurations. It will automatically configure itself into a system with the slaves that it finds available in its slave area on the address map. It searches for these slaves with a specific pattern and expects to find them in a certain order.

The HP 70900B local oscillator source searches the address map by starting in the column where it is addressed and looking for a module in the row directly above it. It continues to look up that column row by row until it reaches the top. It then moves to the next column to the right. Again, it begins its search at the row above its own location, searching up the column to the top. It continues this process until it has searched its entire slave area. In this way it identifies the slave modules that it will configure into a system. For a more detailed description of how a master's slave area is defined, refer to "Address Map Protocol".

### Default Addressing for Configured HP 70000 Systems

Default addresses have been set up to allow for current and future addressing considerations. The use of these default addresses will permit adding additional modules to a system with a minimum of address manipulation. Individual modules shipped from the factory will have their HP-MSIB address set as defined in the default address map. Table 2-2 lists the location of the current modules in the default address map.

**Table 2-2. Default Address Map**

Row			
7	blank	HP 70310	blank
6	RF sections	HP 70300	† HP 70620 or HP 70621
5	HP 70907	HP 70301	blank
4	HP 70903	blank	HP 70810B Option 850
3	HP 70911	* HP 70620 or HP 70621	HP 70810B
2	HP 70700	HP 70600 or HP 70601	blank
1	HP 70902	blank	blank
0	HP 70900	blank	blank
	column 18	column 19	column 20
* When preamplifying the preselector's or RF section's input signal.			
† When preamplifying the lightwave section's input signal.			

## Addressing Criteria

Each module, or type of module, has addressing criteria that impact address selection. The descriptions below are written as if the modules are in the same column; however, this is not a requirement as long as their relative position is maintained with respect to the HP 70900B local oscillator source search pattern.

<b>HP 70900B local oscillator source</b>	A single HP 70900B local oscillator source master module may control only 16 slave modules.
<b>HP 70902A IF section</b>	The HP 70902A IF section, if present, must be closest to the local oscillator (that is, the HP 70902A IF section should be immediately above the HP 70900B local oscillator source in the address map. It must be the first module that the HP 70900B local oscillator source finds when it searches the slave area.)
<b>HP 70911A WB IF section</b>	The HP 70911A WB IF section, if present, should be above the HP 70900B local oscillator source, HP 70902A IF section, and the HP 70700A digitizer. It should be below the HP 70903A IF section, HP 70907A/B external millimeter interface module, and the RF section. For cabling the HP 70911A WB IF section, refer to the <i>HP 71910A Wide Bandwidth Surveillance Receiver User's Guide</i> .
<b>HP 70700A digitizer</b>	When the HP 70700A digitizer is present and used as a slave to the HP 70900B local oscillator source, it should be addressed above the HP 70902A IF section (if present). It should also be addressed below the HP 70903A IF section (if present) and the HP 70911A WB IF section (if present).
<b>HP 70903A IF section</b>	The HP 70903A IF section, if present, should be above the HP 70902A IF section. It should be the next module that the HP 70900B local oscillator source finds when it searches the slave area. If the HP 70902A IF section is not present, the HP 70903A IF section should be above the local oscillator. If all three of the previously mentioned modules are present when the HP 70900B local oscillator source searches the slave area, it should find the HP 70902A IF section, then the HP 70700A digitizer, and then the HP 70903A IF section.
<b>HP 70907A/B external millimeter interface module</b>	An HP 70907A/B external millimeter interface module should be addressed immediately below the RF section. Multiple external mixer interface modules should follow each other in the addressing order.
<b>RF section</b>	Only one RF Section (HP 70904A RF section, HP 70905A/B RF section, HP 70906A/B RF section, HP 70908A RF section, HP 70909A RF section, or HP 70910A RF section) may be used with a single HP 70900B local oscillator source. The RF section should be immediately above the IF sections or external mixer interface module.
<b>HP 70600A preselector/ HP 70601A preselector</b>	The HP 70600A preselector/HP 70601A preselector, if present, should be immediately above the HP 70905A/B RF section or HP 70906A/B RF section. It should normally be the next module that the HP 70900B local oscillator source finds after the RF section when it searches the slave area.

**HP 70300A  
RF tracking generator**

The HP 70300A RF tracking generator should be addressed just above an HP 70301A microwave tracking generator, if one is present.

**HP 70301A microwave  
tracking generator**

The HP 70301A microwave tracking generator should be addressed just below an HP 70300A RF tracking generator, if one is present.

**HP 70310A precision  
frequency reference**

The HP 70310A precision frequency reference may be addressed anywhere.

**HP 70810B lightwave  
section**

The HP 70810B lightwave section should be addressed above the RF section. It should also be addressed above the preselector, if one is present.

**HP 70620A/B preamplifier  
or HP 70621A preamplifier**

The HP 70620A/B preamplifier or HP 70621A preamplifier should be addressed above the module that it is providing preamplification for. Multiple preamplifier modules may be used in the same system. When the HP 70900B local oscillator source searches its slave area, each preamplifier must be found above the module (for example, RF section, preselector, preamplifier) that its output is connected to.

## Row Addressing Priority

The row addressing priority for systems is shown below. Notice that this order is a *relative* row-address ranking only. The individual modules do not require consecutive row addresses (that is, there can be empty rows between modules). Also, note that all modules need not be in the same column. They need only fall in the slave area of the master module.

Highest row (last found):

HP 70620A/B preamplifier or HP 70621A preamplifier (only if preamplifying the lightwave section's input signal)

HP 70810B Option 850 lightwave section

HP 70810B lightwave section

HP 70310A precision frequency reference

HP 70300A RF tracking generator

HP 70301A microwave tracking generator

HP 70620A/B preamplifier or HP 70621A preamplifier (if preamplifying the preselector's or the RF section's input signal)

HP 70600A preselector or HP 70601A preselector

HP 70904A RF section, HP 70905A RF section, HP 70905B RF section HP 70906A RF section, HP 70906B RF section HP 70908A RF section, HP 70909A RF section, HP 70910A RF section (one only)

HP 70907A/B external millimeter interface module (several allowed)

HP 70903A IF section

HP 70911A WB IF section

HP 70700A digitizer

HP 70902A IF section

Lowest row (row 0):

HP 70900B local oscillator source

---

<b>Note</b>	HP-MSIB addresses must be unique. Setting two HP 70000 elements to the same address will create an error and make the local system bus (HP-MSIB) inoperative. If the cursor cannot be moved about within the address map after a module has been readdressed, check to see if two modules have the same row and column address.
-------------	---------------------------------------------------------------------------------------------------------------------------------------------------------------------------------------------------------------------------------------------------------------------------------------------------------------------------------

---

## Address Switches

The row and column address switches set the HP-MSIB address of a module; the column address switch also sets the HP-IB address for masters and independent elements.

To establish proper system function and HP-MSIB communication, each module has an address switch that is set to a binary, 8-bit HP-MSIB address. Each element in a system must be assigned a unique address. The row address of the HP-MSIB address is determined by three address bits, and the column address is determined by five address bits. Each system has 8 row and 32 column addresses. Address row 0, column 31 is an illegal address; therefore, 255 HP-MSIB addresses are available. The decimal equivalents of the binary row and column addresses are referred to throughout this manual. For example, see the table below.



	Row	Column
<b>Binary</b>	010	11000
<b>Decimal</b>	2	24

The following three sections describe the address switch functions for each of the elements and independent elements available.

- Master Address Switches
- Slave Address Switches
- Display Address Switches

The address switches may be found on the top, side, or rear of the modules, and at the rear of the HP 70004A color display and HP 70206A system graphics display. The location of address switches is defined in each element's installation and verification manual.

For system addressing and cable configuration examples, refer to "System Configurations for "A" and "C" Systems".

### Master Address Switches

The HP-MSIB column address is the same as the default HP-IB address of a master. It is defined by the position of the column address switches.

The HP-IB address of any master (for example, HP 70900B local oscillator source) can, under certain conditions, be set from the front panel of a display. At power-up, this address will override the actual address switch settings. For additional information on how to set the HP-IB address from the front panel, refer to *HP 70000 Modular Spectrum Analyzer Operating Manual*.

Figure 2-4 is an illustration of address switches found on an HP 70900B local oscillator source.

**HP-IB ON/OFF** With this switch set to off, the HP 70900B local oscillator source is switched off the HP-IB and uses only the HP-MSIB for communication.

**SW1/MEM** In the SW1 position, the HP-IB address is determined exclusively by the column address switches. In the MEM position, the HP-IB address is determined by HP 70900B local oscillator source memory and can be set from the front panel of the display. The HP 70900B local oscillator source is normally shipped with this switch in the MEM position.

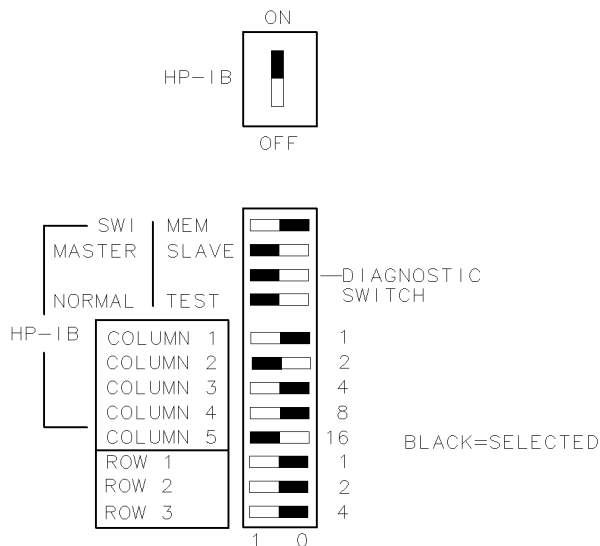

DUA36

**Figure 2-4. HP 70900B Local Oscillator Source Address Switch**

**MAS/SLA** With this set to the MAS position, the HP 70900B local oscillator source can function as a master or sub-master; with it set to the SLA position, the HP 70900B local oscillator source is a slave.

**NRML/TEST** This switch should be set to NRML for normal operation. The TEST position is used for a hard reset and during production.

**COLUMNS 1—5** These set the HP-MSIB column address, which is also the default HP-IB address.

**ROWS 1—3** These set the HP-MSIB row address.

### Slave Address Switches

Figure 2-5 is an illustration of typical address switches found on a slave element.

**Rows 1—3** These switches set the HP-MSIB row address.

**Columns 1—5** These switches set the HP-MSIB column address.

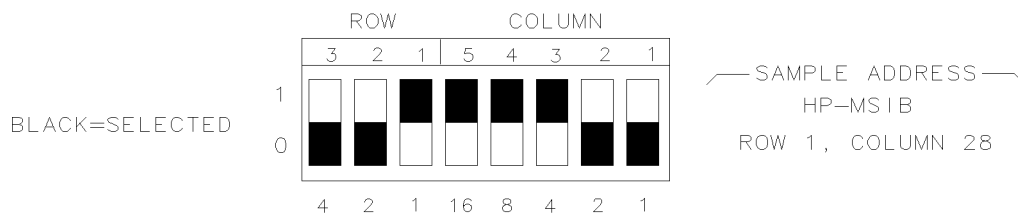

DUA37

**Figure 2-5. Slave Element Address Switches**

## Display Address Switches

A system graphics display is an example of an independent element. It may be assigned both HP-MSIB and HP-IB addresses. Figure 2-6 and Figure 2-7 illustrate the address switches of the HP 70206A system graphics display and HP 70004A color display. For more information on HP-MSIB and HP-IB addressing, refer to "Address Map Protocol".

- HP-IB ON/OFF** This switches the display on or off the HP-IB without disrupting instrument operation.
- A6—A8** The graphical representation of these switches indicates that the default HP-MSIB row address is 0.
- A1—A5** These address switches set the HP-MSIB column address, which is also the default HP-IB address. (This HP-IB address is overridden when the HP-IB address is set from the front panel.)
- TALK ONLY** When this is set to 1 (on) the display can talk on HP-IB without requiring a reply, since some plotters cannot reply. This switch is set to 0 (off) for normal operation.
- SYSTEM CONTROLLER** When this is set to 1 (on), the display functions as a system controller on HP-IB. This switch is set to 0 (off) at the factory.
- TEST MODE** When this is set to 1 (on), the display goes into a special test mode at power-up. This switch is set to 0 (off) for normal operation.

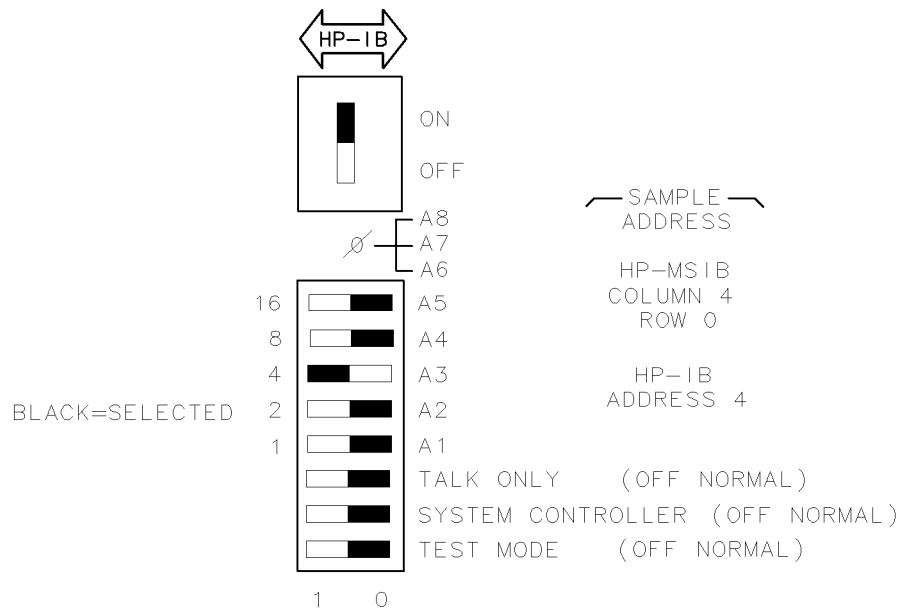
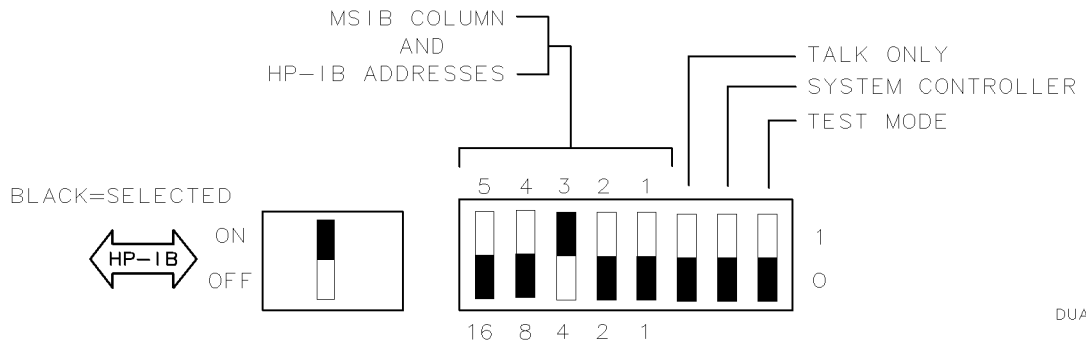

Figure 2-6. HP 70206A System Graphics Display Address Switches



DUA39

**Figure 2-7. HP 70004A Color Display Address Switches**

---

## Module Removal and Installation

The following procedure defines the steps in removing or installing modules.

### Module Removal

1. Set the HP 70004A color display/HP 70001A mainframe line switch to off. See Figure 2-8.
2. Remove the rear panel intermodule cables.
3. Open the HP 70004A color display/HP 70001A mainframe front panel door. With an 8 mm hex-ball driver, loosen the module hex-nut latch.
4. Press against the rear panel, and slide the module out.

### Installation

1. Set the HP 70004A color display/HP 70001A mainframe line switch to off.
2. Check the HP-MSIB address switch on the module for the correct address setting.
3. Open the HP 70004A color display/HP 70001A mainframe front panel door, and slide the module into the HP 70004A color display/HP 70001A mainframe.
4. Press against the module front panel while tightening the hex-nut latch with an 8 mm hex-ball driver.
5. Connect the rear panel intermodule cables as shown in the “System Configuration” examples.
6. Turn the HP 70004A color display/HP 70001A mainframe line switch on.

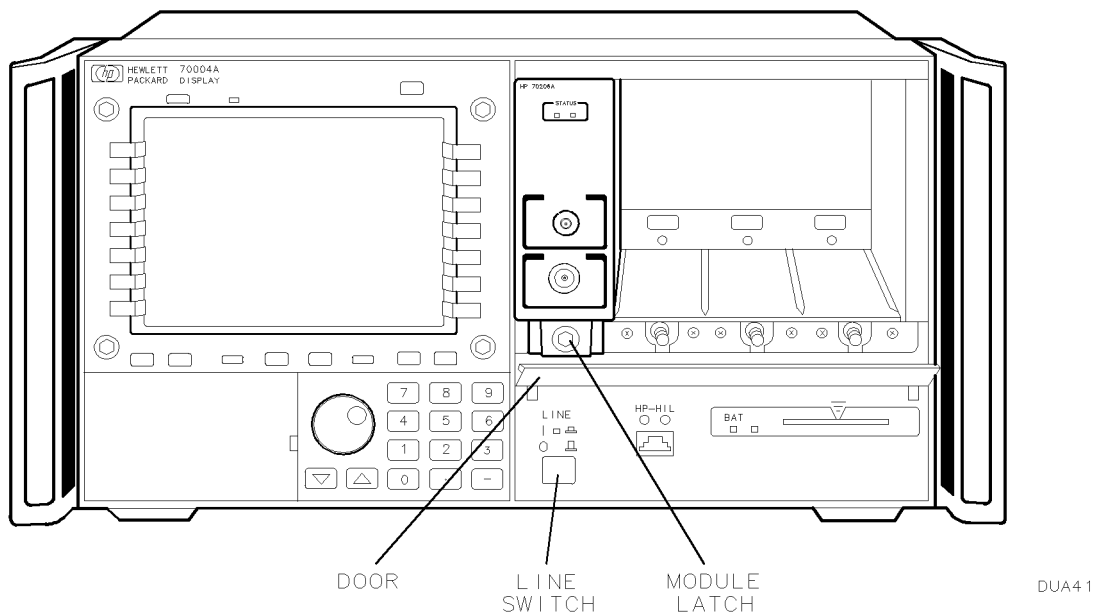

**Figure 2-8. Module Removal/Replacement**

---

**WARNING** If an instrument handle is damaged it should be replaced immediately. Damaged handles can break while the instrument is being moved or lifted. This may cause damage to the instrument or personal injury.

---

### Connecting the MSIB Cables on a “A” and “C” System

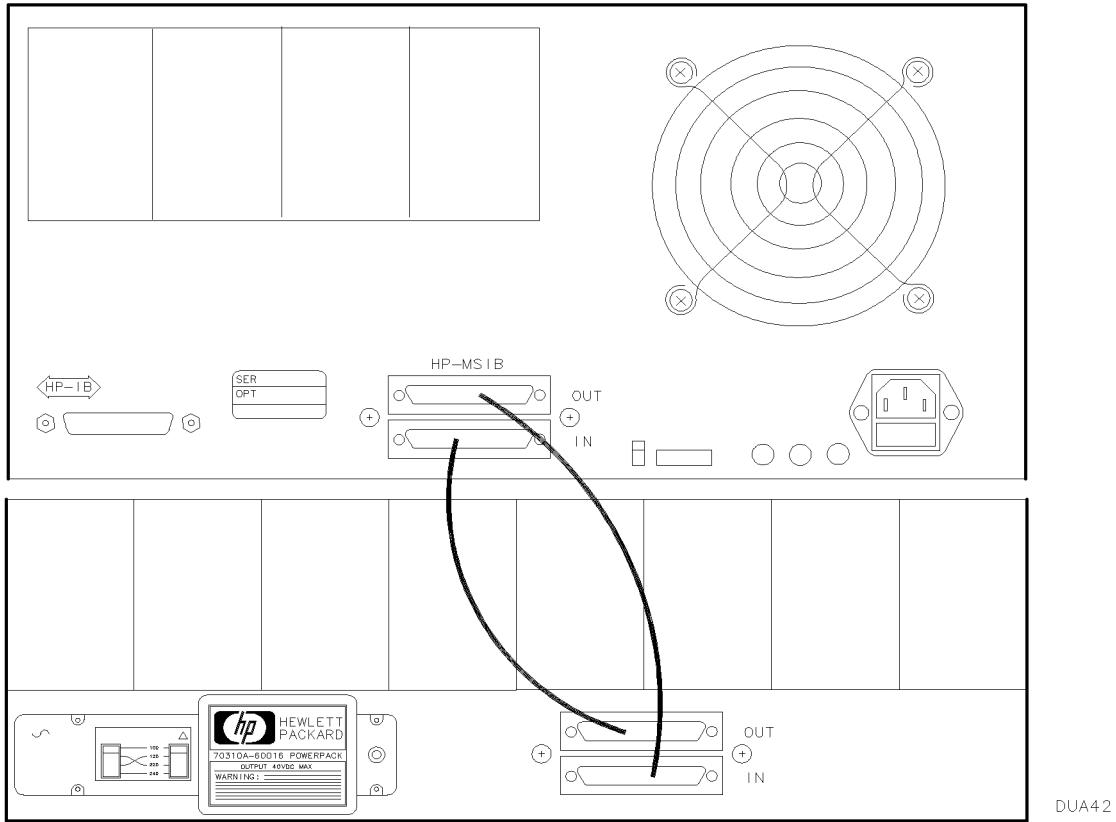
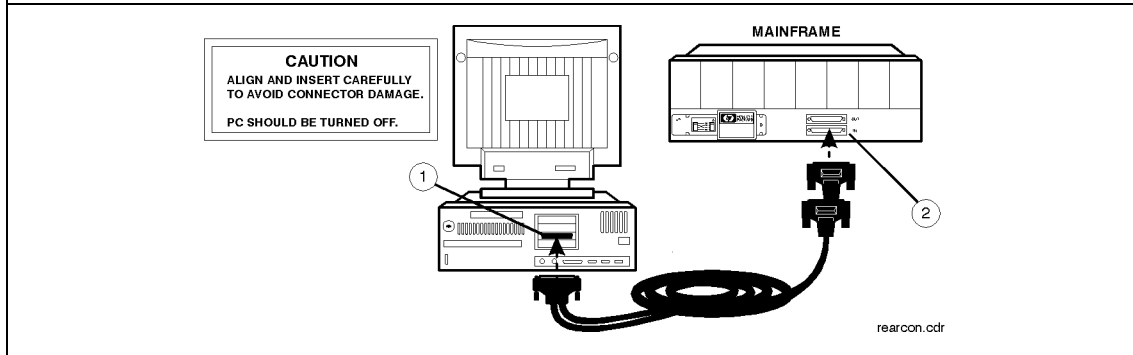

Figure 2-9. HP 70001A Mainframe to HP 70004A Color Display Cabling

## Connecting the MSIB Y-Cable on a “P” System

**CAUTION** Care should be taken when connecting the MSIB Y-cable to the MSIB interface card. Damage can occur if the MSIB Y-cable connection is not properly aligned. Ensure power is not applied while making or removing connections.

1. Remove the protective cap from the MSIB Y-cable and inspect the pins for damage or misalignment. **Do not install MSIB Y-cable if pins are bent or damaged.** If necessary, obtain service from Hewlett-Packard. Refer to “If You Need to Contact Hewlett-Packard” in Chapter 1.
2. Align the MSIB Y-cable to the MSIB interface card’s MSIB connector (1).  
**Do not force the connectors together!** (See the above caution.)
3. Tighten the captive-screws on the MSIB Y-cable to the MSIB interface card.  
**Do not over tighten the screws!**
4. Connect the two free-ends of the MSIB Y-cable (that are not connected to the MSIB interface card) to the HP 70001A mainframe’s IN and OUT MSIB connectors (2).  
  
The MSIB cables are connected serially, coupling the input of one HP 70001A mainframe to the output of the next until a loop is completed.
5. Connect the ac line cord to your computer and display.



**Note** Refer to the *HP 70207A User's Guide* for complete installation instructions of the HP 70207A PC Display for MMS, the MSIB interface card, and the MSIB Y-cable.

---

## System Configurations for “A” and “C” Systems

The figures in this section show the addressing order and cable connections for some common “A” and “C” system configurations. The following information is provided for each configuration.

- A sample address map screen illustrating the addressing order.
- A partial view of the system rear panel illustrating cable connections.
- Modules included in the system to ensure that needed elements are available.
- A list of rear panel cables describing type, quantity, and HP part numbers.
- A from-to list describing where to connect the cables and adapters.

These figures are examples. To address a system differently than shown, refer to “HP-MSIB/HP-IB Addressing”. Modules can be configured in any location, provided the cables are connected to the correct inputs and outputs. The suggested configurations are recommended for optimum instrument speed and minimum changes when adding modules. The system configuration examples provided in this section are listed below.



## “A” and “C” System Configuration Examples

### **HP 71100C modular spectrum analyzer:**

Standard	Figure 2-11
Standard with HP 70903A IF section added	Figure 2-13
Standard with HP 70700A digitizer added	Figure 2-15
Standard with HP 70903A IF section and HP 70700A digitizer added	Figure 2-17
Standard with HP 70300A RF tracking generator added	Figure 2-19

### **HP 71200C modular spectrum analyzer:**

Standard	Figure 2-21
Standard with HP 70903A IF section added	Figure 2-23
Standard deleting HP 70902A IF section, with HP 70903A IF section and HP 70907A external millimeter interface module (EMIM) added	Figure 2-25
Standard deleting HP 70905A RF section, with HP 70905B RF section and HP 70600A preselector added	Figure 2-27
Standard deleting HP 70905A RF section, with HP 70905B RF section, HP 70600A preselector and HP 70301A microwave tracking generator added	Figure 2-29

### **HP 71209A microwave spectrum analyzer:**

Standard	Figure 2-31
----------	-------------

### **HP 71210C microwave spectrum analyzer:**

Standard	Figure 2-33
----------	-------------

### **HP 71400C lightwave signal analyzer:**

Standard	Figure 2-35
Standard with HP 70300A RF tracking generator and HP 70301A microwave tracking generator added	Figure 2-37

### **HP 71401C lightwave signal analyzer:**

Standard	Figure 2-39
Standard with HP 70300A RF tracking generator added	Figure 2-41

## HP 71100C Modular Spectrum Analyzer

An HP 71100C modular spectrum analyzer consists of the following components:

HP 70001A mainframe	HP 70004A color display
HP 70900B local oscillator source	HP 70902A IF section (10 Hz – 300 KHz)
HP 70904A RF section (100 Hz – 2.9 GHz)	HP 70310A precision frequency reference

R O W	7			70310A P.F.R.	
	6		70904A RF SECT		
	5				
	4				
	3				
	2				
	1		70902A IF SECT		
	0		70900B LO/CTLR HP-IB 18		
		17	18	19	20
		COLUMN			

DUA4

**Figure 2-10. Address Map for HP 71100C Modular Spectrum Analyzer**

- The HP 70001A mainframe does not have an HP-MSIB address.
- The usual address for the HP 70004A color display is ROW 0, COLUMN 4.
- For information about software/firmware compatibility, refer to “Software/Hardware Compatibility” in Chapter 4.

To configure an HP 71100C modular spectrum analyzer, connect the rear panel cables according to the following table.

**CAUTION** To ensure proper electrical connection and prevent connector damage, all APC 3.5 and SMA connectors must be torqued 5 to 8 inch-pounds (finger tight). Do not exceed 8 inch-pounds.

From	To	Cable
<b>Flexible LO I/O Cables</b> HP 70900B LO OUT	HP 70904A 1st LO IN	HP 5061-9038 520 mm SMA(m) to SMA(m)
<b>Flexible System Cables</b> HP 70900B 300 MHz OUT 1 HP 70900B 100 MHz IN HP 70900B VIDEO IN HP 70904A 21.4 MHz OUT	HP 70904A 300 MHz IN HP 70310A 100 MHz HP 70902A VIDEO OUT HP 70902A 21.4 MHz IN	HP 8120-5022 365 mm SMB(f) to SMB(f) (6-slot) HP 8120-5022 365 mm SMB(f) to SMB(f) (6-slot) HP 8120-5016 160 mm SMB(f) to SMB(f) (2-slot) HP 8120-5022 365 mm SMB(f) to SMB(f) (6-slot)
<b>Miscellaneous Cables</b> HP 70001A HP-MSIB OUT HP 70004A HP-MSIB OUT	HP 70004A HP-MSIB IN HP 70001A HP-MSIB IN	HP 70800B 1.0 m MSIB cable HP 70800B 1.0 m MSIB cable
External Power Pack	HP 70310A EXT PWR	Built-in Power Pack Cable

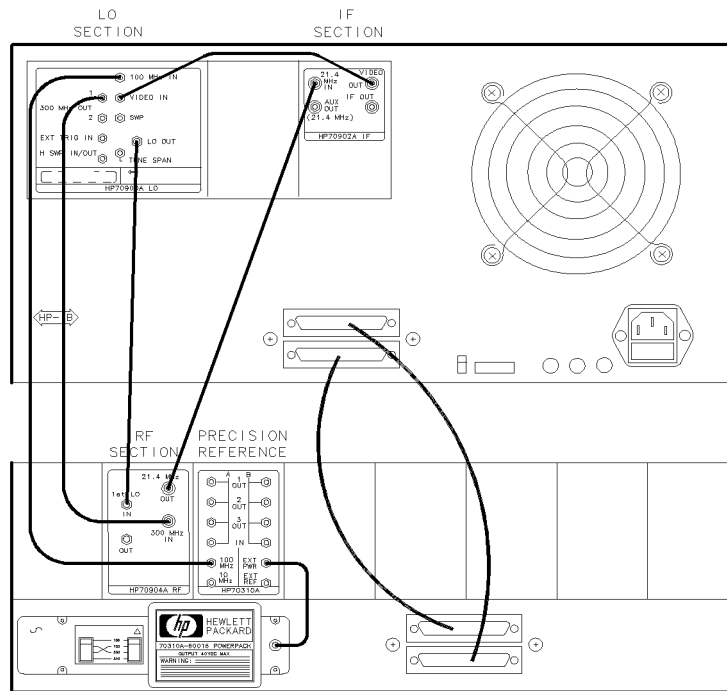

DUA3

Figure 2-11. HP 71100C Modular Spectrum Analyzer Rear Panel Cabling

## HP 71100C Modular Spectrum Analyzer with HP 70903A IF Section

An HP 71100C modular spectrum analyzer with HP 70903A IF section, consists of the following components:

HP 70001A mainframe	HP 70004A color display
HP 70900B local oscillator source	HP 70903A IF section (100 KHz – 3 MHz)
HP 70902A IF section (10 Hz – 300 KHz)	HP 70310A precision frequency reference
HP 70904A RF section (100 Hz – 2.9 GHz)	

R O W	7		70310A P.F.R.		
	6	70904A RF SECT			
	5				
	4	70903A IF SECT			
	3				
	2				
	1	70902A IF SECT			
	0	70900B LO/CTLR HP-IB 18			
		17	18	19	20
		COLUMN			

DUA6

**Figure 2-12.**

### Address Map for HP 71100C Modular Spectrum Analyzer with HP 70903A IF Section

- The HP 70001A mainframe does not have an HP-MSIB address.
- The usual address for the HP 70004A color display is ROW 0, COLUMN 4.
- For information about software/firmware compatibility, refer to “Software/Hardware Compatibility” in Chapter 4.

To configure an HP 71100C modular spectrum analyzer with HP 70903A IF section, connect the rear panel cables according to the following table.

**CAUTION** To ensure proper electrical connection and prevent connector damage, all APC 3.5 and SMA connectors must be torqued 5 to 8 inch-pounds (finger tight). Do not exceed 8 inch-pounds.

From	To	Cable
<b>Flexible LO I/O Cables</b> HP 70900B LO OUT	HP 70904A 1st LO IN	HP 5061-9038 520 mm SMA(m) to SMA(m)
<b>Flexible System Cables</b> HP 70900B 300 MHz OUT 1 HP 70900B 100 MHz IN HP 70900B VIDEO IN HP 70904A 21.4 MHz OUT HP 70902A 21.4 MHz IN HP 70902A VIDEO OUT	HP 70904A 300 MHz IN HP 70310A 100 MHz HP 70903A VIDEO OUT HP 70903A 21.4 MHz IN HP 70903A 21.4 MHz OUT HP 70903A VIDEO IN	HP 8120-5022 365 mm SMB(f) to SMB(f) (6-slot) HP 8120-5022 365 mm SMB(f) to SMB(f) (6-slot) HP 8120-5016 160 mm SMB(f) to SMB(f) (2-slot) HP 8120-5022 365 mm SMB(f) to SMB(f) (6-slot) HP 8120-5014 100 mm SMB(f) to SMB(f) (1-slot) HP 8120-5014 100 mm SMB(f) to SMB(f) (1-slot)
<b>Miscellaneous Cables</b> HP 70001A HP-MSIB OUT HP 70004A HP-MSIB OUT External Power Pack	HP 70004A HP-MSIB IN HP 70001A HP-MSIB IN HP 70310A EXT PWR	HP 70800B 1.0 m MSIB cable HP 70800B 1.0 m MSIB cable Built-in Power Pack Cable

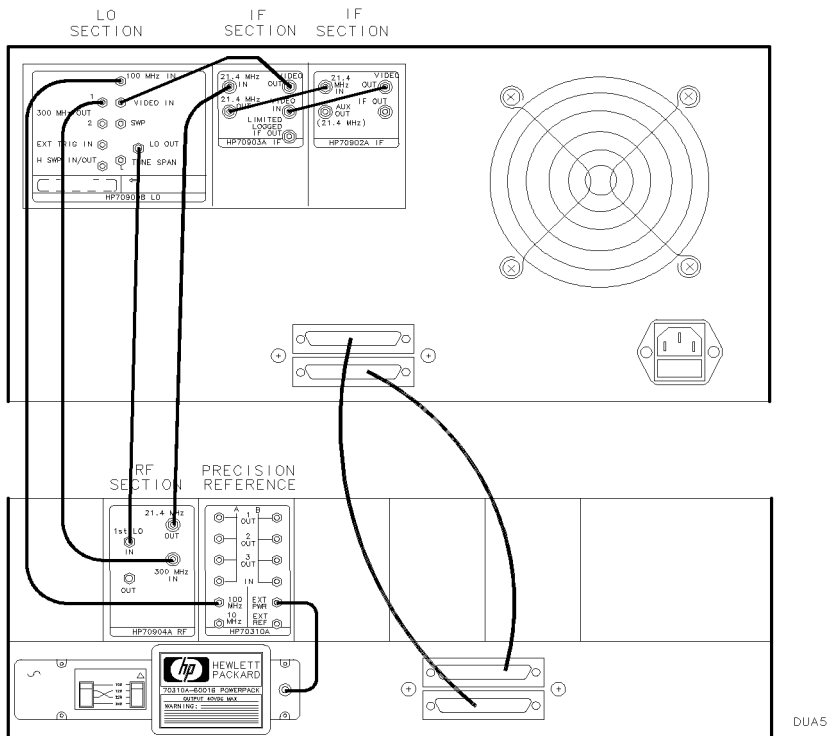

Figure 2-13.

HP 71100C Modular Spectrum Analyzer Rear Panel Cabling with HP 70903A IF Section

## HP 71100C Modular Spectrum Analyzer with HP 70700A Digitizer

An HP 71100C modular spectrum analyzer with HP 70700A digitizer consists of the following components:

HP 70001A mainframe	HP 70004A color display
HP 70900B local oscillator source	HP 70902A IF section (10 Hz - 300 KHz)
HP 70904A RF section (100 Hz - 2.9 GHz)	HP 70310A precision frequency reference
HP 70700A digitizer	

R O W	7		70310A P.F.R.		
	6	70904A RF SECT			
	5				
	4				
	3				
	2	70700A DIGITIZER			
	1	70902A IF SECT			
	0	70900B LO/CTLR HP-IB 18			
		17	18	19	20
		COLUMN			

DUAS

**Figure 2-14.**

### Address Map for HP 71100C Modular Spectrum Analyzer with HP 70700A Digitizer

- The HP 70001A mainframe does not have an HP-MSIB address.
- The usual address for the HP 70004A color display is ROW 0, COLUMN 4.
- For information about software/firmware compatibility, refer to “Software/Hardware Compatibility” in Chapter 4.

To configure an HP 71100C modular spectrum analyzer with HP 70700A digitizer as a slave, connect the rear panel cables according the following table. Note that the HP-IB switch on the HP 70700A digitizer must be in the off position.

**CAUTION** To ensure proper electrical connection and prevent connector damage, all APC 3.5 and SMA connectors must be torqued 5 to 8 inch-pounds (finger tight). Do not exceed 8 inch-pounds.

From	To	Cable
<b>Flexible LO I/O Cables</b> HP 70900B LO OUT	HP 70904A 1st LO IN	HP 5061-9038 520 mm SMA(m) to SMA(m)
<b>Flexible System Cables</b> HP 70900B 300 MHZ OUT 1 HP 70900B 100 MHZ IN HP 70904A 21.4 MHz OUT HP 70900B VIDEO IN * HP 70700A INPUT 2 HP 70900B HSWP IN/OUT * HP 70700A HI SWP HP 70700A CLK IN	HP 70904A 300 MHZ IN HP 70310A 100 MHZ HP 70902A 21.4 MHz IN * HP 70700A INPUT 2 HP 70902A VIDEO OUT * HP 70700A HI SWP HP 70700A EXT TRIG HP 70700A CLK OUT	HP 8120-5022 365 mm SMB(f) to SMB(f) (6-slot) HP 8120-5022 365 mm SMB(f) to SMB(f) (6-slot) HP 8120-5022 365 mm SMB(f) to SMB(f) (6-slot) HP 8120-5016 160 mm SMB(f) to SMB(f) (2-slot) HP 8120-5014 100 mm SMB(f) to SMB(f) (1-slot) HP 8120-5016 160 mm SMB(f) to SMB(f) (2-slot) HP 8120-5014 100 mm SMB(f) to SMB(f) (1-slot) HP 8120-5014 100 mm SMB(f) to SMB(f) (1-slot)
<b>Miscellaneous Cables</b> HP 70001A HP-MSIB OUT HP 70004A HP-MSIB OUT	HP 70004A HP-MSIB IN HP 70001A HP-MSIB IN	HP 70800B 1.0 m MSIB cable HP 70800B 1.0 m MSIB cable
External Power Pack	HP 70310A EXT PWR	Built-in Power Pack Cable

\* On this connector, use an HP 1250-1391 50Ω SMB tee(f) (m) (m) adapter.

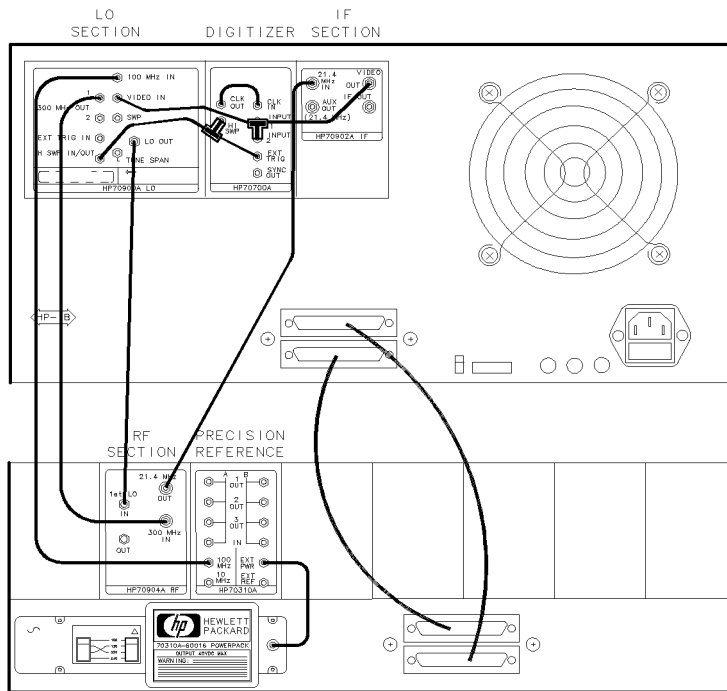

DUA7

**Figure 2-15.**  
**HP 71100C Modular Spectrum Analyzer Rear Panel Cabling with HP 70700A Digitizer**

## HP 71100C Modular Spectrum Analyzer with HP 70903A IF Section and HP 70700A Digitizer

An HP 71100C modular spectrum analyzer with HP 70903A IF section and HP 70700A digitizer consists of the following components:

HP 70001A mainframe	HP 70004A color display
HP 70900B local oscillator source	HP 70902A IF section (10 Hz – 300 KHz)
HP 70903A IF section (100 KHz – 3 MHz)	HP 70904A RF section (100 Hz – 2.9 GHz)
HP 70310A precision frequency reference	HP 70700A digitizer

R O W	7		70310A P.F.R.		
	6		70904A RF SECT		
	5				
	4		70903A IF SECT		
	3				
	2		70700A DIGITIZER		
	1		70902A IF SECT		
	0		70900B LO/CTLR HP-IB 18		
		17	18	19	20
		COLUMN			

DUA10

**Figure 2-16.**

### Address Map for HP 71100C Modular Spectrum Analyzer with HP 70903A IF Section and HP 70700A Digitizer

- The HP 70001A mainframe does not have an HP-MSIB address.
- The usual address for the HP 70004A color display is ROW 0, COLUMN 4.
- For information about software/firmware compatibility, refer to “Software/Hardware Compatibility” in Chapter 4.

To configure an HP 71100C modular spectrum analyzer with HP 70903A IF section and HP 70700A digitizer as a slave, connect the rear panel cables according to the following table. Note that the HP-IB switch on the HP 70700A digitizer should be in the off position.

---

**CAUTION** To ensure proper electrical connection and prevent connector damage, all APC 3.5 and SMA connectors must be torqued 5 to 8 inch-pounds (finger tight). Do not exceed 8 inch-pounds (finger tight).

---



From	To	Cable
<b>Flexible LO I/O Cables</b> HP 70900B LO OUT	HP 70904A 1st LO IN	HP 5061-9038 520 mm SMA(m) to SMA(m)
<b>Flexible System Cables</b> HP 70900B 300 MHz OUT 1	HP 70904A 300 MHz IN	HP 8120-5022 365 mm SMB(f) to SMB(f) (6-slot)
HP 70900B 100 MHz IN	HP 70310A 100 MHz	HP 8120-5022 365 mm SMB(f) to SMB(f) (6-slot)
HP 70900B VIDEO IN	* HP 70700A INPUT 2	HP 8120-5016 160 mm SMB(f) to SMB(f) (2-slot)
* HP 70700A INPUT 2	HP 70903A VIDEO OUT	HP 8120-5021 310 mm SMB(f) to SMB(f) (5-slot)
HP 70900B HSWP IN/OUT	* HP 70700A HI SWP	HP 8120-5016 160 mm SMB(f) to SMB(f) (2-slot)
* HP 70700A HI SWP	HP 70700A EXT TRIG	HP 8120-5014 100 mm SMB(f) to SMB(f) (1-slot)
HP 70904A 21.4 MHz OUT	HP 70903A 21.4 MHz IN	HP 8120-5016 160 mm SMB(f) to SMB(f) (2-slot)
HP 70902A VIDEO OUT	HP 70903A VIDEO IN	HP 8120-5014 100 mm SMB(f) to SMB(f) (1-slot)
HP 70902A 21.4 MHz IN	HP 70903A 21.4 MHz OUT	HP 8120-5014 100 mm SMB(f) to SMB(f) (1-slot)
HP 70700A CLK IN	HP 70700A CLK OUT	HP 8120-5014 100 mm SMB(f) to SMB(f) (1-slot)
<b>Miscellaneous Cables</b> HP 70001A HP-MSIB OUT	HP 70004A HP-MSIB IN	HP 70800B 1.0 m MSIB cable
HP 70004A HP-MSIB OUT	HP 70001A HP-MSIB IN	HP 70800B 1.0 m MSIB cable
External Power Pack	HP 70310A EXT PWR	Built-in Power Pack Cable

\* On this connector, use an HP 1250-1391 50Ω SMB tee(f) (m) (m) adapter.

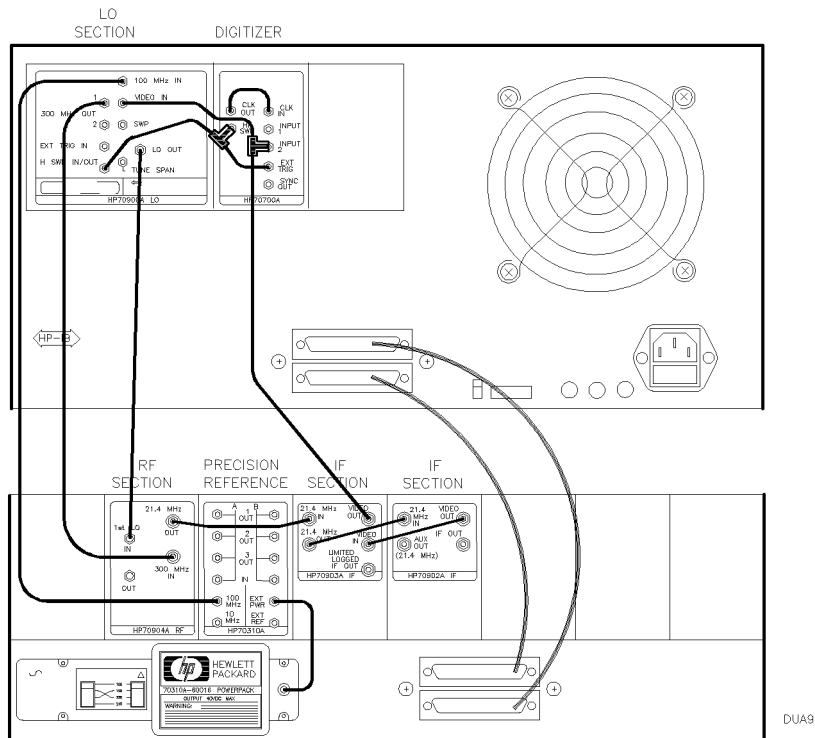

**Figure 2-17.**  
**HP 71100C Modular Spectrum Analyzer Rear Panel Cabling with HP 70903A IF Section and HP 70700A Digitizer**

## HP 71100C Modular Spectrum Analyzer with HP 70300A RF Tracking Generator

An HP 71100C modular spectrum analyzer with an HP 70300A RF tracking generator consists of the following components:

HP 70001A mainframe	HP 70004A color display
HP 70900B local oscillator source	HP 70902A IF section (10 Hz – 300 KHz)
HP 70904A RF section (100 Hz – 2.9 GHz)	HP 70310A precision frequency reference
HP 70300A RF tracking generator	

R O W	7		70310A P.F.R.		
	6	70904A RF SECT	70300A RFTrckG		
	5				
	4				
	3				
	2				
	1	70902A IF SECT			
	0	70900B LO/CTLR HP-IB 18			
		17	18	19	20
		COLUMN			

DUA12

**Figure 2-18.**  
**Address Map for HP 71100C Modular Spectrum Analyzer with HP 70300A RF Tracking Generator**

- The HP 70001A mainframe does not have an HP-MSIB address.
- The usual address for the HP 70004A color display is ROW 0, COLUMN 4.
- For information about software/firmware compatibility, refer to “Software/Hardware Compatibility” in Chapter 4.

To configure an HP 71100C modular spectrum analyzer with an HP 70300A RF tracking generator, connect the rear panel cables according to the following table.

---

**CAUTION** To ensure proper electrical connection and prevent connector damage, all APC 3.5 and SMA connectors must be torqued 5 to 8 inch-pounds (finger tight). Do not exceed 8 inch-pounds.

---

From	To	Cable
<b>Flexible LO I/O Cables</b> HP 70900B LO OUT	HP 70904A 1st LO IN	HP 5061-9038 520 mm SMA(m) to SMA(m)
<b>Flexible System Cables</b> HP 70900B 300 MHZ OUT 1	HP 70904A 300 MHZ IN	HP 8120-5022 365 mm SMB(f) to SMB(f) (6-slot)
HP 70900B 300 MHZ OUT 2	HP 70300A 300 MHZ IN	HP 8120-5025 490 mm SMB(f) to SMB(f)
HP 70900B 100 MHZ IN	HP 70310A 100 MHZ	HP 8120-5022 365 mm SMB(f) to SMB(f) (6-slot)
HP 70900B TUNE SPAN	HP 70300A TUNE + SPAN	HP 8120-5025 490 mm SMB(f) to SMB(f)
HP 70900B SWEEP	HP 70300A SWEEP IN	HP 8120-5025 490 mm SMB(f) to SMB(f)
HP 70900B VIDEO IN	HP 70902A VIDEO OUT	HP 8120-5016 160 mm SMB(f) to SMB(f) (2-slot)
HP 70904A 21.4 MHz OUT	HP 70902A 21.4 MHz IN	HP 8120-5022 365 mm SMB(f) to SMB(f) (6-slot)
HP 70900B HSWP IN/OUT	HP 70300A RF tracking generator HSWP IN	HP 8120-5025 490 mm SMB(f) to SMB(f)
<b>Miscellaneous Cables</b> HP 70904A 1st LO OUT	HP 70300A LO IN	HP 5021-5495 400 mm SMA(m) to SMA(m)
HP 70300A 0-2.9 GHZ OUT	HP 70300A 0-2.9 GHZ IN	HP 70300-20067 380 mm SMA(m) to SMA(m)
HP 70001A HP-MSIB OUT	HP 70004A HP-MSIB IN	HP 70800B 1.0 m MSIB cable
HP 70004A HP-MSIB OUT	HP 70001A HP-MSIB IN	HP 70800B 1.0 m MSIB cable
External Power Pack	HP 70310A EXT PWR	Built-in Power Pack Cable

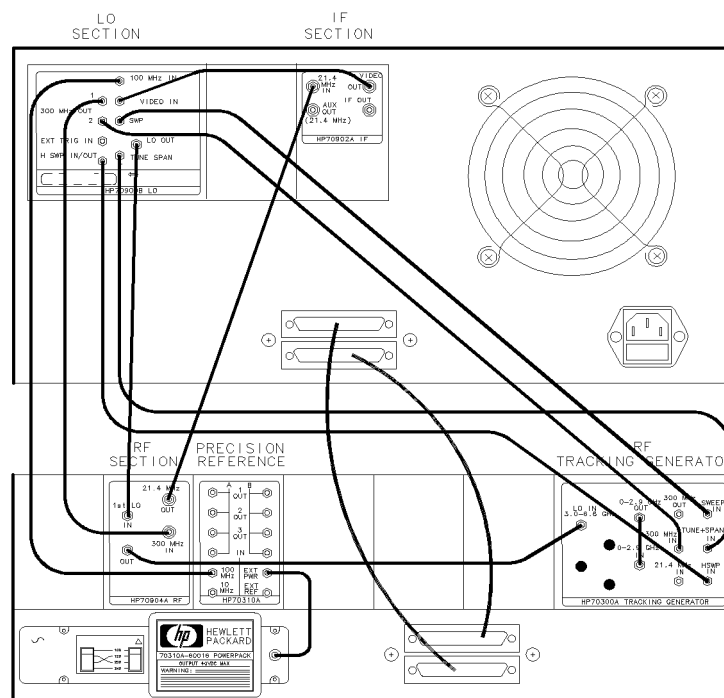

DUA 11

**Figure 2-19.**  
**HP 71100C Modular Spectrum Analyzer Rear Panel Cabling with an HP 70300A RF Tracking Generator**

## HP 71200C Modular Spectrum Analyzer

An HP 71200C modular spectrum analyzer consists of the following components:

HP 70001A mainframe	HP 70004A color display
HP 70900B local oscillator source	HP 70902A IF section (10 Hz – 300 KHz)
HP 70905A RF section (50 KHz – 22 GHz)	HP 70310A precision frequency reference

R O W	7		70310A P.F.R.		
	6	70905A RF SECT			
	5				
	4				
	3				
	2				
	1	70902A IF SECT			
	0	70900B LO/CTLR HP-IB 18			
		17	18	19	20
		COLUMN			

DUA14

**Figure 2-20. Address Map for HP 71200C Modular Spectrum Analyzer**

- The HP 70001A mainframe does not have an HP-MSIB address.
- The usual address for the HP 70004A color display is ROW 0, COLUMN 4.
- For information about software/firmware compatibility, refer to “Software/Hardware Compatibility” in Chapter 4.

To configure an HP 71200C modular spectrum analyzer, connect the rear panel cables according to the following table.

**CAUTION** To ensure proper electrical connection and prevent connector damage, all APC 3.5 and SMA connectors must be torqued 5 to 8 inch-pounds (finger tight). Do not exceed 8 inch-pounds.

From	To	Cable
<b>Flexible LO I/O Cables</b> HP 70900B LO OUT	HP 70905A 1st LO IN	HP 5061-9038 520 mm SMA(m) to SMA(m)
<b>Flexible System Cables</b> HP 70900B 300 MHz OUT 1 HP 70900B 100 MHz IN HP 70900B VIDEO IN HP 70905A 21.4 MHz OUT	HP 70905A 300 MHz IN HP 70310A 100 MHz HP 70902A VIDEO OUT HP 70902A 21.4 MHz IN	HP 8120-5022 365 mm SMB(f) to SMB(f) (6-slot) HP 8120-5022 365 mm SMB(f) to SMB(f) (6-slot) HP 8120-5016 160 mm SMB(f) to SMB(f) (2-slot) HP 8120-5022 365 mm SMB(f) to SMB(f) (6-slot)
<b>Miscellaneous Cables</b> HP 70905A 321.4 MHz OUT HP 70001A HP-MSIB OUT HP 70004A HP-MSIB OUT External Power Pack	HP 70905A 321.4 MHz IN HP 70004A HP-MSIB IN HP 70001A HP-MSIB IN HP 70310A EXT PWR	HP 70905-20024 55 mm SMA(m) to SMA(m) HP 70800B 1.0 m MSIB cable HP 70800B 1.0 m MSIB cable Built-in Power Pack Cable

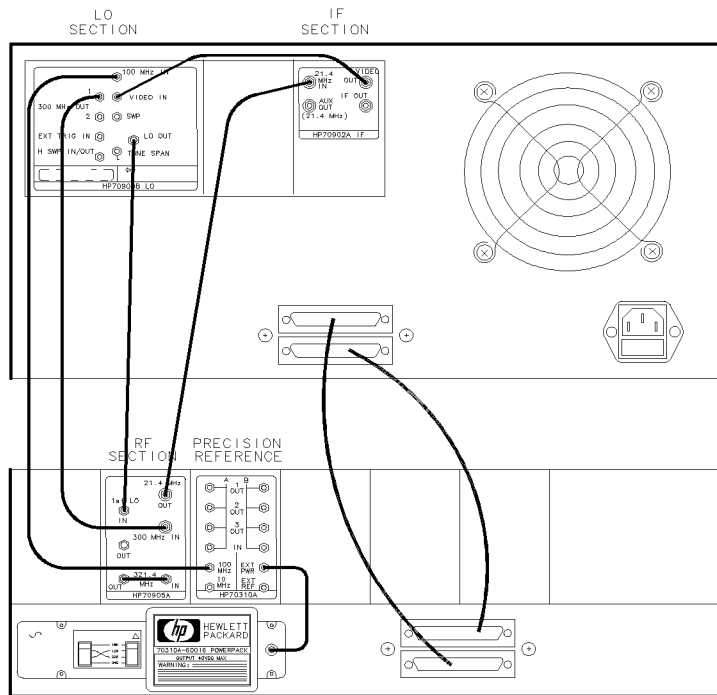

DUA13

Figure 2-21. HP 71200C Modular Spectrum Analyzer Rear Panel Cabling

## HP 71200C Modular Spectrum Analyzer with HP 70903A IF Section

An HP 71200C modular spectrum analyzer with HP 70903A IF section, consists of the following components:

HP 70001A mainframe	HP 70004A color display
HP 70900B local oscillator source	HP 70902A IF section (10 Hz – 300 KHz)
HP 70903A IF section (100 KHz – 3 MHz)	HP 70905A RF section (50 KHz – 22 GHz)
HP 70310A precision frequency reference	

R O W	7		70310A P.F.R.		
	6	70905A RF SECT			
	5				
	4	70903A IF SECT			
	3				
	2				
	1	70902A IF SECT			
	0	70900B LO/CTLR HP-IB 18			
		17	18	19	20
		COLUMN			

DUA16

**Figure 2-22.**

### Address Map for HP 71200C Modular Spectrum Analyzer with HP 70903A IF Section

- The HP 70001A mainframe does not have an HP-MSIB address.
- The usual address for the HP 70004A color display is ROW 0, COLUMN 4.
- For information about software/firmware compatibility, refer to “Software/Hardware Compatibility” in Chapter 4.

To configure an HP 71200C modular spectrum analyzer with an HP 70903A IF section, connect the rear panel cables according to the following table.

**CAUTION** To ensure proper electrical connection and prevent connector damage, all APC 3.5 and SMA connectors must be torqued 5 to 8 inch-pounds (finger tight). Do not exceed 8 inch-pounds.

From	To	Cable
<b>Flexible LO I/O Cables</b> HP 70900B LO OUT	HP 70905A 1st LO IN	HP 5061-9038 520 mm SMA(m) to SMA(m)
<b>Flexible System Cables</b> HP 70900B 300 MHz OUT 1 HP 70900B 100 MHz IN HP 70900B VIDEO IN HP 70905A 21.4 MHz OUT HP 70902A VIDEO OUT HP 70902A 21.4 MHz IN	HP 70905A 300 MHz IN HP 70310A 100 MHz HP 70903A VIDEO OUT HP 70903A 21.4 MHz IN HP 70903A VIDEO IN HP 70903A 21.4 MHz OUT	HP 8120-5022 365 mm SMB(f) to SMB(f) (6-slot) HP 8120-5022 365 mm SMB(f) to SMB(f) (6-slot) HP 8120-5016 160 mm SMB(f) to SMB(f) (2-slot) HP 8120-5022 365 mm SMB(f) to SMB(f) (6-slot) HP 8120-5014 100 mm SMB(f) to SMB(f) (1-slot) HP 8120-5014 100 mm SMB(f) to SMB(f) (1-slot)
<b>Miscellaneous Cables</b> HP 70905A 321.4 MHz OUT HP 70001A HP-MSIB OUT HP 70004A HP-MSIB OUT	HP 70905A 321.4 MHz IN HP 70004A HP-MSIB IN HP 70001A HP-MSIB IN	HP 70905-20024 55 mm SMA(m) to SMA(m) HP 70800B 1.0 m MSIB cable HP 70800B 1.0 m MSIB cable
External Power Pack	HP 70310A EXT PWR	Built-in Power Pack Cable

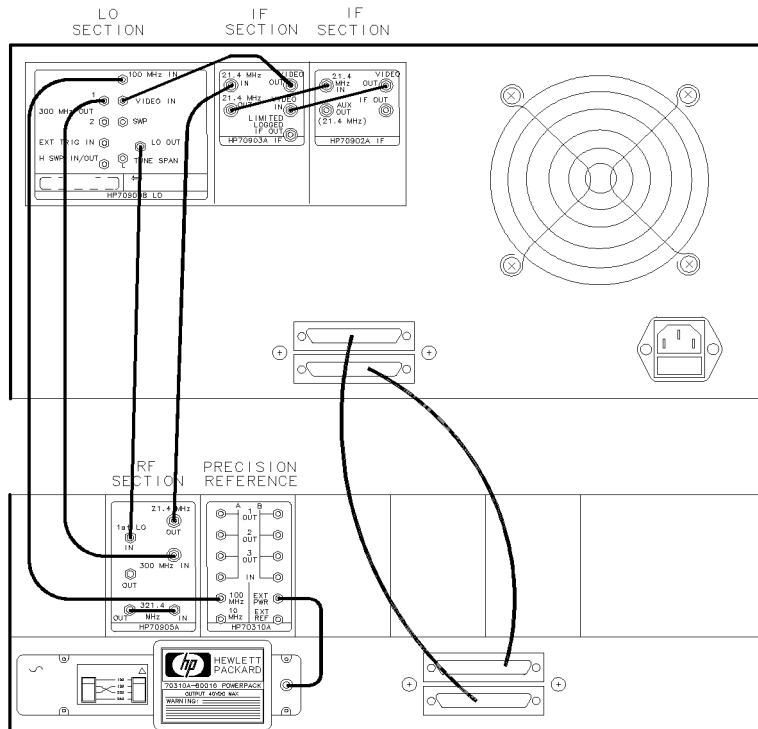

DUA15

**Figure 2-23.**  
**HP 71200C Modular Spectrum Analyzer Rear Panel Cabling with HP 70903A IF Section**

## HP 71200C Modular Spectrum Analyzer Deleting HP 70902A IF Section, with HP 70903A IF Section and HP 70907B External Millimeter Interface Module

An HP 71200C modular spectrum analyzer deleting HP 70902A IF section, with HP 70903A IF section and HP 70907B external millimeter interface module consists of the following components:

HP 70001A mainframe	HP 70004A color display
HP 70900B local oscillator source	HP 70903A IF section (100 KHz – 3 MHz)
HP 70905A RF section (50 KHz – 22 GHz)	HP 70310A precision frequency reference
HP 70907B external millimeter interface module	

R O W	7		70310A P.F.R.		
	6	70905A RF SECT			
	5	70907B EMIM			
	4	70903A IF SECT			
	3				
	2				
	1				
	0	70900B LO/CTLR HP-IB 18			
		17	18	19	20
		COLUMN			

DUA18

**Figure 2-24.**

### Address Map for HP 71200C Modular Spectrum Analyzer Deleting HP 70902A IF Section, with HP 70903A IF Section and HP 70907B External Millimeter Interface Module

- The HP 70001A mainframe does not have an HP-MSIB address.
- The usual address for the HP 70004A color display is ROW 0, COLUMN 4.
- For information about software/firmware compatibility, refer to “Software/Hardware Compatibility” in Chapter 4.

To configure an HP 71200C modular spectrum analyzer deleting HP 70902A IF section, with HP 70903A IF section and HP 70907B external millimeter interface module connect the rear panel cables according to the following table.

---

**CAUTION** To ensure proper electrical connection and prevent connector damage, all APC 3.5 and SMA connectors must be torqued 5 to 8 inch-pounds (finger tight). Do not exceed 8 inch-pounds.

---



From	To	Cable
<b>Flexible LO I/O Cables</b>		
HP 70900B LO OUT	HP 70905A 1st LO IN	HP 5061-9038 520 mm SMA(m) to SMA(m)
HP 70905A 1ST LO OUT	HP 70907B LO IN	HP 5021-5448 150 mm SMA(m) to SMA(m)
<b>Flexible System Cables</b>		
HP 70900B 300 MHZ OUT 1	HP 70905A 300 MHZ IN	HP 8120-5022 365 mm SMB(f) to SMB(f) (6-slot)
HP 70900B 100 MHZ IN	HP 70310A 100 MHZ	HP 8120-5022 365 mm SMB(f) to SMB(f) (6-slot)
HP 70900B VIDEO IN	HP 70903A VIDEO OUT	HP 8120-5016 160 mm SMB(f) to SMB(f) (2-slot)
HP 70905A 21.4 MHz OUT	HP 70907B 21.4 MHz IN	HP 8120-5016 160 mm SMB(f) to SMB(f) (2-slot)
HP 70900B 300 MHZ OUT 2	HP 70907B 300 MHZ IN	HP 8120-5022 365 mm SMB(f) to SMB(f) (6-slot)
HP 70907B 21.4 MHz OUT	HP 70903A 21.4 MHz IN	HP 8120-5022 365 mm SMB(f) to SMB(f) (6-slot)
HP 70900B TUNE SPAN	HP 70907B TUNE SPAN	HP 8120-5022 365 mm SMB(f) to SMB(f) (6-slot)
<b>Miscellaneous Cables</b>		
HP 70905A 321.4 MHz OUT	HP 70905A 321.4 MHz IN	HP 70905-20024 55 mm SMA(m) to SMA(m)
HP 70001A HP-MSIB OUT	HP 70004A HP-MSIB IN	HP 70800B 1.0 m MSIB cable
HP 70004A HP-MSIB OUT	HP 70001A HP-MSIB IN	HP 70800B 1.0 m MSIB cable
External Power Pack	HP 70310A EXT PWR	Built-in Power Pack Cable

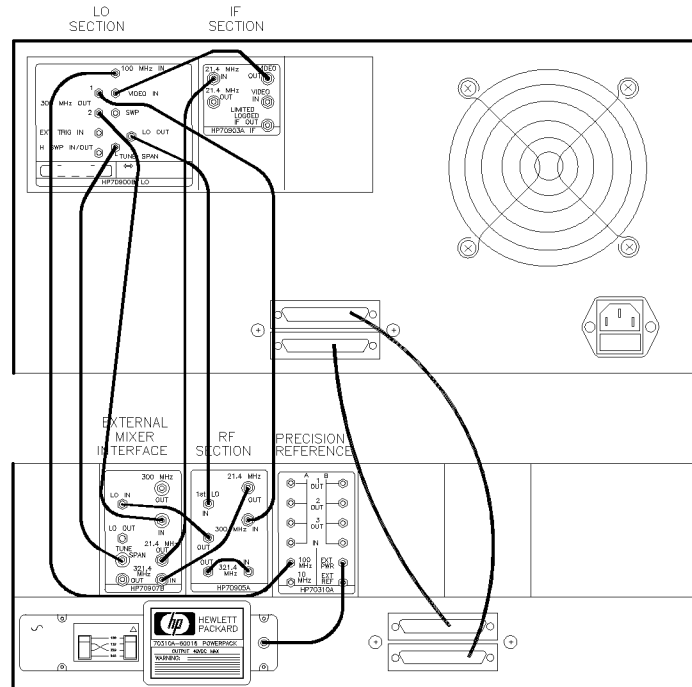

DUA17

**Figure 2-25.**  
**HP 71200C Modular Spectrum Analyzer Deleting HP 70902A IF Section, with HP 70903A IF Section and HP 70907B External Millimeter Interface Module Cabling**

**HP 71200C Modular Spectrum Analyzer Deleting HP 70905A RF Section, with HP 70905B RF Section/HP 70600A Preselector**

An HP 71200C modular spectrum analyzer deleting HP 70905A RF section, with HP 70905B RF section/HP 70600A preselector consists of the following components:

- HP 70001A mainframe
- HP 70900B local oscillator source
- HP 70905B RF section (50 KHz - 22 GHz)
- HP 70310A precision frequency reference
- HP 70004A color display
- HP 70902A IF section (10 Hz - 300 KHz)
- HP 70600A preselector

R O W	7		70310A P.F.R.		
	6	70905B RF SECT			
	5				
	4				
	3				
	2		70600A PRE SEL		
	1	70902A IF SECT			
	0	70900B LO/CTLR HP-IB 18			
		17	18	19	20
		COLUMN			

DUA20

**Figure 2-26.**

**Address Map for HP 71200C Modular Spectrum Analyzer Deleting HP 70905A RF Section, with HP 70905B RF Section/HP 70600A Preselector**

- The HP 70001A mainframe does not have an HP-MSIB address.
- The usual address for the HP 70004A color display is ROW 0, COLUMN 4.
- For information about software/firmware compatibility, refer to “Software/Hardware Compatibility” in Chapter 4.

To configure an HP 71200C modular spectrum analyzer deleting HP 70905A RF section, with HP 70905B RF section/HP 70600A preselector connect the rear panel cables according to the following table.

**CAUTION** To ensure proper electrical connection and prevent connector damage, all APC 3.5 and SMA connectors must be torqued 5 to 8 inch-pounds (finger tight). Do not exceed 8 inch-pounds.

From	To	Cable
<b>Flexible LO I/O Cables</b> HP 70900B LO OUT	HP 70905A 1st LO IN	HP 5061-9038 520 mm SMA(m) to SMA(m)
<b>Flexible System Cables</b> HP 70900B 300 MHz OUT 1 HP 70900B 100 MHz IN HP 70900B VIDEO IN HP 70905B 21.4 MHz OUT HP 70900B TUNE SPAN	HP 70905B 300 MHz IN HP 70310A 100 MHz HP 70902A VIDEO OUT HP 70902A 21.4 MHz IN HP 70600A TUNE SPAN	HP 8120-5022 365 mm SMB(f) to SMB(f) (6-slot) HP 8120-5022 365 mm SMB(f) to SMB(f) (6-slot) HP 8120-5016 160 mm SMB(f) to SMB(f) (2-slot) HP 8120-5022 365 mm SMB(f) to SMB(f) (6-slot) HP 8120-5022 365 mm SMB(f) to SMB(f) (6-slot)
<b>Miscellaneous Cables</b> HP 70905B 321.4 MHz OUT HP 70001A HP-MSIB OUT HP 70004A HP-MSIB OUT External Power Pack	HP 70905B 321.4 MHz IN HP 70004A HP-MSIB IN HP 70001A HP-MSIB IN HP 70310A EXT PWR	HP 70905-20024 55 mm SMA(m) to SMA(m) HP 70800B 1.0 m MSIB cable HP 70800B 1.0 m MSIB cable Built-in Power Pack Cable

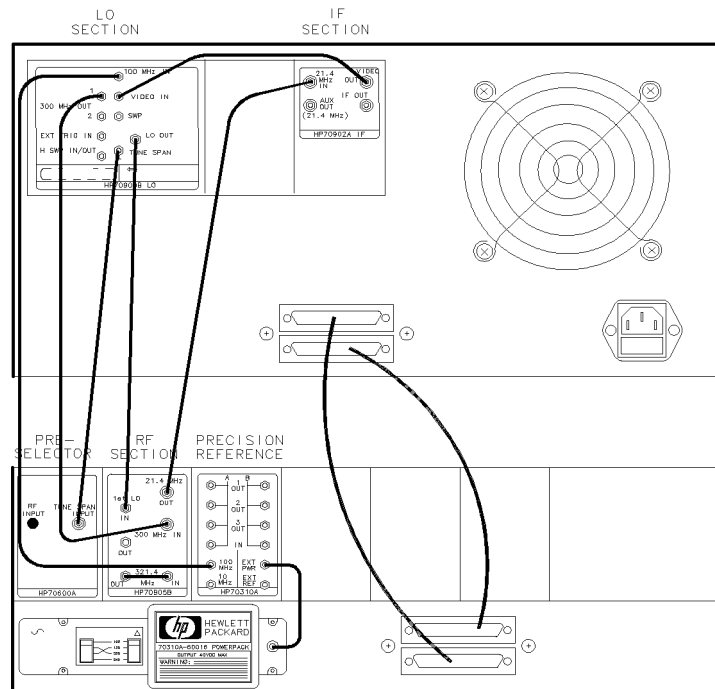

DUA19

**Figure 2-27.**  
**HP 71200C Modular Spectrum Analyzer Deleting HP 70905A RF Section, with HP 70905B RF Section/HP 70600A Preselector Cabling**

## HP 71200C Modular Spectrum Analyzer Deleting HP 70905A RF Section, with HP 70905B RF Section/HP 70600A Preselector/HP 70301A Microwave Tracking Generator

An HP 71200C modular spectrum analyzer deleting HP 70905A RF section, with HP 70905B RF section/HP 70600A preselector/HP 70301A microwave tracking generator consists of the following components:

HP 70001A mainframe	HP 70004A color display
HP 70900B local oscillator source	HP 70902A IF section (10 Hz – 300 KHz)
HP 70905B RF section (50 KHz – 22 GHz)	HP 70310A precision frequency reference
HP 70600A preselector	HP 70301A microwave tracking generator

R O W	7		70310A P.F.R.		
	6	70905B RF SECT			
	5		70301A uWTrckG		
	4				
	3				
	2		70600A PRE SEL		
	1	70902A IF SECT			
	0	70900B LO/CTLR HP-IB 18			
		17	18	19	20
		COLUMN			

DUA22

**Figure 2-28.**

### Address Map for HP 71200C Modular Spectrum Analyzer Deleting HP 70905A RF Section, with HP 70905B RF Section/HP 70600A Preselector/HP 70301A Microwave Tracking Generator

- The HP 70001A mainframe does not have an HP-MSIB address.
- The usual address for the HP 70004A color display is ROW 0, COLUMN 4.
- For information about software/firmware compatibility, refer to “Software/Hardware Compatibility” in Chapter 4.

To configure an HP 71200C modular spectrum analyzer deleting HP 70905A RF section, with HP 70905B RF section/HP 70600A preselector/HP 70301A microwave tracking generator, connect the cables according to the following table.

---

**CAUTION** To ensure proper electrical connection and prevent connector damage, all APC 3.5 and SMA connectors must be torqued 5 to 8 inch-pounds (finger tight). Do not exceed 8 inch-pounds.

---

From	To	Cable
<b>Flexible LO I/O Cables</b>		
HP 70900B LO OUT	HP 70905B 1st LO IN	HP 5061-9038 520 mm SMA(m) to SMA(m)
HP 70905B 1ST LO OUT	HP 70301A LO IN	HP 5021-5494 400 mm SMA(m) to SMA(m)
<b>Flexible System Cables</b>		
HP 70900B 300 MHZ OUT 1	HP 70905A 300 MHZ IN	HP 8120-5022 365 mm SMB(f) to SMB(f) (6-slot)
HP 70900B 100 MHZ IN	HP 70310A 100 MHZ	HP 8120-5022 365 mm SMB(f) to SMB(f) (6-slot)
HP 70900B VIDEO IN	HP 70902A VIDEO OUT	HP 8120-5016 160 mm SMB(f) to SMB(f) (2-slot)
HP 70905B 21.4 MHz OUT	HP 70902A 21.4 MHz IN	HP 8120-5022 365 mm SMB(f) to SMB(f) (6-slot)
HP 70900B TUNE SPAN	* HP 70301A TUNE SPAN	HP 8120-5025 490 mm SMB(f) to SMB(f)
* HP 70301A TUNE SPAN	HP 70600A TUNE SPAN	HP 8120-5022 365 mm SMB(f) to SMB(f) (6-slot)
HP 70900B 300 MHZ OUT 2	HP 70301A 300 MHZ IN	HP 8120-5025 490 mm SMB(f) to SMB(f)
HP 70301A 21.4 MHz IN	HP 70301A 21.4 MHz OUT	HP 8120-5014 100 mm SMB(f) to SMB(f) (1-slot)
<b>Miscellaneous Cables</b>		
HP 70905B 321.4 MHz OUT	HP 70905B 321.4 MHz IN	HP 70905-20024 55 mm SMA(m) to SMA(m)
HP 70001A HP-MSIB OUT	HP 70004A HP-MSIB IN	HP 70800B 1.0 m MSIB cable
HP 70004A HP-MSIB OUT	HP 70001A HP-MSIB IN	HP 70800B 1.0 m MSIB cable
External Power Pack	HP 70310A EXT PWR	Built-in Power Pack Cable

\* On this connector, use an HP 1250-1391 50Ω SMB tee(f) (m) (m) adapter.

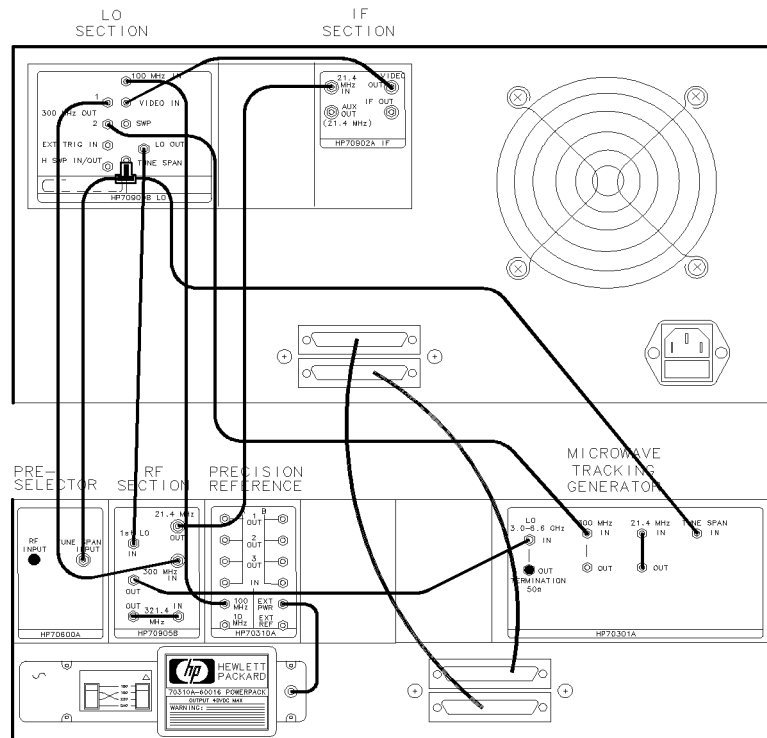

DUA21

**Figure 2-29.**

**HP 71200C Modular Spectrum Analyzer Deleting HP 70905A RF Section, with HP 70905B RF Section/HP 70600A Preselector/HP 70301A Microwave Tracking Generator Cabling**

**Note**

The HP 71201A Option 001 modular spectrum analyzer uses this same cabling configuration, but contains the HP 70906B RF section in place of the HP 70905B RF section and the HP 70601A preselector in place of the HP 70600A preselector.

## HP 71209A Microwave Spectrum Analyzer

An HP 71209A microwave spectrum analyzer consists of the following components:

HP 70001A mainframe	HP 70004A color display
HP 70900B local oscillator source	HP 70902A IF section (10 Hz - 300 KHz)
HP 70903A IF section (100 KHz - 3 MHz)	HP 70909A RF section (100 Hz - 26.5 GHz)
HP 70310A precision frequency reference	or HP 70910A RF section (100 Hz - 26.5 GHz)

R O W	7		70310A FREQ REF		
	6		70909A RF SECT		
	5				
	4		70903A IF SECT		
	3				
	2				
	1		70902A IF SECT		
	0		70900B LO/CTLR HP-IB18		
		17	18	19	20
		COLUMN			

DUA57

**Figure 2-30. Address Map for HP 71209A Microwave Spectrum Analyzer**

- The HP 70001A mainframe does not have an HP-MSIB address.
- The usual address for the HP 70004A color display is ROW 0, COLUMN 4.
- Refer to Chapter 1 for information about software/firmware compatibility.

To configure an HP 71209A microwave spectrum analyzer, connect the rear panel cables according to the following table.

**CAUTION** To ensure proper electrical connection and prevent connector damage, all APC 3.5 and SMA connectors must be torqued 5 to 8 inch-pounds (finger tight). Do not exceed 8 inch-pounds.

### Rear-Panel Cable Connections

From	To	Cable
<b>Flexible LO I/O Cables</b> HP 70900B LO OUT	HP 70909A 1st LO IN	HP 5061-9038 520 mm SMA(m) to SMA(m)
<b>Flexible System Cables</b> HP 70900B 300 MHz OUT 1	HP 70909A 300 MHz IN	HP 8120-5022 365 mm SMB(f) to SMB(f) (6-slot)
HP 70900B 100 MHz IN	HP 70310A 100 MHz	HP 8120-5022 365 mm SMB(f) to SMB(f) (6-slot)
HP 70900B VIDEO IN	HP 70903A VIDEO OUT	HP 8120-5016 160 mm SMB(f) to SMB(f) (2-slot)
HP 70909A 21.4 MHz OUT	HP 70903A 21.4 MHz IN	HP 8120-5022 365 mm SMB(f) to SMB(f) (6-slot)
HP 70900B TUNE SPAN	HP 70909A TUNE SPAN	HP 8120-5022 365 mm SMB(f) to SMB(f) (6-slot)
HP 70902A VIDEO OUT	HP 70903A VIDEO IN	HP 8120-5014 100 mm SMB(f) to SMB(f) (1-slot)
HP 70902A 21.4 MHz IN	HP 70903A 21.4 MHz OUT	HP 8120-5014 100 mm SMB(f) to SMB(f) (1-slot)
<b>Miscellaneous Cables</b> HP 70001A HP-MSIB OUT	HP 70004A HP-MSIB IN	HP 70800B 1.0 m MSIB cable
HP 70004A HP-MSIB OUT	HP 70001A HP-MSIB IN	HP 70800B 1.0 m MSIB cable
External Power Pack	HP 70310A EXT PWR	Built-in Power Pack Cable

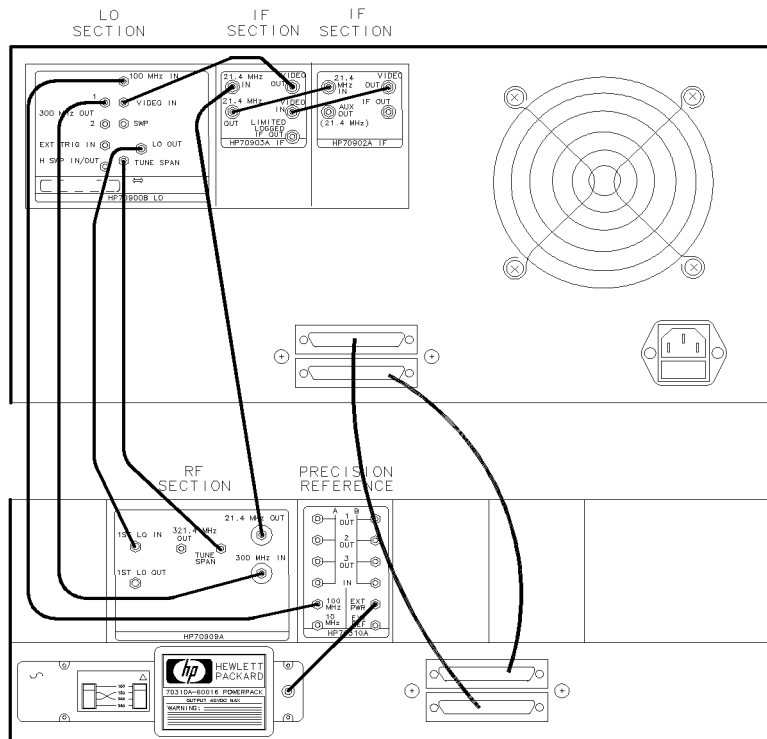

DUA56

Figure 2-31. HP 71209A Microwave Spectrum Analyzer Rear Panel Cabling

## HP 71210C Microwave Spectrum Analyzer

An HP 71210C microwave spectrum analyzer consists of the following components:

HP 70001A mainframe	HP 70004A color display
HP 70900B local oscillator source	HP 70902A IF section (10 Hz – 300 KHz)
HP 70903A IF section (100 KHz – 3 MHz)	HP 70908A RF section (100 Hz – 22 GHz)
HP 70310A precision frequency reference	

R O W	7		70310A P.F.R.		
	6	70908A RF SECT			
	5				
	4	70903A IF SECT			
	3				
	2				
	1	70902A IF SECT			
	0	70900B LO/CTLR HP-IB 18			
		17	18	19	20
		COLUMN			

DUA24

**Figure 2-32. Address Map for HP 71210C Microwave Spectrum Analyzer**

- The HP 70001A mainframe does not have an HP-MSIB address.
- The usual address for the HP 70004A color display is ROW 0, COLUMN 4.
- For information about software/firmware compatibility, refer to “Software/Hardware Compatibility” in Chapter 4.



To configure an HP 71210C microwave spectrum analyzer, connect the rear panel cables according to the following table.

**CAUTION** To ensure proper electrical connection and prevent connector damage, all APC 3.5 and SMA connectors must be torqued 5 to 8 inch-pounds (finger tight). Do not exceed 8 inch-pounds.

From	To	Cable
<b>Flexible LO I/O Cables</b> HP 70900B LO OUT	HP 70908A 1st LO IN	HP 5061-9038 520 mm SMA(m) to SMA(m)
<b>Flexible System Cables</b> HP 70900B 300 MHZ OUT 1 HP 70900B 100 MHZ IN HP 70900B VIDEO IN HP 70908A 21.4 MHz OUT HP 70900B TUNE SPAN HP 70902A VIDEO OUT HP 70902A 21.4 MHz IN	HP 70908A 300 MHZ IN HP 70310A 100 MHZ HP 70903A VIDEO OUT HP 70903A 21.4 MHz IN HP 70908A TUNE SPAN HP 70903A VIDEO IN HP 70903A 21.4 MHz OUT	HP 8120-5022 365 mm SMB(f) to SMB(f) (6-slot) HP 8120-5022 365 mm SMB(f) to SMB(f) (6-slot) HP 8120-5016 160 mm SMB(f) to SMB(f) (2-slot) HP 8120-5022 365 mm SMB(f) to SMB(f) (6-slot) HP 8120-5022 365 mm SMB(f) to SMB(f) (6-slot) HP 8120-5014 100 mm SMB(f) to SMB(f) (1-slot) HP 8120-5014 100 mm SMB(f) to SMB(f) (1-slot)
<b>Miscellaneous Cables</b> HP 70001A HP-MSIB OUT HP 70004A HP-MSIB OUT External Power Pack	HP 70004A HP-MSIB IN HP 70001A HP-MSIB IN HP 70310A EXT PWR	HP 70800B 1.0 m MSIB cable HP 70800B 1.0 m MSIB cable Built-in Power Pack Cable

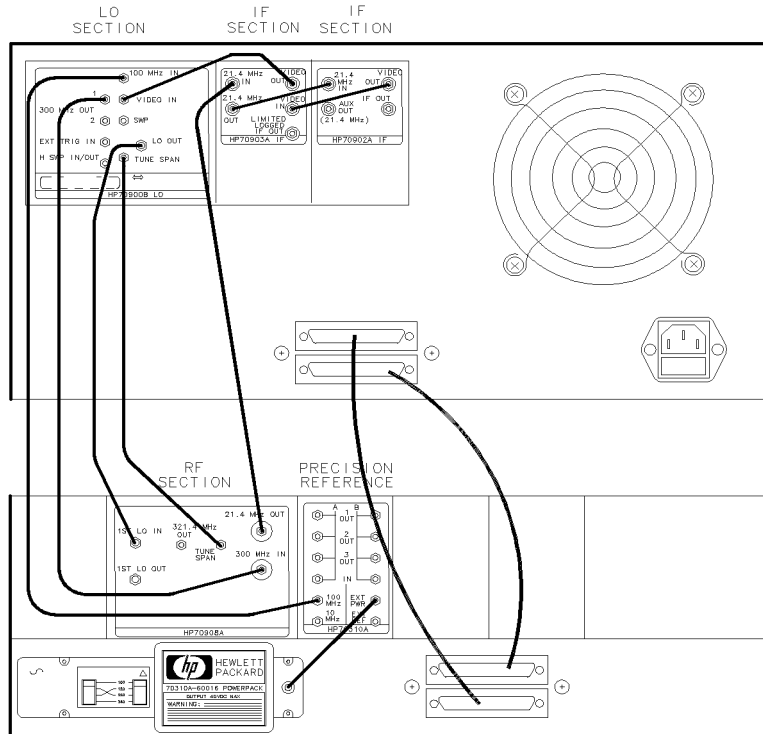

Figure 2-33. HP 71210C Microwave Spectrum Analyzer Rear Panel Cabling

## HP 71400C Lightwave Signal Analyzer

An HP 71400C lightwave signal analyzer consists of the following components:

HP 70001A mainframe	HP 70004A color display
HP 70900B local oscillator source	HP 70902A IF section (10 Hz – 300 KHz)
HP 70903A IF section (100 KHz – 3 MHz)	HP 70908A RF section (100 Hz – 22 GHz)
HP 70310A precision frequency reference	HP 70810B lightwave section

R O W	7		70310A P.F.R.		
	6	70908A RF SECT			
	5				
	4	70903A IF SECT			
	3			70810B LW RCVR	
	2				
	1	70902A IF SECT			
	0	70900B LO/CTLR HP-IB 18			
		17	18	19	20
		COLUMN			

DUA26

**Figure 2-34. Address Map for HP 71400C Lightwave Signal Analyzer**

- The HP 70001A mainframe does not have an HP-MSIB address.
- The usual address for the HP 70004A color display is ROW 0, COLUMN 4.
- For information about software/firmware compatibility, refer to “Software/Hardware Compatibility” in Chapter 4.

To configure an HP 71400C lightwave signal analyzer, connect the rear panel cables according to the following table.

**CAUTION** To ensure proper electrical connection and prevent connector damage, all APC 3.5 and SMA connectors must be torqued 5 to 8 inch-pounds (finger tight). Do not exceed 8 inch-pounds.

From	To	Cable
<b>Flexible LO I/O Cables</b> HP 70900B LO OUT	HP 70908A 1st LO IN	HP 5061-9038 520 mm SMA(m) to SMA(m)
<b>Flexible System Cables</b> HP 70900B 300 MHz OUT 1 HP 70900B 100 MHz IN HP 70900B VIDEO IN HP 70908A 21.4 MHz OUT HP 70900B TUNE SPAN HP 70900B HSWP IN/OUT HP 70902A VIDEO OUT HP 70902A 21.4 MHz IN	HP 70908A 300 MHz IN HP 70310A 100 MHz HP 70903A VIDEO OUT HP 70903A 21.4 MHz IN HP 70908A TUNE SPAN HP 70810B HSWP IN/OUT HP 70903A VIDEO IN HP 70903A 21.4 MHz OUT	HP 8120-5022 365 mm SMB(f) to SMB(f) (6-slot) HP 8120-5022 365 mm SMB(f) to SMB(f) (6-slot) HP 8120-5016 160 mm SMB(f) to SMB(f) (2-slot) HP 8120-5022 365 mm SMB(f) to SMB(f) (6-slot) HP 8120-5022 365 mm SMB(f) to SMB(f) (6-slot) HP 8120-5022 365 mm SMB(f) to SMB(f) (6-slot) HP 8120-5014 100 mm SMB(f) to SMB(f) (1-slot) HP 8120-5014 100 mm SMB(f) to SMB(f) (1-slot)
<b>Miscellaneous Cables</b> HP 70001A HP-MSIB OUT HP 70004A HP-MSIB OUT	HP 70004A HP-MSIB IN HP 70001A HP-MSIB IN	HP 70800B 1.0 m MSIB cable HP 70800B 1.0 m MSIB cable
External Power Pack	HP 70310A EXT PWR	Built-in Power Pack Cable

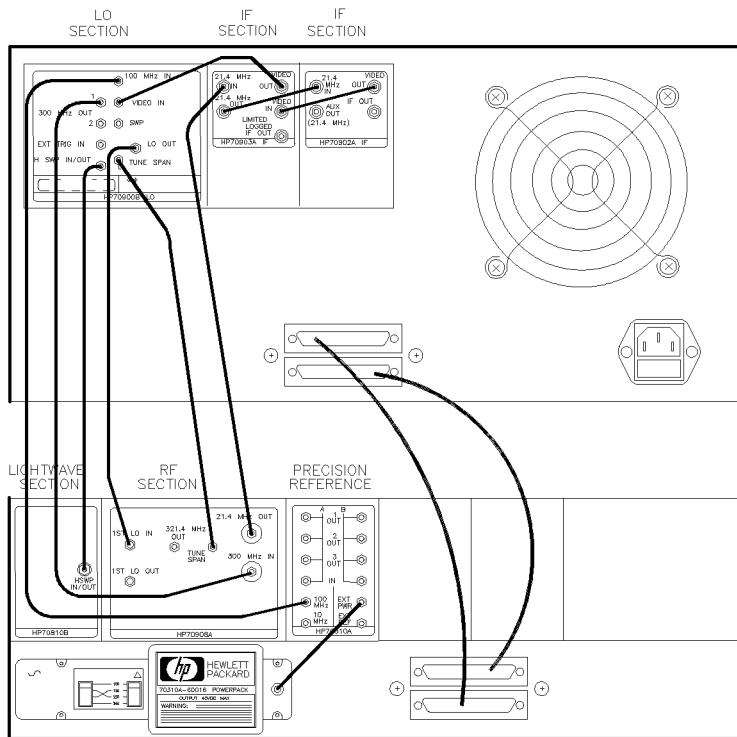

Figure 2-35. HP 71400C Lightwave Signal Analyzer Rear Panel Cabling

## HP 71400C Lightwave Signal Analyzer with HP 70300A RF Tracking Generator and HP 70301A Microwave Tracking Generator

An HP 71400C lightwave signal analyzer with HP 70300A RF tracking generator and HP 70301A microwave tracking generator, consists of the following components:

HP 70001A mainframe	HP 70004A color display
HP 70900B local oscillator source	HP 70902A IF section (10 Hz – 300 KHz)
HP 70903A IF section (100 KHz – 3 MHz)	HP 70905A RF section (50 KHz – 22 GHz)
HP 70300A RF tracking generator	HP 70301A microwave tracking generator
HP 70310A precision frequency reference	HP 70810B lightwave section

R O W	7		70310A P.F.R.		
	6	70908A RF SECT	70300A RFTrckG		
	5		70301A uWTrckG		
	4	70903A IF SECT			
	3			70810B LW RCVR	
	2				
	1	70902A IF SECT			
	0	70900B LO/CTLR HP-IB 18			
		17	18	19	20
		COLUMN			

DUA28

**Figure 2-36.**  
**Address Map for HP 71400C Lightwave Signal Analyzer with HP 70300A RF Tracking Generator and HP 70301A Microwave Tracking Generator**

- The HP 70001A mainframe does not have an HP-MSIB address.
- The usual address for the HP 70004A color display is ROW 0, COLUMN 4.
- For information about software/firmware compatibility, refer to “Software/Hardware Compatibility” in Chapter 4.

To configure an HP 71400C lightwave signal analyzer with HP 70300A RF tracking generator and HP 70301A microwave tracking generator, connect the rear panel cables according to the following table.

**CAUTION** To ensure proper electrical connection and prevent connector damage, all APC 3.5 and SMA connectors must be torqued 5 to 8 inch-pounds (finger tight). Do not exceed 8 inch-pounds.

From	To	Cable
<b>Flexible LO I/O Cables</b>		
HP 70900B LO OUT	HP 70908A 1st LO IN	HP 5061-9038 520 mm SMA(m) to SMA(m)
HP 70301A LO OUT	HP 70300A LO IN	HP 5021-5449 220 mm SMA(m) to SMA(m)
HP 70908A LO OUT	HP 70301A LO IN	HP 5021-5494 400 mm SMA(m) to SMA(m)
<b>Flexible System Cables</b>		
HP 70900B 300 MHZ OUT 1	HP 70908A 300 MHZ IN	HP 8120-5022 365 mm SMB(f) to SMB(f) (6-slot)
HP 70900B 300 MHZ OUT 2	HP 70300A 300 MHZ IN	HP 8120-5022 365 mm SMB(f) to SMB(f) (6-slot)
HP 70900B HSWP IN/OUT	* HP 70810B HSWP IN/OUT	HP 8120-5021 310 mm SMB(f) to SMB(f) (5-slot)
* HP 70810B HSWP IN/OUT	HP 70300A HSWP IN	HP 8120-5021 310 mm SMB(f) to SMB(f) (5-slot)
HP 70900B 100 MHZ IN	HP 70310A 100 MHZ	HP 8120-5022 365 mm SMB(f) to SMB(f) (6-slot)
HP 70900B VIDEO IN	HP 70903A VIDEO OUT	HP 8120-5016 160 mm SMB(f) to SMB(f) (2-slot)
HP 70900B SWEEP	HP 70300A SWEEP IN	HP 8120-5022 365 mm SMB(f) to SMB(f) (6-slot)
HP 70900B TUNE SPAN	* HP 70908A TUNE SPAN	HP 8120-5021 310 mm SMB(f) to SMB(f) (5-slot)
* HP 70908A TUNE SPAN	* HP 70300A TUNE SPAN	HP 8120-5017 205 mm SMB(f) to SMB(f) (3-slot)
* HP 70300A TUNE SPAN	HP 70301A TUNE SPAN	HP 8120-5017 205 mm SMB(f) to SMB(f) (3-slot)
HP 70908A 21.4 MHz OUT	HP 70903A 21.4 MHz IN	HP 8120-5022 365 mm SMB(f) to SMB(f) (6-slot)
HP 70902A VIDEO OUT	HP 70903A VIDEO IN	HP 8120-5014 100 mm SMB(f) to SMB(f) (1-slot)
HP 70902A 21.4 MHz IN	HP 70903A 21.4 MHz OUT	HP 8120-5014 100 mm SMB(f) to SMB(f) (1-slot)
HP 70300A 300 MHZ OUT	HP 70301A 300 MHZ IN	HP 8120-5016 160 mm SMB(f) to SMB(f) (2-slot)
HP 70301A 21.4 MHz IN	HP 70301A 21.4 MHz OUT	HP 8120-5014 100 mm SMB(f) to SMB(f) (1-slot)
<b>Miscellaneous Cables</b>		
Lower HP 70001A HP-MSIB OUT	Upper HP 70001A HP-MSIB IN	HP 70800B 1.0 m MSIB cable
Upper HP 70001A HP-MSIB OUT	HP 70004A HP-MSIB IN	HP 70800B 1.0 m MSIB cable
HP 70004A HP-MSIB OUT	Lower HP 70001A HP-MSIB IN	HP 70800B 1.0 m MSIB cable
External Power Pack	HP 70310A EXT PWR	Built-in Power Pack Cable
* On this connector, use an HP 1250-1391 50Ω SMB tee(f) (m) (m) adapter.		

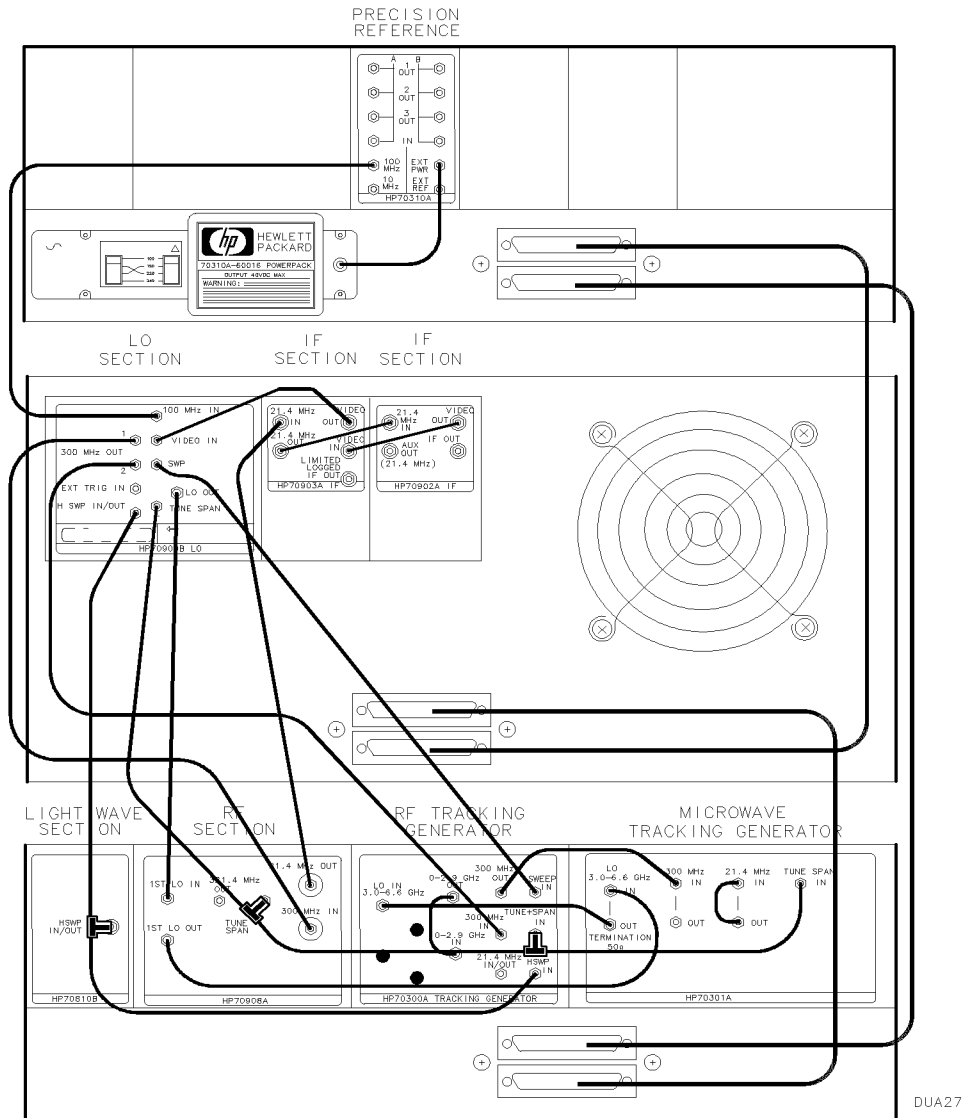

DUA27

**Figure 2-37.**  
**HP 71400C Lightwave Signal Analyzer with HP 70300A RF Tracking Generator and HP 70301A Microwave Tracking Generator Rear Panel Cabling**

## HP 71401C Lightwave Signal Analyzer

An HP 71401C lightwave signal analyzer consists of the following components:

HP 70001A mainframe	HP 70004A color display
HP 70900B local oscillator source	HP 70902A IF section (10 Hz – 300 KHz)
HP 70904A RF section (100 Hz – 2.9 GHz)	HP 70903A IF section (100 KHz – 3 MHz)
HP 70810B lightwave section	HP 70310A precision frequency reference

R O W	7		70310A P.F.R.		
	6	70904A RF SECT			
	5				
	4	70903A IF SECT			
	3			70810B LW RCVR	
	2				
	1	70902A IF SECT			
	0	70900B LO/CTLR HP-IB 18			
		17	18	19	20
		COLUMN			

DUA30

**Figure 2-38. Address Map for HP 71401C Lightwave Signal Analyzer**

- The HP 70001A mainframe does not have an HP-MSIB address.
- The usual address for the HP 70004A color display is ROW 0, COLUMN 4.
- For information about software/firmware compatibility, refer to “Software/Hardware Compatibility” in Chapter 4.

To configure an HP 71401C lightwave signal analyzer, connect the rear panel cables according to the following table.

**CAUTION** To ensure proper electrical connection and prevent connector damage, all APC 3.5 and SMA connectors must be torqued 5 to 8 inch-pounds (finger tight). Do not exceed 8 inch-pounds.

From	To	Cable
<b>Flexible LO I/O Cables</b> HP 70900B LO OUT	HP 70904A 1st LO IN	HP 5061-9038 520 mm SMA(m) to SMA(m)
<b>Flexible System Cables</b> HP 70900B 300 MHZ OUT (1) HP 70900B 100 MHZ IN HP 70900B VIDEO IN HP 70904A 21.4 MHz OUT HP 70903A 21.4 MHz OUT HP 70902A VIDEO OUT HP 70900B HSWP IN/OUT	HP 70904A 300 MHZ IN HP 70310A 100 MHZ HP 70903A VIDEO OUT HP 70903A 21.4 MHz IN HP 70902A 21.4 MHz IN HP 70903A VIDEO IN HP 70810B HSWP IN/OUT	HP 8120-5022 365 mm SMB(f) to SMB(f) (6-slot) HP 8120-5022 365 mm SMB(f) to SMB(f) (6-slot) HP 8120-5016 160 mm SMB(f) to SMB(f) (2-slot) HP 8120-5022 365 mm SMB(f) to SMB(f) (6-slot) HP 8120-5014 100 mm SMB(f) to SMB(f) (1-slot) HP 8120-5014 100 mm SMB(f) to SMB(f) (1-slot) HP 8120-5022 365 mm SMB(f) to SMB(f) (6-slot)
<b>Miscellaneous Cables</b> HP 70001A HP-MSIB OUT HP 70004A HP-MSIB OUT External Power Pack	HP 70004A HP-MSIB IN HP 70001A HP-MSIB IN HP 70310A EXT PWR	HP 70800B 1.0 m MSIB cable HP 70800B 1.0 m MSIB cable Built-in Power Pack Cable

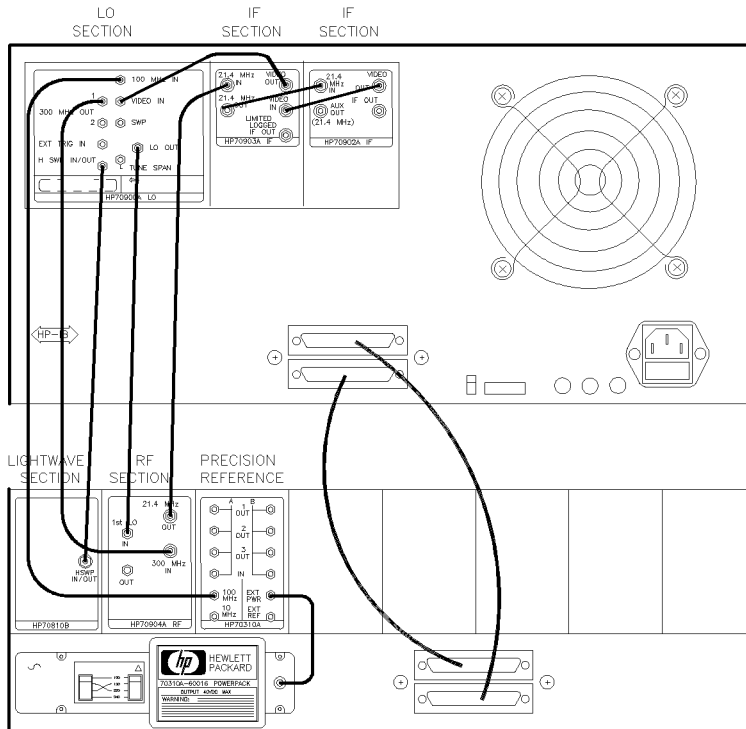

DUA29

Figure 2-39. HP 71401C Lightwave Signal Analyzer Rear-Panel Cabling



## HP 71401C Lightwave Signal Analyzer with an HP 70300A RF Tracking Generator

An HP 71401C lightwave signal analyzer with HP 70300A RF tracking generator consists of the following components:

HP 70001A mainframe	HP 70004A color display
HP 70900B local oscillator source	HP 70902A IF section (10 Hz - 300 KHz)
HP 70904A RF section (100 Hz - 2.9 GHz)	HP 70903A IF section (100 KHz - 3 MHz)
HP 70300A RF tracking generator	HP 70310A precision frequency reference
HP 70810B lightwave section	

		70310A P.F.R.	
	70904A RF SECT	70300A RFTrckG	
	70903A IF SECT		
			70810B LW RCVR
	70902A IF SECT		
	70900B LO/CTLR HP-IB 18		
	17	18	19

COLUMN

DUA32

**Figure 2-40.**  
**Address Map for HP 71401C Lightwave Signal Analyzer with an HP 70300A RF Tracking Generator**

- The HP 70001A mainframe does not have an HP-MSIB address.
- The usual address for the HP 70004A color display is ROW 0, COLUMN 4.
- For information about software/firmware compatibility, refer to “Software/Hardware Compatibility” in Chapter 4.

To configure an HP 71401C lightwave signal analyzer with an HP 70300A RF tracking generator, connect the rear panel cables according to the following table.

---

**CAUTION** To ensure proper electrical connection and prevent connector damage, all APC 3.5 and SMA connectors must be torqued 5 to 8 inch-pounds (finger tight). Do not exceed 8 inch-pounds.

---

From	To	Cable
<b>Flexible LO I/O Cables</b> HP 70900B LO OUT	HP 70904A 1st LO IN	HP 5061-9038 520 mm SMA(m) to SMA(m)
<b>Flexible System Cables</b> HP 70900B 300 MHz OUT (1)	HP 70904A 300 MHz IN	HP 8120-5022 365 mm SMB(f) to SMB(f) (6-slot)
HP 70900B 300 MHz OUT (2)	HP 70300A 300 MHz IN	HP 8120-5025 490 mm SMB(f) to SMB(f)
HP 70900B 100 MHz IN	HP 70310A 100 MHz	HP 8120-5022 365 mm SMB(f) to SMB(f) (6-slot)
HP 70900B TUNE SPAN	HP 70300A TUNE + SPAN IN	HP 8120-5025 490 mm SMB(f) to SMB(f)
HP 70900B SWEEP	HP 70300A SWEEP IN	HP 8120-5025 490 mm SMB(f) to SMB(f)
HP 70900B VIDEO IN	HP 70903A VIDEO OUT	HP 8120-5016 160 mm SMB(f) to SMB(f) (2-slot)
HP 70904A 21.4 MHz OUT	HP 70903A 21.4 MHz IN	HP 8120-5022 365 mm SMB(f) to SMB(f) (6-slot)
HP 70900B HSWP IN/OUT	* HP 70810A HSWP IN/OUT	HP 8120-5021 310 mm SMB(f) to SMB(f) (5-slot)
* HP 70810A HSWP IN/OUT	HP 70300A HSWP IN	HP 8120-5022 365 mm SMB(f) to SMB(f) (6-slot)
HP 70903A 21.4 MHz OUT	HP 70902A 21.4 MHz IN	HP 8120-5014 100 mm SMB(f) to SMB(f) (1-slot)
HP 70903A VIDEO IN	HP 70902A VIDEO OUT	HP 8120-5014 100 mm SMB(f) to SMB(f) (1-slot)
<b>Miscellaneous Cables</b> HP 70904A 1st LO OUT	HP 70300A LO IN	HP 5021-5495 400 mm SMA(m) to SMA(m)
HP 70300A 0-2.9 GHz OUT	HP 70300A 0-2.9 GHz IN	HP 70300-20067 380 mm SMA(m) to SMA(m)
HP 70001A HP-MSIB OUT	HP 70004A HP-MSIB IN	HP 70800B 1.0 m MSIB cable
HP 70004A HP-MSIB OUT	HP 70001A HP-MSIB IN	HP 70800B 1.0 m MSIB cable
External Power Pack	HP 70310A EXT PWR	Built-in Power Pack Cable

\* On this connector, use an HP 1250-1391 50Ω SMB tee(f) (m) (m) adapter.

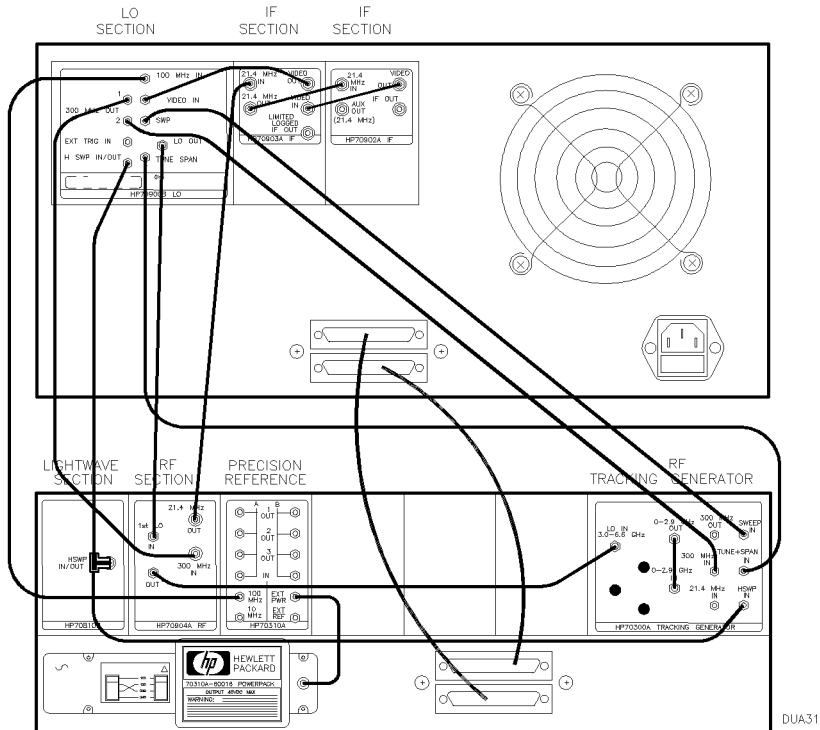

**Figure 2-41.**  
**HP 71401C Lightwave Signal Analyzer Rear-Panel Cabling with an HP 70300A RF Tracking Generator**

---

## System Configurations for “P” Systems

The figures in this section show the addressing order and cable connections for some common “P” system configurations. The following information is provided for each configuration.

- A sample address map screen illustrating the addressing order.
- A partial view of the system rear panel illustrating cable connections.
- Modules included in the system to ensure that needed elements are available.
- A list of rear panel cables describing type, quantity, and HP part numbers.
- A from-to list describing where to connect the cables and adapters.

### General Guidelines for Module Placement

The following is a list of general guidelines for modules that are placed in a single HP 70001A mainframe to make up a “P” system configuration:

- Guideline 1 IF modules should be positioned to the left of the HP 70900B local oscillator source.
- Guideline 2 Tracking generators modules and the HP 70310A precision frequency reference should not be placed directly next to the HP 70900B local oscillator source
- Guideline 3 Systems that contain a HP 70700A digitizer should be positioned in the slot directly to the left of the HP 70900B local oscillator source
- Guideline 4 Tracking generators modules and the HP 70310A precision frequency reference should be positioned to the left of the HP 70900B local oscillator source and IF modules.
- Guideline 5 RF modules should be positioned to the right of the HP 70900B local oscillator source.
- Guideline 6 Preselectors, preamps, and external mixers should be positioned to the right of the RF module.
- Guideline 7 Cabling between the RF module and the pre-RF modules are accomplished using semi-rigid cables.
- Guideline 8 If there is enough empty slots in a system and that system does not contain any modules placed to the right of the RF module (the system does not have a preselector, preamp, or external mixer), a blank space should be left to the right of the RF module to allow easy addition of pre-RF modules in the future.
- Guideline 9 If there are additional empty slots, the empty slots are generally to the left of the HP 70310A precision frequency reference.

A one mainframe system, containing all types of devices, has the standard configuration:

Tracking Generators	Frequency Reference	IF modules	Digitizer	Local Oscillator	Power Meter	RF module	Pre-RF modules
---------------------	---------------------	------------	-----------	------------------	-------------	-----------	----------------

A one mainframe system, in terms of specific models of devices, has the standard configuration:

Type of Device	Specific Model <sup>1</sup>
<b>Tracking Generators</b>	[HP 70301A microwave tracking generator or HP 70300A RF tracking generator]
<b>Frequency Reference</b>	HP 70138A vector voltmeter or HP 70310A precision frequency reference
<b>IF modules</b>	[HP 70902A IF section or HP 70903A IF section or HP 70911A WB IF section]
<b>Digitizer</b>	HP 70700A digitizer
<b>Local Oscillator</b>	HP 70900B local oscillator source
<b>Power Meter</b>	HP 70100A power meter
<b>RF module</b>	[HP 70904A RF section or HP 70905A RF section or HP 70905B RF section or HP 70908A RF section or HP 70909A RF section or HP 70910A RF section]
<b>Pre-RF modules</b>	[HP 70600A preselector or HP 70620A preamplifier or (External Mixer)]

<sup>1</sup> The bracketed components are functional blocks that should be left as a single unit. This is important when the system is expanded to more than eight slots by the addition of modules.

If a system requires nine to sixteen slots for the modules, two mainframes are necessary. The same general relationships between the modules still apply, but the additional spaces allow more flexibility in placement.

A two mainframe system containing multiple IF modules has the standard configuration:

IF modules	Local Oscillator			
Tracking Generators	Frequency Reference	Power Meter	RF module	Pre-RF modules

## **“P” System Configuration Examples**

### **HP 71100P modular spectrum analyzer:**

Standard	Figure 2-43
Standard with HP 70903A IF section added	Figure 2-45
Standard with HP 70700A digitizer added	Figure 2-47
Standard with HP 70903A IF section and HP 70700A digitizer added	Figure 2-49
Standard with HP 70300A RF tracking generator added	Figure 2-51

### **HP 71200P modular spectrum analyzer:**

Standard	Figure 2-53
Standard with HP 70903A IF section added	Figure 2-55
Standard deleting HP 70902A IF section, with HP 70903A IF section and HP 70907B external millimeter interface module (EMIM) added	Figure 2-57
Standard deleting HP 70905A RF section, with HP 70905B RF section and HP 70600A preselector added	Figure 2-59
Standard deleting HP 70905A RF section, with HP 70905B RF section, HP 70600A preselector and HP 70301A microwave tracking generator added	Figure 2-61

### **HP 71209P microwave spectrum analyzer:**

Standard	Figure 2-63
----------	-------------

### **HP 71210P microwave spectrum analyzer:**

Standard	Figure 2-65
Standard with HP 70907B external millimeter interface module added	Figure 2-67

## HP 71100P Modular Spectrum Analyzer

An HP 71100P modular spectrum analyzer consists of the following components:

HP 70001A mainframe	HP 70207A PC Display for MMS
HP 70900B local oscillator source	HP 70902A IF section (10 Hz – 300 KHz)
HP 70904A RF section (100 Hz – 2.9 GHz)	HP 70310A precision frequency reference

R O W	7		70310A P.F.R.	
	6	70904A RF SECT		
	5			
	4			
	3			
	2			
	1	70902A IF SECT		
	0	70900B LO/CTLR HP-IB 18		
	17	18	19	20
	COLUMN			

DUA4

**Figure 2-42. Address Map for HP 71100P Modular Spectrum Analyzer**

- The HP 70001A mainframe does not have an MSIB address.
- The usual address for the HP 70207A PC Display for MMS is ROW 0, COLUMN 2.
- For information about software/firmware compatibility, refer to “Software/Hardware Compatibility” in Chapter 4.

To configure an HP 71100P modular spectrum analyzer, connect the rear panel cables according to the following table.

**CAUTION** To ensure proper electrical connection and prevent connector damage, all APC 3.5 and SMA connectors must be torqued 5 to 8 inch-pounds (finger tight). Do not exceed 8 inch-pounds.

From	To	Cable
<b>Semi-Rigid LO I/O Cable</b> HP 70900B LO OUT	HP 70904A 1st LO IN	HP 5021-5449 220 mm SMA(m) to SMA(m)
<b>Flexible System Cables</b> HP 70900B 300 MHz OUT 1 HP 70900B 100 MHz IN HP 70900B VIDEO IN HP 70904A 21.4 MHz OUT	HP 70904A 300 MHz IN HP 70310A 100 MHz HP 70902A VIDEO OUT HP 70902A 21.4 MHz IN	HP 8120-5014 100 mm SMB(f) to SMB(f) (1-slot) HP 8120-5016 160 mm SMB(f) to SMB(f) (2-slot) HP 8120-5014 100 mm SMB(f) to SMB(f) (1-slot) HP 8120-5016 160 mm SMB(f) to SMB(f) (2-slot)
<b>Miscellaneous Cables</b> MSIB interface card External Power Pack	HP 70001A MSIB IN/OUT HP 70310A EXT PWR	HP 70207-60003 2.5 m MSIB Y-cable Built-in External Power Pack Cable

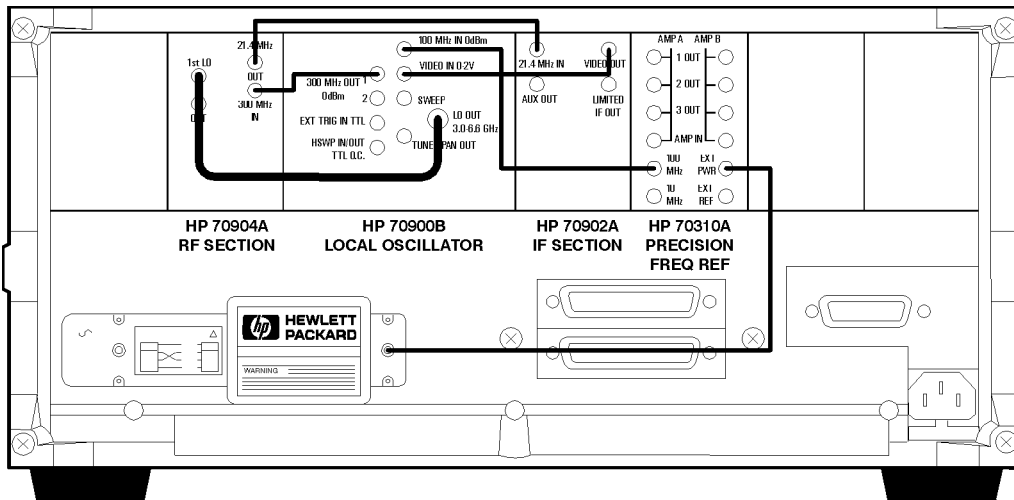

pcconf1.cdr

Figure 2-43. HP 71100P Modular Spectrum Analyzer Rear Panel Cabling

## HP 71100P Modular Spectrum Analyzer with HP 70903A IF Section

An HP 71100P modular spectrum analyzer with HP 70903A IF section, consists of the following components:

HP 70001A mainframe	HP 70207A PC Display for MMS
HP 70900B local oscillator source	HP 70903A IF section (100 KHz – 3 MHz)
HP 70902A IF section (10 Hz – 300 KHz)	HP 70310A precision frequency reference
HP 70904A RF section (100 Hz – 2.9 GHz)	

R O W	7		70310A P.F.R.		
	6	70904A RF SECT			
	5				
	4	70903A IF SECT			
	3				
	2				
	1	70902A IF SECT			
	0	70900B LO/CTLR HP-IB 18			
		17	18	19	20
		COLUMN			

DUA6

**Figure 2-44.**

### Address Map for HP 71100P Modular Spectrum Analyzer with HP 70903A IF Section

- The HP 70001A mainframe does not have an MSIB address.
- The usual address for the HP 70207A PC Display for MMS is ROW 0, COLUMN 2.
- For information about software/firmware compatibility, refer to “Software/Hardware Compatibility” in Chapter 4.



To configure an HP 71100P modular spectrum analyzer with HP 70903A IF section, connect the rear panel cables according to the following table.

**CAUTION** To ensure proper electrical connection and prevent connector damage, all APC 3.5 and SMA connectors must be torqued 5 to 8 inch-pounds (finger tight). Do not exceed 8 inch-pounds.

From	To	Cable
<b>Semi-Rigid LO I/O Cable</b> HP 70900B LO OUT	HP 70904A 1st LO IN	HP 5021-5449 220 mm SMA(m) to SMA(m)
<b>Flexible System Cables</b> HP 70900B 300 MHz OUT 1 HP 70900B 100 MHz IN HP 70900B VIDEO IN HP 70904A 21.4 MHz OUT HP 70902A 21.4 MHz IN HP 70902A VIDEO OUT	HP 70904A 300 MHz IN HP 70310A 100 MHz HP 70903A VIDEO OUT HP 70903A 21.4 MHz IN HP 70903A 21.4 MHz OUT HP 70903A VIDEO IN	HP 8120-5014 100 mm SMB(f) to SMB(f) (1-slot) HP 8120-5017 205 mm SMB(f) to SMB(f) (3-slot) HP 8120-5014 100 mm SMB(f) to SMB(f) (1-slot) HP 8120-5016 160 mm SMB(f) to SMB(f) (2-slot) HP 8120-5014 100 mm SMB(f) to SMB(f) (1-slot) HP 8120-5014 100 mm SMB(f) to SMB(f) (1-slot)
<b>Miscellaneous Cables</b> MSIB interface card External Power Pack	HP 70001A MSIB IN/OUT HP 70310A EXT PWR	HP 70207-60003 2.5 m MSIB Y-cable Built-in External Power Pack Cable

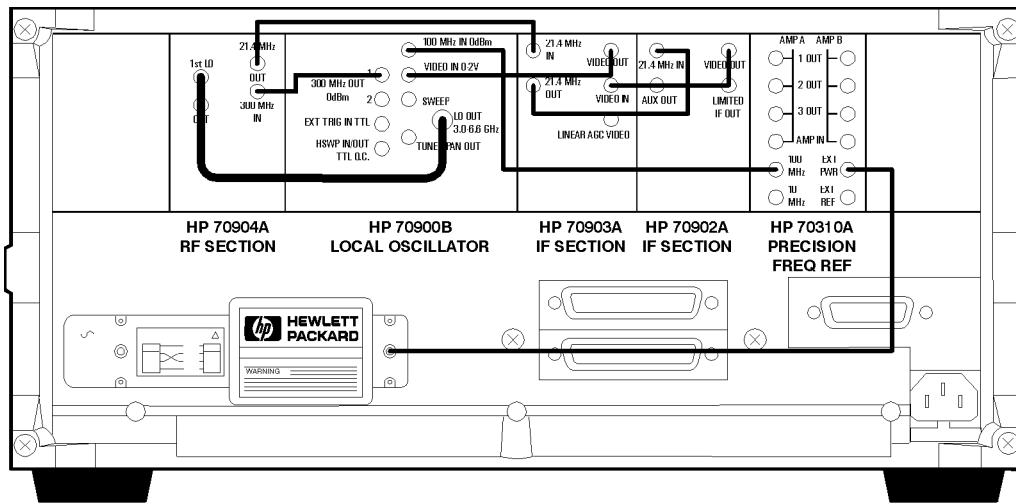

pconfig2.cdr

**Figure 2-45.**  
**HP 71100P Modular Spectrum Analyzer Rear Panel Cabling with HP 70903A IF Section**

## HP 71100P Modular Spectrum Analyzer with HP 70700A Digitizer

An HP 71100P modular spectrum analyzer with HP 70700A digitizer consists of the following components:

HP 70001A mainframe	HP 70207A PC Display for MMS
HP 70900B local oscillator source	HP 70902A IF section (10 Hz – 300 KHz)
HP 70904A RF section (100 Hz – 2.9 GHz)	HP 70310A precision frequency reference
HP 70700A digitizer	

R O W	7		70310A P.F.R.		
	6	70904A RF SECT			
	5				
	4				
	3				
	2	70700A DIGITIZER			
	1	70902A IF SECT			
	0	70900B LO/CTLR HP-IB 18			
		17	18	19	20
		COLUMN			

DUAS

**Figure 2-46.**

### Address Map for HP 71100P Modular Spectrum Analyzer with HP 70700A Digitizer

- The HP 70001A mainframe does not have an MSIB address.
- The usual address for the HP 70207A PC Display for MMS is ROW 0, COLUMN 2.
- For information about software/firmware compatibility, refer to “Software/Hardware Compatibility” in Chapter 4.

To configure an HP 71100P modular spectrum analyzer with HP 70700A digitizer as a slave, connect the rear panel cables according the following table. Note that the HP-IB switch on the HP 70700A digitizer must be in the off position.

**CAUTION** To ensure proper electrical connection and prevent connector damage, all APC 3.5 and SMA connectors must be torqued 5 to 8 inch-pounds (finger tight). Do not exceed 8 inch-pounds.

From	To	Cable
<b>Semi-Rigid LO I/O Cable</b> HP 70900B LO OUT	HP 70904A 1st LO IN	HP 5021-5449 220 mm SMA(m) to SMA(m)
<b>Flexible System Cables</b> HP 70900B 300 MHz OUT 1	HP 70904A 300 MHz IN	HP 8120-5014 100 mm SMB(f) to SMB(f) (1-slot)
HP 70900B 100 MHz IN	HP 70310A 100 MHz	HP 8120-5017 205 mm SMB(f) to SMB(f) (3-slot)
HP 70904A 21.4 MHz OUT	HP 70902A 21.4 MHz IN	HP 8120-5017 205 mm SMB(f) to SMB(f) (3-slot)
HP 70900B VIDEO IN	* HP 70700A INPUT 2	HP 8120-5016 160 mm SMB(f) to SMB(f) (2-slot)
* HP 70700A INPUT 2	HP 70902A VIDEO OUT	HP 8120-5014 100 mm SMB(f) to SMB(f) (1-slot)
HP 70900B HSWP IN/OUT	* HP 70700A HI SWP	HP 8120-5014 100 mm SMB(f) to SMB(f) (1-slot)
* HP 70700A HI SWP	HP 70700A EXT TRIG	HP 8120-5014 100 mm SMB(f) to SMB(f) (1-slot)
HP 70700A CLK IN	HP 70700A CLK OUT	HP 8120-5014 100 mm SMB(f) to SMB(f) (1-slot)
<b>Miscellaneous Cables</b> MSIB interface card	HP 70001A MSIB IN/OUT	HP 70207-60003 2.5 m MSIB Y-cable
External Power Pack	HP 70310A EXT PWR	Built-in External Power Pack Cable

\* On this connector, use an HP 1250-1391 50Ω SMB tee(f) (m) (m) adapter.

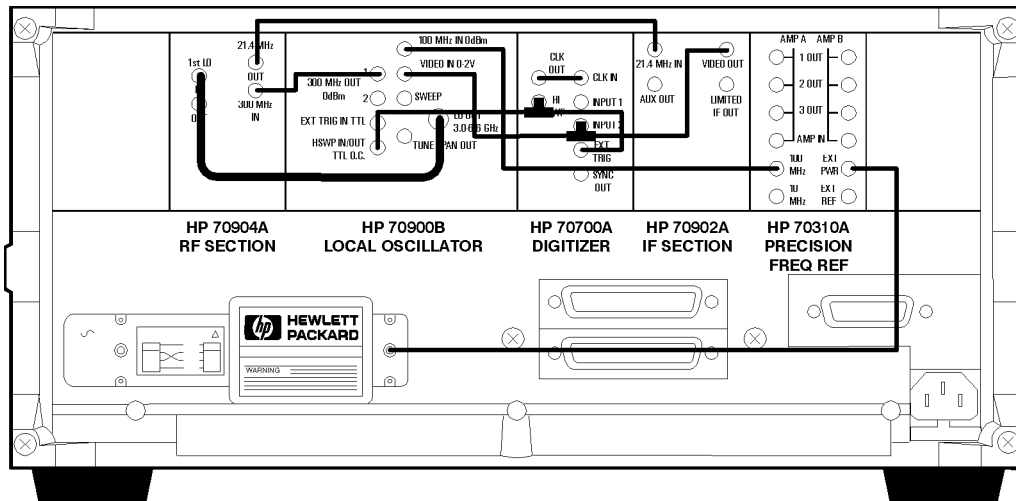

pconfig3.cdr

**Figure 2-47.**  
**HP 71100P Modular Spectrum Analyzer Rear Panel Cabling with HP 70700A Digitizer**

## HP 71100P Modular Spectrum Analyzer with HP 70903A IF Section and HP 70700A Digitizer

An HP 71100P modular spectrum analyzer with HP 70903A IF section and HP 70700A digitizer consists of the following components:

HP 70001A mainframe	HP 70207A PC Display for MMS
HP 70900B local oscillator source	HP 70902A IF section (10 Hz – 300 KHz)
HP 70903A IF section (100 KHz – 3 MHz)	HP 70904A RF section (100 Hz – 2.9 GHz)
HP 70310A precision frequency reference	HP 70700A digitizer

R O W	7		70310A P.F.R.		
	6		70904A RF SECT		
	5				
	4		70903A IF SECT		
	3				
	2		70700A DIGITIZER		
	1		70902A IF SECT		
	0		70900B LO/CTLR HP-IB 18		
		17	18	19	20
		COLUMN			

DUA10

**Figure 2-48.**

### Address Map for HP 71100P Modular Spectrum Analyzer with HP 70903A IF Section and HP 70700A Digitizer

- The HP 70001A mainframe does not have an MSIB address.
- The usual address for the HP 70207A PC Display for MMS is ROW 0, COLUMN 2.
- For information about software/firmware compatibility, refer to “Software/Hardware Compatibility” in Chapter 4.

To configure an HP 71100P modular spectrum analyzer with HP 70903A IF section and HP 70700A digitizer as a slave, connect the rear panel cables according to the following table. Note that the HP-IB switch on the HP 70700A digitizer should be in the off position.

**CAUTION** To ensure proper electrical connection and prevent connector damage, all APC 3.5 and SMA connectors must be torqued 5 to 8 inch-pounds (finger tight). Do not exceed 8 inch-pounds (finger tight).

From	To	Cable
<b>Semi-Rigid LO I/O Cable</b> HP 70900B LO OUT	HP 70904A 1st LO IN	HP 5021-5449 220 mm SMA(m) to SMA(m)
<b>Flexible System Cables</b>		
HP 70900B 300 MHz OUT 1	HP 70904A 300 MHz IN	HP 8120-5014 100 mm SMB(f) to SMB(f) (1-slot)
HP 70900B 100 MHz IN	HP 70310A 100 MHz	HP 8120-5020 260 mm SMB(f) to SMB(f) (4-slot)
HP 70900B VIDEO IN	* HP 70700A INPUT 2	HP 8120-5014 100 mm SMB(f) to SMB(f) (1-slot)
* HP 70700A INPUT 2	HP 70903A VIDEO OUT	HP 8120-5014 100 mm SMB(f) to SMB(f) (1-slot)
HP 70900B HSWP IN/OUT	* HP 70700A HI SWP	HP 8120-5016 160 mm SMB(f) to SMB(f) (2-slot)
* HP 70700A HI SWP	HP 70700A EXT TRIG	HP 8120-5014 100 mm SMB(f) to SMB(f) (1-slot)
HP 70904A 21.4 MHz OUT	HP 70903A 21.4 MHz IN	HP 8120-5017 205 mm SMB(f) to SMB(f) (3-slot)
HP 70902A VIDEO OUT	HP 70903A VIDEO IN	HP 8120-5014 100 mm SMB(f) to SMB(f) (1-slot)
HP 70902A 21.4 MHz IN	HP 70903A 21.4 MHz OUT	HP 8120-5014 100 mm SMB(f) to SMB(f) (1-slot)
HP 70700A CLK IN	HP 70700A CLK OUT	HP 8120-5014 100 mm SMB(f) to SMB(f) (1-slot)
<b>Miscellaneous Cables</b>		
MSIB interface card	HP 70001A MSIB IN/OUT	HP 70207-60003 2.5 m MSIB Y-cable
External Power Pack	HP 70310A EXT PWR	Built-in External Power Pack Cable

\* On this connector, use an HP 1250-1391 50Ω SMB tee(f) (m) (m) adapter.

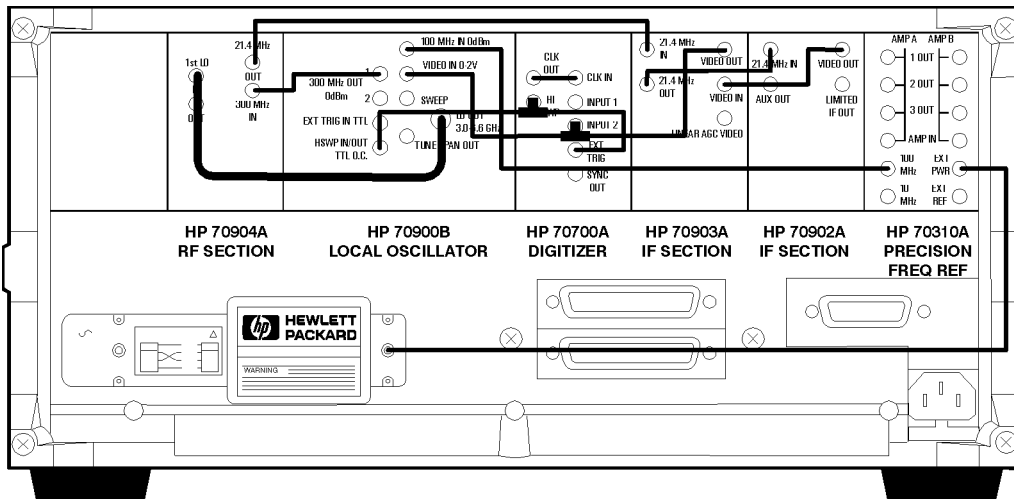

pconfig4.cdr

**Figure 2-49.**  
**HP 71100P Modular Spectrum Analyzer Rear Panel Cabling with HP 70903A IF Section and HP 70700A Digitizer**

## HP 71100P Modular Spectrum Analyzer with HP 70300A RF Tracking Generator

An HP 71100P modular spectrum analyzer with an HP 70300A RF tracking generator consists of the following components:

HP 70001A mainframe	HP 70207A PC Display for MMS
HP 70900B local oscillator source	HP 70902A IF section (10 Hz – 300 KHz)
HP 70904A RF section (100 Hz – 2.9 GHz)	HP 70310A precision frequency reference
HP 70300A RF tracking generator	

R O W	7			70310A P.F.R.	
	6		70904A RF SECT	70300A RFTrckG	
	5				
	4				
	3				
	2				
	1		70902A IF SECT		
	0		70900B LO/CTLR HP-IB 18		
		17	18	19	20
		COLUMN			

DUA12

**Figure 2-50.**  
**Address Map for HP 71100P Modular Spectrum Analyzer with HP 70300A RF Tracking Generator**

- The HP 70001A mainframe does not have an MSIB address.
- The usual address for the HP 70207A PC Display for MMS is ROW 0, COLUMN 2.
- For information about software/firmware compatibility, refer to “Software/Hardware Compatibility” in Chapter 4.

To configure an HP 71100P modular spectrum analyzer with an HP 70300A RF tracking generator, connect the rear panel cables according to the following table.

**CAUTION** To ensure proper electrical connection and prevent connector damage, all APC 3.5 and SMA connectors must be torqued 5 to 8 inch-pounds (finger tight). Do not exceed 8 inch-pounds.

From	To	Cable
<b>Semi-Rigid LO I/O Cables</b>		
HP 70900B LO OUT	HP 70904A 1st LO IN	HP 5021-5449 220 mm SMA(m) to SMA(m)
HP 70904A 1st LO OUT	HP 70300A LO IN	HP 5021-5495 400 mm SMA(m) to SMA(m)
<b>Flexible System Cables</b>		
HP 70900B 300 MHz OUT 1	HP 70904A 300 MHz IN	HP 8120-5014 100 mm SMB(f) to SMB(f) (1-slot)
HP 70900B 300 MHz OUT 2	HP 70300A 300 MHz IN	HP 8120-5020 260 mm SMB(f) to SMB(f) (4-slot)
HP 70900B 100 MHz IN	HP 70310A 100 MHz	HP 8120-5016 160 mm SMB(f) to SMB(f) (2-slot)
HP 70900B TUNE SPAN	HP 70300A TUNE + SPAN	HP 8120-5020 260 mm SMB(f) to SMB(f) (4-slot)
HP 70900B SWEEP	HP 70300A SWEEP IN	HP 8120-5020 260 mm SMB(f) to SMB(f) (4-slot)
HP 70900B VIDEO IN	HP 70902A VIDEO OUT	HP 8120-5014 100 mm SMB(f) to SMB(f) (1-slot)
HP 70904A 21.4 MHz OUT	HP 70902A 21.4 MHz IN	HP 8120-5016 160 mm SMB(f) to SMB(f) (2-slot)
HP 70900B HSWP IN/OUT	HP 70300A HSWP IN	HP 8120-5021 310 mm SMB(f) to SMB(f) (5-slot)
<b>Miscellaneous Cables</b>		
HP 70300A 0-2.9 GHz OUT	HP 70300A 0-2.9 GHz IN	HP 70300-20067 380 mm SMA(m) to SMA(m)
HP 70300A 3.6214 GHz OUT	HP 70300A 3.6214 GHz IN	HP 85660-20101 60 mm SMA(m) to SMA(m)
MSIB interface card	HP 70001A MSIB IN/OUT	HP 70207-60003 2.5 m MSIB Y-cable
External Power Pack	HP 70310A EXT PWR	Built-in External Power Pack Cable

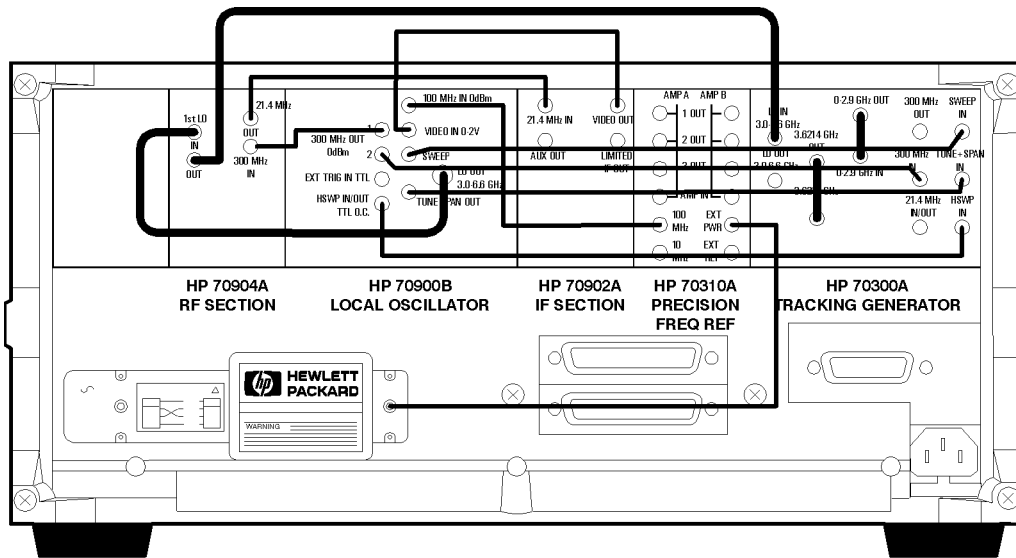

pconfig5.cdr

**Figure 2-51.**  
**HP 71100P Modular Spectrum Analyzer Rear Panel Cabling with an HP 70300A RF Tracking Generator**

## HP 71200P Modular Spectrum Analyzer

An HP 71200P modular spectrum analyzer consists of the following components:

HP 70001A mainframe	HP 70207A PC Display for MMS
HP 70900B local oscillator source	HP 70902A IF section (10 Hz – 300 KHz)
HP 70905A RF section (50 KHz – 22 GHz)	HP 70310A precision frequency reference

R O W	7		70310A P.F.R.		
	6	70905A RF SECT			
	5				
	4				
	3				
	2				
	1	70902A IF SECT			
	0	70900B LO/CTLR HP-IB 18			
		17	18	19	20
		COLUMN			

DUA14

**Figure 2-52. Address Map for HP 71200P Modular Spectrum Analyzer**

- The HP 70001A mainframe does not have an MSIB address.
- The usual address for the HP 70207A PC Display for MMS is ROW 0, COLUMN 2.
- For information about software/firmware compatibility, refer to “Software/Hardware Compatibility” in Chapter 4.



To configure an HP 71200P modular spectrum analyzer, connect the rear panel cables according to the following table.

**CAUTION** To ensure proper electrical connection and prevent connector damage, all APC 3.5 and SMA connectors must be torqued 5 to 8 inch-pounds (finger tight). Do not exceed 8 inch-pounds.

From	To	Cable
<b>Semi-Rigid LO I/O Cable</b> HP 70900B LO OUT	HP 70905A 1st LO IN	HP 5021-5449 220 mm SMA(m) to SMA(m)
<b>Flexible System Cables</b> HP 70900B 300 MHz OUT 1 HP 70900B 100 MHz IN HP 70900B VIDEO IN HP 70905A 21.4 MHz OUT	HP 70905A 300 MHz IN HP 70310A 100 MHz HP 70902A VIDEO OUT HP 70902A 21.4 MHz IN	HP 8120-5014 100 mm SMB(f) to SMB(f) (1-slot) HP 8120-5016 160 mm SMB(f) to SMB(f) (2-slot) HP 8120-5014 100 mm SMB(f) to SMB(f) (1-slot) HP 8120-5016 160 mm SMB(f) to SMB(f) (2-slot)
<b>Miscellaneous Cables</b> HP 70905A 321.4 MHz OUT MSIB interface card External Power Pack	HP 70905A 321.4 MHz IN HP 70001A MSIB IN/OUT HP 70310A EXT PWR	HP 70905-20024 55 mm SMA(m) to SMA(m) HP 70207-60003 2.5 m MSIB Y-cable Built-in External Power Pack Cable

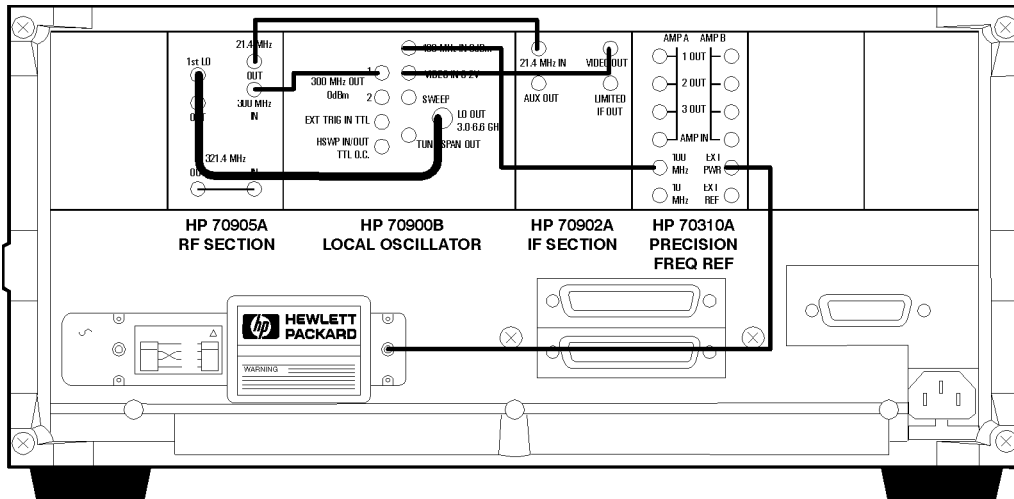

pconfig6.cdr

Figure 2-53. HP 71200P Modular Spectrum Analyzer Rear Panel Cabling

## HP 71200P Modular Spectrum Analyzer with HP 70903A IF Section

An HP 71200P modular spectrum analyzer with HP 70903A IF section, consists of the following components:

HP 70001A mainframe	HP 70207A PC Display for MMS
HP 70900B local oscillator source	HP 70902A IF section (10 Hz – 300 KHz)
HP 70903A IF section (100 KHz – 3 MHz)	HP 70905A RF section (50 KHz – 22 GHz)
HP 70310A precision frequency reference	

R O W	7		70310A P.F.R.		
	6		70905A RF SECT		
	5				
	4		70903A IF SECT		
	3				
	2				
	1		70902A IF SECT		
	0		70900B LO/CTLR HP-IB 18		
		17	18	19	20
		COLUMN			

DUA16

**Figure 2-54.**

### Address Map for HP 71200P Modular Spectrum Analyzer with HP 70903A IF Section

- The HP 70001A mainframe does not have an MSIB address.
- The usual address for the HP 70207A PC Display for MMS is ROW 0, COLUMN 2.
- For information about software/firmware compatibility, refer to “Software/Hardware Compatibility” in Chapter 4.

To configure an HP 71200P modular spectrum analyzer with an HP 70903A IF section, connect the rear panel cables according to the following table.

**CAUTION** To ensure proper electrical connection and prevent connector damage, all APC 3.5 and SMA connectors must be torqued 5 to 8 inch-pounds (finger tight). Do not exceed 8 inch-pounds.

From	To	Cable
<b>Semi-Rigid LO I/O Cable</b> HP 70900B LO OUT	HP 70905A 1st LO IN	HP 5021-5449 220 mm SMA(m) to SMA(m)
<b>Flexible System Cables</b> HP 70900B 300 MHz OUT 1 HP 70900B 100 MHz IN HP 70900B VIDEO IN HP 70905A 21.4 MHz OUT HP 70902A 21.4 MHz IN HP 70902A VIDEO OUT	HP 70905A 300 MHz IN HP 70310A 100 MHz HP 70903A VIDEO OUT HP 70903A 21.4 MHz IN HP 70903A 21.4 MHz OUT HP 70903A VIDEO IN	HP 8120-5014 100 mm SMB(f) to SMB(f) (1-slot) HP 8120-5017 205 mm SMB(f) to SMB(f) (3-slot) HP 8120-5014 100 mm SMB(f) to SMB(f) (1-slot) HP 8120-5016 160 mm SMB(f) to SMB(f) (2-slot) HP 8120-5014 100 mm SMB(f) to SMB(f) (1-slot) HP 8120-5014 100 mm SMB(f) to SMB(f) (1-slot)
<b>Miscellaneous Cables</b> HP 70905A 321.4 MHz OUT MSIB interface card External Power Pack	HP 70905A 321.4 MHz IN HP 70001A MSIB IN/OUT HP 70310A EXT PWR	HP 70905-20024 55 mm SMA(m) to SMA(m) HP 70207-60003 2.5 m MSIB Y-cable Built-in External Power Pack Cable

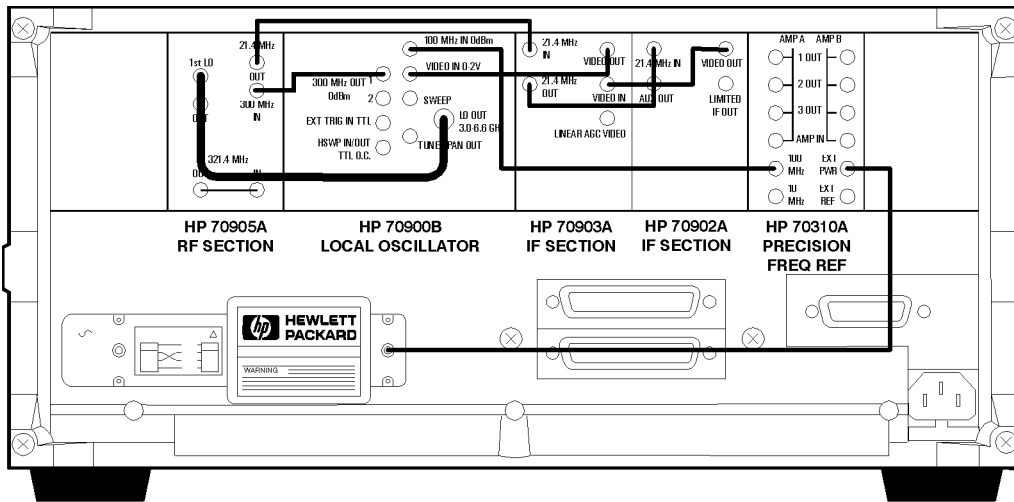

pconfig7.cdr

**Figure 2-55.**  
**HP 71200P Modular Spectrum Analyzer Rear Panel Cabling with HP 70903A IF Section**

## HP 71200P Modular Spectrum Analyzer Deleting HP 70902A IF Section, with HP 70903A IF Section and HP 70907B External Millimeter Interface Module

An HP 71200P modular spectrum analyzer deleting HP 70902A IF section, with HP 70903A IF section and HP 70907B external millimeter interface module consists of the following components:

HP 70001A mainframe	HP 70207A PC Display for MMS
HP 70900B local oscillator source	HP 70903A IF section (100 KHz – 3 MHz)
HP 70905A RF section (50 KHz – 22 GHz)	HP 70310A precision frequency reference
HP 70907B external millimeter interface module	

R O W	7		70310A P.F.R.		
	6		70905A RF SECT		
	5		70907B EMIM		
	4		70903A IF SECT		
	3				
	2				
	1				
	0		70900B LO/CTLR HP-IB 18		
		17	18	19	20
		COLUMN			

DUA18

**Figure 2-56.**

### Address Map for HP 71200P Modular Spectrum Analyzer Deleting HP 70902A IF Section, with HP 70903A IF Section and HP 70907B External Millimeter Interface Module

- The HP 70001A mainframe does not have an MSIB address.
- The usual address for the HP 70207A PC Display for MMS is ROW 0, COLUMN 2.
- For information about software/firmware compatibility, refer to “Software/Hardware Compatibility” in Chapter 4.

To configure an HP 71200P modular spectrum analyzer deleting HP 70902A IF section, with HP 70903A IF section and HP 70907B external millimeter interface module connect the rear panel cables according to the following table.

**CAUTION** To ensure proper electrical connection and prevent connector damage, all APC 3.5 and SMA connectors must be torqued 5 to 8 inch-pounds (finger tight). Do not exceed 8 inch-pounds.

From	To	Cable
<b>Semi-Rigid LO I/O Cables</b>		
HP 70900B LO OUT	HP 70905A 1st LO IN	HP 5021-5449 220 mm SMA(m) to SMA(m)
HP 70905A 1ST LO OUT	HP 70907B LO IN	HP 5021-5448 150 mm SMA(m) to SMA(m)
<b>Flexible System Cables</b>		
HP 70900B 300 MHz OUT 1	HP 70905A 300 MHz IN	HP 8120-5014 100 mm SMB(f) to SMB(f) (1-slot)
HP 70900B 100 MHz IN	HP 70310A 100 MHz	HP 8120-5017 205 mm SMB(f) to SMB(f) (3-slot)
HP 70900B VIDEO IN	HP 70903A VIDEO OUT	HP 8120-5014 100 mm SMB(f) to SMB(f) (1-slot)
HP 70905A 21.4 MHz OUT	HP 70907B 21.4 MHz IN	HP 8120-5014 100 mm SMB(f) to SMB(f) (1-slot)
HP 70900B 300 MHz OUT 2	HP 70907B 300 MHz IN	HP 8120-5016 160 mm SMB(f) to SMB(f) (2-slot)
HP 70907B 21.4 MHz OUT	HP 70903A 21.4 MHz IN	HP 8120-5017 205 mm SMB(f) to SMB(f) (3-slot)
HP 70900B TUNE SPAN	HP 70907B TUNE SPAN	HP 8120-5016 160 mm SMB(f) to SMB(f) (2-slot)
<b>Miscellaneous Cables</b>		
HP 70905A 321.4 MHz OUT	HP 70905A 321.4 MHz IN	HP 70905-20024 55 mm SMA(m) to SMA(m)
MSIB interface card	HP 70001A MSIB IN/OUT	HP 70207-60003 2.5 m MSIB Y-cable
External Power Pack	HP 70310A EXT PWR	Built-in External Power Pack Cable

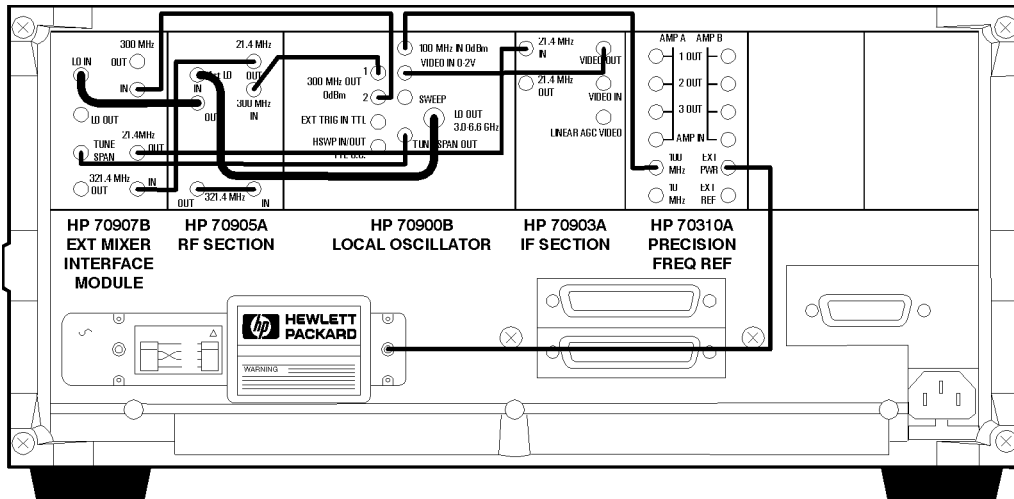

pconfig8.cdr

**Figure 2-57.**  
**HP 71200P Modular Spectrum Analyzer Deleting HP 70902A IF Section, with HP 70903A IF Section and HP 70907B External Millimeter Interface Module Cabling**

**HP 71200P Modular Spectrum Analyzer Deleting HP 70905A RF Section, with HP 70905B RF Section/HP 70600A Preselector**

An HP 71200P modular spectrum analyzer deleting HP 70905A RF section, with HP 70905B RF section/HP 70600A preselector consists of the following components:

- HP 70001A mainframe
- HP 70900B local oscillator source
- HP 70905B RF section (50 KHz - 22 GHz)
- HP 70310A precision frequency reference
- HP 70207A PC Display for MMS
- HP 70902A IF section (10 Hz - 300 KHz)
- HP 70600A preselector

R O W	7		70310A P.F.R.		
	6	70905B RF SECT			
	5				
	4				
	3				
	2		70600A PRE SEL		
	1	70902A IF SECT			
	0	70900B LO/CTLR HP-IB 18			
		17	18	19	20
		COLUMN			

DUA20

**Figure 2-58.**

**Address Map for HP 71200P Modular Spectrum Analyzer Deleting HP 70905A RF Section, with HP 70905B RF Section/HP 70600A Preselector**

- The HP 70001A mainframe does not have an MSIB address.
- The usual address for the HP 70207A PC Display for MMS is ROW 0, COLUMN 2.
- For information about software/firmware compatibility, refer to “Software/Hardware Compatibility” in Chapter 4.

To configure an HP 71200P modular spectrum analyzer deleting HP 70905A RF section, with HP 70905B RF section/HP 70600A preselector connect the rear panel cables according to the following table.

**CAUTION** To ensure proper electrical connection and prevent connector damage, all APC 3.5 and SMA connectors must be torqued 5 to 8 inch-pounds (finger tight). Do not exceed 8 inch-pounds.

From	To	Cable
<b>Semi-Rigid LO I/O Cable</b> HP 70900B LO OUT	HP 70905B 1st LO IN	HP 5021-5449 220 mm SMA(m) to SMA(m)
<b>Flexible System Cables</b> HP 70900B 300 MHz OUT 1 HP 70900B 100 MHz IN HP 70900B VIDEO IN HP 70905B 21.4 MHz OUT HP 70900B TUNE SPAN	HP 70905B 300 MHz IN HP 70310A 100 MHz HP 70902A VIDEO OUT HP 70902A 21.4 MHz IN HP 70600A TUNE SPAN	HP 8120-5014 100 mm SMB(f) to SMB(f) (1-slot) HP 8120-5016 160 mm SMB(f) to SMB(f) (2-slot) HP 8120-5014 100 mm SMB(f) to SMB(f) (1-slot) HP 8120-5016 160 mm SMB(f) to SMB(f) (2-slot) HP 8120-5016 160 mm SMB(f) to SMB(f) (2-slot)
<b>Miscellaneous Cables</b> HP 70905B 321.4 MHz OUT MSIB interface card External Power Pack	HP 70905B 321.4 MHz IN HP 70001A MSIB IN/OUT HP 70310A EXT PWR	HP 70905-20024 55 mm SMA(m) to SMA(m) HP 70207-60003 2.5 m MSIB Y-cable Built-in External Power Pack Cable
<b>Front Panel Cable (Not Shown)</b> HP 70600A RF OUT	HP 70905B RF IN	HP 5021-7403 125 mm SMA(m) to SMA(m)

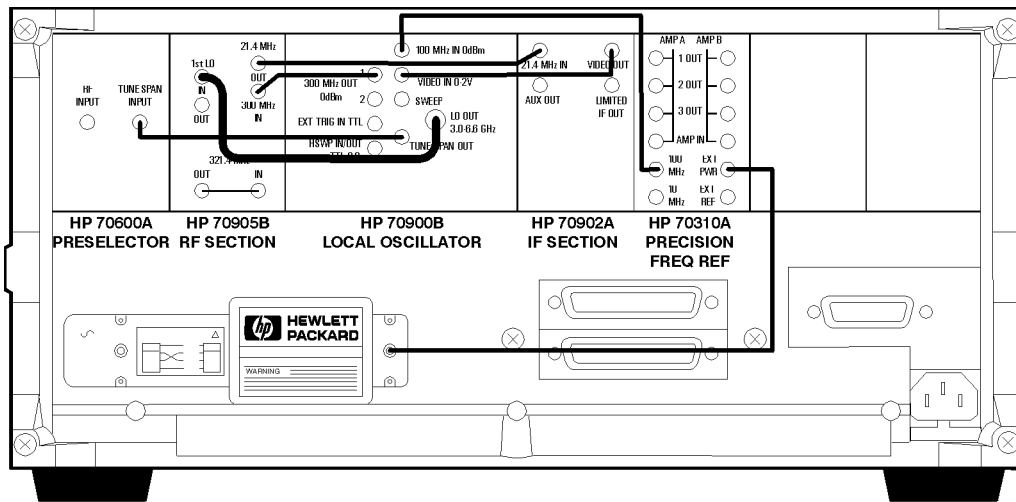

pconfig9.cdr

**Figure 2-59.**  
**HP 71200P Modular Spectrum Analyzer Deleting HP 70905A RF Section, with HP 70905B RF Section/HP 70600A Preselector Cabling**

**HP 71200P Modular Spectrum Analyzer Deleting HP 70905A RF Section, with HP 70905B RF Section/HP 70600A Preselector/HP 70301A Microwave Tracking Generator**

An HP 71200P modular spectrum analyzer deleting HP 70905A RF section, with HP 70905B RF section/HP 70600A preselector/HP 70301A microwave tracking generator consists of the following components:

- |                                        |                                         |
|----------------------------------------|-----------------------------------------|
| HP 70001A mainframe                    | HP 70207A PC Display for MMS            |
| HP 70900B local oscillator source      | HP 70902A IF section (10 Hz – 300 KHz)  |
| HP 70905B RF section (50 KHz – 22 GHz) | HP 70310A precision frequency reference |
| HP 70600A preselector                  | HP 70301A microwave tracking generator  |

R O W	7		70310A P.F.R.		
	6	70905B RF SECT			
	5		70301A uWTrckG		
	4				
	3				
	2		70600A PRE SEL		
	1	70902A IF SECT			
	0	70900B LO/CTLR HP-IB 18			
		17	18	19	20
		COLUMN			

DUA22

**Figure 2-60.**

**Address Map for HP 71200P Modular Spectrum Analyzer Deleting HP 70905A RF Section, with HP 70905B RF Section/HP 70600A Preselector/HP 70301A Microwave Tracking Generator**

- The HP 70001A mainframe does not have an MSIB address.
- The usual address for the HP 70207A PC Display for MMS is ROW 0, COLUMN 2.
- For information about software/firmware compatibility, refer to “Software/Hardware Compatibility” in Chapter 4.



To configure an HP 71200P modular spectrum analyzer deleting HP 70905A RF section, with HP 70905B RF section/HP 70600A preselector/HP 70301A microwave tracking generator, connect the cables according to the following table.

**CAUTION** To ensure proper electrical connection and prevent connector damage, all APC 3.5 and SMA connectors must be torqued 5 to 8 inch-pounds (finger tight). Do not exceed 8 inch-pounds.

From	To	Cable
<b>Flexible LO I/O Cable</b>		
HP 70900B LO OUT	HP 70905B 1st LO IN	HP 5061-9038 520 mm SMA(m) to SMA(m)
<b>Semi-Rigid LO I/O Cable</b>		
HP 70905B 1ST LO OUT	HP 70301A LO IN	HP 5021-5494 400 mm SMA(m) to SMA(m)
<b>Flexible System Cables</b>		
HP 70900B 300 MHz OUT 1	HP 70905A 300 MHz IN	HP 8120-5025 490 mm SMB(f) to SMB(f)
HP 70900B 100 MHz IN	HP 70310A 100 MHz	HP 8120-5016 160 mm SMB(f) to SMB(f) (2-slot)
HP 70900B VIDEO IN	HP 70902A VIDEO OUT	HP 8120-5014 100 mm SMB(f) to SMB(f) (1-slot)
HP 70900B TUNE SPAN	* HP 70301A TUNE SPAN	HP 8120-5022 365 mm SMB(f) to SMB(f) (6-slot)
HP 70905B 21.4 MHz OUT	HP 70902A 21.4 MHz IN	HP 8120-5025 490 mm SMB(f) to SMB(f)
* HP 70301A TUNE SPAN	HP 70600A TUNE SPAN	HP 8120-5020 260 mm SMB(f) to SMB(f) (4-slot)
HP 70900B 300 MHz OUT 2	HP 70301A 300 MHz IN	HP 8120-5020 260 mm SMB(f) to SMB(f) (4-slot)
HP 70301A 21.4 MHz IN	HP 70301A 21.4 MHz OUT	HP 8120-5014 100 mm SMB(f) to SMB(f) (1-slot)
<b>Miscellaneous Cables</b>		
HP 70905B 321.4 MHz OUT	HP 70905B 321.4 MHz IN	HP 70905-20024 55 mm SMA(m) to SMA(m)
MSIB interface card	HP 70001A MSIB IN/OUT	HP 70207-60003 2.5 m MSIB Y-cable
External Power Pack	HP 70310A EXT PWR	Built-in External Power Pack Cable
<b>Front Panel Cable (Not Shown)</b>		
HP 70600A RF OUT	HP 70905B RF IN	HP 5021-7403 125 mm SMA(m) to SMA(m)
* On this connector, use an HP 1250-1391 50Ω SMB tee(f) (m) (m) adapter.		

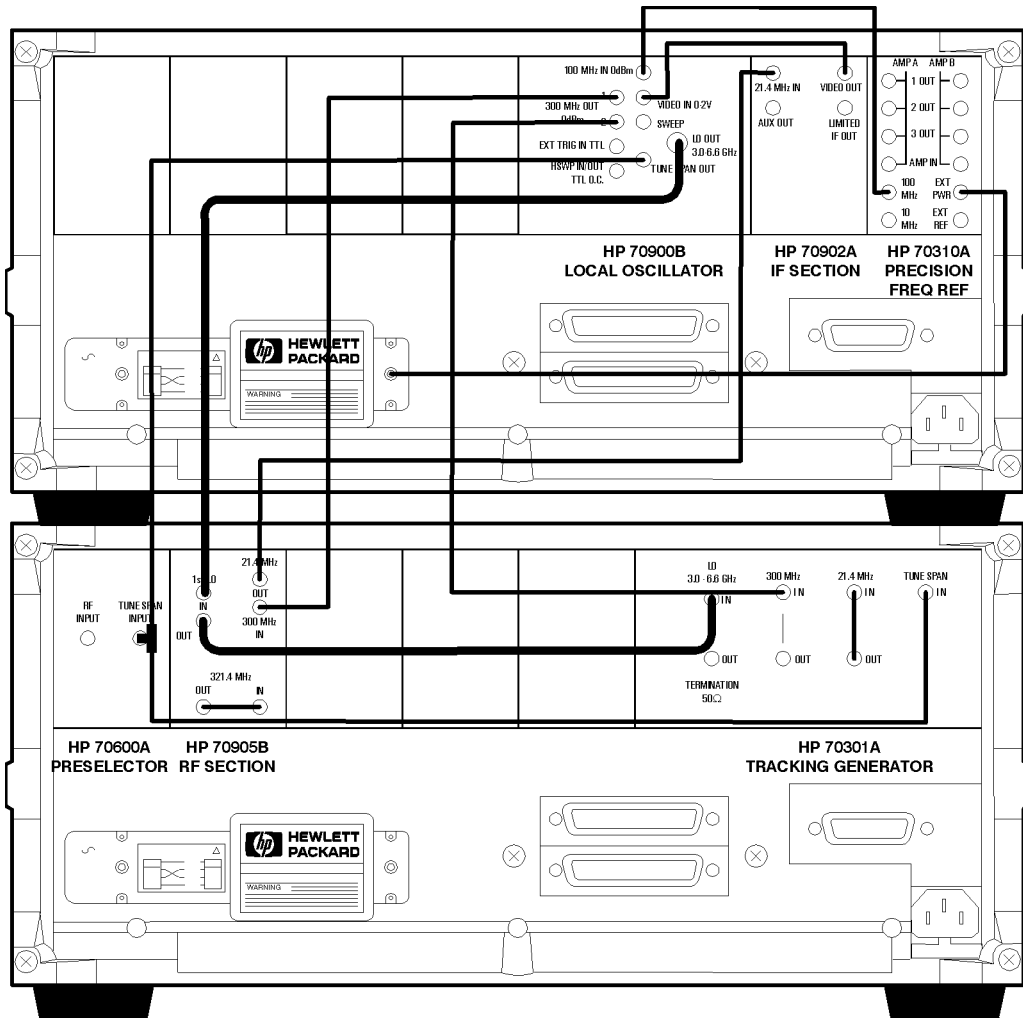

pconfg10.cdr

**Figure 2-61.**  
**HP 71200P Modular Spectrum Analyzer Deleting HP 70905A RF Section, with HP 70905B**  
**RF Section/HP 70600A Preselector/HP 70301A Microwave Tracking Generator Cabling**

## HP 71209P Microwave Spectrum Analyzer

An HP 71209P microwave spectrum analyzer consists of the following components:

HP 70001A mainframe	HP 70207A PC Display for MMS
HP 70900B local oscillator source	HP 70902A IF section (10 Hz – 300 KHz)
HP 70903A IF section (100 KHz – 3 MHz)	HP 70909A RF section (100 Hz – 26.5 GHz)
HP 70310A precision frequency reference	or HP 70910A RF section (100 Hz – 26.5 GHz)

R O W	7		70310A FREQ REF		
	6		70909A RF SECT		
	5				
	4		70903A IF SECT		
	3				
	2				
	1		70902A IF SECT		
	0		70900B LO/CTLR HP-IB18		
		17	18	19	20
		COLUMN			

DUA57

**Figure 2-62. Address Map for HP 71209P Microwave Spectrum Analyzer**

- The HP 70001A mainframe does not have an MSIB address.
- The usual address for the HP 70207A PC Display for MMS is ROW 0, COLUMN 2.
- Refer to Chapter 1 for information about software/firmware compatibility.

To configure an HP 71209P microwave spectrum analyzer, connect the rear panel cables according to the following table.

**CAUTION** To ensure proper electrical connection and prevent connector damage, all APC 3.5 and SMA connectors must be torqued 5 to 8 inch-pounds (finger tight). Do not exceed 8 inch-pounds.

From	To	Cable
<b>Semi-Rigid LO I/O Cable</b> HP 70900B LO OUT	HP 70909A 1st LO IN	HP 5021-5450 260 mm SMA(m) to SMA(m)
<b>Flexible System Cables</b> HP 70900B 300 MHz OUT 1 HP 70900B 100 MHz IN HP 70900B VIDEO IN HP 70909A 21.4 MHz OUT HP 70900B TUNE SPAN HP 70902A VIDEO OUT HP 70902A 21.4 MHz IN	HP 70909A 300 MHz IN HP 70310A 100 MHz OUT HP 70903A VIDEO OUT HP 70903A 21.4 MHz IN HP 70909A TUNE SPAN HP 70903A VIDEO IN HP 70903A 21.4 MHz OUT	HP 8120-5014 100 mm SMB(f) to SMB(f) (1-slot) HP 8120-5017 205 mm SMB(f) to SMB(f) (3-slot) HP 8120-5014 100 mm SMB(f) to SMB(f) (1-slot) HP 8120-5017 205 mm SMB(f) to SMB(f) (3-slot) HP 8120-5016 160 mm SMB(f) to SMB(f) (2-slot) HP 8120-5014 100 mm SMB(f) to SMB(f) (1-slot) HP 8120-5014 100 mm SMB(f) to SMB(f) (1-slot)
<b>Miscellaneous Cables</b> MSIB interface card External Power Pack	HP 70001A MSIB IN/OUT HP 70310A EXT PWR	HP 70207-60003 2.5 m MSIB Y-cable Built-in External Power Pack Cable

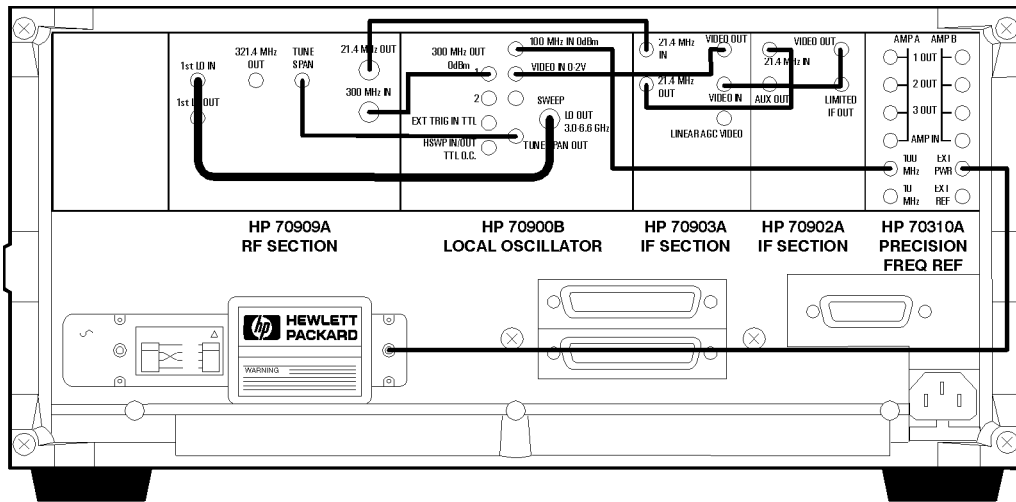

pconfg11.cdr

Figure 2-63. HP 71209P Microwave Spectrum Analyzer Rear Panel Cabling

## HP 71210P Microwave Spectrum Analyzer

An HP 71210P microwave spectrum analyzer consists of the following components:

HP 70001A mainframe	HP 70207A PC Display for MMS
HP 70900B local oscillator source	HP 70902A IF section (10 Hz – 300 KHz)
HP 70903A IF section (100 KHz – 3 MHz)	HP 70908A RF section (100 Hz – 22 GHz)
HP 70310A precision frequency reference	

R O W	7		70310A P.F.R.		
	6	70908A RF SECT			
	5				
	4	70903A IF SECT			
	3				
	2				
	1	70902A IF SECT			
	0	70900B LO/CTLR HP-IB 18			
		17	18	19	20
		COLUMN			

DUA24

**Figure 2-64. Address Map for HP 71210P Microwave Spectrum Analyzer**

- The HP 70001A mainframe does not have an MSIB address.
- The usual address for the HP 70207A PC Display for MMS is ROW 0, COLUMN 2.
- For information about software/firmware compatibility, refer to “Software/Hardware Compatibility” in Chapter 4.

To configure an HP 71210P microwave spectrum analyzer, connect the rear panel cables according to the following table.

**CAUTION** To ensure proper electrical connection and prevent connector damage, all APC 3.5 and SMA connectors must be torqued 5 to 8 inch-pounds (finger tight). Do not exceed 8 inch-pounds.

From	To	Cable
<b>Semi-Rigid LO I/O Cable</b> HP 70900B LO OUT	HP 70908A 1st LO IN	HP 5021-5450 260 mm SMA(m) to SMA(m)
<b>Flexible System Cables</b> HP 70900B 300 MHz OUT 1 HP 70900B 100 MHz IN HP 70900B VIDEO IN HP 70908A 21.4 MHz OUT HP 70900B TUNE SPAN HP 70902A VIDEO OUT HP 70902A 21.4 MHz IN	HP 70908A 300 MHz IN HP 70310A 100 MHz HP 70903A VIDEO OUT HP 70903A 21.4 MHz IN HP 70908A TUNE SPAN HP 70903A VIDEO IN HP 70903A 21.4 MHz OUT	HP 8120-5014 100 mm SMB(f) to SMB(f) (1-slot) HP 8120-5017 205 mm SMB(f) to SMB(f) (3-slot) HP 8120-5014 100 mm SMB(f) to SMB(f) (1-slot) HP 8120-5016 160 mm SMB(f) to SMB(f) (2-slot) HP 8120-5016 160 mm SMB(f) to SMB(f) (2-slot) HP 8120-5014 100 mm SMB(f) to SMB(f) (1-slot) HP 8120-5014 100 mm SMB(f) to SMB(f) (1-slot)
<b>Miscellaneous Cables</b> MSIB interface card External Power Pack	HP 70001A MSIB IN/OUT HP 70310A EXT PWR	HP 70207-60003 2.5 m MSIB Y-cable Built-in External Power Pack Cable

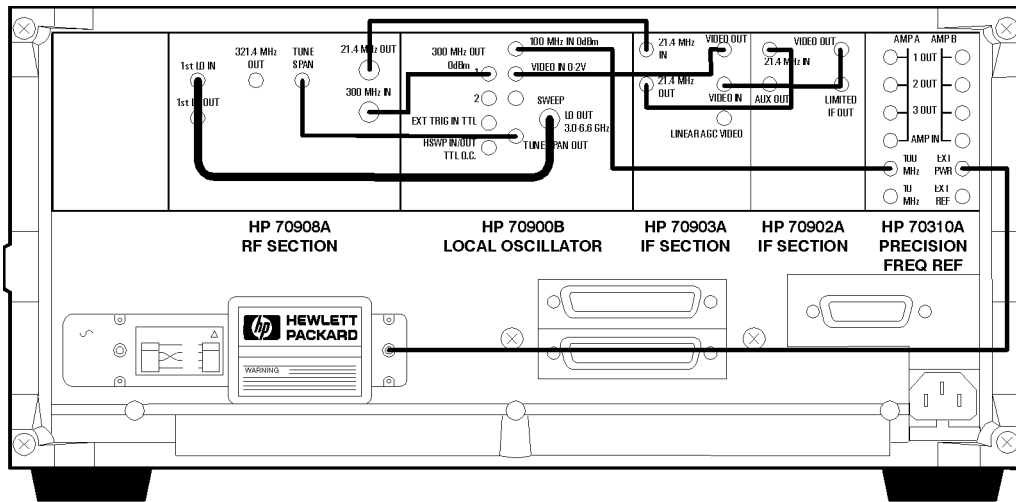

pconfg13.cdr

Figure 2-65. HP 71210P Microwave Spectrum Analyzer Rear Panel Cabling

## HP 71210P Microwave Spectrum Analyzer with HP 70907B external millimeter interface module Added

An HP 71210P microwave spectrum analyzer with HP 70907B external millimeter interface module consists of the following components:

- |                                         |                                                |
|-----------------------------------------|------------------------------------------------|
| HP 70001A mainframe                     | HP 70207A PC Display for MMS                   |
| HP 70900B local oscillator source       | HP 70902A IF section (10 Hz – 300 KHz)         |
| HP 70903A IF section (100 KHz – 3 MHz)  | HP 70908A RF section (100 Hz – 22 GHz)         |
| HP 70310A precision frequency reference | HP 70907B external millimeter interface module |

R O W	7		70310A P.F.R.	
	6	70908A RF SECT		
	5	70907B EMIM		
	4	70903A IF SECT		
	3			
	2			
	1	70902A IF SECT		
	0	70900B LO/CTLR HP-IB 18		
	17	18	19	20
	COLUMN			

DUA24A

**Figure 2-66.**

### Address Map for HP 71210P Microwave Spectrum Analyzer with HP 70907B external millimeter interface module Added

- The HP 70001A mainframe does not have an MSIB address.
- The usual address for the HP 70207A PC Display for MMS is ROW 0, COLUMN 2.
- For information about software/firmware compatibility, refer to “Software/Hardware Compatibility” in Chapter 4.

To configure an HP 71210P microwave spectrum analyzer with HP 70907B external millimeter interface module, connect the rear panel cables according to the following table.

**CAUTION** To ensure proper electrical connection and prevent connector damage, all APC 3.5 and SMA connectors must be torqued 5 to 8 inch-pounds (finger tight). Do not exceed 8 inch-pounds.

From	To	Cable
<b>Semi-Rigid LO I/O Cable</b>		
HP 70900B LO OUT	HP 70908A 1st LO IN	HP 5021-5450 260 mm SMA(m) to SMA(m)
HP 70908A LO OUT	HP 70907B LO IN	HP 5021-5448 150 mm SMA(m) to SMA(m)
<b>Flexible System Cables</b>		
HP 70900B 300 MHz OUT 1	HP 70908A 300 MHz IN	HP 8120-5014 100 mm SMB(f) to SMB(f) (1-slot)
HP 70900B 300 MHz OUT 2	HP 70907B 300 MHz IN	HP 8120-5017 205 mm SMB(f) to SMB(f) (3-slot)
HP 70907B 21.4 MHz OUT	HP 70903A 21.4 MHz IN	HP 8120-5020 260 mm SMB(f) to SMB(f) (4-slot)
HP 70900B 100 MHz IN	HP 70310A 100 MHz	HP 8120-5017 205 mm SMB(f) to SMB(f) (3-slot)
HP 70900B VIDEO IN	HP 70903A VIDEO OUT	HP 8120-5014 100 mm SMB(f) to SMB(f) (1-slot)
HP 70908A 21.4 MHz OUT	HP 70907B 21.4 MHz IN	HP 8120-5016 160 mm SMB(f) to SMB(f) (2-slot)
HP 70900B TUNE SPAN	HP 70908A TUNE SPAN	HP 8120-5016 160 mm SMB(f) to SMB(f) (2-slot)
* HP 70908A TUNE SPAN	HP 70907B TUNE SPAN	HP 8120-5016 160 mm SMB(f) to SMB(f) (2-slot)
HP 70902A VIDEO OUT	HP 70903A VIDEO IN	HP 8120-5014 100 mm SMB(f) to SMB(f) (1-slot)
HP 70902A 21.4 MHz IN	HP 70903A 21.4 MHz OUT	HP 8120-5014 100 mm SMB(f) to SMB(f) (1-slot)
<b>Miscellaneous Cables</b>		
MSIB interface card	HP 70001A MSIB IN/OUT	HP 70207-60003 2.5 m MSIB Y-cable
External Power Pack	HP 70310A EXT PWR	Built-in External Power Pack Cable

\* On this connector, use an HP 1250-1391 50Ω SMB tee(f) (m) (m) adapter.

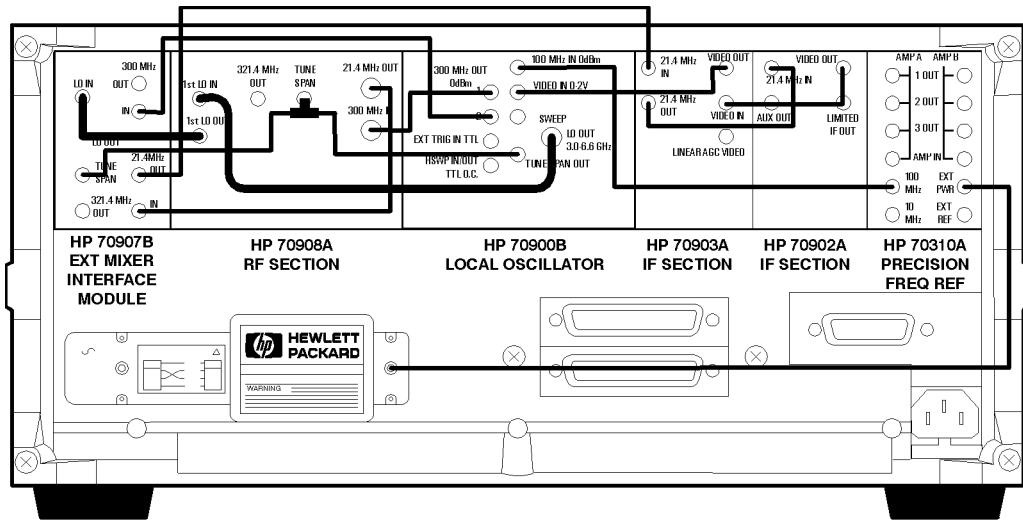

pcconfg12.cdr

**Figure 2-67.**  
**HP 71210P Microwave Spectrum Analyzer with HP 70907B External Millimeter Interface Module Rear Panel Cabling**



---

## System Replaceable Parts

Tables of system-level part numbers and ordering information are included in this section.

- A list of standard systems including model numbers, modules, and system options can be found in Chapter 3.
- The replaceable parts table in this section lists system-level replacement parts, cable assemblies, and service accessories by part number.

## Ordering Information

To order a part listed in the replaceable parts list, contact the nearest Hewlett-Packard Sales or Service Office and provide the following information:

- Hewlett-Packard part number and quantity required.
- Check digit (CD) of each part, if available.
- Name and address for delivery and billing.

Parts that are not listed in the replaceable parts list may be ordered by contacting the nearest Hewlett-Packard Sales or Service Office and providing the following information:

- Element or mainframe model number that needs the replacement part (such as HP 70904A RF section).
- Element or mainframe serial number.
- Description, function, and quantity of each part required.
- Name and address for delivery and billing.

## Direct Mail-Order System

Hewlett-Packard can supply parts through direct mail order within the United States. Advantages of using this method are listed below:

- Direct ordering and shipments from the HP Parts Center in Mountain View, California.
- No maximum or minimum requirements exist on any mail order.
- Prepaid transportation fee (although there is a small handling charge for each order).
- No invoices—a check or money order must accompany each order.

Mail order forms and specific ordering information are available through your local Hewlett-Packard Sales and Service Office.

**Table 2-3. System Replacement Parts Listing**

HP Part Number	CD	Description
<b>Miscellaneous System-Level Parts</b>		
2110-0703	7	Fuse, 6.3 A, 250 V
5061-9006	9	Panel-Mainframe Front Blank 1/8 module width
70001-40017	7	Filter-Mainframe Air
70001-60059	9	Cabinet Interconnecting Kit (HP 70001A mainframe to HP 70001A mainframe)
5061-9061	6	Cabinet Interconnecting Kit (HP 70001A mainframe to HP 70206A system graphics display)
1420-0315	3	Battery for HP 70205A graphics display and HP 70206A system graphics display, 3.60V 1.7 AH
70001-60066	8	Isolation-Transformer Assembly for HP 70001A mainframe and HP 70206A system graphics display (400 Hz operation)
70310-60016	2	Power Pack-External for HP 70310A precision frequency reference (except Module Option 002)
5061-9678	1	Rack Flange Kit (to mount HP 70001A mainframe/HP 70206A system graphics display without handles)
5062-3979	5	Rack Flange Kit (to mount HP 70004A color display without handles)
5062-4072	1	Rack Flange Kit (to mount HP 70001A mainframe/HP 70206A system graphics display with handles)
5062-4073	2	Rack Flange Kit (to mount HP 70004A color display with handles)
5062-0781	1	Rack Mount with Slides for HP 70001A mainframe
5062-0782	2	Rack Mount with Slides for HP 70206A system graphics display
5062-7086	3	Rack Mount with Slides for HP 70004A color display
<b>System Adapters</b>		
1494-0064	4	Adapter Kit for non-HP Racks (also included in 5062-0781)
1494-0061	1	Adapter Kit for non-HP Racks (also included in 5062-0782) <i>(See System Configuration for cabling examples)</i>
<b>System Interconnecting MSIB Cables</b>		
(Two or more MSIB cables are needed for each "A" or "C" system. An MSIB Y-cable is used in each "P" system. Additional cables can be added using the MSIB cable adapter.)		
HP 70800A	5	Cable—MSIB 0.5 m
HP 70800B	6	Cable—MSIB 1.0 m
HP 70800C	7	Cable—MSIB 2.0 m
HP 70800D	8	Cable—MSIB 6.0 m
HP 70800E	9	Cable—MSIB 30 m
70207-60003	1	Cable—MSIB Y-cable 2.5 m
70207-20003	7	Adapter—MSIB cable adapter

**Table 2-3. System Replacement Parts Listing (continued)**

HP Part Number	CD	Description
<b>Semirigid LO Cables</b> (To connect LO OUT to LO IN with the LO module on the right hand side of the RF module, as viewed from the back)		
5021-5448	1	Cable-Semirigid Coax LO 1/8-width SMA
5021-5449	2	Cable-Semirigid Coax LO 2/8-width SMA
5021-5450	5	Cable-Semirigid Coax LO 3/8-width SMA
5021-5451	6	Cable-Semirigid Coax LO 4/8-width SMA
5021-5452	7	Cable-Semirigid Coax LO 5/8-width SMA
5021-5453	8	Cable-Semirigid Coax LO 6/8-width SMA
5021-5454	9	Cable-Semirigid Coax LO 7/8-width SMA
<b>Semirigid LO Cables</b> (To connect LO OUT to LO IN with the LO module on the left hand side of the RF module, as viewed from the back)		
5021-5491	4	Cable-Semirigid Coax LO 1/8-width SMA
5021-5492	5	Cable-Semirigid Coax LO 2/8-width SMA
5021-5493	6	Cable-Semirigid Coax LO 3/8-width SMA
5021-5494	7	Cable-Semirigid Coax LO 4/8-width SMA
5021-5495	8	Cable-Semirigid Coax LO 5/8-width SMA
5021-5496	9	Cable-Semirigid Coax LO 6/8-width SMA
5021-5497	0	Cable-Semirigid Coax LO 7/8-width SMA
<b>Flexible Coax IF/Video/Ref Cables and Adapters</b>		
8120-5014	0	Cable-Flex Coax SMB(f)—SMB(f) (100 mm)
8120-5015	1	Cable-Flex Coax SMB(f)—SMB(f) (120 mm)
8120-5016	2	Cable-Flex Coax SMB(f)—SMB(f) (160 mm)
8120-5017	3	Cable-Flex Coax SMB(f)—SMB(f) (205 mm)
8120-5018	4	Cable-Flex Coax SMB(f)—SMB(f) (315 mm)
8120-5019	5	Cable-Flex Coax SMB(f)—SMB(f) (400 mm)
8120-5020	8	Cable-Flex Coax SMB(f)—SMB(f) (260 mm)
8120-5021	9	Cable-Flex Coax SMB(f)—SMB(f) (310 mm)
8120-5022	0	Cable-Flex Coax SMB(f)—SMB(f) (365 mm)
8120-5023	1	Cable-Flex Coax SMB(f)—SMB(f) (410 mm)
8120-5024	2	Cable-Flex Coax SMB(f)—SMB(f) (445 mm)
8120-5025	3	Cable-Flex Coax SMB(f)—SMB(f) (490 mm)
8120-5026	4	Cable-Flex Coax SMB(f)—SMB(f) (620 mm)
1250-1391	6	Adapter—Tee, SMB

**Table 2-3. System Replacement Parts Listing (continued)**

<b>HP Part Number</b>	<b>CD</b>	<b>Description</b>
<b>Miscellaneous System Cables</b>		
5061-9038	7	Cable-Flex Coax LO SMA(m)—SMA(m) (520 mm)
5061-9039	8	Cable-Flex Coax LO SMA(m)—SMA(m) (745 mm)
5021-7401	0	Cable HP 70600A preselector to HP 70906A RF section
5021-7402	1	Cable HP 70600A preselector to HP 70905A RF section
5021-7403	2	Cable HP 70600A preselector to HP 70905B RF section
5021-9931	5	Cable HP 70620B preamplifier to HP 70906A RF section
5021-9952	0	Cable HP 70620B preamplifier to HP 70908A RF section
5022-0003	6	Cable HP 70620B preamplifier to HP 70904A RF section/ HP 70905A RF section
5022-0081	0	Cable HP 70620B preamplifier to HP 70905B RF section
5022-0137	7	Cable HP 70620B preamplifier to HP 70909A RF section/ HP 70910A RF section
<b>Optical Input Connectors (Lightwave)</b>		
<b>Single-Mode Fiber Connectors</b>		
HP 81000AI	6	Diamond HMS-10/HP
HP 81000FI	2	FC/PC
HP 81000JI	2	SMA
HP 81000SI	9	DIN 47256
HP 81000VI	2	ST
HP 81000WI	3	Biconic
<b>System Service Accessories</b>		
70001-60013	5	Module Service Extender
8710-1307	7	8mm Hex Ball Driver—6-1/2 inch shaft
8710-1651	4	8mm Hex Ball Driver—1-3/4 inch shaft
85680-60093	3	Cable—SMB (f) to BNC (m)
8120-1578	3	Cable—SMA (f) to SMA (m)
1251-2277	1	Adapter—BNC (f) to Dual Banana (f)
1250-1159	4	Adapter—SMA (m) to SMA (m)
8500-2163	0	Display Cleaner, thin-film cleaner
71000-60002	3	System Service Kit
70900-60102	1	LO Service Kit
70206-60058	5	Display Service Kit
71000-60003	4	System Reconfiguration Cable Kit

## Specifications and Characteristics

---

This chapter contains two types of specifications:

- System specification information for HP 70000 Series modular spectrum analyzer systems which have an HP 70900B local oscillator source as the master.
- Module characteristics information related to the modules used in the predefined systems.

Tables in this chapter list specifications, *characteristics*, typical performance, and nominal values.

The distinction between these terms is described as follows:

- Specifications describe warranted performance over the temperature range 0°C to +55°C (unless otherwise noted). All specifications apply after the instrument's temperature has been stabilized after 1 hour continuous operation, self-calibration routines have been run, and the preselector peak functions have been executed. Unless otherwise noted, corrected limits are given when specifications are subject to minimization with error-correction routines.
- *Characteristics* provide useful information by giving functional, but nonwarranted, performance parameters. *Characteristics are printed in italics.*
- Typical Performance, where listed, is not *warranted*, but indicates performance which most units will meet.
- Nominal Value indicates the expected, but not *warranted*, value of the parameter.

---

### System Specifications

The system specification information in this section is for HP 70000 Series modular spectrum analyzer systems which have an HP 70900B local oscillator source as the master. Specifications for the following systems are included:

- HP 71100C modular spectrum analyzer
- HP 71200C modular spectrum analyzer
- HP 71209A microwave spectrum analyzer
- HP 71210C microwave spectrum analyzer
- HP 71400C lightwave signal analyzer
- HP 71401C lightwave signal analyzer

---

**Note** For specifications of a particular “P” system, refer to the corresponding “A” or “C” system.

---

## System Components

HP 70000 Series modular spectrum analyzer systems and lightwave signal analyzers consist of the following elements.

**Table 3-1. Model Numbers, Modules, and System Options**

HP 71100C	HP 71200C	HP 71209A	HP 71210C	HP 71400C	HP 71401C
HP 70001A	HP 70001A	HP 70001A	HP 70001A	HP 70001A	HP 70001A
HP 70310A	HP 70310A	HP 70310A	HP 70310A	HP 70310A	HP 70310A
HP 70004A	HP 70004A	HP 70004A	HP 70004A	HP 70004A	HP 70004A
HP 70900B	HP 70900B	HP 70900B	HP 70900B	HP 70900B	HP 70900B
HP 70902A	HP 70902A	HP 70902A	HP 70902A	HP 70902A	HP 70902A
		HP 70903A	HP 70903A	HP 70903A	
HP 70904A	HP 70905A	HP 70909A	HP 70908A <sup>1</sup>	HP 70908A <sup>1</sup>	HP 70904A
			HP 70810B	HP 70810B	
	Option 001 HP 70906A <sup>2</sup>	Option 001 HP 70910A		Option 850 HP 70810B	Option 850 HP 70810B
	Option 002 HP 70905B HP 70600A				
	Option 003 HP 70906B <sup>2</sup> HP 70601A <sup>2</sup>				

<sup>1</sup> Applies to an HP 70908A RF section with serial number prefix 2S18A or later.

<sup>2</sup> This module is obsolete.

The following options apply to an HP 71200C modular spectrum analyzer:

- Option 001 Replaces the HP 70905A RF section with the HP 70906A RF section. This extends the frequency range to 26.5 GHz.
- Option 002 Replaces the HP 70905A RF section with an HP 70905B RF section and an HP 70600A preselector providing preselection up to 22.0 GHz.
- Option 003 Replaces the HP 70905A RF section with an HP 70906B RF section and an HP 70601A preselector providing preselection up to 26.5 GHz.

The *System Operation Verification Software* is used to verify whether spectrum analyzer system performance meets its major specifications. Refer to Chapter 4 for information on running the program.

### 3-2 Specifications and Characteristics

# HP 71100C Modular Spectrum Analyzer Specifications and Characteristics

The specifications in this table apply to the HP 71100C modular spectrum analyzer.

**Table 3-2.**  
**HP 71100C Modular Spectrum Analyzer Specifications and Characteristics**

<b>FREQUENCY</b>	
<b>Frequency Range</b>	100 Hz to 2.9 GHz (dc coupled)  100 kHz to 2.9 GHz (ac coupled) tunable in 1 Hz increments
<b>Frequency Readout Accuracy</b> Span ≤ 10 MHz  Span > 10 MHz sweep ≥ 20 ms  sweep ≥ 10 ms	± ((frequency readout × frequency reference error) + 1% of span + 10 Hz)  ± ((frequency readout × frequency reference error) + 1.5% of span + 10 Hz)  ± ((frequency readout × frequency reference error) + 2.5% of span + 10 Hz)
<b>Frequency Reference Error</b> (Internal Reference)	frequency reference adjustment error + (frequency reference accuracy aging × time since last adjustment) + frequency reference accuracy temperature drift
<b>Frequency Reference Accuracy</b> Aging  Temperature Drift  Without HP 70310A Precision Frequency Reference Aging  Temperature Drift	< $5 \times 10^{-10}$ /day (7 day average) < $1 \times 10^{-7}$ /year  < $7 \times 10^{-9}$  < $3 \times 10^{-6}$ /year  < $1 \times 10^{-5}$

**Table 3-2.  
HP 71100C Modular Spectrum Analyzer Specifications and  
Characteristics (continued)**

<b>FREQUENCY (Continued)</b>	
<p><b>Frequency Span</b></p> <p>Range</p> <p>Accuracy</p> <p>Span <math>\leq</math> 10 MHz</p> <p>Span <math>&gt;</math> 10 MHz sweep <math>\geq</math> 50 ms</p> <p>sweep <math>\geq</math> 20 ms</p> <p>sweep <math>\geq</math> 10 ms</p>	<p>0 to 2.9 GHz, in 0.5% increments</p> <p><math>\pm</math> (1% of span + (span <math>\times</math> frequency reference error))</p> <p><math>\pm</math> (1.5% of span + (span <math>\times</math> frequency reference error))</p> <p><math>\pm</math> (2.5% of span + (span <math>\times</math> frequency reference error))</p> <p><math>\pm</math> (4.0% of span + (span <math>\times</math> frequency reference error))</p>
<p><b>Frequency Drift</b></p>	<p><math>\pm</math>1 kHz/s and <math>\pm</math>150 kHz/<math>^{\circ}</math>C</p> <p>For spans <math>&gt;</math> 10 MHz, frequency drift during one sweep.</p> <p>Errors due to drift are not cumulative from sweep to sweep.</p>
<p><b>Resolution Bandwidths *</b></p> <p>3 dB, synchronously-tuned approximately Gaussian shape</p> <p>Range</p> <p>Accuracy</p> <p>Selectivity (<math>-60</math> dB/<math>-3</math> dB)</p> <p>10 Hz to 3 kHz bandwidths</p> <p>10 kHz to 300 kHz bandwidths</p>	<p>10 Hz to 300 kHz, adjustable in 1, 3, 10 sequence, and in 10% increments, except 3 kHz to 10 kHz</p> <p><math>\pm</math>20%</p> <p><math>&lt;</math> 12:1</p> <p><math>&lt;</math> 16:1</p>
<p><b>Video Bandwidth *</b></p> <p>Range</p>  <p><i>Accuracy (characteristic)</i></p>	<p>3 Hz to 300 kHz in 1, 3, 10 sequence.</p> <p>When set to 300 kHz the filter is off and has an effective value of <math>&gt;</math> 300 kHz.</p> <p><math>\pm</math>20%</p>
<p>* This specification may change when modules are added or deleted.</p>	



**Table 3-2.  
HP 71100C Modular Spectrum Analyzer Specifications and  
Characteristics (continued)**

<b>FREQUENCY (Continued)</b>	
<b>Residual FM</b> Span > 10 MHz  Span ≤ 10 MHz	< 25 kHz peak-to-peak in 0.1 s (measurement BW = 100 kHz)  In synthesized spans, residual FM is determined by noise sidebands. See Spectral Purity specifications for values.
<b>Spectral Purity</b> 0 to 2.9 GHz Noise Sidebands at 10 kHz offset:  Line-, System-, and Synthesis-Related Sidebands	< -108 dBc/Hz  < -65 dBc
<b>AMPLITUDE</b>	
<b>Maximum Safe Input Power</b> ac Average Continuous Power  Pulse Power  dc	30 dBm (input attenuation ≥ 10 dB)  100 W, 10 μs pulse (≥ 20 dB input attenuation)  0 V (dc coupled) ±25 V (ac coupled)
<b>Gain Compression</b> 0 dB input attenuation	< 0.5 dB for signal levels ≤ -10 dBm
<b>Displayed Average Noise Level*</b>  Frequency Range 10 MHz to 2.0 GHz 2.0 GHz to 2.9 GHz	(10 Hz resolution BW, 3 Hz video bandwidth, 0 dB attenuation)  < -134 dBm < -131 dBm
* This specification may change when modules are added or deleted.	

**Table 3-2.  
HP 71100C Modular Spectrum Analyzer Specifications and  
Characteristics (continued)**

<b>AMPLITUDE (Continued)</b>	
<b>Display Range</b> Calibration Log Scale  Linear Scale  Reference Level Range Log  Linear	0.01 to 20 dB/division in increments of 0.5% (10 division display)  10% of reference level/division (10 division display)  30 dBm to -140 dBm  7.07 V to 22 nV (50Ω system)
<b>Nonsynthesis-Related Spurious Responses</b> Second Harmonic Distortion 100 Hz to 10 MHz 10 MHz to 2.9 GHz  Third-Order Intermodulation  100 Hz to 10 MHz 10 MHz to 2.9 GHz  Image Responses Signals displayed at 6 MHz, 42.8 and 642.8 MHz from the applied signal frequency  All Others 100 Hz to 10 MHz  10 MHz to 2.9 GHz	<div style="display: flex; justify-content: space-between;"> <div style="width: 45%;"> <p>&lt;-60 dBc &lt;-70 dBc</p> <p>&lt;-66 dBc &lt;-70 dBc</p> <p>&lt;-90 dBc</p> <p>&lt;-60 dBc &lt;-70 dBc</p> </div> <div style="width: 50%; text-align: right;"> <p>(for input signals of ≤ -40 dBm at the mixer 10 dB attenuation)</p> <p><b>Intermodulation Products</b>    <b>Equivalent</b> (TOI Distortion <b>TOI</b> for two signals, 3 dBm each ≤ -30 dBm 5 dBm each the mixer input 10 dB attn.)</p> <p>(For mixer input level ≤ -40 dBm 10 dB attenuation)</p> </div> </div>

**Table 3-2.  
HP 71100C Modular Spectrum Analyzer Specifications and  
Characteristics (continued)**

<b>AMPLITUDE (Continued)</b>	
<b>Out-of-Range Responses</b> 4 to 12 GHz 12 to 18 GHz	( $\geq 10$ dB input attenuation) < -90 dBc < -40 dBc
<b>Residual Responses</b> 10 MHz to 2.9 GHz	(0 dB input attenuation with input terminated) < -100 dBm
<b>Frequency Responses</b> 100 Hz to 2.5 GHz 100 Hz to 2.9 GHz 100 Hz to 2.9 GHz  Referenced to 300 MHz, -10 dBm calibrator  100 Hz to 2.5 GHz 100 Hz to 2.9 GHz	(10 dB input attenuation) $\pm 1$ dB $\pm 1.0$ dB, 20-30°C <sup>†</sup> $\pm 1.5$ dB    $\pm 1.3$ dB $\pm 1.8$ dB
<b>300 MHz Calibrator Amplitude</b>	-10 dBm $\pm 0.3$ dB
<i>Amplitude Temperature Drift (characteristic)</i>	$\pm 0.05$ dB/°C <i>For -10 dBm reference level with 10 dB input attenuation, in 100 Hz resolution BW (accumulated error eliminated by recalibration).</i>
<b>Resolution Bandwidth Switching Accuracy*</b> Corrected (1, 3, 10 bandwidths) Uncorrected	Reference bandwidth=100 Hz  $\pm 0.2$ dB $\pm 3$ dB
* This specification may change when modules are added or deleted. <sup>†</sup> This applies if the HP 70904A RF section serial number prefix is 3248A01639 or greater.	

**Table 3-2.  
HP 71100C Modular Spectrum Analyzer Specifications and  
Characteristics (continued)**

<b>AMPLITUDE (Continued)</b>		
<b>IF Gain Accuracy*</b>	<b>20°C to 30°C</b>	<b>0°C to 55°C</b>
10 dB	±0.2 dB	±0.2 dB
20 dB	±0.2 dB	±0.2 dB
30 dB	±0.2 dB	±0.3 dB
40 dB	±0.2 dB	±0.5 dB
50 dB	±0.2 dB	±0.6 dB
<b>Scale Fidelity*</b> Log Fidelity Using HP 70902A (Display Range is 0 to 90 dB) <b>Bandwidth</b> 10 Hz 30 Hz to 100 kHz 300 kHz  Uncorrected, 0 to 90 dB  Incremental fidelity (corrected)  Linear Fidelity	±0.7 dB ±0.5 dB ±0.7 dB  ±3 dB (20°C to 30°C)  ±0.1 dB/dB  ±7.5% of reference level	
<b>Marker Resolution</b>	±0.03 dB	
<b>Input Attenuator Switching Repeatability</b>	±0.2 dB	
<b>Input Switching Accuracy</b> (ac-coupled versus dc-coupled)	<0.3 dB (400 kHz to 2.9 GHz)	
<b>SWEEP</b>		
<b>Sweep Time</b> Range Accuracy	10 ms to 1000 s continuously adjustable ±2%	
<b>Trigger</b>	Free Run, Line, Video, or External	
* This specification may change when modules are added or deleted.		

**Table 3-2.  
HP 71100C Modular Spectrum Analyzer Specifications and  
Characteristics (continued)**

<b>GENERAL SPECIFICATIONS</b>	
<b>Temperature</b> Operation Storage	0°C to +55°C –40°C to +75°C
<b>EMI</b>	Conducted and radiated interference is in compliance with CISPR publication 11 (1975) and Messemphaenger-Postverfuegung 526/527/79 (Kennzeichnung Mit F-Nummer/Funkschutzzeichen). Radiated interference is in compliance with MIL-STD 461B, Part 7, RE02.
<b>Power Requirements</b> HP 70001A Ratings  Voltage  Option 400  HP 70004A Ratings  Voltage	310 W maximum 570 VA maximum  90 to 132 V ac, 47 to 66 Hz 198 to 264 V ac, 47 to 66 Hz  103 to 132 V ac, 365 to 444 Hz  260 W maximum 350 VA maximum  90 to 132 V ac, 47 to 66 Hz and 356 to 444 Hz 198 to 264 V ac, 47 to 66 Hz
<i>Weight (characteristic)</i> HP 71100C Spectrum Analyzer Modules HP 70001A Mainframe HP 70004A Display HP 70310A Precision Reference HP 70900B Local Oscillator HP 70902A IF Section HP 70904A RF Section	<i>47.2 kg (104.2 lb)</i>  <i>14.5 kg (32 lb)</i> <i>19.5 kg (43 lb)</i> <i>2.2 kg (4.9 lb)</i> <i>5.7 kg (12.6 lb)</i> <i>2.4 kg (5.3 lb)</i> <i>2.9 kg (6.4 lb)</i>
<i>Physical Dimensions (characteristic)</i>	Refer to Figure 3-1 and Figure 3-2 for physical dimensions.

# HP 71200C Modular Spectrum Analyzer Specifications and Characteristics [Including Option 001]

The specifications in this table apply to the HP 71200C modular spectrum analyzer [including Option 001]. Option 001 specifications are in brackets [ ].

**Table 3-3.**  
**HP 71200C Modular Spectrum Analyzer Specifications and Characteristics**

<b>FREQUENCY</b>	
<b>Frequency Range</b>	50 kHz to 22.0 GHz [26.5 GHz] tunable in 1 Hz increments
<b>Band*</b>	
1H–	50 kHz to 2.9 GHz
1L–	2.7 GHz to 6.2 GHz
2L–	6.0 GHz to 12.7 GHz
3L+	12.5 GHz to 19.9 GHz
4L+	19.7 GHz to 22.0 GHz [26.5 GHz]
<b>Frequency Readout Accuracy</b>	
Span $\leq$ 10 MHz $\times$ N <sup>†</sup>	$\pm$ ((frequency readout $\times$ frequency reference error) + 1% of span + 10 Hz)
Span $>$ 10 MHz $\times$ N <sup>†</sup> sweep $\geq$ 20 ms	$\pm$ ((frequency readout $\times$ frequency reference error) + 1.5% of span + 10 Hz)
sweep $\geq$ 10 ms	$\pm$ ((frequency readout $\times$ frequency reference error) + 2.5% of span + 10 Hz)
* H = High IF (3.6214 GHz IF); L = Low IF (321.4 MHz IF)	
† N = harmonic mixing band constant, defined as follows:	
Frequency Range	Value of N
50 kHz to 6.2 GHz	1
6.0 GHz to 12.7 GHz	2
12.5 GHz to 19.9 GHz	3
19.7 GHz to 22.0 GHz [26.5 GHz]	4

**Table 3-3.  
HP 71200C Modular Spectrum Analyzer Specifications and  
Characteristics (continued)**

<b>FREQUENCY (Continued)</b>	
<b>Frequency Reference Error</b> (Internal Reference)	frequency reference adjustment error + (frequency reference accuracy aging × time since last adjustment) + frequency reference accuracy temperature drift
<b>Frequency Reference Accuracy</b> Aging	< $5 \times 10^{-10}$ /day (7 day average) < $1 \times 10^{-7}$ /year
Temperature Drift	< $7 \times 10^{-9}$
Without HP 70310A Precision Frequency Reference Aging	< $3 \times 10^{-6}$ /year
Temperature Drift	< $1 \times 10^{-5}$
<b>Frequency Span</b> Range	0 to 22 GHz [26.5 GHz], in 0.5% increments
Accuracy Span ≤ 10 MHz × N*	± (1% of span + (span × frequency reference error))
Span > 10 MHz × N* sweep ≥ 50 ms	± (1.5% of span + (span × frequency reference error))
sweep ≥ 20 ms	± (2.5% of span + (span × frequency reference error))
sweep ≥ 10 ms	± (4.0% of span + (span × frequency reference error))
* N = harmonic mixing band constant, defined as follows:	
Frequency Range	Value of N
50 kHz to 6.2 GHz	1
6.0 GHz to 12.7 GHz	2
12.5 GHz to 19.9 GHz	3
19.7 GHz to 22.0 GHz [26.5 GHz]	4

**Table 3-3.  
HP 71200C Modular Spectrum Analyzer Specifications and  
Characteristics (continued)**

<b>FREQUENCY (Continued)</b>	
<b>Frequency Drift</b>	<p><math>\pm 1</math> kHz/s and <math>\pm 150</math> kHz/<math>^{\circ}</math>C. For spans &gt; 10 MHz, frequency drift during one sweep. Errors due to drift are not cumulative from sweep to sweep.</p>
<p><b>Resolution Bandwidths *</b> 3 dB, synchronously-tuned approximately Gaussian shape</p> <p>Range</p> <p>Accuracy</p> <p>Selectivity (<math>-60</math> dB/<math>-3</math> dB) 10 Hz to 3 kHz bandwidths 10 kHz to 300 kHz bandwidths</p>	<p>10 Hz to 300 kHz, adjustable in 1, 3, 10 sequence, and in 10% increments, except 3 kHz to 10 kHz.</p> <p><math>\pm 20\%</math></p> <p>&lt; 12:1 &lt; 16:1</p>
<p><b>Video Bandwidth *</b></p> <p>Range</p> <p><i>Accuracy (characteristic)</i></p>	<p>3 Hz to 300 kHz in 1, 3, 10 sequence. When set to 300 kHz the filter is off and has an effective value of &gt; 300 kHz.</p> <p><math>\pm 20\%</math></p>
<p><b>Residual FM</b></p> <p>Span &gt; 10 MHz</p> <p>Span <math>\leq</math> 10 MHz</p>	<p>&lt; 25 kHz peak-to-peak in 0.1 s (measurement BW = 100 kHz)</p> <p>In synthesized spans, residual FM is determined by noise sidebands. See Spectral Purity specifications for values.</p>
<p>* This specification may change when modules are added or deleted.</p>	



**Table 3-3.  
HP 71200C Modular Spectrum Analyzer Specifications and  
Characteristics (continued)**

<b>FREQUENCY (Continued)</b>	
<b>Spectral Purity</b> 0 to 2.9 GHz Noise Sidebands at 10 kHz offset:	< -108 dBc/Hz
2.7 to 22 GHz [26.5 GHz] Noise Sidebands at 30 kHz offset:	< -108 dBc/Hz + 20 log N*
Line-, System-, and Synthesis-Related Sidebands	< -65 dBc + 20 log N*
<b>AMPLITUDE</b>	
<b>Maximum Safe Input Power</b> <sup>†</sup> ac Average Continuous Power	15 dBm (0 dB input attenuation) 25 dBm (10 dB input attenuation) 30 dBm (>10 dB input attenuation)
Pulse Power	100 W, 10 μs pulse (≥ 40 dB input attenuation)
dc	0 V
<b>Gain Compression</b> <sup>†</sup> 0 dB input attenuation	< 0.5 dB for signal levels ≤ -10 dBm
<b>Displayed Average Noise Level</b> <sup>†</sup>	(10 Hz resolution BW, 3 Hz video BW, 0 dB attenuation)
Frequency Range	
10 MHz to 2.9 GHz	< -129 dBm
2.7 GHz to 6.2 GHz	< -132 dBm
6.0 GHz to 12.7 GHz	< -125 dBm
12.5 GHz to 19.9 GHz	< -120 dBm
19.7 GHz to 22.0 GHz	< -116 dBm
[19.7 GHz to 26.5 GHz]	[< -115 dBm]
* N = harmonic mixing band constant, defined as follows:	
Frequency Range	Value of N
50 kHz to 6.2 GHz	1
6.0 GHz to 12.7 GHz	2
12.5 GHz to 19.9 GHz	3
19.7 GHz to 22.0 GHz [26.5 GHz]	4
† This specification will change when modules are added or deleted.	

**Table 3-3.  
HP 71200C Modular Spectrum Analyzer Specifications and  
Characteristics (continued)**

<b>AMPLITUDE (Continued)</b>	
<p><b>Display Range</b> Calibration</p> <p>Log Scale</p> <p>Linear Scale</p> <p>Reference Level Range Log</p> <p>Linear</p>	<p>0.01 to 20 dB/division in increments of 0.5% (10 division display)</p> <p>10% of reference level/division (10 division display)</p> <p>30 dBm to -140 dBm</p> <p>7.07 V to 22 nV (50Ω system)</p>
<p><b>Nonsynthesis Related Spurious Responses*</b></p> <p>Second Harmonic Distortion 50 kHz to 10 MHz 10 MHz to 6.2 GHz 6.0 GHz to 12.7 GHz 12.5 GHz to 19.9 GHz 19.7 GHz to 22 GHz [26.5 GHz]</p> <p>Third-Order Intermodulation 50 kHz to 10 MHz 10 MHz to 6.2 GHz 6.0 GHz to 22.0 GHz [26.5 GHz]</p> <p>Image Responses Signals displayed at 6 MHz, 42.8 and 642.8 MHz from the applied signal frequency over a range of 0 to 2.9 GHz (1H- band).</p> <p>All Others 50 kHz to 10 MHz 10 MHz to 22 GHz [26.5 GHz]</p>	<p>&lt;-60 dBc      (for input signals ≤ -40 dBm at the mixer 10 dB attenuation)</p> <p>&lt;-70 dBc</p> <p>&lt;-60 dBc</p> <p>&lt;-55 dBc</p> <p>&lt;-50 dBc</p> <p><b>Intermodulation Products</b>      <b>Equivalent (TOI Distortion TOI for two signals,</b> 3 dBm each ≤ -30 dBm 7 dBm at the mixer 8 dBm input 10 dB attn.)</p> <p>&lt;-66 dBc</p> <p>&lt;-74 dBc</p> <p>&lt;-76 dBc</p> <p>&lt;-85 dBc</p> <p>&lt;-60 dBc      (For mixer input level ≤ -40 dBm 10 dB attenuation)</p> <p>&lt;-70 dBc</p>
<p>* This specification may change when modules are added or deleted.</p>	

**Table 3-3.  
HP 71200C Modular Spectrum Analyzer Specifications and  
Characteristics (continued)**

<b>AMPLITUDE (Continued)</b>	
<b>Residual Responses *</b> 10 MHz to 6.2 GHz 6.0 GHz to 12.7 GHz 12.5 GHz to 19.9 GHz 19.7 GHz to 22 GHz [26.5 GHz]	(0 dB input attenuation with input terminated) < -100 dBm < -92 dBm < -88 dBm < -83 dBm
<b>Frequency Response *</b> 50 kHz to 2.9 GHz 400 kHz to 2.9 GHz 2.7 GHz to 6.2 GHz 6.0 GHz to 12.7 GHz 12.5 GHz to 19.9 GHz 19.7 GHz to 22 GHz [26.5 GHz]	(10 dB input attenuation) ±2.7 dB ±1.4 dB ±1.4 dB ±1.9 dB ±2.5 dB ±2.5 dB
Referenced to 300 MHz, -10 dBm calibrator  50 kHz to 2.9 GHz 400 kHz to 2.9 GHz 400 kHz to 6.2 GHz 400 kHz to 12.7 GHz 400 kHz to 19.9 GHz 400 Hz to 22 GHz [26.5 GHz]	(10 dB input attenuation)  -3.9 to +1.6 dB ±1.9 dB ±2.3 dB ±3.0 dB ±3.8 dB ±3.8 dB
<b>300 MHz Calibrator Amplitude</b>	-10 dBm ±0.3 dB
<i>Amplitude Temperature Drift (characteristic)</i>	±0.05 dB/°C For -10 dBm reference level with 10 dB input attenuation, in 100 Hz resolution BW (accumulated error eliminated by recalibration).
<b>Resolution Bandwidth*</b> <b>Switching Accuracy</b>  Corrected (1, 3, 10 bandwidths) Uncorrected	Reference bandwidth = 100 Hz  ±0.2 dB ±3 dB
* This specification may change when modules are added or deleted.	

**Table 3-3.  
HP 71200C Modular Spectrum Analyzer Specifications and  
Characteristics (continued)**

<b>AMPLITUDE (Continued)</b>		
<b>IF Gain Accuracy*</b>	<b>20°C to 30°C</b>	<b>0°C to 55°C</b>
10 dB	±0.2 dB	±0.2 dB
20 dB	±0.2 dB	±0.2 dB
30 dB	±0.2 dB	±0.3 dB
40 dB	±0.2 dB	±0.5 dB
50 dB	±0.2 dB	±0.6 dB
<b>Scale Fidelity*</b> Log Fidelity Using HP 70902A (Display Range is 0 to 90 dB) <b>Bandwidth</b> 10 Hz 30 Hz to 100 kHz 300 kHz  Uncorrected, 0 to 90 dB  Incremental Fidelity (corrected)  Linear Fidelity	±0.7 dB ±0.5 dB ±0.7 dB  ±3 dB (20°C to 30°C)  ±0.1 dB/dB  ±7.5% of reference level	
<b>Marker Resolution</b>	±0.03 dB	
<b>Input Attenuator Switching Repeatability</b>	±0.2 dB	
<b>SWEEP</b>		
<b>Sweep Time</b> Range Accuracy	10 ms to 1000 s (continuously adjustable) ±2%	
<b>Trigger</b>	Free Run, Line, Video, or External	
* This specification may change when modules are added or deleted.		

**Table 3-3.  
HP 71200C Modular Spectrum Analyzer Specifications and  
Characteristics (continued)**

<b>GENERAL SPECIFICATIONS</b>	
<b>Temperature</b> Operation Storage	0°C to +55°C –40°C to +75°C
<b>EMI</b>	Conducted and radiated interference is in compliance with CISPR publication 11 (1975) and Messemphaenger-Postverfuegung 526/527/79 (Kennzeichnung Mit F-Nummer/Funkschutzzeichen). Radiated interference is in compliance with MIL-STD 461B, Part 7, RE02.
<b>Power Requirements</b> HP 70001A Ratings  Voltage  Option 400  HP 70004A Ratings  Voltage	310 W maximum 570 VA maximum  90 to 132 V ac, 47 to 66 Hz 198 to 264 V ac, 47 to 66 Hz  103 to 132 V ac, 365 to 444 Hz  260 W maximum 350 VA maximum  90 to 132 V ac, 47 to 66 Hz and 356 to 444 Hz 198 to 264 V ac, 47 to 66 Hz
<i>Weight (characteristic)</i> HP 71200C Spectrum Analyzer Modules HP 70001A Mainframe HP 70004A Display HP 70310A Precision Reference HP 70900B Local Oscillator HP 70902A IF Section HP 70905A RF Section HP 70906A RF Section [Option 001]	<i>47.2 kg (104.2 lb)</i>  <i>14.5 kg (32 lb)</i> <i>19.5 kg (43 lb)</i> <i>2.2 kg (4.9 lb)</i> <i>5.7 kg (12.6 lb)</i> <i>2.4 kg (5.3 lb)</i> <i>2.9 kg (6.4 lb)</i> <i>[2.9 kg (6.4 lb)]</i>
<i>Physical Dimensions (characteristic)</i>	Refer to Figure 3-1 and Figure 3-2 for physical dimensions.

# HP 71209A Microwave Spectrum Analyzer Specifications and Characteristics

The specifications in this table apply to the HP 71209A microwave spectrum analyzer.

**Table 3-4.**  
**HP 71209A Microwave Spectrum Analyzer Specifications and Characteristics**

<b>FREQUENCY</b>	
<b>Frequency Range</b>	100 Hz to 26.5 GHz tunable in 1 Hz increments
<b>Band*</b>	<b>Signal Frequency in GHz      First LO Frequency in GHz</b>
1H-	0 to 2.9                              3.6214 to 6.5214
1L-	2.7 to 6.2                              3.0214 to 6.5214
2L-	6.0 to 12.8                             3.1607 to 6.5607
4L+	12.6 to 26.5                            3.0697 to 6.5447
<b>Center Frequency Accuracy</b> (After IF Center Frequency Correction)	
Span $\leq N \times 10$ MHz (Synthesized) <sup>†</sup>	$\pm ((\text{center frequency} \times \text{frequency reference accuracy}) + 1\% \text{ of Span} + 10 \text{ Hz})$
Span $> N \times 10$ MHz (Lock and Roll) <sup>†</sup> sweep $\geq 20$ ms	$\pm ((\text{center frequency} \times \text{frequency reference accuracy}) + 1.5\% \text{ of Span} + 10 \text{ Hz})$
10 ms $\leq$ sweep $< 20$ ms	$\pm ((\text{center frequency} \times \text{frequency reference accuracy}) + 2.5\% \text{ of Span} + 10 \text{ Hz})$
<b>Frequency Reference Error</b>	Frequency reference adjustment error + (frequency reference accuracy aging $\times$ time since last adjustment) + frequency reference accuracy temperature drift.
<b>Frequency Reference Accuracy</b>	Aging $< 5 \times 10^{-10}$ /day (7 day average) $< 1 \times 10^{-7}$ /year
without HP 70310A (Option 110)	Temperature Drift $< 7 \times 10^{-9}$ Aging $< 3 \times 10^{-6}$ /year Temperature Drift $< 1 \times 10^{-5}$
<b>Frequency Span</b>	
Range	0 to 26.5 GHz in 0.5% increments
Accuracy	
Span $\leq 10$ MHz $\times N$	$\pm (1\% \text{ of span} + (\text{span} \times \text{frequency reference accuracy}))$
Span $> 10$ MHz $\times N$	
sweep $\geq 50$ ms	$\pm (1.5\% \text{ of span} + (\text{span} \times \text{frequency reference accuracy}))$
20 ms $\leq$ sweep $< 50$ ms	$\pm (2.5\% \text{ of span} + (\text{span} \times \text{frequency reference accuracy}))$
10 ms $\leq$ sweep $< 20$ ms	$\pm (4.0\% \text{ of span} + (\text{span} \times \text{frequency reference accuracy}))$
* H = High IF (3.6214 GHz IF) and L = Low IF (321.4 MHz IF).	
<sup>†</sup> N = harmonic mixing band constant, defined as follows:	
Frequency Range	Value of N
100 Hz to 6.2 GHz	1
6.0 GHz to 12.8 GHz	2
12.6 GHz to 26.5 GHz	4

**Table 3-4. HP 71209A Specifications and Characteristics (continued)**

<b>FREQUENCY (Continued)</b>				
<b>Resolution Bandwidths</b>				
Bandwidth (−3 dB)	10 Hz to 3 MHz* in 1, 3, 10 sequence (normal) and in 10% increments (except 3 kHz to 10 kHz).			
Accuracy	±20%			
Selectivity (60 dB/3 dB)				
10 kHz to 3 MHz	< 16:1			
10 Hz to 3 kHz	< 12:1			
Shape	Synchronously tuned, 4 Poles 10 kHz to 3 MHz (LC filters) 5 Poles 10 Hz to 3 kHz (XTAL filters)			
<b>Video Bandwidth</b>				
Range	3 Hz to 3 MHz <sup>†</sup> in 1, 3, 10 sequence			
<i>HP 70902A Accuracy (characteristic)</i>				
3 Hz to 100 kHz	±20%			
300 kHz	>300 kHz			
<i>HP 70903A Accuracy (characteristic)</i>				
300 Hz to 1 MHz	±20%			
3 MHz	>4.5 MHz			
<b>Spectral Purity</b>				
Noise Sidebands	<b>Single Sideband Noise (dBc/Hz)</b>			
	<b>Band</b>			
<b>Offset</b>	<b>1H−</b>	<b>1L−</b>	<b>2L−</b>	<b>4L+</b>
100 Hz (characteristic)	−85	−85	−79	−73
300 Hz (characteristic)	−88	−88	−82	−76
1 kHz (characteristic)	−94	−94	−88	−82
3 kHz (characteristic)	−104	−104	−98	−92
10 kHz	<−108	<−108	<−102	<−96
30 kHz (characteristic)	−111	−111	−105	−99
100 kHz (characteristic)	−115	−115	−109	−103
300 kHz (characteristic)	−123	−123	−117	−111
1 MHz (characteristic)	−135	−135	−129	−123
3 MHz (characteristic)	−145	−145	−139	−133
10 MHz (characteristic)	−153	−153	−147	−141
* HP 70902A: 10 Hz to 178 kHz, HP 70903A: 178 kHz to 3 MHz				
† HP 70902A: 3 Hz to 300 kHz, HP 70903A: 300 Hz to 3 MHz				

**Table 3-4. HP 71209A Specifications and Characteristics (continued)**

<b>FREQUENCY (Continued)</b>				
<b>Power Line and Display Related Sidebands Offset</b> N × 50, 60, 400 Hz 24 kHz 40 kHz 80 kHz	<b>Maximum Sideband Level (dBc/Hz)</b>  <− 65 dBc + 20 log N <− 65 dBc + 20 log N <− 65 dBc + 20 log N <− 65 dBc + 20 log N			
<b>Synthesis Related</b>	<b>Maximum Level (dBc)</b> −65 dBc + 20 Log N			
<b>Residual FM</b> Span > 10 MHz* Span ≤ 10 MHz	< N × 25 kHz p-p in 0.1 s In synthesized spans, residual FM is determined by noise sidebands. See Noise Sidebands specifications for values.			
<b>AMPLITUDE</b>				
<b>Frequency Response</b> (preselector peaked)	<b>Frequency Range</b>	<b>[0°C to 55°C]<sup>†</sup></b>	<b>[20°C to 30°C]<sup>†,‡</sup></b>	<b>[0°C to 55°C]<sup>†,‡</sup></b>
	100 Hz to 2.9 GHz	±1.5 dB	±2.0 dB	±2.0 dB
	2.7 to 6.2 GHz	±2.0 dB	±2.0 dB	±3.0 dB
	6.0 to 12.8 GHz	±2.0 dB	±2.0 dB	±3.0 dB
	12.6 to 22.0 GHz	±2.0 dB	±2.0 dB	±3.5 dB
	22.0 to 26.5 GHz	±2.5 dB	±2.5 dB	±4.0 dB
<b>Frequency Response</b> (preset preselector DAC settings) (characteristic)	<b>Frequency Range</b>	<b>[20°C to 30°C]<sup>†,‡,§</sup></b>		
	2.7 GHz to 6.2 GHz	+2.0, −3.0 dB		
	6.0 to 12.8 GHz	+2.0, −3.0 dB		
	12.6 to 22.0 GHz	+2.0, −3.0 dB		
	22.0 to 26.5 GHz	+2.5, −3.5 dB		
<b>Displayed Values</b> Calibration Log Scale Linear Scale  Attenuator Range  Reference Level Range Log Linear  Marker Resolution	0.01 to 20 dB/division in increments of 0.5% (10 division display) 10% of reference level/division (10 division display)  0 to 65 dB in 5 dB steps  30 dBm to −140 dBm 7.07 V to 22 nV (50Ω system)  ±0.03 dB			
* Measurement BW = 100 kHz. <sup>†</sup> With 10 dB Attenuation. <sup>‡</sup> Relative to 300 MHz Calibrator (does not include calibrator amplitude error). <sup>§</sup> For spans ≤ 100 MHz.				



**Table 3-4. HP 71209A Specifications and Characteristics (continued)**

<b>AMPLITUDE (Continued)</b>	
<b>Frequency Response (Flatness)</b>	See amplitude table above.
<i>Amplitude Temperature Drift*</i> (characteristic)	$\pm 0.05 \text{ dB}^\circ\text{C}$ at 300 MHz <sup>†</sup>
<b>Resolution Bandwidth Switching</b>	
Corrected	$\pm 0.2 \text{ dB}$ in 1, 3, 10 sequence
Uncorrected	$\pm 3 \text{ dB}$
<b>Fidelity</b>	
Log Fidelity	For amplitudes $\leq -10 \text{ dBm}$ at the input mixer
Corrected Specifications	<b>Fidelity</b> <span style="float: right;"><b>Range</b><sup>‡</sup></span>
BW < 30 Hz	$\pm 0.7 \text{ dB}$ <span style="float: right;">0 to 90 dB</span>
30 Hz $\leq$ BW $\leq$ 100 kHz	$\pm 0.5 \text{ dB}$ <span style="float: right;">0 to 90 dB</span>
100 kHz < BW $\leq$ 178 kHz	$\pm 0.7 \text{ dB}$ <span style="float: right;">0 to 90 dB</span>
178 kHz $\leq$ BW $\leq$ 1 MHz	$\pm 0.5 \text{ dB}$ <span style="float: right;">0 to 75 dB</span>
1 MHz < BW	$\pm 0.7 \text{ dB}$ <span style="float: right;">0 to 75 dB</span>
Uncorrected Specifications	<b>Fidelity</b> <span style="float: right;"><b>Range</b></span>
All HP 70902A Bandwidths	$\pm 3 \text{ dB}$ <span style="float: right;">0 to 90 dB</span>
All HP 70903A Bandwidths	$\pm 3 \text{ dB}$ <span style="float: right;">0 to 80 dB</span>
Incremental Accuracy	$\pm 0.1 \text{ dB/dB}$ (HP 70902A, HP 70903A, all bandwidths)
Linear Fidelity	$\pm 7.5\%$ of reference level
<b>Digitizing Resolution</b>	
Log Scale Switching	$\pm 0.027 \text{ dB}$
<b>Digitizing Repeatability</b> (characteristic)	$\pm 0.1 \text{ dB}$
<b>Step Gain</b>	
HP 70902A	<b>20°C to 30°C</b> <span style="float: right;"><b>0°C to 55°C</b></span>
10 dB	$\pm 0.2 \text{ dB}$ <span style="float: right;"><math>\pm 0.2 \text{ dB}</math></span>
20 dB	$\pm 0.2 \text{ dB}$ <span style="float: right;"><math>\pm 0.2 \text{ dB}</math></span>
30 dB	$\pm 0.2 \text{ dB}$ <span style="float: right;"><math>\pm 0.3 \text{ dB}</math></span>
40 dB	$\pm 0.2 \text{ dB}$ <span style="float: right;"><math>\pm 0.5 \text{ dB}</math></span>
50 dB	$\pm 0.2 \text{ dB}$ <span style="float: right;"><math>\pm 0.6 \text{ dB}</math></span>
60 dB	$\pm 0.4 \text{ dB}$ <span style="float: right;"><math>\pm 0.8 \text{ dB}</math></span>
HP 70903A	
10 dB	$\pm 0.1 \text{ dB}$
20 dB	$\pm 0.3 \text{ dB}$
<p>* At <math>-10 \text{ dBm}</math> reference level with 10 dB input attenuation and 100 Hz resolution bandwidth for the HP 70902A or 300 kHz resolution bandwidth for the HP 70903A.</p> <p><sup>†</sup> Accumulated error eliminated by recalibration.</p> <p><sup>‡</sup> Range specification is 0 to 90 dB (HP 70902A IF section) or 0 to 75 dB (HP 70903A IF section) below the reference level or 10 dB above displayed average noise level, whichever is higher.</p>	

**Table 3-4. HP 71209A Specifications and Characteristics (continued)**

<b>AMPLITUDE (Continued)</b>		
<b>Input Attenuator Absolute Accuracy</b> <i>(characteristic)</i>	<b>Center Frequency*</b>	
	0.0 to 2.9 GHz	±1.2 dB
	2.9 to 6.2 GHz	±2.3 dB
	6.2 to 12.7 GHz	±2.3 dB
	12.7 to 19.9 GHz	±2.8 dB
	19.9 to 26.5 GHz	±4.8 dB
<b>Attenuator Repeatability</b>	<±0.2 dB variation for any setting	
<b>Preselector Bypass Switch Repeatability</b> <sup>†</sup>	<±0.2 dB variation for any setting	
<b>Spurious Responses</b> <sup>†,§</sup>  Second Harmonic Distortion <sup>§,#</sup>  Third Order Intermodulation (20°C to 30°C) HP 70902A IF section <sup>**,:‡‡</sup>  <b>Center Frequency</b> 100 Hz to 20 MHz 20 MHz to 2.9 GHz 2.7 GHz to 6.2 GHz 6.0 GHz to 26.5 GHz  HP 70903A IF section <sup>††,:‡‡</sup>  <b>Center Frequency</b> 100 Hz to 20 MHz 20 MHz to 2.9 GHz 2.7 GHz to 6.2 GHz 6.0 GHz to 26.5 GHz	<b>Inputs</b>	
	10 MHz to 26.5 GHz	<−70 dBc
	100 Hz to 10 MHz	<−60 dBc
	<b>Frequency</b>	
	100 Hz to 20 MHz	<−60 dBc
	20 MHz to 2.9 GHz	<−75 dBc
	2.9 GHz to 26.5 GHz	<−100 dBc
	<b>Intermodulation Products</b>	
		<b>TOI</b>
	<−64 dBc	2 dBm
	<−78 dBc	9 dBm
	<−68 dBc	4 dBm
<−64 dBc	2 dBm	
<b>Intermodulation Products</b>		
	<b>TOI</b>	
<−54 dBc	2 dBm	
<−68 dBc	9 dBm	
<−58 dBc	4 dBm	
<−54 dBc	2 dBm	
<p>* 0 to 65 dB range, referenced to the 10 dB setting.  <sup>†</sup> Option 001 only (HP 70910A).  <sup>‡</sup> Except as listed below, for ≤ −30 dBm total signal power at the RF input with 10 dB attenuation.  <sup>§</sup> Preselector ON for Option 001 only (HP 70910A).  <sup>#</sup> For ≤ −30 dBm total signal power at RF input with 10 dB attenuation.  <sup>**</sup> For two signals, each ≤ −20 dBm at the RF input with 10 dB attenuation.  <sup>††</sup> For two signals, each ≤ −15 dBm at the RF input with 10 dB attenuation.  <sup>:‡‡</sup> TOI is degraded by 2 dB over 0°C to 55°C temperature range.</p>		

**Table 3-4. HP 71209A Specifications and Characteristics (continued)**

<b>AMPLITUDE (Continued)</b>																															
<b>Spurious Responses</b> <i>(continued)</i> Image Responses <sup>*,†</sup> (due to 21.4 MHz and 3 MHz IF) 6 MHz, 42.8 MHz 642.8 MHz	< -85 dBc <table style="width: 100%; border: none;"> <thead> <tr> <th style="text-align: left; width: 60%;"><b>Center Frequency</b></th> <th style="text-align: left;"><b>Rejection</b></th> </tr> </thead> <tbody> <tr> <td>100 Hz to 2.9 GHz</td> <td>-85 dBc</td> </tr> <tr> <td>2.7 GHz to 6.2 GHz</td> <td>-70 dBc</td> </tr> <tr> <td>6.0 GHz to 12.8 GHz</td> <td>-70 dBc</td> </tr> <tr> <td>12.7 GHz to 18.0 GHz</td> <td>-70 dBc</td> </tr> <tr> <td>18.0 GHz to 26.5 GHz</td> <td>-60 dBc</td> </tr> </tbody> </table>	<b>Center Frequency</b>	<b>Rejection</b>	100 Hz to 2.9 GHz	-85 dBc	2.7 GHz to 6.2 GHz	-70 dBc	6.0 GHz to 12.8 GHz	-70 dBc	12.7 GHz to 18.0 GHz	-70 dBc	18.0 GHz to 26.5 GHz	-60 dBc																		
<b>Center Frequency</b>	<b>Rejection</b>																														
100 Hz to 2.9 GHz	-85 dBc																														
2.7 GHz to 6.2 GHz	-70 dBc																														
6.0 GHz to 12.8 GHz	-70 dBc																														
12.7 GHz to 18.0 GHz	-70 dBc																														
18.0 GHz to 26.5 GHz	-60 dBc																														
<b>Residual Responses</b> <sup>‡</sup>	<table style="width: 100%; border: none;"> <thead> <tr> <th style="text-align: left; width: 50%;"><b>Frequency</b></th> <th style="text-align: left;"><b>Response</b></th> </tr> </thead> <tbody> <tr> <td>10 MHz to 26.5 GHz</td> <td>&lt; -100 dBm displayed</td> </tr> </tbody> </table>	<b>Frequency</b>	<b>Response</b>	10 MHz to 26.5 GHz	< -100 dBm displayed																										
<b>Frequency</b>	<b>Response</b>																														
10 MHz to 26.5 GHz	< -100 dBm displayed																														
<b>Multiple and Out of Band Responses</b> <sup>†, #</sup>	For inputs $\leq 26.5$ GHz, all multiple responses (RF $\pm n \times$ LO) <sup>§</sup> will be < -70 dBc																														
<b>Gain Compression</b> <sup>#</sup>	< 0.5 dB																														
<b>Displayed Average Noise Level</b> <sup>**</sup>	<table style="width: 100%; border: none;"> <thead> <tr> <th style="text-align: left; width: 60%;"><b>Frequency</b></th> <th style="text-align: left;"><b>Noise Level</b></th> </tr> </thead> <tbody> <tr><td>100 Hz (characteristic)</td><td>&lt; -92 dBm</td></tr> <tr><td>300 Hz (characteristic)</td><td>&lt; -95 dBm</td></tr> <tr><td>1 kHz (characteristic)</td><td>&lt; -101 dBm</td></tr> <tr><td>3 kHz (characteristic)</td><td>&lt; -111 dBm</td></tr> <tr><td>10 kHz (characteristic)</td><td>&lt; -118 dBm</td></tr> <tr><td>30 kHz (characteristic)</td><td>&lt; -118 dBm</td></tr> <tr><td>100 kHz (characteristic)</td><td>&lt; -122 dBm</td></tr> <tr><td>300 kHz (characteristic)</td><td>&lt; -130 dBm</td></tr> <tr><td>1 MHz (characteristic)</td><td>&lt; -139 dBm</td></tr> <tr><td>3 MHz (characteristic)</td><td>&lt; -139 dBm</td></tr> <tr><td>10 MHz to 2.0 GHz</td><td>-138 dBm</td></tr> <tr><td>2.0 GHz to 12.8 GHz</td><td>-137 dBm</td></tr> <tr><td>12.7 GHz to 22.0 GHz</td><td>-130 dBm</td></tr> <tr><td>22.0 GHz to 26.5 GHz</td><td>-128 dBm</td></tr> </tbody> </table>	<b>Frequency</b>	<b>Noise Level</b>	100 Hz (characteristic)	< -92 dBm	300 Hz (characteristic)	< -95 dBm	1 kHz (characteristic)	< -101 dBm	3 kHz (characteristic)	< -111 dBm	10 kHz (characteristic)	< -118 dBm	30 kHz (characteristic)	< -118 dBm	100 kHz (characteristic)	< -122 dBm	300 kHz (characteristic)	< -130 dBm	1 MHz (characteristic)	< -139 dBm	3 MHz (characteristic)	< -139 dBm	10 MHz to 2.0 GHz	-138 dBm	2.0 GHz to 12.8 GHz	-137 dBm	12.7 GHz to 22.0 GHz	-130 dBm	22.0 GHz to 26.5 GHz	-128 dBm
<b>Frequency</b>	<b>Noise Level</b>																														
100 Hz (characteristic)	< -92 dBm																														
300 Hz (characteristic)	< -95 dBm																														
1 kHz (characteristic)	< -101 dBm																														
3 kHz (characteristic)	< -111 dBm																														
10 kHz (characteristic)	< -118 dBm																														
30 kHz (characteristic)	< -118 dBm																														
100 kHz (characteristic)	< -122 dBm																														
300 kHz (characteristic)	< -130 dBm																														
1 MHz (characteristic)	< -139 dBm																														
3 MHz (characteristic)	< -139 dBm																														
10 MHz to 2.0 GHz	-138 dBm																														
2.0 GHz to 12.8 GHz	-137 dBm																														
12.7 GHz to 22.0 GHz	-130 dBm																														
22.0 GHz to 26.5 GHz	-128 dBm																														
<sup>*</sup> For $\geq 10$ dB input attenuation, RF input level $\leq 0$ dBm, and for signals displayed at 6 MHz, 42.8 MHz, and 642.8 MHz away from the applied signal frequency. <sup>†</sup> Preselector ON only for Option 001 only (HP 70910A). <sup>‡</sup> With 0 dB input attenuation and no input signal. <sup>§</sup> n is any integer. <sup>#</sup> For signal levels $\leq 0$ dBm at the RF input with 10 dB attenuation. <sup>**</sup> With 0 dB input attenuation, Ref Level $\leq -75$ dBm, 10 Hz RBW, 3 Hz Video BW.																															

**Table 3-4. HP 71209A Specifications and Characteristics (continued)**

<b>SWEEP</b>	
<b>Sweep Time</b>	
Range	10 ms to 1000 s (continuously adjustable)
Accuracy	$\pm 2\%$ indicated by HSWP
<b>Frequency Drift*</b>	$\pm 1$ kHz/second and $\pm 150$ kHz/ $^{\circ}$ C for spans $> 10$ MHz $\times$ N, frequency drift during one sweep.
<b>Trigger</b>	Free Run, Line, Video, External
* Errors due to drift are not cumulative from sweep to sweep.	

**Table 3-5. HP 71209A Specifications and Characteristics (continued)**

<b>GENERAL SPECIFICATIONS</b>	
<b>Temperature</b> Operation Storage	0°C to +55°C –40°C to +75°C
<b>EMI</b>	Conducted and radiated interference is in compliance with CISPR publication 11 (1975) and Messemmpfaenger-Postverfuegung 526/527/7 9 (Kennzeichnung Mit F-Nummer/Funkschutzzeichen). Radiated interference is in compliance with MIL-STD 461C, Part 7, RE02.
<b>Power Requirements</b> HP 70001A Ratings Voltage Option 004  HP 70004A Ratings Voltage	310 W maximum, 570 VA maximum 90 to 132 V ac, 47 to 66 Hz 198 to 264 V ac, 47 to 66 Hz 103 to 132 V ac, 365 to 444 Hz  260 W maximum, 350 VA maximum 90 to 132 V ac, 47 to 66 Hz, and 356 to 444 Hz 198 to 264 V ac, 47 to 66 Hz
<i>Power (characteristic)</i> HP 70900B HP 70902A HP 70903A HP 70909A HP 70910A HP 70310A HP 70001A HP 70004A HP 71209A	Local Oscillator <i>50 W</i> IF Section <i>19 W</i> IF Section <i>16 W</i> RF Section <i>40 W</i> RF Section <i>40 W</i> Precision Reference <i>25 W</i> Mainframe <i>42 W*</i> Color Display/Mainframe <i>137 W*</i> Spectrum Analyzer <i>329W</i>
<i>Weight (characteristic)</i> HP 70900B HP 70902A HP 70903A HP 70909A HP 70910A HP 70310A HP 70001A HP 70004A HP 71209A	Local Oscillator <i>5.6 kg</i> IF Section <i>2.4 kg</i> IF Section <i>2.3 kg</i> RF Section <i>5.5 kg</i> RF Section <i>5.5 kg</i> Precision Reference <i>2.2 kg</i> Mainframe <i>14.5 kg</i> Color Display/Mainframe <i>19.1 kg</i> Spectrum Analyzer <i>51.6 kg</i>
<i>LO RAM Hold Time (characteristic)</i>	(Battery Life) <i>1 year minimum at 25° C</i> <i>6 months minimum at 55° C</i> <i>&gt; 1 year typical at 55° C</i>
* Accounts for power supply efficiency in standard module configuration.	

# HP 71209A Microwave Spectrum Analyzer Specifications and Characteristics with External Mixers

The system specifications\* in the following tables apply to the HP 71209A microwave spectrum analyzer when used with HP 11970 and HP 11974 Series external mixers.

**Table 3-6.  
HP 71209A Microwave Spectrum Analyzer Specifications and Characteristics When Used with HP 11970 and HP 11974 External Mixers**

<b>FREQUENCY</b>																											
<b>Frequency Range</b> Used with: HP 11970 External Harmonic Mixers HP 11974 External Mixers	Tunable in 1 Hz increments  18 to 110 GHz 26.5 to 75 GHz																										
<b>Frequency Span</b> Range  Accuracy Span $\leq N \times 10$ MHz <sup>†</sup> Span $> N \times 10$ MHz <sup>†</sup> sweep $\geq 50$ ms sweep $\geq 20$ ms sweep $\geq 10$ ms	0 Hz to full band of external mixer, or $N \times 3.6$ GHz in 0.5% increments. <sup>†</sup>  $\pm$ (1% of span + (span $\times$ frequency reference error))  $\pm$ (1.5% of span + (span $\times$ frequency reference error)) $\pm$ (2.5% of span + (span $\times$ frequency reference error)) $\pm$ (4.0% of span + (span $\times$ frequency reference error))																										
<p>* Specifications apply to the following conditions unless otherwise specified:  a. Ambient temperature 0°C to 55°C.  b. HP 71209A spectrum analyzer operating with an HP 11974A mixer.  c. The connections between the HP 11974A and the host spectrum analyzer are made with one length of coax cable, HP part number 5061-5458.</p>																											
<p><sup>†</sup> N = harmonic mixing band constant, defined as follows:</p> <table border="0" style="width: 100%;"> <thead> <tr> <th style="text-align: left;"><b>Frequency Range</b></th> <th style="text-align: left;"><b>Value of N</b></th> </tr> </thead> <tbody> <tr> <td colspan="2">Used with HP 11970 Series Mixer:</td> </tr> <tr> <td>18 GHz to 26.5 GHz</td> <td>6</td> </tr> <tr> <td>26.5 GHz to 40 GHz</td> <td>8</td> </tr> <tr> <td>33 GHz to 50 GHz</td> <td>10</td> </tr> <tr> <td>40 GHz to 60 GHz</td> <td>10</td> </tr> <tr> <td>50 GHz to 75 GHz</td> <td>14</td> </tr> <tr> <td>75 GHz to 110 GHz</td> <td>18</td> </tr> <tr> <td colspan="2">Used with HP 11974 Series Mixer:</td> </tr> <tr> <td>26.5 GHz to 40 GHz</td> <td>8</td> </tr> <tr> <td>33 GHz to 50 GHz</td> <td>10</td> </tr> <tr> <td>40 GHz to 60 GHz</td> <td>10</td> </tr> <tr> <td>50 GHz to 75 GHz</td> <td>14</td> </tr> </tbody> </table>		<b>Frequency Range</b>	<b>Value of N</b>	Used with HP 11970 Series Mixer:		18 GHz to 26.5 GHz	6	26.5 GHz to 40 GHz	8	33 GHz to 50 GHz	10	40 GHz to 60 GHz	10	50 GHz to 75 GHz	14	75 GHz to 110 GHz	18	Used with HP 11974 Series Mixer:		26.5 GHz to 40 GHz	8	33 GHz to 50 GHz	10	40 GHz to 60 GHz	10	50 GHz to 75 GHz	14
<b>Frequency Range</b>	<b>Value of N</b>																										
Used with HP 11970 Series Mixer:																											
18 GHz to 26.5 GHz	6																										
26.5 GHz to 40 GHz	8																										
33 GHz to 50 GHz	10																										
40 GHz to 60 GHz	10																										
50 GHz to 75 GHz	14																										
75 GHz to 110 GHz	18																										
Used with HP 11974 Series Mixer:																											
26.5 GHz to 40 GHz	8																										
33 GHz to 50 GHz	10																										
40 GHz to 60 GHz	10																										
50 GHz to 75 GHz	14																										

**Table 3-6.**  
**HP 71209A Microwave Spectrum Analyzer Specifications and**  
**Characteristics When Used with HP 11970 and**  
**HP 11974 External Mixers (continued)**

<b>AMPLITUDE</b>	
<b>Maximum Safe Input Power</b> ac Average Continuous Power Used with HP 11970 Mixers Used with HP 11974 Mixers  Pulse Power Used with HP 11970 Mixers	20 dBm + 25 dBm  + 250 mW peak power with < 1 $\mu$ s pulse ( 20 dBm average power)
<b>+ 1 dB Gain Compression</b> Used with HP 11970 Mixers       <i>Used with HP 11974 Mixers</i> <i>(characteristic)</i>	RF Input for 1 dB increase in conversion loss  < 1 dB gain compression level 18 to 26.5 GHz                      < -3 dBm 26.5 to 40 GHz                       < -5 dBm 33 to 50 GHz                         < -7 dBm 40 to 60 GHz                         < -7 dBm 50 to 75 GHz                         < -3 dBm 75 to 110 GHz                       < -1 dBm  <i>dBm min.</i> <i>26.5 to 40 GHz                         5 dBm</i> <i>33 to 50 GHz                             0 dBm</i> <i>40 to 60 GHz                             0 dBm</i> <i>50 to 75 GHz                             3 dBm</i>
<b>Displayed Average Noise Level</b> Used with HP 11970 Mixers      Used with HP 11974 Mixers	10 Hz resolution BW  18 to 26.5 GHz                      < -128 dBm 26.5 to 40 GHz                       < -126 dBm 33 to 50 GHz                         < -124 dBm 40 to 60 GHz                         < -124 dBm 50 to 75 GHz                         < -112 dBm 75 to 110 GHz                       < -106 dBm  26.5 to 40 GHz                       < -111 dBm 33 to 50 GHz                         < -106 dBm 40 to 60 GHz                         < -109 dBm 50 to 75 GHz                         < -94 dBm

**Table 3-6.**  
**HP 71209A Microwave Spectrum Analyzer Specifications and**  
**Characteristics When Used with HP 11970 and**  
**HP 11974 External Mixers (continued)**

<b>AMPLITUDE (Continued)</b>		
<b>Nonsynthesis Related Spurious Responses</b>		
<i>IF Subharmonic Response Intercept*</i> (characteristic)		
Used with HP 11970 Mixers <sup>†</sup>		
<i>Used with HP 11974 Mixers</i>		
26.5 to 40 GHz (n = 8)	<b>0° C to 55° C</b>	<b>20° C to 30° C</b>
33 to 50 GHz (n = 10)	30 dBm	30 dBm
40 to 60 GHz (n = 10)	30 dBm	30 dBm
50 to 75 GHz (n = 14)	30 dBm	30 dBm
<i>Third-Order Intermodulation Distortion</i> (Depends on external mixer used <sup>‡</sup> )		
Used with HP 11970 Mixers <sup>†</sup>		
<i>Used with HP 11974 Mixers</i>		
26.5 to 40 GHz (n = 8)	<b>0° C to 55° C</b>	
33 to 50 GHz (n = 10)	+ 7.5 dBm	
40 to 60 GHz (n = 10)	+ 7.5 dBm	
50 to 75 GHz (n = 14)	+ 7.5 dBm	
Image Responses <sup>§</sup>		
Used with HP 11970 Mixers		
Used with HP 11974 Mixers		
Image Rejection <sup>#</sup>		
Used with HP 11970 Mixers <sup>†</sup>		
Used with HP 11974 Mixers		
26.5 to 40 GHz (n = 8)	<b>0° C to 55° C</b>	<b>20° C to 30° C</b>
33 to 50 GHz (n = 10)	-54 dBc max.	-59 dBc max.
40 to 60 GHz (n = 10)	-50 dBc max.	-55 dBc max.
50 to 67 GHz (n = 14)	-50 dBc max.	-55 dBc max.
67 to 75 GHz (n = 14)	-50 dBc max.	-55 dBc max.
<p>* IF subharmonic response intercept (2nd order):            Response at <math>f_{IF/2}</math> above input signal frequency            where <math>f_{IF/2} = 160.7</math> MHz for HP 70000 Series spectrum analyzers.</p> <p><sup>†</sup> This information is neither specified nor characterized for systems using HP 11970 Series external mixers.</p> <p><sup>‡</sup> The following formula is used to calculate TOI:  <math display="block">TOI = -10 \times \log(10^{-(TOI(M))/10} + 10^{-(CL(M)+TOI(S))/10})</math>           where TOI(M) = TOI of external mixer            CL(M) = Conversion loss of external mixer            TOI(S) = TOI of system at 321.4 MHz</p> <p><sup>§</sup> Signals displayed 6 MHz and 42.8 MHz from the applied signal frequency.</p> <p><sup>#</sup> Signals displayed at <math>2 \times f_{IF}</math> above applied signal frequency.</p>		



**Table 3-6.**  
**HP 71209A Microwave Spectrum Analyzer Specifications and**  
**Characteristics When Used with HP 11970 and**  
**HP 11974 External Mixers (continued)**

<b>AMPLITUDE (Continued)</b>	
<p><b>Multiple Responses*</b></p> <p>Used with HP 11970 Mixers<sup>†</sup>            Used with HP 11974 Mixers</p> <p>26.5 to 40 GHz (n = 8)</p> <p>33 to 50 GHz (n = 10)</p> <p>40 to 60 GHz (n = 10)</p> <p>50 to 67 GHz (n = 14)</p> <p>67 to 75 GHz (n = 14)</p>	<p>(Due to in-range applied signals mixing with LO harmonics other than order n.)</p> <p>–63 dBc max.</p> <p>–60 dBc max.</p> <p>–60 dBc max.</p> <p>–60 dBc max.</p> <p>–55 dBc max.</p>
<p><b>Residual Responses</b></p> <p>Used with HP 11970 Mixers</p> <p>18 to 26.5 GHz</p> <p>26.5 to 40 GHz</p> <p>33 to 50 GHz</p> <p>40 to 60 GHz</p> <p>50 to 75 GHz</p> <p>75 to 110 GHz</p> <p>Used with HP 11974 Mixers</p> <p>26.5 to 40 GHz (n = 8)</p> <p>33 to 50 GHz (n = 10)</p> <p>40 to 60 GHz (n = 10)</p> <p>50 to 75 GHz (n = 14)</p>	<p>With HP 70909A RF input terminated.</p> <p>&lt;–83 dBm</p> <p>&lt;–81 dBm</p> <p>&lt;–79 dBm</p> <p>&lt;–79 dBm</p> <p>&lt;–67 dBm</p> <p>&lt;–59 dBm</p> <p>–78 dBm</p> <p>–73 dBm</p> <p>–74 dBm</p> <p>–59 dBm</p>
<p>* Multiple response displayed frequency, <math>f'_{RF}</math>, due to input signal <math>f_{RF}</math>.</p> $f'_{RF} = \left(\frac{n}{n'}\right)(f_{RF}) + f_{IF} \left(\frac{n' \pm n}{n'}\right)$ <p>where <math>n</math> = Band Harmonic number  <math>n'</math> = Unwanted Harmonic, ... <math>n - 4, n - 2, n + 2, n + 4, \dots</math>  <math>f_{IF}</math> = 321.4 MHz for HP 70000 Series spectrum analyzers.</p> <p><sup>†</sup> This information is neither specified nor characterized for systems using HP 11970 Series external mixers.</p>	

**Table 3-6.**  
**HP 71209A Microwave Spectrum Analyzer Specifications and**  
**Characteristics When Used with HP 11970 and**  
**HP 11974 External Mixers (continued)**

<b>AMPLITUDE (Continued)</b>		
<b>Frequency Response</b>	Uncorrected	
	<b>0°C to 55°C</b>	<b>20°C to 30°C</b>
Used with HP 11970 Mixers		
18 to 26.5 GHz	±3.2 dB	±2.3 dB
26.5 to 40 GHz	±3.2 dB	±2.3 dB
33 to 50 GHz	±3.2 dB	±2.3 dB
40 to 60 GHz	±3.2 dB	±2.3 dB
50 to 75 GHz	±3.2 dB	±2.5 dB
75 to 110 GHz	±4.5 dB	±3.5 dB
<i>Used with HP 11974 Mixers</i>		
<i>(characteristic)</i>		
<i>26.5 to 40 GHz (n = 8)</i>	<i>±4.5 dB</i>	
<i>33 to 50 GHz (n = 10)</i>	<i>±4.0 dB</i>	
<i>40 to 60 GHz (n = 10)</i>	<i>±4.0 dB</i>	
<i>50 to 75 GHz (n = 14)</i>	<i>±4.0 dB</i>	

# HP 71210C Microwave Spectrum Analyzer Specifications and Characteristics

The specifications in this table apply to the HP 71210C microwave spectrum analyzer with HP 70908A RF section serial number prefix 2818A or later.

**Table 3-7.**  
**HP 71210C Microwave Spectrum Analyzer Specifications and Characteristics**

<b>FREQUENCY</b>	
<b>Frequency Range</b>	100 Hz to 22 GHz, tunable in 1 Hz increments
<b>Frequency Readout Accuracy</b> Span $\leq$ 10 MHz $\times$ M*  Span $>$ 10 MHz $\times$ M* sweep $\geq$ 20 ms  sweep $\geq$ 10 ms	$\pm$ ((frequency readout $\times$ frequency reference error) + 1% of span + 10 Hz)  $\pm$ ((frequency readout $\times$ frequency reference error) + 1.5% of span + 10 Hz)  $\pm$ ((frequency readout $\times$ frequency reference error) + 2.5% of span + 10 Hz)
<b>Frequency Reference Error</b> (Internal Reference)	frequency reference adjustment error + (frequency reference accuracy aging $\times$ time since last adjustment) + frequency reference accuracy temperature drift.
* M = LO multiplier constant, defined as follows:	
Frequency Range	Value of M
100 Hz to 6.2 GHz	1
6.0 GHz to 12.8 GHz	2
12.6 GHz to 22.0 GHz	4

**Table 3-7.**  
**HP 71210C Microwave Spectrum Analyzer Specifications and**  
**Characteristics (continued)**

<b>FREQUENCY (Continued)</b>	
<b>Frequency Reference Accuracy</b> Aging  Temperature Drift  Without HP 70310A Precision Frequency Reference Aging  Temperature Drift	$< 5 \times 10^{-10}$ /day (7 day average) $< 1 \times 10^{-7}$ /year  $< 7 \times 10^{-9}$  $< 3 \times 10^{-6}$ /year  $< 1 \times 10^{-5}$
<b>Frequency Span</b> Range Accuracy  Span $\leq 10$ MHz $\times M^*$  Span $> 10$ MHz $\times M^*$ sweep $\geq 50$ ms  sweep $\geq 20$ ms  sweep $\geq 10$ ms	0 to 22 GHz, in 0.5% increments  $\pm (1\% \text{ of span} + (\text{span} \times \text{frequency reference error}))$  $\pm (1.5\% \text{ of span} + (\text{span} \times \text{frequency reference error}))$ $\pm (2.5\% \text{ of span} + (\text{span} \times \text{frequency reference error}))$ $\pm (4.0\% \text{ of span} + (\text{span} \times \text{frequency reference error}))$
<b>Frequency Drift</b>	$\pm 1$ kHz/s and $\pm 150$ kHz/ $^{\circ}$ C. For spans $> 10$ MHz, frequency drift during one sweep. Errors due to drift are not cumulative from sweep to sweep.
* M = LO multiplier constant, defined as follows:	
Frequency Range 100 Hz to 6.2 GHz 6.0 GHz to 12.8 GHz 12.6 GHz to 22.0 GHz	Value of M 1 2 4

**Table 3-7.  
HP 71210C Microwave Spectrum Analyzer Specifications and  
Characteristics (continued)**

<b>FREQUENCY (Continued)</b>									
<p><b>Resolution Bandwidths*</b> 3 dB, synchronously-tuned approximately Gaussian shape</p> <p>Range</p> <p>Accuracy</p> <p>Selectivity (–60 dB/–3 dB) 10 Hz to 3 kHz bandwidths 10 kHz to 300 kHz bandwidths</p>	<p>10 Hz to 3 MHz, adjustable in 1, 3, 10 sequence, and in 10% increments, except 3 kHz to 10 kHz.</p> <p>±20%</p> <p>&lt; 12:1 &lt; 16:1</p>								
<p><b>Video Bandwidth*</b> Range</p> <p><i>Accuracy (characteristic)</i></p>	<p>3 Hz to 300 kHz in 1, 3, 10 sequence. When set to 300 kHz the filter is off and has an effective value of &gt; 300 kHz.</p> <p>±20%</p>								
<p><b>Residual FM</b> Span &gt; 10 MHz × M<sup>†</sup></p> <p>Span ≤ 10 MHz × M<sup>†</sup></p>	<p>&lt; 25 kHz peak-to-peak in 0.1 s (measurement BW = 100 kHz)</p> <p>In synthesized spans, residual FM is determined by noise sidebands. See Spectral Purity specifications for values.</p>								
<p>* This specification may change when modules are added or deleted. † M = LO multiplier constant, defined as follows:</p> <table style="margin-left: auto; margin-right: auto;"> <thead> <tr> <th style="text-align: center;">Frequency Range</th> <th style="text-align: center;">Value of M</th> </tr> </thead> <tbody> <tr> <td style="text-align: center;">100 Hz to 6.2 GHz</td> <td style="text-align: center;">1</td> </tr> <tr> <td style="text-align: center;">6.0 GHz to 12.8 GHz</td> <td style="text-align: center;">2</td> </tr> <tr> <td style="text-align: center;">12.6 GHz to 22.0 GHz</td> <td style="text-align: center;">4</td> </tr> </tbody> </table>		Frequency Range	Value of M	100 Hz to 6.2 GHz	1	6.0 GHz to 12.8 GHz	2	12.6 GHz to 22.0 GHz	4
Frequency Range	Value of M								
100 Hz to 6.2 GHz	1								
6.0 GHz to 12.8 GHz	2								
12.6 GHz to 22.0 GHz	4								

**Table 3-7.  
HP 71210C Microwave Spectrum Analyzer Specifications and  
Characteristics (continued)**

<b>AMPLITUDE</b>									
<b>Spectral Purity</b> 0 to 2.9 GHz Noise Sidebands at 10 kHz offset:  2.7 to 22 GHz Noise Sidebands at 30 kHz offset:  Line-, System-, and Synthesis-Related Sidebands:	< -108 dBc/Hz  < -108 dBc/Hz + 20 log M*  < -65 dBc + 20 log M*								
<b>Maximum Safe Input Power</b> ac Average Continuous Power  Pulse Power  dc	20 dBm (0 dB input attenuation) 30 dBm ( $\geq$ 10 dB input attenuation)  100 W, 10 $\mu$ s pulse ( $\geq$ 40 dB input attenuation)  0 V								
<b>Gain Compression</b> 0 dB input attenuation	< 0.5 dB for signal levels $\leq$ -10 dBm								
<b>Displayed Average Noise Level<sup>†</sup></b>  Frequency Range 10 MHz to 2.0 GHz 2.0 GHz to 12.8 GHz 12.6 GHz to 22.0 GHz  100 kHz resolution BW, 300 Hz video BW, 0 dB attenuation	(10 Hz resolution BW, 3 Hz video BW, 0 dB attenuation)  < -139 dBm < -136 dBm < -133 dBm  For frequencies > 10 MHz, displayed average noise is 40 dB higher than the above values.								
* M = LO multiplier constant, defined as follows: <table style="margin-left: auto; margin-right: auto; border: none;"> <thead> <tr> <th style="text-align: center;">Frequency Range</th> <th style="text-align: center;">Value of M</th> </tr> </thead> <tbody> <tr> <td style="text-align: center;">100 Hz to 6.2 GHz</td> <td style="text-align: center;">1</td> </tr> <tr> <td style="text-align: center;">6.0 GHz to 12.8 GHz</td> <td style="text-align: center;">2</td> </tr> <tr> <td style="text-align: center;">12.6 GHz to 22.0 GHz</td> <td style="text-align: center;">4</td> </tr> </tbody> </table>		Frequency Range	Value of M	100 Hz to 6.2 GHz	1	6.0 GHz to 12.8 GHz	2	12.6 GHz to 22.0 GHz	4
Frequency Range	Value of M								
100 Hz to 6.2 GHz	1								
6.0 GHz to 12.8 GHz	2								
12.6 GHz to 22.0 GHz	4								
<sup>†</sup> This specification may change when modules are added or deleted.									

**Table 3-7.  
HP 71210C Microwave Spectrum Analyzer Specifications and  
Characteristics (continued)**

<b>AMPLITUDE (Continued)</b>		
<b>Display Range</b> Calibration Log Scale  Linear Scale  Reference Level Range Log  Linear	0.01 to 20 dB/division in increments of 0.5% (10 division display)  10% of reference level/division (10 division display)  30 dBm to -140 dBm  7.07 V to 22 nV (50Ω system)	
<b>Nonsynthesis Related Spurious Responses*</b> Second Harmonic Distortion 100 Hz to 20 MHz 20 MHz to 3.5 GHz 3.5 GHz to 22.0 GHz  Third-Order Intermodulation  100 Hz to 10 MHz 10 MHz to 22.0 GHz  <b>(Option H10 Only)</b> 100 Hz to 20 MHz 20 MHz to 22.0 GHz  Image Responses Signals displayed at 6 MHz, 42.8 MHz, and 642.8 MHz from the applied signal frequency over a range of 0 to 2.9 GHz (1H- band).  Center Frequency 100 Hz to 2.9 GHz 100 Hz to 2.9 GHz <b>(Option H10)</b> 2.7 GHz to 6.2 GHz 6.0 GHz to 12.8 GHz 12.6 GHz to 16.0 GHz 16.0 GHz to 22.0 GHz	<div style="display: flex; justify-content: space-between;"> <div style="width: 30%;"> <p align="center">&lt;-60 dBc &lt;-70 dBc &lt;-100 dBc</p> </div> <div style="width: 60%;"> <p align="center">(for input signals ≤ -40 dBm at the mixer 10 dB attenuation)</p> </div> </div> <div style="display: flex; justify-content: space-between;"> <div style="width: 30%;"> <p align="center"><b>Intermodulation Products</b> &lt;-66 dBc &lt;-80 dBc</p> </div> <div style="width: 60%;"> <p align="center"><b>Equivalent TOI</b> (TOI Distortion TOI for two signals, 3 dBm each ≤ -30 dBm 10 dBm at the mixer with 10 dB of input attenuation)</p> </div> </div> <div style="display: flex; justify-content: space-between;"> <div style="width: 30%;"> <p align="center"><b>6 MHz/42.8 MHz</b> &lt;-85 &lt;-85 &lt;-85 &lt;-85 &lt;-85 &lt;-85</p> </div> <div style="width: 60%;"> <p align="center"><b>642.8 MHz</b> &lt;-100 dBc &lt;-85 dBc &lt;-83 dBc &lt;-73 dBc &lt;-70 dBc &lt;-58 dBc</p> </div> </div>	
<p>* This specification may change when modules are added or deleted.</p>		

**Table 3-7.**  
**HP 71210C Microwave Spectrum Analyzer Specifications and**  
**Characteristics (continued)**

<b>AMPLITUDE (Continued)</b>	
<b>Residual Responses*</b> 10 MHz to 22.0 GHz	(0 dB input attenuation with input terminated) < -100 dBm
<b>Multiple and Out-of-Band Responses</b> (RF $\pm n^\dagger \times$ LO)	-60 dBc For RF input level $\leq$ 0 dBm  ( $\geq$ 10 dB attenuation)
<b>Frequency Response</b>  100 Hz to 2.9 GHz 2.7 GHz to 22.0 GHz  Referenced to 300 MHz, -10 dBm calibrator  100 Hz to 2.9 GHz 2.7 GHz to 22.0 GHz	-10 dB input attenuation 20°C to 30°C      0°C to 50°C $\pm 1.5$ dB $\pm 2.0$ dB $\pm 2.0$ dB $\pm 2.5$ dB     0°C to 50°C $\pm 2.3$ dB $\pm 3.3$ dB
<b>300 MHz Calibrator Amplitude</b>	-10 dBm $\pm 0.3$ dB
<i>Amplitude Temperature Drift (characteristic)</i>	$\pm 0.05$ dB/°C <i>For -10 dBm reference level with 10 dB input attenuation, in 100 Hz resolution BW (accumulated error eliminated by recalibration).</i>
<b>Resolution Bandwidth Switching Accuracy</b> Corrected (1, 3, 10 bandwidths) Uncorrected	Referenced BW = 100 Hz  $\pm 0.2$ dB $\pm 3$ dB
* This specification may change when modules are added or deleted. $\dagger$ n is any integer	



**Table 3-7.**  
**HP 71210C Microwave Spectrum Analyzer Specifications and**  
**Characteristics (continued)**

<b>AMPLITUDE (Continued)</b>			
<b>IF Gain Accuracy</b>	<b>HP 70902A</b>	<b>HP 70902A</b>	<b>HP 70903A</b>
Gain	20°C to 30°C	0°C to 55°C	0°C to 55°C
10 dB	±0.2 dB	±0.2 dB	±0.1 dB
20 dB	±0.2 dB	±0.2 dB	±0.3 dB
30 dB	±0.2 dB	±0.3 dB	
40 dB	±0.2 dB	±0.5 dB	
50 dB	±0.2 dB	±0.6 dB	
60 dB	±0.4 dB	±0.8 dB	
<b>Scale Fidelity</b>			
Log Fidelity			
Using HP 70902A			
(Display Range is 0 to 90 dB)			
<b>Bandwidth</b>			
10 Hz	±0.7 dB		
30 Hz to 100 kHz	±0.5 dB		
300 kHz	±0.7 dB		
Using HP 70903A			
(Display Range is 0 to 75 dB)			
<b>Bandwidth</b>			
100 kHz to 1 MHz	±0.5 dB		
3 MHz	±0.7 dB		
With both the HP 70902A and HP 70903A present, the HP 70902A is used for bandwidths of 162 kHz and narrower, the HP 70903A is used for bandwidths of 178 kHz and greater.			
Uncorrected	±3 dB (20°C to 30°C)		
Incremental Fidelity (corrected)	±0.1 dB/dB		
Linear	±7.5% of reference level		

**Table 3-7.  
HP 71210C Microwave Spectrum Analyzer Specifications and  
Characteristics (continued)**

<b>AMPLITUDE (Continued)</b>	
<b>Marker Resolution</b>	±0.03 dB
<b>Input Attenuator Switching Repeatability</b>	±0.2 dB
<b>SWEEP</b>	
<b>Sweep Time</b> Range continuously adjustable	10 ms to 1000 s
Accuracy	±2%
<b>Trigger</b>	Free Run, Line, Video, or External
<b>GENERAL SPECIFICATIONS</b>	
<b>Temperature</b> Operation Storage	0°C to +55°C -40°C to +75°C
<b>EMI</b>	Conducted and radiated interference is in compliance with CISPR publication 11 (1975) and Messemphaenger-Postverfuegung 526/527/79 (Kennzeichnung Mit F-Nummer/Funkschutzzeichen). Radiated interference is in compliance with MIL-STD 461B, Part 7, RE02.
<b>Power Requirements</b> HP 70001A Ratings  Voltage  Option 400  HP 70004A Ratings  Voltage	310 W maximum 570 VA maximum  90 to 132 V ac, 47 to 66 Hz 198 to 264 V ac, 47 to 66 Hz  103 to 132 V ac, 365 to 444 Hz  260 W maximum 350 VA maximum  90 to 132 V ac, 47 to 66 Hz and 356 to 444 Hz 198 to 264 V ac, 47 to 66 Hz

**Table 3-7.  
HP 71210C Microwave Spectrum Analyzer Specifications and  
Characteristics (continued)**

<b>GENERAL SPECIFICATIONS (Continued)</b>	
<i>Weight (characteristic)</i>	
HP 71210C Spectrum Analyzer	<i>52.0 kg (114.8 lb)</i>
Modules	
HP 70001A Mainframe	<i>14.5 kg (32 lb)</i>
HP 70004A Display	<i>19.5 kg (43 lb)</i>
HP 70310A Precision Reference	<i>2.2 kg (4.9 lb)</i>
HP 70900B Local Oscillator	<i>5.7 kg (12.6 lb)</i>
HP 70902A IF Section	<i>2.4 kg (5.3 lb)</i>
HP 70903A IF Section	<i>2.4 kg (5.3 lb)</i>
HP 70908A RF Section	<i>5.4 kg (11.9 lb)</i>
<i>Physical Dimensions (characteristic)</i>	Refer to Figure 3-1 and Figure 3-2 for physical dimensions.

## System Specification Changes with HP 70620B Preamplifier/ HP 70621A Preamplifier

Including an HP 70620B preamplifier or HP 70621A preamplifier with an HP 70000 Series modular measurement system may affect the system specifications. The following tables identify the system specifications that are modified when a preamplifier is added to a system:

- Specifications that are changed when an HP 70620B preamplifier is added to an existing system.
- Specifications that are changed when an HP 70620B Option 001 preamplifier is added to an existing system.
- Specifications that are changed when an HP 70621A preamplifier is added to an existing system.

**Table 3-8.**  
**Specifications Affected When an HP 70620B Preamplifier Is Added**

<b>AMPLITUDE</b>		
<i>Gain Compression</i> (characteristic) 0 dB input attenuation	Depending on measurement conditions, the performance may be limited by the preamplifier or the spectrum analyzer. If limited by the preamplifier, refer to the specifications for that module in the Installation and Verification Manual. Otherwise, there is no change in system specifications.	
<b>Displayed Average Noise Level</b> (0°C to 55°C) <i>HP 71200C (characteristic)</i> 1.0 GHz to 2.9 GHz 2.7 GHz to 6.2 GHz 6.0 GHz to 12.7 GHz 12.5 GHz to 19.9 GHz 19.7 GHz to 22.0 GHz 22.0 GHz to 26.5 GHz (Opt. 001 only)	<b>Preamplifier Mode Off</b> (Bypass Mode)	<b>Preamplifier Mode On</b>
HP 71200C Option 002/003* 1.0 GHz to 2.9 GHz 2.7 GHz to 6.2 GHz 6.0 GHz to 12.7 GHz 12.5 GHz to 19.9 GHz 19.7 GHz to 22.0 GHz 22.0 GHz to 26.5 GHz (Opt. 003 only)	<-129 dBm <-132 dBm <-124 dBm <-119 dBm <-115 dBm <-113 dBm	<-150 dBm <-153 dBm <-150 dBm <-144 dBm <-141 dBm <-137 dBm
* When Preselectors are used with HP 70905A/6A, Displayed Average Noise specifications are degraded by: 1 dB between 1 GHz to 12.7 GHz 2 dB between 12.5 GHz to 26.5 GHz		

**Table 3-8.**  
**Specifications Affected When an HP 70620B Preamplifier Is Added (continued)**

<b>AMPLITUDE (Continued)</b>		
<b>Displayed Average Noise Level (continued)</b> (0°C to 55°C)	<b>Preamplifier Mode Off</b> (Bypass Mode)	<b>Preamplifier Mode On</b>
HP 71210C		
1.0 GHz to 2.9 GHz	<-138 dBm	<-155 dBm
2.7 GHz to 12.8 GHz	<-132 dBm	<-153 dBm
12.6 GHz to 22.0 GHz	<-131 dBm	<-150 dBm
HP 71210C <sup>1</sup>		
1.0 GHz to 2.0 GHz	<-138 dBm	<-155 dBm
2.0 GHz to 12.8 GHz	<-132 dBm	<-153 dBm
12.6 GHz to 22.0 GHz	<-131 dBm	<-150 dBm
HP 71209A		
1.0 GHz to 2.0 GHz	<-137 dBm	<-155 dBm
2.0 GHz to 2.9 GHz	<-136 dBm	<-155 dBm
2.7 GHz to 6.2 GHz	<-136 dBm	<-155 dBm
6.0 GHz to 12.8 GHz	<-136 dBm	<-155 dBm
12.6 GHz to 22.0 GHz	<-128 dBm	<-150 dBm
22.0 GHz to 26.5 GHz	<-126 dBm	<-148 dBm
<b>Nonsynthesis Related Spurious Responses</b>		
<i>Second Harmonic Distortion (characteristic)</i>	<i>(Applies only when preamplifier mode is on.)</i>	
<i>71200C Option 002</i>		
<i>1 GHz to 22 GHz</i>	<-60 dBc*	
<i>71200C Option 003</i>		
<i>1 GHz to 26.5 GHz</i>	<-60 dBc*	
<i>71210C</i>		
<i>1 GHz to 22 GHz</i>	<-60 dBc*	
<i>71209A</i>		
<i>1 GHz to 26.5 GHz</i>	<-60 dBc*	
<i>Third-Order Intermodulation (characteristic)</i>	Depending on measurement conditions, the performance may be limited by the preamplifier or the spectrum analyzer. If limited by the preamplifier, refer to the specifications for that module in the Installation and Verification Manual. Otherwise, there is no change in system specifications.	

\* For signals  $\leq -30$  dBm at RF input with 10 dB input attenuation.

<sup>1</sup> Applies to an HP 70908A with serial number  $\geq 3127A00921$ .

**Table 3-8.**  
**Specifications Affected When an HP 70620B Preamplifier Is Added**  
**(continued)**

<b>AMPLITUDE (Continued)</b>				
<b>Frequency Response</b> <i>(continued)</i> (10 dB attenuation)	<b>Preamplifier Mode Off</b>		<b>Preamplifier Mode On</b>	
	(Bypass Mode) (0°C to 55°C)		(20°C to 30°C)	
	<b>relative</b>	<b>absolute</b>	<b>relative</b>	<b>absolute</b>
<i>HP 71200C (characteristic)</i>				
50 kHz to 1.0 GHz	±1.3	±1.5	NA	NA
1.0 GHz to 2.9 GHz	±1.3	±1.5	±1.6	±1.8
2.7 GHz to 6.2 GHz	±1.3	±2.4	±1.6	±2.6
6.0 GHz to 12.7 GHz	±1.7	±2.9	±1.9	±3.0
12.5 GHz to 19.9 GHz	±2.2	±3.4	±2.8	±3.8
19.7 GHz to 22.0 GHz	±2.6	±3.9	±3.1	±4.2
22.0 GHz to 26.5 GHz (Opt. 001 only)	±2.6	±3.9	±3.5	±4.5
 HP 71200C (Option 002/003)				
50 kHz to 1.0 GHz <i>(characteristic)</i>	±2.0	±2.2	NA	NA
1.0 GHz to 2.9 GHz <i>(characteristic)</i>	±2.0	±2.2	±2.0	±2.4
2.7 GHz to 6.2 GHz	±2.2	±3.4	±2.4	±3.5
6.0 GHz to 12.7 GHz	±2.6	±3.9	±2.8	±4.0
12.5 GHz to 19.9 GHz	±3.7	±5.0	±4.0	±5.2
19.7 GHz to 22.0 GHz	±4.0	±5.4	±4.4	±5.5
22.0 GHz to 26.5 GHz (Opt. 003 only)	±4.0	±5.4	±4.7	±5.8
 HP 71210C				
100 Hz to 1.0 GHz <i>(characteristic)</i>	±2.3	±2.5	NA	NA
1.0 GHz to 2.9 GHz	±2.3	±2.5	±2.0	±2.3
2.7 GHz to 12.8 GHz	±2.8	±3.5	±2.5	±3.2
12.6 GHz to 22.0 GHz	±3.0	±3.6	±3.0	±3.5
 HP 71209A				
100 Hz to 1.0 GHz <i>(characteristic)</i>	±2.0	±3.2	NA	NA
1.0 GHz to 2.9 GHz	±2.0	±3.2	±2.0	±3.2
2.7 GHz to 6.2 GHz	±2.0	±3.2	±2.0	±3.2
6.0 GHz to 12.8 GHz	±2.5	±3.8	±2.5	±3.8
12.6 GHz to 22.0 GHz	±3.2	±4.6	±3.2	±4.6
22.0 GHz to 26.5 GHz	±4.0	±5.3	±4.0	±5.3



**Table 3-9.**  
**Specifications Affected When an HP 70620B Option 001 Preamplifier Is Added**

<b>AMPLITUDE</b>		
<i>Gain Compression</i> <i>(Characteristic)</i> 0 dB attenuation	Depending on measurement conditions, the performance may be limited by the preamplifier or the spectrum analyzer. If limited by the preamplifier, refer to the specifications for that module in the Installation and Verification Manual. Otherwise, there is no change in system specifications.	
<b>Displayed Average Noise Level</b> (0°C to 55°C) <i>HP 71100C (characteristic)</i> 10 MHz to 2.0 GHz 2.0 GHz to 2.9 GHz  <i>HP 71200C (characteristic)</i> 10 MHz to 2.9 GHz 2.7 GHz to 6.2 GHz 6.0 GHz to 12.7 GHz 12.5 GHz to 19.9 GHz 19.7 GHz to 22.0 GHz 22.0 GHz to 26.5 GHz (Opt. 001 only)  HP 71200C Option 002/003* 1.0 GHz to 2.9 GHz 2.7 GHz to 6.2 GHz 6.0 GHz to 12.7 GHz 12.5 GHz to 19.9 GHz 19.7 GHz to 22.0 GHz 22.0 GHz to 26.5 GHz (Opt. 003 only)	<b>Preamplifier Mode Off</b> (Bypass Mode)	<b>Preamplifier Mode On</b>
	<-133.0 dBm <-130.0 dBm	<-155.0 dBm <-155.0 dBm
	<-129 dBm <-132 dBm <-124 dBm <-119 dBm <-115 dBm <-113 dBm	<-150 dBm <-153 dBm <-150 dBm <-144 dBm <-141 dBm <-137 dBm
	<-119 dBm <-118 dBm <-109 dBm <-100 dBm <-94 dBm <-93 dBm	<-140 dBm <-141 dBm <-134 dBm <-125 dBm <-119 dBm <-115 dBm
* When Preselectors are used with HP 70905A/6A, Displayed Average Noise specifications are degraded by: 1 dB between 10 MHz to 12.7 GHz 2 dB between 12.5 GHz to 26.5 GHz		



**Table 3-9.**  
**Specifications Affected When an HP 70620B Option 001 Preamplifier Is Added**  
**(continued)**

<b>AMPLITUDE (Continued)</b>																			
<b>Displayed Average Noise Level</b> <i>(continued)</i>																			
HP 71210C																			
10 MHz to 2.9 GHz		<-137 dBm	<-156 dBm																
2.7 GHz to 12.8 GHz		<-132 dBm	<-153 dBm																
12.6 GHz to 22.0 GHz		<-130 dBm	<-150 dBm																
HP 71209A																			
10 MHz to 2.0 GHz		<-137 dBm	<-155 dBm																
2.0 GHz to 2.9 GHz		<-136 dBm	<-155 dBm																
2.7 GHz to 6.2 GHz		<-136 dBm	<-154 dBm																
6.0 GHz to 12.8 GHz		<-136 dBm	<-154 dBm																
12.6 GHz to 22.0 GHz		<-128 dBm	<-148 dBm																
22.0 GHz to 26.5 GHz		<-126 dBm	<-145 dBm																
<b>Nonsynthesis Related Spurious Responses</b>																			
<i>Second Harmonic Distortion</i> <i>(Characteristic)</i>		<i>(Applies only when preamplifier mode is on.)</i>																	
<i>71200C Option 002</i> <i>100 kHz to 22 GHz</i>		<-60 dBc*																	
<i>71200C Option 003</i> <i>100 kHz to 26.5 GHz</i>		<-60 dBc*																	
<i>71210C</i> <i>100 kHz to 22 GHz</i>		<-60 dBc*																	
<i>71209A</i> <i>100 kHz to 26.5 GHz</i>		<-60 dBc*																	
<i>Third-Order Intermodulation</i> <i>(Characteristic)</i>		Depending on measurement conditions, the performance may be limited by the preamplifier or the spectrum analyzer. If limited by the preamplifier, refer to the specifications for that module in the Installation and Verification Manual. Otherwise, there is no change in system specifications.																	
<b>Frequency Response</b> (10 dB attenuation) <i>HP 71100C (characteristic)</i> (0°C to 55°C) <i>10 MHz to 2.9 GHz</i>		<table border="0" style="width: 100%;"> <thead> <tr> <th colspan="2" style="text-align: center;"><b>Preamplifier Mode Off</b></th> <th colspan="2" style="text-align: center;"><b>Preamplifier Mode On</b></th> </tr> <tr> <th colspan="4" style="text-align: center;">(Bypass Mode)</th> </tr> <tr> <th style="text-align: center;"><b>relative</b></th> <th style="text-align: center;"><b>absolute</b></th> <th style="text-align: center;"><b>relative</b></th> <th style="text-align: center;"><b>absolute</b></th> </tr> </thead> <tbody> <tr> <td style="text-align: center;"><i>±1.5 dB</i></td> <td style="text-align: center;"><i>±1.8 dB</i></td> <td style="text-align: center;"><i>±1.7 dB</i></td> <td style="text-align: center;"><i>±2.0 dB</i></td> </tr> </tbody> </table>		<b>Preamplifier Mode Off</b>		<b>Preamplifier Mode On</b>		(Bypass Mode)				<b>relative</b>	<b>absolute</b>	<b>relative</b>	<b>absolute</b>	<i>±1.5 dB</i>	<i>±1.8 dB</i>	<i>±1.7 dB</i>	<i>±2.0 dB</i>
<b>Preamplifier Mode Off</b>		<b>Preamplifier Mode On</b>																	
(Bypass Mode)																			
<b>relative</b>	<b>absolute</b>	<b>relative</b>	<b>absolute</b>																
<i>±1.5 dB</i>	<i>±1.8 dB</i>	<i>±1.7 dB</i>	<i>±2.0 dB</i>																
* For signals ≤ -30 dBm at RF input with 10 dB input attenuation.																			

**Table 3-9.**  
**Specifications Affected When an HP 70620B Option 001 Preamplifier Is**  
**Added (continued)**

<b>AMPLITUDE (Continued)</b>				
<b>Frequency Response</b> <i>(continued)</i> (10 dB attenuation)	<b>Preamplifier Mode Off</b>		<b>Preamplifier Mode On</b>	
	(Bypass Mode) (0°C to 55°C)		(20°C to 30°C)	
	<b>relative</b>	<b>absolute</b>	<b>relative</b>	<b>absolute</b>
<i>HP 71200C (characteristic)</i>				
50 kHz to 100 kHz	±1.3	±1.5	NA	NA
100 kHz to 2.9 GHz	±1.3	±1.5	±1.6	±1.8
2.7 GHz to 6.2 GHz	±1.3	±2.4	±1.6	±2.6
6.0 GHz to 12.7 GHz	±1.7	±2.9	±1.9	±3.0
12.5 GHz to 19.9 GHz	±2.2	±3.4	±2.8	±3.8
19.7 GHz to 22.0 GHz	±2.6	±3.9	±3.1	±4.2
22.0 GHz to 26.5 GHz (Opt. 001 only)	±2.6	±3.9	±3.5	±4.5
<i>HP 71200C (Option 002/003)</i>				
50 kHz to 100 kHz (characteristic)	±2.0	±2.2	NA	NA
100 kHz to 2.9 GHz	±2.0	±2.2	±2.0	±2.4
2.7 GHz to 6.2 GHz	±2.2	±3.4	±2.4	±3.5
6.0 GHz to 12.7 GHz	±2.6	±3.9	±2.8	±4.0
12.5 GHz to 19.9 GHz	±3.7	±5.0	±4.0	±5.2
19.7 GHz to 22.0 GHz	±4.0	±5.4	±4.4	±5.5
22.0 GHz to 26.5 GHz (Opt. 003 only)	±4.0	±5.4	±4.7	±5.8
<i>HP 71210C</i>				
100 Hz to 100 kHz (characteristic)	±2.3 dB	±2.5 dB	NA	NA
100 kHz to 2.9 GHz	±2.3 dB	±2.5 dB	±2.0 dB	±2.3 dB
2.7 GHz to 12.8 GHz	±2.8 dB	±3.5 dB	±2.5 dB	±3.2 dB
12.6 GHz to 22.0 GHz	±3.0 dB	±3.6 dB	±3.0 dB	±3.5 dB
<i>HP 71209A</i>				
100 Hz to 100 kHz (characteristic)	±2.0	±3.2	NA	NA
100 kHz to 2.9 GHz	±2.0	±3.2	±2.0	±3.2
2.7 GHz to 6.2 GHz	±2.0	±3.2	±2.0	±3.2
6.0 GHz to 12.8 GHz	±2.5	±3.8	±2.5	±3.8
12.6 GHz to 22.0 GHz	±3.2	±4.6	±3.2	±4.6
22.0 GHz to 26.5 GHz	±4.0	±5.3	±4.0	±5.3
<i>Additional Amplitude Temperature Drift (characteristic)</i>				
	Note that this contribution to the accumulated error is <i>not</i> eliminated by recalibration. When a preamplifier is added to a system, the following should be added to the system amplitude temperature drift:			
	<b>Preamplifier Mode Off</b>		<b>Preamplifier Mode On</b>	
	(Bypass Mode)			
10 MHz to 2.9 GHz	<i>no change</i>		-0.025 dB/°C	
2.7 GHz to 26.5 GHz	<i>no change</i>		-0.12 dB/°C	

**Table 3-10.**  
**Specifications Affected When an HP 70621A Preamplifier Is Added**

<b>AMPLITUDE</b>																					
<i>Gain Compression</i> <i>(Characteristic)</i> 0 dB attenuation	Depending on measurement conditions, the performance may be limited by the preamplifier or the spectrum analyzer. If limited by the preamplifier, refer to the specifications for that module in the Installation and Verification Manual. Otherwise, there is no change in system specifications.																				
<b>Displayed Average Noise Level</b> (0°C to 55°C)  HP 71100C 10 MHz to 2.0 GHz 2.0 GHz to 2.9 GHz	<table border="0"> <tr> <td style="vertical-align: top;"><b>Preamplifier Mode Off</b></td> <td style="vertical-align: top;"><b>Preamplifier Mode On</b></td> </tr> <tr> <td style="vertical-align: top;">(Bypass Mode)</td> <td></td> </tr> <tr> <td style="vertical-align: top;">&lt; -133 dBm</td> <td style="vertical-align: top;">&lt; -156 dBm</td> </tr> <tr> <td style="vertical-align: top;">&lt; -130 dBm</td> <td style="vertical-align: top;">&lt; -156 dBm</td> </tr> </table>	<b>Preamplifier Mode Off</b>	<b>Preamplifier Mode On</b>	(Bypass Mode)		< -133 dBm	< -156 dBm	< -130 dBm	< -156 dBm												
<b>Preamplifier Mode Off</b>	<b>Preamplifier Mode On</b>																				
(Bypass Mode)																					
< -133 dBm	< -156 dBm																				
< -130 dBm	< -156 dBm																				
<b>Nonsynthesis Related Spurious Responses</b> <i>Second Harmonic Distortion</i> <i>(Characteristic)</i> HP 71100C 100 kHz to 2.9 GHz  <i>Third-Order Intermodulation</i> <i>(Characteristic)</i>	<p align="center"><i>(Applies only when preamplifier mode is on.)</i></p> <p align="center">&lt; -60 dBc*</p> <p>Depending on measurement conditions, the performance may be limited by the preamplifier or the spectrum analyzer. If limited by the preamplifier, refer to the specifications for that module in the Installation and Verification Manual. Otherwise, there is no change in system specifications.</p>																				
<b>Frequency Response</b> (10 dB attenuation) HP 71100C (0°C to 55°C) 100 Hz to 100 kHz ( <i>characteristic</i> ) 100 kHz to 2.5 GHz 100 kHz to 2.5 GHz	<table border="0"> <tr> <td style="vertical-align: top;"><b>Preamplifier Mode Off</b></td> <td style="vertical-align: top;"><b>Preamplifier Mode On</b></td> </tr> <tr> <td style="vertical-align: top;">(Bypass Mode)</td> <td></td> </tr> <tr> <td style="vertical-align: top;"><b>relative</b></td> <td style="vertical-align: top;"><b>absolute</b></td> <td style="vertical-align: top;"><b>relative</b></td> <td style="vertical-align: top;"><b>absolute</b></td> </tr> <tr> <td style="vertical-align: top;">±1.4 dB</td> <td style="vertical-align: top;">±1.4 dB</td> <td style="vertical-align: top;">NA</td> <td style="vertical-align: top;">NA</td> </tr> <tr> <td style="vertical-align: top;">±1.4 dB</td> <td style="vertical-align: top;">±1.6 dB</td> <td style="vertical-align: top;">±1.8 dB</td> <td style="vertical-align: top;">±2.0 dB</td> </tr> <tr> <td style="vertical-align: top;">±1.8 dB</td> <td style="vertical-align: top;">±2.3 dB</td> <td style="vertical-align: top;">±2.1 dB</td> <td style="vertical-align: top;">±2.5 dB</td> </tr> </table>	<b>Preamplifier Mode Off</b>	<b>Preamplifier Mode On</b>	(Bypass Mode)		<b>relative</b>	<b>absolute</b>	<b>relative</b>	<b>absolute</b>	±1.4 dB	±1.4 dB	NA	NA	±1.4 dB	±1.6 dB	±1.8 dB	±2.0 dB	±1.8 dB	±2.3 dB	±2.1 dB	±2.5 dB
<b>Preamplifier Mode Off</b>	<b>Preamplifier Mode On</b>																				
(Bypass Mode)																					
<b>relative</b>	<b>absolute</b>	<b>relative</b>	<b>absolute</b>																		
±1.4 dB	±1.4 dB	NA	NA																		
±1.4 dB	±1.6 dB	±1.8 dB	±2.0 dB																		
±1.8 dB	±2.3 dB	±2.1 dB	±2.5 dB																		
<i>Additional Amplitude</i> <i>Temperature Drift (characteristic)</i>  100 kHz to 2.9 GHz	<p>Note that this contribution to the accumulated error is <i>not</i> eliminated by recalibration. When a preamplifier is added to a system, the following should be added to the system amplitude temperature drift:</p> <table border="0"> <tr> <td style="vertical-align: top;"><b>Preamplifier Mode Off</b></td> <td style="vertical-align: top;"><b>Preamplifier Mode On</b></td> </tr> <tr> <td style="vertical-align: top;">(Bypass Mode)</td> <td></td> </tr> <tr> <td style="vertical-align: top;"><i>no change</i></td> <td style="vertical-align: top;">-0.025 dB/°C</td> </tr> </table>	<b>Preamplifier Mode Off</b>	<b>Preamplifier Mode On</b>	(Bypass Mode)		<i>no change</i>	-0.025 dB/°C														
<b>Preamplifier Mode Off</b>	<b>Preamplifier Mode On</b>																				
(Bypass Mode)																					
<i>no change</i>	-0.025 dB/°C																				
* For signals ≤ -30 dBm at RF input with 10 dB input attenuation.																					

## System Specification and Characteristic Changes with HP 70903A IF Section

The addition of an HP 70903A IF section to an HP 70000 Series modular measurement system will result in the following specification changes.

**Table 3-11.**  
**System Specifications and Characteristics Affected by an HP 70903A IF Section**

<b>FREQUENCY</b>	
<b>Resolution Bandwidths</b> 3 dB, synchronously-tuned approximately Gaussian shape  Range  Selectivity (-60 dB/-3 dB)	   100 kHz to 300 kHz, adjustable in 1, 3, 10 sequence, and in 10% increments, except 100 kHz to 300 kHz.  < 16:1
<b>Video Bandwidth</b> Range	300 Hz to 3 MHz, in 1, 3, 10 increments. When set to 3 MHz the filter is off and has an effective value of > 3 MHz.
<b>AMPLITUDE</b>	
<b>Displayed Average Noise Level</b>  Frequency Range 10 MHz to 2.0 GHz 2.0 GHz to 2.9 GHz	(100 kHz resolution BW, 300 Hz video bandwidth, 0 dB attenuation)  < -94 dBm < -91 dBm
<b>Resolution Bandwidth</b> <b>Switching Accuracy</b> Corrected (1, 3, 10 bandwidths) Uncorrected	Reference bandwidth = 300 kHz  ±0.2 dB ±3 dB
IF Gain Accuracy 10 dB	±0.1 dB

**Table 3-11.  
System Specifications and Characteristics Affected by an HP 70903A  
IF Section (continued)**

<b>AMPLITUDE (Continued)</b>	
<b>Scale Fidelity</b> Log Fidelity (Display Range is 0 to 75 dB) <b>Bandwidth</b> 100 kHz to 1 MHz 3 MHz	   $\pm 0.5$ dB $\pm 0.7$ dB
<b>GENERAL CHARACTERISTICS</b>	
<i>Weight (characteristic)            HP 70903A IF Section</i>	<i>2.4 kg (5.3 lb)</i>

## System Specification and Characteristic Changes with HP 70907A External Millimeter Interface Module (EMIM)

Including an HP 70907A external millimeter interface module (EMIM) in an HP 70000 Series modular spectrum analyzer system may affect the system specifications. All specifications apply only to an HP 70907A external millimeter interface module used with an HP 11970 Series harmonic mixers.

- Table 3-12 identifies the specification changes that occur when an HP 70907A external millimeter interface module EMIM is used to replace an existing RF section in an HP 70000 Series modular spectrum analyzer system.
- Table 3-13 identifies the specification changes that occur when *one* HP 70907A external millimeter interface module EMIM is added to an HP 71100C modular spectrum analyzer, HP 71200C modular spectrum analyzer, or HP 71210C microwave spectrum analyzer.
- Table 3-14 identifies the amount specifications will be further degraded as *each* additional HP 70907A external millimeter interface module is added to an HP 71100C modular spectrum analyzer, HP 71200C modular spectrum analyzer, or HP 71210C microwave spectrum analyzer.

The footnotes for Table 3-12 are listed after Table 3-12.

---

**Note** Cabling between the HP 70900B local oscillator source, HP 70907A external millimeter interface module, and RF sections is critical with regard to these specifications. For examples of cabling, refer to Chapter 2 or to the installation and verification manual for the HP 70907A/B external millimeter interface module.

---

**Table 3-12.**  
**System Specifications Affected When RF Section is Replaced by HP 70907A External Millimeter Interface Module**

<b>FREQUENCY</b>	
<b>Frequency Range</b> HP 11970 External Harmonic Mixers Other Manufacturers Mixers	Tunable in 1 Hz increments 18 to 110 GHz 2.7 to 325 GHz
<b>Frequency Span</b> Range  Accuracy Span $\leq 10$ MHz $\times N^*$ Span $> 10$ MHz $\times N^*$ sweep $\geq 50$ ms sweep $\geq 20$ ms sweep $\geq 10$ ms	0 Hz to full band of external mixer or $3.6 \text{ GHz} \times N^*$ in 0.5% increments  $\pm (1\% \text{ of span} + (\text{span} \times \text{frequency reference error}))$  $\pm (1.5\% \text{ of span} + (\text{span} \times \text{frequency reference error}))$ $\pm (2.5\% \text{ of span} + (\text{span} \times \text{frequency reference error}))$ $\pm (4.0\% \text{ of span} + (\text{span} \times \text{frequency reference error}))$

**Table 3-12.**  
**System Specifications Affected When RF Section is Replaced by**  
**HP 70907A External Millimeter Interface Module (continued)**

<b>FREQUENCY (Continued)</b>	
<b>Additional Frequency Readout Error</b>  HP 70902A IF section 10 Hz to 100 kHz 300 kHz HP 70903A IF section 100 kHz 300 kHz to 3 MHz	When an HP 70907A is used, the following amounts should be added to the frequency readout error:  $\pm$ (greater of: 300 Hz or 25% of resolution bandwidth) $\pm$ 30% of resolution bandwidth  $\pm$ 35% of resolution bandwidth $\pm$ 25% of resolution bandwidth
<b>AMPLITUDE</b>	
<b>Maximum Safe Input Power</b> ac Average Continuous Power  Pulse Power	20 dBm with HP 11970 mixers  +250 mW peak power with $< 1 \mu\text{s}$ pulse (20 dBm average power) with HP 11970 mixers
<b>Gain Compression</b> HP 11970 Band 18 to 26.5 GHz 26 to 40 GHz 33 to 50 GHz 40 to 60 GHz 50 to 75 GHz 75 to 110 GHz	$< 1$ dB gain compression level $< -3$ dBm $< -5$ dBm $< -7$ dBm $< -7$ dBm $< -3$ dBm $< -1$ dBm
<b>Displayed Average Noise Level</b> HP 11970 Band 18 to 26.5 GHz 26 to 40 GHz 33 to 50 GHz 40 to 60 GHz 50 to 75 GHz 75 to 110 GHz	300 Hz resolution BW, 0 dB attenuation  $< -103$ dBm $< -101$ dBm $< -99$ dBm $< -99$ dBm $< -97$ dBm $< -90$ dBm

**Table 3-12.  
System Specifications Affected When RF Section is Replaced by  
HP 70907A External Millimeter Interface Module (continued)**

<b>AMPLITUDE (Continued)</b>	
<b>Nonsynthesis Related Spurious Responses</b> Second Harmonic Distortion  Third-Order Intermodulation Distortion  Image Responses (signals displayed 6 MHz and 42.8 MHz from the applied signal frequency)	Same as external mixer used  Depends on external mixer used <sup>†</sup>  < -80 dBc
<b>Residual Responses</b> HP 11970 Band 18 to 26.5 GHz 26 to 40 GHz 33 to 50 GHz 40 to 60 GHz 50 to 75 GHz 75 to 110 GHz	0 dB input attenuation with input terminated  < -83 dBm < -81 dBm < -79 dBm < -79 dBm < -67 dBm < -59 dBm
<b>Frequency Response (uncorrected)</b> HP 11970 Band 18 to 26.5 GHz 26 to 40 GHz 33 to 50 GHz 40 to 60 GHz 50 to 75 GHz 75 to 110 GHz	10 dB input attenuation  ±2.3 dB ±2.3 dB ±2.3 dB ±2.3 dB ±2.5 dB ±3.5 dB
<b>Internal 321.4 MHz Calibrator Accuracy</b>	±0.6 dB at -35 dBm



**Table 3-12.**  
**System Specifications Affected When RF Section is Replaced by**  
**HP 70907A External Millimeter Interface Module (continued)**

<b>AMPLITUDE (Continued)</b>	
<b>Resolution Bandwidth Switching</b> <b>Accuracy</b> Corrected HP 70902A, 1, 3, and 10 bandwidths 300 Hz to 100 kHz 300 kHz  HP 70903A 100 kHz 300 kHz 1 MHz to 3 MHz  Uncorrected (all bandwidths)	±0.5 dB +1.2, -0.5 dB  ±1.0 dB +1.0, -0.5 dB +2.0, -1.0 dB  ±3 dB
<b>GENERAL CHARACTERISTICS</b>	
<i>Weight (characteristic)</i> HP 70907A EMIM	<i>2.8 kg (6.2 lb)</i>

**Footnotes for Table 3-12**

\* N = harmonic mixing band constant, defined as follows:

**HP 11970 Band**

18 to 26.5 GHz	N = 6
26 to 40 GHz	N = 8
33 to 50 GHz	N = 10
40 to 60 GHz	N = 10
50 to 75 GHz	N = 14
75 to 110 GHz	N = 18

† The following formula is used to calculate TOI:

$$\text{TOI} = -10 \times \log \left( 10^{\frac{-(\text{TOI}(\text{M}))}{10}} + 10^{\frac{-(\text{CL}(\text{M}) + \text{TOI}(\text{S}))}{10}} \right)$$

where: TOI (M) = TOI of external mixer  
 CL (M) = Conversion loss of external mixer  
 TOI (S) = TOI of system at 321.4 MHz, Input = -10 dBm

**Table 3-13.**  
**System Specifications Affected When One HP 70907A EMIM Is Added**

<b>FREQUENCY</b>		
	<b>EMIM Input</b>	<b>RF Input</b>
<b>Noise Sidebands</b>		
Offset		
≤100 kHz	no change	Degraded by 1 dB
> 100 kHz	no change	Degraded by 2 dB
<b>Line Related Sidebands</b>	no change	Degraded by 1 dB
<b>AMPLITUDE</b>		
	<b>EMIM Input</b>	<b>RF Input</b>
<b>Frequency Response</b>	Degraded by 0.2 dB	no change
<b>Residual Responses</b> (HP 71100A only)		
Band Frequency		
K 21.407 GHz	-65 dBm	no change
A 29.193 GHz	-63 dBm	no change
Q 36.535 GHz	-61 dBm	no change
V 51.021 GHz	-49 dBm	no change
<b>Displayed Average Noise Level</b>	Degraded by 1 dB	Degraded by 2 dB

**Table 3-14.**  
**System Specification Changes for Each Additional HP 70907A EMIM Added**

<b>FREQUENCY</b>		
	<b>EMIM Input</b>	<b>RF Input</b>
<b>Noise Sidebands</b>	no change	Degraded by 1 dB
<b>Line Related Sidebands</b>	Degraded by 1 dB	Degraded by 1 dB
<b>AMPLITUDE</b>		
	<b>EMIM Input</b>	<b>RF Input</b>
<b>Frequency Response</b>	Degraded by 0.2 dB	no change
<b>Displayed Average Noise Level</b>	Degraded by 1 dB	Degraded by 1 dB

---

## System Specification and Characteristic Changes with HP 70907B External Millimeter Interface Module (EMIM)

Including an HP 70907B external millimeter interface module (EMIM) in an HP 70000 Series modular measurement system may affect the system specifications. The following tables identify the system specifications that are modified when an EMIM is added to a system:

- Specifications that are changed when an HP 70907B external millimeter interface module EMIM is used to replace an existing RF section in an HP 70000 Series modular measurement system.
- Specifications that are changed when one HP 70907B external millimeter interface module EMIM is added to an HP 71100C modular spectrum analyzer, HP 71200C modular spectrum analyzer, HP 71210C microwave spectrum analyzer, or HP 71209A microwave spectrum analyzer system.
- Specifications that will be further degraded as *each* additional HP 70907B external millimeter interface module EMIM is added to an HP 71100C modular spectrum analyzer, HP 71200C modular spectrum analyzer, HP 71210C microwave spectrum analyzer, or HP 71209A microwave spectrum analyzer.

---

**Note**                      Cabling between the HP 70900B local oscillator source, HP 70907B external millimeter interface module, and RF sections is critical with regard to these specifications. For examples of cabling, refer to Chapter 2 or the installation and verification manual in the HP 70907A/B external millimeter interface module.

---

**Table 3-15.**  
**System Specifications Affected When an RF Section Is Replaced by HP 70907B**  
**external millimeter interface module**

<b>FREQUENCY</b>																											
<b>Frequency Range</b> Used with: HP 11970 External Harmonic Mixers HP 11974 External Mixers Other Manufacturer's Mixers	Tunable in 1 Hz increments  18 to 110 GHz 26.5 to 75 GHz 2.7 to 325 GHz																										
<b>Frequency Span</b> Range  Accuracy Span $\leq N \times 10$ MHz <sup>†</sup> Span $> N \times 10$ MHz <sup>†</sup> sweep $\geq 50$ ms sweep $\geq 20$ ms sweep $\geq 10$ ms	0 Hz to full band of external mixer, or $N \times 3.6$ GHz in 0.5% increments. <sup>†</sup>  $\pm (1\% \text{ of span} + (\text{span} \times \text{frequency reference error}))$  $\pm (1.5\% \text{ of span} + (\text{span} \times \text{frequency reference error}))$ $\pm (2.5\% \text{ of span} + (\text{span} \times \text{frequency reference error}))$ $\pm (4.0\% \text{ of span} + (\text{span} \times \text{frequency reference error}))$																										
<p>* Specifications apply to the following conditions unless otherwise specified:</p> <p>a. Ambient temperature 0°C to 55°C.</p> <p>b. HP 70000 Series modular spectrum analyzer system that includes an HP 70907B EMIM, operating with an HP 11074 mixer.</p> <p>c. The connections between the HP 11974A and the host spectrum analyzer are made with one length of coax cable, HP part number 5061-5458.</p>																											
<p><sup>†</sup> N = harmonic mixing band constant, defined as follows:</p> <table style="width: 100%; border-collapse: collapse;"> <thead> <tr> <th style="text-align: left;">Frequency Range</th> <th style="text-align: left;">Value of N</th> </tr> </thead> <tbody> <tr> <td colspan="2">Used with HP 11970 Series Mixer:</td> </tr> <tr> <td>18 GHz to 26.5 GHz</td> <td>6</td> </tr> <tr> <td>26.5 GHz to 40 GHz</td> <td>8</td> </tr> <tr> <td>33 GHz to 50 GHz</td> <td>10</td> </tr> <tr> <td>40 GHz to 60 GHz</td> <td>10</td> </tr> <tr> <td>50 GHz to 75 GHz</td> <td>14</td> </tr> <tr> <td>75 GHz to 110 GHz</td> <td>18</td> </tr> <tr> <td colspan="2">Used with HP 11974 Series Mixer:</td> </tr> <tr> <td>26.5 GHz to 40 GHz</td> <td>8</td> </tr> <tr> <td>33 GHz to 50 GHz</td> <td>10</td> </tr> <tr> <td>40 GHz to 60 GHz</td> <td>10</td> </tr> <tr> <td>50 GHz to 75 GHz</td> <td>14</td> </tr> </tbody> </table>		Frequency Range	Value of N	Used with HP 11970 Series Mixer:		18 GHz to 26.5 GHz	6	26.5 GHz to 40 GHz	8	33 GHz to 50 GHz	10	40 GHz to 60 GHz	10	50 GHz to 75 GHz	14	75 GHz to 110 GHz	18	Used with HP 11974 Series Mixer:		26.5 GHz to 40 GHz	8	33 GHz to 50 GHz	10	40 GHz to 60 GHz	10	50 GHz to 75 GHz	14
Frequency Range	Value of N																										
Used with HP 11970 Series Mixer:																											
18 GHz to 26.5 GHz	6																										
26.5 GHz to 40 GHz	8																										
33 GHz to 50 GHz	10																										
40 GHz to 60 GHz	10																										
50 GHz to 75 GHz	14																										
75 GHz to 110 GHz	18																										
Used with HP 11974 Series Mixer:																											
26.5 GHz to 40 GHz	8																										
33 GHz to 50 GHz	10																										
40 GHz to 60 GHz	10																										
50 GHz to 75 GHz	14																										

**Table 3-15.**  
**System Specifications Affected When an RF Section Is Replaced by**  
**HP 70907B external millimeter interface module (continued)**

<b>AMPLITUDE</b>	
<b>Maximum Safe Input Power</b> ac Average Continuous Power Used with HP 11970 Mixers Used with HP 11974 Mixers Pulse Power Used with HP 11970 Mixers	20 dBm + 25 dBm  + 250 mW peak power with < 1 $\mu$ s pulse ( 20 dBm average power)
<b>+ 1 dB Gain Compression</b> Used with HP 11970 Mixers         Used with HP 11974 Mixers (characteristic)	RF Input for 1 dB increase in conversion loss  < 1 dB gain compression level 18 to 26.5 GHz                      < -3 dBm 26.5 to 40 GHz                        < -5 dBm 33 to 50 GHz                           < -7 dBm 40 to 60 GHz                           < -7 dBm 50 to 75 GHz                           < -3 dBm 75 to 110 GHz                         < -1 dBm  <i>dBm min.</i> 26.5 to 40 GHz                        5 dBm 33 to 50 GHz                            0 dBm 40 to 60 GHz                            0 dBm 50 to 75 GHz                            3 dBm
<b>Displayed Average Noise Level</b> Used with HP 11970 Mixers        Used with HP 11974 Mixers	10 Hz resolution BW  18 to 26.5 GHz                        < -118 dBm 26.5 to 40 GHz                        < -116 dBm 33 to 50 GHz                           < -114 dBm 40 to 60 GHz                           < -114 dBm 50 to 75 GHz                           < -112 dBm 75 to 110 GHz                         < -105 dBm  26.5 to 40 GHz                        < -111 dBm 33 to 50 GHz                           < -106 dBm 40 to 60 GHz                           < -109 dBm 50 to 75 GHz                           < -94 dBm

**Table 3-15.**  
**System Specifications Affected When an RF Section Is Replaced by**  
**HP 70907B external millimeter interface module (continued)**

<b>AMPLITUDE (Continued)</b>		
<b>Nonsynthesis Related Spurious Responses</b>		
<i>IF Subharmonic Response Intercept*</i> (characteristic)		
Used with HP 11970 Mixers <sup>†</sup>		
<i>Used with HP 11974 Mixers</i>	<b>0° C to 55° C</b>	<b>20° C to 30° C</b>
26.5 to 40 GHz (n = 8)	+45 dBm	+45 dBm
33 to 50 GHz (n = 10)	+45 dBm	+45 dBm
40 to 60 GHz (n = 10)	+45 dBm	+45 dBm
50 to 75 GHz (n = 14)	30 dBm	+45 dBm
 <i>Third-Order Intermodulation Distortion</i>		
	(Depends on external mixer used <sup>‡</sup> )	
Used with HP 11970 Mixers <sup>†</sup>		
<i>Used with HP 11974 Mixers</i>	<b>0° C to 55° C</b>	
26.5 to 40 GHz (n = 8)	12 dBm	
33 to 50 GHz (n = 10)	12 dBm	
40 to 60 GHz (n = 10)	12 dBm	
50 to 75 GHz (n = 14)	12 dBm	
 <i>Image Responses<sup>§</sup></i>		
Used with HP 11970 Mixers	< -80 dBc	
Used with HP 11974 Mixers	< -80 dBc	
 <i>Image Rejection<sup>#</sup></i>		
Used with HP 11970 Mixers <sup>†</sup>		
<i>Used with HP 11974 Mixers</i>	<b>0° C to 55° C</b>	<b>20° C to 30° C</b>
26.5 to 40 GHz (n = 8)	-54 dBc max.	-59 dBc max.
33 to 50 GHz (n = 10)	-50 dBc max.	-55 dBc max.
40 to 60 GHz (n = 10)	-50 dBc max.	-55 dBc max.
50 to 67 GHz (n = 14)	-50 dBc max.	-55 dBc max.
67 to 75 GHz (n = 14)	-40 dBc max.	-45 dBc max.
<p>* IF subharmonic response intercept (2nd order):  Response at <math>f_{IF/2}</math> above input signal frequency  where <math>f_{IF/2} = 160.7</math> MHz for HP 70000 Series modular spectrum analyzer system.</p> <p><sup>†</sup> This information is neither specified nor characterized for systems using HP 11970 Series external mixers.</p> <p><sup>‡</sup> The following formula is used to calculate TOI:  <math>TOI = -10 \times \log(10^{-(TOI(M))/10} + 10^{-(CL(M)+TOI(S))/10})</math>  where TOI(M) = TOI of external mixer  CL(M) = Conversion loss of external mixer  TOI(S) = TOI of system at 321.4 MHz</p> <p><sup>§</sup> Signals displayed 6 MHz and 42.8 MHz from the applied signal frequency.</p> <p><sup>#</sup> Signals displayed at <math>2 \times f_{IF}</math> above applied signal frequency.</p>		

**Table 3-15.**  
**System Specifications Affected When an RF Section Is Replaced by**  
**HP 70907B external millimeter interface module (continued)**

<b>AMPLITUDE (Continued)</b>	
<b>Multiple Responses</b> <sup>*,†</sup> Used with HP 11970 Mixers <sup>‡</sup> Used with HP 11974 Mixers 26.5 to 40 GHz (n = 8) 33 to 50 GHz (n = 10) 40 to 60 GHz (n = 10) 50 to 67 GHz (n = 14) 67 to 75 GHz (n = 14)	-63 dBc max. -60 dBc max. -60 dBc max. -60 dBc max. -55 dBc max.
<b>Residual Responses</b> Used with HP 11970 Mixers 18 to 26.5 GHz 26.5 to 40 GHz 33 to 50 GHz 40 to 60 GHz 50 to 75 GHz 75 to 110 GHz  Used with HP 11974 Mixers 26.5 to 40 GHz (n = 8) 33 to 50 GHz (n = 10) 40 to 60 GHz (n = 10) 50 to 75 GHz (n = 14)	0 dB input attenuation with input terminated.  <-83 dBm <-81 dBm <-79 dBm <-79 dBm <-67 dBm <-59 dBm  -78 dBm -73 dBm -74 dBm -59 dBm
<p>* Multiple response displayed frequency, <math>f'_{RF}</math>, due to input signal <math>f_{RF}</math>.</p> $f'_{RF} = \left(\frac{n}{n'}\right) (f_{RF}) + f_{IF} \left(\frac{n' \pm n}{n'}\right)$ where $n$ = Band Harmonic number $n'$ = Unwanted Harmonic, ... $n - 4, n - 2, n + 2, n + 4, \dots$ $f_{IF} = 321.4$ MHz for HP 70000 Series modular spectrum analyzer system.	
<p>† Due to in-range applied signals mixing with LO harmonics other than order <math>n</math>.</p> <p>‡ This information is neither specified nor characterized for systems using HP 11970 Series external mixers.</p>	

**Table 3-15.**  
**System Specifications Affected When an RF Section Is Replaced by**  
**HP 70907B external millimeter interface module (continued)**

<b>AMPLITUDE (Continued)</b>	
<b>Frequency Response</b>	Uncorrected
Used with HP 11970 Mixers	
18 to 26.5 GHz	±2.3 dB
26.5 to 40 GHz	±2.3 dB
33 to 50 GHz	±2.3 dB
40 to 60 GHz	±2.3 dB
50 to 75 GHz	±2.5 dB
75 to 110 GHz	±3.5 dB
<i>Used with HP 11974 Mixers</i>	
<i>(characteristic)</i>	
<i>26.5 to 40 GHz (n = 8)</i>	<i>±4.5 dB</i>
<i>33 to 50 GHz (n = 10)</i>	<i>±4.0 dB</i>
<i>40 to 60 GHz (n = 10)</i>	<i>±4.0 dB</i>
<i>50 to 75 GHz (n = 14)</i>	<i>±4.0 dB</i>
<b>Internal 321.4 MHz Calibrator Accuracy</b>	±0.6 dB at -35 dBm
<i>Weight (characteristic)</i>	
<i>HP 70907B EMIM</i>	
	<i>2.8 kg (6.2 lb)</i>



**Table 3-16.**  
**System Specifications Affected When One HP 70907B EMIM Is added**

<b>FREQUENCY</b>		
	<b>EMIM Input</b>	<b>RF Input</b>
<b>Noise Sidebands</b>		
Offset		
≤ 100 kHz	no change	Degraded by 1 dB
> 100 kHz	no change	Degraded by 2 dB
<b>Line Related Sidebands</b>	no change	Degraded by 1 dB
<b>AMPLITUDE</b>		
	<b>EMIM Input</b>	<b>RF Input</b>
<b>Frequency Response</b>	Degraded by 0.2 dB	no change
<b>Residual Responses</b> (HP 71100C only)		
<b>Band</b>	<b>Frequency</b>	
K	21.407 GHz	-65 dBm
A	29.193 GHz	-63 dBm
Q	36.535 GHz	-61 dBm
V	51.021 GHz	-49 dBm
<b>Displayed Average Noise Level</b>	Degraded by 1 dB	Degraded by 2 dB

**Table 3-17.**  
**System Specification Changes for Each Additional HP 70907B EMIM**

<b>FREQUENCY</b>		
	<b>EMIM Input</b>	<b>RF Input</b>
<b>Noise Sidebands</b>	no change	Degraded by 1 dB
<b>Line Related Sidebands</b>	Degraded by 1 dB	Degraded by 1 dB
<b>AMPLITUDE</b>		
	<b>EMIM Input</b>	<b>RF Input</b>
<b>Frequency Response</b>	Degraded by 0.2 dB	no change
<b>Displayed Average Noise Level</b>	Degraded by 1 dB	Degraded by 1 dB

---

## **System Specification and Characteristic Changes with HP 70905B RF Section/HP 70600A Preselector or HP 70906B RF Section/HP 70601A Preselector**

The HP 71200C Option 002 modular spectrum analyzer, deletes the HP 70905A RF section and adds an HP 70905B RF section/HP 70600A preselector combination. HP 71200C Option 003 modular spectrum analyzer deletes the HP 70905A RF section and adds an HP 70906B RF section/HP 70601A preselector combination. HP 71200C Option 003 modular spectrum analyzer extends the frequency range to 26.5 GHz. HP 71200C Option 003 modular spectrum analyzer specifications are shown in brackets [ ]. The HP 70905B RF section and HP 70906B RF section should not be used as stand-alone RF sections. The HP 71200C modular spectrum analyzer specifications apply with the following exceptions:

**Table 3-18.**  
**HP 70905B RF Section/HP 70600A Preselector or HP 70906B**  
**RF Section/HP 70601A Preselector Specifications and Characteristics**

<b>FREQUENCY</b>		
<b>Frequency Range</b>	Option 002	[Option 003]
Bypass Mode	50 kHz to 22.0 GHz	[50 kHz to 26.5 GHz]
Low-Pass Filter Mode	50 kHz to 2.9 GHz	[50 kHz to 2.9 GHz]
Preselected Mode	2.7 to 22.0 GHz	[2.7 to 26.5 GHz]
<b>Frequency Span</b>	Option 002	[Option 003]
Bypass Mode	0 to 22 GHz	[0 to 26.5 GHz]
Preselected Mode	0 to 19.3 GHz	[0 to 23.8 GHz]
<b>AMPLITUDE</b>		
<b>Gain Compression</b>	0 dB input attenuation	
Bypass Mode	<0.5 dB for signal levels $\leq -10$ dBm	
LPF Mode (50 kHz to 2.9 GHz)	<0.5 dB for signal levels $\leq -5$ dBm	
Preselected Mode	<0.5 dB for signal levels $\leq 0$ dBm	
<b>Displayed Average Noise Level *</b>	10 Hz resolution bandwidth, 3 Hz video bandwidth, 0 dB attenuation	
<b>Band</b>	<b>Bypass Mode</b>	<b>Preselected Mode</b>
10 MHz to 2.9 GHz	<-127 dBm	<-119 dBm
2.7 GHz to 6.2 GHz	<-130 dBm	<-118 dBm
6.0 GHz to 12.7 GHz	<-121 dBm	<-109 dBm
12.5 GHz to 19.9 GHz	<-115 dBm	<-101 dBm
19.7 GHz to 22.0 GHz	<-111 dBm	<-96 dBm
[22 GHz to 26.5 GHz]	[<-109 dBm]	[<-95 dBm]
<p>* When Preselectors are used with HP 70905A/70906A, Displayed Average Noise specifications are degraded by:  1 dB between 10 MHz to 12.7 GHz  2 dB between 12.5 GHz to 26.5 GHz</p>		

**Table 3-18.**  
**HP 70905B RF Section/HP 70600A Preselector or HP 70906B**  
**RF Section/HP 70601A Preselector Specifications and Characteristics**  
**(continued)**

<b>AMPLITUDE (Continued)</b>			
<b>Nonsynthesis Related Spurious Responses</b>	With 10 dB attenuation, for mixer input levels $\leq -40$ dBm, or $\leq -30$ dBm in preselected filter path, all spurious responses (except as listed below) are less than these values:		
50 kHz to 10 MHz	$< -60$ dBc		
10 MHz to 22.0 GHz	$< -70$ dBc		
[10 MHz to 26.5 GHz]	[ $< -70$ dBc]		
Second Harmonic Distortion	For mixer input levels $< -30$ dBm and 10 dB attenuation in bypass and low-pass bands, $\leq 0$ dBm attenuation in pre-selected bands.		
<b>Band</b>	<b>Second Harmonic</b>		
	<b>Bypass</b>	<b>Preselected</b>	
100 kHz to 20 MHz	$< -60$ dBc	$-66$ dBc	
20 MHz to 2.9 GHz	$< -70$ dBc	$-76$ dBc	
2.7 GHz to 6.2 GHz	$< -70$ dBc	$-100$ dBc	
6.0 GHz to 12.7 GHz	$< -60$ dBc	$-100$ dBc	
12.5 GHz to 19.9 GHz	$< -55$ dBc	$-90$ dBc	
19.7 GHz to 22.0 GHz	$< -50$ dBc	$-85$ dBc	
[19.7 GHz to 26.5 GHz]	[ $< -50$ dBc]	[ $-85$ dBc]	
Third-Order Intermodulation	Distortion (10 dB attenuation) for two signals at the input mixer, each $< -30$ dBm in bypass mode and $\leq -20$ dBm in preselected (filtered) mode.		
<b>Center Frequency</b>	<b>Intermodulation Products</b>		<b>Equivalent TOI</b>
	<b>Bypass</b>	<b>Preselected</b>	<b>Bypass/Preselected</b>
50 kHz to 10 MHz	$< -66$ dBc	$< -58$ dBc	+3/ 9 dBm
10 MHz to 2.9 GHz	$< -74$ dBc	$< -66$ dBc	+7/ 13 dBm
2.7 GHz to 6.2 GHz	$< -74$ dBc	$< -74$ dBc	+7/ 17 dBm
6.0 GHz to 26.5 GHz	$< -76$ dBc	$< -76$ dBc	+8/ 18 dBm

**Table 3-18.**  
**HP 70905B RF Section/HP 70600A Preselector or HP 70906B**  
**RF Section/HP 70601A Preselector Specifications and Characteristics**  
**(continued)**

<b>AMPLITUDE (Continued)</b>																		
<b>Image Response</b> For RF input level $\leq 0$ dBm ( $\geq 10$ dB attenuation)  50 kHz to 2.9 GHz 2.7 to 12.7 GHz 12.5 to 22 GHz [12.5 to 26.5 GHz]	<b>Image Response</b>  <table style="margin-left: auto; margin-right: auto;"> <tr> <td style="padding: 0 10px;">6 MHz</td> <td style="padding: 0 10px;">42.8 MHz</td> <td style="padding: 0 10px;">642.8 MHz*</td> </tr> <tr> <td style="padding: 0 10px;"><math>&lt; -85</math> dBc</td> <td style="padding: 0 10px;"><math>&lt; -85</math> dBc</td> <td style="padding: 0 10px;"><math>&lt; -100</math> dBc</td> </tr> <tr> <td style="padding: 0 10px;"><math>&lt; -85</math> dBc</td> <td style="padding: 0 10px;"><math>&lt; -85</math> dBc</td> <td style="padding: 0 10px;"><math>&lt; -70</math> dBc</td> </tr> <tr> <td style="padding: 0 10px;"><math>&lt; -85</math> dBc</td> <td style="padding: 0 10px;"><math>&lt; -85</math> dBc</td> <td style="padding: 0 10px;"><math>&lt; -60</math> dBc</td> </tr> <tr> <td style="padding: 0 10px;">[<math>&lt; -85</math> dBc]</td> <td style="padding: 0 10px;"><math>&lt; -85</math> dBc</td> <td style="padding: 0 10px;"><math>&lt; -60</math> dBc]</td> </tr> </table>			6 MHz	42.8 MHz	642.8 MHz*	$< -85$ dBc	$< -85$ dBc	$< -100$ dBc	$< -85$ dBc	$< -85$ dBc	$< -70$ dBc	$< -85$ dBc	$< -85$ dBc	$< -60$ dBc	[ $< -85$ dBc]	$< -85$ dBc	$< -60$ dBc]
6 MHz	42.8 MHz	642.8 MHz*																
$< -85$ dBc	$< -85$ dBc	$< -100$ dBc																
$< -85$ dBc	$< -85$ dBc	$< -70$ dBc																
$< -85$ dBc	$< -85$ dBc	$< -60$ dBc																
[ $< -85$ dBc]	$< -85$ dBc	$< -60$ dBc]																
<b>Multiple and Out-of-Band Responses</b>	$< -60$ dBc*	For RF input level $\leq 0$ dBm ( $\geq 10$ dB attenuation)																
<b>Residual Responses</b>  10 MHz to 2.9 GHz 2.7 GHz to 6.2 GHz 6.0 GHz to 12.7 GHz 12.5 GHz to 19.9 GHz 19.7 GHz to 22 GHz [19.7 GHz to 26.5 GHz]	0 dB input attenuation with input terminated  <table style="margin-left: auto; margin-right: auto;"> <tr> <td style="padding: 0 10px;"><b>Bypass</b></td> <td style="padding: 0 10px;"><b>Preselected</b></td> </tr> <tr> <td style="padding: 0 10px;"><math>&lt; -99</math> dBm</td> <td style="padding: 0 10px;"><math>&lt; -91</math> dBm</td> </tr> <tr> <td style="padding: 0 10px;"><math>&lt; -99</math> dBm</td> <td style="padding: 0 10px;"><math>&lt; -86</math> dBm</td> </tr> <tr> <td style="padding: 0 10px;"><math>&lt; -90</math> dBm</td> <td style="padding: 0 10px;"><math>&lt; -76</math> dBm</td> </tr> <tr> <td style="padding: 0 10px;"><math>&lt; -85</math> dBm</td> <td style="padding: 0 10px;"><math>&lt; -70</math> dBm</td> </tr> <tr> <td style="padding: 0 10px;"><math>&lt; -80</math> dBm</td> <td style="padding: 0 10px;"><math>&lt; -63</math> dBm</td> </tr> <tr> <td style="padding: 0 10px;">[<math>&lt; -80</math> dBm]</td> <td style="padding: 0 10px;"><math>&lt; -63</math> dBm]</td> </tr> </table>			<b>Bypass</b>	<b>Preselected</b>	$< -99$ dBm	$< -91$ dBm	$< -99$ dBm	$< -86$ dBm	$< -90$ dBm	$< -76$ dBm	$< -85$ dBm	$< -70$ dBm	$< -80$ dBm	$< -63$ dBm	[ $< -80$ dBm]	$< -63$ dBm]	
<b>Bypass</b>	<b>Preselected</b>																	
$< -99$ dBm	$< -91$ dBm																	
$< -99$ dBm	$< -86$ dBm																	
$< -90$ dBm	$< -76$ dBm																	
$< -85$ dBm	$< -70$ dBm																	
$< -80$ dBm	$< -63$ dBm																	
[ $< -80$ dBm]	$< -63$ dBm]																	
* Filtered mode only																		

**Table 3-18.**  
**HP 70905B RF Section/HP 70600A Preselector or HP 70906B**  
**RF Section/HP 70601A Preselector Specifications and Characteristics**  
**(continued)**

<b>AMPLITUDE (Continued)</b>		
<b>Frequency Response</b>	10 dB input attenuation	
	<b>Bypass</b>	<b>Preselected*</b>
50 kHz to 2.9 GHz	±2.6 dB	±2.8 dB
400 kHz to 2.9 GHz	±1.3 dB	±1.5 dB
2.7 GHz to 6.2 GHz	±1.5 dB	±1.8 dB
6.0 GHz to 12.7 GHz	±2.0 dB	±2.3 dB
12.5 GHz to 19.9 GHz	±3.2 dB	±3.3 dB
[19.7 GHz to 22 GHz	±3.6 dB	±3.7 dB
[19.7 GHz to 26.5 GHz]	[±3.6 dB	±3.7 dB]
Referenced to 300 MHz	-10 dBm calibrator (10 dB input attenuation)	
	<b>Bypass</b>	<b>Preselected*</b>
50 kHz to 2.9 GHz	+1.6 dB, -4.2 dB	+1.8, -4.4 dB
400 kHz to 2.9 GHz	±1.6 dB	±1.8 dB
2.7 GHz to 6.2 GHz	±2.8 dB	±3.1 dB
6.0 GHz to 12.7 GHz	±3.3 dB	±3.6 dB
12.5 GHz to 19.9 GHz	±4.5 dB	±4.6 dB
19.7 GHz to 22 GHz	±4.9 dB	±5.0 dB
[19.7 GHz to 26.5 GHz]	[±4.9 dB	±5.0 dB]
<b>Bypass/Preselected Switching Repeatability</b>	±0.2 dB*	
<b>GENERAL CHARACTERISTICS</b>		
<i>Weight (characteristic)</i>		
HP 70905B RF Section	<i>2.9 kg (6.4 lb)</i>	
HP 70906B RF Section	<i>2.9 kg [(6.4 lb)]</i>	
HP 70600A Preselector	<i>2.7 kg (6.0 lb)</i>	
HP 70601A Preselector	<i>2.7 kg [(6.0 lb)]</i>	
* With preselector peaked in all preselector bands		

---

## **HP 71400C Lightwave Signal Analyzer Specifications and Characteristics**

This table contains the specifications and characteristics for an HP 71400C lightwave signal analyzer.

Additional electrical specifications apply at the RF input of the HP 70908A RF section. These specifications are documented in Table 3-7 for the HP 71210C microwave spectrum analyzer.

All amplitude specifications are in optical dB units unless noted otherwise.

**Table 3-19.**  
**HP 71400C Lightwave Signal Analyzer Specifications and Characteristics**

<b>Wavelength Range</b> (characteristic)	1200 nm to 1600 nm	
<b>Frequency Range</b> (demodulated signal)	100 kHz to 22 GHz	
<b>Average Power Accuracy</b>	<b>Factory-Calibrated</b>	<b>User-Calibrated</b>
	(At 1300 and 1550 nm) ±0.65 dB ±5 nW	(By external power meter) ±0.05 dB ±5 nW
	±connector variation*	±power meter accuracy†
<b>Modulated Power Amplitude Accuracy</b>		<b>20° C to 30° C    0° C to 55° C</b>
	at 100 MHz	±1.0 dB    ±1.8 dB
<b>Modulated Power Frequency Response‡</b> relative to 100 MHz		<b>20° C to 30° C    0° C to 55° C</b>
	100 kHz to 2.9 GHz	±1.0 dB    ±1.3 dB
	2.9 GHz to 22 GHz	±1.0 dB    ±3.0 dB
<b>RF Input Frequency Response‡</b>		
	100 kHz to 2.9 GHz	±2.3 dB§ (±2.6 dB)#
	2.9 GHz to 22 GHz	±2.8 dB§ (±3.6 dB)#
<p>* Connector losses vary with such factors as connector type and quality, connector cleanliness, temperature, damage, and wear.</p> <p>† Applies to any wavelength for the case where the average readout is set to match the reading of a calibrated external optical power meter.</p> <p>‡ Specifications assume that either the HP 70908A and HP 70810B were calibrated together during the manufacturing process or that an extended system calibration (Option 020) has been performed. If not, use module specifications for frequency response. The module specifications are documented in the <i>HP 70810B and HP 70810B Option 850 Lightwave Section Installation and Verification Manual</i>.</p> <p>§ Amplitude measurement is in electrical dB units.</p> <p># Referenced to 300 MHz, -10 dBm calibrator.</p>		



**Table 3-19.**  
**HP 71400C Lightwave Signal Analyzer Specifications and**  
**Characteristics (continued)**

<b>Electrical Input Flatness Corrected<sup>1</sup></b> <i>(characteristic)</i>	<b>Frequency</b>	<b>Amplitude Error</b>
	100 kHz to 6 GHz	1.4 dB <sup>2</sup>
	6 GHz to 12 GHz	1.6 dB <sup>2</sup>
	12 GHz to 16 GHz	2.0 dB <sup>2</sup>
<b>Displayed Average Optical Noise Level</b> 10 Hz Res BW, 3 Hz Vid BW Ref Level $\leq -40$ dBm	<b>Frequency</b>	<b>Displayed Noise Level</b>
	100 kHz to 1 MHz	-51 dBm
	1 MHz to 10 MHz	-57 dBm
	10 MHz to 100 MHz	-62 dBm
	100 MHz to 8 GHz	-66 dBm
	8 GHz to 16 GHz	-64 dBm
<b>Harmonic Distortion</b>	16 GHz to 22 GHz	
	-60 dBm	
<b>Input Return Loss<sup>3</sup></b> with HMS-10/HP	$>70$ dB <sup>2</sup> below fundamental with modulated power $\leq -30$ dBm	
<b>Input Return Loss<sup>4</sup></b> <i>(characteristic)</i> with HMS-10/HP	$\geq 40$ dB (internal reflections) with 0 dB optical input attenuation. $\geq 35$ dB (total reflections) with 0 dB optical input attenuation.  $>27$ dB with optical input attenuation $\geq 5$ dB	
<b>Maximum Safe Optical Input Power</b>	<b>Average Power</b>	<b>Modulated Power</b>
	15 dBm	15 dBm
<b>Optical Input Connectors<sup>5</sup></b> (Option-dependent)	<b>Single-Mode Fiber Connectors</b> Diamond HMS-10/HP, FC/PC, ST, Biconic, DIN	
<b>GENERAL SPECIFICATIONS</b>		
<b>Temperature</b>	<b>Operation</b> 0°C to +55°C	<b>Storage</b> -40°C to +75°C

1 When a lightwave section is installed in a measurement system, add the amplitude-error value to the related flatness specifications for the system.

2 Amplitude measurement is in electrical dB units.

3 **Input Return Loss** (specification) applies to HP 70810B lightwave sections with a serial prefix 3242A and above.

4 **Input Return Loss** (*characteristic*) applies to HP 70810B lightwave sections with a serial prefix 3237A and below.

5 Refer to "System Replaceable Parts" in Chapter 2 for optical connector HP part numbers.

**Table 3-19.  
HP 71400C Lightwave Signal Analyzer Specifications and  
Characteristics (continued)**

<b>GENERAL SPECIFICATIONS (Continued)</b>	
<b>EMI</b>	Conducted and radiated interference is in compliance with CISPR publication 11 (1975) and Messempfaenger-Postverfuegung 526/527/79 (Kennzeichnung Mit F-Nummer/Funkschutzzeichen). Radiated interference is in compliance with MIL-STD 461B, Part 7, RE02.
<b>Power Requirements</b> HP 70001A Ratings  Voltage  Option 400  HP 70004A Ratings  Voltage	310 W maximum 570 VA maximum  90 to 132 V ac, 47 to 66 Hz 198 to 264 V ac, 47 to 66 Hz  103 to 132 V ac, 365 to 444 Hz  260 W maximum 350 VA maximum  90 to 132 V ac, 47 to 66 Hz and 356 to 444 Hz 198 to 264 V ac, 47 to 66 Hz
<i>Weight (characteristic)</i> HP 71400C  <b>Individual Modules</b>  HP 70001A Mainframe HP 70004A Display HP 70310A Precision Reference HP 70900B Local Oscillator HP 70902A IF Section HP 70903A IF Section HP 70908A RF Section HP 70810B Lightwave Section	53.8 kg (118.7 lb)  14.5 kg (32 lb) 19.5 kg (43 lb) 2.2 kg (4.9 lb) 5.7 kg (12.6 lb) 2.4 kg (5.3 lb) 2.4 kg (5.3 lb) 5.4 kg (11.9 lb) 1.75 kg (3.9 lb)
<i>Physical Dimensions (characteristic)</i>	Refer to Figure 3-1 and Figure 3-2 for physical dimensions.

---

## **HP 71400C Option 850 Lightwave Signal Analyzer Specifications and Characteristics**

This table contains the specifications and characteristics for an HP 71400C Option 850 lightwave signal analyzer.

Additional electrical specifications apply at the RF input of the HP 70908A RF section. These specifications are documented in Table 3-7 for the HP 71210C microwave spectrum analyzer.

All amplitude specifications are in optical dB unless noted otherwise.

**Table 3-20.  
HP 71400C Option 850 Lightwave Signal Analyzer Specifications and  
Characteristics**

<b>Wavelength Range</b> (characteristic)	750 nm to 870 nm	
<b>Frequency Range</b> (demodulated signal)	100 kHz to 22 GHz	
<b>Average Power Accuracy</b>	<b>Factory-Calibrated</b>  (At 830 nm) ±0.65 dB ±5 nW  ±connector variation*	<b>User-Calibrated</b>  (By external power meter) ±0.5 dB ±5 nW  ±power meter accuracy†
<b>Modulated Power Amplitude Accuracy</b>	at 100 MHz	<b>20° C to 30° C</b> <b>0° C to 55° C</b> ±1.0 dB    ±1.8 dB
<b>Modulated Power Frequency Response‡</b> relative to 100 MHz	100 kHz to 2.9 GHz 2.9 GHz to 22 GHz	<b>20° C to 30° C</b> <b>0° C to 55° C</b> ±1.0 dB    ±1.3 dB ±1.0 dB    ±3.0 dB
<b>RF Input Frequency Response‡</b>	100 kHz to 2.9 GHz 2.9 GHz to 22 GHz	±2.3 dB§ (±2.6 dB)# ±2.8 dB§ (±3.6 dB)#
<p>* Connector losses vary with such factors as connector type and quality, connector cleanliness, temperature, damage, and wear.</p> <p>† Applies to any wavelength for the case where the average readout is set to match the reading of a calibrated external optical power meter.</p> <p>‡ Specifications assume that either the HP 70908A and HP 70810B were calibrated together during the manufacturing process or that an extended system calibration (Option 020) has been performed. If not, use module specifications for frequency response. The module specifications are documented in the <i>HP 70810B and HP 70810B Option 850 Lightwave Section Installation and Verification Manual</i>.</p> <p>§ Amplitude measurement is in electrical dB units.</p> <p># Referenced to 300 MHz, -10 dBm calibrator.</p>		

**Table 3-20.**  
**HP 71400C Option 850 Lightwave Signal Analyzer Specifications and Characteristics (continued)**

<b>Electrical Input Flatness Corrected*</b> <i>(characteristic)</i>	<b>Frequency</b>	<b>Amplitude Error</b>
	100 kHz to 6 GHz	1.4 dB †
	6 GHz to 12 GHz	1.6 dB †
	12 GHz to 16 GHz	2.0 dB †
<b>Displayed Average Optical Noise Level</b> 10 Hz Res BW, 3 Hz Vid BW Ref Level $\leq -40$ dBm	<b>Frequency</b>	<b>Displayed Noise Level</b>
	100 kHz to 1 MHz	-47 dBm
	1 MHz to 10 MHz	-53 dBm
	10 MHz to 100 MHz	-58 dBm
	100 MHz to 8 GHz	-62 dBm
<b>Harmonic Distortion</b>	8 GHz to 16 GHz	-60 dBm
	16 GHz to 22 GHz	-56 dBm
<b>Harmonic Distortion</b>	$>70$ dB † below fundamental with modulated power $\leq -30$ dBm	
<b>Input Return Loss</b> <i>(characteristic)</i> with HMS-10/HP	$>27$ dB with input attenuation $\geq 5$ dB	
<b>Maximum Safe Optical Input Power</b>	<b>Average Power</b>	<b>Modulated Power</b>
	15 dBm	15 dBm
<b>Optical Input Connectors ‡</b> (Option-dependent)	<b>Single-Mode Fiber Connectors</b> Diamond HMS-10/HP, FC/PC, ST, Biconic, DIN	
<b>GENERAL SPECIFICATIONS</b>		
<b>Temperature</b>	<b>Operation</b>	<b>Storage</b>
	0°C to +55°C	-40°C to +75°C
<b>EMI</b>	Conducted and radiated interference is in compliance with CISPR publication 11 (1975) and Messemphaenger-Postverfuegung 526/527/79 (Kennzeichnung Mit F-Nummer/Funkschutzzeichen). Radiated interference is in compliance with MIL-STD 461B, Part 7, RE02.	
* When a lightwave section is installed in a measurement system, add the amplitude-error value to the related flatness specifications for the system. † Amplitude measurement is in electrical dB units. ‡ Refer to the replaceable parts section of Chapter 2 for optical connector part numbers.		

**Table 3-20.**  
**HP 71400C Option 850 Lightwave Signal Analyzer Specifications and**  
**Characteristics (continued)**

<b>GENERAL SPECIFICATIONS (Continued)</b>	
<p><b>Power Requirements</b>            HP 70001A            Ratings</p> <p>Voltage</p> <p>Option 400</p> <p>HP 70004A            Ratings</p> <p>Voltage</p>	<p>310 W maximum            570 VA maximum</p> <p>90 to 132 V ac, 47 to 66 Hz            198 to 264 V ac, 47 to 66 Hz</p> <p>103 to 132 V ac, 365 to 444 Hz</p> <p>260 W maximum            350 VA maximum</p> <p>90 to 132 V ac, 47 to 66 Hz and 356 to 444 Hz            198 to 264 V ac, 47 to 66 Hz</p>
<p><i>Weight (characteristic)</i>            HP 71400C Option 850</p> <p><b>Individual Modules</b></p> <p>HP 70001A Mainframe            HP 70004A Display            HP 70310A Precision Reference            HP 70900B Local Oscillator            HP 70902A IF Section            HP 70903A IF Section            HP 70908A RF Section            HP 70810B Option 850            Lightwave Section</p>	<p><i>53.8 kg (118.7 lb)</i></p> <p><i>14.5 kg (32 lb)</i>  <i>19.5 kg (43 lb)</i>  <i>2.2 kg (4.9 lb)</i>  <i>5.7 kg (12.6 lb)</i>  <i>2.4 kg (5.3 lb)</i>  <i>2.4 kg (5.3 lb)</i>  <i>5.4 kg (11.9 lb)</i>  <i>1.75 kg (3.9 lb)</i></p>
<p><i>Physical Dimensions (characteristic)</i></p>	<p>Refer to Figure 3-1 and Figure 3-2 for physical dimensions.</p>

---

## **HP 71401C Lightwave Signal Analyzer Specifications and Characteristics**

This table contains the specifications and characteristics for an HP 71401C lightwave signal analyzer.

Additional electrical specifications apply at the RF input of the HP 70904A RF section. These specifications are documented in Table 3-2 for the HP 71100C modular spectrum analyzer.

All amplitude specifications are in optical dB unless noted otherwise.

**Table 3-21.  
HP 71401C Lightwave Signal Analyzer Specifications and  
Characteristics**

<b>Wavelength Range</b> (characteristic)	<i>1200 nm to 1600 nm</i>	
<b>Frequency Range</b> (demodulated signal)	100 kHz to 2.9 GHz	
<b>Average Power Accuracy</b>	<b>Factory-Calibrated</b>  (At 1300 and 1550 nm) $\pm 0.65$ dB $\pm 5$ nW  $\pm$ connector variation*	<b>User-Calibrated</b>  (By external power meter) $\pm 0.05$ dB $\pm 5$ nW  $\pm$ power meter accuracy <sup>†</sup>
<b>Modulated Power Amplitude Accuracy</b>	at 100 MHz	<b>20° C to 30° C</b> <b>0° C to 55° C</b>  $\pm 1.0$ dB $\pm 1.8$ dB
<b>Modulated Power Frequency Response<sup>‡</sup></b> relative to 100 MHz	100 kHz to 2.9 GHz	<b>20° C to 30° C</b> <b>0° C to 55° C</b>  $\pm 1.0$ dB $\pm 1.3$ dB
<b>RF Input Frequency Response<sup>‡</sup></b>	100 kHz to 2.5 GHz 2.5 GHz to 2.9 GHz	$\pm 1.3$ dB <sup>§</sup> ( $\pm 1.6$ dB) <sup>#</sup> $\pm 1.8$ dB <sup>§</sup> ( $\pm 2.1$ dB) <sup>#</sup>
<p>* Connector losses vary with such factors as connector type and quality, connector cleanliness, temperature, damage, and wear.</p> <p><sup>†</sup> Applies to any wavelength for the case where the average readout is set to match the reading of a calibrated external optical power meter.</p> <p><sup>‡</sup> Specifications assume that either the HP 70904A and HP 70810B were calibrated together during the manufacturing process or that an extended system calibration (Option 020) has been performed. If not, use module specifications for frequency response. The module specifications are documented in the <i>HP 70810B and HP 70810B Option 850 Lightwave Section Installation and Verification Manual</i>.</p> <p><sup>§</sup> Amplitude measurement is in electrical dB units.</p> <p><sup>#</sup> Referenced to 300 MHz, -10 dBm calibrator.</p>		



**Table 3-21.**  
**HP 71401C Lightwave Signal Analyzer Specifications and**  
**Characteristics (continued)**

<b>Electrical Input Flatness Corrected<sup>1</sup></b> <i>(characteristic)</i>	<b>Frequency</b>  100 kHz to 2.9 GHz	<b>Amplitude Error</b>  1.4 dB <sup>1</sup>
<b>Displayed Average Optical Noise Level</b> 10 Hz Res BW, 3 Hz Vid BW Ref Level $\leq -40$ dBm	<b>Frequency</b>  100 kHz to 1 MHz 1 MHz to 10 MHz 10 MHz to 100 MHz 100 MHz to 2.9 GHz	<b>Displayed Noise Level</b>  -51 dBm -57 dBm -62 dBm -66 dBm
<b>Harmonic Distortion</b>	70 dB <sup>2</sup> below fundamental with modulated power $\leq -30$ dBm	
<b>Input Return Loss<sup>3</sup></b> with HMS-10/HP  <b>Input Return Loss<sup>4</sup></b> <i>(characteristic)</i> with HMS-10/HP	$\geq 40$ dB (internal reflections) with 0 dB optical input attenuation. $\geq 35$ dB (total reflections) with 0 dB optical input attenuation.  <i><math>&gt; 27</math> dB with optical input attenuation <math>\geq 5</math> dB</i>	
<b>Maximum Safe Optical Input Power</b>	<b>Average Power</b>  15 dBm	<b>Modulated Power</b>  15 dBm
<b>Optical Input Connectors<sup>5</sup></b> (Option-dependent)	<b>Single-Mode Fiber Connectors</b> Diamond HMS-10/HP, FC/PC, ST, Biconic, DIN	
<b>GENERAL SPECIFICATIONS</b>		
<b>Temperature</b>	<b>Operation</b> 0°C to +55°C	<b>Storage</b> -40°C to +75°C

1 When a lightwave section is installed in a measurement system, add the amplitude-error value to the related flatness specifications for the system.

2 Amplitude measurement is in electrical dB units.

3 **Input Return Loss** (specification) applies to HP 70810B lightwave sections with a serial prefix 3242A and above.

4 **Input Return Loss** (*characteristic*) applies to HP 70810B light wave sections with a serial prefix 3237A and below.

5 Refer to "System Replaceable Parts" in Chapter 2 for optical connector HP part numbers.

**Table 3-21.  
HP 71401C Lightwave Signal Analyzer Specifications and  
Characteristics (continued)**

<b>GENERAL SPECIFICATIONS (Continued)</b>	
<b>EMI</b>	Conducted and radiated interference is in compliance with CISPR publication 11 (1975) and Messempefaenger-Postverfuegung 526/527/79 (Kennzeichnung Mit F-Nummer/Funkschutzzeichen). Radiated interference is in compliance with MIL-STD 461B, Part 7, RE02.
<b>Power Requirements</b> HP 70001A Ratings  Voltage  Option 400  HP 70004A Ratings  Voltage	310 W maximum 570 VA maximum  90 to 132 V ac, 47 to 66 Hz 198 to 264 V ac, 47 to 66 Hz  103 to 132 V ac, 365 to 444 Hz  260 W maximum 350 VA maximum  90 to 132 V ac, 47 to 66 Hz and 356 to 444 Hz 198 to 264 V ac, 47 to 66 Hz
<i>Weight (characteristic)</i> HP 71401C  <b>Individual Modules</b>  HP 70001A Mainframe HP 70004A Display HP 70310A Precision Reference HP 70900B Local Oscillator HP 70902A IF Section HP 70903A IF Section HP 70904A RF Section HP 70810B Lightwave Section	<i>49 kg (108.1 lb)</i>  <i>14.5 kg (32 lb)</i> <i>19.5 kg (43 lb)</i> <i>2.2 kg (4.9 lb)</i> <i>5.7 kg (12.6 lb)</i> <i>2.4 kg (5.3 lb)</i> <i>2.4 kg (5.3 lb)</i> <i>2.9 kg (6.4 lb)</i> <i>1.75 kg (3.9 lb)</i>
<i>Physical Dimensions (characteristic)</i>	Refer to Figure 3-1 and Figure 3-2 for physical dimensions.

---

## **HP 71401C Option 850 Lightwave Signal Analyzer Specifications and Characteristics**

This table contains the specifications and characteristics for an HP 71401C Option 850 lightwave signal analyzer.

Additional electrical specifications apply at the RF input of the HP 70904A RF section. These specifications are documented in Table 3-2 for the HP 71100C modular spectrum analyzer.

All amplitude specifications are in optical dB unless noted otherwise.

**Table 3-22.**  
**HP 71401C Option 850 Lightwave Signal Analyzer Specifications and Characteristics**

<b>Wavelength Range</b> (characteristic)	750 nm to 870 nm	
<b>Frequency Range</b> (demodulated signal)	100 kHz to 2.9 GHz	
<b>Average Power Accuracy</b>	<b>Factory-Calibrated</b>  (At 830 nm) ±0.65 dB ±5 nW  ±connector variation*	<b>User-Calibrated</b>  (By external power meter) ±0.05 dB ±5 nW  ±power meter accuracy†
<b>Modulated Power Amplitude Accuracy</b>	at 100 MHz	<b>20° C to 30° C</b> <b>0° C to 55° C</b>  ±1.0 dB    ±1.8 dB
<b>Modulated Power Frequency Response‡</b> relative to 100 MHz	100 kHz to 2.9 GHz	<b>20° C to 30° C</b> <b>0° C to 55° C</b>  ±1.0 dB    ±1.3 dB
<b>RF Input Frequency Response‡</b>	100 kHz to 2.5 GHz 2.5 GHz to 2.9 GHz	±1.3 dB§ (±1.6 dB)# ±1.8 dB§ (±2.1 dB)#
<p>* Connector losses vary with such factors as connector type and quality, connector cleanliness, temperature, damage, and wear.</p> <p>† Applies to any wavelength for the case where the average readout is set to match the reading of a calibrated external optical power meter.</p> <p>‡ Specifications assume that either the HP 70904A and HP 70810B were calibrated together during the manufacturing process or that an extended system calibration (Option 020) has been performed. If not, use module specifications for frequency response. The module specifications are documented in the <i>HP 70810B and HP 70810B Option 850 Lightwave Section Installation and Verification Manual</i>.</p> <p>§ Amplitude measurement is in electrical dB units.</p> <p># Referenced to 300 MHz, -10 dBm calibrator.</p>		

**Table 3-22.**  
**HP 71401C Option 850 Lightwave Signal Analyzer Specifications and Characteristics (continued)**

<b>Electrical Input Flatness Corrected*</b> <i>(characteristic)</i>	<b>Frequency</b>  100 kHz to 2.9 GHz	<b>Amplitude Error</b>  1.4 dB*
<b>Displayed Average Optical Noise Level</b> 10 Hz Res BW, 3 Hz Vid BW Ref Level $\leq -40$ dBm	<b>Frequency</b>  100 kHz to 1 MHz 1 MHz to 10 MHz 10 MHz to 100 MHz 100 MHz to 2.9 GHz	<b>Displayed Noise Level</b>  -47 dBm -53 dBm -58 dBm -62 dBm
<b>Harmonic Distortion</b>	70 <sup>†</sup> dB below fundamental with modulated power $\leq -30$ dBm	
<b>Input Return Loss</b> <i>(characteristic)</i> with HMS-10/HP	$>27$ dB with input attenuation $\geq 5$ dB	
<b>Maximum Safe Optical Input Power</b>	<b>Average Power</b>  15 dBm	<b>Modulated Power</b>  15 dBm
<b>Optical Input Connectors<sup>‡</sup></b> <i>(Option-dependent)</i>	<b>Single-Mode Fiber Connectors</b> Diamond HMS-10/HP, FC/PC, ST, Biconic, DIN	
<b>GENERAL SPECIFICATIONS</b>		
<b>Temperature</b>	<b>Operation</b> 0°C to +55°C	<b>Storage</b> -40°C to +75°C
<b>EMI</b>	Conducted and radiated interference is in compliance with CISPR publication 11 (1975) and Messempefaenger-Postverfuegung 526/527/79 (Kennzeichnung Mit F-Nummer/Funkschutzzeichen). Radiated interference is in compliance with MIL-STD 461B, Part 7, RE02.	
* When a lightwave section is installed in a measurement system, add the amplitude-error value to the related flatness specifications for the system.		
<sup>†</sup> Amplitude measurement is in electrical dB units.		
<sup>‡</sup> Refer to the replaceable parts section of Chapter 2 for optical connector part numbers.		

**Table 3-22.**  
**HP 71401C Option 850 Lightwave Signal Analyzer Specifications and Characteristics (continued)**

<b>GENERAL SPECIFICATIONS (Continued)</b>	
<b>Power Requirements</b> HP 70001A Ratings  Voltage  Option 400  HP 70004A Ratings  Voltage	310 W maximum 570 VA maximum  90 to 132 V ac, 47 to 66 Hz 198 to 264 V ac, 47 to 66 Hz  103 to 132 V ac, 365 to 444 Hz  260 W maximum 350 VA maximum  90 to 132 V ac, 47 to 66 Hz and 356 to 444 Hz 198 to 264 V ac, 47 to 66 Hz
<i>Weight (characteristic)</i> HP 71401C Option 850  <b>Individual Modules</b>  HP 70001A Mainframe HP 70004A Display HP 70310A Precision Reference HP 70900B Local Oscillator HP 70902A IF Section HP 70903A IF Section HP 70904A RF Section HP 70810B Option 850 Lightwave Section	49 kg (108.1 lb)  14.5 kg (32 lb) 19.5 kg (43 lb) 2.2 kg (4.9 lb) 5.7 kg (12.6 lb) 2.4 kg (5.3 lb) 2.4 kg (5.3 lb) 2.9 kg (6.4 lb)  1.75 kg (3.9 lb)
<i>Physical Dimensions (characteristic)</i>	Refer to Figure 3-1 and Figure 3-2 for physical dimensions.

## Physical Dimensions of the HP 70004A Color Display and HP 70001A Mainframe

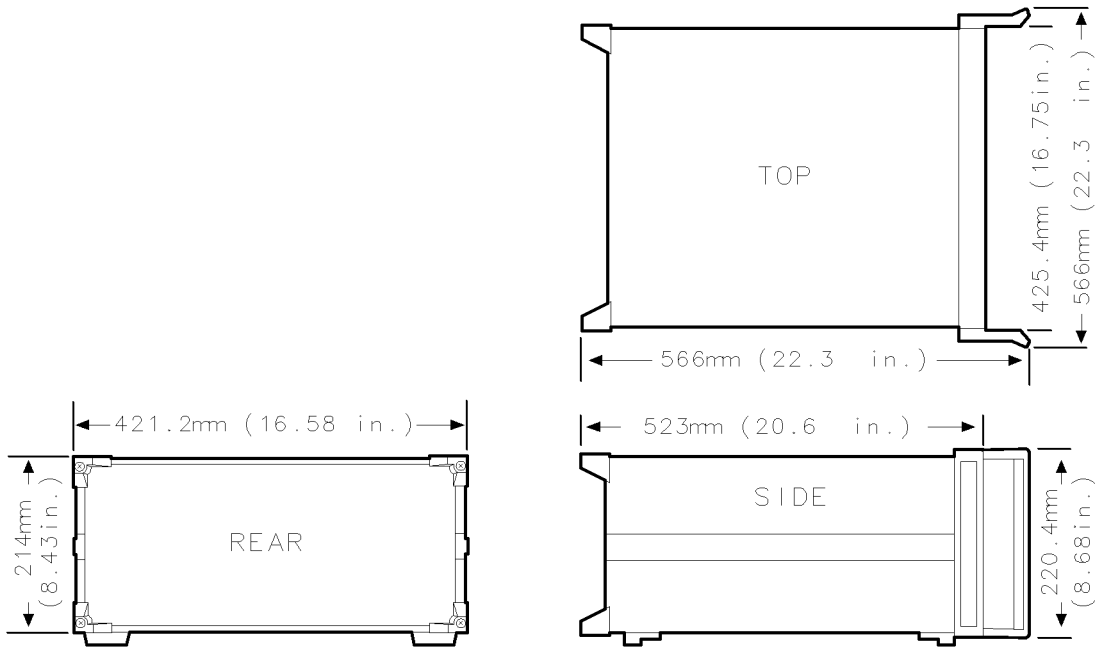

**Figure 3-1. HP 70004A Color Display Physical Dimensions**

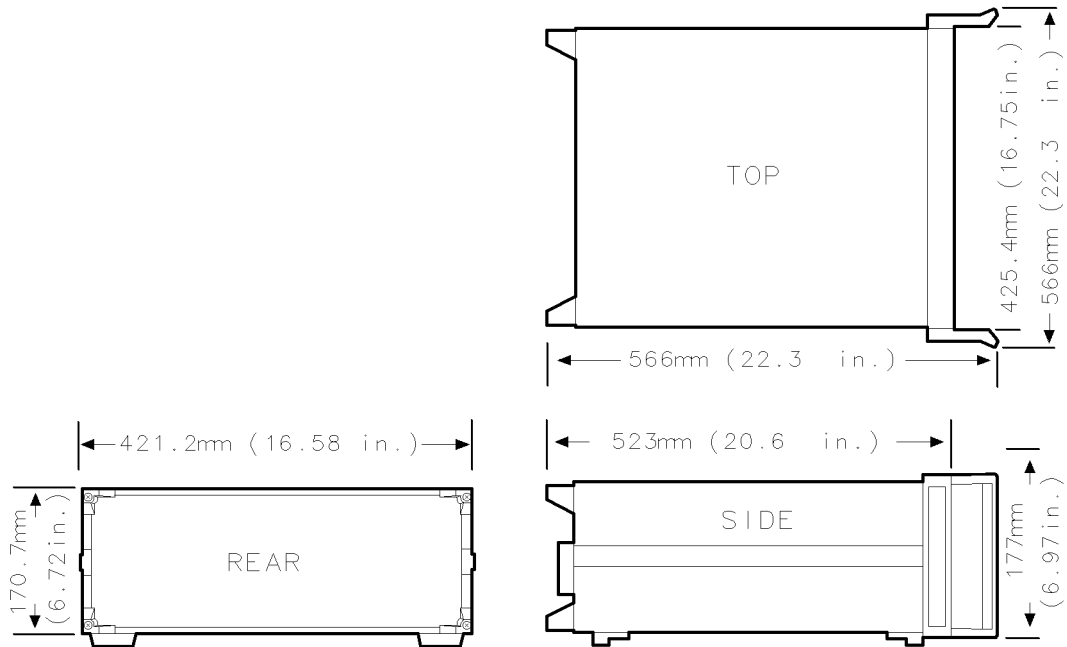

**Figure 3-2. HP 70001A Mainframe Physical Dimensions**

---

## **Module Input and Output Characteristics**

The following section covers the input and output specifications and characteristics of modules used in HP 70000 Series modular spectrum analyzer system. The data in this section is a characteristic unless identified as a specification.

For information on elements not covered in this section (for example, HP 70300A RF tracking generator or HP 70004A color display) refer to the installation and verification manual for the element of interest.



## HP 70310A Precision Frequency Reference

### 10 MHz

Output Power ( <i>specification</i> )	0 dBm 3 dB, -2 dB
Harmonics ( <i>specification</i> )	<-20 dBc
Spurious ( <i>specification</i> )	<-80 dBc

### 100 MHz

Output Power ( <i>specification</i> )	0 dBm 3 dB, -2 dB
Harmonics	<-25 dBc
Spurious	<-115 dBc

### Distribution Amplifier Input

Frequency ( <i>specification</i> )	10 to 300 MHz
( <i>typical</i> )	5 to 300 MHz
Power Range ( <i>specification</i> )	-4.0 dBm to +4.0 dBm
Impedance	50Ω ( <i>nominal</i> )

### Distribution Amplifier Output

Power:	
< 300 MHz ( <i>specification</i> )	0 dBm ±2 dB
300 MHz ( <i>specification</i> )	0 dBm ±1 dB
Impedance	50Ω ( <i>nominal</i> )
VSWR	≤ 1.5

**Note** Distribution amplifiers will distribute both the 100 MHz and 300 MHz system references without degradation in system performance.

## HP 70310A Precision Frequency Reference

### EXT REF

Frequencies ( <i>specification</i> )	1, 2, 5, or 10 MHz
Power Range ( <i>specification</i> )	-5 to 15 dBm
Damage Level ( <i>specification</i> )	1 W ( 30 dBm)
Impedance	50 $\Omega$ ( <i>nominal</i> )

System phase noise specifications can be met if the external-reference signal has the characteristics listed below:

External Reference Input Frequency ( <i>specification</i> )	10 MHz
Phase Noise:	
10 Hz Offset ( <i>specification</i> )	<-95 dBc/Hz
100 Hz Offset ( <i>specification</i> )	<-125 dBc/Hz
1 kHz Offset ( <i>specification</i> )	<-145 dBc/Hz
Spurious:	
< 1 kHz Offset ( <i>specification</i> )	<-135 dBc
$\geq$ 1 kHz Offset ( <i>specification</i> )	<-125 dBc

## HP 70600A Preselector/HP 70601A Preselector

### RF INPUT

Frequency Range	
Bypass Path .....	0 to 22.0/26.5 GHz
Low-Pass Filter Path .....	0 to 2.9 GHz
YIG-Tuned Filter (YTF) Path .....	2.7 to 22.0/26.5 GHz
Maximum Input Power	
ac (continuous) .....	.30 dBm
ac (peak) .....	100 W (1 $\mu$ s)
dc .....	0 V

Actual safe input power is limited by system's RF section input mixer. Maximum safe input power is 15 dBm in bypass mode with 0 dB attenuation.

### RF OUTPUT

Frequency .....	0 to 26.5 GHz
Insertion Loss	
Bypass Mode .....	$\leq 8$ dB
Filtered mode (with preselector peaked in YTF bands) .....	$\leq 22$ dB
Impedance .....	50 $\Omega$ ( <i>nominal</i> )

### TUNE + SPAN INPUT

Sensitivity .....	1.5 V/GHz
Impedance .....	1 M $\Omega$ ( <i>nominal</i> )

---

## HP 70810B Lightwave Section and HP 70810B Option 850 Lightwave Section

### LIGHTWAVE INPUT

HP 70810B Wavelength Range .....	1200 nm to 1600 nm
HP 70810B Option 850 Wavelength Range .....	750 nm to 870 nm
Frequency Range (demodulated signal) .....	100 kHz to 22 GHz
Maximum Input Average Optical Power .....	15 dBm

### RF INPUT

Frequency Range .....	0 Hz to 22 GHz
VSWR	
0 to 6 GHz .....	< 1.3
6 to 12 GHz .....	< 1.5
12 to 22 GHz .....	< 1.9

The actual input frequency range is limited by the frequency range of the RF section that is installed in the lightwave signal analyzer.

The actual safe input power is limited by the maximum safe input power of the RF section that is installed in the lightwave signal analyzer.

### RF OUTPUT

Frequency Range .....	0 Hz to 22 GHz
Insertion Loss .....	<5.2 dB

### HSWP IN/OUT

Line Type .....	TTL (open collector)
Sweep condition .....	low = not ready to sweep
Maximum Delay .....	200 $\mu$ s from HSWP high to sweep
Maximum Current Draw .....	16 mA

**HP 70900B Local Oscillator Source**

**100 MHz IN**

Frequency ..... 100 MHz  
 Power required ..... 0 dBm  $\pm$ 3 dB  
 Impedance ..... 50 $\Omega$  (*nominal*)

**300 MHz OUT**

Frequency ..... 300 MHz  
 Power ..... 0 dBm  $\pm$ 1 dB  
 Impedance ..... 50 $\Omega$  (*nominal*)

**CALIBRATOR**

Frequency Accuracy (*specification*) ..... 300 MHz  $\times$  frequency reference error  
 Power (*specification*) ..... -10 dBm  $\pm$ 0.3 dB  
 Impedance ..... 50 $\Omega$  (*nominal*)

**EXTERNAL TRIGGER IN**

Line Type ..... TTL, Positive Edge, 2 TTL loads

**HSWP IN/OUT**

Line Type ..... TTL (open collector)  
 Sweep condition ..... low = not ready to sweep  
 Maximum Delay ..... 200  $\mu$ s from HSWP high to sweep  
 Maximum Current Draw ..... 16 mA

**LO OUT**

Frequency ..... 3.0 GHz to 6.6 GHz  
 Power ..... +7 to 15 dBm  
 Impedance ..... 50 $\Omega$  (*nominal*)

**SWEEP**

Range ..... 0 to 10 V  
 Accuracy ..... 2%

**TUNE + SPAN OUT**

Range ..... 4.5 to 9.9 V  
 Sensitivity (for LO signal) ..... 1.5 V/GHz

**VIDEO IN**

Range ..... 0 to 2 V

---

## HP 70902A IF Section

### 21.4 MHz IN

Center Frequency .....	21.4 MHz
Nominal Input Power .....	-5 dBm
VSWR at 21.4 MHz $\pm$ 500 kHz .....	$\leq 1.5$
Impedance .....	50 $\Omega$ ( <i>nominal</i> )

### AUX OUT

Frequency .....	21.4 MHz
Output Power (with -5 dBm input) .....	-15 dBm $\pm$ 1 dB
VSWR .....	$\leq 1.5$
Impedance .....	50 $\Omega$ ( <i>nominal</i> )

### IF 3 MHz

Center Frequency .....	3 MHz
Output Power (with -5 dBm input in 100 Hz Res BW) .....	-15 dBm $\pm$ 1 dB
VSWR .....	$\leq 1.5$
Impedance .....	50 $\Omega$ ( <i>nominal</i> )

### LIMITED IF OUT

Frequency .....	3 MHz triangle wave
Output Amplitude (for use with frequency counters) .....	1 Vp-p $\pm$ 0.5 V

### VIDEO 0-1V

Impedance .....	1 k $\Omega$ ( <i>nominal</i> )
Output Amplitude (open circuit) .....	0 to 1 V
Accuracy .....	2%

### VIDEO OUT

Output Amplitude .....	0 to 2 V
Impedance .....	< 1 $\Omega$ ( <i>nominal</i> )

**HP 70903A IF Section**

**21.4 MHz IF**

Center Frequency .....	21.4 MHz
Output Amplitude (with -5 dBm input in 300 kHz Res. BW) .....	-15 dBm ±1 dB
VSWR .....	≤ 1.5
Impedance .....	<50Ω ( <i>nominal</i> )

**21.4 MHz IN**

Center Frequency .....	21.4 MHz
Nominal Input Power .....	-5 dBm
VSWR (21.4 MHz ±5 MHz) .....	≤ 1.2
Impedance .....	<50Ω ( <i>nominal</i> )

**IF 21.4 MHz Out**

Center Frequency .....	21.4 MHz
Output Power (with -5 dB input into 50Ω) .....	-5 dBm ±0.5 dB
VSWR .....	≤ 1.2
Impedance .....	<50Ω ( <i>nominal</i> )

**LINEAR AGC VIDEO**

Level (linearly related to RF INPUT) .....	1 V ( <i>nominal</i> )
Distortion (-30 dBm input, 90% Am, F <sub>mod</sub> = 10 kHz) .....	< 8% THD
Attack and Decay Times (periodic signals)	
Attack Time .....	30 μs
Decay Time .....	300 ms
Impedance .....	50Ω ( <i>nominal</i> )

**VIDEO 0-1V**

Output Voltage (open circuit) .....	0 to 1 V
Accuracy .....	±2%
Impedance .....	100Ω ( <i>nominal</i> )

**VIDEO IN**

Input Voltage .....	0 to 2 V
Impedance .....	50Ω ( <i>nominal</i> )

**VIDEO OUT**

Range .....	0 to 2 V
Source Impedance .....	< 1Ω ( <i>nominal</i> )

---

## HP 70904A RF Section

### 1st LO IN

Frequency .....	3.0 GHz to 6.6 GHz
Amplitude .....	-0.5 dBm to +19.0 dBm
Impedance .....	50Ω ( <i>nominal</i> )

### 1st LO OUT

Frequency .....	3.0 to 6.6 GHz
Output Power .....	+2.6 dBm to +14.9 dBm
VSWR .....	≤ 2.3
Impedance .....	50Ω ( <i>nominal</i> )

### 21.4 MHz OUT

Center Frequency .....	21.4 MHz
Output Power (for -10.0 dBm, 300 MHz RF INPUT signal with 10 dB attenuation) .....	-15.0 ±0.5 dBm
VSWR .....	≤ 1.5
Impedance .....	50Ω ( <i>nominal</i> )

### 300 MHz IN

Frequency .....	300 MHz ±30 kHz
Input Power .....	-2.0 to +2.0 dBm
VSWR (at 300 MHz) .....	≤ 1.5
Impedance .....	50Ω ( <i>nominal</i> )

### PROBE POWER

Outputs (150 mA maximum) .....	+15 V ±10%, -12.6 V ±10%
--------------------------------	--------------------------

### RF INPUT

Frequency .....	100 Hz to 2.9 GHz
VSWR (with LO freq. equal to RF freq. + 3.6214 GHz)	
0 dB attenuation .....	≤ 2.9
≥ 10 dB attenuation .....	≤ 1.3
Maximum Input Level	
ac (continuous, ≤ 10 dB attenuation) .....	30 dBm
ac (peak power) .....	100 W at 10 μs pulse with ≥ 50 dB attenuation
dc (ac coupled) .....	±25 V
dc (dc coupled) .....	0 V
Maximum Input Level at Mixer .....	≤ 15 dBm continuous power
Impedance .....	50Ω ( <i>nominal</i> )



**HP 70905A RF Section**

**1st LO IN**

Frequency ..... 3.0 to 6.6 GHz  
 Amplitude ..... -0.5 dBm to +19.0 dBm  
 Impedance ..... 50Ω (*nominal*)

**1st LO OUT**

Frequency ..... 3.0 to 6.6 GHz  
 Output Power ..... +2.4 dBm to +15.5 dBm  
 VSWR ..... ≤ 2.1  
 Impedance ..... 50Ω (*nominal*)

**21.4 MHz OUT**

Center Frequency ..... 21.4 MHz  
 Output Power (for -10 dBm, 300 MHz signal with 10 dB atten.) ..... -15.0 ±0.5 dBm  
 VSWR ..... ≤ 1.5  
 Impedance ..... 50Ω (*nominal*)

**300 MHz IN**

Frequency ..... 300 MHz ±30 kHz  
 Input Power ..... -2.0 dBm to +2.0 dBm  
 VSWR (at 300 MHz) ..... ≤ 1.5  
 Impedance ..... 50Ω (*nominal*)

**321.4 MHz IF IN**

Frequency ..... 321.4 MHz ±5 MHz  
 Minimum Input Level ..... -20 dBm  
 VSWR (at 321.4 MHz) ..... ≤ 2.3  
 Impedance ..... 50Ω (*nominal*)

**321.4 MHz IF OUT**

Output tracks 21.4 MHz IF Output with a nominal offset of -21 dB (321.4 MHz IF bands only.)

Frequency Range ..... 100 MHz to 700 MHz  
 VSWR ..... ≤ 1.9  
 Impedance ..... 50Ω (*nominal*)

## HP 70905A RF Section

### RF INPUT

Frequency Range .....	50 kHz to 22.0 GHz
Maximum Input Level	
ac (continuous, > 10 dB attenuation) .....	30 dBm
ac (peak power) .....	100 W at 10 $\mu$ s pulse with $\geq$ 50 dB attenuation
dc ( $\geq$ 10 dB attenuation) .....	0 V
dc (0 dB attenuation) .....	$\pm$ 25 V
Maximum Input Level at Mixer .....	$\leq$ 15 dBm continuous power
VSWR ( $\geq$ 10 dB attenuation)	
0 to 12.7 GHz .....	$\leq$ 1.7
12.7 to 18.0 GHz .....	$\leq$ 2.0
18.0 to 22.0 GHz .....	$\leq$ 2.5
Impedance .....	50 $\Omega$ ( <i>nominal</i> )

**HP 70906A RF Section**

**1st LO IN**

Frequency Range ..... 3.0 to 6.6 GHz  
 Amplitude ..... -0.5 dBm to +19.0 dBm  
 Impedance ..... 50Ω (*nominal*)

**1st LO OUT**

Frequency Range ..... 3.0 to 6.6 GHz  
 Output Power ..... +2.4 dBm to +15.5 dBm  
 VSWR ..... ≤ 2.1  
 Impedance ..... 50Ω (*nominal*)

**21.4 MHz OUT**

Center Frequency ..... 21.4 MHz  
 Output Power (for -10 dBm, 300 MHz with 10 dB atten.) ..... -5.0 ±0.5 dBm  
 VSWR ..... ≤ 1.5  
 Impedance ..... 50Ω (*nominal*)

**300 MHz IN**

Frequency ..... 300 MHz ±30 kHz  
 Input Power ..... -2.0 dBm to +2.0 dBm  
 VSWR (at 300 MHz) ..... ≤ 1.5  
 Impedance ..... 50Ω (*nominal*)

**321.4 MHz IF IN**

Frequency ..... 321.4 MHz ±5 MHz  
 Maximum Input Level ..... -20 dBm  
 VSWR ..... ≤ 2.3  
 Impedance ..... 50Ω (*nominal*)

**321.4 MHz IF OUT**

Output tracks 21.4 MHz IF Output with a nominal offset of -21 dB (321.4 MHz IF bands only.)

Frequency Range ..... 100 MHz to 700 MHz  
 VSWR ..... ≤ 1.93  
 Impedance ..... 50Ω (*nominal*)

## HP 70906A RF Section

### RF INPUT

Frequency Range .....	50 kHz to 26.5 GHz
Maximum Input Level	
ac (continuous) .....	30 dBm
ac (peak power) .....	100 W at 10 $\mu$ s pulse with $\geq$ 50 dB attenuation
dc ( $\geq$ 10 dB attenuation) .....	0 V
dc (0 dB attenuation) .....	$\pm$ 25 V
Maximum Input Level at Mixer .....	$\leq$ 15 dBm continuous power
VSWR ( $\geq$ 10 dB attenuation)	
0 to 12.7 GHz .....	$\leq$ 1.7
12.7 to 18.0 GHz .....	$\leq$ 2.0
18.0 to 22.0 GHz .....	$\leq$ 2.5
Impedance .....	50 $\Omega$ ( <i>nominal</i> )

## HP 70905B RF Section and HP 70906B RF Section

### 1st LO IN

Frequency .....	3.0 to 6.6 GHz
Amplitude .....	-0.5 dBm to +19.0 dBm
Impedance .....	50Ω ( <i>nominal</i> )

### 1st LO OUT

Frequency .....	3.0 to 6.6 GHz
Output Power .....	+2.4 dBm to +15.5 dBm
VSWR .....	≤ 2.1
Impedance .....	50Ω ( <i>nominal</i> )

### 21.4 MHz OUT

Center Frequency .....	21.4 MHz
Output Power (for -10 dBm, 300 MHz signal with 10 dB atten.) .....	-5.0 ±0.5 dBm
VSWR .....	≤ 1.5
Impedance .....	50Ω ( <i>nominal</i> )

### 300 MHz IN

Frequency .....	300 MHz ±30 kHz
Input Power .....	-2.0 dBm to +2.0 dBm
VSWR (at 300 MHz) .....	≤ 1.5
Impedance .....	50Ω ( <i>nominal</i> )

### 321.4 MHz IF IN

Frequency .....	321.4 MHz ±5 MHz
Maximum Input Level .....	-20 dBm
VSWR .....	≤ 2.3
Impedance .....	50Ω ( <i>nominal</i> )

### 321.4 MHz IF OUT

Output tracks 21.4 MHz IF Output with a nominal offset of -21 dB ±1 dB (321.4 MHz IF bands only, at 2.7 GHz RF frequency).

Frequency Range .....	100 MHz to 700 MHz
VSWR .....	≤ 1.9
Impedance .....	50Ω ( <i>nominal</i> )

### RF INPUT

Frequency Range .....	50 kHz to 22/26.5 GHz
Maximum Input Level	
ac (continuous) .....	15 dBm
dc .....	±25 V
Impedance .....	50Ω ( <i>nominal</i> )

---

## HP 70907A External Millimeter Interface Module

### MIXER BIAS OUTPUT

<i>Maximum Voltage (characteristic)</i> .....	3.3 V
<i>Current Range, <math>-2\text{ V} &lt; V_{out} &lt; 2\text{ V}</math></i>	
Range (specification) .....	-10 to +10 mA
<i>Resolution (characteristic)</i> .....	< 20 $\mu\text{A}$
Accuracy (specification) .....	$\pm 30\ \mu\text{A}$
Source Impedance .....	> 1 M $\Omega$ ( <i>nominal</i> )

### LO OUTPUT

Frequency Range (specification) .....	3.0 to 6.6 GHz
Output Power (specification) .....	16 dBm $\pm 1.5\text{ dB}$
<i>VSWR (characteristic)</i> .....	$\leq 1.9$
Impedance .....	50 $\Omega$ ( <i>nominal</i> )

### IF INPUT

<i>Frequency (characteristic)</i> .....	321.4 MHz
<i>Maximum Safe Input Level (characteristic)</i>	
<i>ac</i> .....	$\leq 30\text{ dBm}$
<i>dc</i> .....	$\pm 3\text{ V}$
<i>VSWR at <math>321.4 \pm 5\text{ MHz}</math> (characteristic)</i> .....	$\leq 1.8$
Impedance .....	50 $\Omega$ ( <i>nominal</i> )

### Rear-Panel Inputs and Outputs

For rear panel input and output information, refer to the *HP 70907A/B External Mixer Interface Installation and Verification Manual*.

## HP 70907B External Millimeter Interface Module

### Front-Panel Inputs and Outputs

#### PRESEL TUNE + SPAN INPUT

Voltage Range (specification) .....	< 4.5 to > 9.9 V
Tuning Sensitivity (specification) .....	1.5 V/GHz
Load Impedance .....	> 10 k $\Omega$ ( <i>nominal</i> )

#### MIXER BIAS

<i>Maximum Voltage (characteristic)</i> .....	3.3 V
<i>Current Range, -2 V &lt; Vout &lt; 2 V</i>	
Range (specification) .....	-10 to +10 mA
<i>Resolution (characteristic)</i> .....	< 20 $\mu$ A
Accuracy (specification) .....	$\pm$ 30 $\mu$ A
Source Impedance .....	> 1 M $\Omega$ ( <i>nominal</i> )

#### LO OUTPUT

Frequency Range (specification) .....	3.0 to 6.6 GHz
Output Power (specification) .....	16 dBm $\pm$ 1.5 dB
<i>VSWR (characteristic)</i> .....	$\leq$ 1.9
Impedance .....	50 $\Omega$ ( <i>nominal</i> )

#### IF INPUT

<i>Frequency (characteristic)</i> .....	321.4 MHz
<i>Maximum Safe Input Level (characteristic)</i>	
<i>ac</i> .....	$\leq$ 30 dBm
<i>dc</i> .....	$\pm$ 3 V
<i>VSWR at 321.4 <math>\pm</math>5 MHz (characteristic)</i> .....	$\leq$ 1.8
Impedance .....	50 $\Omega$ ( <i>nominal</i> )

### Rear-Panel Inputs and Outputs

For rear panel input and output information, refer to the *HP 70907A/B External Mixer Interface Installation and Verification Manual*.

---

## HP 70908A RF Section

### 1st LO IN

Frequency .....	3.0 to 6.6 GHz
Input Power .....	+4.0 to +12.0 dBm
VSWR .....	$\leq 2.4$
Impedance .....	50 $\Omega$ ( <i>nominal</i> )

### 1st LO OUT

Frequency .....	3.0 to 6.6 GHz
Output Power .....	5 dBm to 12 dBm
VSWR .....	$\leq 3.0$
Impedance .....	50 $\Omega$ ( <i>nominal</i> )

### 21.4 MHz OUT

Center Frequency .....	21.4 MHz
Output Power (0 dB input power, 10 dB attenuation) .....	-5 dBm
VSWR .....	$\leq 1.5$
Impedance .....	50 $\Omega$ ( <i>nominal</i> )

### 300 MHz IN

Frequency .....	300 MHz $\pm$ 30 MHz
Input Power .....	-2.0 to +2.0 dBm
Impedance .....	50 $\Omega$ ( <i>nominal</i> )

### 321.4 MHz IF OUT

Output is switched and is available for all input frequencies.

Frequency Range .....	100 MHz to 700 MHz
Output Power .....	-5 dBm for -10 dBm input to mixer
VSWR .....	$\leq 1.9$
Impedance .....	50 $\Omega$ ( <i>nominal</i> )
Bandwidth, 100 Hz to 2.9 GHz ( <i>specification Option H10 Only</i> ) .....	> 50 MHz

### RF INPUT

Frequency .....	100 Hz to 22 GHz
Maximum Input Level	
ac (continuous) .....	30 dBm with $\geq 10$ dB attenuation
ac (peak power) .....	100 W, 10 $\mu$ s pulse with $\geq 50$ dB attenuation
dc .....	0 V
Maximum Input Level at Mixer .....	$\leq 20$ dBm continuous power
VSWR ( $\geq 10$ dB attenuation)	
0 to 12.7 GHz .....	$\leq 1.9$
12.7 to 18.0 GHz .....	$\leq 2.3$
18.0 to 22.0 GHz .....	$\leq 2.5$
Impedance .....	50 $\Omega$ ( <i>nominal</i> )



**TUNE + SPAN INPUT**

Input Range .....	4.5 V to 9.9 V
Sensitivity .....	1.5 V/GHz
Impedance .....	20 k $\Omega$ ( <i>nominal</i> )

---

## HP 70909A RF Section and HP 70910A RF Section

### 1st LO IN

Frequency .....	3.0 to 6.6 GHz
Input Power .....	-0.5 to 19 dBm
Impedance .....	50 $\Omega$ ( <i>nominal</i> )

### 1st LO OUT (Front Panel)

Frequency Range ( <i>specification</i> ) .....	3.0 to 6.6 GHz
Output Power ( <i>specification</i> ) .....	+14.0 to +18.0 dBm
VSWR .....	< 2.1
Impedance .....	50 $\Omega$ ( <i>nominal</i> )

### 1st LO OUT (Rear Panel)

Frequency Range .....	3.0 to 6.6 GHz
Output Power .....	+2.6 to +14.9 dBm
VSWR .....	< 2.4
Impedance .....	50 $\Omega$ ( <i>nominal</i> )

### 21.4 MHz OUT

Center Frequency .....	21.4 MHz
Output Power (0 dB input power, 10 dB attenuation) .....	-5 dBm
VSWR .....	$\leq$ 1.5
Impedance .....	50 $\Omega$ ( <i>nominal</i> )

### 300 MHz IN

Frequency .....	300 MHz $\pm$ 30 kHz
Input Power .....	-2.0 to +2.0 dBm
Impedance .....	50 $\Omega$ ( <i>nominal</i> )

### 321.4 MHz IF OUT

Minimum Preselected 3 dB Bandwidth (HP 70909A) .....	27 MHz
Minimum Preselected 3 dB Bandwidth (HP 70910A) ( <i>specification 20 - 30 °C</i> ) .....	36 MHz
Output Power .....	-5 dBm for -10 dBm input to mixer
VSWR .....	$\leq$ 1.5
Impedance .....	50 $\Omega$ ( <i>nominal</i> )

### RF INPUT (APC 3.5)

Frequency .....	100 Hz to 26.5 GHz
Maximum Input Level at attenuator ( <i>specification</i> )	
ac (continuous) .....	30 dBm with $\geq$ 10 dB attenuation
ac (peak power) .....	100 W, 10 $\mu$ s pulse with $\geq$ 50 dB attenuation
dc .....	0 V
VSWR ( $\geq$ 10 dB attenuation)	
0 to 6.2 GHz .....	< 1.4
6.0 to 26.5 GHz .....	< 2.0

**HP 70909A RF Section and HP 70910A RF Section**

Impedance ..... 50 $\Omega$  (*nominal*)

**TUNE + SPAN INPUT (with external mixer selected)**

Voltage Range ..... 0 to 13.5 V  
Tuning Sensitivity ..... 1.5 V/GHz of L.O. frequency  
Voltage Accuracy .....  $\pm 0.4\%$   
Preselector DAC Range .....  $\pm 40$  mV  
Load Impedance .....  $> 10$  k $\Omega$



## System Operation Verification

---

This chapter describes how to install, configure, and operate the *System Operation Verification Software*. In addition, this chapter gives a description of each operation verification test, and lists the error and status messages that may occur.

The tests documented in this section verify the electrical performance of a system that has an HP 70900A/B local oscillator source as the master element. This is done by using the *System Operation Verification Software* provided with this manual. Table 4-1 and Table 4-2 list all of the equipment needed for the system operation verification tests. Each test description lists the equipment needed for that specific test.

---

**Note** The *System Operation Verification Software* automates the electrical performance verification of an HP 70000 Series modular spectrum analyzer system whose master module is an HP 70900A/B local oscillator source. Some systems (for example, a system with two HP 70907A external millimeter interface modules) may have more than one input. For information about testing each input, refer to “Testing Multiple Systems”.

---

---

### Shipment Contents

This documentation supports *System Operation Verification Software*, Revision C.01.02 or greater.

*System Operation Verification Software* provides both the user interface and individual test programs. If you are testing a system that includes modules that are not part of a predefined system, accessory software may be needed to test the additional modules. The two types of packages and their contents are described below.

- The menu-key-driven *System Operation Verification Software* automates the test process. This program is the same for each system and is documented in this manual. It includes the following items:
  - Executive Disk
  - Operating Disk
  - Test Disk
- Accessory software contains performance tests applicable to specific modules that, although they are not part of a predefined system, can be used with the system. An example of this program is Test Disk 3, provided with HP 70300A RF tracking generator and HP 70301A microwave tracking generators. The manual with each Accessory Software package documents the test descriptions, test setups, and test equipment requirements that are applicable to the specific modules. The quantity of Test Disks will vary with each accessory software package.

---

**Note** Make a working copy of each disk before installing any of the software, then store the master disks in a safe place.

---

---

## Software Version

The *System Operation Verification Software* version and the HP part number of the program will be needed if you contact Hewlett-Packard about this software. The HP part number of the *System Operation Verification Software* is printed on the disk labels. The software version of the program is visible on the right-hand side of the display that appears after the first program disk is loaded. It is also visible in the Main Menu and the Test Menu. Specific numbers vary, but the version number looks like this: Rev. A.02.00.

---

## Software/Hardware Compatibility

### Computer Hardware Compatibility

System Performance Test software is written in HP 9000 Series BASIC 5.0. There is no copy protection. The software can run on the following HP 9000 Series 200/300 computers. Minimum RAM requirement is 4.0 megabytes.

HP 9816	HP 9920 (with HP 35721A Monitor)
HP 9836	HP 9000 Series 300 computer

When using an HP 9000 Series 300 computer, a medium-resolution monitor and either an HP 98203C or an HP 46020A/46021A keyboard are required. If printed results are not needed, a high-resolution monitor can be used.

Due to the various keyboards supported, some minor text differences appear in the menus and keys displayed on-screen. (Refer to “Typographic Conventions”.)

### Computer Language Compatibility

---

**Note** If you have set up some RAM memory for specific usage, be aware that this program uses RAM memory Volume “:MEMORY, 0, 15”. Move any information stored at this Volume to another location before running the System Performance Test software program.

---

The software program runs on HP BASIC 5.0, or later, with the following BIN files in RAM.

CLOCK	HPIB
CS80 (optional – supports newer Winchester disk drives)	IO
DISC (optional – supports microfloppies and older Winchester disk drives)	KBD
ERR	MAT
GRAPH	MS
GRAPHX	PDEV (optional – provides debugging features for program development)
CRTA or CRTB	

In an SRM (shared resource management) environment, the following BIN files are also required:

DCOMM  
SRM

In an HFS (hierarchical file structure) environment, the following BIN file is also required:

HFS

### **Printer Compatibility**

System Performance Test software supports any HP-IB printer; however, many of the printed test results require a graphics printer. Graphical test results are not output to a non-graphics printer.

---

**Note** It is not possible to print graphical test results when an HP 9000 Series 300 controller is used with a high-resolution monitor. (Refer to “Computer Hardware Compatibility”.)

---

---

## Typographic Conventions

This chapter uses the following conventions:

**KEY** Text that looks like this represents the key label of a key physically located on the computer or the front panel of an analyzer.

**menu key** Text that looks like this represents a **menu key**, a key whose label is determined by the instrument's firmware. When key labels are written in lowercase letters, a sub-level menu exists for that particular menu key. Key labels written in uppercase letters indicate that no further sub-level menus exist for that menu key.

**Text** Text that looks like this represents messages displayed on the display screen, or text that the user enters via the keyboard.

For simplicity in this document, we assume that you are using either an HP 9000 Series 200 controller keyboard, or an HP 98203C keyboard. Refer to the table below if your keyboard key labels do not match the ones used in text.

Key Labels Shown In This Document	Alternate Key Labels
<b>EXECUTE</b>	<b>RETURN</b>
<b>ENTER</b>	<b>RETURN</b>
<b>RUN</b>	press <b>SYSTEM</b> , then <b>RUN</b>
<b>CONTINUE</b>	press <b>SYSTEM</b> , then <b>CONTINUE</b>



## Required Test Equipment

External test equipment required for operation verification is listed in Table 4-1. A list of accessories required for operation verification is given in Table 4-2.

**Note** A technical computer is necessary. Refer to “Computer Hardware Compatibility” for requirements.

**Table 4-1. External Test Equipment**

Category	HP Model Number for RF and $\mu$ W Systems <sup>1</sup>	HP Model Number for Millimeter Systems <sup>1</sup>
Printer (any HP-IB printer)	Graphics/Non-Graphics	Graphics/Non-Graphics
Level Generator	HP 3335A	
Microwave Source	HP 8340A, HP 8340B, HP 8341A, HP 8341B, or HP 8360 sources	
Synthesized Source	HP 8340A, 8340B, HP 8341A, HP 8341B, or HP 8360 sources	
General Source		HP 8340A, HP 8340B, HP 8341A, HP 8341B, or HP 8360 sources
Frequency Counter	HP 5342A or HP 5343A	HP 5342A or HP 5343A
Measuring Receiver		HP 8902A
Signal Sensor		HP 11722A
Power Meter	HP 436A or HP 8902A	HP 436A or HP 8902A
RF Power Sensor	HP 8482A or HP 11722A	
$\mu$ W Power Sensor	HP 8485A <sup>2</sup> , HP 8481A, HP 8487A <sup>3</sup> , or HP 11972A	HP 8485A, HP 8481A, or HP 11972A
Power Splitter Type N (f) connectors APC 3.5 (f) connectors APC 3.5 (f) connectors	HP 11667A HP 11667B <sup>2</sup> HP 11667C <sup>3</sup>	HP 11667B HP 11667B
Hybrid Combiner		Mini-Lab Circuits (p/n ZFSC-2-5)
50 $\Omega$ Termination	N/A	N/A

1 The first item listed is the recommended model of test equipment.

2 Recommended for  $\mu$ W modular spectrum analyzer.

3 This model is used for the HP 71209A Option Z40 microwave spectrum analyzer.

**Table 4-2. Required Accessories**

Accessory	HP Model or Part Number
<b>Adapters</b>	
Type N (f)-to-BNC (m)	1250-0077
Type N (m)-to-BNC (f) <i>HP 70904A RF section only</i>	1250-0780 <sup>1</sup>
APC 3.5 (f)-to-Type N (m)	1250-1744
BNC (f)-to-dual banana plug	1251-2277
APC 3.5 (f)-to-APC 3.5 (f) <i>HP 70906A RF section only</i>	1250-1749 <sup>1</sup> or 5061-5311
<b>Cables</b>	
BNC (m)-to-SMB (m), 122 cm (48 in.)	85680-60093 <sup>1</sup>
BNC (m)-to-BNC (m), 122 cm (48 in.)	HP 10503A
SMA (m)-to-SMA (m), 61 cm (24 in.)	8120-3124
APC 3.5(m)-to-APC 3.5 (m), (low-loss cable), 99 cm (38 in.)	8120-4921
APC 2.4(m) to APC 2.4(m) 1 meter	1946-8000-0140 <sup>2</sup>
<b>Terminations</b>	
Type N (m), 50Ω	HP 908A
APC 3.5 (m), 50Ω	HP 909D

<sup>1</sup> Recommended accessory.

<sup>2</sup> This model is used for the HP 71209A Option Z40 microwave spectrum analyzer. (This is not an HP part number, but is available from Adams Russell).

---

## Operation Verification Test Software Overview

### Testing Multiple Systems

*System Operation Verification Software* tests only one system at a time. If you have more than one RF section module to test in your configuration, test them separately. If you have tested a RF section module and want to select another RF section module to test without turning off the controller, follow the steps below.

---

**Note** The program erases test results stored on disk the first time it enters the Test Menu. Therefore, if you want a printed copy of the previously run test results, you must print them before pressing **test menu**. Refer to the “Parameter Menu” and “Main Menu” sections in this chapter. “Parameter Menu” contains information on configuring the software to save test results to disk. “Main Menu” contains information about the **REPRINT** menu key.

---

1. Get to the Main Menu.
2. Press `RESTART` , then press `HP-MSIB map` .
3. Place the cursor to indicate the desired RF module.
4. Press `SELECT MODULE` to select the desired RF section module. (The `SELECT MODULE` menu key is only present when more than one RF section module is present.)
5. Press `main menu` .

## Types of Error Messages or Warnings Defined

There are three kinds of error messages or warnings generated by the program.

- One type appears briefly at the bottom of the display. The program then goes automatically to a menu that asks you for corrections or modifications.
- Another type of error message begins with `ERROR MESSAGE` and provides special menu keys. These errors are user-correctable and anticipated by the program. There is usually a `Possible Fix` message displayed to help you clear the problem.
- The final type begins with `ERROR` and provides no special menu keys. The message informs you of an unanticipated error. There is no suggested fix displayed. If you cannot recover from one of these errors, please contact your Hewlett-Packard Sales and Service Office.

Detailed error and status message information is available at the end of this chapter.

## Limited Cal Defined

Limited Cal provides the same function as All Tests by performing a predefined sequence of every test. It is used to verify system operation.

## Single Tests Defined

You may select individual tests with this program. Refer to “Test Menu” in the “Menus” section of this chapter.

## Test Results

For each test, the program indicates whether the system passed or requires adjustment.

## Printing Test Results

You can use the Parameter Menu to configure the program to format and print test results. Test results will be automatically printed if the program is correctly configured, an HP-IB printer is on the bus, and the printer address is provided in the Equipment Menu. The printout includes title and summary pages. The summary page will be printed at the completion of the Limited Cal or All Test modes of operation if the printer is selected for `Results sent to:` in the Parameter Menu. The summary page will also be printed when the Test Menu `SUMMARY` menu key is pressed.

The title page lists the following data:

- *System Operation Verification Software* used, version code for the user interface software, and the test date.
- Model number, serial number, and firmware version of the modules tested.
- Test person's identification.
- Ambient temperature.
- Ambient humidity.
- Test equipment names, model numbers, addresses, and ID or serial number.

The Summary Page contains the following information:

- *System Operation Verification Software* used, version codes for user interface and test package software, and the test date.
- Model number, serial number, and firmware version of the modules tested.
- Text indicating that the instrument passed, or that it requires adjustment or repair to meet specifications.
- There may also be listings of tests under one or more of the following categories:
  - The following tests showed insufficient performance.
  - The following tests were not completed due to setup errors.
  - The following tests met the appropriate specifications.
  - The following tests were not completed.

---

## Start-Up Procedures

Start-up procedures including configuring the hardware and installing the test program are defined below.

---

<b>Note</b>	The configuration of the current system is easily verified on the HP-MSIB Map Screen Menu. The user interface software automatically reads system configuration data from the Hewlett-Packard Modular System Interface Bus (HP-MSIB). This data is then written to the HP-MSIB Map Screen Menu as a list of the modules in the current system. Refer to Chapter 2, "Installation," of this manual for information about the configuration of various HP 70000 Series modular spectrum analyzers.
-------------	--------------------------------------------------------------------------------------------------------------------------------------------------------------------------------------------------------------------------------------------------------------------------------------------------------------------------------------------------------------------------------------------------------------------------------------------------------------------------------------------------

---

## Configuring the Hardware

Use the following procedure to configure the hardware:

1. Connect the HP 70000 Series modular spectrum analyzer system to the computer port determined by the following criteria:
  - a. If your computer has an HP 98624A HP-IB Interface, connect your analyzer to the port labeled HP-IB SELECT CODE 8. If needed, refer to the *HP 9000 Series 200/300 Peripheral Installation Guide, Volume 1*.
  - b. If your computer does not have an HP 98624A HP-IB Interface, connect the HP 70000 Series modular spectrum analyzer system to the port labeled HP-IB SELECT CODE 7.

2. Connect the HP-IB cables from the test equipment to the computer's HP-IB SELECT CODE 7 port.
3. Use a 0.5 meter HP-IB cable (HP 10833D, or similar cable) to connect any external disk drive's HP-IB to the HP-IB SELECT CODE 7 port.

---

**Note** Occasionally disk drives exhibit unpredictable behavior when sharing the HP-IB with instruments. If you find this occurring, connect the disk drive to a separate HP-IB interface.

---

4. Set the external test equipment and the HP 70000 Series modular spectrum analyzer system line switches to on. Allow the equipment to warm up as specified.
5. Turn on the disk drive (if used) and computer.

## Installing Operation Verification Software

This section contains a procedure for installing the program. More specific program-operation information is contained in "Menus," later in this chapter.

Two assumptions are made with the Operation Verification test software: that you are using standard HP-IB addresses for the test equipment, and that all passive devices are available. If either of these assumptions is incorrect, you must use the Equipment Menu edit screen to correctly report your test configuration.

---

**Note** The program software version and the program part number will be needed if you contact Hewlett-Packard about this software. The software version of the program is visible on the right-hand side of the display that appears after the first program disk is loaded. It is also visible in the Main Menu and the Test Menu. Specific numbers vary, but the version number looks like this: Rev. B.03.00. The program part number is printed on the disk labels.

---

Use the following steps to install the program.

1. Load BASIC 5.0 or later, with the appropriate binaries, into an HP 9000 Series 200/300 computer. If necessary, refer to an HP BASIC reference manual.

---

**CAUTION** Make backup copies of all write-protected disks. If the program data on an individual disk should become altered, it cannot be ordered separately. The entire set of disks must be ordered to replace any one.

---

2. Assign the MSI (mass storage is) to the drive you will use as the default drive. As an example, assigning the MSI to a disk drive looks like this: MSI ":,700,0"
3. Insert Executive Disk into the assigned default drive. Type the following command line:  
LOAD "900\_OP\_VER",1
4. Press **(EXECUTE)**. The software version number appears in the screen that is next displayed.
5. If the date and time prompt appears, enter the date and time in the specified format. (This message appears only if date and time are not current.)
6. If you are using your system's software for the first time, a message appears stating that mass storage data is needed. Press **PROCEED** to use the default storage location, or **mass storage** to enter the Mass Storage edit screen. The Mass Storage edit screen allows you to edit the msus and directory path for the OPERATING Volume. Because the OPERATING Volume tells the program where to find all of the other mass storage locations,

edits made to the locations of the other volumes will be overwritten by old information unless the OPERATING Volume location is edited before you exit the Mass Storage Menu. (Once mass storage data is stored, the message will not reappear.)

7. Load the Operating Disk as directed. Unless the mass storage information was changed in Step 7 above, the Operating Disk should remain in the drive specified as the MSI default drive.
8. Load Test Disk by inserting it into the drive specified on-screen and pressing **PROCEED**. This process may require up to 2 minutes.
9. If you have not entered serial numbers for passive devices that require calibration data for test purposes, on-screen prompts request the data now. Enter the data via the Cal Data edit screen. Press **CREATE** to access this screen. For a detailed explanation of entering calibration data, refer to “Editing Calibration Data” in the “Equipment Menu” section of this chapter. Enter the serial number for each device specified, or bypass the device to continue if it is not used now. After data for the passive devices has been entered and stored, this prompt screen will not reappear.

---

**Note**            The program displays any additional passive devices that require serial numbers and calibration data. Serial numbers are only required for passive devices that need their calibration data stored on the Operating Disk. You are prompted to enter serial numbers for these devices only. In the future, rather than entering the data for passive devices with given serial numbers each time you begin testing, you can use the calibration data that was stored on the Operating Disks.

---

10. After completing the above procedure, you may perform any of the items listed below:
  - Select **LIMITED CAL** or **ALL TESTS** to automatically perform a predefined sequence of tests. The program will *not* run a test if any of the test equipment required for that test is missing.
  - Press **equipment menu** and return to the Equipment Menu. From here you can modify the status of the equipment in the menu (make it unavailable, readdress it, change the model number, and so on). Refer to “Equipment Menu” in this chapter.
  - Press **test menu** to display the Test Menu and select individual performance tests.
  - Press **MAIN MENU** to customize your test process via any other menu.

---

## Menus

This section contains information about the user interface menus.

### Menu Structure

The first menu presented allows you to go to the Main Menu, to begin Limited Cal (Quick Test), or to return to the Equipment Menu. From the Main Menu you can access all of the other menus. Figure 4-1 through Figure 4-4 at the end of this section show the menu structure.

The Mass Storage Menu, Parameter Menu, Equipment Menu, and HP-MSIB Map Screen Menu are **configuration** menus; they are used to initialize the software for operation. In these menus you can enter information about disk drives, environment conditions, test equipment, the system under test, and so on.

The Test Menu allows the selection and execution of specific tests, or sets of tests, that are present in the current Operation Verification package.

---

**Note** When a cursor is present, you may use either the cursor arrow-keys or the knob to position the cursor at the column item you wish to edit. In most cases, there are more selections available than are displayed on-screen. Be sure to move the cursor to the right and down as far as you can. `NEXT PAGE` and `PREVIOUS PAGE` keys are provided to speed your vertical searches.

---

### Common Edit and Command Screen Menu Keys

Not all of the menus have edit screens, but all have command screens. This section describes the edit and command screen menu keys that are common to most menus. Menu keys that are unique to a single menu are described in the section for that menu.

#### Edit Screen Menu keys

The following menu keys are present for edit screens:

`SELECT` or `SELECT/TOGGLE` either one of these keys can appear in the edit screen. `SELECT` activates the column item where the cursor is located, while `SELECT/TOGGLE` activates predefined choices.

`DONE` exits the edit screen, then displays the menu's command screen.

#### Command Screen Menu Keys

The following menu keys are present for most command screens:

`main menu` returns you to the Main Menu. Refer to "Main Menu" for details.

`EDIT` appears if there is an edit screen in the menu you are working in. Pressing this key returns you to the menu's edit screen.

`STORE` appears if you have data that needs to be stored on the `OPERATING` Volume. The HP-MSIB Address Menu does not require this menu key, therefore it does not appear in the command screen for that menu.

`CREATE` appears if you tried to store data without an existing file available. `CREATE` activates the store function and creates a file on the `OPERATING` Volume.

**REPEAT** appears if the correct Operating Disk containing calibration or menu data is not in the disk drive. This key allows you to insert the correct Operating Disk into the disk drive and try again.

**ABORT** displays the Main Menu screen. **ABORT** is available in various special task screens. In general, pressing this key a time or two will display the Main Menu, which has a **quit** menu key. If the Main Menu has not appeared for the first time, pressing **ABORT** produces a message asking you to press **(RUN)**, which returns you to where you were when you pressed **ABORT**.

**HELP** accesses menu and menu key descriptions. Listed below are menu key selections and functions available via this menu key.

**NEXT PAGE** takes you to the top of the next available menu page.

**PREVIOUS PAGE** returns you to the top of the preceding menu page.

**PRINT HELP** generates a printout of help-screen information.

**DONE** returns you to the command or edit screen of the menu you were previously in.

**quit** displays the quit screen. This menu key is available only from menu command screens. After you press **quit**, you are asked if you really want to return to the BASIC operating system. The following two menu key selections are available via the **quit** menu key.

**YES** stops the program, retains any data files you stored before pressing **quit**, and returns you to the BASIC operating system. (You can press **(RUN)** to restart the program and return to the Main Menu. The program retains all previously entered and stored data.)

**NO** displays the edit screen of the previous menu, or the command screen if there is no edit screen.



## Main Menu

From the Main Menu screen you can access all other menus. There is no edit screen for this menu. Figure 4-1 illustrates the Main Menu key organization.

In addition to the five menu selection keys and two common keys `HELP` and `quit`, the following three keys are present in the Main Menu.

`QUICK TEST` runs Limited Cal, a predefined sequence of Operation Verification tests.

`REPRINT` initiates the reprinting of test data from disk to a selected printer. Test results are stored on disk if the Parameter Menu was set up appropriately. Note that the program erases test results stored on disk the first time it enters the Test Menu. Therefore, if a printed copy of the results of the previously run test is desired, it must be printed before pressing `test menu`.

If test results exceed available disk space, only the results that were stored on disk may be reprinted. If you want to have the results of a sequence printed, select `printer` for the Parameter Menu selection `Results sent to:` and the test results will be printed during the test.

If no printer is present on the HP-IB, the program omits this menu key. Refer to "Parameter Menu" for more information.

`RESTART` is used to reconfigure the program and retest a system, or to test a different system. Pressing this key affects the Status column of the Test Menu command screen, and the RF section selected in the HP-MSIB Address Menu command screen. Pressing `RESTART` also forces the software to reload the Equipment Menu and Parameter Menu files from the Operating Disk.

## Mass Storage Menu

The Mass Storage Menu has both an edit screen and a command screen. The edit screen displays a list of mass storage information and allows you to assign the areas where the program stores system and operation data. This is done by assigning Volume Labels to a mass storage unit specifier (msus). An msus is a string expression that points to a mass storage location. The command screen allows you to save the mass storage information after it is entered. Refer to “Mass Storage Menu Volume Labels” and “Editing Mass Storage Menu Information” below. Figure 4-2 illustrates the Mass Storage Menu key organization.

### Mass Storage Menu Volume Labels

The BASIC operating system can use a number of mass storage devices. These include internal disk drives, external disk drives, and SRM systems. A mass storage Volume is composed of one or more files. Files are data items or subprograms. A Volume might consist entirely of files on a floppy disk, or some number of files on a small portion of a hard disk.

The Mass Storage Menu lists Volume Labels, which show the location of certain types of program information. Volume Labels each have a default msus. From the Mass Storage Menu, you can reassign the current msus or directory path designation to another designation. You cannot edit Volume Labels, but you may edit their msus designations and directory path data fields.

The Volume Labels are explained below.

- **SYSTEM** contains the Executive Disk program code. There must be an msus assigned to this Volume Label.
- **DATA** is where the test results (including header and summary information) are temporarily stored.
- **ERROR LOG** is where unanticipated errors are recorded for possible future use.
- **OPERATING** is where all the program data, including menu configuration files and calibration data, is stored.
- **TEST DISK** contains the system performance tests programs. (There may be more than one TEST DISK Volume.)

### Editing Mass Storage Menu Information

Use the following procedure to edit Mass Storage Menu information:

1. Use either the keyboard arrow keys or the knob to position the cursor next to the msus or directory path you wish to edit. The annotations `<=more` and `more=>` indicate that you must scroll the screen left or right to view off-screen column items.
2. Press `SELECT`. Key in the new location (msus or Directory Path), then press `ENTER`.

---

**Note** Unless you are using an SRM system or HP BASIC 5.0 (or later version), which uses directory path hierarchy, leave the Directory Path field blank.

---

3. Repeat Steps 1 and 2 until you have finished editing, then press `DONE`.
4. Press `STORE` to save the edited data. Saving Mass Storage Menu data for the first time causes an error message prompting you to create a file. Do this simply by pressing `CREATE`.
5. Press `main menu` to return to the Main Menu screen, or press `EDIT` to continue editing Mass Storage Menu information.

## Parameter Menu

The Parameter Menu has both an edit and a command screen. The edit screen displays a list of parameter items and allows you to determine some of the operating conditions of the software program.

Use **SELECT/TOGGLE** to select the parameter item and enter data, or to toggle to a predefined state. After you have finished editing the Parameter Menu items, press **DONE** to display the command screen. Then press **STORE** to save any edited Parameter Menu data, **EDIT** to return to the edit screen, or **main menu** to return to the Main Menu screen. Figure 4-2 illustrates the Parameter Menu key organization.

The parameter items and their appropriate selections are defined below.

- Results sent to: Your choices are Screen, Printer, or None. Press **SELECT/TOGGLE**. When Screen is displayed, test results appear on the display screen. When Printer is displayed, test results are displayed on-screen and printed out. When None is displayed, simple pass/fail indications are listed next to the test name in the Test Menu.
- Output format: Your choices are Graph, Table, or Short Table. Press **SELECT/TOGGLE**. When Graph is displayed, test results are generated in a graph format if appropriate for the particular test results (a graphics printer is required if Printer and Graph are both selected). When Table is displayed, test results are output in a table format. When Short Table is displayed, test results are also output in a table format; however, less critical data points may be eliminated to limit the table length.
- Save for reprinting: Your choices are Yes or No. Press **SELECT/TOGGLE**. If Yes is displayed, test results are saved on disk for later reprinting using the **REPRINT** menu key in the Main Menu. If No is displayed, test results are not saved.
- Printer lines: Lines allowed are from 50 to 70. Press **SELECT/TOGGLE**. Type a number from 50 to 70 to set the number of lines per printed page, then press **(ENTER)**.
- Begin each test on a new page: Your choices are Yes or No. Press **SELECT/TOGGLE**. If Yes is displayed, the printer form-feeds after each test. If No is displayed, there is no form-feed between tests.
- Line frequency: Valid frequency selections are 50, 60, and 400 Hz. Press **SELECT/TOGGLE** until the power line frequency for your system is displayed. The line frequency value affects some test results.

Ambient temperature: Valid Celsius temperature entries are 0 to 55. Press **SELECT/TOGGLE**. Type a number from 0 to 55, then press **ENTER**. This provides the program with the test environment temperature in Celsius, allowing the test limits to reflect temperature-drift guard-bands, if necessary.

Ambient humidity: Valid entries for ambient humidity are 0% to 105%. Press **SELECT/TOGGLE**. Type a number from 0 to 105, then press **ENTER**.

Beeper to be activated: Your choices are Yes or No. Press **SELECT/TOGGLE**. When Yes is displayed, the warning and time-lapse reminder beeps are activated. When No is displayed, the program's beep feature is disabled.

Verify equipment on HP-IB: Your choices are Yes or No. Press **SELECT/TOGGLE** to indicate your choice. Yes causes the program to verify the presence of each instrument on HP-IB at the address shown in the Equipment Menu. Select No to bypass this feature.

Customer: Press **SELECT/TOGGLE**, type the customer's name or ID number, then press **ENTER**. This allows the name or ID number to be included on the output report. There is a 30 character limit.

Repair number: Press **SELECT/TOGGLE**, type the repair number, then press **ENTER**. This allows the repair number to be included on the output report. There is a 30 character limit.

Test person's ID: Press **SELECT/TOGGLE**, type your name or ID number, then press **ENTER**. This allows your name or ID number to be included on the output report. There is a 30 character limit.

Number lines added: Lets you include a printed message with the test results. Depending on the program, you can enter up to 30 lines, with no more than 30 characters per line. (Select **User Line**: to enter the message you wish to have printed in this screen.)

User Lines:

1. Position the cursor to the left-hand side of a User Line in the menu. Press **SELECT/TOGGLE**.
2. The prompt, Enter additional information, appears. Type in your message (up to 30 characters per line), then press **ENTER**.
3. After you have entered your message, reposition the cursor at **Number lines added**:. Enter the number of user lines your message occupies, then press **ENTER**.

## Equipment Menu

The Equipment Menu has both an edit screen and a command screen. The edit screen displays a list of all the equipment required to test your device under test (DUT) completely, and allows you to enter device model numbers, addresses, serial numbers, and information about the availability of passive devices. “Equipment Menu Edit Screen,” below, gives more information about entering test equipment data. After you have finished editing the Equipment Menu, press **DONE** to enter the command screen. Press **STORE** in the command screen to save the edited data.

The command screen also provides a menu key, **edit cal data**, that provides access to a calibration-data screen. This calibration-data screen lists those passive devices that are labeled **Available** and require calibration data. Refer to “Equipment Menu Command Screen” and “Editing Calibration Data” below for more information. Figure 4-3 illustrates the Equipment Menu key organization.

---

**Note** Table 4-1 lists all required test equipment. Using the preferred test equipment (identified by \*) ensures the most complete testing capability. Individual test descriptions provide an equipment list and the test setup for that particular test.

---

### Equipment Menu Edit Screen

From the Equipment Menu edit screen you can enter data about your test equipment. Next to each **DEVICE TYPE** in the equipment list there are columns labeled **DEVICE MODEL** for the model number, **ADDRESS** for the HP-IB address, and **SERIAL** or identification number (for example, calibration lab number). You may use either the cursor arrow keys or the knob to position the cursor at the column item you wish to edit. Use the following information to edit information in the different columns. You cannot edit the **DEVICE TYPE** column.

**DEVICE MODEL** Locate the cursor beside the model number you wish to edit. Press **SELECT**, type the model number, then press **ENTER**.

**ADDRESS** Locate the cursor beside the address you want to edit. Press **SELECT**, edit the address, then press **ENTER**.

If a device does not have an address listed in the address column, **Missing ETE** (missing test equipment) is included in the **Status** column next to the tests that required the device. Tests tagged with **Missing ETE** are not performed.

Active devices should be given a three-digit HP-IB address. The three-digit address includes the HP-IB select code and the actual HP-IB address. For example, an HP 70000 Series modular spectrum analyzer HP-IB select code of 8 and an HP-IB address of 18 yields an address of 818. Valid addresses for active devices are listed below:

- 700 to 730 and 800 to 830 for an HP 70000 Series modular spectrum analyzer master module.
- 700 to 730 for any other device type.

Passive devices (nonprogrammable devices such as sensors, directional bridges, and detectors) should be addressed as either **Available** or **Not Available**. When certain passive devices are addressed as **Available**, you will also be required to enter a serial number and calibration data for the device. To enter calibration data, press **edit cal data** to access the Cal Data edit screen. (The calibration data for a passive

device is stored on Operating Disk.) If a passive device has Not Available in the address column, any tests that require that passive device will not be performed. Missing ETE will be printed next to the test names on the test menu for any procedures that require a device listed as Not Available.

**SERIAL OR ID NO.** Locate the cursor beside the serial or ID number that you want to edit. Press **SELECT**, enter the new serial or ID number (10 digits or less), then press **ENTER**. Some passive devices that have Available displayed in the address column must also have a serial- or ID-number entry.

### Equipment Menu Command Screen

In addition to the common menu keys **EDIT**, **STORE**, **main menu**, **HELP**, and **quit**, this command screen displays the following additional menu keys:

**edit cal data** displays the Select Passive Device screen. From this screen, move the cursor to the passive device that needs its calibration data edited. Press **SELECT**, then enter the required data. Refer to “Editing Calibration Data” below for more information.

**NO ADDRESS** appears only if the program cannot find an instrument at a specified HP-IB address. Either press **NO ADDRESS** to delete all faulty addresses from the edit menu, or use the steps below to find out which instruments are not responding and correct their addresses.

1. Press **EDIT** to access the Equipment Menu edit screen.
2. Scroll the **ADDRESS** column for flashing addresses, then be sure that the instrument is on.
3. **SELECT** the flashing address, correct it, and then press **DONE**. If you do not want to correct all of the incorrect addresses, press **DONE** to return to the Equipment Menu command screen, then press **NO ADDRESS** to delete the remaining faulty addresses.

---

**Note** If the **Verify equipment on HP-IB:** feature is selected in the Parameter Menu, when you exit the Equipment Menu or enter the Test Menu the program will search the addresses in the Equipment Menu for instruments assigned to HP-IB.

---

### Editing Calibration Data

The program requires calibration data for some of the passive devices listed in the Equipment Menu edit screen. The Select Passive Device screen of the Equipment Menu displays all passive devices that need calibration data entered. To reach the Select Passive Device screen, press **edit cal data** in the Equipment Menu.

---

**Note** If you are in the Select Passive Device screen and select a passive device that needs a serial number entered, you will be prompted to return to the Equipment Menu and enter the number. If you have formerly entered calibration data for a passive device of a given serial number and you would rather not reenter the data, replace your current Operating Disk with one containing data for passive devices from previous testing. Press **REPEAT** to access the calibration data from that disk. If you only need to enter the passive

device's calibration data, press **CREATE**, then use the procedure given later in this section to enter the appropriate information.

---

If you edit the factory default frequency or calibration factor values, you *must* enter valid calibration factors for each frequency edited. For power sensors, you must enter a frequency and calibration factor for 300 MHz even if the device has no factor listed at 300 MHz. Not all frequencies are listed on the screen at once. Be sure to enter calibration data for frequencies listed on all pages of the display.

Enter the values from the valid calibration factors given below. Other frequencies outside the normal range of the device may also be required. Prior to using your device, you may need to calibrate it at these frequencies to ensure accurate measurement results.

<b>Passive Device</b>	<b>Valid Calibration Factors</b>
Mixers	16 to 24 dB
Directional Couplers	8 to 11 dB
Sensors	0.3 to 1.6 (stored as a percentage by the program)

Use the procedure below to edit calibration data:

1. While in the Equipment Menu command screen, press **edit cal data** to access the Select Passive Device screen.
2. Locate the cursor beside the device and press **SELECT**.
  - a. To change a frequency or calibration factor, move the cursor next to the one you want to change, enter the new value, then press **(ENTER)**. (It is not necessary to enter new frequency values in numeric order; the program sorts them before storing them on the Operating Disk.)
  - b. To delete a frequency or calibration factor, select the frequency or cal factor you want to delete, then clear the line by typing spaces and pressing **(ENTER)**.
3. After you have deleted or entered the necessary data, press **DONE** to return to the Select Passive Device screen. If you do not want to edit any more data, press **DONE** to return to the Equipment Menu command screen. Press **main menu** to continue with the program.

## **HP-MSIB Address Menu**

The HP-MSIB Address Menu lists the model numbers and HP-MSIB addresses of the modules in the HP 70000 Series modular spectrum analyzer system that you may wish to test. The HP-MSIB address of the master and the system are the same. In other words, the address of the master module determines the address of the system.

Figure 4-3 illustrates the HP-MSIB Address Map Menu key organization. There is no edit screen for this menu. The command screen may have the following additional menu key.

**SELECT MODULE** appears when there is more than one system input (RF section module) available to test. Locate the cursor next to the RF section module that you wish to test. Press **SELECT MODULE**.

## Test Menu

The Test Menu does not have an edit screen. The command screen allows you to select and run system performance tests.

If **Missing ETE** is listed next to a test, additional test equipment is required to perform that test. To review which additional test equipment is required, locate the cursor beside the test name, then press **SINGLE TEST**. The Missing ETE screen displays the missing test equipment for that test.

Missing calibration data for a passive device causes display of an error screen informing you that no file exists for the device serial number. If the correct Operating Disk is in the default drive, press **CREATE** to build the data file. The Test Menu reappears after calibration data has been entered for all passive devices that require it.

---

**CAUTION** Pressing either **RESTART** or **equipment menu** any time after testing begins purges Test Menu Status column information. Selecting a new RF section module to test in the HP-MSIB Map Screen Menu also deletes the Status column data. The assumption is that test status will most likely be modified if you are moving between RF section modules, or “Test Equipment” model numbers.

---

Figure 4-4 illustrates the Test Menu key organization. The Test Menu command screen is different from the command screen formats previously described. The menu keys available in this menu are described below.

<b>LIMITED CAL</b>	begins a factory-defined sequence of the Limited Cal mode tests. For Operation Verification <b>LIMITED CAL</b> is the same as <b>ALL TESTS</b> . During the test sequence, the keys listed below are also available.
<b>END SEQUENCE</b>	interrupts the test sequence at the end of the test in progress. The Test Menu is displayed with an additional menu key labeled <b>RESUME TESTING</b> . Press this key to resume the test sequence where the program left off.
<b>ABORT</b>	ends the testing process and displays the Test Menu. From there you may choose some other action.



**ALL TESTS** begins a factory-defined sequence that includes all of the tests displayed in the Test Menu. For Operation Verification, **ALL TESTS** is the same as **LIMITED CAL**. During the test sequence, the keys listed below are also available.

**END SEQUENCE** interrupts the test sequence at the end of the test in progress. The Test Menu is displayed with an additional menu key labeled **RESUME TESTING**. Press this key to resume the test sequence where the program left off.

**ABORT** ends the testing process and displays the Test Menu. From there you may choose some other action.

**REPEAT TEST** runs the selected test and repeats it until you press **END SEQUENCE**. During the test sequence, the keys listed below are also available.

**END SEQUENCE** interrupts the test sequence at the end of the test in progress. The Test Menu is displayed with an additional menu key labeled **RESUME TESTING**. Press this key to resume the test sequence where the program left off.

**ABORT** ends the testing process and displays the Test Menu. From there you may choose some other action.

**RESUME TESTING** allows you to continue the test sequence after you have pressed either **LIMITED CAL** or **ALL TESTS**, and then pressed **END SEQUENCE** or **ABORT**.

**SINGLE TEST** lets you select an individual test to run. If Missing ETE is listed in the Status column, you can review which test equipment is missing. Locate the cursor beside that test name, then press **SINGLE TEST**. The Missing ETE screen is displayed. If you choose to return to the Test Equipment Menu via the Test Menu to install the missing test equipment, you lose the status of any tests that have run. To run a single test that has the necessary test equipment, locate the cursor beside the test name and press **SINGLE TEST**.

**multiple tests** allows you to organize a group of tests sequentially. Locate the cursor beside the test you want to run. Press **SELECT** to assign the first number of the series to that test. Continue to locate the cursor and press **SELECT** until you have organized the tests you want to run in the order that you want to run them. Press **END LIST** when you are ready to begin testing. During testing, the following menu keys are also available.

**END SEQUENCE** interrupts the test sequence at the end of the test in progress, then displays the Test Menu.

**ABORT** ends the testing process and displays the Test Menu. From there you may choose some other action.

`repeat mult.`

allows you to select a test sequence (you determine the quantity and order). The tests loop through this sequence until you decide to stop them. Locate the cursor beside the test you want to run, press `SELECT`, move the cursor to the next test, press `SELECT`, and so on. Continue selecting tests until you are ready to begin testing. It is acceptable to select the same test for repeated testing. Press `END LIST` to start the test sequence. During testing, the following menu keys are also available.

`END SEQUENCE` interrupts the test sequence at the end of the test in progress, then displays the Test Menu.

`ABORT` ends the testing process and displays the Test Menu. From there you may choose some other action.

`more keys`

toggles between `SUMMARY`, `select output`, and `PURGE DISK` and the previously explained Test Menu command screen menu keys.

`SUMMARY` gives you a printout of the current test(s) run.

`select output` chooses an output device. You can print test results by pressing `PRINTER`, or you can print the current display by pressing `SCREEN`, or you can select no output by pressing `NONE`. Press `RETURN` to return to the previous set of menu keys in the Test Menu command screen.

`PURGE DISK` allows you to delete any stored data for the spectrum analyzer system under test. Press `YES` to delete the stored data. Press `NO` to return to the Test Menu command screen.

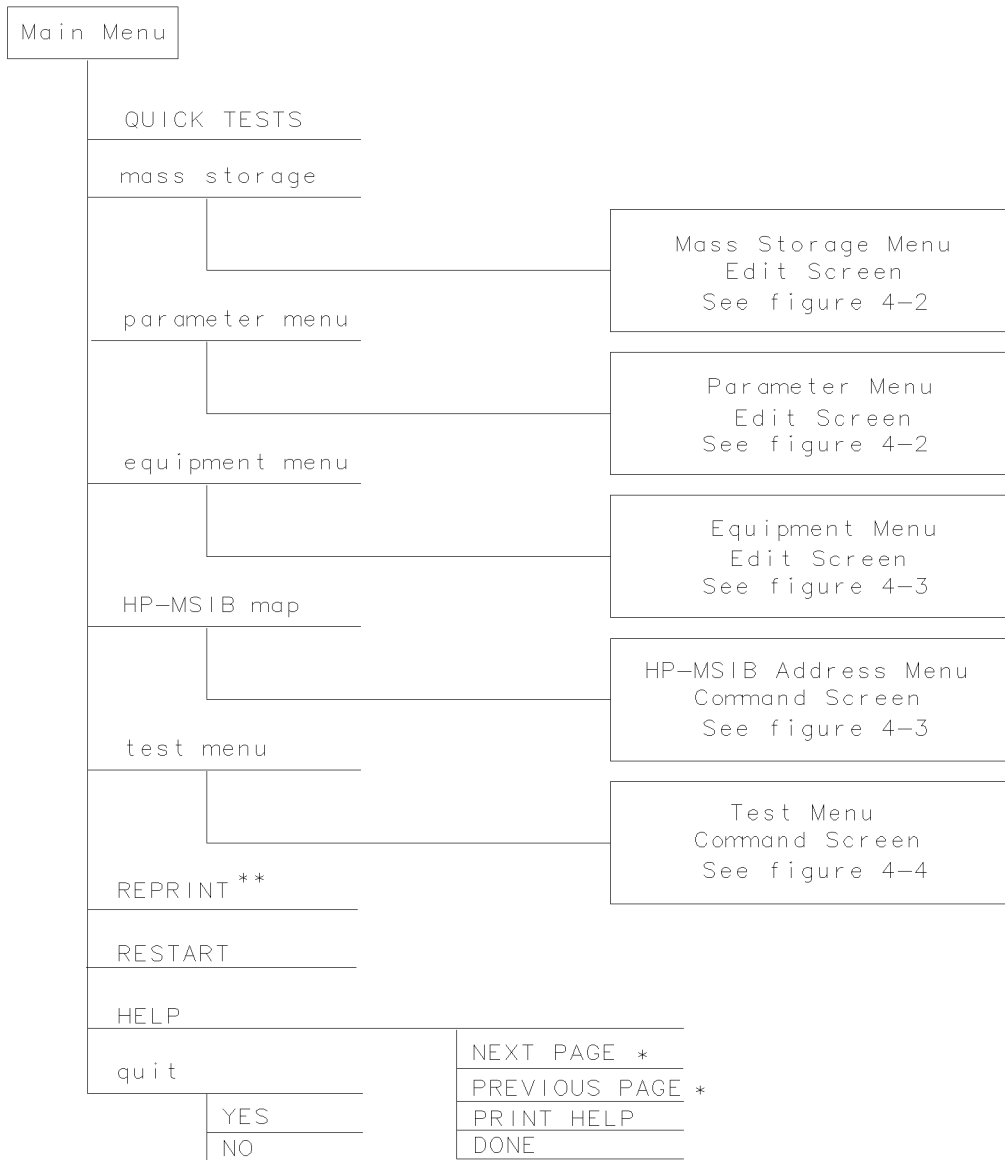

\* Present when more pages of information are available  
 \*\* Present if a printer address is available in the Equipment Menu

**Figure 4-1. Main Menu keys**

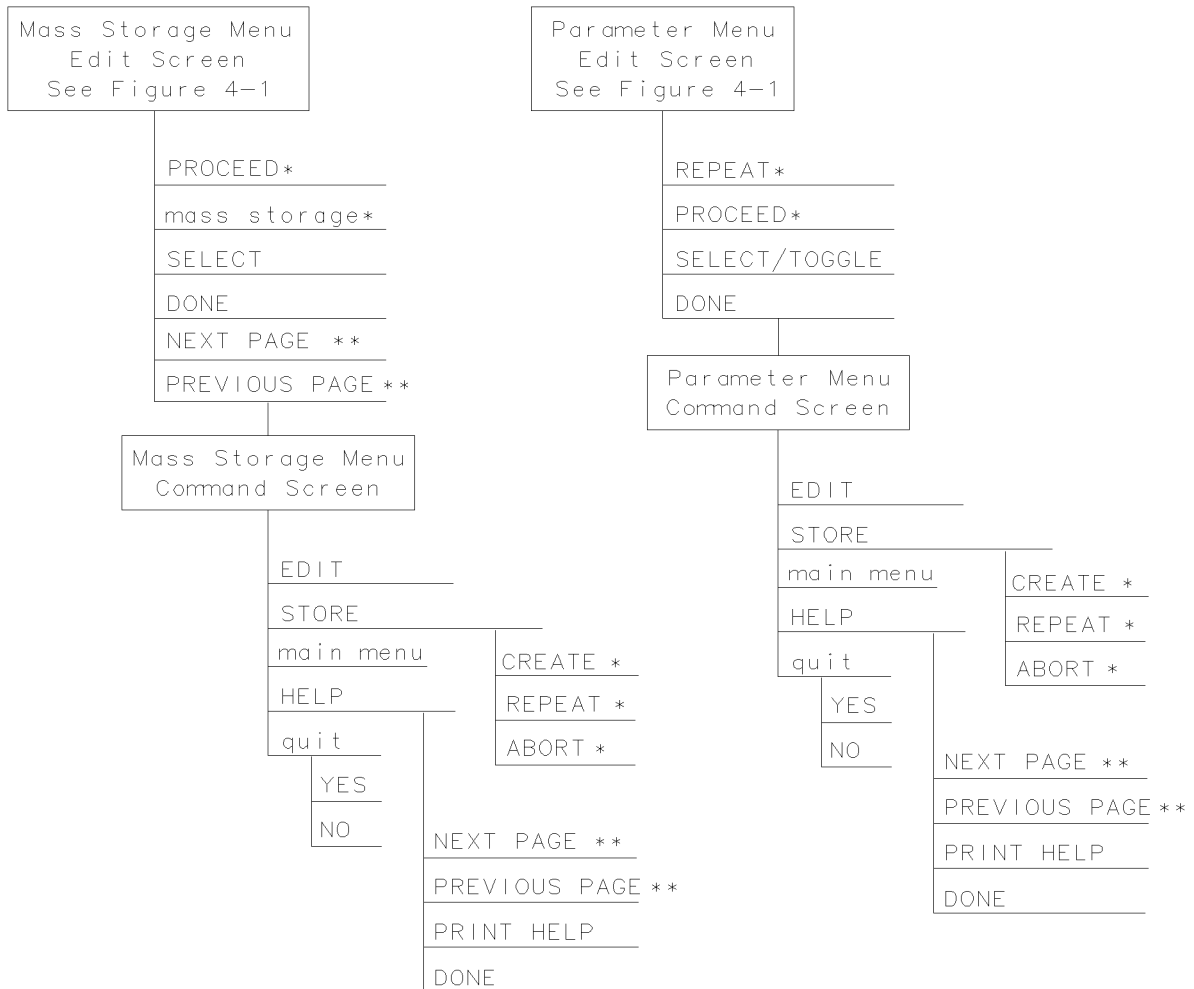

\* Present when the program does not find a file on the Operating Disc.  
 \*\* Present when more pages of information are available

**Figure 4-2. Mass Storage Menu and Parameter Menu Keys**

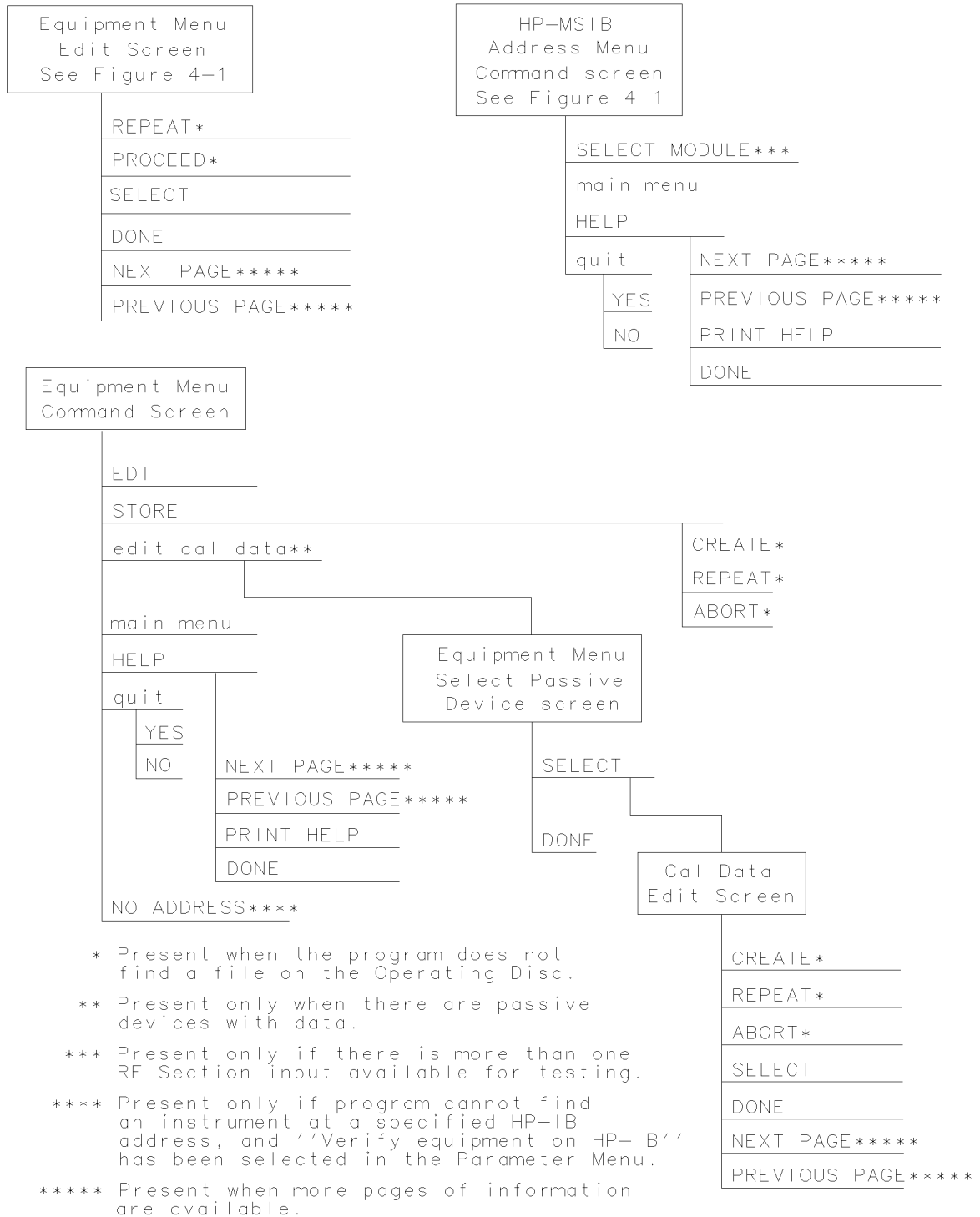

**Figure 4-3. Equipment Menu and HP-MSIB Map Screen Menu Keys**



---

## Test Descriptions

This section contains the following information:

**Operation Verification Tests** list and describe the individual tests that appear in the Test Selection Menu. Table 4-3 lists the Operation Verification Tests and indicates the page where the test description can be found.

**Test Limit Changes** indicate changes in the test limits that may not exist in the software version being used.

The following list explains the information found in each test description:

- **Tested Specification** is the name of the specification as found in the Chapter 3.
- **Equipment** lists all external test equipment required by the particular test. Accessories are not listed. The test will not run if required test equipment is missing. Test descriptions also list external test equipment by generic type. Refer to Table 4-1 for a listing of acceptable model numbers for each type. The table also indicates a recommended model which tests the specification more completely, more accurately, or both.
- **Equipment Setup** describes equipment interconnections. A User Interface Setup Screen will also provide instruction. This screen does not appear if the current setup is complete and correct. The screen presents **ABORT** and **PROCEED** softkeys. **ABORT** displays the Test Menu. Pressing **PROCEED** three times when the setup is wrong will display the Test Menu.
- **Description** provides a brief description of the test.

## Test Description List

Some test descriptions apply to more than one test, since many of the tests use the same algorithm but have different data values. For example, the Log Fidelity test description is valid for the HP 70902A IF section and HP 70903A IF section Log Fidelity tests. Table 4-3 lists operation verification tests described in this section and included on Test Disks 1 and 2.

**Table 4-3. Operation Verification Tests**

Test Names
* Calibrator Frequency Accuracy (for HP 70900A/B local oscillator source)
* Calibrator Amplitude Accuracy (for HP 70900A/B local oscillator source)
* Frequency Response (for HP 70904A RF section)
* Frequency Response (for HP 70905A RF section, HP 70906A RF section)
* Frequency Response (for HP 70600A preselector/HP 70601A preselector and HP 70905B RF section/HP 70906B RF section)
* Frequency Response (for HP 70908A RF section)
* Frequency Response (for HP 70908A RF section and HP 70620B preamplifier)
* Frequency Response (for HP 70909A or HP 70910A RF section)
* Frequency Response (for HP 70600A preselector/HP 70601A preselector, HP 70905A/B RF section or HP 70906A/B RF section, and HP 70620B preamplifier)
* Frequency Response (for HP 70904A RF section and HP 70621A preamplifier)
* GSM System Calibration (for HP 71150C GSM transmitter tester or HP 71250C GSM transmitter tester)
* Frequency Span Accuracy
* Displayed Average Noise (using HP 70902A IF section or HP 70903A IF section)
* GSM System Displayed Average Noise Level (using HP 70902A IF section)
* Log Fidelity (for HP 70902A IF section or HP 70903A IF section)
* Resolution Bandwidth Tests (for HP 70902A IF section or HP 70903A IF section)
* Calibrator Amplitude Accuracy (using HP 70907A external millimeter interface module)
* Calibrator Amplitude Accuracy (using HP 70907B external millimeter interface module)
* LO Output Amplitude (from HP 70907A/B external millimeter interface module)
* Log Fidelity (using HP 70907A/B external millimeter interface module)
* Resolution Bandwidth (using HP 70907A external millimeter interface module)
* Resolution Bandwidth (using HP 70907B external millimeter interface module)



## Calibrator Frequency Accuracy (for HP 70900A/B Local Oscillator Source)

### Tested Specification

FREQUENCY: Frequency Reference Error

### Equipment

Frequency Counter

### Equipment Setup

The CALIBRATOR output of the HP 70900A/B local oscillator source is connected to the input of the frequency counter.

### Description

With the spectrum analyzer (DUT) set to its internal frequency reference, the frequency counter is used to measure the 300 MHz CALIBRATOR frequency.

### In Case of Failure

If this test fails, the following modules may need repair or adjustment:

- Local oscillator

## Calibrator Amplitude Accuracy (for HP 70900A/B Local Oscillator Source)

### Tested Specification

300 MHz Calibrator Amplitude

### Equipment

Power Meter  
RF Power Sensor or MW Power Sensor

### Equipment Setup

Connect the power sensor to the spectrum analyzer (DUT) CALIBRATOR output connector.

### Description

After zeroing and calibrating the power meter, the power sensor is connected to the DUT CALIBRATOR output. The calibrator amplitude is measured and corrected using the calibration factor of the power sensor.

### In Case of Failure

If this test fails, the following modules may need repair or adjustment:

- Local oscillator

---

## Frequency Response (for HP 70904A RF Section)

### Tested Specification

AMPLITUDE ACCURACY: Frequency Response

### Equipment

Microwave Source  
Power Meter  
RF Power Sensor or MW Power Sensor  
Power Splitter

### Equipment Setup

---

**Note** A low-loss cable such as HP part number 8120-3124 must be used to connect the microwave source to the spectrum analyzer (DUT).

---

Connect the RF OUTPUT of the microwave source to the input port of the power splitter. Connect one output of the power splitter to the RF INPUT of the DUT. With the power splitter connected to the power meter, connect the other output of the power splitter to the power sensor.

### Description

The power meter is calibrated. The input attenuator of the DUT is set to 10 dB. The microwave source output level is adjusted for a power-meter reading of  $-10$  dBm at 300 MHz. The DUT marker amplitude is read to establish a reference. A minimum of 30 measurements are made in each frequency band above 50 MHz.

The frequency response data is available in graph mode.

### In Case of Failure

If this test fails, the following modules may need repair or adjustment:

- RF section

## Frequency Response

---

### Frequency Response (for HP 70905A RF Section, HP 70906A RF Section)

#### Tested Specification

AMPLITUDE ACCURACY: Frequency Response

#### Equipment

Microwave Source  
Power Meter  
MW Power Sensor  
Power Splitter

#### Equipment Setup

---

**Note** A low-loss cable such as HP part number 8120-3124 must be used to connect the microwave source to the spectrum analyzer (DUT).

---

Connect the RF OUTPUT of the microwave source to the input port of the power splitter. Connect one output of the power splitter to the RF INPUT of the DUT. With the power sensor connected to the power meter, connect the other output of the power splitter to the power sensor.

#### Description

The power meter is calibrated. The input attenuator of the DUT is set to 10 dB. The microwave source output level is adjusted for a power-meter reading of  $-10$  dBm at 300 MHz. The DUT marker amplitude is read to establish a reference. A minimum of 30 measurements are made in each frequency band above 50 MHz. The frequency response data is available in graph mode.

#### In Case of Failure

If this test fails, the following modules may need repair or adjustment:

- RF section

---

## Frequency Response (for HP 70600A Preselector/HP 70601A Preselector, HP 70905B RF Section/HP 70906B RF Section)

### Tested Specification

AMPLITUDE ACCURACY: Frequency Response  
(absolute and relative in all bypassed and preselected bands)

### Equipment

Microwave Source  
Power Meter  
MW Power Sensor  
Power Splitter

### Equipment Setup

---

**Note** A low-loss cable such as HP part number 8120-3124 must be used to connect the microwave source to the spectrum analyzer (DUT).

---

Setup A: Connect the HP 70900A/B local oscillator source CALIBRATOR output to the HP 70600A preselector or HP 70601A preselector RF INPUT to calibrate the preselected front end.

Setup B: Connect the source output to the input connector of the power splitter. Connect one output of the power splitter to the RF INPUT of the HP 70600A preselector or HP 70601A preselector. Connect the other output from the power splitter to the power sensor, which is connected to the power meter.

### Description

The algorithm used in this test is the same as for the HP 70905A RF section and HP 70906A RF section verification tests. The difference is that this test is run twice, once in the preselected mode and once in the bypass mode. In the preselected mode, the preselector is peaked before making each measurement. For both modes, the measurements are made in 3 kHz resolution bandwidth when the HP 70902A IF section is in the system. The purpose of using this bandwidth is to eliminate any local oscillator drift during preselector peaking. If only the wide-band HP 70903A IF section is in the system, the 300 kHz resolution bandwidth is used.

Once the modular spectrum analyzer and power meter have been calibrated, setup B is verified and the HP 70600A preselector or HP 70601A preselector attenuator is set to 10 dB. Then the preselector mode is enabled. Next the source power level is adjusted for a power-meter reading of  $-10$  dBm at 300 MHz. The amplitude of the preselector is then measured to set a reference amplitude.

Starting with the highest band, each band is path-locked while amplitude measurements are taken at various preselector frequencies with the power meter. If the preselected mode is enabled, the preselector is peaked in zero span prior to each measurement, then returned to the test span. The difference between the power-meter reading and the measured amplitude of the preselector is the amplitude measurement error for the frequency measured.

Next, the preselector bypass mode is enabled, and the measurements are repeated once, starting at the  $-10$  dBm, 300 MHz reference amplitude measurement.

## **Frequency Response**

### **In Case of Failure**

If this test fails, the following modules may need repair or adjustment:

- Preselector
- RF section

---

## Frequency Response (for HP 70908A RF Section)

### Tested Specification

AMPLITUDE: Frequency Response

### Equipment

Microwave Source  
Power Meter  
MW Power Sensor  
Power Splitter

### Equipment Setup

---

**Note** A low-loss cable such as HP part number 8120-3124 must be used to connect the microwave source to the spectrum analyzer (DUT).

---

Connect the RF OUTPUT of the microwave source to the input port of the power splitter. Connect one output of the power splitter to the RF INPUT of the DUT. With the power sensor connected to the power meter, connect the other output of the power splitter to the power sensor.

### Description

The power meter is calibrated. The input attenuator of the DUT is set to 10 dB. The microwave source output level is adjusted for a power-meter reading of  $-10$  dBm at 300 MHz. The DUT marker amplitude is read to establish a reference. A minimum of 30 measurements are made in each frequency band above 50 MHz.

The frequency response data is available in graph mode.

### In Case of Failure

If this test fails, the following modules may need repair or adjustment:

- RF section

## Frequency Response

---

# Frequency Response (for HP 70908A RF Section and HP 70620B Preamplifier)

## Tested Specification

AMPLITUDE: Frequency Response

## Equipment

Microwave Source  
Power Meter  
MW Power Sensor  
Power Splitter

## Equipment Setup

---

**Note** A low-loss cable such as HP part number 8120-4921 must be used to connect the microwave source to the spectrum analyzer (DUT).

---

Connect the power sensor to the power meter. Connect the RF OUTPUT of the microwave source to the input port of the power splitter. Connect one output port of the power splitter to the RF INPUT of the DUT. Connect the other output port of the power splitter to the power sensor.

## Description

If necessary, the DUT and power meter are calibrated.

## Equipment Setup Check

The microwave source is set to 50 MHz at a power level of approximately  $-24$  dBm. If the DUT marker frequency is  $50 \text{ MHz} \pm 1 \text{ MHz}$ , then the microwave source amplitude is reduced by 5 dB. The equipment setup is considered correct if this 5 dB change results in a 3 to 7 dB change in the power-meter reading and the DUT marker amplitude.

## Frequency Response Test

The DUT is set as follows:

Coupling .....	dc
Resolution bandwidth	
IF HP 70902A IF section in system .....	100 Hz
IF only HP 70903A IF section in system .....	300 kHz
Video bandwidth .....	300 Hz
Detection mode .....	Sample
Ratio of resolution bandwidth/span .....	0.2
Preamplifier .....	off

Reference-level readings are taken at 300 MHz, for the power meter and DUT marker amplitude. The microwave source amplitude is adjusted to produce a power-meter reading of  $-30.0 \text{ dBm} \pm 0.1 \text{ dBm}$ .

The microwave source is tuned to the highest frequency that will be tested, and the frequency error of the DUT relative to the source frequency is determined.



## **Frequency Response**

A minimum of 30 measurements are then made in each frequency band above 50 MHz. After the measurements are taken with the preamplifier off, the preamplifier is turned on and the above procedure is repeated over the preamplifier frequency range.

The frequency response data is available in graph mode.

### **In Case of Failure**

If this test fails, the following modules may need repair or adjustment:

- RF section
- Preamplifier

## Frequency Response

### Frequency Response (for HP 70909A or HP 70910A RF Section )

#### Tested Specification

AMPLITUDE ACCURACY: Frequency Response

#### Equipment

Microwave source  
Power meter  
Microwave power sensor  
Directional coupler  
External mixer (HP 11970K harmonic mixer)

#### Equipment Setup

Connect the source to the input of the directional-coupler main guide. Connect the microwave power sensor to the power meter, then connect the sensor to the output of the directional-coupler main guide. Connect the HP 11970K harmonic mixer to the directional-coupler coupled port. Connect the HP 11970K harmonic mixer to the EMIM IF INPUT and LO OUTPUT through appropriate cables.

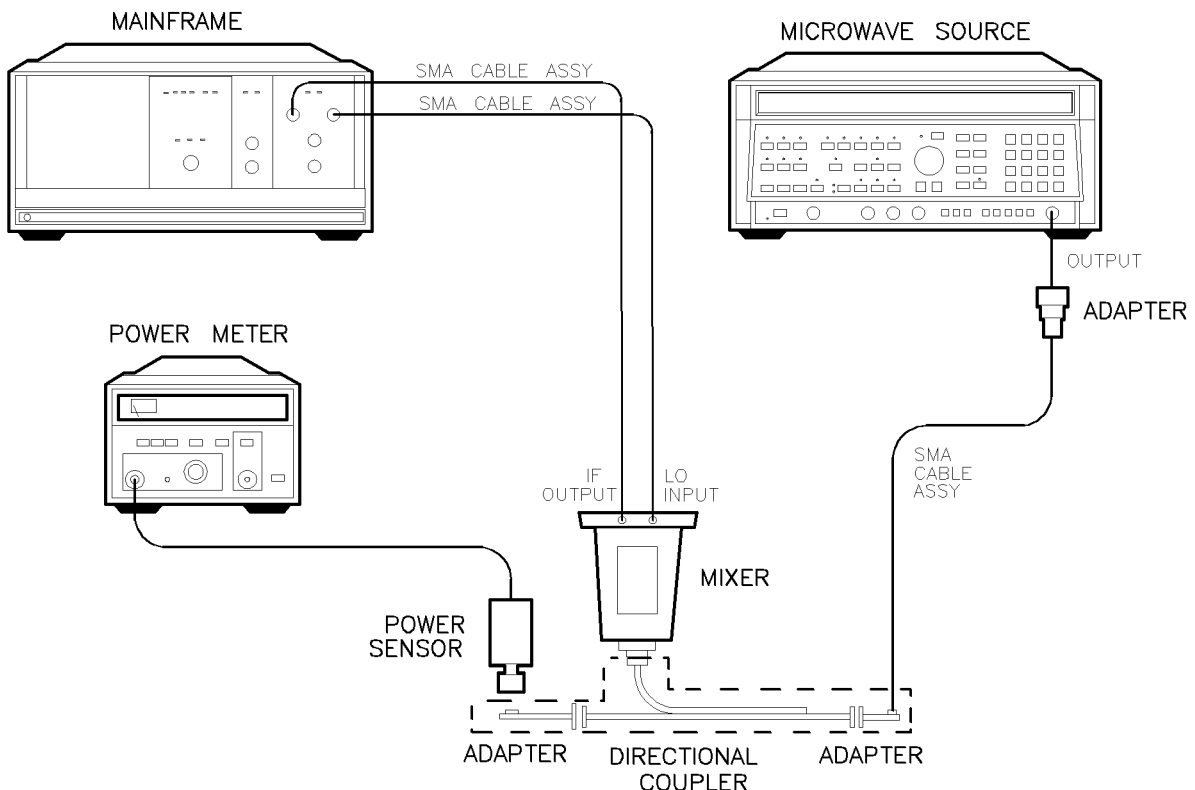

Figure 4-5. Frequency Response Test Setup

### Description

This test measures amplitude variation of the HP 71209A microwave spectrum analyzer from 18 to 26 GHz. The microwave power sensor is selected and the system is interrogated for an IF section. This step allows an optimum resolution bandwidth to be used to minimize measurement errors due to log fidelity. The signal is centered on the display using a span that is five times greater than the resolution bandwidth. Marker amplitude is measured at 100 MHz increments and compared with the power meter measurement, which has been corrected for directional-coupler coupling factor. The system conversion loss is set to 0 dB so that the conversion loss being measured is that of the external mixer when used with the HP 71209A microwave spectrum analyzer. The frequency response is then one-half of the difference between the maximum and minimum values measured.

### In Case of Failure

If this test fails, the following modules may need repair or adjustment:

- Local oscillator
- RF section

## Frequency Response

---

# Frequency Response (for HP 70600A Preselector/HP 70601A Preselector, HP 70905A/B RF Section or HP 70906A/B RF Section, and HP 70620B Preamplifier)

## Tested Specification

AMPLITUDE: Frequency Response

## Equipment

Microwave Source  
Power Meter  
MW Power Sensor  
Power Splitter

## Equipment Setup

---

**Note** A low-loss cable such as HP part number 8120-4921 must be used to connect the microwave source to the spectrum analyzer (DUT).

---

Connect the power sensor to the power meter. Connect the RF OUTPUT of the microwave source to the input port of the power splitter. Connect one output port of the power splitter to the RF INPUT of the DUT. Connect the other output port of the power splitter to the power sensor.

## Description

If necessary, the DUT and power meter are calibrated.

### Equipment Setup Check

The microwave source is set to 50 MHz at a power level of approximately  $-24$  dBm. If the DUT marker frequency is  $50 \text{ MHz} \pm 1 \text{ MHz}$ , then the microwave source amplitude is reduced by 5 dB. The equipment setup is considered correct if this 5 dB change results in a 3 to 7 dB change in the power-meter reading and the DUT marker amplitude.

### Frequency Response Test

The DUT is set as follows:

Coupling .....	dc
Resolution bandwidth	
IF HP 70902A IF section in system .....	100 Hz
IF only HP 70903A IF section in system .....	300 kHz
Video bandwidth .....	300 Hz
Detection mode .....	Sample
Ratio of resolution bandwidth/span .....	0.2
Preamplifier .....	off

Reference-level readings are taken at 300 MHz, for the power meter and DUT marker amplitude. The microwave source amplitude is adjusted to produce a power-meter reading of  $-30.0 \text{ dBm} \pm 0.1 \text{ dBm}$ .

The microwave source is tuned to the highest frequency that will be tested, and the frequency error of the DUT relative to the source frequency is determined.

## **Frequency Response**

A minimum of 30 measurements are then made in each frequency band above 50 MHz. For frequencies above 2.7 GHz, the preselector must be peaked before the measurement is taken. After the measurements are taken with the preamplifier off, the preamplifier is turned on and the above procedure is repeated over the preamplifier frequency range.

The frequency response data is available in graph mode.

### **In Case of Failure**

If this test fails, the following modules may need repair or adjustment:

- RF section
- Preamplifier
- Preselector

## Frequency Response

---

# Frequency Response (for HP 70904A RF Section and HP 70621A Preamplifier)

## Tested Specification

AMPLITUDE: Frequency Response

## Equipment

Microwave Source  
Power Meter  
MW Power Sensor  
Power Splitter

## Equipment Setup

---

**Note** A low-loss cable such as HP part number 8120-4921 must be used to connect the microwave source to the spectrum analyzer (DUT).

---

Connect the power sensor to the power meter. Connect the RF OUTPUT of the microwave source to the input port of the power splitter. Connect one output port of the power splitter to the RF INPUT of the DUT. Connect the other output port of the power splitter to the power sensor.

## Description

If necessary, the DUT and power meter are calibrated.

## Equipment Setup Check

The microwave source is set to 50 MHz at a power level of approximately  $-24$  dBm. If the DUT marker frequency is  $50 \text{ MHz} \pm 1 \text{ MHz}$ , then the microwave source amplitude is reduced by 5 dB. The equipment setup is considered correct if this 5 dB change results in a 3 to 7 dB change in the power-meter reading and the DUT marker amplitude.

## Frequency Response Test

The DUT is set as follows:

Coupling .....	dc
Resolution bandwidth	
IF HP 70902A IF section in system .....	100 Hz
IF only HP 70903A IF section in system .....	300 kHz
Video bandwidth .....	300 Hz
Detection mode .....	Sample
Ratio of resolution bandwidth/span .....	0.2
Preamplifier .....	off

Reference-level readings are taken at 300 MHz, for the power meter and DUT marker amplitude. The microwave source amplitude is adjusted to produce a power-meter reading of  $-30.0 \text{ dBm} \pm 0.1 \text{ dBm}$ .

The microwave source is tuned to the highest frequency that will be tested, and the frequency error of the DUT relative to the source frequency is determined.

## **Frequency Response**

The frequency response is then measured at 57 points over the 50 MHz to 2.9 GHz range. After the measurements are taken with the preamplifier off, the preamplifier is turned on and the above procedure is repeated over the preamplifier frequency range.

The frequency response data is available in graph mode.

### **In Case of Failure**

If this test fails, the following modules may need repair or adjustment:

- RF section
- Preamplifier

# GSM System Calibration (for HP 71150C GSM Transmitter Tester or HP 71250C GSM Transmitter Tester)

## Tested Specification

Not Applicable

## Equipment

Microwave Source  
Power Meter  
RF Power Sensor or MW Power Sensor  
Power Splitter

## Equipment Setup

---

**Note** A low-loss cable such as HP Part Number 8120-3124 must be used to connect the microwave source to the GSM system input.

---

Connect the RF OUTPUT of the microwave source to the input port of the power splitter. Connect one output of the power splitter to the HP 70912B downconverter High-Power RF INPUT. If an HP 70621A preamplifier-H50 Preamplifier is present in the system, connect the power splitter to its RF INPUT instead of the HP 70912B downconverter. With the power sensor connected to the power meter, connect the other output of the power splitter to the power sensor.

## Description

The power meter is calibrated. The input attenuator of the GSM system is set to 10 dB. The microwave source output level is set to approximately  $-10$  dBm. The GSM system calibration factors are determined at approximately 50 MHz intervals over the frequency range of 10 MHz to 2.9 GHz (for HP 71150C GSM transmitter tester) or 12.75 GHz (for HP 71250C GSM transmitter tester). The calibration factor is the difference between the power meter reading and the GSM system marker amplitude.

The GSM calibration factor data is available in graph mode.

## In Case of Failure

If this test fails, the following modules may need repair or adjustment:

- RF section
- Downconverter
- Preamplifier (if present)



## Frequency Span Accuracy

### Tested Specification

FREQUENCY: Frequency Span: Accuracy

### Equipment

Synthesized Source

### Equipment Setup

Connect the RF OUTPUT of the synthesized source to the spectrum analyzer (DUT) RF INPUT.

### Description

The DUT center frequency is set to 1.5 GHz, and spans of 10 kHz, 100 kHz, 1 MHz, 10 MHz, 10.01 MHz, 101 MHz, and 1.01 GHz are tested. The synthesizer frequency is adjusted until a signal appears near the left edge of the display. The frequency of this point and several other points in the span are noted by using marker peak. The deviation between the marker frequency and the synthesizer frequency is the absolute error. The maximum frequency span error is calculated by taking the difference between the maximum and minimum absolute errors.

This test is performed with the DUT referenced to the internal frequency reference.

If the HP 70700A digitizer is in the system, the test is repeated with the external digitizer selected.

### In Case of Failure

If this test fails, the following modules may need repair or adjustment:

- Local oscillator
- Digitizer

## Displayed Average Noise

---

### Displayed Average Noise (using HP 70902A IF Section or HP 70903A IF Section)

#### Tested Specification

AMPLITUDE: Displayed Average Noise Level

#### Equipment

50 $\Omega$  Termination

#### Equipment Setup

Connect the 50 $\Omega$  termination to the spectrum analyzer (DUT) RF INPUT.

#### Description

The average displayed noise level is measured at the frequency of the displayed peak in each band, except below 10 MHz where 10 data points are taken (for the HP 70900A local oscillator source only).

When the DUT system has an HP 70902A IF section, a resolution bandwidth of 10 Hz and a video bandwidth of 3 Hz are used. When the DUT system has an HP 70903A IF section, a resolution bandwidth of 100 kHz and a video bandwidth of 300 Hz are used. A sweep is taken and trace information is averaged.

#### In Case of Failure

If this test fails, the following modules may need repair or adjustment:

- Local oscillator
- IF section
- RF section

## GSM System Displayed Average Noise Level (using HP 70902A IF Section)

### Tested Specification

AMPLITUDE: Displayed Average Noise Level

### Equipment

50 $\Omega$  Termination

### Equipment Setup

Connect the 50 ohm termination to the HP 70912B downconverter High-Power RF INPUT. If the HP 70621A preamplifier-H50 Preamplifier is present in the system, connect the termination to its RF INPUT instead.

---

**Note** GSM System Calibration must be completed before performing this test in order to generate the required system calibration factors and store them in the AMPCOR facility.

---

### Description

With the AMPCOR facility activated, the GSM system displayed average noise level is measured over two ranges: 10 MHz to 1 GHz, and 1 GHz to 2.9 GHz (for HP 71150C GSM transmitter tester) or 12.75 GHz (for HP 71250C GSM transmitter tester). A resolution bandwidth of 100 kHz is used for this measurement. The noise peak is located in each range. The frequency span is set to zero-span, and a sweep is taken at the frequency of the measured peak noise. The trace information from this sweep is averaged.

### In Case of Failure

If this test fails, the following modules may need repair or adjustment:

- Local oscillator
- IF section
- RF section
- Downconverter
- Preamplifier (if present)

# Log Fidelity (for HP 70902A IF Section or HP 70903A IF Section)

## Tested Specification

AMPLITUDE: Scale Fidelity: Log Fidelity

## Equipment

Level Generator

## Equipment Setup

Connect the 50 $\Omega$  output of the level generator to the RF INPUT of the spectrum analyzer (DUT).

## Description

This test measures the relative on-screen log scale fidelity (that is, the display screen's upper eight divisions for the HP 70903A IF section, or upper nine divisions for the HP 70902A IF section).

The DUT is set for a reference level of 10 dBm, span of 0 Hz, and a resolution bandwidth of 100 kHz (HP 70903A IF section) or 100 Hz (HP 70902A IF section). The level generator frequency is adjusted to peak the detected signal, and the amplitude is adjusted to set the signal at the reference level. The difference between the level generator and marker amplitudes establishes a reference error at this point.

The level generator is stepped down in 2 dB increments until the signal is 75 to 90 dB below top-screen. The actual level depends on the IF and RF being tested. In the last 20 dB of the log range, the sweep time is increased to lessen the effects of the reduced signal-to-noise ratio. The amplitude difference between the level generator and the displayed trace average is measured. Once all measurements have been made, the data is normalized to -10 dB of top-screen.

If the HP 70700A digitizer is in the system, the test is repeated with the digitizer selected.

## In Case of Failure

If this test fails, the following modules may need repair or adjustment:

- IF section

---

## Resolution Bandwidth Tests (for HP 70902A IF Section or HP 70903A IF Section)

### Tested Specifications

AMPLITUDE: Resolution Bandwidth Switching Accuracy  
FREQUENCY: Resolution Bandwidths (–3 dB), Accuracy  
FREQUENCY: Resolution Bandwidths (–3 dB), Selectivity

### Equipment

Level Generator

### Equipment Setup

Connect the RF OUTPUT of the level generator to the RF INPUT of the spectrum analyzer (DUT).

### Description

Bandwidth switching variation is tested by setting a reference value at the widest resolution bandwidth. The DUT resolution bandwidth is then stepped down in a 1, 3, 10 sequence and the amplitude variation from the widest bandwidth is recorded. The data is then normalized to the reference bandwidth (100 Hz, HP 70902A IF section; 300 kHz, HP 70903A IF section).

The 3 dB (or 60 dB) points of the resolution bandwidth response are tested as follows. The DUT is set to the 0 Hz span and the level generator frequency is adjusted to peak the response. The level generator amplitude is then stepped down 3 dB to establish a reference value. The level generator amplitude is then returned to the original value and the frequency is decreased until the 3 dB reference amplitude is reached. This establishes the lower 3 dB frequency point. The level generator frequency is then increased until the upper 3 dB point is found. The difference in level generator frequencies is the 3 dB bandwidth. This procedure may be repeated to determine the 60 dB points of the resolution bandwidth response.

### In Case of Failure

If this test fails, the following modules may need repair or adjustment:

- IF section

# Calibrator Amplitude Accuracy (using HP 70907A External Millimeter Interface Module)

## Tested Specification

AMPLITUDE: Internal 321.4 MHz Calibrator Accuracy

## Equipment

General Source  
Measuring Receiver  
Sensor Module

## Equipment Setup

Setup A: Connect the general source through an appropriate cable to the sensor module of the measuring receiver.

Setup B: Connect the general source output to the IF INPUT of the HP 70907A external millimeter interface module. Connect the sensor module to the 321.4 MHz OUT of the EMIM.

## Description

This test measures the amplitude variation of the internal calibration source over its tuning range referenced to a  $-35$  dBm signal applied to the IF INPUT of the EMIM.

The general source is set to a frequency of 321.4 MHz and an amplitude of  $-35$  dBm. The amplitude of the general source output is measured by the measuring receiver. The cables that are needed to connect the source to the EMIM must be included so that any losses may be accounted for and calibrated out.

The amplitude of the EMIM output is measured to establish its gain. The internal calibration source of the EMIM is then stepped over its frequency range in 5 kHz increments. At each frequency increment, the actual frequency is measured by the measuring receiver. This data is then normalized to the  $-35$  dBm level previously set.

Note that the internal calibration source is actually changing frequency. The tuning is not symmetrical about the 321.4 MHz nominal center and requires tuning  $\pm 30$  kHz of this center.

## In Case of Failure

If this test fails, the following modules may need repair or adjustment:

- External Mixer Interface module

---

## Calibrator Amplitude Accuracy (using HP 70907B External Millimeter Interface Module)

### Tested Specification

AMPLITUDE: Internal 321.4 MHz Calibrator Accuracy

### Equipment

General Source  
Measuring Receiver  
Sensor Module  
Hybrid Combiner

### Equipment Setup

---

**Note** Before this test can be performed accurately, the measuring receiver and the HP 70000 Series system under test (DUT), which includes the HP 70907B external millimeter interface module, must both be calibrated.

---

Connect a low-loss cable (such as HP part number 8120-3124) from the general source to the common port of the hybrid combiner. Connect one of the output ports of the hybrid combiner to the measuring receiver. Connect the other output port of the hybrid combiner to the HP 70907B external millimeter interface module front panel IF INPUT port.

### Description

#### Equipment Setup Check

The general source is set to 321.4 MHz at a power level of  $-20$  dBm. The power level is measured by both the measuring receiver and, by using markers, the DUT. The general source's power level is then lowered by 10 dB and the power level is again measured by both instruments. The equipment setup is considered correct if the difference between the two sets of power-level measurements is approximately 8 to 12 dB for both instruments.

#### Calibrator Test

The DUT is preset, the span is set to 0 Hz, and the conversion loss is set to 0 dB. The resolution bandwidth is set to either 100 Hz (when an HP 70902A IF section is used) or 300 kHz (when only an HP 70903A IF section is used). The general source's output frequency is adjusted to peak (center in the IF-filter passband) the measured response on the DUT. The general source's amplitude is then adjusted to produce a reading of  $-20$  dBm on the measuring receiver. The DUT marker amplitude is read and compared to the measuring receiver's reading. The difference between the DUT reading and the measuring receiver's reading is the calibrator's absolute amplitude accuracy.

### In Case of Failure

If this test fails, the following modules may need repair or adjustment:

- External Mixer Interface module

## LO Output Amplitude

---

# LO Output Amplitude (from HP 70907A/B External Millimeter Interface Module)

## Tested Specification

HP 70907A/B external millimeter interface module LO OUTPUT

## Equipment

Power Meter  
MW Power Sensor

## Equipment Setup

Setup A: Connect the MW power sensor to the power meter POWER REF OUTPUT.

Setup B: Connect the MW power sensor to the LO OUTPUT of the HP 70907A/B external millimeter interface module.

## Description

If the power meter needs calibration, connect the equipment using setup A.

Connect the equipment using setup B. This test measures the EMIM LO OUTPUT power over the full tuning range of the HP 70900B local oscillator source (3.0 to 6.6 GHz). The EMIM is set to zero span.

## In Case of Failure

If this test fails, the following modules may need repair or adjustment:

- External Mixer Interface module



---

## Log Fidelity — Using HP 70907A/B External Millimeter Interface Module (for HP 70902A IF Section and HP 70903A IF Section)

### Tested Specification

AMPLITUDE: Scale Fidelity: Log Fidelity

### Equipment

General Source  
Measuring Receiver  
Sensor Module  
Hybrid Combiner

### Equipment Setup

Connect the general source to the input of the hybrid combiner. Connect one output of the hybrid combiner to the IF INPUT of the HP 70907A/B external millimeter interface module. To the remaining output of the hybrid combiner, connect the sensor module from the measuring receiver.

### Description

This test measures the relative on-screen log scale fidelity (that is, the display screen's upper eight divisions for the HP 70903A IF section, or upper nine divisions for the HP 70902A IF section).

The IF section is set to 100 kHz (HP 70903A IF section) or 1 kHz (HP 70902A IF section) resolution bandwidth, 300 Hz video bandwidth, and sample detection. The millimeter spectrum analyzer acts as a fixed-tuned 321.4 MHz receiver, so the span is set to 0 Hz. The reference is set to provide maximum on-screen dynamic range. The general source frequency is adjusted to center the signal in the IF passband, and the general source amplitude is adjusted to set the signal at the reference level. The measuring receiver measures the general source amplitude. The difference between the measuring receiver reading and marker amplitude readout establishes a top-screen reference.

The general source amplitude is decreased in 2 dB increments until the signal is 75 to 90 dB below top-screen. The actual level depends on the IF being tested and the test mode. In the last 20 dB of the log range, the sweep time is increased to lessen the effects of the reduced signal-to-noise ratio. Once all measurements have been made, the data is normalized to -10 dB of top-screen to account for the small amount of gain compression in the upper 10 dB of display range.

If the HP 70700A digitizer is in the system, the test is run again with the digitizer selected.

### In Case of Failure

If this test fails, the following modules may need repair or adjustment:

- IF section

# Resolution Bandwidth — Using HP 70907A External Millimeter Interface Module (for HP 70902A IF Section or HP 70903A IF Section)

## Tested Specifications

AMPLITUDE: Resolution Bandwidth Switching Accuracy  
FREQUENCY: Resolution Bandwidths (–3 dB), Accuracy  
FREQUENCY: Resolution Bandwidths (–3 dB), Selectivity

## Equipment

General Source  
Measuring Receiver  
Sensor Module  
Hybrid Combiner

## Equipment Setup

Connect the general source to the input of the hybrid combiner. Connect one output connector of the hybrid combiner to the IF INPUT of the HP 70907A external millimeter interface module. To the remaining output connector of the hybrid combiner, connect the sensor module from the measuring receiver.

## Description

This test measures the resolution bandwidth switching variation by taking a reference amplitude reading in 1 kHz (HP 70902A IF section) or 300 kHz (HP 70903A IF section) resolution bandwidth, then comparing the IF section resolution bandwidth amplitude (from 300 Hz to 300 kHz) to this reference. During this measurement, the video bandwidth is set at 300 Hz (used during the calibration of the IF section) to eliminate any amplitude shift caused by video bandwidth switching.

The 3 dB and 60 dB bandwidths are determined by the following algorithm: The resolution bandwidths are stepped in a 1, 3, 10 sequence from 300 Hz to 300 kHz (HP 70902A IF section) or 100 kHz to 3 MHz (HP 70903A), the general source frequency is adjusted to peak the signal in each bandwidth, and the marker amplitude is read by taking the mean of the trace points. The mean is used as a reference amplitude.

The general source amplitude is stepped down 3 dB (or 60 dB) to establish a reference marker amplitude on the display. The general source amplitude is then returned to the original level and the frequency is adjusted until the lower 3 dB (or 60 dB) point is found. This procedure is repeated for the upper 3 dB (or 60 dB) point. The 3 dB (or 60 dB) bandwidth is the difference between the upper and lower frequencies. The selectivity (shape factor) is the ratio of the 60 dB bandwidth divided by the 3 dB bandwidth.

## **In Case of Failure**

---

**Note**            The switching specification is primarily determined by the preceding Calibrator Amplitude Accuracy test specification. Should the Resolution Bandwidth test fail, perform the Calibrator Amplitude Accuracy test to verify that it passes before assuming that the resolution bandwidths are out of specification.

---

If this test fails, the following modules may need repair or adjustment:

- IF section

# Resolution Bandwidth — Using HP 70907B External Millimeter Interface Module (HP 70902A IF Section or HP 70903A IF Section)

## Tested Specifications

AMPLITUDE: Resolution Bandwidth Switching Accuracy  
FREQUENCY: Resolution Bandwidths (–3 dB), Accuracy  
FREQUENCY: Resolution Bandwidths (–3 dB), Selectivity

## Equipment

General Source  
Measuring Receiver  
Sensor Module  
Hybrid Combiner

## Equipment Setup

Connect the general source to the input of the hybrid combiner. Connect one output connector of the hybrid combiner to the IF INPUT of the HP 70907B external millimeter interface module. To the remaining output connector of the hybrid combiner, connect the sensor module from the measuring receiver.

## Description

This test measures the resolution bandwidth switching variation by taking a reference amplitude reading in 100 Hz (HP 70902A IF section) or 300 kHz (HP 70903A IF section) resolution bandwidth, then comparing the IF section resolution bandwidth amplitude (from 10 Hz to 300 kHz) to this reference. During this measurement, the video bandwidth is set at 300 Hz (used during the calibration of the IF section) to eliminate any amplitude shift caused by video bandwidth switching.

The 3 dB and 60 dB bandwidths are determined by the following algorithm: The resolution bandwidths are stepped in a 1, 3, 10 sequence from 10 Hz to 300 kHz (HP 70902A IF section) or 100 kHz to 3 MHz (HP 70903A IF section), the general source frequency is adjusted to peak the signal in each bandwidth, and the marker amplitude is read by taking the mean of the trace points. The mean is used as a reference amplitude.

The general source amplitude is stepped down 3 dB (or 60 dB) to establish a reference marker amplitude on the display. The general source amplitude is then returned to the original level and the frequency is adjusted until the lower 3 dB (or 60 dB) point is found. This procedure is repeated for the upper 3 dB (or 60 dB) point. The 3 dB (or 60 dB) bandwidth is the difference between the upper and lower frequencies. The selectivity (shape factor) is the ratio of the 60 dB bandwidth divided by the 3 dB bandwidth.

## **In Case of Failure**

---

**Note**            The switching specification is primarily determined by the preceding Calibrator Amplitude Accuracy test specification. Should the Resolution Bandwidth test fail, perform the Calibrator Amplitude Accuracy test to verify that it passes before assuming that the resolution bandwidths are out of specification.

---

If this test fails, the following modules may need repair or adjustment:

- IF section

## **Test Limit Changes**

---

## **Test Limit Changes**

### **Revision D.01.00**

There are no test limit changes as of this printing.

---

## Error and Status Messages

User interface messages used with HP 70000 Series software products are alphabetized in this section. The messages are designed to provide information about test results, operator errors, system conditions, and so on. Refer to your *HP BASIC Language Reference* for system error information.

<<<<

The indicated result of the test is outside the test limit.

<\*>

The indicated result of the test far exceeds the expected result. Suspect a failure of test equipment, accessories, or spectrum analyzer.

3478A MULTIMETER requires calibration.

Your HP 3478A is functioning improperly. Either connect a different HP 3478A or display the Equipment Menu and assign a different model number.

Aborted

You aborted the test indicated.

Adjust Inst

The system under test needs adjustment or repair to pass the indicated test's specification.

CAUTION: Some Model #'s are not supported. (See Edit Screen).

You have model numbers in the Equipment Menu that are not supported by the software. Ignore this caution if you are sure that the model numbers listed are correct and that program memory contains a driver for these models. Otherwise, press **EDIT** to return to the edit screen, and correct the model number. A driver that is required but missing causes the error message **ERROR MESSAGE:\_\_\_\_\_ is a undefined subprogram to appear on-screen.** You can return to the Test Menu by pressing **ABORT**.

Current zero expired.

The power meter requires rezeroing. Perform the procedure provided on the computer display.

Disk file is full, no longer duplicating output.

You attempted to store too much data on a disk.

Equipment list is not acceptable.

You attempted to enter the Test Menu, but the program could not locate all the instruments for which you have specified HP-IB addresses. Verify that the indicated equipment is turned on, then return to the Equipment Menu edit screen to verify accuracy of addresses that are flashing in the Address column.

Equipment list shows no analyzer to test.

The DUT has no assigned HP-IB address. Return to the Equipment Menu and edit the Address column.

## Error and Status Messages

ERROR: Address matches system disk drive.

You entered an HP-IB address matching that of the computer's external disk drive. HP-IB protocol allows only one instrument per address.

ERROR: Address not in acceptable range.

You entered an HP-IB address outside the range 700 to 730, inclusive.

ERROR: Non-responding HP-IB address.

You attempted to exit the Equipment Menu after assigning an HP-IB address to an instrument that is not responding on HP-IB.

ERROR: Search for volume label \_\_\_\_ unsuccessful.

The program tried to find the disk identified but could not. Either assign a drive to the disk or insert the required disk into its appropriate drive. Then press **REPEAT**.

ERROR: Some devices listed as "Available" require serial numbers.

You pressed **DONE** to go to the Equipment Menu command screen, but some devices have not been assigned their required serial numbers. Display the Equipment Menu edit screen and assign the serial numbers.

ERROR: Address is HP-IB controller address.

You entered an HP-IB address matching the computer's address. HP-IB protocol allows only one instrument per address.

ERROR MESSAGE: Attempt to close file \_\_\_\_ failed.

There is a problem with the data file on the Operating Disk. Correct the problem, then do one of the following:

- Press **REPEAT** to try again.
- Press **CREATE** to create a new file.
- Press **ABORT** to return to the Main Menu.

ERROR MESSAGE: Attempt to create file \_\_\_\_ failed.

There is a problem with the data file on the Operating Disk. Correct the problem, then do one of the following:

- Press **REPEAT** to try again.
- Press **CREATE** to create a new file.
- Press **ABORT** to return to the Main Menu.

ERROR MESSAGE: Attempt to Edit Mass Storage failed.

Your edits to the Mass Storage Menu were not valid. Return to this menu and correct the errors.

ERROR MESSAGE: Attempt to store Mass Storage failed.

You pressed **ABORT** after pressing **STORE** mass storage. The Mass Storage Menu failed. Press **ABORT** to return to the Main Menu.



## Error and Status Messages

ERROR MESSAGE: Bad instrument address in equipment list. Address matches controller.

You entered an HP-IB address matching that of the controller. HP-IB protocol allows only one instrument per address and only one controller per HP-IB system. (The factory preset controller address is 21.)

ERROR MESSAGE: Calibration data frequency exceed acceptable limits.

Return to the Cal Data edit screen in the Equipment Menu and correct the data entries that are flashing.

The frequency entered next to the device in the Cal Data edit screen is out of the device's operating range. The return to this screen is automatic. Enter valid frequencies for the values that are flashing.

ERROR MESSAGE: Calibration data frequency is greater than maximum range of \_\_\_\_.

The frequency entered next to the device in the Cal Data edit screen is out of the device's operating range. The return to this screen is automatic. Enter valid frequencies for the values that are flashing.

ERROR MESSAGE: Calibration data for \_\_\_\_ is blank for some frequencies listed.

Return to the Cal Data edit screen in the Equipment Menu and enter the calibration data for frequencies indicated with flashing markers.

ERROR MESSAGE: Calibration data for \_\_\_\_ is less than minimum range of \_\_\_\_.

The factor entered next to the device in the Cal Data edit screen is out of the device's operating range. The return to this screen is automatic. Enter valid values for the ones that are flashing.

ERROR MESSAGE: Calibration data for \_\_\_\_ is greater than maximum range of \_\_\_\_.

The factor entered next to the device in the Cal Data edit screen is out of the device's operating range. The return to this screen is automatic. Enter valid values for the ones that are flashing.

ERROR MESSAGE: Calibration data for \_\_\_\_ with serial number \_\_\_\_ is not found on the current Operating disk.

The data file cannot be found or there is a problem with the data file on the Operating Disk. If you have stored calibration data on another HP 70000 Software Product Operating Disk, replace your current Operating Disk with that one and access the data. Be sure to return the Operating Disk belonging with your system under test to the default drive. After correcting the problem, either press **REPEAT** to try again or press **PROCEED**.

ERROR MESSAGE: DUT does not have an address.

You attempted to leave the Equipment Menu, but the program cannot verify the DUT at the specified HP-IB address. First check the address. If the address is correct, cycle the main power of the system under test.

## Error and Status Messages

ERROR MESSAGE: DUT was not at address in the equipment list. DUT was expected at address \_\_\_\_.

The DUT is not at the specified address, or HP-IB is at fault, or main power on the DUT is off. Press **ABORT**, then return to the Equipment Menu to verify the address.

ERROR MESSAGE: DUT was not found at address in equipment list.

The address specified for the DUT is not valid. Press **ABORT**, then return to the Equipment Menu to verify the address.

ERROR MESSAGE: Equipment address matches external disk drive.

You entered an equipment address matching that of the external disk drive. HP-IB protocol allows only one instrument per address.

ERROR MESSAGE: Equipment Menu data not found on \_\_\_\_.

The program could not find the Equipment Menu data file on the Operating Disk. Possible Fix instructions appear with the on-screen error message. If the data file is available in a location other than the one currently specified in the Mass Storage Menu, return to that menu and change the msus or the directory path of the Operating Disk. It may also be that the Operating Disk accessed by the program is not the one containing the Equipment Menu file. Insert the correct Operating Disk, then press **REPEAT** or **PROCEED**.

ERROR MESSAGE: Equipment does not have an address.

There is no address assigned to the DUT. Return to the Equipment Menu edit screen and verify or enter an address in the Address column.

ERROR MESSAGE: ERROR XXX in XXXX \_\_\_\_.

An unanticipated occurrence in the program caused a program failure. For clarification, call your Hewlett-Packard Sales and Service Office.

ERROR MESSAGE: File \_\_\_\_ not found while assigning I/O path.

You attempted to **STORE** a list (equipment, mass storage, or parameter) for the first time on the current Operating Disk. Possible Fix instructions appear with the on-screen error message. Follow the on-screen instructions or return to the Mass Storage Menu to change the location of the Operating Disk.

ERROR MESSAGE: Incorrect disk found. \_\_\_\_ required.

The wrong disk is in the required storage medium. Either correct the fault and press **REPEAT** to retry, or select **mass storage** to return to the Mass Storage Menu. From here you can indicate a different mass storage drive.

ERROR MESSAGE: \_\_\_\_ is a undefined subprogram.

The program has tried to use a model number that is not supported by the current software. If an incorrect model number was entered, return to the Equipment Menu and correct the model number. If the model number is correct, you must load the appropriate instrument driver before you can continue testing. Press **ABORT** to return to the Test Menu command screen.

## Error and Status Messages

ERROR MESSAGE: Parameter Menu data not found on \_\_\_\_.

The program could not find Parameter Menu data file on the Operating Disk. Possible Fix instructions appear with the on-screen error message. If the data file is available in a location other than the one currently specified in the Mass Storage Menu, return to that menu and change the msus and/or the directory path of the Operating Disk. It may also be that the Operating Disk accessed by the program is not the one containing the Parameter Menu data file. Insert the correct Operating Disk, then press **REPEAT** or **PROCEED**.

ERROR MESSAGE: Read \_\_\_\_ data from file \_\_\_\_ failed.

There is a problem with the data file on the Operating Disk. Correct the problem, then either press **REPEAT** to try again or **ABORT** to return to Main Menu.

ERROR MESSAGE: Selected system under test is \_\_\_\_; but the software supports the \_\_\_\_ system.

The RF section module entered in the HP-MSIB map is not currently supported by software. Either load the correct software or select a different RF section module in the HP-MSIB Map Menu.

ERROR MESSAGE: Sensor model # \_\_\_\_ not supported.

Software does not support the sensor model number entered for the Signal Sensor in the Equipment Menu. Return to the Equipment Menu and select a sensor with a model number that is supported. (For a list of supported equipment, refer to Table 4-1.

ERROR MESSAGE: Parameter Menu data file not found on \_\_\_\_.

The program could not find parameter-list data file on the Operating Disk. Possible Fix instructions appear with the on-screen error message. If the data file is available in a location other than the one currently specified in the Mass Storage Menu, return to that menu and change the msus and/or the directory path of the Operating Disk. It may also be that the Operating Disk being accessed by the program is not the one containing the parameter-list data file. Insert the correct Operating Disk, then press **REPEAT** or **PROCEED**.

ERROR MESSAGE: The correct Power Sensor has not been detected. Connect the \_\_\_\_ or Abort the test.

The power sensor currently connected to the Measuring Receiver is not the power sensor required for the current test. Connect the required sensor and press **PROCEED**, or press **ABORT** to return to the Test Menu command screen.

ERROR MESSAGE: The Operating Disk is write protected.

Make a working copy of the Operating Disk and store the original in a safe place, or remove the write-protect.

ERROR MESSAGE: Too many Cal Data frequencies were eliminated. There must be at least two frequencies.

Only one Cal Frequency remains in the Cal Data edit screen. Return to that screen and enter more frequencies in the Frequency column.

## Error and Status Messages

ERROR MESSAGE: \_\_\_\_ was not located.

The program cannot access the listed Volume. If the Volume is correct, press **REPEAT** to retry. If the Volume is incorrect, press **mass storage** to return to the Mass Storage Menu. From here you can indicate a different mass storage medium for the Volume in question.

ERROR MESSAGE: Write \_\_\_\_ data to file \_\_\_\_ failed.

There is a problem with the data file on the Operating Disk. Correct the problem, then do one of the following:

- Press **REPEAT** to try again.
- Press **CREATE** to create a new file.
- Press **ABORT** to return to the Main Menu.

ERROR MESSAGE: Wrong device at specified address. DUT was expected at address \_\_\_\_.

The address specified for the DUT is actually that of a test instrument. Possible Fix instructions appear with the on-screen error message. If necessary, return to the Equipment Menu.

FORMAT ERROR: Observe date format and character position.

You entered the date and time in an unacceptable format. Enter date and time in the format dd mmm yyyy and hh:mm, then press **(ENTER)**.

Hdw Broken

Actual test results far exceed the expected results. This is often an indication of a hardware failure (hardware broken) or incorrect connections.

Initializing the HP-IB system per the Equipment Menu.

The program is attempting to determine if the HP-IB addresses provided in the Equipment Menu can be found. This message only appears if Verify equipment on HP-IB: has been selected in the Parameter Menu.

KEYBOARD SYSTEM CRASH WITH KEYBOARD: \_\_\_\_.

The software program does not support the current keyboard. Install a keyboard having one of the part numbers listed in the "Computer Hardware Compatibility", then restart the program.

The program tried to store error data onto the Operating Disk and could not because of the write-protect. Make a working copy of the Operating Disk and store the original in a safe place, or remove the write-protect.

Media not initialized.

You attempted to access a blank disk. Correct the fault, then press **(CONTINUE)**.

No case for the sensor in the 8902A driver!

Software does not support the sensor indicated as Signal Sensor in the Equipment Menu. Return to the Equipment Menu and select a supported sensor.

## Error and Status Messages

No disk copy of output found.

You pressed **REPRINT** in the Main Menu, but the program cannot find a data file in the current DATA Volume. If you saved the data, return to the Mass Storage Menu and edit the location of the DATA Volume.

Passed

The spectrum analyzer meets the tested specifications.

PAUSED. PRESS CONTINUE.

You pressed **PAUSE** on the computer keyboard. Press **CONTINUE** to resume program execution.

PRGM ERROR

The program detected an error within itself. For clarification contact Hewlett-Packard Signal Analysis Division.

Reading errors from ERRORLOG failed. Check disk at \_\_\_\_\_.

The program tried to read error data from the Operating Disk. Check that the Operating Disk is installed in the drive specified in the error message.

Return to Equipment Menu to enter serial number for \_\_\_\_\_.

You must return to the Equipment Menu edit screen and enter a SERIAL or ID NO. for the passive device selected before you can edit the device's calibration data.

Setup Error

The program aborted the test after attempting to verify the test setup. Make sure that all required test equipment is present, and has been turned on and connected.

Short Pass

The spectrum analyzer meets an abbreviated version of the tested specifications. Some external test equipment, or the spectrum analyzer, has insufficient range for a complete test. (For example, Line-Related Sidebands typically passes with a Short Pass.)

Test can not be done.

Required ETE is missing. Return to the Equipment Menu and enter all ETE listed as required for the current test.

Testing \_\_\_\_ dd\_mmm\_yyyy.

The particular test was last modified on the displayed date.

TEST\_LIST is not compatible.

A bad test list exists. Contact Hewlett-Packard Signal Analysis Division for assistance.

The controller does not have sufficient memory. This software cannot load. See the computer hardware system documentation for information on adding additional memory.

Refer to the appropriate manual to extend the memory capability of your system.

The \_\_\_\_\_ at address \_\_\_\_\_ was not found on HP-IB.

When Yes is selected for Verify equipment on HP-IB: in the Parameter Menu, this error message displays the test equipment with the address that is either missing or not set to on.

The 436A is in lowest range, waiting 10 seconds.

The current power measurement requires the lowest power-meter range. Program execution will resume in 10 seconds.

The 8902A needs repair (Error 6).

There is a problem related to the HP 8902A. Correct the fault or return to the Equipment Menu where you can enter a different model number.

The DUT must have an HP-IB address.

You attempted to leave the Equipment Menu, but the program cannot find the HP 70000 system at the assigned HP-IB address.

THIS COLUMN CAN NOT BE EDITED.

You pressed **SELECT** with the cursor positioned in the first column of the Mass Storage edit screen or the Equipment Menu edit screen. This column cannot be edited.

This test can not be selected because of missing ETE.

You were in either Multiple Tests or Repeat Multiple, then tried to select a test that has missing ETE. This is not allowed. Check the Status column of the Test Menu to verify a Missing ETE tag next to the test name you attempted to select.

Timed Out

The program aborted the test.

WARNING: Duplicate Address

You attempted to exit the Equipment Menu after assigning the same HP-IB address to two different model numbers. HP-IB protocol allows only one instrument per address. It is acceptable to assign the same address to identical model numbers, implying multiple use of the same instrument. You may have to scroll through the menu to find the duplication.

WARNING: Duplication may exclude specific tests.

You assigned two generic device functions to one test instrument. (For example, the TOI test will not be run if you assign a single HP 3335A as both the required level generator and the required general source.)

WARNING: String is too long. It has been truncated.

You entered too many characters in a user's line of the Parameter Menu edit screen. Select the line and enter 30 or fewer characters.

Write protected.

You attempted to store data on a write-protected disk. After correcting the fault, press **CONTINUE**.

## Error Messages

---

Representative error messages for HP 70000 Series modular spectrum analyzer systems are listed on the following pages. For information about error messages not listed here, refer to the installation and verification manual for the element that is generating the error.

These error messages are grouped by functional category each category has its own series of numbers. A definition of the functional category is given at the beginning of each error message listing.

<b>Types</b>	<b>Numbers</b>
User Application	0001—0999
Operating	2000—2999
Hardware-Warning	6000—6999
Hardware-Broken	7000—7999
Computation	8000—8999
Factory Use Only	9000—9999

The spectrum analyzer displays error messages, which can also be retrieved via HP-IB by executing the ERR? programming command.

Operating, hardware-warning, hardware-broken, and computation error messages report the element model number and HP-MSIB address of the module that is generating the error condition.

---

**Note** For complete troubleshooting instructions related to the HP 70207A PC Display for MMS, the MSIB interface card, and the MSIB Y-cable, refer to the *HP 70207A User's Guide*.

---

---

## User Application Errors 0001 – 0999

The numbers 0001–0999 are reserved for error messages that are created for user-application programs and loaded into RAM.

### Error Messages for System Diagnostics

One example of a user-application program is “System Diagnostics,” a down-loadable program (DLP) designed by Hewlett-Packard. The system diagnostics error messages are listed below. These diagnostic error messages range from 0001 – 0070.

The asterisk (\*) printed before some of the following error code messages indicates that the program stops until the error is no longer being generated. The asterisk does not appear on the display screen.

---

**Note**            When a customer-designed down-loadable program is used, any error numbers assigned to the program should not duplicate system diagnostics error numbers.

---

#### **\*0001**

NO L0?

Cause: The program cannot find an HP 70900B local oscillator source at row address 0.

Cure: Check and correct the HP-MSIB switches on the HP 70900B local oscillator source.

#### **\*0002**

HP-MSIB addr 70902

Cause: The HP-MSIB address of the HP 70902A IF section does not follow addressing rules.

Cure: The recommended address of the HP 70902A IF section is in row 2 and the same column as the HP 70900B local oscillator source.

#### **\*0003**

HP-MSIB addr 70903

Cause: The HP-MSIB address of the HP 70903A IF section does not follow addressing rules.

Cure: The recommended address of the HP 70903A IF section is in row 4 and the same column as the HP 70900B local oscillator source.

#### **\*0004**

HP-MSIB addr 70904

Cause: The HP-MSIB address of the HP 70904A RF section does not follow addressing rules.

Cure: The recommended address of the HP 70904A RF section is in row 6 and the same column as the HP 70900B local oscillator source.



**\*0005**

HP-MSIB addr 70905/6

Cause: The HP-MSIB address of the HP 70905A RF section or HP 70906A RF section does not follow addressing rules.

Cure: The recommended address of the HP 70905A RF section or the HP 70906A RF section is in row 6 and the same column as the HP 70900B local oscillator source.

**\*0007**

21.4MHz daisy chain

Cause: The IF Section's 21.4 MHz rear panel daisy-chain cables are incorrectly connected.

Cure: The 21.4 MHz OUT of the 70903A connects to the 21.4 MHz IN of the HP 70902A IF section. The VIDEO OUT of the HP 70902A IF section connects to the VIDEO IN of the HP 70903A IF section.

**\*0008**

NO RF SECTION?

Cause: The program cannot find an RF section module.

Cure: Install an RF section in the system, or correct the HP-MSIB switch settings on the currently installed RF section.

**\*0009**

NO I.F. SECTION?

Cause: The program cannot find an IF Section.

Cure: Install an IF Section in the system, or correct the HP-MSIB switch settings on the currently installed IF Section.

**\*0010**

HP-MSIB addr 70907

Cause: The HP-MSIB address of the HP 70907A/B external millimeter interface module does not follow the addressing rules.

Cure: The recommended address of the HP 70907A/B external millimeter interface module is in row 5 and the same column as the HP 70900B local oscillator source.

**\*0011**

No EMIM Section?

Cause: The program cannot find an HP 70907A/B external millimeter interface module.

Cure: Install an EMIM in the system, or correct the HP-MSIB switch settings on the currently installed EMIM. This error will not occur in Revision C.00.00 and later.

## **User Application Errors 0001 – 0999**

### **\*0012**

HP-MSIB addr 70600

Cause: The HP-MSIB address of the Preselector does not follow the addressing rules.

Cure: The recommended address of the Preselector is in row 2 and the column immediately to the right of the HP 70900B local oscillator source.

### **\*0013**

No PRESELECTOR?

Cause: The program cannot find a Preselector configured to the HP 70900B local oscillator source.

Cure: Install a Preselector in the system, or correct the HP-MSIB switch settings on the currently installed preselector.

### **\*0014**

Incorrect System

Cause: The system selected to be tested requires modules which are not present in the system.

Cure: Select another configured system, or reconfigure your system to match the selection. This error will not occur in Revision C.00.00 and later.

### **\*0015**

HP-MSIB addr 70700

Cause: The HP-MSIB address of the HP 70700A digitizer does not follow the addressing rules. The program can test the HP 70700A digitizer only when it is configured as a slave to the HP 70900B local oscillator source.

Cure: The recommended address of the HP 70700A digitizer is in row 3 and the same column as the HP 70900B local oscillator source.

### **\*0020**

21.4MHz input cable

Cause: The program cannot find the rear panel 21.4 MHz input signal for the HP 70902A IF section.

Cure: Check the 21.4 MHz OUT connection on the rear panel of the RF section going to the 21.4 MHz IN connection on the rear panel of the HP 70903A IF section if present, otherwise the 21.4 MHz IN on the rear panel of the HP 70902A IF section. If this cable is connected properly, it might be defective.

**\*0021**

Video output cable

Cause: The rear panel VIDEO OUT signal from the HP 70902A IF section is not getting to the VIDEO input of the HP 70900B local oscillator source or 70903A.

Cure: Check the rear panel VIDEO OUT connection on the HP 70902A IF section. Be sure it is routed properly and the cable is not defective.

**0022**

LC bandwidths

Cause: The signal amplitude of the HP 70902A IF section is too low when it is set to the LC bandwidths (10 to 300 kHz).

Cure: The LC filters in the HP 70902A IF section require adjustment or repair.

**0023**

CRYSTAL bandwidths

Cause: The signal amplitude of the HP 70902A IF section is too low when it is set to the crystal bandwidths (10 Hz to 3 kHz).

Cure: The crystal filters in the HP 70902A IF section require adjustment or repair.

**0024**

Problem/ampl low?

Cause: The signal amplitude of the HP 70902A IF section is too low in both the LC and Xtal bandwidths. The program stops testing the HP 70902A IF section when this error is generated.

Cure: Check the connection at the 21.4 MHz IN on the rear panel of the HP 70902A IF section. Be sure the cable is routed correctly and is not defective. If this does not remedy the problem, the HP 70902A IF section 21.4 MHz Input Filter requires adjustment or repair.

**0025**

Step gain amplifier

Cause: The gain of one or more of the step gain amplifiers of the HP 70902A IF section is incorrect.

Cure: The step gain amplifiers in the HP 70902A IF section require adjustment or repair.

**0026**

Res BW-accuracy

Cause: The HP 70902A IF section resolution bandwidth is incorrect.

Cure: The bandwidth filter adjustments in the HP 70902A IF section should be performed. If this does not remedy the problem, repair the HP 70902A IF section LC or crystal bandwidth filters.

## User Application Errors 0001 – 0999

### 0027

#### Res BW-amplitude

Cause: The amplitude variation between the resolution bandwidths of the HP 70902A IF section is too large.

Cure: The bandwidth filter adjustments in the HP 70902A IF section should be performed. If this does not remedy the problem, repair the HP 70902A IF section LC or crystal bandwidth filters.

### 0028

#### Calibration atten

Cause: The calibration attenuator of the HP 70902A IF section is not functioning correctly.

Cure: The calibration attenuators in the HP 70902A IF section require adjustment or repair.

### 0029

#### Log amplifier

Cause: The log amplifier of the HP 70902A IF section is not functioning correctly.

Cure: Perform the HP 70902A IF section log amplifier adjustment. If this does not remedy the problem, refer to the *HP 70902A IF section Service Manual* for procedures to repair the log amplifier or replace the thick-film log amplifier microcircuits.

### \*0030

#### 21.4MHz input cable

Cause: The program cannot find the rear panel 21.4 MHz input signal for the HP 70903A IF section.

Cure: Check the 21.4 MHz OUT connection on the rear panel of the RF section going to the 21.4 MHz IN connection on the rear panel of the HP 70903A IF section. If this cable is connected properly, it might be defective.

### \*0031

#### Video output cable

Cause: The rear panel VIDEO OUT signal of the HP 70903A IF section is not getting to the HP 70900B local oscillator source VIDEO input.

Cure: Check the rear panel VIDEO OUT connection on the HP 70903A IF section. Be sure it is routed properly to the HP 70900B local oscillator source and the cable is not defective.

### 0032

#### LC board

Cause: The HP 70903A IF section LC board signal amplitude is too low.

Cure: Perform the HP 70903A IF section LC filter adjustments or the HP 70903A IF section step gain adjustment. If these do not remedy the problem, the A1 LC filter assembly requires repair.

**0033**

Log board

Cause: The 70903A IF Section log board signal amplitude is too low.

Cure: Perform the HP 70903A IF section log amplifier adjustments. If this does not remedy the problem, the A2 Log Amplifier Assembly requires repair.

**0034**

Problem/ampl low?

Cause: The HP 70903A IF section internal 21.4 MHz IF signal amplitude is too low. The program stops testing the HP 70903A IF section when this error is generated.

Cure: Perform the HP 70903A IF section module adjustments. It is likely either the A1 LC wideband filter or A2 log amplifier/power supply requires repair.

**0035**

Step gain amplifier

Cause: The gain of the step gain amplifier of the HP 70903A IF section is incorrect.

Cure: The step gain amplifiers in the HP 70902A IF section require adjustment or repair.

**0036**

Res BW-accuracy

Cause: One or more of the HP 70903A IF section resolution bandwidths are not the correct value.

Cure: The bandwidth filter adjustments in the HP 70903A IF section should be performed. If this does not remedy the problem, repair the HP 70903A IF section LC bandwidth filters.

**0037**

Res BW-amplitude

Cause: The amplitude variation between the HP 70903A IF section resolution bandwidths is too large.

Cure: The bandwidth filter adjustments in the HP 70903A IF section should be performed. If this does not remedy the problem, repair the HP 70903A IF section LC bandwidth filters.

**0038**

Calibration atten

Cause: One or more of the calibration attenuators of the HP 70903A IF section are not functioning correctly.

Cure: The calibration attenuators in the HP 70903A IF section require adjustment or repair.

## User Application Errors 0001 – 0999

### 0039

Log amplifier

Cause: The log amplifier of the HP 70903A IF section is not functioning correctly.

Cure: Perform the HP 70903A IF section log amplifier adjustment. If this does not remedy the problem, refer to the *HP 70903A IF section Service Manual* for procedures to repair the log amplifier.

### 0040

Tune+Span

Cause: The Tune + Span level is incorrect or the system cable is missing.

Cure: Check to ensure the Tune + Span cable is connected from the HP 70900B local oscillator source LO to all modules that require it. SMB tee adapters may be required to daisy-chain this signal.

### 0041

RF attenuator

Cause: The HP 70907A/B external millimeter interface module internal attenuator is not functioning correctly.

Cure: Test and, if necessary, replace the HP 70907A/B external millimeter interface module input attenuator.

### \*0042

Cal/I.F. cables?

Cause: The front panel CALIBRATOR output of the HP 70900B local oscillator source is not connected to the RF INPUT of the RF section (a prerequisite for running the program), or the rear panel 21.4 MHz output of the RF section is not connected to the IF Section.

Cure: The marker reading was less than  $-60$  dBm and the RF section 21.4 MHz diagnostic detector indicated a low signal condition. This could be caused by no calibrator signal applied to the RF section input, no 21.4 MHz cable connected to the RF section rear panel 21.4 MHz output, or a defective RF section. Check for these conditions to remedy the problem.

### \*0043

Problem/ampl low?

Cause: The signal amplitude of the RF section is too low. The marker reading was less than  $-20$  dBm but greater than  $-60$  dBm and the RF section 21.4 MHz diagnostic detector indicated a low signal condition. The program stops testing when this error is generated.

Cure: This could be caused by no 21.4 MHz cable connected to the RF section rear panel 21.4 MHz output, or excessive loss in the signal path of the RF section. Check for these conditions to remedy the problem.

**0044**

Low/high band switch

Cause: The low/high band switch of the RF section is not functioning correctly.

Cure: This error occurs when a signal is detected in one setting of the high-low band coaxial switch but not the other. This switch is the most likely cause of this error. Test and replace if necessary.

**0045**

RF attenuator

Cause: The RF attenuator of the RF section is not functioning correctly.

Cure: Test and replace the RF Attenuator if necessary

**0046**

Step gain amplifier

Cause: The gain of the step gain amplifier of the HP 70908A RF section is incorrect. This error occurs if the 10 dB step gain amplifier in the HP 70908A RF section fails its test.

Cure: This amplifier is located in the last converter assembly of the HP 70908A RF section. The last converter assembly should be tested and repaired as required.

**0050**

Res BW -- CF

Cause: The resolution bandwidth center frequency of one or more of the 70902A IF Sections is out of adjustment.

Cure: Perform the HP 70902A IF section Resolution Bandwidth Filter adjustments.

**0051**

Res BW -- CF ampl

Cause: The resolution bandwidth of one or more of the HP 70902A IF sections is out of adjustment.

Cure: Perform the HP 70902A IF section Resolution Bandwidth Filter adjustments.

**0052**

Res BW -- CF ampl

Cause: The resolution bandwidth center frequency of one or more of the HP 70903A IF sections is out of adjustment.

Cure: Perform the HP 70903A IF section Resolution Bandwidth Filter adjustments.

## User Application Errors 0001 – 0999

### 0053

Res BW -- CF ampl

Cause: The resolution bandwidth of one or more of the HP 70903A IF sections is out of adjustment.

Cure: Perform the HP 70903A IF section Resolution Bandwidth Filter adjustments.

### 0060

RF attenuator

Cause: The RF attenuator of the HP 70600A preselector or the HP 70601A preselector is not functioning correctly.

Cure: Check and replace the RF Attenuator in the HP 70600A preselector or HP 70601A preselector.

### 0061

Cannot test 70905/6B

Cause: These RF sections can only be tested with an associated HP 70600A preselector or an HP 70601A preselector, as part of a preselected microwave spectrum analyzer system.

### 0062

Cal input incorrect?

Cause: The front panel CALIBRATOR output of the HP 70900B local oscillator source is not connected to the RF INPUT of the system being tested. (This is a prerequisite for running the program.)

Cure: This error indicates that the marker reading of the signal was less than  $-60$  dBm and the 21.4 MHz diagnostic detector indicated a low signal condition. Check that the calibrator signal from the HP 70900B local oscillator source is connected to the RF Input of the RF section or the preselector. If the calibrator is connected, check the RF signal path in the RF section for excessive loss.

### 0063

ATTENUATOR Section

Cause: One or more of the RF attenuator sections in the HP 70600A preselector or the HP 70601A preselector is not functioning correctly.

Cure: Check and replace the RF Attenuator in the HP 70600A preselector or HP 70601A preselector.



**0064**

RF Switch 1

Cause: This RF switch in the HP 70600A preselector or the HP 70601A preselector is not functioning properly.

Cure: Check A3S1 and replace if required.

**0065**

RF Switch 2

Cause: This RF switch in the HP 70600A preselector or the HP 70601A preselector is not functioning properly.

Cure: Check A4S2 and replace if required.

**0066**

RF Switch 3

Cause: This RF switch in the HP 70600A preselector or the HP 70601A preselector is not functioning properly.

Cure: Check A5S3 and replace if required.

**0067**

RF Switch 4

Cause: This RF switch in the HP 70600A preselector or the HP 70601A preselector is not functioning properly.

Cure: Check A6S4 and replace if required.

**0068**

RF Switch 1

Cause: The HP 70620 or HP 70621 has failed its switch diagnostic #1. If the preamplifier is an HP 70620A preamplifier, S4 or its associated drive circuitry has failed. If the preamplifier is an HP 70620B preamplifier or an HP 70621A preamplifier, K1 or its associated drive circuitry has failed.

Cure: Troubleshoot and replace the failed component if necessary.

**0069**

RF Switch 2

Cause: The HP 70620A preamplifier has failed its switch diagnostic #2. This indicates S1 or its associated drive circuitry has failed. This error applies to the HP 70620A preamplifier only.

Cure: Troubleshoot and replace the failed component if necessary.

## **User Application Errors 0001 – 0999**

### **0070**

#### **RF Preamplifier**

**Cause:** The HP 70621A preamplifier or HP 70620B preamplifier Option 001 RF preamplifier has failed its diagnostic test. This error will occur if the signal level gain through the RF preamplifier path at 300 MHz is less than or equal to 0 dB.

**Cure:** The most likely failure is the RF preamplifier microcircuit. Troubleshoot and repair this component and its power supply.

## Operating Errors 2000 – 2999

Operating errors occur when the spectrum analyzer is operated incorrectly.

### 2000

No errors

Cause: This message is returned from querying the system when no error is present in the system.

### 2001

Illegal command

Cause: The remote command sent over the bus or executed as part of a DLP was not a legal remote command. This error could also occur if a User Variable (VARDEF), which did not exist, was used as a parameter in a remote command. Check for missing terminators, and the proper number of parameters. Also verify that delimited strings have are properly ended.

Cure: Use the DEBUG command to locate the programming error. Refer to the DEBUG command description in the *HP 70000 Modular Spectrum Analyzer Programming Manual*.

### 2002

Illegal parameter

Cause: This is a user-generated system protocol error.

### 2003

Missing parameter

Cause: The command being executed requires more parameters than were provided, or a user variable VARDEF used as a parameter for a function was not found.

Cure: Use the DEBUG command to locate the programming error. Refer to the *HP 70000 Modular Spectrum Analyzer Programming Manual*.

### 2004

Illegal character

### 2005

Illegal character set

### 2006

Parm out of range

Cause: A change was made to an instrument setting that was beyond the capabilities of the hardware. This could be remote, DLP, or front panel changes.

Cure: Use the DEBUG command to locate the programming error. Refer to the *HP 70000 Modular Spectrum Analyzer Programming Manual*.

## **Operating Errors 2000 – 2999**

### **2007**

Missing terminator

### **2008**

Output unlevelled

### **2009**

Protocol error

Cause: Internal error due to illegal communication. Due to hardware failure.

Cure: Please document all details possible that lead up to the error and contact your HP representative

### **2010**

Cmd out of sequence

Cause: Internal error due to process synchronization. Possible hardware failure.

Cure: Please document all details possible that lead up to the error and contact your HP representative.

### **2011**

Memory overflow

Cause: There is not enough available memory for the operation. Examples would be adding a VARDEF, FUNCDEF, or ACTDEF sending AMPCOR data adding new modules to a system that was almost out of memory because of FUNCDEF's, and so forth

Cure: Some items must be removed from memory. Analyze DLP's to see if there are extra characters (spaces, and so forth) that could be removed. Expanded memory options for the Local Oscillator are also available.

### **2011**

A Hardware Selected

Cause: This is notification that a service mode has been enabled. The system is overriding the automatic configuration and operating as if the hardware is the "A" version of the HP 70900B local oscillator source LO module.

Cure: The power must be cycled to restore the automatic mode.

### **2012**

B Hardware Selected

Cause: This is notification that a service mode has been enabled. The system is overriding the automatic configuration and operating as if the hardware is the "B" version of the HP 70900B local oscillator source LO module.

Cure: The power must be cycled to restore the automatic mode.

## 2013

Item not found or XXXXX not found

The XXXXX will be replaced by the name of the item that was not found.

Cause: A request was made to operate on an item in memory that was not located.

Cure: Use the DEBUG command to locate the programming error. Refer to the *HP 70000 Modular Spectrum Analyzer Programming Manual*.

## 2014

Duplicate identifier

Cause: A variable, trace, or DLP name matches a reserved spectrum analyzer command.

Cure: Use the DEBUG command to locate the programming error. Refer to the *HP 70000 Modular Spectrum Analyzer Programming Manual*.

## 2015

Too many entries

Too many user definitions

Cause: More entries have been made in an internal table than was reserved. The most common time this will occur is having too many entries in the Limit Line Table.

Cure: Use the LIMILINE command to allocate more space for limit line entries.

## 2016

Label too long

Cause: A user generated key label that has more than 14 characters, or a FUNCDEF, VARDEF, or ACTDEF with more than 12 characters will generate this error.

Cure: The system will truncate the text to the correct number of characters and execute the requested function. Use the DEBUG command to locate the programming error. Refer to the *HP 70000 Modular Spectrum Analyzer Programming Manual*.

## 2018

State protected

Cause: This error occurs if a user stored instrument state that is protected was requested to be removed from memory. The state will not be removed. Also, if the number of user states is reduced using NSTATE, all states above the requested number will be deleted. If any of those states were protected, the NSTATE command will be ignored and this error will occur.

Cure: Unprotect any states no longer needed.

## **Operating Errors 2000 – 2999**

### **2019**

Illegal marker type

Cause: The command executed does not apply to the marker mode of the markers on the display. For example, if a normal marker is on screen, and the “Marker delta into span” function is activated, the function cannot be executed, and the error will occur.

Cure: Refer to the programming or operation manual for the function being executed to determine the proper marker type for the operation.

### **2020**

No active marker

Cause: This error occurs when Marker Delta is moved to Center Frequency Step Size (MKSS) while no markers are active.

### **2021**

Bad IF/ENDIF nesting

Cure: Use the DEBUG command to locate the programming error. Refer to the *HP 70000 Modular Spectrum Analyzer Programming Manual*.

### **2022**

REPEAT/UNTIL error

Cure: Use the DEBUG command to locate the programming error. Refer to the *HP 70000 Modular Spectrum Analyzer Programming Manual*.

### **2023**

Illegal Cal signal

Cause: Calibration signal did not match.

### **2024**

Illegal HP-MSIB comm

Illegal HP-MSIB communication

Cause: An HP-MSIB protocol violation has occurred.

Cure: Document all steps leading up to the error condition and contact your HP representative.

### **2025**

System error (slave)

Cause: HP-MSIB communications with a slave module has created this error.

Cure:

- Record the error number and the hexadecimal code.
- Record all events that led up to the occurrence of the error message.
- Record the HP model numbers of the modules in the system.
- Record the firmware version.

- Contact the nearest HP Sales and Service Office for assistance.

## 2026

Check mixer bias

## 2027

Service mode -- do IP

Cause: This is a user-generated system protocol error. The bandwidth or reference select is not in their AUTO modes. (For service use only.)

## 2028

Idler is unlocked

## 2029

Command syntax error

Cause: This error is generated when MSIB packet syntax is incorrect, or when a BDLP call is does not have the proper syntax.

Cure: Please document all the steps that led up to this error and contact your HP representative.

## 2030

Scaling overflow

Cause: The user has requested a scale factor that is too large in the DWINDOW command.

Cure: Refer to the DWINDOW command description in the *HP 70000 Modular Spectrum Analyzer Programming Manual* for limits.

## 2031

Too many errors

Cause: The error buffer has been filled.

## 2032

Hardware not present

Cause: A function was requested that required hardware not available in the system.

Cure: Use the DEBUG command to locate the programming error. Refer to the *HP 70000 Modular Spectrum Analyzer Programming Manual*.

## **Operating Errors 2000 – 2999**

### **2033**

Single band only

Cause: The SIGID command requires that the trace be in a single microwave band.

Cure: Adjust the start or the stop frequency so that the trace does not span more than a single band.

### **2034**

Test switch on

Cause: The module test switch is in the “test” position. All RAM is erased at each power cycle.

Cure: Set the module test switch to the “normal” position.

### **2035**

Illegal operation

### **2036**

HP-IB multiple cntlr

Cause: A DLP used an OUTPUT command or the spectrum analyzer attempted to access the disk when another device had control of the HP-IB.

Cure: Remove the other device from the HP-IB.

### **2037**

No instr resp

Cause: No HP-IB instrument response from an OUTPUT command or mass storage (such as SAVE or RECALL) to an HP-IB disk.

Cure: Verify that the HP-IB address is correct.

### **2038**

Span÷trace too large

Cause: There are too few data points for the span requested.

Cure: Reduce the span or increase the number of trace points.

### **2039**

User stack overflow

Cause: There is not enough RAM space remaining for the operation requested. Often nested DLPs are calling too deeply. For example, DLP “A” calls DLP “B” which calls DLP “C”, and so forth.

Cure: DLP program should be redesigned using fewer nesting levels.



**2040**

Partial USTATE data

Cause: A recalled user state is not complete.

**2041**

CAL POWER lvl err

CAL power level error

Cause: The calibration signal level is not sufficient for system calibration.

Cure: Increase the signal level. -10 dBm is optimum.

**2042**

Not stored, A-X->A on

Cure: Use the DEBUG command to locate the programming error. Refer to the *HP 70000 Modular Spectrum Analyzer Programming Manual*.

**2043**

LINEAR not allowed

Cure: Use the DEBUG command to locate the programming error. Refer to the *HP 70000 Modular Spectrum Analyzer Programming Manual*.

**2044**

Not stored: open 1st

Cause: The data for the short is entered before the data for the open when normalizing for swept response.

Cure: Store the data for the open first. Refer to the STORREF command.

**2045**

HP-IB bus error

Cause: HP-IB protocol violation.

Cure: Verify cables and computer for proper operation.

**2046**

No DAC in this band

Cause: There is no preselector in the current band.

Cure: Verify the start and stop frequencies and see the manual for operation ranges.

## **Operating Errors 2000 – 2999**

### **2047**

Preselector disabled

Cause: The preselector was bypassed while the peak command was executed.

Cure: Select the preselector path before executing the peak command.

### **2048**

Userdef protected

Cause: User-defined function or **(USER)** key is protected.

Cure: Use the DEBUG command to locate the programming error. Refer to the DEBUG command description in the *HP 70000 Modular Spectrum Analyzer Programming Manual*.

### **2049**

Battery failed

Cause: The battery backed up RAM was not valid.

Cure: Return to Hewlett-Packard for servicing.

### **2050**

Ampcr/span too large

Amplitude-correction data too large

### **2051**

File not found

Cause: A user state was not found in memory.

Cure: Check the state number or name.

### **2052**

File already exists

### **2053**

storage device

### **2054**

write protect

Cause: Mass storage device is write protected.

**2055**

bad file

Cause: File can not be read.

**2056**

bad revision

Cause: A recalled state is from a different firmware revision and cannot be used.

**2057**

volume full

Cause: The mass storage device is full.

Cure: Remove some files from the mass storage device.

**2058**

bad volume

**2059**

directory full

Cause: The directory of the mass storage device is full.

Cure: Remove some files from the mass storage device.

**2060**

New 70810 ROMs req

Cause: This LO firmware revision requires the latest HP 70810B lightwave section firmware to make lightwave measurements.

**2802**

Illegal in LW mode

Cause: The last command sent to the HP 70810B lightwave section is legal in bypass mode only.

Cure: Change the HP 70810B lightwave section to the bypass mode before using this command.

**2803**

Illegal in bypass

Cause: The last command sent to the HP 70810B lightwave section is legal in lightwave mode only.

Cure: Change the HP 70810B lightwave section to the lightwave mode before using this command.

---

## Hardware Warning Errors 6000 – 6999

Hardware-warning errors occur when the hardware is faulty. The spectrum analyzer can still make measurements, but the accuracy of the measurement cannot be guaranteed.

### 6000

EAROM unprotected

Cause: The memory-enable write switch is set to the WRITE position. It is not set to the PROTECT position.

Cure: Set the memory-enable write switch to the PROTECT position.

### 6001

Confidence test passed

### 6002

A6 RAM checksum (battery)

### 6003

FFS won't tune low

### 6004

FFS won't tune high

### 6005

Idler tuning range

### 6006

YTO tuning range

### 6007

MSIB NMAA received

HP-MSIB “no module at address” received

Cause: The module attempted to establish communication with a module at an incorrect address. The system responded with an NMAA (no module at address).

Cure: If using MSIB communication, verify the address if the module you are trying to communicate with is correct. Otherwise, document all steps that led to the error condition and contact your HP representative.

**6008**

Confidence test failed

**6009**

No module label

**6010**

Err in MDOC response

Cause: An error in module-output capabilities response has occurred.

Cure: Return to Hewlett-Packard for servicing.

**6011**

RBW hardware error

Resolution bandwidth hardware error

Cause: The resolution bandwidth filters were not able to be calibrated.

Cure: Return to Hewlett-Packard for servicing.

**6012**

Gain hardware error

Cause: The amplifiers were not able to be calibrated.

Cure: Return to Hewlett-Packard for servicing.

**6013**

LOGAMP hardware error

Cause: The log amplifiers were not able to be calibrated.

Cure: Return to Hewlett-Packard for servicing.

**6014**

PLL error

Phase-lock loop is unlocked and/or the loop-tuning voltage is near its limit. The internal or external frequency reference source is not close enough to 1, 2, 5, or 10 MHz for the HP 70310A precision frequency reference to operate, or a hardware failure exists.

**6015**

Oven cold

The HP 70310A precision frequency reference's Oven/Oscillator assembly has not reached normal operating temperature of approximately 85° C, and there is no external frequency reference applied. If the error appears at power-up when the instrument has been off for more than fifteen minutes and then disappears after the instrument has been on for fifteen to twenty minutes, the most probable causes are:

- the external power pack has an open fuse

## Hardware Warning Errors 6000 – 6999

- the external power pack is not properly connected
- the external power pack is faulty
- the HP 70310A precision frequency reference module has faulty hardware

---

**Note** At ambient temperatures below the specified operating range of the module, the oven may not be able to generate enough power to keep itself at approximately 85° C.

---

### 6016

freq reference

No internal oven/oscillator is present and no external frequency reference is applied.

### 6017

6214 GHz error

### 6018

PGA gain sum high

### 6019

PGA gain sum low

### 6802

Invalid cal data

Cause: The EAROM data installed during the manufacturing process may not be valid.

Cure: Return to Hewlett-Packard for servicing.

### 6805

Firmware Changed

Cause: The HP 70810B lightwave section firmware version is of a different date code than was installed in the module the last time it was turned on. All optical power calibration data previously stored by the user in module memory has been lost.

Cure: Perform a calibration on the HP 70810B lightwave section.

## Hardware Broken Errors 7000 – 7999

Hardware-broken errors occur when the spectrum analyzer might have faulty hardware.

### 7000

ROM Check error

Cause: The programmed checksum of the ROM does not agree with the computed checksum.

Cure: This could only be caused by a hardware failure. Return to Hewlett-Packard for servicing.

### 7001

L0 unlevelled

### 7002

First L0 unlevelled

### 7003

Second L0 unlocked

### 7004

300 MHz error

### 7005

321.4 MHz error

### 7006

21.4 MHz error

### 7007

Cal error

Calibration error.

### 7008

FFS handshake

Fractional-frequency-source handshake error

Cause: Communication has been lost to the Frequency Synthesizer portion of the 70900 module. This is very likely due to a hardware failure.

Cure: Return to Hewlett-Packard for servicing.

## **Hardware Broken Errors 7000 – 7999**

### **7009**

ROM 2 check error

### **7010**

FFS is unlocked

Fractional-frequency-source is unlocked

Cause: The frequency synthesizer is not able to acquire phase lock. If an external frequency reference is being used, verify that the frequency is accurate. If not, it is likely that the LO hardware has failed.

Cure: Correct external frequency reference accuracy or return to Hewlett-Packard for servicing.

### **7011**

125 KZ to FFS

125 kHz to fractional frequency source error

Cause: The internal 125 kHz reference signal is not at the correct power level on the Fractional Frequency Synthesizer assembly. This error will only occur on power up of the system, or when the TEST command is invoked, either from the front panel or remotely.

Cure: Return to Hewlett-Packard for servicing.

### **7012**

Cannot lock YTO

Cannot lock YIG-tuned oscillator

Cause: The Local Oscillator cannot acquire phase lock. If an external frequency reference is being used, verify that the frequency is accurate. If not, it is likely that the LO hardware has failed or is in need of calibration.

Cure: Verify the external reference frequency is operating correctly. If it is, return the LO module to Hewlett-Packard for servicing.

### **7013**

Can't finetune YTO

Cannot fine-tune YIG-tuned oscillator

Cause: The Local Oscillator cannot be adjusted for proper operation. Module service or calibration is required.

Cure: Return to Hewlett-Packard for servicing.



## 7014

12.5 MZ to YTO LK BD

12.5 MHz to YIG-tuned oscillator lock board error

Cause: The internal 12.5 MHz reference signal is not at the correct power level on the YTO phase lock board. This error will only occur on power up of the system, or when the TEST command is invoked, either from the front panel or remotely.

Cure: Return to Hewlett-Packard for servicing.

## 7015

YTO unlevelled YIG-tuned oscillator unlevelled

Cause: The leveling amplifier for the Local Oscillator output is not able to generate the proper output level. This error will only occur on power up of the system, or when the TEST command is invoked, either from the front panel or remotely.

Cure: Return to Hewlett-Packard for servicing.

## 7016

YTO is unlocked

YIG-tuned oscillator is unlocked

Cause: During a sweep of the local oscillator, phase lock was lost. If an external frequency reference is being used, its accuracy should be verified.

Cure: Verify external reference accuracy. If no external reference is being used, module service or calibration is necessary. Return to Hewlett-Packard for servicing.

## 7017

External ref (100 MZ)

External 100 MHz reference error

Cause: The detector used to automatically switch between an internal and external reference is not operating properly. This error will only occur on power up of the system, or when the TEST command is invoked, either from the front panel or remotely.

Cure: Return to Hewlett-Packard for servicing.

## 7018

50 MZ to sampler

50 MHz to sampler error

Cause: The internal 50 MHz sampler drive signal is not at the correct power level at the sampler. This error will only occur on power up of the system, or when the TEST command is invoked, either from the front panel or remotely.

Cure: Return to Hewlett-Packard for servicing.

## **Hardware Broken Errors 7000 – 7999**

### **7019**

300 MZ post fltr det

300 MHz post-filter detector error

Cause: The internal 300 MHz reference signal is not at the correct power level after the filter stage. This error will only occur on power up of the system, or when the TEST command is invoked, either from the front panel or remotely.

Cure: Return to Hewlett-Packard for servicing.

### **7020**

300 MZ AGC

300 MHz automatic gain control error

Cause: The gain control voltage on the 300 MHz signal has reached a limit. This error will only occur on power up of the system, or when the TEST command is invoked, either from the front panel or remotely.

Cure: Return to Hewlett-Packard for servicing.

### **7021**

600 MZ doubler level

600 MHz doubler level error

Cause: The 600 MHz internal reference signal amplitude is not correct. This error will only occur on power up of the system, or when the TEST command is invoked, either from the front panel or remotely.

Cure: Return to Hewlett-Packard for servicing.

### **7022**

Low idler range

Cause: The internal “Idler” oscillator did not acquire phase lock at the low end of its operating range. This error will only occur on power up of the system, or when the TEST command is invoked, either from the front panel or remotely.

Cure: Return to Hewlett-Packard for servicing.

### **7023**

High idler range

Cause: The internal “Idler” oscillator did not acquire phase lock at the high end of its operating range. This error will only occur on power up of the system, or when the TEST command is invoked, either from the front panel or remotely.

Cure: Return to Hewlett-Packard for servicing.

## 7024

Tune DAC Tune the digital-to-analog converter

Cause: The DAC that tunes the YIG oscillator is not operating properly. This error will only occur on power up of the system, or when the TEST command is invoked, either from the front panel or remotely.

Cure: Return to Hewlett-Packard for servicing.

## 7025

Decade span atten

Decade spanwidth attenuator error

Cause: The DAC that generates the scaled voltage for sweeping the YIG oscillator is not operating properly. This error will only occur on power up of the system, or when the TEST command is invoked, either from the front panel or remotely.

Cure: Return to Hewlett-Packard for servicing.

## 7026

Binary span atten

Binary span width attenuator error

Cause: The DAC that scales the tune voltage to sweep the YIG oscillator is not operating properly. This error will only occur on power up of the system, or when the TEST command is invoked, either from the front panel or remotely.

Cure: Return to Hewlett-Packard for servicing.

## 7027

Sweep dac

Digital-to-analog converter sweep error

Cause: The DAC that generates the system sweep ramp is not operating properly. This error will only occur on power up of the system, or when the TEST command is invoked, either from the front panel or remotely.

Cure: Return to Hewlett-Packard for servicing.

## 7028

Correction dac

Correction digital-to-analog converter

Cause: The DAC that fine tunes the phase lock circuit for the EYO is not operating properly. This error will only occur on power up of the system, or when the TEST command is invoked, either from the front panel or remotely.

Cure: Return to Hewlett-Packard for servicing.

## **Hardware Broken Errors 7000 – 7999**

### **7029**

Video proc: 0 volt

Video processor: 0 volt error

Cause: The video processor is not able to be properly calibrated to the 0 volt reference. This error will only occur on power up of the system, or when the TEST command is invoked, either from the front panel or remotely.

Cure: Return to Hewlett-Packard for servicing.

### **7030**

Video proc: 2 volt

Video processor: 2 volt error

Cause: The video processor is not able to be properly calibrated to the 2 volt reference. This error will only occur on power up of the system, or when the TEST command is invoked, either from the front panel or remotely.

Cure: Return to Hewlett-Packard for servicing.

### **7031**

Idler is unlocked

Cause: The local oscillator is not able to acquire phase lock.

Cure: Verify an external reference if applicable, otherwise the module will need to be returned to Hewlett-Packard for servicing.

### **7032**

Oven RF error

The HP 70310A precision frequency reference accessory oven is not providing a signal, is providing a low signal, or is providing a signal when it should not be.

### **7033**

Power supply error

One or more of the +5 V, -12 V, or -5 V voltages are out of spec.

### **7034**

Dist amp A error

Either the input to the HP 70310A precision frequency reference Distribution Amplifier "A" board assembly is beyond the specified operating range, or a hardware failure exists. The most probable causes are either: (a) one or more outputs are unlevelled due to faulty HP 70310A precision frequency reference hardware, or (b) an input that is too low in power.

### 7035

Dist amp B error

Either the input to the HP 70310A precision frequency reference Distribution Amplifier “B” board assembly is beyond the specified operating range, or a hardware failure exists. The most probable causes are either: (a) one or more outputs are unlevelled due to faulty HP 70310A precision frequency reference hardware, or (b) an input that is too low in power.

### 7036

HP-MSIB error

### 7041

FFS won't tune low

Fractional frequency source cannot tune low

Cause: The frequency synthesizer will not acquire lock at the lowest end of its operating range. This error will only occur on power up of the system, or when the TEST command is invoked from the front panel or remotely.

Cure: If an external frequency reference is being used, its accuracy should be verified. If the reference is good, there is a hardware failure. The module must be returned to Hewlett-Packard for servicing.

### 7042

FFS won't tune high

Fractional frequency source cannot tune high

Cause: The frequency synthesizer will not acquire lock at the highest end of its operating range. This error will only occur on power up, or when the TEST command is invoked, either remotely or from the front panel.

Cure: If an external frequency reference is being used, its accuracy should be verified. If the reference is good, there is a hardware failure. The module must be returned to Hewlett-Packard for servicing.

### 7043

Freq board adjust

Frequency-board adjust

Cause: The Frequency control board is out of calibration. This error will only occur on power up of the system, or when the TEST command is invoked, either from the front panel or remotely.

Cure: Return to Hewlett-Packard for servicing.

## Hardware Broken Errors 7000 – 7999

### 7044

YTO tuning range

YIG-tuned oscillator tuning range

Cause: The YIG oscillator is not able to be tuned over the necessary range. This error will only occur on power up of the system, or when the TEST command is invoked, either from the front panel or remotely.

Cure: Return to Hewlett-Packard for servicing.

### 7045

10 MHz out error

The HP 70310A precision frequency reference 10 MHz OUT signal is absent or too low. The most probable cause is faulty HP 70310A precision frequency reference hardware.

### 7046

Illegal bandslct cde

Illegal band-select code

Cause: The Internal/External Frequency reference switch was set to an illegal position

Cure: Please document all steps taken that led to this error condition and contact your HP representative.

### 7047

RAM failure

Cause: The RAM self test detected a failure in the system RAM.

Cure: Return to Hewlett-Packard for servicing.

### 7048

FFS won't unlock

Cause: The module self test tunes the synthesizer to a frequency outside its operating range to verify the lock detector is operating properly. The synthesizer never indicated an unlock condition.

Cure: Return to Hewlett-Packard for servicing.

### 7050

Hardware config fail

Cause: On power up of the system a test of the hardware is made to verify the hardware matches the model revision ("A" or "B"). If this test is not conclusive, this error will occur.

Cure: If an external frequency reference is being used, verify the proper accuracy. Return to Hewlett-Packard for servicing.

**7073**

Tune+Span disconnect

**7074**

Discriminator unlock

**7075**

LOLA unlevelled

**7076**

MULT unlevelled

**7077**

YTF drive error

**7078**

Tune/Span error

**7079**

EEPROM check error

Cause: This hardware error occurs when the controller has determined that the EEPROM memory is invalid. Either the EEPROM is defective or the data in the EEPROM must be reloaded.

Cure: Return to Hewlett-Packard for servicing.

**7801**

Optical atten failed

Cause: The optical attenuator cannot achieve a given setting. Automatic periodic zeroing temporarily modifies the attenuator setting, so this error can occur without a user attempt to change attenuation.

Cure: Return to Hewlett-Packard for servicing.

**7802**

ADC error

Cause: The analog digital converter (ADC) in the power meter is not responding.

Cure: Return to Hewlett-Packard for servicing.

## **Hardware Broken Errors 7000 – 7999**

### **7803**

Power meter failed

Cause: The power meter circuitry has failed during the self test.

Cure: Return to Hewlett-Packard for servicing.

### **7804**

Self test failed

Cause: The self test checks the functionality of the power meter and optical attenuator.

Cure: Return to Hewlett-Packard for servicing.

### **7805**

Zeroing error

Cause: Photodiode dark current cannot be nulled.

Cure: Check for a hardware problem such as excessive noise on the photodiode, or catastrophic failure in the power meter circuitry.



## Computation Errors 8000 – 8999

Computation errors occur during illegal math operations. For all of these computation errors, use the DEBUG command to locate the programming error. Refer to the *HP 70000 Modular Spectrum Analyzer Programming Manual*.

### 8000

Divide by zero

### 8001

Float pt overflow

Floating-point overflow. Absolute value of number exceeds  $1.797,693,134,862,315 \times 10^{308}$ .

### 8002

Log of zero

### 8003

Log of negative

### 8004

Integer overflow

Number is less than  $-32,768$  or greater than  $32,767$ .

### 8005

Square root error

### 8006

Modulus of zero

### 8999

Float pt underflow

Floating-point underflow. Number is between 0 and  $\pm 2.225,073,858,507,202 \times 10^{-308}$ .

---

## **Factory-Use Only Errors 9000 – 9999**

These errors are for factory use only. If any of the 9000 – 9999 errors occurs,

1. Record the error number and the hexadecimal code.
2. Record all events that led up to the occurrence of the error message.
3. Record the HP model numbers of the modules in the system.
4. Record the firmware version.
5. Contact the nearest HP Sales and Service Office for assistance.

# Index

---

## 1

- 100 MHz
  - HP 70310A precision frequency reference, 3-85
- 100 MHz IN
  - HP 70900B local oscillator source, 3-89
- 100 MHz IN, HP 70900B local oscillator source, 1-6
- 10 MHz
  - HP 70310A precision frequency reference, 3-85
- 10 MHz out error, hardware broken error, 7045, 5-32
- 125 KZ to FFS, hardware broken error, 7011, 5-26
- 12.5 MZ to YT0 LK BD, hardware broken error, 7014, 5-27
- 1st LO IN
  - HP 70904A RF section, 3-92
  - HP 70905A RF section, 3-93
  - HP 70905B RF section, 3-97
  - HP 70906A RF section, 3-95
  - HP 70906B RF section, 3-97
  - HP 70908A RF section, 3-100
  - HP 70909A RF section, 3-102
  - HP 70910A RF section, 3-102
- 1st LO OUT
  - HP 70904A RF section, 3-92
  - HP 70905A RF section, 3-93
  - HP 70905B RF section, 3-97
  - HP 70906A RF section, 3-95
  - HP 70906B RF section, 3-97
  - HP 70908A RF section, 3-100
  - HP 70909A RF section (Front Panel), 3-102
  - HP 70909A RF section (Rear Panel), 3-102
  - HP 70910A RF section (Front Panel), 3-102
  - HP 70910A RF section (Rear Panel), 3-102

## 2

- 21.4MHz daisy chain, diagnostics error, 0007, 5-3
- 21.4 MHz error, hardware broken error, 7006, 5-25
- 21.4 MHz IF
  - HP 70903A IF section, 3-91
- 21.4 MHz IN

- HP 70902A IF section, 3-90
- HP 70903A IF section, 3-91
- 21.4MHz input cable, diagnostics error, 0020, 5-4
- 21.4MHz input cable, diagnostics error, 0030, 5-6
- 21.4 MHz OUT
  - HP 70904A RF section, 3-92
  - HP 70905A RF section, 3-93
  - HP 70905B RF section, 3-97
  - HP 70906A RF section, 3-95
  - HP 70906B RF section, 3-97
  - HP 70908A RF section, 3-100
  - HP 70909A RF section, 3-102
  - HP 70910A RF section, 3-102

## 3

- 300 MHz error, hardware broken error, 7004, 5-25
- 300 MHz IN
  - HP 70904A RF section, 3-92
  - HP 70905A RF section, 3-93
  - HP 70905B RF section, 3-97
  - HP 70906A RF section, 3-95
  - HP 70906B RF section, 3-97
  - HP 70908A RF section, 3-100
  - HP 70909A RF section, 3-102
  - HP 70910A RF section, 3-102
- 300 MHz OUT
  - HP 70900B local oscillator source, 1-4, 3-89
- 300 MHz OUT 1 and 2, HP 70900B local oscillator source, 1-6
- 300 MZ AGC, hardware broken error, 7020, 5-28
- 300 MZ post fltr det, hardware broken error, 7019, 5-28
- 321.4 MHz error, hardware broken error, 7005, 5-25
- 321.4 MHz IF IN
  - HP 70905A RF section, 3-93
  - HP 70905B RF section, 3-97
  - HP 70906A RF section, 3-95
  - HP 70906B RF section, 3-97
- 321.4 MHz IF OUT
  - HP 70905A RF section, 3-93

- HP 70905B RF section, 3-97
- HP 70906A RF section, 3-95
- HP 70906B RF section, 3-97
- HP 70908A RF section, 3-100
- HP 70909A RF section, 3-102
- HP 70910A RF section, 3-102
- 3478A MULTIMETER requires calibration.,  
error and status message, 4-59

## 4

- 400 Hz
  - operation, 1-17
  - option, 1-17
  - power-source, 1-17

## 5

- 50 MZ to sampler, hardware broken error,  
7018, 5-27

## 6

- 600 MZ doubler level, hardware broken  
error, 7021, 5-28
- 60 Hz power-source, 1-17
- 6214 GHz error, hardware warning error,  
6017, 5-24

## A

- A1—A5, switches, 2-13
- A6—A8, switches, 2-13
- A6 RAM checksum (battery), hardware  
warning error, 6002, 5-22
- Aborted, error and status message, 4-59
- access area, HP-IB, 2-4
- accessories, 1-8
  - HP 70900B local oscillator source, 1-8
  - operation verification, 4-5
  - required, 4-6
  - shipped with module, 1-8
- ac power cords, 1-20
- ACT LED, HP 70900B local oscillator source,  
1-4
- ADC error, hardware broken error, 7802,  
5-33
- additional cables, 1-19
- Address
  - is HP-IB controller address., error and  
status message, 4-60
  - matches system disk drive., error and  
status message, 4-60
  - not in acceptable range., error and status  
message, 4-60
- addressing
  - binary and decimal equivalent, 2-3
  - elements, 2-4
  - HP-MSIB/HP-IB, 2-1

- least significant bits, 2-3
- most significant bits, 2-3
- of display, 2-4
- order requirements, 2-7
- override, 2-11
- switches, 2-4
- addressing criteria
  - HP 70300A RF tracking generator, 2-9
  - HP 70301A microwave tracking generator,  
2-9
  - HP 70310A precision frequency reference,  
2-9
  - HP 70600A preselector, 2-8
  - HP 70601A preselector, 2-8
  - HP 70620A/B preamplifier, 2-9
  - HP 70621A preamplifier, 2-9
  - HP 70700A digitizer, 2-8
  - HP 70810B lightwave section, 2-9
  - HP 70900B local oscillator source, 2-8
  - HP 70902A IF section, 2-8
  - HP 70903A IF section, 2-8
  - HP 70907A/B external millimeter interface  
module, 2-8
  - HP 70911A WB IF section, 2-8
  - RF section, 2-8
- address map
  - default, 2-7
  - HP 71100C modular spectrum analyzer,  
2-20
  - HP 71100C modular spectrum analyzer with  
HP 70300A RF tracking generator,  
2-28
  - HP 71100C modular spectrum analyzer  
with HP 70700A digitizer, 2-24
  - HP 71100C modular spectrum analyzer  
with HP 70903A IF section, 2-22
  - HP 71100C modular spectrum analyzer with  
HP 70903A IF section and HP 70700A  
digitizer, 2-26
  - HP 71100P modular spectrum analyzer,  
2-56
  - HP 71100P modular spectrum analyzer with  
HP 70300A RF tracking generator,  
2-64
  - HP 71100P modular spectrum analyzer  
with HP 70700A digitizer, 2-60
  - HP 71100P modular spectrum analyzer  
with HP 70903A IF section, 2-58
  - HP 71100P modular spectrum analyzer with  
HP 70903A IF section and HP 70700A  
digitizer, 2-62
  - HP 71200C modular spectrum analyzer,  
2-30
  - HP 71200C modular spectrum analyzer  
deleting HP 70902A IF section, 2-34

HP 71200C modular spectrum analyzer  
   deleting HP 70905A RF section, 2-36,  
   2-38  
 HP 71200C modular spectrum analyzer  
   with HP 70903A IF section, 2-32  
 HP 71200P modular spectrum analyzer,  
   2-66  
 HP 71200P modular spectrum analyzer  
   deleting HP 70902A IF section, 2-70  
 HP 71200P modular spectrum analyzer  
   deleting HP 70905A RF section, 2-72,  
   2-74  
 HP 71200P modular spectrum analyzer  
   with HP 70903A IF section, 2-68  
 HP 71209A microwave spectrum analyzer,  
   2-40  
 HP 71209P microwave spectrum analyzer,  
   2-77  
 HP 71210C microwave spectrum analyzer,  
   2-42  
 HP 71210P microwave spectrum analyzer,  
   2-79  
 HP 71210P microwave spectrum analyzer  
   with HP 70907B external millimeter  
   interface module, 2-81  
 HP 71400C lightwave signal analyzer, 2-44  
 HP 71400C lightwave signal analyzer with  
   HP 70300A RF tracking generator  
   and HP 70301A microwave tracking  
   generator, 2-46  
 HP 71401C lightwave signal analyzer, 2-49  
 HP 71401C lightwave signal analyzer with  
   an HP 70300A RF tracking generator,  
   2-51  
   protocol, 2-3  
 address matrix, 2-3  
   master/slave, 2-5  
   sub-master, 2-5  
 address switches  
   column address, 2-10  
   HP 70004A color display, 2-14  
   HP 70206A system graphics display, 2-14  
   HP 70900B local oscillator source, 2-12  
   master, 2-11  
   row address, 2-10  
   slave element, 2-12  
 Adjust Inst, error and status message, 4-59  
 A Hardware Selected, operating error,  
   2011, 5-14  
 Ampcr/span too large, operating error,  
   2050, 5-20  
 angle brackets, 1-13  
 ASSIGN KEYBOARD, display menu key, 2-4  
 ASSIGN WINDOW, display menu key, 2-4  
 asterisk (\*), error messages, with an, 5-2

Attempt to  
   close file \_\_\_\_ failed., error and status  
   message, 4-60  
   create file \_\_\_\_ failed., error and status  
   message, 4-60  
   Edit Mass Storage failed., error and status  
   message, 4-60  
   store Mass Storage failed., error and status  
   message, 4-60  
 ATTENUATOR Section, diagnostics error,  
   0063, 5-10  
 automatic assignment, display-response area,  
   2-4  
 automatic slave configuration, 2-7  
 AUX OUT  
   HP 70902A IF section, 3-90

## B

bad file, operating error, 2055, 5-21  
 Bad IF/ENDIF nesting, operating error,  
   2021, 5-16  
 Bad instrument address in equipment list.  
   Address matches controller., error and  
   status message, 4-61  
 bad revision, operating error, 2056, 5-21  
 bad volume, operating error, 2058, 5-21  
 Battery failed, operating error, 2049, 5-20  
 before operation, 1-2  
 B Hardware Selected, operating error,  
   2012, 5-14  
 binary address, decimal equivalent, 2-3  
 Binary span atten, hardware broken error,  
   7026, 5-29  
 BIN files, 4-2  
 blown fuse, 1-17

## C

cable connections  
   HP 70001A mainframe to HP 70004A color  
   display, 2-16  
   HP 71100C modular spectrum analyzer,  
   2-21  
   HP 71100C modular spectrum analyzer with  
   an HP 70300A RF tracking generator,  
   2-29  
   HP 71100C modular spectrum analyzer  
   with HP 70700A digitizer, 2-26  
   HP 71100C modular spectrum analyzer  
   with HP 70903A IF section, 2-23  
   HP 71100C modular spectrum analyzer with  
   HP 70903A IF section and HP 70700A  
   digitizer, 2-27  
   HP 71100P modular spectrum analyzer,  
   2-57

HP 71100P modular spectrum analyzer with an HP 70300A RF tracking generator, 2-65  
 HP 71100P modular spectrum analyzer with HP 70700A digitizer, 2-61  
 HP 71100P modular spectrum analyzer with HP 70903A IF section, 2-59  
 HP 71100P modular spectrum analyzer with HP 70903A IF section and HP 70700A digitizer, 2-63  
 HP 71200C modular spectrum analyzer, 2-31  
 HP 71200C modular spectrum analyzer deleting HP 70902A IF section, 2-35  
 HP 71200C modular spectrum analyzer deleting HP 70905A RF section, 2-37, 2-39  
 HP 71200C modular spectrum analyzer with HP 70903A IF section, 2-33  
 HP 71200P modular spectrum analyzer, 2-67  
 HP 71200P modular spectrum analyzer deleting HP 70902A IF section, 2-71  
 HP 71200P modular spectrum analyzer deleting HP 70905A RF section, 2-73, 2-76  
 HP 71200P modular spectrum analyzer with HP 70903A IF section, 2-69  
 HP 71201A Option 001 modular spectrum analyzer deleting HP 70905A RF section, 2-40  
 HP 71209A microwave spectrum analyzer, 2-41  
 HP 71209P microwave spectrum analyzer, 2-78  
 HP 71210C microwave spectrum analyzer, 2-43  
 HP 71210P microwave spectrum analyzer, 2-80  
 HP 71210P microwave spectrum analyzer with HP 70907B external millimeter interface module, 2-82  
 HP 71400C lightwave signal analyzer, 2-45  
 HP 71400C lightwave signal analyzer with HP 70300A RF tracking generator and HP 70301A microwave tracking generator, 2-48  
 HP 71401C lightwave signal analyzer, 2-50  
 HP 71401C lightwave signal analyzer with an HP 70300A RF tracking generator, 2-52  
 cables, system power, 1-19  
 Cal error, hardware broken error, 7007, 5-25  
 Calibration atten, diagnostics error, 0028, 5-6  
 Calibration atten, diagnostics error, 0038, 5-7  
 Calibration data  
   for \_\_\_\_ is blank for some frequencies listed., error and status message, 4-61  
   for \_\_\_\_ is greater than maximum range of \_\_\_\_\_., error and status message, 4-61  
   for \_\_\_\_ is less than minimum range of \_\_\_\_\_., error and status message, 4-61  
   for \_\_\_\_ with serial number \_\_\_\_ is not found on the current Operating disk., error and status message, 4-61  
   frequency exceed acceptable limits., error and status message, 4-61  
   frequency is greater than maximum range of \_\_\_\_\_., error and status message, 4-61  
   frequency is less than minimum range of \_\_\_\_\_., error and status message, 4-61  
 Calibrator  
   Amplitude Accuracy for HP 70900A/B local oscillator source, 4-28, 4-30  
   Amplitude Accuracy using HP 70907A external millimeter interface module, 4-28, 4-50  
   Amplitude Accuracy using HP 70907B external millimeter interface module, 4-28, 4-51  
   Frequency Accuracy for HP 70900A/B local oscillator source, 4-28, 4-29  
 CALIBRATOR  
   HP 70900B local oscillator source, 3-89  
 Cal/I.F. cables?, diagnostics error, 0042, 5-8  
 Cal input incorrect?, diagnostics error, 0062, 5-10  
 CAL POWER lvl err, operating error, 2041, 5-19  
 Cannot lock YT0, hardware broken error, 7012, 5-26  
 Cannot test 70905/6B, diagnostics error, 0061, 5-10  
 Can't finetune YT0, hardware broken error, 7013, 5-26  
 certification label, 1-10  
 certification, system calibration, 1-10  
 changes, test limit, 4-58  
 characteristics  
   HP 70310A precision frequency reference, 3-85  
   HP 70600A preselector, 3-87  
   HP 70601A preselector, 3-87

- HP 70810B lightwave section, 3-88
- HP 70810B Option 850 lightwave section, 3-88
- HP 70900B local oscillator source, 3-89
- HP 70902A IF section, 3-90
- HP 70903A IF section, 3-91
- HP 70904A RF section, 3-92
- HP 70905A RF section, 3-93
- HP 70905B RF section, 3-97
- HP 70906A RF section, 3-95
- HP 70906B RF section, 3-97
- HP 70907A external millimeter interface module, 3-98
- HP 70907B external millimeter interface module, 3-99
- HP 70908A RF section, 3-100
- HP 70909A RF section, 3-102
- HP 70910A RF section, 3-102
- module inputs and outputs, 3-84
- Check mixer bias, operating error, 2026, 5-17
- cleaning, display screen, 1-21
- Cmd out of sequence, operating error, 2010, 5-14
- COLUMNS 1–5, switches, 2-12
- command screen menu keys, 4-11
- Command syntax error, operating error, 2029, 5-17
- common edit and command screen menu keys, 4-11
- computation error
  - 8000, Divide by zero, 5-35
  - 8001, Float pt overflow, 5-35
  - 8002, Log of zero, 5-35
  - 8003, Log of negative, 5-35
  - 8004, Integer overflow, 5-35
  - 8005, Square root error, 5-35
  - 8006, Modulus of zero, 5-35
  - 8999, Float pt underflow, 5-35
- computation errors 8000 – 8999, 5-35
- computer
  - hardware compatibility, 4-2
  - language compatibility, 4-2
- conditions at power-on, 1-10
- Confidence test failed, hardware warning error, 6008, 5-23
- Confidence test passed, hardware warning error, 6001, 5-22
- configuring the hardware, 4-8
- Correction dac, hardware broken error, 7028, 5-29
- CRYSTAL bandwidths, diagnostics error, 0023, 5-5
- Current zero expired., error and status message, 4-59

## D

- DANGER notices, 1-2, 1-9, 1-16, 1-17
- Decade span atten, hardware broken error, 7025, 5-29
- decimal equivalent, binary address, 2-3
- default
  - addressing, 2-7
  - address map, 2-7
  - HP-IB address, 2-4, 2-12
- definition
  - characteristics*, 3-1
  - defining element, 2-6
  - error messages, 5-1
  - independent elements, 2-3, 2-6
  - limited cal, 4-7
  - master, 2-3
  - nominal value, 3-1
  - single tests, 4-7
  - slave, 2-3, 2-4
  - slave area, 2-5
  - softkeys, 1-1
  - specifications, 3-1
  - sub-master, 2-3, 2-5
  - typical performance, 3-1
- diagnostics error
  - 0001, NO LO?, 5-2
  - 0002, HP-MSIB addr 70902, 5-2
  - 0003, HP-MSIB addr 70903, 5-2
  - 0004, HP-MSIB addr 70904, 5-2
  - 0005, HP-MSIB addr 70905/6, 5-3
  - 0007, 21.4MHz daisy chain, 5-3
  - 0008, NO RF SECTION?, 5-3
  - 0009, NO I.F. SECTION?, 5-3
  - 0010, HP-MSIB addr 70907, 5-3
  - 0011, No EMIM Section?, 5-3
  - 0012, HP-MSIB addr 70600, 5-4
  - 0013, No PRESELECTOR?, 5-4
  - 0014, Incorrect System, 5-4
  - 0015, HP-MSIB addr 70700, 5-4
  - 0020, 21.4MHz input cable, 5-4
  - 0021, Video output cable, 5-5
  - 0022, LC bandwidths, 5-5
  - 0023, CRYSTAL bandwidths, 5-5
  - 0024, Problem/ampl low?, 5-5
  - 0025, Step gain amplifier, 5-5
  - 0026, Res BW-accuracy, 5-5
  - 0027, Res BW-amplitude, 5-6
  - 0028, Calibration atten, 5-6
  - 0029, Log amplifier, 5-6
  - 0030, 21.4MHz input cable, 5-6
  - 0031, Video output cable, 5-6
  - 0032, LC board, 5-6
  - 0033, Log board, 5-7
  - 0034, Problem/ampl low?, 5-7

0035, Step gain amplifier, 5-7  
 0036, Res BW-accuracy, 5-7  
 0037, Res BW-amplitude, 5-7  
 0038, Calibration atten, 5-7  
 0039, Log amplifier, 5-8  
 0040, Tune+Span, 5-8  
 0041, RF attenuator, 5-8  
 0042, Cal/I.F. cables?, 5-8  
 0043, Problem/ampl low?, 5-8  
 0044, Low/high band switch, 5-9  
 0045, RF attenuator, 5-9  
 0046, Step gain amplifier, 5-9  
 0050, Res BW -- CF, 5-9  
 0051, Res BW -- CF ampl, 5-9  
 0052, Res BW -- CF ampl, 5-9  
 0053, Res BW -- CF ampl, 5-10  
 0060, RF attenuator, 5-10  
 0061, Cannot test 70905/6B, 5-10  
 0062, Cal input incorrect?, 5-10  
 0063, ATTENUATOR Section, 5-10  
 0064, RF Switch 1, 5-11  
 0065, RF Switch 2, 5-11  
 0066, RF Switch 3, 5-11  
 0067, RF Switch 4, 5-11  
 0068, RF Switch 1, 5-11  
 0069, RF Switch 2, 5-11  
 0070, RF Preamplifier, 5-12  
 direct mail-order system, 2-83  
 directory full, operating error, 2059, 5-21  
 Discriminator unlock, hardware broken  
 error, 7074, 5-33  
 Disk file is full, no longer duplicating output.,  
 error and status message, 4-59  
 display  
   A1—A5, switches, 2-13  
   A6—A8, switches, 2-13  
   address switches, 2-13  
   HP-IB ON/OFF, switches, 2-13  
   response area, 2-4  
   screen cleaning, 1-21  
   SYSTEM CONTROLLER, switches, 2-13  
   TALK ONLY, switches, 2-13  
   TEST MODE, switches, 2-13  
 Displayed Average Noise  
   using HP 70902A IF section, 4-28, 4-46  
   using HP 70903A IF section, 4-28, 4-46  
 DISPLAY, function keys, 1-4  
 display menu key  
   ASSIGN KEYBOARD, 2-4  
   ASSIGN WINDOW, 2-4  
   REPORT ERRORS, 2-4  
   SELECT INSTRUMENT, 2-4  
 display-response area  
   automatic assignment, 2-4  
   manual assignment, 2-4  
 Dist amp A error, hardware broken error,  
 7034, 5-30  
 Dist amp B error, hardware broken error,  
 7035, 5-31  
 distribution amplifier input  
   HP 70310A precision frequency reference,  
   3-85  
 distribution amplifier output  
   HP 70310A precision frequency reference,  
   3-85  
 Divide by zero, computation error, 8000,  
 5-35  
 Duplicate Address, error and status message,  
 4-66  
 Duplicate identifier, operating error,  
 2014, 5-15  
 Duplication may exclude specific tests., error  
 and status message, 4-66  
 DUT  
   does not have an address., error and status  
   message, 4-61  
   was not at address in the equipment list.  
   DUT was expected at address \_\_\_\_\_,  
   error and status message, 4-62  
   was not found at address in equipment  
   list., error and status message, 4-62  
**E**  
 EAROM unprotected, hardware warning  
 error, 6000, 5-22  
 editing  
   calibration data, 4-18  
   mass storage menu information, 4-14  
 edit screen menu keys, 4-11  
 EEPROM check error, hardware broken  
 error, 7079, 5-33  
 electrostatic discharge (ESD), 1-22  
 element, MMS term, 2-1, 2-2  
 equipment, 4-27  
 Equipment  
   address matches external disk drive., error  
   and status message, 4-62  
   does not have an address., error and status  
   message, 4-62  
   list is not acceptable., error and status  
   message, 4-59  
   list shows no analyzer to test., error and  
   status message, 4-59  
   Menu data not found on \_\_\_\_\_, error and  
   status message, 4-62  
 equipment menu, 4-17, 4-25  
   command screen, 4-18  
   edit screen, 4-17  
 equipment setup, 4-27



Err in MDOC response, hardware warning error, 6010, 5-23  
 ERR LED, HP 70900B local oscillator source, 1-4  
 <\*>, error and status message, 4-59  
 <<<<, error and status message, 4-59  
 error and status messages  
     <\*>, 4-59  
     <<<<, 4-59  
 3478A MULTIMETER requires calibration., 4-59  
 Aborted, 4-59  
 Address is HP-IB controller address., 4-60  
 Address matches system disk drive., 4-60  
 Address not in acceptable range., 4-60  
 Adjust Inst, 4-59  
 Attempt to close file \_\_\_\_ failed., 4-60  
 Attempt to create file \_\_\_\_ failed., 4-60  
 Attempt to Edit Mass Storage failed., 4-60  
 Attempt to store Mass Storage failed., 4-60  
 Bad instrument address in equipment list.  
     Address matches controller., 4-61  
 Calibration data for \_\_\_\_ is blank for some frequencies listed., 4-61  
 Calibration data for \_\_\_\_ is greater than maximum range of \_\_\_\_\_, 4-61  
 Calibration data for \_\_\_\_ is less than minimum range of \_\_\_\_\_, 4-61  
 Calibration data for \_\_\_\_ with serial number \_\_\_\_ is not found on the current Operating disk., 4-61  
 Calibration data frequency exceed acceptable limits., 4-61  
 Calibration data frequency is greater than maximum range of \_\_\_\_\_, 4-61  
 Calibration data frequency is less than minimum range of \_\_\_\_\_, 4-61  
 Current zero expired., 4-59  
 Disk file is full, no longer duplicating output., 4-59  
 Duplicate Address, 4-66  
 Duplication may exclude specific tests., 4-66  
 DUT does not have an address., 4-61  
 DUT was not at address in the equipment list. DUT was expected at address \_\_\_\_\_, 4-62  
 DUT was not found at address in equipment list., 4-62  
 Equipment address matches external disk drive., 4-62  
 Equipment does not have an address., 4-62  
 Equipment list is not acceptable., 4-59  
 Equipment list shows no analyzer to test., 4-59  
 Equipment Menu data not found on \_\_\_\_\_, 4-62  
 ERROR XXX in XXXXX \_\_\_\_\_, 4-62  
 File \_\_\_\_ not found while assigning I/O path., 4-62  
 FORMAT ERROR: Observe date format and character position., 4-64  
 Hdw Broken, 4-64  
 Incorrect disk found. \_\_\_\_ required., 4-62  
 Initializing the HP-IB system per the Equipment Menu., 4-64  
 \_\_\_\_ is a undefined subprogram., 4-62  
 KEYBOARD SYSTEM CRASH WITH KEYBOARD: \_\_\_\_\_, 4-64  
 Logging errors to ERRORLOG failed.  
     Operating Disk is write protected., 4-64  
 Media not initialized., 4-64  
 No case for the sensor in the 8902A driver!, 4-64  
 No disk copy of output found., 4-65  
 Non-responding HP-IB address., 4-60  
 Parameter Menu data file not found on \_\_\_\_\_, 4-63  
 Parameter Menu data not found on \_\_\_\_\_, 4-63  
 Passed, 4-65  
 PAUSED. PRESS CONTINUE., 4-65  
 PRGM ERROR, 4-65  
 Read \_\_\_\_ data from file \_\_\_\_ failed., 4-63  
 Reading errors from ERRORLOG failed.  
     Check disk at \_\_\_\_\_, 4-65  
 Return to Equipment Menu to enter serial number for \_\_\_\_\_, 4-65  
 Search for volume label \_\_\_\_ unsuccessful., 4-60  
 Selected system under test is \_\_\_\_; but the software supports the \_\_\_\_ system., 4-63  
 Sensor model # \_\_\_\_ not supported., 4-63  
 Setup Error , 4-65  
 Short Pass, 4-65  
 Some devices listed as "Available" require serial numbers., 4-60  
 Some Model #'s are not supported. (See Edit Screen)., 4-59  
 String is too long. It has been truncated., 4-66  
 Test can not be done., 4-65  
 Testing \_\_\_\_ dd\_mmm\_yyyy., 4-65  
 TEST\_LIST is not compatible., 4-65  
 The 436A is in lowest range, waiting 10 seconds., 4-66

The 8902A needs repair (Error 6)., 4-66

The \_\_\_\_\_ at address \_\_\_\_\_ was not found on HP-IB., 4-66

The controller does not have sufficient memory., 4-65

The correct Power Sensor has not been detected. Connect the \_\_\_\_\_ or Abort the test., 4-63

The DUT must have an HP-IB address., 4-66

The Operating Disk is write protected., 4-63

THIS COLUMN CAN NOT BE EDITED., 4-66

This test can not be selected because of missing ETE., 4-66

Timed Out , 4-66

Too many Cal Data frequencies were eliminated. There must be at least two frequencies., 4-63

\_\_\_\_\_ was not located., 4-64

Write \_\_\_\_\_ data to file \_\_\_\_\_ failed., 4-64

Write protected., 4-66

Wrong device at specified address. DUT was expected at address \_\_\_\_\_, 4-64

error messages, 4-7

0001, diagnostics error, 5-2

0002, diagnostics error, 5-2

0003, diagnostics error, 5-2

0004, diagnostics error, 5-2

0005, diagnostics error, 5-3

0007, diagnostics error, 5-3

0008, diagnostics error, 5-3

0009, diagnostics error, 5-3

0010, diagnostics error, 5-3

0011, diagnostics error, 5-3

0012, diagnostics error, 5-4

0013, diagnostics error, 5-4

0014, diagnostics error, 5-4

0015, diagnostics error, 5-4

0020, diagnostics error, 5-4

0021, diagnostics error, 5-5

0022, diagnostics error, 5-5

0023, diagnostics error, 5-5

0024, diagnostics error, 5-5

0025, diagnostics error, 5-5

0026, diagnostics error, 5-5

0027, diagnostics error, 5-6

0028, diagnostics error, 5-6

0029, diagnostics error, 5-6

0030, diagnostics error, 5-6

0031, diagnostics error, 5-6

0032, diagnostics error, 5-6

0033, diagnostics error, 5-7

0034, diagnostics error, 5-7

0035, diagnostics error, 5-7

0036, diagnostics error, 5-7

0037, diagnostics error, 5-7

0038, diagnostics error, 5-7

0039, diagnostics error, 5-8

0040, diagnostics error, 5-8

0041, diagnostics error, 5-8

0042, diagnostics error, 5-8

0043, diagnostics error, 5-8

0044, diagnostics error, 5-9

0045, diagnostics error, 5-9

0046, diagnostics error, 5-9

0050, diagnostics error, 5-9

0051, diagnostics error, 5-9

0052, diagnostics error, 5-9

0053, diagnostics error, 5-10

0060, diagnostics error, 5-10

0061, diagnostics error, 5-10

0062, diagnostics error, 5-10

0063, diagnostics error, 5-10

0064, diagnostics error, 5-11

0065, diagnostics error, 5-11

0066, diagnostics error, 5-11

0067, diagnostics error, 5-11

0068, diagnostics error, 5-11

0069, diagnostics error, 5-11

0070, diagnostics error, 5-12

2000, operating error, 5-13

2001, operating error, 5-13

2002, operating error, 5-13

2003, operating error, 5-13

2004, operating error, 5-13

2005, operating error, 5-13

2006, operating error, 5-13

2007, operating error, 5-14

2008, operating error, 5-14

2009, operating error, 5-14

2010, operating error, 5-14

2011, operating error, 5-14

2012, operating error, 5-14

2013, operating error, 5-15

2014, operating error, 5-15

2015, operating error, 5-15

2016, operating error, 5-15

2018, operating error, 5-15

2019, operating error, 5-16

2020, operating error, 5-16

2021, operating error, 5-16

2022, operating error, 5-16

2023, operating error, 5-16

2024, operating error, 5-16

2025, operating error, 5-16

2026, operating error, 5-17

2027, operating error, 5-17

2028, operating error, 5-17



7802, hardware broken error, 5-33  
 7803, hardware broken error, 5-34  
 7804, hardware broken error, 5-34  
 7805, hardware broken error, 5-34  
 8000, computation error, 5-35  
 8001, computation error, 5-35  
 8002, computation error, 5-35  
 8003, computation error, 5-35  
 8004, computation error, 5-35  
 8005, computation error, 5-35  
 8006, computation error, 5-35  
 8999, computation error, 5-35  
 computation, 8000 – 8999, 5-35  
 factory-use only, 9000 – 9999, 5-36  
 hardware broken, 7000 – 7999, 5-25  
 hardware warning, 6000 – 6999, 5-22  
 not listed, 5-1  
 operating, 2000 – 2999, 5-13  
 remote retrieval, 5-1  
 system diagnostics 0001 – 0070, 5-2  
 user application, 0001 – 0999, 5-2  
 with an asterisk (\*), 5-2  
 ERROR XXX in XXXXX \_\_\_\_\_, error and  
 status message, 4-62  
 ESD (electrostatic discharge), 1-22, 1-23  
 executive disk, 4-1  
 external power pack, 1-21  
 External ref (100 MZ), hardware broken  
 error, 7017, 5-27  
 external-reference signal  
 input requirements, 3-86  
 external test equipment, 4-5  
 EXTERNAL TRIGGER IN  
 HP 70900B local oscillator source, 3-89  
 EXT REF  
 HP 70310A precision frequency reference,  
 3-86  
 EXT TRIG IN, HP 70900B local oscillator  
 source, 1-6

**F**

factory-use only errors 9000 – 9999, 5-36  
 FFS handshake, hardware broken error,  
 7008, 5-25  
 FFS is unlocked, hardware broken error,  
 7010, 5-26  
 FFS Loop Unlock LED, HP 70900B local  
 oscillator source, 1-4  
 FFS won't tune high, hardware broken  
 error, 7042, 5-31  
 FFS won't tune high, hardware warning  
 error, 6004, 5-22  
 FFS won't tune low, hardware broken  
 error, 7041, 5-31

FFS won't tune low, hardware warning  
 error, 6003, 5-22  
 FFS won't unlock, hardware broken error,  
 7048, 5-32  
 File already exists, operating error,  
 2052, 5-20  
 File not found, operating error, 2051, 5-20  
 File \_\_\_\_ not found while assigning I/O path.,  
 error and status message, 4-62  
 Firmware Changed, hardware warning error,  
 6805, 5-24  
 First L0 unlevelled, hardware broken  
 error, 7002, 5-25  
 Float pt overflow, computation error,  
 8001, 5-35  
 Float pt underflow, computation error,  
 8999, 5-35  
 FORMAT ERROR  
 Observe date format and character  
 position., error and status message,  
 4-64  
 Freq board adjust, hardware broken error,  
 7043, 5-31  
 freq reference, hardware warning error,  
 6016, 5-24  
 Frequency Response  
 for HP 70600A preselector, 4-28, 4-33,  
 4-40  
 for HP 70601A preselector, 4-28, 4-33,  
 4-40  
 for HP 70620B preamplifier, 4-28, 4-40  
 for HP 70904A RF section, 4-31  
 for HP 70904A RF section and HP 70621A  
 preamplifier, 4-28, 4-42  
 for HP 70905A/B RF section, 4-28, 4-40  
 for HP 70905A RF section, 4-28, 4-32  
 for HP 70905B RF section, 4-28, 4-33  
 for HP 70906A/B RF section, 4-28, 4-40  
 for HP 70906A RF section, 4-28, 4-32  
 for HP 70906B RF section, 4-28, 4-33  
 for HP 70908A RF section, 4-28, 4-35  
 for HP 70908A RF section and HP 70620B  
 preamplifier, 4-28, 4-36  
 for HP 70909A RF section, 4-38  
 for HP 70910A RF section, 4-38  
 Frequency Span Accuracy, 4-28, 4-45  
 front handle  
 rack-mounting, 1-14  
 removal, 1-14  
 front-panel  
 HP 70900B local oscillator source, 1-4  
 HP 70907B external millimeter interface  
 module, 3-99  
 LEDs, 1-4  
 functional terms, 2-2

function keys  
  DISPLAY, 1-4  
  instrument keypad, 1-11  
  REPORT ERRORS, 1-4  
fuse replacement, system, 1-18

## G

Gain hardware error, hardware warning error, 6012, 5-23  
GSM System Calibration  
  for HP 71150C GSM transmitter tester, 4-28, 4-44  
  for HP 71250C GSM transmitter tester, 4-28, 4-44  
GSM System Displayed Average Noise Level using HP 70902A IF section, 4-28, 4-47

## H

hard reset, TEST position, 2-12  
hardware  
  broken errors 7000 – 7999, 5-25  
  interconnect, 1-15  
  warning errors 6000 – 6999, 5-22  
hardware broken error  
  7000, ROM Check error, 5-25  
  7001, L0 unleveled, 5-25  
  7002, First L0 unleveled, 5-25  
  7003, Second L0 unlocked, 5-25  
  7004, 300 MHz error, 5-25  
  7005, 321.4 MHz error, 5-25  
  7006, 21.4 MHz error, 5-25  
  7007, Cal error, 5-25  
  7008, FFS handshake, 5-25  
  7009, ROM 2 check error, 5-26  
  7010, FFS is unlocked, 5-26  
  7011, 125 KZ to FFS, 5-26  
  7012, Cannot lock YTO, 5-26  
  7013, Can't finetune YTO, 5-26  
  7014, 12.5 MZ to YTO LK BD, 5-27  
  7015, YTO unleveled, 5-27  
  7016, YTO is unlocked, 5-27  
  7017, External ref (100 MZ), 5-27  
  7018, 50 MZ to sampler, 5-27  
  7019, 300 MZ post fltr det, 5-28  
  7020, 300 MZ AGC, 5-28  
  7021, 600 MZ doubler level, 5-28  
  7022, Low idler range, 5-28  
  7023, High idler range, 5-28  
  7024, Tune DAC, 5-29  
  7025, Decade span atten, 5-29  
  7026, Binary span atten, 5-29  
  7027, Sweep dac, 5-29  
  7028, Correction dac, 5-29  
  7029, Video proc: 0 volt, 5-30  
  7030, Video proc: 2 volt, 5-30

  7031, Idler is unlocked, 5-30  
  7032, Oven RF error, 5-30  
  7033, Power supply error, 5-30  
  7034, Dist amp A error, 5-30  
  7035, Dist amp B error, 5-31  
  7036, HP-MSIB error, 5-31  
  7041, FFS won't tune low, 5-31  
  7042, FFS won't tune high, 5-31  
  7043, Freq board adjust, 5-31  
  7044, YTO tuning range, 5-32  
  7045, 10 MHz out error, 5-32  
  7046, Illegal bandslct cde, 5-32  
  7047, RAM failure, 5-32  
  7048, FFS won't unlock, 5-32  
  7050, Hardware config fail, 5-32  
  7073, Tune+Span disconnect, 5-33  
  7074, Discriminator unlock, 5-33  
  7075, LOLA unleveled, 5-33  
  7076, MULT unleveled, 5-33  
  7077, YTF drive error, 5-33  
  7078, Tune/Span error, 5-33  
  7079, EEPROM check error, 5-33  
  7801, Optical atten failed, 5-33  
  7802, ADC error, 5-33  
  7803, Power meter failed, 5-34  
  7804, Self test failed, 5-34  
  7805, Zeroing error, 5-34  
Hardware config fail, hardware broken error, 7050, 5-32  
Hardware not present, operating error, 2032, 5-17  
hardware warning error  
  6000, EAROM unprotected, 5-22  
  6001, Confidence test passed, 5-22  
  6002, A6 RAM checksum (battery), 5-22  
  6003, FFS won't tune low, 5-22  
  6004, FFS won't tune high, 5-22  
  6005, Idler tuning range, 5-22  
  6006, YTO tuning range, 5-22  
  6007, MSIB NMAA received, 5-22  
  6008, Confidence test failed, 5-23  
  6009, No module label, 5-23  
  6010, Err in MDOC response, 5-23  
  6011, RBW hardware error, 5-23  
  6012, Gain hardware error, 5-23  
  6013, LOGAMP hardware error, 5-23  
  6014, PLL error, 5-23  
  6015, Oven cold, 5-23  
  6016, freq reference, 5-24  
  6017, 6214 GHz error, 5-24  
  6018, PGA gain sum high, 5-24  
  6019, PGA gain sum low, 5-24  
  6802, Invalid cal data, 5-24  
  6805, Firmware Changed, 5-24  
Hdw Broken, error and status message, 4-64

- heterodyning, 1-6
- hex-nut latch, 1-4
- High idler range, hardware broken error, 7023, 5-28
- How to
  - connect the MSIB Y-Cable, 2-17
- HP 11990A system performance test software, 1-10
- HP 70001A mainframe
  - cabling to HP 70004A color display, 2-16
  - physical dimensions, 3-83
- HP 70004A color display
  - address switches, 2-14
  - physical dimensions, 3-83
- HP 70206A system graphics display
  - address switches, 2-14
- HP 70300A RF tracking generator
  - addressing criteria, 2-9
- HP 70301A microwave tracking generator
  - addressing criteria, 2-9
- HP 70310A precision frequency reference
  - 100 MHz, 3-85
  - 10 MHz, 3-85
  - addressing criteria, 2-9
  - characteristics, 3-85
  - distribution amplifier input, 3-85
  - distribution amplifier output, 3-85
  - EXT REF, 3-86
- HP 70600A preselector
  - addressing criteria, 2-8
  - characteristics, 3-87
  - Frequency Response, test, 4-28, 4-33, 4-40
  - RF INPUT, 3-87
  - RF OUTPUT, 3-87
  - TUNE + SPAN INPUT, 3-87
- HP 70601A preselector
  - addressing criteria, 2-8
  - characteristics, 3-87
  - Frequency Response, test, 4-28, 4-33, 4-40
  - RF INPUT, 3-87
  - RF OUTPUT, 3-87
  - TUNE + SPAN INPUT, 3-87
- HP 70620A/B preamplifier
  - addressing criteria, 2-9
- HP 70620A preamplifier
  - specifications, system changes, 3-40
- HP 70620B preamplifier
  - Frequency Response for HP 70908A RF section and, test, 4-28, 4-36
  - Frequency Response, test, 4-28, 4-40
- HP 70621A preamplifier
  - addressing criteria, 2-9
  - Frequency Response for HP 70904A RF section and, test, 4-28, 4-42
  - specifications, system changes, 3-40
- HP 70700A digitizer
  - addressing criteria, 2-8
- HP 70810B lightwave section
  - addressing criteria, 2-9
  - characteristics, 3-88
  - HSWP IN/OUT, 3-88
  - LIGHTWAVE INPUT, 3-88
  - RF INPUT, 3-88
  - RF OUTPUT, 3-88
- HP 70810B Option 850 lightwave section
  - characteristics, 3-88
  - HSWP IN/OUT, 3-88
  - LIGHTWAVE INPUT, 3-88
  - RF INPUT, 3-88
  - RF OUTPUT, 3-88
- HP 70900A/B local oscillator source
  - Calibrator Amplitude Accuracy, test, 4-28, 4-30
  - Calibrator Frequency Accuracy, test, 4-28, 4-29
- HP 70900B local oscillator source
  - 100 MHz IN, 1-6, 3-89
  - 300 MHz CALIBRATOR Output, 1-4
  - 300 MHz OUT, 3-89
  - 300 MHz OUT 1 and 2, 1-6
  - accessories, 1-8
  - ACT LED, 1-4
  - addressing criteria, 2-8
  - address switches, 2-12
  - CALIBRATOR, 3-89
  - characteristics, 3-89
  - COLUMNS 1–5, switches, 2-12
  - ERR LED, 1-4
  - EXTERNAL TRIGGER IN, 3-89
  - EXT TRIG IN, 1-6
  - FFS Loop Unlock LED, 1-4
  - fractional-N techniques, 1-3
  - frequency range, 1-3
  - front-panel features, 1-4
  - functions, 1-3
  - HP-IB ON/OFF, switches, 2-11
  - HSWP IN/OUT, 1-6, 3-89
  - IDL Loop Unlock LED, 1-4
  - lock-and-roll tuning, 1-3
  - LO OUT, 1-6, 3-89
  - LSN LED, 1-4
  - MAS/SLA, switches, 2-12
  - MEASURE LED, 1-4
  - NRML/TEST, switches, 2-12
  - Option 910, 1-8
  - Option 915, 1-8
  - rear-panel features, 1-6
  - RMT LED, 1-4
  - ROWS 1–3, switches, 2-12
  - SELF TEST LED, 1-4

- SRQ LED, 1-4
- SW1/MEM, switches, 2-11
- SWEEP, 1-6, 3-89
- TLK LED, 1-4
- TUNE + SPAN OUT, 1-6, 3-89
- VIDEO IN, 1-6, 3-89
- YTO Loop Unlock LED, 1-4
- HP 70902A IF section
  - 21.4 MHz IN, 3-90
  - addressing criteria, 2-8
  - AUX OUT, 3-90
  - characteristics, 3-90
  - Displayed Average Noise, test, 4-28, 4-46
  - GSM System Displayed Average Noise
    - Level, test, 4-28, 4-47
  - IF 3 MHz, 3-90
  - LIMITED IF OUT, 3-90
  - Log Fidelity, test, 4-28, 4-48
  - Resolution Bandwidth Tests, test, 4-28, 4-49
  - VIDEO 0-1V, 3-90
  - VIDEO OUT, 3-90
- HP 70903A IF section
  - 21.4 MHz IF, 3-91
  - 21.4 MHz IN, 3-91
  - addressing criteria, 2-8
  - characteristics, 3-91
  - Displayed Average Noise, test, 4-28, 4-46
  - IF 21.4 MHz Out, 3-91
  - LINEAR AGC VIDEO, 3-91
  - Log Fidelity, test, 4-28, 4-48
  - Resolution Bandwidth Tests, test, 4-28, 4-49
  - system specifications changes with, 3-48
  - VIDEO 0-1V, 3-91
  - VIDEO IN, 3-91
  - VIDEO OUT, 3-91
- HP 70904A RF section
  - 1st LO IN, 3-92
  - 1st LO OUT, 3-92
  - 21.4 MHz OUT, 3-92
  - 300 MHz IN, 3-92
  - characteristics, 3-92
  - Frequency Response, test, 4-31
  - PROBE POWER, 3-92
  - RF INPUT, 3-92
- HP 70905A/B RF section
  - Frequency Response, test, 4-28, 4-40
- HP 70905A RF section
  - 1st LO IN, 3-93
  - 1st LO OUT, 3-93
  - 21.4 MHz OUT, 3-93
  - 300 MHz IN, 3-93
  - 321.4 MHz IF IN, 3-93
  - 321.4 MHz IF OUT, 3-93
  - characteristics, 3-93
  - Frequency Response, test, 4-28, 4-32
  - RF INPUT, 3-94
- HP 70905B RF section
  - 1st LO IN, 3-97
  - 1st LO OUT, 3-97
  - 21.4 MHz OUT, 3-97
  - 300 MHz IN, 3-97
  - 321.4 MHz IF IN, 3-97
  - 321.4 MHz IF OUT, 3-97
  - characteristics, 3-97
  - Frequency Response, test, 4-28, 4-33
  - RF INPUT, 3-97
- HP 70906A/B RF section
  - Frequency Response, test, 4-28, 4-40
- HP 70906A RF section
  - 1st LO IN, 3-95
  - 1st LO OUT, 3-95
  - 21.4 MHz OUT, 3-95
  - 300 MHz IN, 3-95
  - 321.4 MHz IF IN, 3-95
  - 321.4 MHz IF OUT, 3-95
  - characteristics, 3-95
  - Frequency Response, test, 4-28, 4-32
  - RF INPUT, 3-96
- HP 70906B RF section
  - 1st LO IN, 3-97
  - 1st LO OUT, 3-97
  - 21.4 MHz OUT, 3-97
  - 300 MHz IN, 3-97
  - 321.4 MHz IF IN, 3-97
  - 321.4 MHz IF OUT, 3-97
  - characteristics, 3-97
  - Frequency Response, test, 4-28, 4-33
  - RF INPUT, 3-97
- HP 70907A/B external millimeter interface module
  - addressing criteria, 2-8
  - Log Fidelity, test, 4-28, 4-53
  - LO Output Amplitude (from, test, 4-28, 4-52
- HP 70907A external millimeter interface module
  - Calibrator Amplitude Accuracy, test, 4-28, 4-50
  - characteristics, 3-98
  - IF INPUT, 3-98
  - LO OUTPUT, 3-98
  - MIXER BIAS OUTPUT, 3-98
  - rear-panel, 3-98
  - Resolution Bandwidth, test, 4-28, 4-54
  - system specification changes with, 3-50
- HP 70907B external millimeter interface module

- Calibrator Amplitude Accuracy, test, 4-28, 4-51
- characteristics, 3-99
- front-panel, 3-99
- IF INPUT, 3-99
- LO OUTPUT, 3-99
- MIXER BIAS, 3-99
- PRESEL TUNE + SPAN INPUT, 3-99
- rear-panel, 3-99
- Resolution Bandwidth, test, 4-28, 4-56
- system specification changes with, 3-55
- HP 70908A RF section
  - 1st LO IN, 3-100
  - 1st LO OUT, 3-100
  - 21.4 MHz OUT, 3-100
  - 300 MHz IN, 3-100
  - 321.4 MHz IF OUT, 3-100
  - characteristics, 3-100
  - Frequency Response, test, 4-28, 4-35
  - RF INPUT, 3-100
  - TUNE + SPAN INPUT, 3-101
- HP 70909A RF section
  - 1st LO IN, 3-102
  - 1st LO OUT (Front Panel), 3-102
  - 1st LO OUT (Rear Panel), 3-102
  - 21.4 MHz OUT, 3-102
  - 300 MHz IN, 3-102
  - 321.4 MHz IF OUT, 3-102
  - characteristics, 3-102
  - Frequency Response, test, 4-38
  - RF INPUT (APC 3.5), 3-102
  - TUNE + SPAN INPUT, 3-103
- HP 70910A RF section
  - 1st LO IN, 3-102
  - 1st LO OUT (Front Panel), 3-102
  - 1st LO OUT (Rear Panel), 3-102
  - 21.4 MHz OUT, 3-102
  - 300 MHz IN, 3-102
  - 321.4 MHz IF OUT, 3-102
  - characteristics, 3-102
  - Frequency Response, test, 4-38
  - RF INPUT (APC 3.5), 3-102
  - TUNE + SPAN INPUT, 3-103
- HP 70911A WB IF section
  - addressing criteria, 2-8
- HP 71100C modular spectrum analyzer, 2-20
  - address map, 2-20
  - address map with HP 70300A RF tracking generator, 2-28
  - address map with HP 70903A IF section and HP 70700A digitizer, 2-26
  - cabling, 2-21
  - cabling with an HP 70300A RF tracking generator, 2-29
  - cabling with HP 70700A digitizer, 2-26
  - cabling with HP 70903A IF section, 2-23
  - cabling with HP 70903A IF section and HP 70700A digitizer, 2-27
  - specifications, 3-3, 3-9
  - with HP 70300A RF tracking generator, 2-28
  - with HP 70700A digitizer, 2-24, 2-26
  - with HP 70903A IF section, 2-22, 2-26
- HP 71100P modular spectrum analyzer, 2-56
  - address map, 2-56
  - address map with HP 70300A RF tracking generator, 2-64
  - address map with HP 70903A IF section and HP 70700A digitizer, 2-62
  - cabling, 2-57
  - cabling with an HP 70300A RF tracking generator, 2-65
  - cabling with HP 70700A digitizer, 2-61
  - cabling with HP 70903A IF section, 2-59
  - cabling with HP 70903A IF section and HP 70700A digitizer, 2-63
  - with HP 70300A RF tracking generator, 2-64
  - with HP 70700A digitizer, 2-60, 2-62
  - with HP 70903A IF section, 2-58, 2-62
- HP 71150C GSM transmitter tester
  - GSM System Calibration, test, 4-28, 4-44
- HP 71200C modular spectrum analyzer, 2-30
  - address map, 2-30
  - address map, deleting HP 70902A IF section, 2-34
  - address map, deleting HP 70905A RF section, 2-36, 2-38
  - address map, with HP 70903A IF section, 2-32
  - cabling, 2-31
  - cabling, deleting HP 70902A IF section, 2-35
  - cabling, deleting HP 70905A RF section, 2-37
  - cabling, with HP 70903A IF section, 2-33
  - deleting HP 70902A IF section, 2-34
  - deleting HP 70905A RF section, 2-36, 2-38, 2-39
  - specifications, 3-10, 3-17
  - with HP 70903A IF section, 2-32
- HP 71200P modular spectrum analyzer, 2-66
  - address map, 2-66
  - address map, deleting HP 70902A IF section, 2-70
  - address map, deleting HP 70905A RF section, 2-72, 2-74
  - address map, with HP 70903A IF section, 2-68
  - cabling, 2-67



- cabling, deleting HP 70902A IF section, 2-71
- cabling, deleting HP 70905A RF section, 2-73
- cabling, with HP 70903A IF section, 2-69
- deleting HP 70902A IF section, 2-70
- deleting HP 70905A RF section, 2-72, 2-74, 2-76
- with HP 70903A IF section, 2-68
- HP 71209A microwave spectrum analyzer, 2-40
  - address map, 2-40
  - cabling, 2-41
  - specifications, 3-18
  - specifications, with external mixers, 3-26
  - specifications with HP 11970, 3-30
  - specifications with HP 11974, 3-30
- HP 71209P microwave spectrum analyzer, 2-77
  - address map, 2-77
  - cabling, 2-78
- HP 71210C microwave spectrum analyzer, 2-42
  - address map, 2-42
  - cabling, 2-43
  - specifications, 3-31, 3-39
- HP 71210P microwave spectrum analyzer, 2-79
  - address map, 2-79
  - cabling, 2-80
  - with HP 70907B external millimeter interface module address map, 2-81
  - with HP 70907B external millimeter interface module cabling, 2-82
- HP 71210P microwave spectrum analyzer with HP 70907B external millimeter interface module, 2-81
- HP 71250C GSM transmitter tester
  - GSM System Calibration, test, 4-28, 4-44
- HP 71400C lightwave signal analyzer, 2-44
  - address map, 2-44
  - address map, with HP 70300A RF tracking generator and HP 70301A microwave tracking generator, 2-46
  - cabling, 2-45
  - specifications, 3-67, 3-70
  - with HP 70300A RF tracking generator and HP 70301A microwave tracking generator, 2-46, 2-48
- HP 71400C Option 850 lightwave signal analyzer
  - specifications, 3-71, 3-74
- HP 71401C lightwave signal analyzer, 2-49
  - add HP 70300A RF tracking generator, 2-51
  - address map, 2-49
  - address map, with HP 70300A RF tracking generator, 2-51
  - cabling, 2-50
  - cabling, with HP 70300A RF tracking generator, 2-52
  - specifications, 3-75, 3-78
- HP 71401C Option 850 lightwave signal analyzer
  - specifications, 3-79, 3-82
- HP-IB
  - access, 2-4
  - access area, 2-4
  - address, default, 2-12
  - HP-IB bus error, operating error, 2045, 5-19
  - HP-IB multiple cntlr, operating error, 2036, 5-18
  - HP-IB ON/OFF, switches, 2-13
- HP-MSIB
  - address menu, 4-19
  - map screen menu keys, 4-25
  - row address, setting, 2-12
  - HP-MSIB addr 70600, diagnostics error, 0012, 5-4
  - HP-MSIB addr 70700, diagnostics error, 0015, 5-4
  - HP-MSIB addr 70902, diagnostics error, 0002, 5-2
  - HP-MSIB addr 70903, diagnostics error, 0003, 5-2
  - HP-MSIB addr 70904, diagnostics error, 0004, 5-2
  - HP-MSIB addr 70905/6, diagnostics error, 0005, 5-3
  - HP-MSIB addr 70907, diagnostics error, 0010, 5-3
  - HP-MSIB address
    - error message, source of, 5-1
  - HP-MSIB error, hardware broken error, 7036, 5-31
  - HP-MSIB/HP-IB addressing, 2-1
- HSWP IN/OUT
  - HP 70810B lightwave section, 3-88
  - HP 70810B Option 850 lightwave section, 3-88
  - HP 70900B local oscillator source, 1-6, 3-89

**I**

- Idler is unlocked, hardware broken error, 7031, 5-30
- Idler is unlocked, operating error, 2028, 5-17

Idler tuning range, hardware warning error, 6005, 5-22  
 IDL Loop Unlock LED, HP 70900B local oscillator source, 1-4  
 IF 21.4 MHz Out  
     HP 70903A IF section, 3-91  
 IF 3 MHz  
     HP 70902A IF section, 3-90  
 IF INPUT  
     HP 70907A external millimeter interface module, 3-98  
     HP 70907B external millimeter interface module, 3-99  
 illegal address, 2-4  
 Illegal bandslct cde, hardware broken error, 7046, 5-32  
 Illegal Cal signal, operating error, 2023, 5-16  
 Illegal character, operating error, 2004, 5-13  
 Illegal character set, operating error, 2005, 5-13  
 Illegal command, operating error, 2001, 5-13  
 Illegal HP-MSIB comm, operating error, 2024, 5-16  
 Illegal in bypass, operating error, 2803, 5-21  
 Illegal in LW mode, operating error, 2802, 5-21  
 Illegal marker type, operating error, 2019, 5-16  
 Illegal operation, operating error, 2035, 5-18  
 Illegal parameter, operating error, 2002, 5-13  
 Incorrect disk found. ---- required., error and status message, 4-62  
 Incorrect System, diagnostics error, 0014, 5-4  
 independent element  
     addressing, 2-3  
     definition, 2-3  
 independent elements, 2-6  
 independent, MMS term, 2-2  
 indicator lights, 1-4  
 initial  
     inspection, 1-3  
     system power-on, 1-10  
 Initializing the HP-IB system per the Equipment Menu., error and status message, 4-64  
 installation, 2-15  
     rear-fan filter, 1-19  
     system rack-mount, 1-13

installing software, 4-9  
 instrument  
     cabinets, interconnecting, 1-15  
     keypad, 1-11  
     keypad function keys, 1-11  
     MMS term, 2-2  
 Integer overflow, computation error, 8004, 5-35  
 interconnecting  
     hardware, 1-15  
     instrument cabinets, 1-15  
     System II cabinets, 1-15  
 Invalid cal data, hardware warning error, 6802, 5-24  
 ---- is a undefined subprogram., error and status message, 4-62  
 isolation transformer, 1-17  
 Item not found, operating error, 2013, 5-15

## K

KEYBOARD SYSTEM CRASH WITH KEYBOARD  
     -----, error and status message, 4-64  
 keypad  
     function keys, 1-11  
     spectrum analyzer instrument, 1-11  
 keys, main menu, 4-23

## L

Label too long, operating error, 2016, 5-15  
 LC bandwidths, diagnostics error, 0022, 5-5  
 LC board, diagnostics error, 0032, 5-6  
 least significant bits, 2-3  
 LEDs  
     front panel, 1-4  
 legal addresses, 2-3  
 LIGHTWAVE INPUT  
     HP 70810B lightwave section, 3-88  
     HP 70810B Option 850 lightwave section, 3-88  
 limited cal defined, 4-7  
 LIMITED IF OUT  
     HP 70902A IF section, 3-90  
 LINEAR AGC VIDEO  
     HP 70903A IF section, 3-91  
 LINEAR not allowed, operating error, 2043, 5-19  
 line fuse removal and replacement, 1-18  
 line voltage selector, 1-16  
 LO, 1-3  
 LOGAMP hardware error, hardware warning error, 6013, 5-23  
 Log amplifier, diagnostics error, 0029, 5-6  
 Log amplifier, diagnostics error, 0039, 5-8  
 Log board, diagnostics error, 0033, 5-7

Log Fidelity  
 for HP 70902A IF section, 4-28, 4-48  
 for HP 70903A IF section, 4-28, 4-48  
 using HP 70907A/B external millimeter interface module, 4-28, 4-53

Logging errors to ERRORLOG failed.  
 Operating Disk is write protected., error and status message, 4-64

Log of negative, computation error, 8003, 5-35

Log of zero, computation error, 8002, 5-35

L0LA unlevelled, hardware broken error, 7075, 5-33

LO OUT  
 HP 70900B local oscillator source, 3-89

LO OUT, HP 70900B local oscillator source, 1-6

LO OUTPUT  
 HP 70907A external millimeter interface module, 3-98  
 HP 70907B external millimeter interface module, 3-99

LO Output Amplitude (from HP 70907A/B external millimeter interface module, 4-28, 4-52

L0 unlevelled, hardware broken error, 7001, 5-25

Low/high band switch, diagnostics error, 0044, 5-9

Low idler range, hardware broken error, 7022, 5-28

LSN LED, HP 70900B local oscillator source, 1-4

## M

mainframe, MMS term, 2-2

main menu, 4-6, 4-13

main menu keys, 4-23

manual conventions, 1-1

MAS/SLA, switches, 2-12

mass storage menu, 4-14, 4-24

mass storage menu volume labels, 4-14

master  
 address switches, 2-11  
 definition, 2-3  
 elements, 2-4  
 function as a slave, 2-12  
 function as a sub-master, 2-12  
 MMS term, 2-2

master/slave address matrix, 2-5

MEASURE LED, HP 70900B local oscillator source, 1-4

Media not initialized., error and status message, 4-64

Memory overflow, operating error, 2011, 5-14

menu  
 equipment, 4-17, 4-25  
 mass storage, 4-24  
 parameter, 4-15  
 structure of, 4-11  
 test, 4-20  
 user interface, 4-11

menu keys  
 HP-MSIB map screen, 4-25  
 parameter menu, 4-24  
 test, 4-26

Missing parameter, operating error, 2003, 5-13

Missing terminator, operating error, 2007, 5-14

MIXER BIAS  
 HP 70907B external millimeter interface module, 3-99

MIXER BIAS OUTPUT  
 HP 70907A external millimeter interface module, 3-98

MMS term  
 element, 2-2  
 independent, 2-2  
 instrument, 2-2  
 mainframe, 2-2  
 master, 2-2  
 module, 2-2  
 slave, 2-2  
 stand-alone instrument, 2-2  
 sub-master, 2-2

module  
 characteristics, inputs and outputs, 3-84  
 MMS term, 2-2  
 options, 1-8  
 removal, 2-15  
 removal and installation, 2-15  
 removal/replacement, 2-15

module, serial numbers, 1-24

Modulus of zero, computation error, 8006, 5-35

most significant bits, 2-3

MSIB  
 additional cable lengths, 2-84  
 cable adapter, 2-84  
 Y-cable, 2-84

MSIB NMAA received, hardware warning error, 6007, 5-22

MSIB Y-cable  
 connecting to an MMS mainframe, 2-17

MULT unlevelled, hardware broken error, 7076, 5-33

## N

New 70810 ROMs req, operating error, 2060, 5-21  
No active marker, operating error, 2020, 5-16  
No case for the sensor in the 8902A driver!, error and status message, 4-64  
No DAC in this band, operating error, 2046, 5-19  
No disk copy of output found., error and status message, 4-65  
No Element Present, in address map, 2-6  
No EMIM Section?, diagnostics error, 0011, 5-3  
No errors, operating error, 2000, 5-13  
NO I.F. SECTION?, diagnostics error, 0009, 5-3  
No instr resp, operating error, 2037, 5-18  
NO L0?, diagnostics error, 0001, 5-2  
No module label, hardware warning error, 6009, 5-23  
Non-responding HP-IB address., error and status message, 4-60  
No PRESELECTOR?, diagnostics error, 0013, 5-4  
NO RF SECTION?, diagnostics error, 0008, 5-3  
Not stored, A-X->A on, operating error, 2042, 5-19  
Not stored: open 1st, operating error, 2044, 5-19  
NRML/TEST, switches, 2-12

## O

operating disk, 4-1  
operating error  
2000, No errors, 5-13  
2001, Illegal command, 5-13  
2002, Illegal parameter, 5-13  
2003, Missing parameter, 5-13  
2004, Illegal character, 5-13  
2005, Illegal character set, 5-13  
2006, Parm out of range, 5-13  
2007, Missing terminator, 5-14  
2008, Output unlevelled, 5-14  
2009, Protocol error, 5-14  
2010, Cmd out of sequence, 5-14  
2011, A Hardware Selected, 5-14  
2011, Memory overflow, 5-14  
2012, B Hardware Selected, 5-14  
2013, Item not found, 5-15  
2014, Duplicate identifier, 5-15  
2015, Too many entries, 5-15  
2016, Label too long, 5-15  
2018, State protected, 5-15

2019, Illegal marker type, 5-16  
2020, No active marker, 5-16  
2021, Bad IF/ENDIF nesting, 5-16  
2022, REPEAT/UNTIL error, 5-16  
2023, Illegal Cal signal, 5-16  
2024, Illegal HP-MSIB comm, 5-16  
2025, System error (slave), 5-16  
2026, Check mixer bias, 5-17  
2027, Service mode -- do IP, 5-17  
2028, Idler is unlocked, 5-17  
2029, Command syntax error, 5-17  
2030, Scaling overflow, 5-17  
2031, Too many errors, 5-17  
2032, Hardware not present, 5-17  
2033, Single band only, 5-18  
2034, Test switch on, 5-18  
2035, Illegal operation, 5-18  
2036, HP-IB multiple cntlr, 5-18  
2037, No instr resp, 5-18  
2038, Span÷trace too large, 5-18  
2039, User stack overflow, 5-18  
2040, Partial USTATE data, 5-19  
2041, CAL POWER lvl err, 5-19  
2042, Not stored, A-X->A on, 5-19  
2043, LINEAR not allowed, 5-19  
2044, Not stored: open 1st, 5-19  
2045, HP-IB bus error, 5-19  
2046, No DAC in this band, 5-19  
2047, Preselector disabled, 5-20  
2048, Userdef protected, 5-20  
2049, Battery failed, 5-20  
2050, Ampcr/span too large, 5-20  
2051, File not found, 5-20  
2052, File already exists, 5-20  
2053, storage device, 5-20  
2054, write protect, 5-20  
2055, bad file, 5-21  
2056, bad revision, 5-21  
2057, volume full, 5-21  
2058, bad volume, 5-21  
2059, directory full, 5-21  
2060, New 70810 ROMs req, 5-21  
2802, Illegal in LW mode, 5-21  
2803, Illegal in bypass, 5-21  
operating errors 2000 - 2999, 5-13  
operation verification, system  
accessories, 4-5  
error messages, 4-7  
installation, 4-9  
software version, 4-2  
start up, 4-8  
test equipment, 4-5  
test software overview, 4-6  
title page, 4-8

Optical atten failed, hardware broken error, 7801, 5-33  
Option 910, HP 70900B local oscillator source, 1-8  
Option 915, HP 70900B local oscillator source, 1-8  
options  
    HP 70900B local oscillator source, 1-8  
    mainframe rear-fan filter, 1-19  
ordering  
    information, 2-83  
    rack flange kit, 1-13  
    rack mount with slides, 1-13  
    side support, 1-13  
Output unlevelled, operating error, 2008, 5-14  
Oven cold, hardware warning error, 6015, 5-23  
Oven RF error, hardware broken error, 7032, 5-30

## P

packaging  
    damage, 1-3  
parameter menu, 4-15  
Parameter Menu data file not found on -----, error and status message, 4-63  
Parameter Menu data not found on -----, error and status message, 4-63  
parameter menu keys, 4-24  
Parm out of range, operating error, 2006, 5-13  
Partial USTATE data, operating error, 2040, 5-19  
parts listing, replacement, 2-86  
Passed, error and status message, 4-65  
PAUSED. PRESS CONTINUE., error and status message, 4-65  
PC board connector cleaning, 1-22  
PGA gain sum high, hardware warning error, 6018, 5-24  
PGA gain sum low, hardware warning error, 6019, 5-24  
physical dimensions  
    HP 70001A mainframe, 3-83  
    HP 70004A color display, 3-83  
PLL error, hardware warning error, 6014, 5-23  
power cables, ac, 1-20  
Power meter failed, hardware broken error, 7803, 5-34  
power-on  
    initial system, 1-10  
power pack, external, 1-21

power pack, HP 70310A Precision Frequency Reference, 1-21  
power-source  
    400 Hz, 1-17  
    60 Hz, 1-17  
Power supply error, hardware broken error, 7033, 5-30  
preparing a system for use, 1-9  
Preselector disabled, operating error, 2047, 5-20  
PRESEL TUNE + SPAN INPUT  
    HP 70907B external millimeter interface module, 3-99  
PRGM ERROR, error and status message, 4-65  
printer compatibility, 4-3  
printing, 4-3, 4-7  
printing test results, 4-7  
PROBE POWER  
    HP 70904A RF section, 3-92  
Problem/amp1 low?, diagnostics error, 0024, 5-5  
Problem/amp1 low?, diagnostics error, 0034, 5-7  
Problem/amp1 low?, diagnostics error, 0043, 5-8  
Protocol error, operating error, 2009, 5-14

## R

rack flange kit, 1-13  
rack-mounting, 1-13  
    front handle, 1-14  
    with slides, 1-13  
RAM failure, hardware broken error, 7047, 5-32  
RBW hardware error, hardware warning error, 6011, 5-23  
Read ---- data from file ---- failed., error and status message, 4-63  
Reading errors from ERRORLOG failed. Check disk at -----, error and status message, 4-65  
rear-fan filter  
    for mainframe, 1-19  
    installation, 1-19  
rear-panel  
    HP 70900B local oscillator source, features, 1-6  
    HP 70907A external millimeter interface module, 3-98  
    HP 70907B external millimeter interface module, 3-99  
removal  
    front handle, 1-14  
removal/replacement

- line fuse, 1-18
  - module, 2-15
- REPEAT/UNTIL error, operating error, 2022, 5-16
- replacement parts listing, 2-86
- REPORT ERRORS, display menu key, 2-4
- REPORT ERRORS, function keys, 1-4
- reporting errors, 2-4
- required accessories, 4-6
- requirements
  - addressing order, 2-7
  - system operation, 1-9
  - test equipment, 4-5
- Res BW-accuracy, diagnostics error, 0026, 5-5
- Res BW-accuracy, diagnostics error, 0036, 5-7
- Res BW-amplitude, diagnostics error, 0027, 5-6
- Res BW-amplitude, diagnostics error, 0037, 5-7
- Res BW -- CF amp1, diagnostics error, 0051, 5-9
- Res BW -- CF amp1, diagnostics error, 0052, 5-9
- Res BW -- CF amp1, diagnostics error, 0053, 5-10
- Res BW -- CF, diagnostics error, 0050, 5-9
- Resolution Bandwidth
  - using HP 70907A external millimeter interface module, 4-28, 4-54
  - using HP 70907B external millimeter interface module, 4-28, 4-56
- Resolution Bandwidth Tests
  - for HP 70902A IF section, 4-28, 4-49
  - for HP 70903A IF section, 4-28, 4-49
- Return to Equipment Menu to enter serial number for -----, error and status message, 4-65
- RF attenuator, diagnostics error, 0041, 5-8
- RF attenuator, diagnostics error, 0045, 5-9
- RF attenuator, diagnostics error, 0060, 5-10
- RF INPUT
  - HP 70600A preselector, 3-87
  - HP 70601A preselector, 3-87
  - HP 70810B lightwave section, 3-88
  - HP 70810B Option 850 lightwave section, 3-88
  - HP 70904A RF section, 3-92
  - HP 70905A RF section, 3-94
  - HP 70905B RF section, 3-97
  - HP 70906A RF section, 3-96
  - HP 70906B RF section, 3-97
  - HP 70908A RF section, 3-100

- RF INPUT (APC 3.5)
  - HP 70909A RF section, 3-102
  - HP 70910A RF section, 3-102
- RF OUTPUT
  - HP 70600A preselector, 3-87
  - HP 70601A preselector, 3-87
  - HP 70810B lightwave section, 3-88
  - HP 70810B Option 850 lightwave section, 3-88
- RF Preamplifier, diagnostics error, 0070, 5-12
- RF section
  - addressing criteria, 2-8
- RF Switch 1, diagnostics error, 0064, 5-11
- RF Switch 1, diagnostics error, 0068, 5-11
- RF Switch 2, diagnostics error, 0065, 5-11
- RF Switch 2, diagnostics error, 0069, 5-11
- RF Switch 3, diagnostics error, 0066, 5-11
- RF Switch 4, diagnostics error, 0067, 5-11
- RMT LED, HP 70900B local oscillator source, 1-4
- ROM 2 check error, hardware broken error, 7009, 5-26
- ROM Check error, hardware broken error, 7000, 5-25
- row addressing priority, 2-10
- ROWS 1–3, switches, 2-12

## S

- Scaling overflow, operating error, 2030, 5-17
- Search for volume label ---- unsuccessful, error and status message, 4-60
- Second L0 unlocked, hardware broken error, 7003, 5-25
- Selected system under test is ----; but the software supports the ---- system., error and status message, 4-63
- SELECT INSTRUMENT, display menu key, 2-4
- self-test, 1-4
- Self test failed, hardware broken error, 7804, 5-34
- SELF TEST LED, HP 70900B local oscillator source, 1-4
- Sensor model # ---- not supported., error and status message, 4-63
- serial numbers, module, 1-24
- Service mode -- do IP, operating error, 2027, 5-17
- setting
  - HP-MSIB row address, 2-12
  - slave area boundaries, 2-6
- Setup Error , error and status message, 4-65
- shipment

- contents, of software, 4-1
- Short Pass, error and status message, 4-65
- side support, what to order, 1-13
- Single band only, operating error, 2033, 5-18
- single tests defined, 4-7
- slave
  - address switches, 2-12
  - area boundaries, 2-6
  - definition, 2-3
  - element address switches, 2-12
  - elements, 2-5
  - MMS term, 2-2
- slave area, 2-3, 2-4
  - boundaries, setting, 2-6
  - of master, 2-10
- slave modules, 1-3
- software/hardware compatibility, 4-2
- software version, 4-2
- Some devices listed as "Available" require serial numbers., error and status message, 4-60
- Some Model #'s are not supported. (See Edit Screen)., error and status message, 4-59
- Span÷trace too large, operating error, 2038, 5-18
- spare fuse, 1-18
- specifications
  - affected by preamplifiers, 3-40
  - different RF sections/preselectors, 3-62
  - for various systems, 3-1
  - HP 71100C modular spectrum analyzer, 3-3
  - HP 71200C modular spectrum analyzer, 3-10
  - HP 71209A microwave spectrum analyzer, 3-18
  - HP 71209A microwave spectrum analyzer with external mixers, 3-26
  - HP 71210C microwave spectrum analyzer, 3-31
  - HP 71400C lightwave signal analyzer, 3-67
  - HP 71400C Option 850 lightwave signal analyzer, 3-71
  - HP 71401C lightwave signal analyzer, 3-75
  - HP 71401C Option 850 lightwave signal analyzer, 3-79
  - system changes with HP 70620B preamplifier, 3-40
  - system changes with HP 70621A preamplifier, 3-40
  - system changes with HP 70903A IF section, 3-48
  - system changes with HP 70907A external millimeter interface module, 3-50
  - system changes with HP 70907B external millimeter interface module, 3-55
  - with additional HP 70907A external millimeter interface module, 3-54
  - with HP 70620B Option 001 preamplifier, 3-44
  - with HP 70620B preamplifier, 3-41
  - with HP 70621A preamplifier, 3-47
  - with HP 70903A IF section, 3-49
  - with HP 70907A external millimeter interface module, 3-53, 3-54
  - with HP 70907B external millimeter interface module, 3-61
- spectrum analyzer
  - instrument keypad, functions, 1-11
- Square root error, computation error, 8005, 5-35
- SRQ LED, HP 70900B local oscillator source, 1-4
- stand-alone instrument, MMS term, 2-2
- standby power, 1-21
- start-up procedures, 4-8
- State protected, operating error, 2018, 5-15
- static-safe work station, 1-22
- static-shielding containers, 1-23
- status messages, for user interface, 4-59
- Step gain amplifier, diagnostics error, 0025, 5-5
- Step gain amplifier, diagnostics error, 0035, 5-7
- Step gain amplifier, diagnostics error, 0046, 5-9
- storage device, operating error, 2053, 5-20
- String is too long. It has been truncated., error and status message, 4-66
- structural terms, 2-2
- sub-master
  - address matrix, 2-5
  - definition, 2-3
  - elements, 2-5
  - function as a master, 2-12
  - MMS term, 2-2
- SWEEP
  - HP 70900B local oscillator source, 3-89
- Sweep dac, hardware broken error, 7027, 5-29
- SWEEP, HP 70900B local oscillator source, 1-6
- switches
  - A1–A5, 2-13
  - A6–A8, 2-13
  - COLUMNS 1–5, 2-12
  - HP-IB ON/OFF, 2-11, 2-13
  - MAS/SLA, 2-12

- NRML/TEST, 2-12
- ROWS 1–3, 2-12
- SW1/MEM, 2-11
- SYSTEM CONTROLLER, 2-13
- TALK ONLY, 2-13
- TEST MODE, 2-13
- system
  - calibration certification, 1-10
  - component, definition, 2-1
  - components, 3-2
  - configuration examples, 2-19, 2-55
  - configurations for A and C systems, 2-18
  - configurations for P systems, 2-53
  - diagnostics, error messages, 5-2
  - line fuse replacement, 1-18
  - operating requirements, 1-9
  - operation verification, accessories, 4-5
  - operation verification, error messages, 4-7
  - operation verification, installation, 4-9
  - operation verification, software version, 4-2
  - operation verification, start up, 4-8
  - operation verification, test equipment, 4-5
  - operation verification, test software overview, 4-6
  - operation verification, title page, 4-8
  - power cables, 1-19
  - rack-mount and cabinet interconnect installation, 1-13
  - replaceable parts, 2-83
  - specifications, 3-1
- SYSTEM CONTROLLER, switches, 2-13
- System error (slave), operating error, 2025, 5-16
- System II cabinets, interconnecting, 1-15
- system operation verification
  - Calibrator Amplitude Accuracy for HP 70900A/B local oscillator source, 4-28, 4-30
  - Calibrator Amplitude Accuracy using HP 70907A external millimeter interface module, 4-28, 4-50
  - Calibrator Amplitude Accuracy using HP 70907B external millimeter interface module, 4-28, 4-51
  - Calibrator Frequency Accuracy for HP 70900A/B local oscillator source, 4-28, 4-29
  - Displayed Average Noise using HP 70902A IF section, 4-28, 4-46
  - Displayed Average Noise using HP 70903A IF section, 4-28, 4-46
  - Frequency Response for HP 70600A preselector, 4-28, 4-33, 4-40
  - Frequency Response for HP 70601A preselector, 4-28, 4-33, 4-40
  - Frequency Response for HP 70620B preamplifier, 4-28, 4-40
  - Frequency Response for HP 70904A RF section, 4-31
  - Frequency Response for HP 70904A RF section and HP 70621A preamplifier, 4-28, 4-42
  - Frequency Response for HP 70905A/B RF section, 4-28, 4-40
  - Frequency Response for HP 70905A RF section, 4-28, 4-32
  - Frequency Response for HP 70905B RF section, 4-28, 4-33
  - Frequency Response for HP 70906A/B RF section, 4-28, 4-40
  - Frequency Response for HP 70906A RF section, 4-28, 4-32
  - Frequency Response for HP 70906B RF section, 4-28, 4-33
  - Frequency Response for HP 70908A RF section, 4-28, 4-35
  - Frequency Response for HP 70908A RF section and HP 70620B preamplifier, 4-28, 4-36
  - Frequency Response for HP 70909A RF section, 4-38
  - Frequency Response for HP 70910A RF section, 4-38
  - Frequency Span Accuracy, 4-28, 4-45
  - GSM System Calibration for HP 71150C GSM transmitter tester, 4-28, 4-44
  - GSM System Calibration for HP 71250C GSM transmitter tester, 4-28, 4-44
  - GSM System Displayed Average Noise Level using HP 70902A IF section, 4-28, 4-47
  - Log Fidelity for HP 70902A IF section, 4-28, 4-48
  - Log Fidelity for HP 70903A IF section, 4-28, 4-48
  - Log Fidelity using HP 70907A/B external millimeter interface module, 4-28, 4-53
  - LO Output Amplitude (from HP 70907A/B external millimeter interface module, 4-28, 4-52
  - Resolution Bandwidth Tests for HP 70902A IF section, 4-28, 4-49
  - Resolution Bandwidth Tests for HP 70903A IF section, 4-28, 4-49
  - Resolution Bandwidth using HP 70907A external millimeter interface module, 4-28, 4-54



- Resolution Bandwidth using HP 70907B external millimeter interface module, 4-28, 4-56
- tests, 4-28
- system specification changes
  - HP 70620B preamplifier, 3-40
  - HP 70621A preamplifier, 3-40

## T

- TALK ONLY, switches, 2-13

- test

- description list, 4-28
- descriptions, 4-27
- disk, 4-1
- equipment, external, 4-5
- limit changes, 4-58
- menu, 4-20
- menu keys, 4-26
- results, 4-7

- Test can not be done., error and status message, 4-65

- Testing \_\_\_\_ dd\_mmm\_yyyy., error and status message, 4-65

- testing multiple systems, 4-6

- TEST\_LIST is not compatible., error and status message, 4-65

- TEST MODE, switches, 2-13

- TEST position, hard reset, 2-12

- tests

- operation verification, 4-28

- Tests

- Calibrator Amplitude Accuracy for HP 70900A/B local oscillator source, 4-28, 4-30

- Calibrator Amplitude Accuracy using HP 70907A external millimeter interface module, 4-28, 4-50

- Calibrator Amplitude Accuracy using HP 70907B external millimeter interface module, 4-28, 4-51

- Calibrator Frequency Accuracy for HP 70900A/B local oscillator source, 4-28, 4-29

- Displayed Average Noise using HP 70902A IF section, 4-28, 4-46

- Displayed Average Noise using HP 70903A IF section, 4-28, 4-46

- Frequency Response for HP 70600A preselector, 4-28, 4-33, 4-40

- Frequency Response for HP 70601A preselector, 4-28, 4-33, 4-40

- Frequency Response for HP 70620B preamplifier, 4-28, 4-40

- Frequency Response for HP 70904A RF section, 4-31

- Frequency Response for HP 70904A RF section and HP 70621A preamplifier, 4-28, 4-42

- Frequency Response for HP 70905A/B RF section, 4-28, 4-40

- Frequency Response for HP 70905A RF section, 4-28, 4-32

- Frequency Response for HP 70905B RF section, 4-28, 4-33

- Frequency Response for HP 70906A/B RF section, 4-28, 4-40

- Frequency Response for HP 70906A RF section, 4-28, 4-32

- Frequency Response for HP 70906B RF section, 4-28, 4-33

- Frequency Response for HP 70908A RF section, 4-28, 4-35

- Frequency Response for HP 70908A RF section and HP 70620B preamplifier, 4-28, 4-36

- Frequency Response for HP 70909A RF section, 4-38

- Frequency Response for HP 70910A RF section, 4-38

- Frequency Span Accuracy, 4-28, 4-45

- GSM System Calibration for HP 71150C GSM transmitter tester, 4-28, 4-44

- GSM System Calibration for HP 71250C GSM transmitter tester, 4-28, 4-44

- GSM System Displayed Average Noise Level using HP 70902A IF section, 4-28, 4-47

- Log Fidelity for HP 70902A IF section, 4-28, 4-48

- Log Fidelity for HP 70903A IF section, 4-28, 4-48

- Log Fidelity using HP 70907A/B external millimeter interface module, 4-28, 4-53

- LO Output Amplitude (from HP 70907A/B external millimeter interface module, 4-28, 4-52

- Resolution Bandwidth Tests for HP 70902A IF section, 4-28, 4-49

- Resolution Bandwidth Tests for HP 70903A IF section, 4-28, 4-49

- Resolution Bandwidth using HP 70907A external millimeter interface module, 4-28, 4-54

- Resolution Bandwidth using HP 70907B external millimeter interface module, 4-28, 4-56

- Test switch on, operating error, 2034, 5-18

- The 436A is in lowest range, waiting 10 seconds., error and status message, 4-66

The 8902A needs repair (Error 6)., error and status message, 4-66

The \_\_\_\_\_ at address \_\_\_\_\_ was not found on HP-IB., error and status message, 4-66

The controller does not have sufficient memory., error and status message, 4-65

The correct Power Sensor has not been detected. Connect the \_\_\_\_\_ or Abort the test., error and status message, 4-63

The DUT must have an HP-IB address., error and status message, 4-66

The Operating Disk is write protected., error and status message, 4-63

THIS COLUMN CAN NOT BE EDITED., error and status message, 4-66

This test can not be selected because of missing ETE., error and status message, 4-66

Timed Out , error and status message, 4-66

TLK LED, HP 70900B local oscillator source, 1-4

Too many Cal Data frequencies were eliminated. There must be at least two frequencies., error and status message, 4-63

Too many entries, operating error, 2015, 5-15

Too many errors, operating error, 2031, 5-17

troubleshooting

- HP 70207A PC Display for MMS, 5-1
- MSIB interface card, 5-1
- MSIB Y-cable, 5-1

Tune DAC, hardware broken error, 7024, 5-29

Tune+Span, diagnostics error, 0040, 5-8

Tune+Span disconnect, hardware broken error, 7073, 5-33

Tune/Span error, hardware broken error, 7078, 5-33

TUNE + SPAN INPUT

- HP 70600A preselector, 3-87
- HP 70601A preselector, 3-87
- HP 70908A RF section, 3-101
- HP 70909A RF section, 3-103
- HP 70910A RF section, 3-103

TUNE + SPAN OUT

- HP 70900B local oscillator source, 1-6, 3-89

two IF sections in a system, 1-10

types of error messages or warnings defined, 4-7

typographic conventions, 4-4

## U

Userdef protected, operating error, 2048, 5-20

user errors 0001 - 0999, 5-2

user interface, error and status messages, 4-59

User Interface Setup Screen, 4-27

User stack overflow, operating error, 2039, 5-18

## V

VIDEO 0-1V

- HP 70902A IF section, 3-90
- HP 70903A IF section, 3-91

VIDEO IN

- HP 70900B local oscillator source, 1-6, 3-89
- HP 70903A IF section, 3-91

VIDEO OUT

- HP 70902A IF section, 3-90
- HP 70903A IF section, 3-91

Video output cable, diagnostics error, 0021, 5-5

Video output cable, diagnostics error, 0031, 5-6

Video proc: 0 volt, hardware broken error, 7029, 5-30

Video proc: 2 volt, hardware broken error, 7030, 5-30

volume full, operating error, 2057, 5-21

## W

warm-up requirements, 1-9, 1-10

\_\_\_\_\_ was not located., error and status message, 4-64

Write \_\_\_\_\_ data to file \_\_\_\_\_ failed., error and status message, 4-64

Write protected., error and status message, 4-66

write protect, operating error, 2054, 5-20

Wrong device at specified address. DUT was expected at address \_\_\_\_\_., error and status message, 4-64

## Y

YTF drive error, hardware broken error, 7077, 5-33

YTO is unlocked, hardware broken error, 7016, 5-27

YTO Loop Unlock LED, HP 70900B local oscillator source, 1-4

YTO tuning range, hardware broken error, 7044, 5-32

YTO tuning range, hardware warning error, 6006, 5-22

YT0 unlevelled, hardware broken error,  
7015, 5-27

## **Z**

Zeroing error, hardware broken error,  
7805, 5-34

