

**83711A/12A and
83711B/12B
Synthesized CW
Generators**

Quick Start Guide



HP part number: 83711-90133 Supersedes: 5960-7090
Printed in USA April 1995

Notice.

The information contained in this document is subject to change without notice.

Hewlett-Packard makes no warranty of any kind with regard to this material, including but not limited to, the implied warranties of merchantability and fitness for a particular purpose. Hewlett-Packard shall not be liable for errors contained herein or for incidental or consequential damages in connection with the furnishing, performance, or use of this material.

© Copyright Hewlett-Packard Company 1995

All Rights Reserved. Reproduction, adaptation, or translation without prior written permission is prohibited, except as allowed under the copyright laws.
1400 Fountaingrove Parkway, Santa Rosa, CA 95403-1799, USA

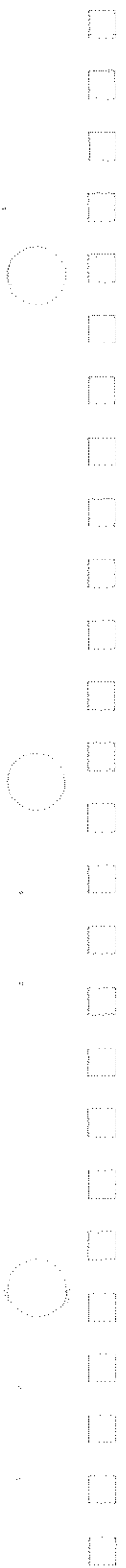

Warranty

The information contained in this document is subject to change without notice and should not be construed as a commitment by the Hewlett-Packard Company.

WARNING The WARNING sign denotes a hazard. It calls attention to a procedure, practice, or the like which, if not correctly performed or adhered to, could result in personal injury. Do not proceed beyond a WARNING sign until the indicated conditions are fully understood and met.

CAUTION

The CAUTION sign denotes a hazard. It calls attention to a procedure, practice, or the like which, if not correctly performed or adhered to, could result in damage to or destruction of part or all of the product. Do not proceed beyond a CAUTION sign until the indicated conditions are fully understood and met.

Safety Information



Instruction manual symbol: The product will be marked with this symbol when it is necessary for the user to refer to the instruction manual in order to protect against damage to the product.



Indicates hazardous voltages.

Complete safety, legal, and regulatory information can be found in the HP 8371A/12A and HP 8371B/12B Synthesized CW Generators User's Guide.

The Synthesizer at a Glance

The following figure and accompanying text explains some features of the HP 8371A and HP 8371B. The HP 8371A and HP 8371B are nearly identical.

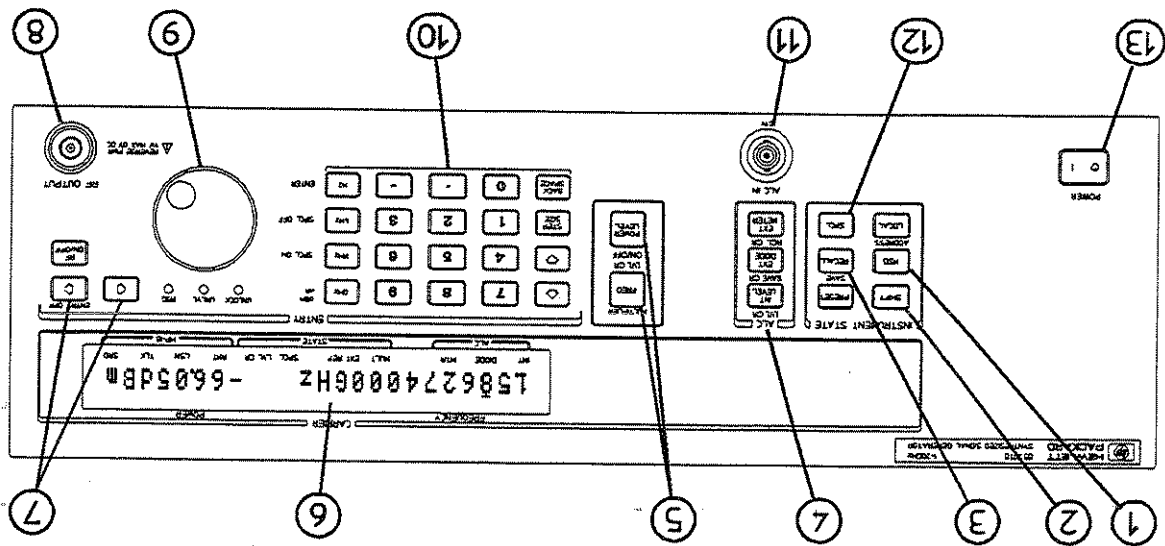

HP 8371A Synthesized CW Generator

pdg1ab.c

10. The data entry keys are used to enter and modify various synthesizer parameters. The **BACKSPACE** key cancels all or part of an erroneous parameter entry before it has been terminated. The terminator keys (the right-most column of keys) are used to choose the units for the entered parameter as well as to terminate the parameter entry. The **↑**, **↓**, and **STEP SIZE** keys are used to increase or decrease a parameter in predetermined steps.

11. The Automatic Level Control voltage input (ALC IN) connector is used as the feedback path to the synthesizer when its RF output power level is being leveled externally.

12. The **SPCL** key is used to initiate the activation of several special functions available in the synthesizer. Special functions are additional functions that are not activated by pressing a front panel key or shifted key.

13. The POWER for LINE on HP 83711A/12A switch turns the synthesizer either on or standby. To set the POWER for LINE on HP 83711A/12A switch to standby, depress the side of the switch that is marked with the ☐ symbol.

5. These keys set the carrier frequency and RF output power level of the synthesizer.

6. The display shows the current values of synthesizer parameters as well as the status of many of the synthesizer functions. The display shows the current carrier frequency and output power level. The annunciators that appear below the parameters are only visible when their associated function is active.

7. The **←** and **→** keys move the cursor that is over one of the digits in the display either to the right or left when pressed. The digit that is under the cursor will be modified when the knob is rotated. If no cursor appears in the display, parameter entry or modification has been inhibited.

8. The **RF OUTPUT** connector mates with a Type-N male connector on non-option 1E9 instruments. The connector mates with a female APC 3.5-mm precision connector on instruments with option 1E9 installed.

9. The knob is used to increase or decrease the digit under the cursor (▲) in the display in steps of one.

1. The **MSG** key allows you to display any error messages on the front panel display. Error messages are generated when you perform a keystroke sequence that is not valid, try to operate the synthesizer in a mode that is not allowed, etc.

2. The **SHIFT** key changes the function of some of the keys. When you press the **SHIFT** key and then press another key, the synthesizer performs the function printed in blue above the key.

3. The **RECALL** / **SAVE** key is used to save most of the synthesizer operating parameters in one of nine nonvolatile registers so that they can be recalled and used at a later time.

4. The Automatic Level Control keys select the method used to regulate the synthesizer output power level. Either internal leveling, external power meter leveling, or external diode detector leveling can be selected. Additional external equipment is required when either external power meter leveling or external diode detector leveling is used.

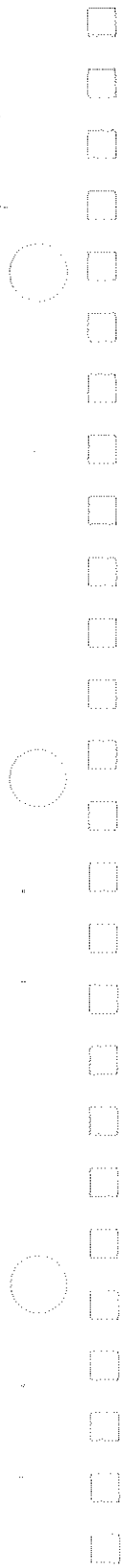

In This Book

This book provides a way for you to start using the HP 83711A/12A or HP 83711B/12B synthesizer quickly and productively. It gives you an overview of some basic synthesizer features while making you aware of other more complex features.

- "The Synthesizer at a Glance" shows you the various controls and other features of the synthesizer's front panel.
- "To Get Started" shows you how to power up the synthesizer.
- "To Use the Synthesizer" shows you how to enter function parameters and generate a simple signal.
- "If You Encounter a Problem" is included in case you run into any difficulties operating the synthesizer.

The HP 83711A/12A and
HP 83711B/12B
Quick Start Guide

The HP 83711A/12A and HP 83711B/12B Quick Start Guide

To Get Started

This section explains how to apply power to the synthesizer and turn it on. It also explains what you will see on the synthesizer's display after it has powered up.

1. Set the POWER (or LINE on HP 83711A/12A) switch on the synthesizer to standby.

To set the POWER (or LINE on HP 83711A/12A) switch to standby, depress the side of the switch that is marked with the S symbol.

2. Set the line voltage selector switch to match the mains voltage.

The line voltage selector switch is located on the rear panel of the synthesizer to the right of the power module. Use a small flat blade screwdriver to set the switch up for mains voltages in the range of 90 V to 132 V, 50, 60, or 400 Hz or down for mains voltages in the range of 198 V to 264 V, 50 or 60 Hz.

3. Connect the power cable to the power module on the synthesizer.

Note that the power module end of the power cable is keyed and will only plug into the power module one way.

4. Connect the plug end of the power cable to a suitable mains power receptacle.

WARNING

This is a Safety Class I product (provided with a protective earthing ground incorporated in the power cord. The mains plug shall only be inserted in a socket outlet provided with a protective earth contact. Any interruption of the protective conductor inside or outside of the product is likely to make the product dangerous. Intentional interruption is prohibited.

5. Set the POWER (or LINE on HP 83711A/12A) switch to on (I).
When you turn the synthesizer on, the ventilation fan starts. In addition, every segment of the display will light momentarily and then the turn-on sequence will rapidly flash on the display.
After the turn-on sequence is complete, the MSG LED annunciator should not be lit after the appropriate warm up time. The synthesizer is now ready to use.

NOTE

Error message 940 TIMEBASE OVEN COLD will remain on after the power-up test if the instrument has option 1E5 installed, and has been disconnected from mains power. This error should go away after a short warmup period.







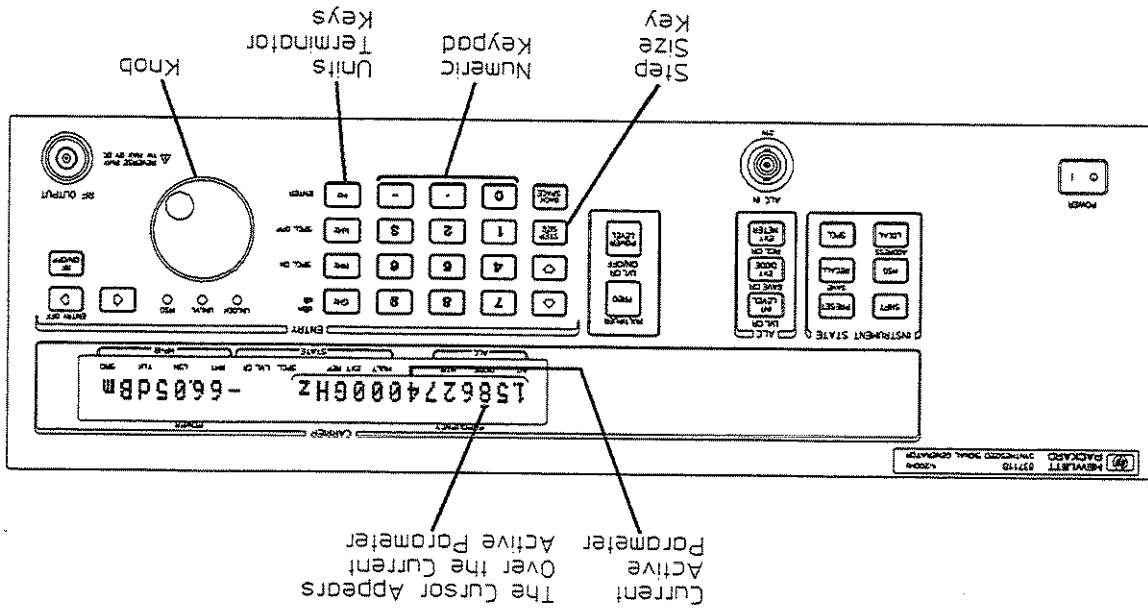



6. If the MSG annunciator remains lit after the turn-on sequence is complete, or you have other problems with power-up of the synthesizer, refer to "Power-Up Problems" in the section titled "If You Encounter a Problem" at the end of this book.

To Use the Synthesizer

This section explains how to enter function parameters (called "data" in this section) and then shows you how to generate a CW signal. Other synthesizer capabilities are covered in the HP 83711A/12A and HP 83711B/12B Synthesized CW Generators User's Guide.



The Synthesizer Front Panel

- You can use the knob to increase or decrease the digit in the display that is under the cursor.
 - The cursor in the display is always over the current active parameter. It is also always directly over the digit that will be increased or decreased by rotating the knob.
 - The cursor can be moved over the active parameter using the  and  keys.
 - You can use the  and  keys to increase or decrease the active parameter by a predetermined amount set with the  key.
 - You can select a function key or shifted function to begin the data entry process.
 - The function must have a numeric value (parameter) associated with it in order to be able to enter a new function parameter value.  and  are examples of functions with parameters.
 - You can use the numeric keypad and units terminators to enter data directly.
 - You use the units terminator keys to terminate numeric parameter entries.
- The text on the keys show the various frequency terminator values. The text adjacent to the keys show power level terminator values.
- For example, to enter a frequency multiplier value of 5 using the numeric keypad, perform the following steps:
1. Press the  key and then the  key.
 2. Press  on the numeric keypad.
 3. Press  (ENTER) to terminate the entry.

To Generate a CW Signal

1. Set the desired frequency.
For example, perform the following procedure to set the frequency to 2.000203 GHz.
 - a. Press the **FREQ** key.
 - b. Type **2.000203** on the synthesizer's numeric keypad.
 - c. Terminate frequency entry by pressing the **GHz** key.

2. Set the desired RF output power level.
For example, perform the following procedure to set the output power level to 2.5 dBm.
 - a. Press the **POWER LEVEL** key.
 - b. Type **25** on the synthesizer's numeric keypad.
 - c. Terminate the power level entry by pressing the **dBm** (**GHz**) key.

3. If the RF output is currently turned off, press the **RF ON/OFF** key to turn it on.
(If the RF output is off, the word **OFF** appears in the power level portion of the display.)

Additionally, you can use different kinds of signal leveling, or save and recall instrument states. These procedures and others are explained in the *HP 83711A/12A and HP 83711B/12B Synthesized CW Generators User's Guide*.

To Use External Diode Detector Leveling

External diode detector leveling is useful when you desire leveled RF output power from the synthesizer at a point other than the RF OUTPUT connector. External diode detector leveling uses the following external equipment.

Equipment	Requirements
Diode Detector	Must be specified for use at the desired synthesizer output frequency. Must produce greater than 1 mV of ALC voltage for the power levels present at the sampling point.
Power Splitter or Directional Coupler	Must be specified for use at the desired synthesizer output frequency.
Power Meter <i>(optional)</i>	None
Power Sensor <i>(optional)</i>	Must be capable of measuring power at the frequency and level present at the sampling point in the leveling loop.
Cables and Adapters	You must supply the cables and adapters necessary to connect the equipment.

NOTE

The power meter and power sensor are not required, but are helpful when adjusting the synthesizer output power for the desired power level at the output.

In addition, you must supply the cables and adapters necessary to connect the equipment.

3. Set the desired output signal frequency using the **[FREQ]** key and any modulation.
4. If the RF output is currently turned off, press the **[RF ON/OFF]** key to turn it on.
(If the RF output is off, the word OFF appears in the power level portion of the right-most display.)

NOTE
When the **[EXT DIODE]** key is pressed, the synthesizer enters the external diode detector leveling mode. Power is then held at a constant level at the sampling point, regardless of gain changes in the signal path between the synthesizer RF OUTPUT connector and the output.

2. Press the **[EXT DIODE]** key to enable external leveling.

Figure 1-1. External Diode Detector Leveling Setup

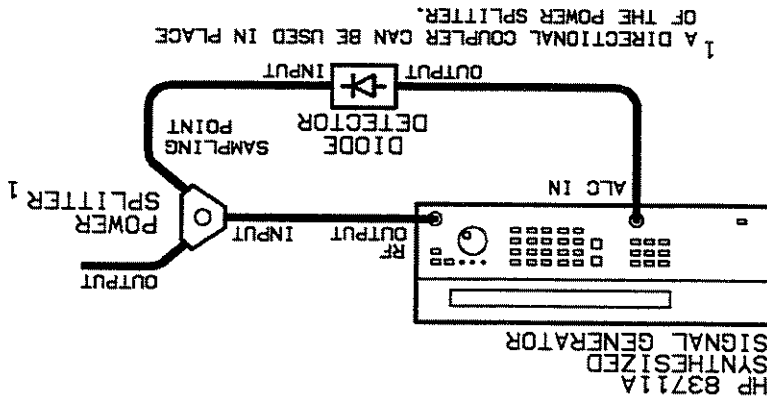

1. Connect the equipment as shown in Figure 1-1:

To Use External Diode Detector Leveling

Quick Start Guide

The HP 83711A/12A and HP 83711B/12B

Notes

1. When the **EXT DIODE** key is pressed, the synthesizer output power might change. Therefore, you might want to check the output power and readjust if necessary.
2. External diode detector leveling does not provide temperature compensation, thus, output level recalibration might be required in environments that are not temperature stabilized.
3. External diode detector leveling does not provide proper compensation from square law to linear regions of the detector. Therefore, power level changes may require output level recalibration.

- a. Temporarily connect the power meter and sensor at the output.
 - b. Press the **POWER LEVEL** key.
 - c. Rotate the knob until the power meter reads -5 dbm (disregard the synthesizer power level reading).
 - d. Disconnect the power meter and sensor from the output and connect the device under test (DUT).
5. Adjust the synthesizer output power so that the desired power at the output is attained.

The HP 83711A/12A and HP 83711B/12B
 Quick Start Guide
 To Use External Diode Detector Leveling

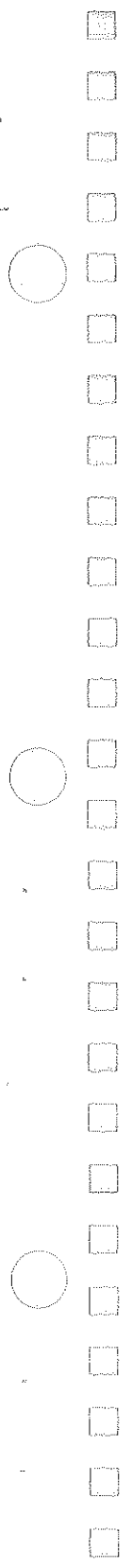

If You Encounter a Problem

If you have difficulty while installing or using the synthesizer, check the following list of commonly encountered problems and troubleshooting procedures. If the problem that you encounter is not in the following list, refer to additional sections entitled "If You Encounter a Problem" in the HP 83711A/12A and HP 83711B/12B Synthesized CW Generators User's Guide.

Power-Up Problems

If the synthesizer display does not light:

- Check that the power cord is fully seated in both the mains power receptacle and the synthesizer power module.
- Check that the synthesizer line fuse is not open.

For continued protection against fire hazard, replace the fuse with same type and rating.

WARNING

Refer to the following figure to remove the fuse from the power module. You can use a continuity light or an ohmmeter to check the fuse. An ohmmeter should read very close to zero ohms if the fuse is good. The 6.3 A, 250 V fuse is HP part number 2110-0703.

- Contact the nearest Hewlett-Packard office for service, if necessary.
- If the display lights, but the ventilation fan does not start:

- Check that the fan is not stuck. To check the fan, follow these steps:
- 1. Set the POWER switch (LNF on the HP 83711A/12A) to standby (Ⓞ).
- 2. Check that the fan blades are not jammed.
- Contact the nearest Hewlett-Packard office for service, if necessary.

If the synthesizer MSG LED annunciator remains on after the power-up test is complete:
When the MSG annunciator is on, the synthesizer is reporting an error condition. To determine the error and turn off the MSG annunciator, refer to "To Read the Contents of the Error Queue" as well as the listing of error messages in the HP 83711A/12A and HP 83711B/12B Synthesized CW Generators User's Guide.

Line Fuse Removal and Replacement

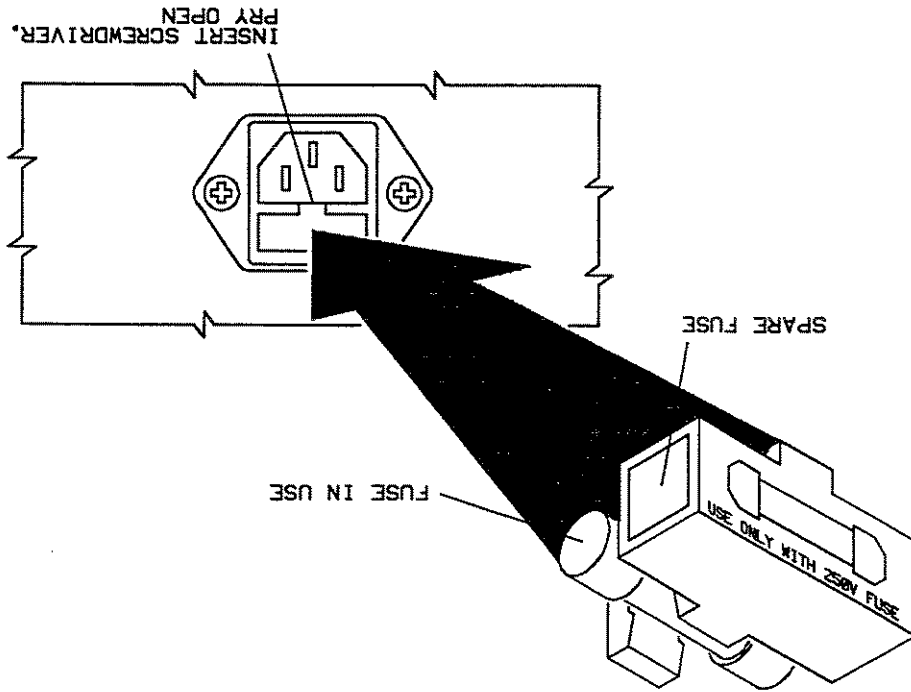





If You Encounter a Problem

Quick Start Guide

The HP 83711A/12A and HP 83711B/12B



Data Entry Problems

If the data entry controls (keypad, knob, , , , ) do not respond:

- Check that the ENTRY OFF function is not enabled.
The ENTRY OFF function is enabled when the cursor (▲) doesn't appear over any of the parameters in the display. To return to normal entry mode, press any function key that has a numeric parameter associated with it.
- Check that the function key which is selected accepts data.
For instance, **FREQ** accepts data, but, **LOCAL** does not.

- Check that the synthesizer is in the local (not remote) operating mode.
If the synthesizer is in the remote operating mode, the RMT annunciator will be lit. Press the **LOCAL** key on the front panel to return the synthesizer to local operating mode.

If no cursor (▲) appears over a parameter in the display:

- Check that the ENTRY OFF function is not enabled.
The ENTRY OFF function is enabled when the cursor (▲) doesn't appear over any of the parameters in the display. To return to normal entry mode, press any function key that has a numeric parameter associated with it.
- If the parameter you are trying to enter is not accepted by the synthesizer:

- Ensure that you are not trying to set the parameter greater than or less than its limit. Refer to the HP 83711A/12A and HP 83711B/12B *Synthesized CW Generators User's Guide* for the parameter limits.

- Check that the MSG LED annunciator is off.

When the MSG annunciator is on, the synthesizer is reporting an error condition. To determine the error and turn off the MSG annunciator, refer to "To Read the Contents of the Error Queue" as well as the listing of error messages in the HP 83711A/12A and HP 83711B/12B *Synthesized CW Generators User's Guide*.

No RF Output

If there is no signal at the RF OUTPUT connector:

- Check that the signal at the RF OUTPUT connector is turned on.
(If the RF OUTPUT connector is turned off, the text OFF will be displayed in place of dBm in the display.)
- If the signal at the RF OUTPUT connector is turned off, press the **RF ON/OFF** key once to turn it on.

Other Documentation

The following manuals or kits are available for HP 83711A/12A and HP 83711B/12B operation and service:

Quick Start Guide (this manual)	83711-90133
User's Guide	83711-90131
Programming Guide	83711-90132
Calibration Kit	5063-1635
Calibration Software	5010-7723
Calibration Guide	83731-90125
Service Guide (Option OBW)	83711-90134
Component Level Information (Option OBV)	83731-90126

Index

A ALC IN connector, v

annunciators, v

↑ key, v

⇐ key, v

⇒ key, v

† key, v

Automatic Level Control. *See* ALC

Automatic Level Control keys, v

B BACKSPACE key, v

C Calibration Kit, 1-14

carrier keys, v

Component Level Information (Option OBV), 1-14

cursor, v

D

data entry keys, v

Data Entry Problems, 1-12

diode detector leveling

using, 1-7

E

earth ground

for safety, 1-2

ENTRY OFF key, 1-12

error messages

user-oriented, v

F

fan

checking, 1-10

fuse

checking, 1-10

Index-2

I If You Encounter a Problem, 1-9-13
In This Book, v

K knob, v

L leveling
using diode detector, 1-7
LINE switch, v
line voltage selector, 1-2
LOCAL key, 1-12

M mating connectors
RF OUTPUT, v
MSG annunciator, 1-11, 1-12
MSG key, v

N No RF Output, 1-12-18

O Other Documentation, 1-13
overview
book, v

P power cable, 1-2
POWER/LINE switch, 1-2
Power-Up Problems, 1-11
Power-Up Problems, 1-10ff
problems
data entry, 1-12
power-up, 1-10-11

Programmer's Reference, 1-14

Q Quick Start Guide, 1-14

R RECALL key, v
RF OUTPUT connector, v
RMT annunciator, 1-12

S SAVE key, v

Service Manual (Option OBW), 1-14

SHIFT key, v

SPCL key, v

Special functions, v

STEP SIZE key, v

summary

book, v

Synthesizer at a Glance, iv-5

T

terminator keys, v, 1-5

To Generate a CW Signal, 1-6

To Get Started, 1-2-3

To Use External Diode Detector Leveling, 1-7

To Use the Synthesizer, 1-3-5

troubleshooting. See If You Encounter a Problem

U

units terminator keys. See terminator keys

User's Guide, 1-14

Using the Synthesizer, 1-9