

**8410S  
NETWORK  
ANALYZER  
SYSTEMS**

OPERATING AND SERVICE MANUAL

*The Hewlett-Packard Company certifies that this instrument was thoroughly tested and inspected and found to meet its published specifications when it was shipped from the factory. The Hewlett-Packard Company further certifies that its calibration measurements are traceable to the U.S. National Bureau of Standards to the extent allowed by the Bureau's calibration facility.*

## **CERTIFICATION**

All Hewlett-Packard products are warranted against defects in materials and workmanship. This warranty applies for one year from the date of delivery, or, in the case of certain major components listed in the operating manual, for the specified period. We will repair or replace products which prove to be defective during the warranty period provided they are returned to Hewlett-Packard. No other warranty is expressed or implied. We are not liable for consequential damages.

Service contracts or customer assistance agreements are available for Hewlett-Packard products that require maintenance and repair on-site.

For any assistance, contact your nearest Hewlett-Packard Sales and Service Office. Addresses are provided at the back of this manual.

08410-91008 Printed: SEPT 1969  
 Copyright HEWLETT-PACKARD COMPANY 1969  
 1501 PAGE MILL ROAD, PALO ALTO, CALIFORNIA, U.S.A.

| INSTRUMENT | SERIAL NO. PREFIX |
|------------|-------------------|
| 8410A      | 932- and above    |
| 8411A      | 930- and above    |
| 8413A      | 903- and above    |
| 8414A      | 936- and above    |
| 8743A      | 917- and above    |
| 8745A      | 906- and above    |

This manual applies directly to component instruments with the serial numbers listed below.

**SERIALS PREFIXED**

**NETWORK ANALYZER SYSTEMS**  
**8410S**  
**Option 100**  
**Option 200**  
**Option 300**



TABLE OF CONTENTS

| Section                          | Page | Section                             | Page |
|----------------------------------|------|-------------------------------------|------|
| I                                | 1-1  | III                                 | 3-1  |
| GENERAL INFORMATION              | 1-1  | OPERATION                           | 3-1  |
| 1-1. Description                 | 1-1  | 3-1. Introduction                   | 3-1  |
| 1-7. Accessories Furnished       | 1-1  | 3-3. Operating Precautions          | 3-1  |
| 1-8. Accessory Kit               | 1-1  | 3-5. Measurement Procedures         | 3-1  |
| 1-10. Other Accessories          | 1-2  | 3-6. Measurement Procedures         | 3-1  |
| 1-12. Accessories Available      | 1-2  | 3-8. Measurement Procedures         | 3-1  |
| 1-13. Adapters                   | 1-2  | 3-10. Measurement Procedures        | 3-1  |
| 1-15. Fixed Coaxial Attenuators  | 1-2  | 3-12. Measurement Procedures        | 3-1  |
| 1-17. Accessories for Transistor | 1-2  | 3-17. Measurement Procedures        | 3-1  |
| Measurement with 8410S-100       |      | 3-17. Increased Accuracy for Trans- |      |
| System                           |      | mission Measurements in             |      |
| 1-2                              |      | 8410S-200 System                    |      |
| 1-2                              |      | 3-12                                |      |
| 2-1                              |      | MAINTENANCE                         |      |
| 2-1                              |      | 4-1                                 |      |
| 2-9. Power Cable                 | 2-1  | 4-6. Troubleshooting                | 4-1  |
| 2-6. 115/230 Volt Operation      | 2-1  | 4-3. Performance Test               | 4-1  |
| 2-4. Power Requirements          | 2-1  | 4-1. Introduction                   | 4-1  |
| 2-3. Preparation for Use         | 2-1  |                                     |      |
| 2-1. Incoming Inspection         | 2-1  |                                     |      |
| 2-1. Installation                | 2-1  |                                     |      |
| 2-16. Repackaging for Shipment   | 2-1  |                                     |      |
| 2-14. Rack Mounting              | 2-1  |                                     |      |
| 2-12. Bench Use                  | 2-1  |                                     |      |
| 2-9. Power Cable                 | 2-1  |                                     |      |
| 2-6. 115/230 Volt Operation      | 2-1  |                                     |      |
| 2-4. Power Requirements          | 2-1  |                                     |      |
| 2-3. Preparation for Use         | 2-1  |                                     |      |
| 2-1. Incoming Inspection         | 2-1  |                                     |      |
| 2-1. Installation                | 2-1  |                                     |      |

LIST OF ILLUSTRATIONS

| Number | Title   | Page | Number | Title  | Page |
|--------|---|------|--------|--|------|
| 1-1.   | Model 8410S Network Analyzer  | 1-0  | 3-7.   | Typical Polar Plot Showing Locus of Measured Reflection when Sliding Load is Moved       | 3-12 |
| 2-1.   | Preparation for Rack Mounting   | 2-0  | 3-8.   | Center of Polar Display, Showing Locus of Sliding Load Vector with Directivity Cancelled | 3-12 |
| 3-1.   | Transmission and Reflection Measure-  | 3-2  | 4-1.   | Performance Test Procedures Common to all Systems  | 4-3  |
| 3-2.   | Reflection Measurement with 8410S-100 System  | 3-4  | 4-2.   | Performance Test for 8410S-100 System  | 4-23 |
| 3-3.   | Polar Display   | 3-4  | 4-3.   | Performance Test for 8410S-200 System  | 4-30 |
| 3-4.   | 8410S-200 System Using 8414A  | 3-6  | 4-4.   | Typical Pattern of a Swept VSWR Measurement  | 4-36 |
| 3-5.   | Reflection Measurements with 8410S-200 System Using 8413A Display Unit                    | 3-8  | 4-5.   | Test Setup for Model 8410S-100 and 8410S-300 Troubleshooting                             | 4-37 |
| 3-6.   | Transmission Measurements with 8410S-200 System Using 8413A Display Unit                  | 3-10 | 4-6.   | Test Setup for Model 8410S-100 and 8410S-300 Troubleshooting Tree                        | 4-37 |
| 3-6.   | Typical Polar Plot Showing Measured Reflection as the Sum of Directivity and Load Vectors | 3-1  | 4-7.   | Test Setup for Model 8410S-200 and 8410S-300 Troubleshooting Tree                        | 4-39 |
| 4-1.   | Specifications  | 1-1  | 4-8.   | System Troubleshooting Tree  | 4-39 |
| 1-2.   | Instruments Included in 8410S System  | 1-1  |        |  |      |
| 1-3.   | Parts Included in Accessory Kit No. 11650A  | 1-1  |        |  |      |
| 1-4.   | Adapters for Non-APC-T Connectors   | 1-2  |        |  |      |
| 1-5.   | HP 8492A Series Attenuators   | 1-2  |        |  |      |
| 4-1.   | Recommended Test Equipment  | 4-1  |        |  |      |

LIST OF TABLES

| Number | Title                                      | Page |
|--------|--|------|
| 1-1.   | Specifications                             | 1-3  |
| 1-2.   | Instruments Included in 8410S System       | 1-1  |
| 1-3.   | Parts Included in Accessory Kit No. 11650A | 1-1  |
| 1-4.   | Adapters for Non-APC-T Connectors          | 1-2  |
| 1-5.   | HP 8492A Series Attenuators                | 1-2  |
| 4-1.   | Recommended Test Equipment                 | 4-1  |

Figure I-1. Model 8410S Network Analyzer Systems

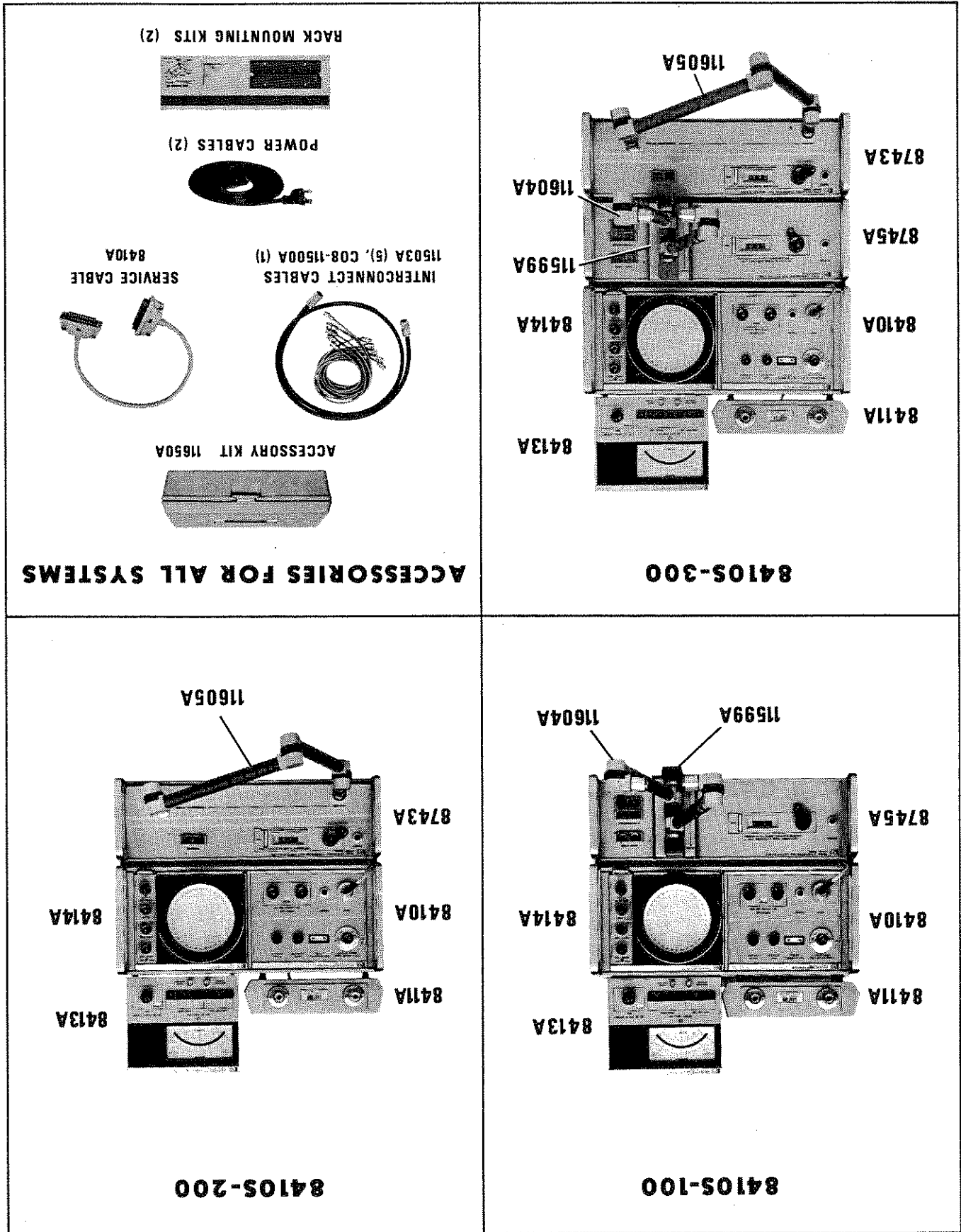

SECTION I

GENERAL INFORMATION

1-1. DESCRIPTION.

1-2. The Model 8410S Network Analyzer System is composed of a number of instruments grouped together to form a measurement system. The system measures reflection and transmission characteristics of micro-ferent systems are available, the Model 8410S-100 system covers the frequency range between 0.11 and 2.0 GHz, the Model 8410S-200 system covers the frequency range between 2.0 and 12.4 GHz, and the 8410S-300 system combines instruments of the -100 and -200 systems to cover the entire range of 0.11 to 12.4 GHz. The specifications for the three systems are listed in Table 1-1.

This eliminates the need for changing connections when making both transmission and reflection tests. Both transducers have flexible arm accessories which allow connection to a unit under test of almost any configuration.

1-5. The instruments which form the three systems are listed in Table 1-2. Basically, there is a low frequency system (8410S-100) and a high frequency system (8410S-200). The 8410S-300 system includes two transducer instruments (8743A and 8745A) and their accessories to cover the full frequency range covered by both the 8410S-100 and 8410S-200 systems and provides all the measurement capabilities of the other two systems.

1-6. The 8410S Network Analyzer Systems were designed to work with Hewlett-Packard sweep oscillators such as the HP 690 and 8690 Series. If any other sweep oscillator is used, the sweep signal specifications should be checked against the signal requirements listed in the 8410A Operating and Service Manual.

1-7. ACCESSORIES FURNISHED.

1-8. ACCESSORY KIT.

1-9. An accessory kit, HP Model 11650A, is included with each system. It contains the accessories most used for making various types of measurements, as well as tools for repairing the APC-7 type connectors. A list of the parts included in the accessory kit is presented in Table 1-3.

| Instrument or Accessory                 | Included in System |      |      |
|---|--------------------|------|------|
|   | -100               | -200 | -300 |
| 8410A Network Analyzer                  | X                  | X    | X    |
| 8411A Harmonic Freq. Converter          | X                  | X    | X    |
| 8413A Phase-Gain Indicator Plug-In      | X                  | X    | X    |
| 8414A Polar Display Plug-In             | X                  | X    | X    |
| 8745A S-Parameter Test Set              | X                  |      |      |
| 11599A Quick-Connect Adapter            | X                  |      |      |
| 11604A Universal Extension              | X                  |      |      |
| 8743A Reflection-Transmission Test Unit | X                  | X    | X    |
| 11605A Flexible Arm Accessory Kit       | X                  | X    | X    |
| 11503A Interconnect Cable (5)           | X                  | X    | X    |
| C08-11500A Interconnect Cable (1)       | X                  | X    | X    |

Table 1-2. Instruments Included in 8410S Systems

| Description   | Model           | Qty. |
|---|-----------------|------|
| APC-7 to N Female Adapter                           | 11524A          | 2    |
| APC-7 to N Male Adapter                             | 11525A          | 2    |
| 3-dB Attenuator with APC-7 Connectors               | 8492A Option 03 | 1    |
| 10-dB Attenuator with APC-7 Connectors              | 8492A Option 10 | 1    |
| 20-dB Attenuator with APC-7 Connectors              | 8492A Option 20 | 1    |
| APC-7 Contact Extractor                             | 5060-0236       | 1    |
| Spanner Wrench                                      | 5060-0237       | 1    |
| 1/2 Inch and 9/16 Inch Open End Wrench              | 8710-0877       | 1    |
| Replacement APC-7 Inner Conductor Contacts          | 1250-0907       | 5    |
| Type N Female Short                                 | 11511A          | 1    |
| Type N Male Short                                   | 11512A          | 1    |
| APC-7 Short   | 11565A          | 1    |
| For maintenance of precision 7-mm APC-7 Connectors. |                 |      |

Table 1-3. Parts Included in Accessory Kit No. 11650A

1-17. ACCESSORIES FOR TRANSISTOR MEASUREMENT WITH 8410S-100 SYSTEM.

1-18. The Hewlett-Packard Models 11600A and 11602A Transistor Fixtures prove a convenient and accurate way to hold transistors and many other devices when making s-parameter measurements from 0.1 to 2.0 GHz. The 11600A accepts transistors with T0-18 and T0-72 base patterns, and has four snap-on dials, two for bi-polar transistors and two for FET's. The 11602A accepts transistors with T0-5 and T0-12 base patterns. It has two snap-on dials for different types of bipolar transistors and provides for FET's without a dial.

1-19. The 11601A and 11603A Calibration Sets are used with transistor fixtures to obtain greater accuracy. The kit consists of a short circuit termination, a 50-ohm through section, and a 50-ohm termination. The Model 11601A is used with the Model 11600A Transistor Fixture and the Model 11603A is used with the Model 11602A Transistor Fixture.

1-20. The Hewlett-Packard 8717A Transistor Power Supply is designed especially for use with the 8745A S-Parameter Test Set and the 11600A and 11602A Transistor Fixtures. This programmable supply provides bias levels for the semiconductor devices tested in the fixtures. Feedback circuits within the supply provide very stable bias conditions. Overload protection for the device under test is selectable. Maximum current is 500 mA and maximum voltage is 30 Vdc.

Table 1-5. HP 8492A Series Attenuators

| Number | Attenuation | MAX. SWR (up to 12.4 GHz) |
|--------|-------------|---------------------------|
| 03     | 3 dB        | 1.3:1                     |
| 06     | 6 dB        | 1.3:1                     |
| 10     | 10 dB       | 1.25:1                    |
| 20     | 20 dB       | 1.25:1                    |
| 30     | 30 dB       | 1.25:1                    |
| 40     | 40 dB       | 1.25:1                    |
| 50     | 50 dB       | 1.25:1                    |
| 60     | 60 dB       | 1.25:1                    |

1-10. OTHER ACCESSORIES.

1-11. A number of miscellaneous accessories are included with the system. Interconnecting cables are included to connect the individual instruments together. These include five cables with BNC connectors and one RF cable with type N connectors. A servicing cable is included with the 8410A to allow servicing the plug-in units outside of the mainframe. One end of the cable plugs into the rear of the plug-in and the other end of the cable plugs inside the 8410A mainframe at the rear of the plug-in compartment. Rack-mounting kits are included with each instrument to allow rack-mounting of the system. The 8410A has a helix filter kit included so that if an HP Model 690 or 8690A series sweep oscillator is used for the signal source, the sweeper may be modified by adding the kit to make it compatible with the 8410A phase lock system. Model 8690A sweep oscillators with serial number 803-2061 and above have the filter already installed.

1-12. ACCESSORIES AVAILABLE.

1-13. ADAPTERS.

1-14. Table 1-4 lists adapters available to accommodate some of the most common connector types.

1-15. FIXED COAXIAL ATTENUATORS.

1-16. Besides the three attenuators contained in the accessory kit, other values of attenuation may be used to reduce power or to improve the signal-to-noise ratio for wide range attenuation and amplification measurements. Table 1-5 lists the attenuation values available in the HP 8492A series units with APC-7 connectors.

Table 1-4. Adapters for Non-APC-7 Connectors

| Adapter           | Mfr. Number | Number |
|-------------------|-------------|--------|
| APC-7 to N female | 11524A      | 1      |
| APC-7 to N male   | 11525A      | 1      |
| APC-7 to OSM male | 11533A      | 1      |
| APC-7 to BNC      |             | 2      |
| APC-7 to TNC      |             | 2      |
| APC-7 to GR900    |             | 2      |
| APC-7 to GR874    |             | 2      |
| APC-7 to NPM      |             | 3      |

1. Hewlett-Packard  
 2. Amphenol RF Division, Danbury Connecticut  
 3. Narada Microwave Corp., Long Island, N. Y.



Table 1-1. Specifications

**SPECIFICATIONS COMMON TO 8410S-100,-200, and -300 SYSTEMS**

**DESCRIPTION**

**FUNCTION:** All systems measure transmission and reflection parameters on a swept-frequency and reflection in the form of attenuation, gain, phase shift, reflection coefficient, return loss, and impedance, depending on readout display.

**DISPLAY UNITS**

**8413A PHASE GAIN INDICATOR:**

Meter readout of amplitude in dB and phase in degrees.  
**AMPLITUDE RANGES:**  $\pm 3, \pm 10, \pm 30$  dB full scale.  
**PHASE RANGES:**  $\pm 6, \pm 18, \pm 60, \pm 180$  degrees full scale.

**RESOLUTION:** 0.1 dB, 0.1 degree.

Swept-frequency readout with oscilloscope or X-Y recorder.

**AMPLITUDE:** Front-panel analog output at 50mV/dB, 10-kHz bandwidth. Also, rear output 0-1 volt linear, proportional to ratio of test and reference signals.

**PHASE:** Front-panel analog output at 10 mV/degree, 10-kHz bandwidth.

**8414A POLAR DISPLAY:**

Polar coordinate CRT with magnitude calibration divisions at 20, 40, 60, 80, and 100% of full scale. Outer range settable by IF Gain Control and amplitude vernier.

Accepts marker signals from HP sweep oscillators, -5V peak, which appear as intensified dot on CRT face. Accepts blanking pulse, -4V, from HP sweep oscillators to blank retrace during swept operation.  
**CONNECTORS:** RF Input, Type N female, stainless steel; Measurement Ports APC-7 precision 7-mm connectors.

**PERFORMANCE**

**TRANSMISSION MEASUREMENT ACCURACY**

**AMPLITUDE ACCURACY:** (using 8413A)

**RANGE:** Full 60-dB dynamic range.  
**IF GAIN CONTROL:** 69 dB in 10-dB and 1-dB steps.

$\pm 0.1$  dB/10 dB  
 $\pm 0.05$  dB maximum cumulative

**AMPLITUDE VERNIER:** 2-dB range. Meter:  $\pm 3\%$  of full scale,  $\pm 0.05$  dB for readings between 0 and 0.5 dB only.

**PHASE ACCURACY:**

Accuracy curves show overall system uncertainty when measuring amplitude and phase. Sources of error included are IF gain control, meter accuracy, phase offset, system noise, and crosstalk. System frequency response is specified separately and is not included in accuracy curves.

**OFFSET RANGE:**  $\pm 180^\circ$  in  $10^\circ$  steps.  
**OFFSET ACCURACY:**  $\pm 0.3^\circ/10^\circ$  step,  $\pm 1.5^\circ$  maximum cumulative for equal signal levels in reference and test channels. Add  $\pm 2^\circ$  maximum to above for 60-dB difference between reference and test channels.

**METER:**  $\pm 2\%$  of full scale.

**PHASE VERNIER:** 90° range.

**REFERENCE PLANE EXTENSION:** 0 to 15 cm for reflection; 0 to 30 cm for transmission; calibrated by digital dial indicator. Indicator is adjustable for initial calibration.

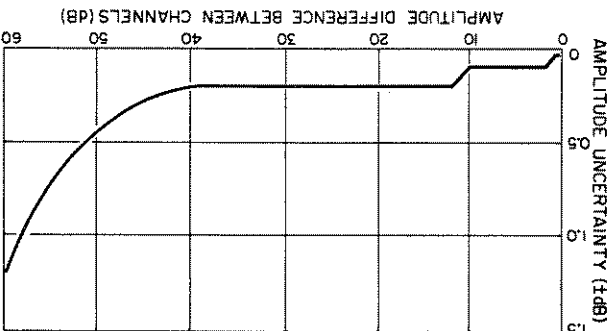

Amplitude uncertainty for transmission measurements as a function of amplitude measured.

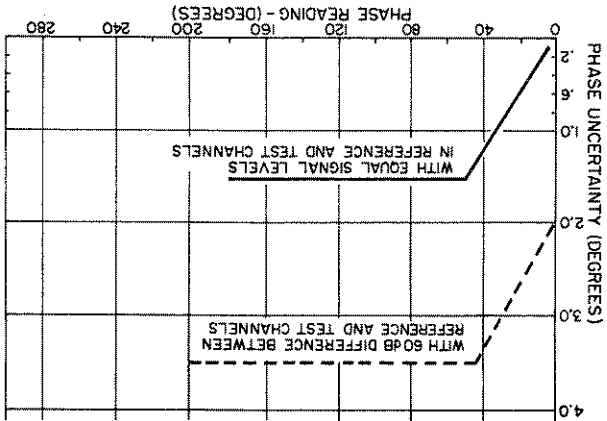

Phase uncertainty for transmission measurements as a function of phase shift measured.

Table 1-1. Specifications (Contd)

**8410S-100 SPECIFICATIONS**

**FREQUENCY RANGE:** 0.11 to 2.0 GHz.

**TRANSMISSION-REFLECTION SELECTION:** Manual by front panel, lighted pushbuttons; remote by contact closure or saturated transistors through 36-pin connector contacts. Short circuit current, 12 mA; open circuit voltage, 12 Vdc.

**RF INPUT:** 20-dB range between -21 dbm and +7 dbm. 20-dB variation causes less than 1.5 dB and 4° change in amplitude and phase readings.

**SOURCE REFLECTION COEFFICIENT:<sup>1</sup>**  
 $\leq 0.09$  ( $\leq 1.2$  SWR), 0.11 - 2.0 GHz

**TERMINATION REFLECTION COEFFICIENT:<sup>2</sup>**  
 $\leq 0.11$  ( $\leq 1.25$  SWR), 100-200 MHz  
 $\leq 0.09$  ( $\leq 1.20$  SWR), 200-2000 MHz

**DIRECTIVITY:**  
 $> 36$  dB (typically  $> 39$  dB) 0.11 - 1.0 GHz  
 $> 32$  dB (typically  $> 36$  dB) 1.0 - 2.0 GHz

**INSERTION LOSS, RF INPUT TO TEST PORT:**  
 4 dB nominal.

**FREQUENCY RESPONSE:**  
**TRANSMISSION:** Typically  $\pm 0.35$  dB Amplitude and  $\pm 3^\circ$  phase.

**REFLECTION:** Typically  $\pm 0.06$  Magnitude and  $\pm 5^\circ$  phase as read on the 8414A polar display with a short on the test port.

**TRANSMISSION MEASUREMENT ACCURACY**  
 (See common performance specifications)

**REFLECTION MEASUREMENT ACCURACY:**

Accuracy curves below show overall system uncertainty when measuring reflection coefficient. Sources of error included are directivity, source match, and polar display accuracy. System frequency response is specified separately and is not included in the accuracy curves.

**1 Source Reflection Coefficient:** Reflection coefficient of the port used to supply incident signal to the device under test.

**MAGNITUDE ACCURACY:**

$$p_u = \pm(0.015 + 0.06p_L^2) \quad 0.11 - 1.0 \text{ GHz}$$

$$p_u = \pm(0.025 + 0.06p_L^2) \quad 1.0 - 2.0 \text{ GHz}$$

$p_u$  = magnitude uncertainty  
 $p_L$  = measured reflection coefficient magnitude

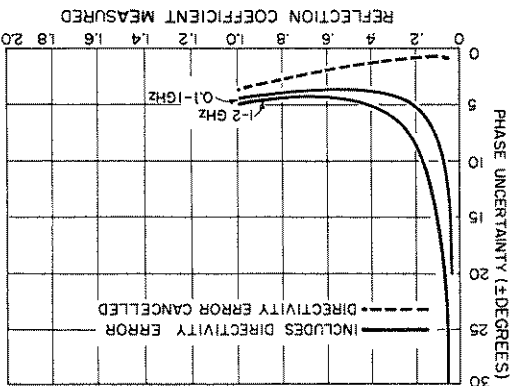

Reflection coefficient magnitude uncertainty including coupler directivity and when directivity is cancelled using a low VSWR load.

**PHASE ACCURACY:**

$$\phi_u = \sin^{-1} \frac{p_L}{p_u} \quad \text{for } \phi < 90^\circ$$

$\phi_u$  = phase uncertainty

(See Magnitude above for  $p_u$ ,  $p_L$  terms)

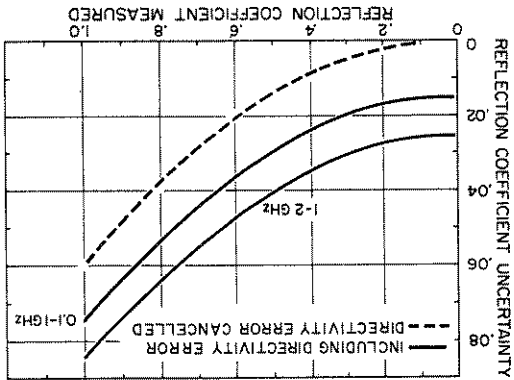

Reflection coefficient phase uncertainty including coupler directivity and when directivity is cancelled using a low VSWR load.

**2 Termination Reflection Coefficient:** Reflection coefficient of port connected to output of test device when transmission or reflection measurement is being made.

Table I-1. Specifications (Contd)

**8410S-200 SPECIFICATIONS**

**FREQUENCY RANGE:** 2.0 to 12.4 GHz.

**TRANSMISSION-REFLECTION SELECTION:** Manual, by front panel, lighted pushbuttons; remote, by contact closure or saturated transistors through 36-pin connector contacts. Short circuit current, 12 mA; open circuit voltage, 12 Vdc.

**RF INPUT:** 20-dB range between -14 dBm and +14 dBm. 20-dB variation causes less than 1.5 dB and 4° change in amplitude and phase readings.

**SOURCE REFLECTION COEFFICIENT: 1**

$\leq 0.09$  (1.2 SWR), 2-8 GHz

$\leq 0.13$  (1.3 SWR), 8-12.4 GHz

**TERMINATION REFLECTION COEFFICIENT: 2**

$\leq 0.09$  (1.2 SWR), 2-8 GHz

$\leq 0.13$  (1.3 SWR), 8-12.4 GHz

**DIRECTIVITY:**  $\geq 30$  dB, 2-12.4 GHz.

**INSERTION LOSS, RF INPUT TO TEST PORT:** 20 dB nominal.

**FREQUENCY RESPONSE:**

**TRANSMISSION:** Typically  $\pm 0.5$  dB Amplitude  $\pm 5^\circ$  phase.

**REFLECTION:** Typically  $\pm 0.06$  Magnitude and  $\pm 7^\circ$  phase, as read on the 8414A with a short on the unknown port.

**TRANSMISSION MEASUREMENT ACCURACY**

(See common performance specifications)

**REFLECTION MEASUREMENT ACCURACY:**

Accuracy curves show overall system uncertainty when measuring reflection coefficient. Sources of error included are directivity, source match, and polar display accuracy. System frequency responses is specified separately and is not included in the accuracy curves.

**1 Source Reflection Coefficient:** Reflection coefficient of the port used to supply incident signal to the device under test.

**2 Termination Reflection Coefficient:** Reflection coefficient of port connected to output of test device when using a sliding load.

**MAGNITUDE ACCURACY:**

$p_u = \pm(0.032 + 0.03p_L + 0.03p_L^2)$ , 2-8 GHz

$p_u = \pm(0.032 + 0.04p_L + 0.04p_L^2)$ , 8-12.4 GHz

$p_u$  = magnitude uncertainty

$p_L$  = measured reflection coefficient magnitude

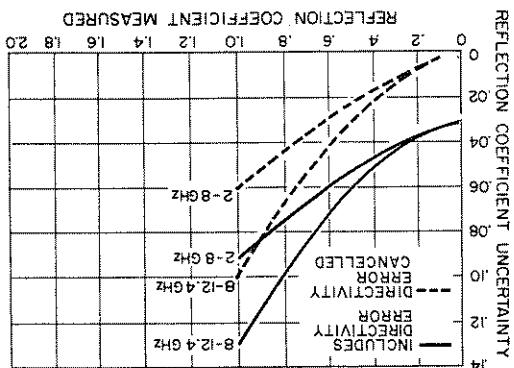

Reflection coefficient magnitude uncertainty including coupler directivity and when directivity is cancelled using a sliding load.

**PHASE ACCURACY:**

$\phi_u = \sin^{-1} \frac{p_L}{p_u}$  for  $\phi_u < \pm 90^\circ$

$p_u$  = phase uncertainty

(See Magnitude above for  $p_u$ ,  $p_L$  terms)

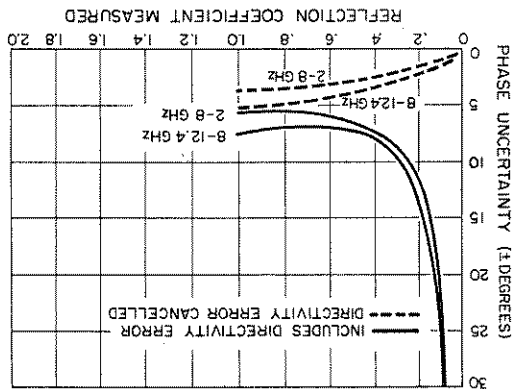

Reflection coefficient phase uncertainty including coupler directivity and when directivity is cancelled using a sliding load.

**2 Termination Reflection Coefficient:** Reflection coefficient of port connected to output of test device when using a sliding load.

Table 1-1. Specifications (Contd)

8410S-300 SPECIFICATIONS

FREQUENCY RANGE: 0.11 to 12.4 GHz, Specifications for Model 8410S-300 are a combination of Models 8410S-100 and 8410S-200. All specifications for those models pertain directly to the 8410S-300 at the frequencies of interest.

INDIVIDUAL INSTRUMENT SPECIFICATIONS

8410A NETWORK ANALYZER AND 8411A HARMONIC FREQUENCY CONVERTER

FUNCTION: 8411A Harmonic Frequency Converter converts RF signals to IF signals for processing in 8410A mainframe. 8410A is the mainframe for display plug-in units. The mainframe includes tuning circuits, IF amplifiers and precision IF attenuator. FREQUENCY RANGE: 0.11 to 12.4 GHz.

8411A INPUT IMPEDANCE: 50 ohms nominal. SWR <1.5, 0.11 to 8 GHz; <2.0, 8 to 12.4 GHz; connectors precision 7 mm coax (APC-7).

CHANNEL ISOLATION: >65 dB, 0.1 to 6 GHz; >60 dB, 6 to 12.4 GHz.

AMPLITUDE

AMPLITUDE RANGE:

REFERENCE CHANNEL: 20-dB range between -16 and -44 dBm; meter indicates proper range. 20 dB variation causes less than 1.5 dB and 4° change in amplitude and phase readings.

TEST CHANNEL: -10 to -78 dBm.

MAXIMUM RF INPUT TO EITHER CHANNEL: 50 mW (+17 dBm) (damage level).

MAXIMUM DC ON RF LINE: +3V.

IF GAIN CONTROL: Adjusts gain of test channel relative to reference channel.

RANGE: 69 dB total in 10-dB and 1-dB steps; vernier provides continuous adjustment over at least 2 dB

ACCURACY: ±0.1 dB per 10-dB steps, ±0.05 dB per 1-dB step. Maximum cumulative, ±0.2 dB.

GENERAL

OUTPUTS: Two rear panel auxiliary outputs provide 278 kHz IF signals; outputs may be used for signal analysis, special applications, and convenient test points; modulation bandwidth nominally 10 kHz. REFERENCE CHANNEL IF: 2 volts peak-to-peak. TEST CHANNEL IF: 10 volts peak-to-peak or less, depending on signal level and test channel gain setting. POWER: 115 or 230 volts ±10%, 50 to 60 Hz, 70 watts (includes 8411A).

WEIGHT:

8410A: Net, 34 lb (15, 2 kg).

8411A: Net, 6-1/4 lb (2, 8 kg).

DIMENSIONS:

8410A: 7 in. high, 8-3/8 in. deep, 16-3/4 in. wide (17, 8 x 21, 3 x 42, 5 cm).

8411A: 2-5/8 in. high, 5-5/8 in. deep, 9 in. wide (6, 8 x 14, 3 x 22, 9 cm), exclusive of connectors.

5-ft cable permanently attached for connection to 8410A.

Table I-1. Specifications (Contd)

**INDIVIDUAL INSTRUMENT SPECIFICATIONS**

**8413A PHASE-GAIN INDICATOR**

**FUNCTION:** Plug-in meter display unit for 8410A. Displays relative amplitude in dB between reference and test channel inputs or relative phase in degrees. Pushbutton selection of meter function and range.

**RANGE:** ±30, ±10, and ±3 dB full scale.

**ACCURACY:** ±8% of meter end scale.

**LOG OUTPUT:** 50 millivolts per dB up to 60 dB total; 10-kHz nominal bandwidth depending on signal level; source impedance 1 k $\Omega$ ; accuracy same as meter.

**LINEAR OUTPUT (Rear Panel):** 0 to 1 V maximum; 10-kHz bandwidth; 250 $\Omega$  source impedance.

**PHASE RESPONSE VERSUS SIGNAL AMPLITUDE:** 1.5 degrees maximum phase change for 60-dB amplitude change in test channel.

**GENERAL**

**PHASE OFFSET:** ±180 degrees in 10-degree steps. ACCURACY:  $\pm(0.2^\circ + 0.3^\circ/10^\circ \text{ step})$ , does not exceed 2° cumulative referenced from 0°.

**PHASE RESPONSE VERSUS SIGNAL AMPLITUDE:** 1.5 degrees maximum phase change for 60-dB amplitude change in test channel.

**AMPLITUDE**

**RANGE:** ±30, ±10, and ±3 dB full scale.

**ACCURACY:** ±8% of meter end scale.

**LOG OUTPUT:** 50 millivolts per dB up to 60 dB total; 10-kHz nominal bandwidth depending on signal level; source impedance 1 k $\Omega$ ; accuracy same as meter.

**LINEAR OUTPUT (Rear Panel):** 0 to 1 V maximum; 10-kHz bandwidth; 250 $\Omega$  source impedance.

**PHASE**

**RANGE:** ±180, ±60, ±18, ±6 degrees full scale. ACCURACY: ±2% of meter end scale.

**OUTPUT:** 10 millivolts per degree; 10-kHz bandwidth; 1 k $\Omega$  source impedance. Accuracy ±2% of reading on auxiliary display or ±1 mV, whichever is greater.

**8414A POLAR DISPLAY**

**FUNCTION:** Plug-in CRT display unit for 8410A. Displays amplitude and phase data in polar coordinates on 5-in. cathode ray tube.

**RANGE:** Normalized polar coordinate display; magnitude calibration 20% of full scale per division. Scale factor is a function of IF setting on 8410A. Phase calibrated in 10-degree increments over 360-degree range.

**ACCURACY:** Error circle on CRT < 3 mm.

**OUTPUTS:** Two dc outputs provide horizontal and vertical components of polar quantity. Maximum output ±2.5 volts, < 100 $\Omega$  source impedance, bandwidth (3 dB) 10 kHz.

**BEAM CENTER:** Pressing BEAM CTR simulates zero-signal-input. Allows convenient beam position adjustment for reference.

**GENERAL**

**FUNCTION:** Plug-in meter display unit for 8410A. Displays relative amplitude in dB between reference and test channel inputs or relative phase in degrees. Pushbutton selection of meter function and range.

**RANGE:** ±30, ±10, and ±3 dB full scale.

**ACCURACY:** ±8% of meter end scale.

**LOG OUTPUT:** 50 millivolts per dB up to 60 dB total; 10-kHz nominal bandwidth depending on signal level; source impedance 1 k $\Omega$ ; accuracy same as meter.

**LINEAR OUTPUT (Rear Panel):** 0 to 1 V maximum; 10-kHz bandwidth; 250 $\Omega$  source impedance.

**PHASE RESPONSE VERSUS SIGNAL AMPLITUDE:** 1.5 degrees maximum phase change for 60-dB amplitude change in test channel.

**PHASE OFFSET:** ±180 degrees in 10-degree steps. ACCURACY:  $\pm(0.2^\circ + 0.3^\circ/10^\circ \text{ step})$ , does not exceed 2° cumulative referenced from 0°.

**PHASE RESPONSE VERSUS SIGNAL AMPLITUDE:** 1.5 degrees maximum phase change for 60-dB amplitude change in test channel.

**MARKER INPUT (Rear Panel):** Accepts frequency marker output pulse from HP 8690-Series and 690-Series sweep oscillators, -5 volts peak. Markers displayed as intensified dot on CRT display.

**BLANKING INPUT (Rear Panel):** Accepts -4 volt RF blanking pulse from HP 8690-Series and 690-Series sweep oscillators to blank retrace during sweep operation.

**BACKGROUND ILLUMINATION:** Controls intensity of CRT background illumination for photography. Eliminates need for ultraviolet light source in oscilloscope camera when photographing internal graticule.

**DRIFT:** CRT,  $< \pm 0.2 \text{ mm}/^\circ\text{C}$ ; auxiliary outputs,  $< \pm 10 \text{ mV}/^\circ\text{C}$ .

**POWER:** Additional 35 watts supplied by 8410A. WEIGHT: Net, 13 lb (5, 8 kg). Shipping, 17-1/2 lb (7, 8 kg).

**DIMENSIONS:** 6 in. high, 15-9/16 in. deep, 7-9/32 in. wide (15, 2 x 39, 5 x 18, 6 cm), excluding front panel knobs.

| INDIVIDUAL INSTRUMENT SPECIFICATIONS   |   |
|--|---|
| <p>8743A REFLECTION/TRANSMISSION TEST UNIT</p>   | <p><b>1</b> Equivalent source reflection coefficient when used with Network Analyzer.</p> <p><b>2</b> Reflection coefficient of port that connects to the 11605A flexible arm.</p>  |
| <p><b>FUNCTION:</b> Wideband RF power splitter and reflectometer with calibrated line stretcher. Pushbutton operated for either transmission or reflection measurements with network analyzer.</p> <p><b>FREQUENCY RANGE:</b> 2-12.4 GHz.</p> <p><b>IMPEDANCE:</b> 50 ohms nominal.</p> <p><b>REFLECTION COEFFICIENT:</b></p> <p>UNKNOWN PORT: 1 2-8 GHz, &lt;math&gt;\leq 0.09&lt;/math&gt; (SWR 1.2); 8-12.4 GHz, &lt;math&gt;\leq 0.13&lt;/math&gt; (SWR 1.30).</p> <p>TRANSMISSION RETURN PORT: 2 2-12.4 GHz, &lt;math&gt;\leq 0.167&lt;/math&gt; (SWR &lt;math&gt;\leq 1.4&lt;/math&gt;).</p> <p><b>DIRECTIVITY:</b> 2-12.4 GHz, &gt; 30 dB.</p> <p><b>FREQUENCY RESPONSE:</b> (Including 8411A Frequency Converter.)</p> <p><b>TRANSMISSION:</b> Typically &lt;math&gt;\pm 0.5&lt;/math&gt; dB Amplitude, &lt;math&gt;&lt; \pm 5^\circ&lt;/math&gt; phase.</p> <p><b>REFLECTION:</b> Typically &lt;math&gt;\pm 0.1&lt;/math&gt; Magnitude, &lt;math&gt;\pm 5^\circ&lt;/math&gt; phase as read on 8414A Polar Display with a short on the unknown port.</p> | <p><b>FUNCTION:</b> Mounts on front of 8743A; connects to device under test. Rotary air lines and rotary joints connect any two-port geometry.</p> <p><b>IMPEDANCE:</b> 50 ohms nominal. Reflection coefficient of ports: &lt;math&gt;\leq 0.11&lt;/math&gt; (1.25 SWR), dc-12.4 GHz.</p> <p><b>CONNECTORS:</b> APC-7</p> |
| <p><b>INSERTION LOSS:</b> 20 dB FROM RF INPUT TO TEST DEVICE; 20 dB nominal. FROM RF INPUT TO REFERENCE CHANNEL OUTPUT: 30 dB nominal.</p> <p><b>MAXIMUM RF POWER:</b> 2 watts.</p> <p><b>REFERENCE PLANE EXTENSION:</b> 0 to 15 cm for reflection; 0 to 30 cm for transmission; calibrated by digital dial indicator. Indicator is adjustable for initial calibration.</p> <p><b>CONNECTORS:</b> Input, Type N female, stainless steel; all other connectors APC-7.</p> <p><b>REMOTE PROGRAMMING:</b> Remote reflection or transmission selection by closing 2 contacts of 36-pin rear panel connector to ground pin. Contact is at 12 volts and short to ground will draw 12 mA.</p> <p><b>POWER:</b> 115 Vac <math>\pm 10\%</math>, 50-400 Hz, 15 W.</p> <p><b>WEIGHT:</b> Net, 27 lb (12, 4 kg).</p> <p><b>DIMENSIONS:</b> 5-1/2 in. high, 16-3/4 in. wide 18-3/8 in. deep (140 x 426 x 467 mm).</p>   | <p><b>INSERTION LOSS:</b> Approximately 1.5 dB.</p> <p><b>WEIGHT:</b> Net, 4 lb (1, 8 kg).</p> <p><b>LENGTH:</b> 10.1 in. (256, 5 mm) closed, 25.5 in. (647, 7 mm) extended.</p>  |
| <p>11605A FLEXIBLE ARM</p>   |   |
| <p><b>1</b> Equivalent source reflection coefficient when used with Network Analyzer.</p> <p><b>2</b> Reflection coefficient of port that connects to the 11605A flexible arm.</p>   |   |

Table 1-1. Specifications (Contd)

Table I-1. Specifications (Contd)

**INDIVIDUAL INSTRUMENT SPECIFICATIONS**

**8745A S-PARAMETER TEST UNIT**

**FUNCTION:** Wideband RF Power Splitter and reflectometer with calibrated line stretcher. Push-button operated for either transmission or reflection measurements with Network Analyzer.

**FREQUENCY RANGE:** 100 MHz to 2 GHz. Can be used below 100 MHz since coupler directivity remains above 36 dB and insertion loss to Reference and Test channel outputs increase  $\approx$  6 dB/octave.

**IMPEDANCE:** 50 ohms nominal.

**SOURCE REFLECTION COEFFICIENT:**  $1 \leq 0.057$  ( $< 1.12$  SWR), 0.11-2.0 GHz.

**TERMINATION REFLECTION COEFFICIENT:**  $2$

**TRANSMISSION:**  $< 0.10$  ( $< 1.22$  SWR), 100-200 MHz  $< 0.063$  ( $< 1.13$  SWR), 200-2000 MHz.

**REFLECTION:**  $< 0.10$  ( $< 1.22$  SWR), 100-200 MHz  $< 0.063$  ( $> 1.13$  SWR), 200-2000 MHz.

**DIRECTIVITY:** 0.1 to 1 GHz,  $> 36$  dB; 1-2 GHz,  $> 32$  dB.

**FREQUENCY RESPONSE:** (Including 8411A frequency converter.)

**TRANSMISSION:** Typically  $\pm 0.35$  dB Amplitude  $< \pm 5^\circ$  phase.

**REFLECTION:** Typically  $\pm 0.06$  Magnitude  $< \pm 5^\circ$  phase as read on the 8414A with a short on the test port.

**FUNCTION:** Mounts on front of 8745A; connects to device under test. Rotary air lines and rotary joints connect to any two-port geometry.

**FREQUENCY RANGE:** dc to 2 GHz

**<sup>1</sup>Equivalent source reflection coefficient when used with Network Analyzer.**

**11604A UNIVERSAL EXTENSION**

**IMPEDANCE:** 50 ohms nominal, reflection coefficient 0.035 (1.07 SWR).

**WEIGHT:** Net, 4 lb (1.8 kg).

**DIMENSIONS:** 10-1/2 x 5 x 1-1/4 in. (267 x 127 x 31, 6 mm).

**<sup>2</sup>Reflection coefficient of port that connects to the 11605A flexible arm.**

**CONNECTORS:** RF INPUT: Type N female  
 TEST PORTS: APC-7 precision connectors.  
 OUTPUTS TO 8411A: Mates with APC-7 precision connectors.

**REMOTE PROGRAMMING:** Remote S-parameter selection by closing 2 contacts of 36-pin rear panel connector to ground pin. Contact is at 12 volts and short to ground will draw 12 mA.

**TRANSISTOR BIASING:** Bias and bias sensing connections are made to the biasing networks built into the 8745A via the 36-pin rear panel connector.

**MAXIMUM BIAS:** 100 Vdc; 1.0 amp.

**POWER:** 115 or 230  $\pm 10\%$ , 50 to 400 Hz, 40 watts

**WEIGHT:** Net, 34-1/4 lb (15.9 kg).

**DIMENSIONS:** 5-1/2 x 16-3/4 x 25-3/4 in. (139 x 423 x 650 mm).

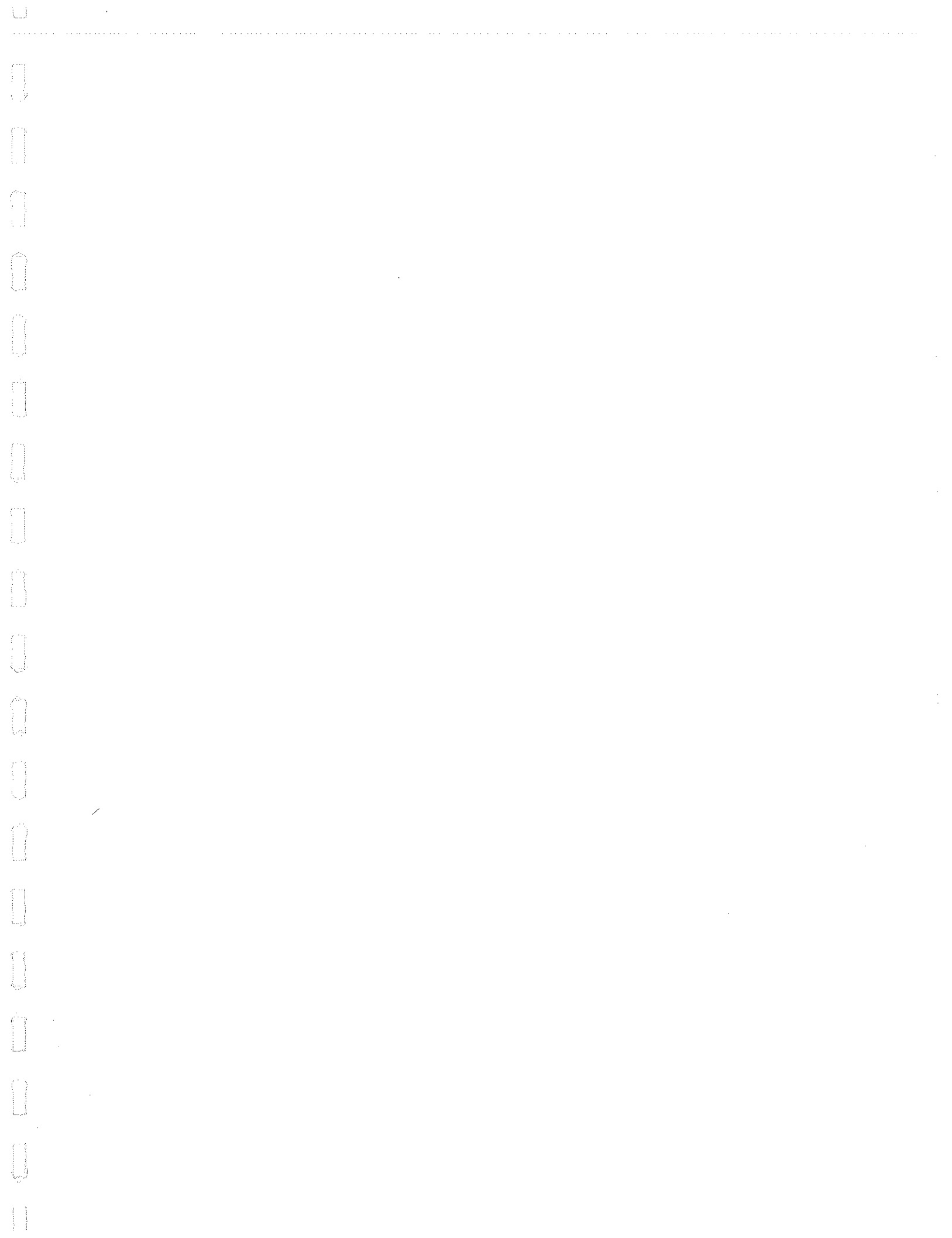



## SECTION II INSTALLATION

- 2-1. INCOMING INSPECTION.**
- 2-2. Instruments in the 8410S System were carefully inspected, both mechanically and electrically, prior to shipment. Inspect them for mechanical damage received in transit, check for supplied accessories, and test electrical performance using the performance test in Section IV. If there is any damage or deficiency, or if electrical performance is not within specifications, notify the carrier and your nearest Hewlett-Packard Sales and Service Office. The field office will arrange for repair or replacement of the instrument without waiting for a possible claim against the carrier to be settled.
- 2-3. PREPARATION FOR USE.**
- 2-4. POWER REQUIREMENTS.**
- 2-5. The Network Analyzer System requires a power source of 115 or 230 volts AC  $\pm 10\%$ , 50 to 60 Hz, single phase, which can supply approximately 200 watts.
- 2-6. 115/230 VOLT OPERATION.
- 2-7. Two-position slide switches on the rear panels permit operation from either a 115- or 230-volt power source. The number visible on the switch slider indicates the line voltage for which the instrument is connected. Adjacent to the switch is the correct fuse rating for each line voltage.
- 2-8. To prepare the instruments in the system for operation, position the 115-230 volt switches so that the numbers visible on the switch slider indicate the available line voltage, and install fuses of correct rating.
- CAUTION**
- To avoid damage to the instruments, set the 115-230 volt switches for the line voltage to be used BEFORE connecting the power cables.
- 2-9. POWER CABLE.**
- 2-10. To protect operating personnel, the National Electrical Manufacturers' Association (NEMA) recommends that the instrument panels and cabinets be grounded. Accordingly, all instruments in the 8410S system are equipped with three-conductor power cables which, when plugged into an appropriate receptacle, ground the panels and cabinets. The offset pin of the three-prong connector is the ground pin.
- 2-11. To preserve the protection feature when operating the system from a two-contact outlet, use a three-prong to two-prong adapter (HP Stock No. 1251-0048) and connect the green wire on the adapter to ground.
- 2-12. BENCH USE.**
- 2-13. The instruments in the system have plastic feet and foldaway tilt stands for convenience in bench operation. The tilt stands permit inclining the instrument for more convenient viewing of the control panels, and the plastic feet are shaped to make full width modular instruments self-aligning when stacked.
- 2-14. RACK MOUNTING.
- 2-15. Preparation for rack mounting is illustrated in Figure 2-1. All necessary hardware is contained in the rack mounting kits supplied with the individual instruments.
- NOTE**
- If the rack-mounted instruments will be subjected to shock or vibration, provide additional bracing at the rear of the cabinets.
- 2-16. REPACKAGING FOR SHIPMENT.**
- 2-17. If one of the instruments in the system is to be packaged for shipment, use the original shipping container and packing materials. If these have been discarded or are not in condition for reuse, contact your local Hewlett-Packard Sales and Service Office (see rear of this manual for locations), or follow these general instructions.
- a. If the instrument is a Model 8743A or 8745A, remove the rear-panel coaxial link, wrap it separately and include it in the instrument shipping container.
- b. Wrap the instrument in heavy paper or plastic service facility, attach a tag indicating type of servicing required, return address, model number, and full serial number.)
- c. Use a strong shipping container. A carton made of 600 pound test material will usually provide adequate protection.
- d. Use enough shock-absorbing material (3 to 4 inch layer) around all sides of the instrument to provide firm cushion and prevent movement inside the container. Protect the control panel with cardboard. With Hewlett-Packard "float pack" packaging, the foam blocks provide sufficient shock protection, and additional material is unnecessary.
- e. Seal the shipping container securely.
- f. Mark the shipping container "FRAGILE" to assure careful handling.
- g. In any correspondence, refer to the instrument by model number and full serial number.

Figure 2-1. Preparation for Rack Mounting

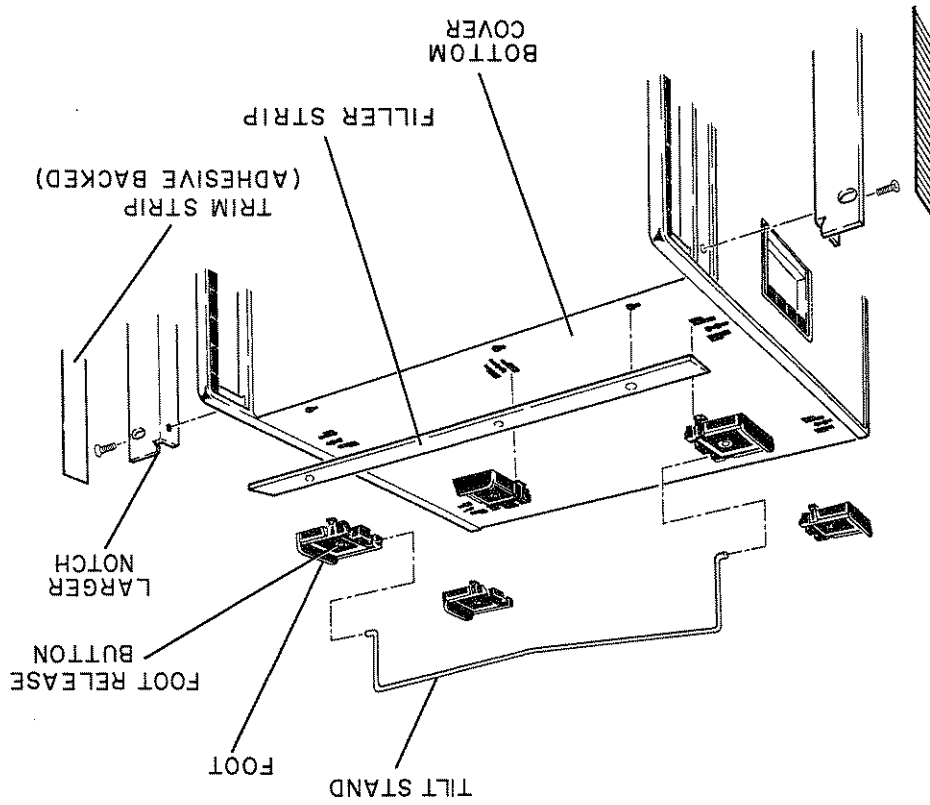

### SECTION III OPERATION

#### 3-1. INTRODUCTION.

3-2. The 8410S System may be used to measure the magnitude and phase parameters of 50-ohm coaxial devices. These measurements can be made at single frequencies or at swept frequencies from 0.11 to 12.4 GHz. The 8410S-100 System covers the frequency range from 0.11 to 2.0 GHz, the 8410S-200 System covers the range from 2.0 to 12.4 GHz, and the 8410S-300 System covers the entire range from 0.11 to 12.4 GHz. The systems include two plug-in readout units for the network analyzer, the network analyzer mainframe and harmonic frequency converter, and the RF transducer unit(s) necessary to cover the selected frequency range. Flexible arm extensions are included with the transducers to connect almost any configuration of unit under test. The system was designed to be compatible with Hewlett-Packard 690 and 8690 series sweep oscillators. If any other type of sweeper or signal source is used, refer to the Model 8410A Network Analyzer Operating and Service Manual for the signal characteristics necessary for proper operation of the network analyzer.

#### 3-3. OPERATING PRECAUTIONS.

3-4. The following operating precautions must be observed, or damage to an instrument may result:

- a. Maximum RF power to the RF input of the 8743A and 8745A is 2 watts.
- b. Maximum RF power to the inputs of the 8411A Harmonic Frequency Converter is 50 milliwatts.
- c. Maximum dc across the RF input connectors of the 8411A Harmonic Frequency Converter is +3 Vdc.
- d. Static electrical discharge into the center conductor of the 8411A Harmonic Frequency Converter may damage the unit. Discharge the center conductor of any line that might carry a static charge before connecting it directly to the 8411A input connector. If connection is made through the 8743A or 8745A transducer, there is no risk of static discharge because of the built-in discharge circuit paths.

#### 3-5. MEASUREMENT PROCEDURES.

3-6. MEASUREMENTS WITH 8410S-100 SYSTEM (0.11 TO 2 GHz)  
 3-7. Instructions for making reflection and transmission measurements with the 8410S-100 system in the 0.11 to 2 GHz range are given in Figure 3-1. Refer to paragraph 3-12 for methods of obtaining the highest measurement accuracy.

3-8. MEASUREMENTS WITH 8410S-200 SYSTEM (2 TO 12.4 GHz).  
 3-9. Instructions for making reflection measurements with the 8410S-200 system in the 2 to 12.4 GHz range are given in Figures 3-2 and 3-4. Figures 3-3 and 3-5 give instructions for making transmission tests with this system. Refer to paragraphs 3-12 and 3-17

for methods of obtaining the highest measurement accuracy.  
 3-10. MEASUREMENTS WITH 8410S-300 SYSTEM (0.11 TO 12.4 GHz)

3-11. The 8410S-300 System is similar to either the 8410S-100 or 8410S-200 systems except it covers the entire range of the other two systems. This is accomplished by including both transducers (8743A and 8745A) in the system. To perform reflection or transmission measurements, use the appropriate procedure for the 100 or 200 system given in Figures 3-1 through 3-5. Refer to paragraphs 3-12 and 3-17 for methods of obtaining the highest measurement accuracy.

#### 3-12. INCREASED ACCURACY FOR REFLECTION MEASUREMENTS.

3-13. Greatest accuracy for single-frequency, high resolution reflection measurements can be obtained by connecting the device under test directly to the front-panel ports of the 8743A or 8745A. If it is necessary to make connections through an I1604A or I1605A, an air line, or a coaxial cable, any movement of the swivel joints or flexing of coaxial cable will alter the phase relations of the reflections in the test setup; therefore, any component inserted between the 8743A or 8745A and the device under test should remain in the same position for both calibration and measurement.  
 3-14. Directivity errors are not significant unless small reflection coefficients are being measured. This error can be cancelled at single frequencies when necessary. The measured reflection is the vector sum of the directivity vector plus the reflection coefficient of the device under test (Figure 3-6). The error can be calibrated out at single frequencies by using a sliding

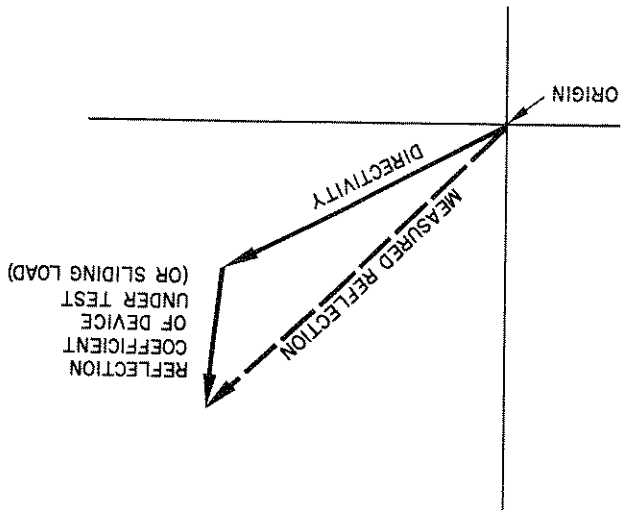
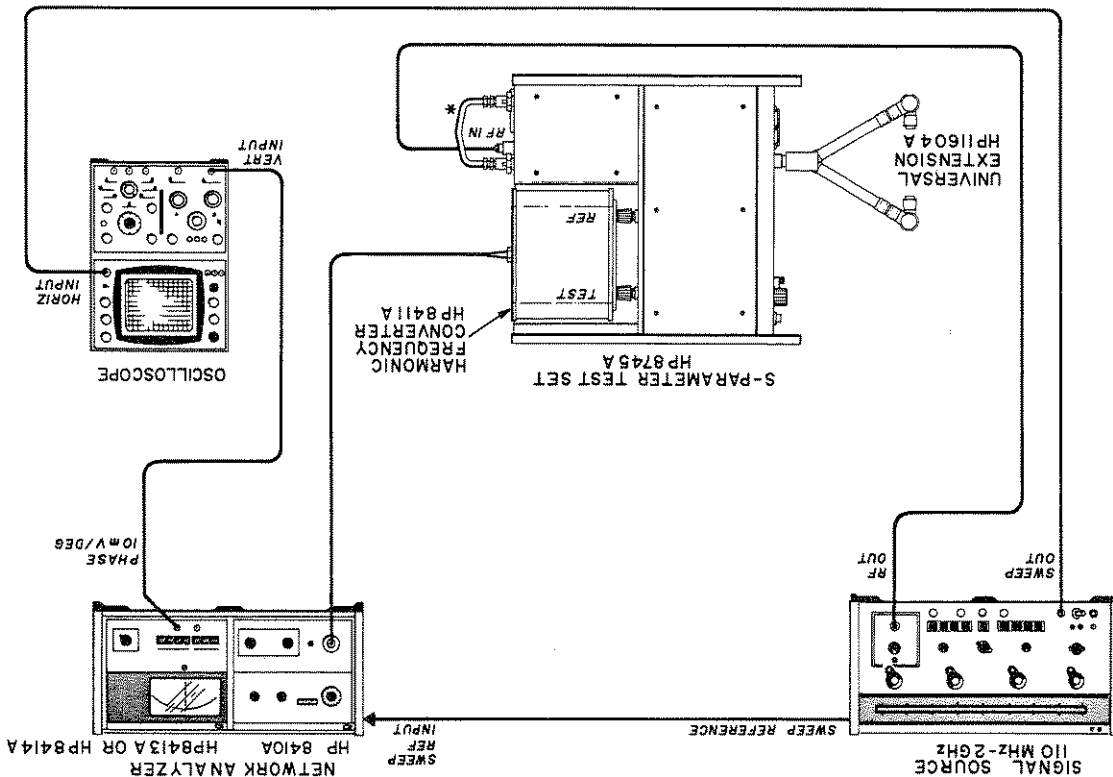

Figure 3-6. Typical Polar Plot Showing Measured Reflection as the Sum of Directivity and Load Vectors.

Figure 3-1. Transmission and Reflection Measurement with 8410S-100 System (Sheet 1 of 2)

**TRANSMISSION AND REFLECTION MEASUREMENT WITH 8410S-100 SYSTEM**



\*Use HP Part Number 11604-20021 with Universal Extension and use HP Part Number 08745-20064 when making measurements without the Universal Extension

**CALIBRATION DESCRIPTION**

4. Adjust the 8745A REFERENCE PLANE EXTENSION to cancel out the linear phase error (equal reference and test channel electrical lengths). For the 8414A, adjust for the small-est cluster. For an 8413A with an oscilloscope connected to its PHASE output, adjust for a horizontal line.
5. Establish the calibration condition to be used. (see table below).
6. If an 8414A is used as the readout, adjust the 8410A controls as follows:

Table of Calibration Readout Values

| S-Parameter      | Condition | Magnitude | Phase |
|------------------|-----------|-----------|-------|
| $S_{11}, S_{22}$ | Open      | 1         | 0°    |
| $S_{11}, S_{22}$ | Short     | 1         | 180°  |
| $S_{21}, S_{12}$ | Through   | 1         | 0°    |

**CALIBRATION PROCEDURE**

1. Connect equipment as shown in test setup opposite.
2. Set the signal source to sweep the band of interest.
3. Set the 8745A to measure the reflection coefficient of an open or a short. Adjust the signal source RF power and the 8410A SWEEP STA-BILITY control to obtain a REF CHANNEL LEVEL meter indication in the middle of the OPERATE range.

**TRANSMISSION AND REFLECTION MEASUREMENT WITH 8410S-100 SYSTEM**

GAIN control settings, convert the change in dB referenced from the calibration setting into the equivalent voltage ratio.

4. If an 8413A is used in the 8410A, the amplitude display is relative magnitude in dB of the incident and reflected (S<sub>11</sub>, S<sub>22</sub>) or incident and transmitted (S<sub>21</sub>, S<sub>12</sub>) signals. These can be converted to reflection or transmission coefficients with the following equations:

$$p = \log^{-1} (0.05 \times \text{return loss in dB})$$

or

$$\tau = \log^{-1} (0.05 \times \text{return loss in dB})$$

**NOTE**

$p$  = Reflection Coefficient Magnitude

$\tau$  = Transmission coefficient magnitude

Table of Magnitude Scale

| 8410A TEST CHANNEL GAIN Change from Cal. Setting (dB) |       | Full Scale | Each Ring |
|---|-------|------------|-----------|
| +32   | 0.025 | 0.005      | 0.01      |
| +26   | 0.05  | 0.01       | 0.02      |
| +20   | 0.1   | 0.02       | 0.04      |
| +14   | 0.2   | 0.05       | 0.08      |
| +12   | 0.25  | 0.1        | 0.1       |
| +6  | 0.5   | 0.2        | 0.2       |
| -6  | 1.0   | 0.4        | 0.4       |
| -12   | 2.0   | 0.8        | 0.8       |
| -14   | 4.0   | 1.0        | 1.0       |
| -20   | 10.0  | 2.0        | 2.0       |
| -26   | 20.0  | 4.0        | 4.0       |
| -32   | 40.0  | 8.0        | 8.0       |

a. Adjust the PHASE VERNIER for the appropriate reference phase indication (e.g., for a through section, press S<sub>21</sub> or S<sub>12</sub> and adjust for 0°).

b. Adjust the 8410A TEST CHANNEL GAIN and AMPL. VERNIER controls for an 8414A magnitude indication of 1.0. This places the dot or cluster trace on the outside graphic circle of the CRT.

7. If an 8413A is used as the readout, set the signal source for single frequency (CW) operation and adjust the 8410A controls as follows:

a. Adjust the PHASE VERNIER control for the appropriate reference phase indication (e.g., for a through section, press S<sub>21</sub> or S<sub>12</sub> and adjust for 0°).

b. Adjust the TEST CHANNEL GAIN and AMPL. VERNIER controls for a zero dB indication. For S<sub>11</sub> and S<sub>22</sub> the 8413A indicates return loss (0 dB return loss equals a reflection coefficient of 1). For S<sub>21</sub> and S<sub>12</sub> the 8413A indicates gain or loss in dB.

**MEASUREMENT**

1. Insert the device to be tested between the arms of the Universal Extension and select INPUT PORT A or B as desired.

2. Select the S PARAMETER to be measured.

3. If an 8414A plug-in is used in the 8410A Network Analyzer, read the magnitude and phase from the CRT. Note from the table below that the 8414A magnitude scale may be changed by changing the 8410A TEST CHANNEL GAIN control settings. To use other TEST CHANNEL

Figure 3-1. Transmission and Reflection Measurement with 8410S-100 System (Sheet 2 of 2)

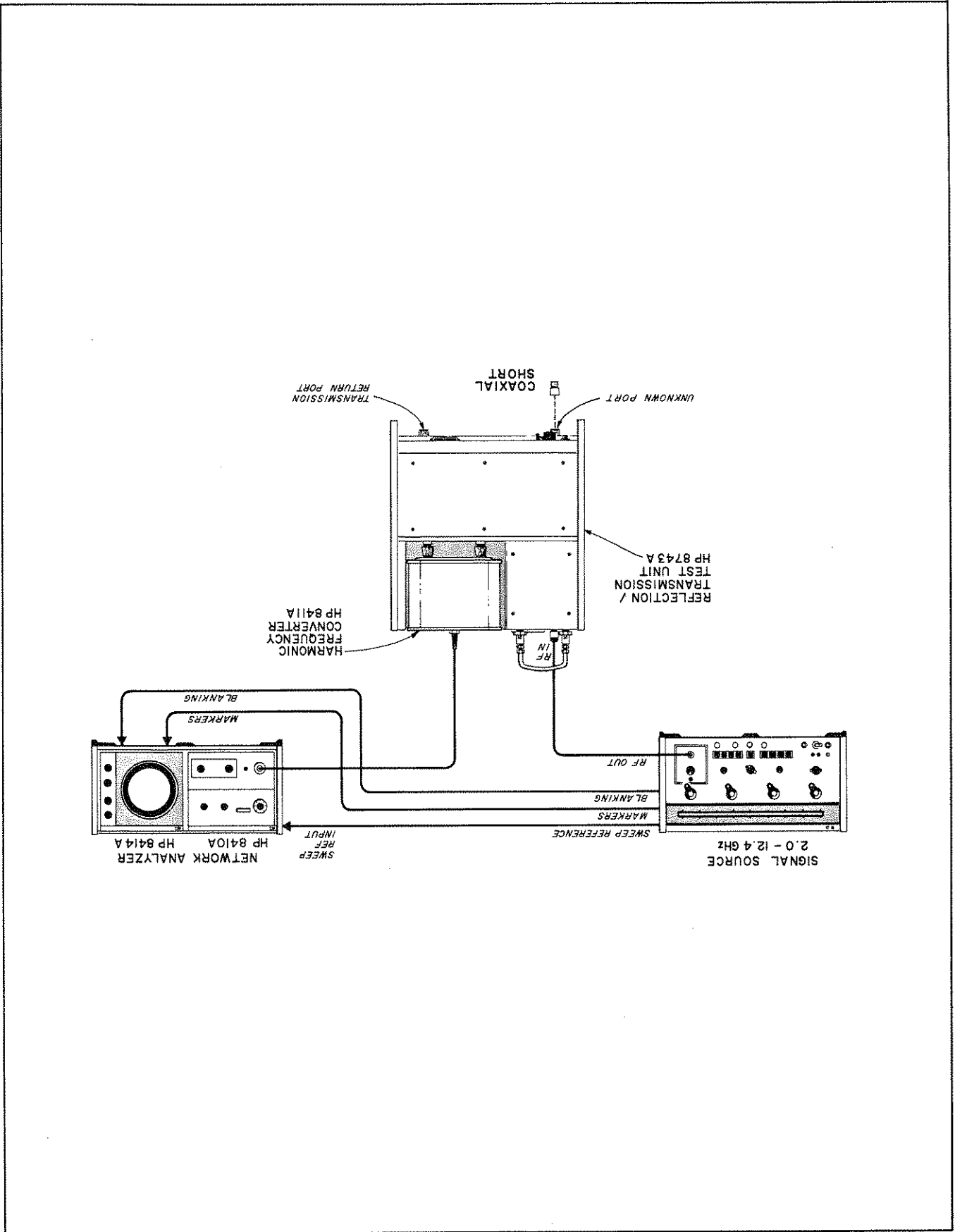

Figure 3-2. Reflection Measurement with 8410S-200 System Using 8414A Polar Display (Sheet 1 of 2)

**REFLECTION MEASUREMENT WITH 8410S-200 SYSTEM**

**CALIBRATION DESCRIPTION**

Calibration consists of adjusting the 8743A REFERENCE PLANE EXTENSION to obtain equal reference and test channel electrical lengths, then obtaining a reference magnitude and phase indication.

**CALIBRATION PROCEDURE**

1. Connect equipment as shown in setup above.

2. Connect coaxial short, HP 11565A to the 8743A UNKNOWN port and depress the REFLECT push-button.

3. Set the signal source to sweep the band of interest. Adjust the signal source RF power and the 8410A SWEEP STABILITY control to obtain a REF CHANNEL LEVEL meter indication in the middle of the OPERATE range.

4. Push and hold the 8414A BEAM CTR push-button and adjust the centering controls to place the dot in the center of the polar display.

5. Obtain equal reference and test channel electrical lengths by adjusting the 8743A REFERENCE PLANE EXTENSION to collapse the trace to a dot or smallest cluster. If the plane of measurement is to be extended beyond the plane of the short, the digital counter should be set to zero so that it can be used to set the required extension accurately. A convenient way to do this is as follows:

- a. Adjust 8743A REFERENCE PLANE EXTENSION crank until counter reads all zeros.
- b. Hold thumbwheel to retain zero indication and readjust REFERENCE PLANE EXTENSION to collapse the trace to a dot or smallest cluster.

6. Adjust the 8410A PHASE VERNIER, TEST CHANNEL GAIN, and AMPL VERNIER controls to place the dot or cluster for a reference indication of  $T = 1/180^\circ$ .

**NOTE**

Calibration for greater accuracy is discussed in paragraph 3-12.

**MEASUREMENT**

1. Remove the coaxial short and connect the device to be tested to the 8743A UNKNOWN port.
2. Read the reflection coefficient magnitude and phase (or impedance using a Smith Chart overlay) from the 8414A display.

**NOTE**

For small reflection coefficients, the 8414A resolution can be improved by increasing the 8410A test channel gain. For example, increasing the full scale reflection by 20 dB changes the full scale reflection coefficient calibration from 1.0 to 0.1 at the outer circle.

3. The effective load plane of the device under test may be determined by adjusting the 8743A REFERENCE PLANE EXTENSION to again collapse the trace to a dot or smallest cluster. The distance from reference plane to load plane may be read directly from 8743A digital counter (counter set to zero during calibration).

Figure 3-2. Reflection Measurement with 8410S-200 System Using 8414A Polar Display (Sheet 2 of 2)

Figure 3-3. Transmission Measurements with 8410S-200 System Using 8414A Polar Display (Sheet 1 of 2)

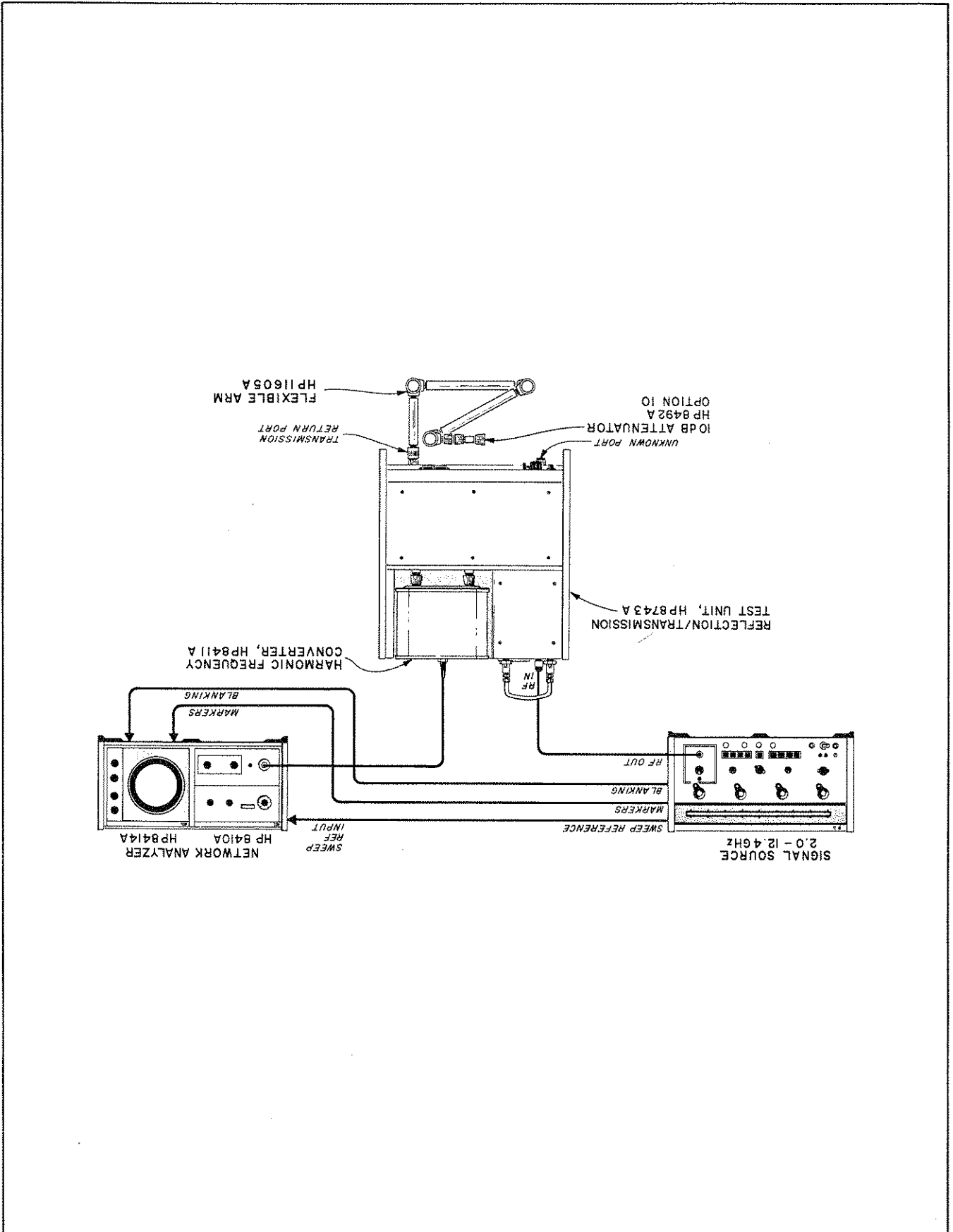



**TRANSMISSION MEASUREMENT WITH 8410S-200 SYSTEM**

**CALIBRATION DESCRIPTION**

Calibration consists of adjusting the 8743A REFERENCE PLANE EXTENSION to obtain equal reference and test channel electrical lengths and obtaining a reference magnitude and phase indication.

1. Connect equipment as shown in setup above. Connect a 10-dB attenuator, such as the HP 8492A Option 10, to the Flexible Arm (para-graph 3-17), and connect the attenuator to the 8743A UNKNOWN port.

2. Depress the 8743A TRANS pushbutton.
3. Set the signal source to sweep the band of interest. Adjust the signal source RF power and the 8410A SWEEP STABILITY control to obtain a REF CHANNEL LEVEL meter indication in the middle of the OPERATE range.

4. Push and hold the 8414A beam center pushbutton and adjust the centering controls to place the dot in the center of the polar display.
5. Obtain equal reference and test channel electrical lengths by adjusting the 8743A REFERENCE PLANE EXTENSION to collapse the trace to a dot or smallest cluster. If the digital counter is to be used to determine the electrical length of the device under test, it should be set to zero. A convenient way to do this is as follows:

- a. Adjust REFERENCE PLANE EXTENSION crank until counter reads all zeros.

- b. Hold thumbwheel to retain zero indication and readjust REFERENCE PLANE EXTENSION to collapse the trace to a dot or smallest cluster.
6. Adjust the 8410A amplitude and phase controls to place the dot or cluster at a reference indication of  $\tau = 1/0^\circ$ .

**MEASUREMENT**

1. Insert the device to be tested between the UNKNOWN port and the 10-dB attenuator.

2. Note the 8410A TEST CHANNEL GAIN setting. This is the calibration gain setting. Adjust the TEST CHANNEL GAIN controls to locate the point of the CRT display representing the frequency of interest on the outside ring. The difference in TEST CHANNEL GAIN settings is the magnitude of the transmission gain or loss of the device under test at the frequency of interest. Note from the table below that the 8414A magnitude scale may be changed to convenient multiples by changing the 8410A TEST CHANNEL GAIN control setting as listed.
3. To determine the electrical length of the device under test, perform the following:
  - a. Adjust the 8743A REFERENCE PLANE EXTENSION to again collapse the trace to a dot or smallest cluster.
  - b. The electrical length of the device under test is two times the digital counter reading.

Table of Magnitude Scale

| 8410A TEST CHANNEL GAIN Change from Cal. Setting (dB) |       | Full Scale | Each Ring |
|---|-------|------------|-----------|
| +32   | 0.025 | 40.0       | 8.0       |
| +26   | 0.05  | 20.0       | 4.0       |
| +20   | 0.1   | 10.0       | 2.0       |
| +14   | 0.2   | 5.0        | 1.0       |
| +6  | 0.5   | 2.0        | 0.8       |
| -6  | 1.0   | 1.0        | 0.4       |
| -12   | 2.0   | 0.5        | 0.2       |
| -14   | 4.0   | 0.25       | 0.1       |
| -20   | 10.0  | 0.1        | 0.05      |
| -26   | 20.0  | 0.05       | 0.04      |
| -32   | 40.0  | 0.02       | 0.02      |
|   |       | 0.01       | 0.01      |
|   |       | 0.005      | 0.005     |

Figure 3-4. Reflection Measurements with 8410S-200 System Using 8413A Display Unit. (Sheet 1 of 2)

**CALIBRATION PROCEDURE**

1. Connect equipment as shown in setup above.
2. Connect a coaxial short such as the HP 11565A to the 8743A UNKNOWN port and depress the REFL pushbutton.
3. Adjust 8413A phase offset control for 180° offset (either polarity).
4. Set the signal source to sweep the band of interest. Adjust the signal source RF power and the 8410A SWEEP STABILITY control to obtain a REF CHANNEL LEVEL meter indication in the middle of the OPERATE range.

**CALIBRATION DESCRIPTION**

Calibration consists of adjusting the 8743A REFERENCE PLANE EXTENSION to obtain equal reference and test channel electrical lengths and phase angle.

5. Select dc coupling at oscilloscope vertical inputs and adjust the oscilloscope to display the swept phase output from the 8413A.
6. Obtain equal reference and test channel electrical lengths by adjusting the REFERENCE PLANE EXTENSION for a horizontal phase display on the oscilloscope. If the plane of measurement is to be extended beyond the plane of the short, the digital counter should be set to zero so that it can be used to set the required extension accurately. A convenient way to do this is as follows:
  - a. Adjust REFERENCE PLANE EXTENSION crank until counter reads all zeros.
  - b. Hold thumbwheel to retain zero indication and readjust REFERENCE PLANE EXTENSION for a horizontal display on the oscilloscope.
7. For swept-frequency measurements, adjust the oscilloscope display as follows:

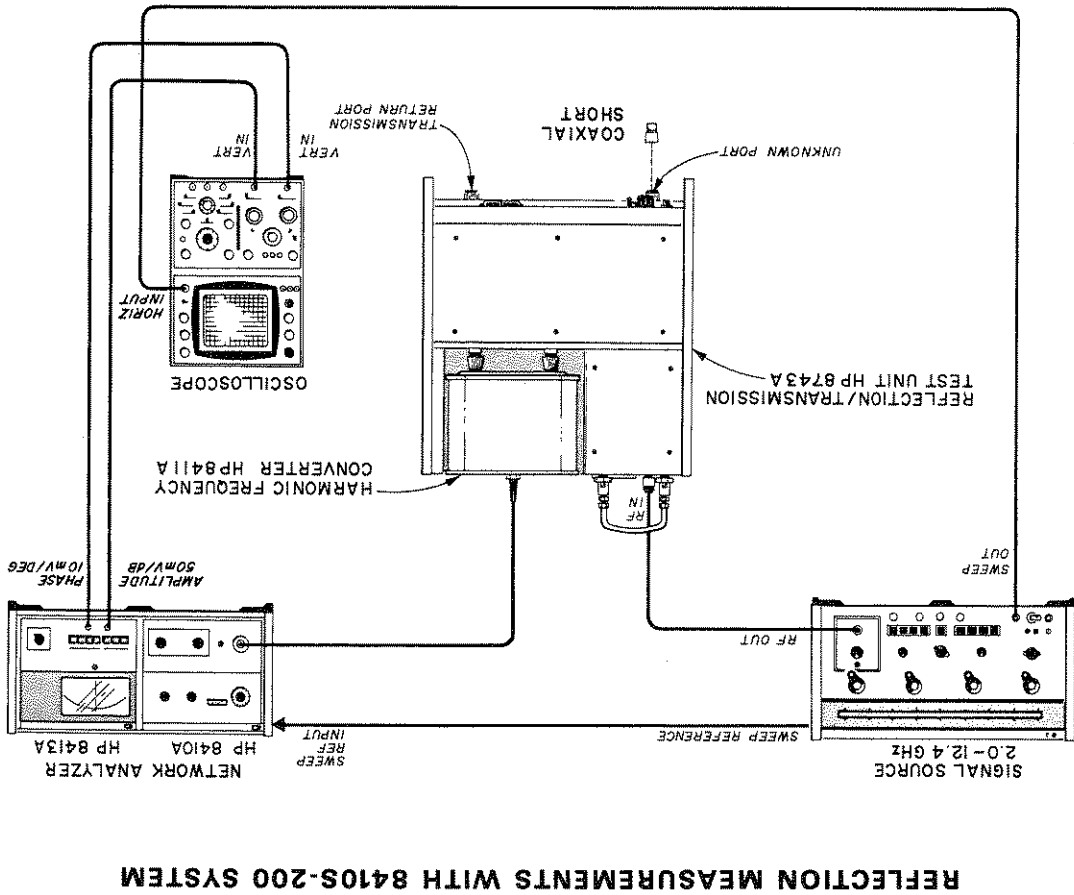

**REFLECTION MEASUREMENTS WITH 8410S-200 SYSTEM**

**NOTE**

Calibration for greater accuracy is discussed in Paragraph 3-12.

**MEASUREMENT**

1. Remove the coaxial short and connect the device to be tested to the 8743A UNKNOWN port.
2. Return the 8413A phase offset to zero.
3. For swept-frequency measurements, read magnitude and phase as follows:

- a. For magnitude, note 8410A TEST CHANNEL GAIN settings. Increase TEST CHANNEL GAIN to return oscilloscope display to reference obtained during calibration. The difference in TEST CHANNEL GAIN settings is the reflection magnitude in return loss.
- b. For phase, adjust oscilloscope vertical sensitivity and position controls to view the swept-phase display of the device under test. Use the calibrated 8413A output (10 mV/degree) and the oscilloscope vertical calibration to determine phase angle.

4. For single-frequency measurements, read magnitude and phase as follows:

- a. For magnitude, note 8410A TEST CHANNEL GAIN settings. Increase TEST CHANNEL GAIN to return the 8413A meter indication to zero. The difference in TEST CHANNEL GAIN settings is the reflection magnitude in return loss.
- b. For phase, adjust the 8413A phase offset for an on-scale meter indication on the most sensitive scale. The phase angle is the algebraic sum of phase offset and meter indication.

$$|p| = \text{Log}^{-1} (0.05 \times \text{return loss})$$

- a. Disconnect oscilloscope vertical input from 8413A amplitude channel to simulate no amplitude signal from 8413A. Note trace position.
- b. Reconnect vertical input and adjust 8410A TEST CHANNEL GAIN and AMPL VERNIER controls so that the average of the trace falls on the zero position noted in step (a) opposite.
- c. Adjust oscilloscope vertical position for a convenient amplitude reference.
- d. Disconnect oscilloscope vertical input from 8413A phase channel to simulate no phase signal from 8413A. Note trace position.
- e. Reconnect vertical input and adjust 8410A PHASE VERNIER control so that the average of the trace falls on the zero trace position noted in step (d) above.
- f. Adjust oscilloscope vertical position for a convenient phase reference.

8. To calibrate for single-frequency measurements, perform the following:

- a. Set the signal source for single-frequency operation.

- b. Set 8413A PHASE OFFSET switch to zero and depress PHASE 180 degree pushbutton. Adjust 8410A PHASE VERNIER control for a zero degree indication on the 8413A. Depress PHASE 6 degree pushbutton and again zero meter with 8410A PHASE VERNIER.
- c. Depress 8413A AMPLITUDE 30 dB pushbutton. Adjust 8410A TEST CHANNEL GAIN and AMPLITUDE VERNIER controls for a zero dB indication on the 8413A meter. Depress AMPLITUDE 3 dB pushbutton and again zero meter with 8410A AMPLITUDE VERNIER control.

Figure 3-4. Reflection Measurements with 8410S-200 System Using 8413A Display Unit. (Sheet 2 of 2)

Figure 3-5. Transmission Measurement with 8410S-200 System Using 8413A Display Unit. (Sheet 1 of 2)

**CALIBRATION PROCEDURE**

1. Connect equipment as shown in setup above. Connect a 10-dB attenuator, such as the HP 8492A Option 10, to the HP 11605A Flexible Arm (paragraph 3-17) and connect the attenuator to the 8743A UNKNOWN port. Depress 8743A TRANS pushbutton.
2. Set the signal source to sweep the band of interest. Adjust the signal source RF power and the 8410A SWEEP STABILITY control to obtain a REF CHANNEL LEVEL meter indication in the middle of the OPERATE range.
3. Select dc coupling at oscilloscope vertical inputs and adjust the oscilloscope to display the swept phase output from the 8413A.
4. Obtain equal reference and test channel electrical lengths by adjusting the 8743A REFERENCE PLANE EXTENSION for a horizontal phase display on the oscilloscope. If the digital counter is to be used to determine the electrical length of the device under test, it should be set to zero. A convenient way to do this is as follows:
  - a. Adjust REFERENCE PLANE EXTENSION crank until counter reads all zeros.
  - b. Hold thumbwheel to retain zero indication and readjust REFERENCE PLANE EXTENSION for a horizontal display on the oscilloscope.
5. For swept-frequency measurements, adjust the oscilloscope display as follows:
  - a. Disconnect oscilloscope vertical input from 8413A amplitude channel, to simulate no amplitude signal from 8413A. Note trace position.
  - b. Select dc coupling at oscilloscope vertical inputs and adjust the oscilloscope to display the swept phase output from the 8413A.

**CALIBRATION DESCRIPTION**

Calibration consists of adjusting the 8743A REFERENCE PLANE EXTENSION to obtain equal reference and test channel electrical lengths and obtaining reference magnitude and phase indication.

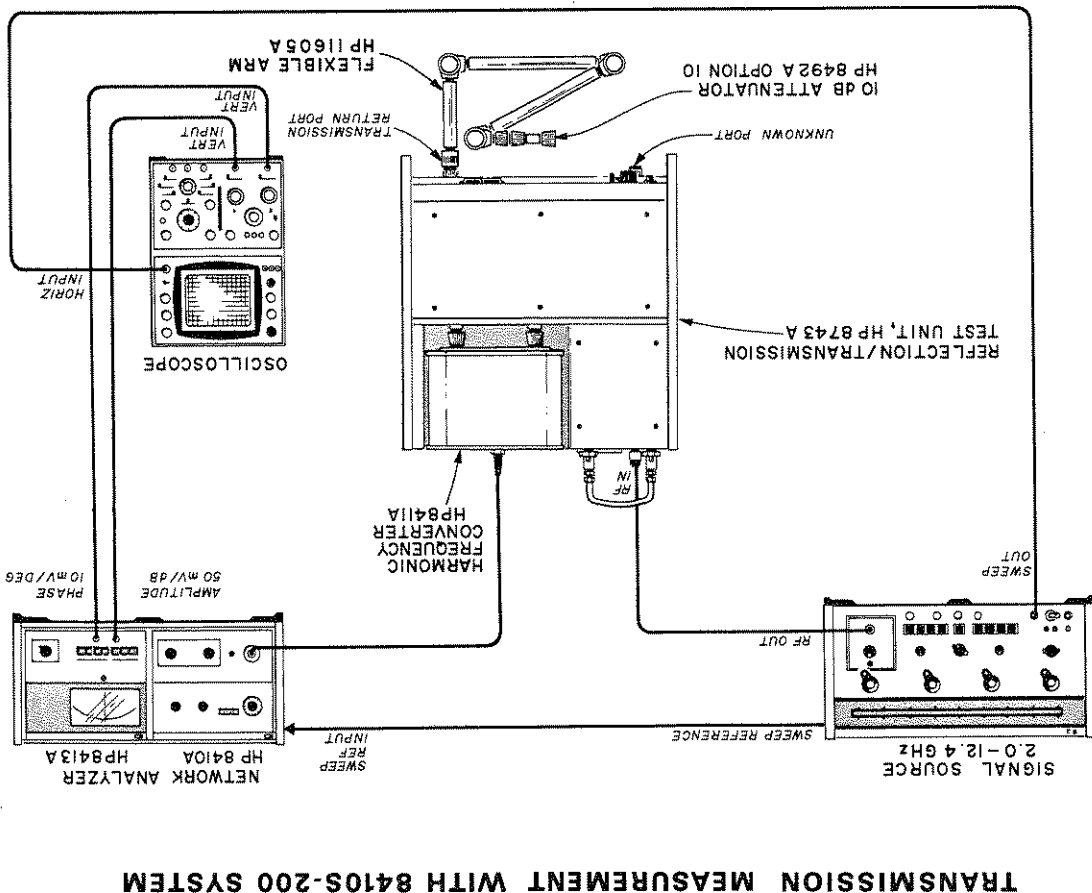

**TRANSMISSION MEASUREMENT WITH 8410S-200 SYSTEM**

**MEASUREMENT**

1. Insert the device to be tested between the 8743A UNKNOWN port and the 10-dB attenuator.
  2. For swept-frequency measurements, read magnitude and phase as follows:
    - a. For magnitude, note 8410A TEST CHANNEL GAIN settings. Adjust TEST CHANNEL GAIN to return oscilloscope display to reference obtained during calibration. The difference in TEST CHANNEL GAIN settings is the transmission gain or loss in dB of the device under test.
    - b. For phase, adjust oscilloscope vertical sensitivity and position controls to view the swept-phase display of the device under test. Use the calibrated 8413A output (10 mV/degree) and the oscilloscope vertical calibration to determine phase angle.
- NOTE**
- The phase display is the combination of linear phase shift (due to electrical length) and non-linear phase shift. Group delay can be determined from this display. (See HP Application Note 92.)
3. For single-frequency measurements, read magnitude and phase as follows:
    - a. For magnitude, note 8410A TEST CHANNEL GAIN settings. Adjust TEST CHANNEL GAIN to return the 8413A meter indication to zero. The difference in TEST CHANNEL GAIN settings is the transmission gain or loss in dB of the device under test.
    - b. For phase, adjust the 8413A PHASE OFFSET for an on-scale meter indication on the most sensitive scale. The phase angle is the algebraic sum of PHASE OFFSET and meter indication.
- a. Reconnect vertical input and adjust 8410A TEST CHANNEL GAIN and AMPLITUDE VERNIER controls so that the average of the trace falls on the zero trace position noted in step (d) above.
  - b. Disconnect oscilloscope vertical input from 8413A phase channel, to simulate no phase signal from 8413A. Note trace position.
  - c. Adjust oscilloscope vertical position for a convenient amplitude reference.
  - d. Reconnect vertical input and adjust 8410A PHASE VERNIER controls so that the average of the trace falls on the zero trace position noted in step (d) above.
  - e. Adjust oscilloscope vertical position for a convenient phase reference.
6. To calibrate for single-frequency measurements, perform the following:
    - a. Set the signal source for single-frequency operation.
    - b. Set 8413A PHASE OFFSET switch to zero and depress PHASE 180 degree pushbutton. Adjust 8410A PHASE VERNIER control for zero degree indication on the 8413A. Depress PHASE 6-degree pushbutton and again zero meter with PHASE VERNIER.
    - c. Depress 8413A AMPLITUDE 30 dB pushbutton. Adjust 8410A TEST CHANNEL GAIN and AMPLITUDE VERNIER controls for a zero dB indication on the 8413A meter. Depress AMPLITUDE 3 dB pushbutton and again zero meter with 8410A AMPLITUDE VERNIER control.

Figure 3-5. Transmission Measurement with 8410S-200 System Using 8413A Display Unit. (Sheet 2 of 2)

vector. Adjust the 8414A horizontal and vertical controls to place the dot in the center of the CRT. Directivity is now cancelled for this frequency and this TEST CHANNEL GAIN setting on the 8410A.

3-16. System tracking, or response also introduces an error into a measurement. This error occurs only in sweep mode and is eliminated by simply making CW (single frequency) measurements.

### 3-17. INCREASED ACCURACY FOR TRANSMISSION MEASUREMENTS IN 8410S-200 SYSTEMS.

3-18. A 50-ohm coaxial attenuator is recommended for transmission measurements. An attenuator connected between the output of the device under test and the HP 11605A Flexible Arm reduces the ambiguity due to mismatch between the 11605A, 8743A, and 8411A. A 10-dB low-reflection attenuator, such as an HP 8492A Option 10, reduces this ambiguity to essentially that due to the mismatch of the attenuator ( $VSWR < 1.25$ ). Greater values of attenuation may be used, however, values greater than 10 dB will not reduce mismatch. For values less than 10 dB the multiple mismatch between the 11605A, 8743A, and 8411A should be taken into consideration.

3-19. In addition to reducing ambiguity due to mismatch, the 10-dB attenuator makes the test channel power level during calibration the same for transmission and reflection. Also, the combined electrical lengths of the 8492A and the 11605A makes the electrical length of the test channel in the transmission mode nearly equal to its length in the reflection mode. This means that it is possible to calibrate in reflection mode of operation, then switch to transmission mode and be in approximate calibration. However, for best accuracy, it is necessary to recalibrate in each mode.

load. Figure 3-7 depicts the sliding load in one position. Figure 3-7 depicts the sliding load in one position. As the sliding load is moved, the magnitude of its reflection remains constant but the phase of the reflection changes. As the load is moved, its reflection indication rotates in a circle of constant magnitude about the directivity vector. The center of this circle is the tip of the directivity vector. When the location of the center of the circle is known, the error can be vectorially subtracted from the measured reflection to obtain the reflection coefficient of the device under test.

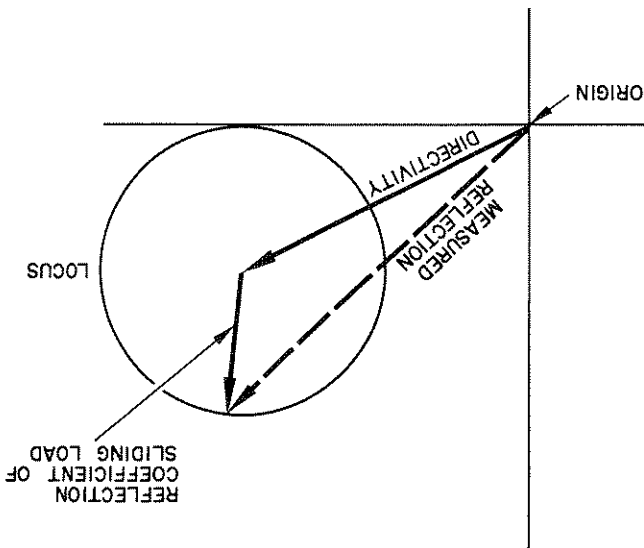

Figure 3-7. Typical Polar Plot Showing Locus of Measured Reflection when Sliding Load is Moved.

3-15. On the 8414A polar display, the vector subtraction can be performed directly with the horizontal and vertical position controls. Increase the 8410A test channel gain so full scale reflection on the polar display is suitable for the component you wish to measure and perform the following:

- a. For single frequencies above 1 GHz, set up the 8743A or 8745A to measure the desired reflection coefficient. Calibrate the display unit and attach the sliding load (HP Model 907A) to the 8743A UNKNOWN port or to the 8745A incident power port (INPUT PORT A or B). Slide the load and adjust the horizontal and vertical controls until the circle rotates about the center of the 8414A CRT, as shown in Figure 3-8. Directivity is now cancelled for this frequency and this TEST CHANNEL GAIN setting on the 8410A.

- b. For single frequencies below 1 GHz, set up the 8745A to measure the desired reflection coefficient (S11 or S22). Calibrate the display unit and connect a low reflection termination ( $\rho = 0.005$  or  $VSWR = 1.01$  max.), such as an HP Model H01-909A, to the 8745A incident power port (INPUT PORT A or B) at the reference plane. Since the magnitude of the Model H01-909A reflection is very small, the measured reflection coefficient on the 8414A can be considered the directivity

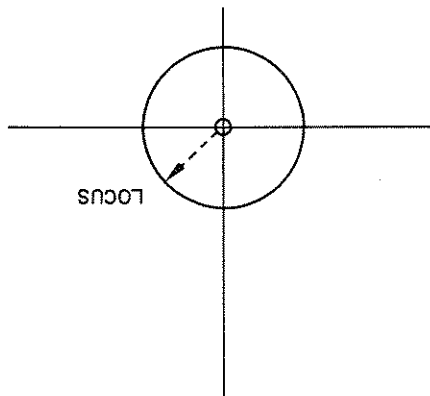

Figure 3-8. Center of Polar Display, Showing Locus of Sliding Load Vector with Directivity Cancelled.

## SECTION IV MAINTENANCE

### 4-1. INTRODUCTION.

4-2. This section provides instructions for checking the performance of the system, as well as isolating trouble to an individual instrument. For adjustment or alignment procedures, see the individual instrument Operating and Service Manual.

### 4-3. PERFORMANCE TEST.

4-4. The performance tests are presented in Figures 4-1 through 4-3. These procedures may be used during incoming inspection to verify the electrical operation of all of the instruments in the system. They may also be used during periodic evaluation of the system or after repair or alignment of one of the individual instruments. Test equipment required for these procedures is listed in Table 4-1. Other equipment required for the tests is furnished in the accessory kit that is included with the system.

### 4-6. TROUBLESHOOTING.

4-5. Figure 4-1 contains performance test procedures which are to be performed on all system configurations (8410S-100, -200, and -300). The procedures in Figure 4-2 check the transducer in the 8410S-100 system and Figure 4-3 checks the transducer in the 8410S-200 system. Therefore, to check an 8410S-100 system, perform the procedures in Figures 4-1 and 4-2. For an 8410S-200 system, perform procedures in Figures 4-1 and 4-3. For an 8410S-300 system, perform all of the procedures in Figures 4-1 through 4-3.

4-7. The troubleshooting procedures are presented in Figures 4-6 and 4-8. They isolate a fault to an individual instrument. When the malfunctioning instrument is found, refer to the Operating and Service Manual for the faulty instrument to further isolate the trouble within the instrument.

Table 4-1. Recommended Test Equipment (Sheet 1 of 2)

| Item No. | Used in System       | Instrument                       | Critical Specifications   | Recommended HP Model  |
|----------|----------------------|----------------------------------|---|---|
| 1        | -100<br>-200<br>-300 | Signal Source                    | Frequency Range: 0.11 to 12.4 GHz<br>Output Power: +8 dBm   | 8690B/8699B (0.1 to 4 GHz)<br>8690B/8693A, B (4 to 8 GHz)<br>8690B/8694A, B (8 to 12.4 GHz) |
| 2        | -100<br>-200<br>-300 | Power Meter and Thermistor Mount | Frequency Range: 0.11 to 12.4 GHz<br>Power Range: +5 to -30 dBm<br>Instrument Accuracy: ±3%<br>Input Impedance: 50 ohms<br>SWR: 1.35 maximum<br>Connector: APC-7*                 | 432A with 8478B Option 11<br>Thermistor Mount   |
| 3        | -200<br>-300         | Swept Slotted-Line               | Any frequency in range: 2.0 to 12.4 GHz<br>Impedance: 50 ohm ±0.2 ohms<br>Output Connector: APC-7*<br>Residual SWR: 1.03 or less  | 817A  |
| 4        | -100<br>-200<br>-300 | Dual Trace Oscilloscope          | Vertical Amplifier: Dual trace, DC Coupled<br>Vertical Sensitivity: 5 mV/cm<br>Bandwidth: 450 KHz minimum<br>Horizontal Sweep Rate: 1μs/cm to 5 s/cm<br>External Horizontal Input | 1200A or<br>140A/1401A/1422A or<br>180A/1801A/1820A or<br>181A/1801A/1820A                  |
| 5        | -100<br>-200<br>-300 | Narrow Band AC Voltmeter         | Frequency Range: 270 through 290 KHz<br>Selectivity: 200 and 1000 Hz at 278 KHz<br>Dynamic Range: 75 dB<br>Meter Scale: dB  | 310A or<br>312A   |

\*Amphenol RF Division, Danbury, Connecticut.

| Item No. | Used in System       | Instrument                          | Critical Specifications   | Recommended HP Model                                    |
|----------|----------------------|-------------------------------------|---|---|
| 6        | -100<br>-200<br>-300 | Variable Attenuator<br>(Calibrated) | Attenuation: 0 and 60 dB<br>Input and Output Impedance:<br>50 ohms nominal<br>Calibration: at 60 dB setting<br>referenced from 0 dB setting<br>Calibration Accuracy: $\pm 0.3$ dB<br>Calibration Frequency: 2.0 GHz | 354A calibrated by<br>Standards Laboratory              |
| 7        | -100<br>-200<br>-300 | Fixed Air Line<br>(2 Required)      | 50-ohm, 10-cm air line extension<br>with APC-7* connectors  | 11566A  |
| 8        | -100<br>-200<br>-300 | 50-ohm Load                         | Impedance: 50 ohms<br>Power Rating: 10 mW maximum<br>VSWR: 1.01 maximum, 0.11 to<br>2 GHz; 1.1 maximum 2 to<br>12.4 GHz<br>Connector: APC-7*  | H01-909A  |
| 9        | -100<br>-200<br>-300 | Sliding Load                        | 50-ohm coaxial sliding termina-<br>tion with APC-7* connector<br>SWR: < 1.05<br>Frequency Range: 1 to 12.4 GHz  | 907A  |
| 10       | -100<br>-200<br>-300 | DC Power Supply                     | Range: 0-5 Vdc  | 721A  |
| 11       | -100<br>-200<br>-300 | Signal Generator                    | Frequency Range: 270 through<br>290 kHz<br>Output Level: 0 to 3V rms<br>Output Impedance: 50 to 600 ohms  | 200CD or<br>651A  |
| 12       | -100<br>-200<br>-300 | Variable Attenuator                 | Range: 12 dB in 1-dB steps<br>Frequency: 278 kHz and 1 GHz<br>Accuracy: $\pm 0.35$ dB at 278 kHz<br>and 1 GHz   | 355C  |
| 13       | -100<br>-200<br>-300 | Variable Attenuator                 | Range: 120 dB in 10-dB steps<br>Frequency: 278 kHz and<br>1 GHz<br>Accuracy: $\pm 1.5$ dB at 278 kHz<br>and 1 GHz   | 355D  |
| 14       | -100<br>-200<br>-300 | DC Digital<br>Voltmeter             | Accuracy: 0.05%<br>Input Impedance: 10 megohm<br>minimum<br>Automatic Range Selection:<br>range to 50V  | 3440A with 3442A<br>Automatic Range Selector<br>Plug-in |

\*Amphenol RF Division, Danbury, Connecticut.

Table 4-1. Recommended Test Equipment (Sheet 2 of 2)



TEST

DESCRIPTION AND PROCEDURE

1

SPECIFICATION TESTED

TEST CHANNEL NOISE: Less than -78 dBm.

TEST DESCRIPTION

A -30 dbm signal at the TEST input of the 8411A is used to set a reference at the 8413A. The TEST port of the 8411A is terminated, leaving only TEST CHANNEL noise to be measured at the 8413A. Noise level of -78 dbm is 48 dB lower than the -30 dbm reference level. 40 dB of gain is added with the TEST CHANNEL GAIN control and -8 dB from zero reference is indicated on the 8413A, totaling 48 dB.

TEST SETUP

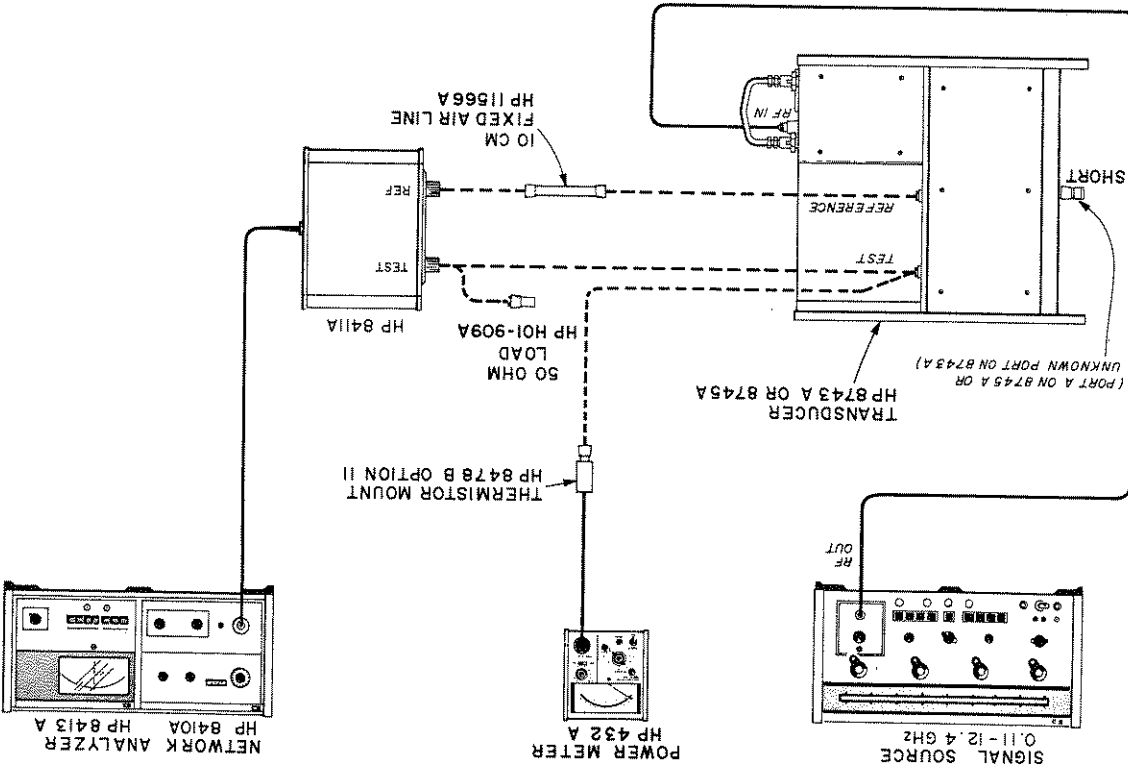

EQUIPMENT: Items 1, 2, 7, and 8, Table 4-1.

Figure 4-1. Performance Test Procedures Common to all Systems. (Sheet 1 of 20)

Figure 4-1. Performance Test Procedures Common to all Systems. (Sheet 2 of 20)

| TEST         | DESCRIPTION AND PROCEDURE  |
|--------------|--|
| 1<br>(Contd) | <p><u>PROCEDURE</u></p> <p>a. Connect equipment as shown above. Install short on port A of 8745A or UNKNOWN Port of 8743A. If 8745A is used, depress INPUT PORT A and S11 pushbuttons. If 8743A is used, depress REFLECT pushbutton. Set signal source for single-frequency (CW) operation in range of transducer used.</p> <p>b. Disconnect 8411A from 8743A or 8745A and check for -30 dBm signal level at 8743A or 8745A TEST port with power meter. If necessary, adjust signal source for -30 dBm indication. Reconnect 8411A to 8743A or 8745A.</p> <p>c. Check that 8410A REF CHANNEL LEVEL meter indicates in the OPERATE range.</p> <p>d. Press 8413A PHASE 180 degree pushbutton then adjust the 8410A PHASE VERNIER control: the 8413A meter indication should change smoothly indicating the 8410A is phase locked.</p> <p>e. Press 8413A AMPLITUDE 10 dB pushbutton. Adjust 8410A AMPL VERNIER and TEST CHANNEL GAIN controls to obtain a zero (center of scale) indication on 8413A meter.</p> <p>f. Disconnect 8411A from 8743A or 8745A, extend reference channel with 10-cm air line, and connect 50-ohm termination to 8411A TEST input.</p> <p>g. Increase 8410A TEST CHANNEL GAIN by 40 dB. The 8413A meter should indicate in the negative direction at least -8 dB. (This indicates less than -78 dBm equivalent input noise.)</p> |
| 2            | <p><u>SPECIFICATION TESTED</u></p> <p>IF GAIN CONTROL RANGE: 69 dB total in 10- and 1-dB steps; vernier provides continuous adjustment over at least 2 dB.</p> <p>IF GAIN CONTROL ACCURACY: <math>\pm 0.1</math> dB per 10-dB step and <math>\pm 0.05</math> dB per 1-dB step. A combination of both 10 dB and 1 dB steps not to exceed <math>\pm 0.2</math> dB.</p>   |
|              | <p><u>TEST DESCRIPTION</u></p> <p>The TEST CHANNEL GAIN control is tested for accuracy and the AMPL VERNIER control operation is checked. This is done by feeding a constant RF signal through the test channel and monitoring the rear-panel test channel 278 KHz IF output signal on a narrow-band ac voltmeter. The attenuators are set at each position and the resultant change in signal level is read on the ac voltmeter.</p>  |

TEST

DESCRIPTION AND PROCEDURE

2  
(Contd)

TEST SETUP

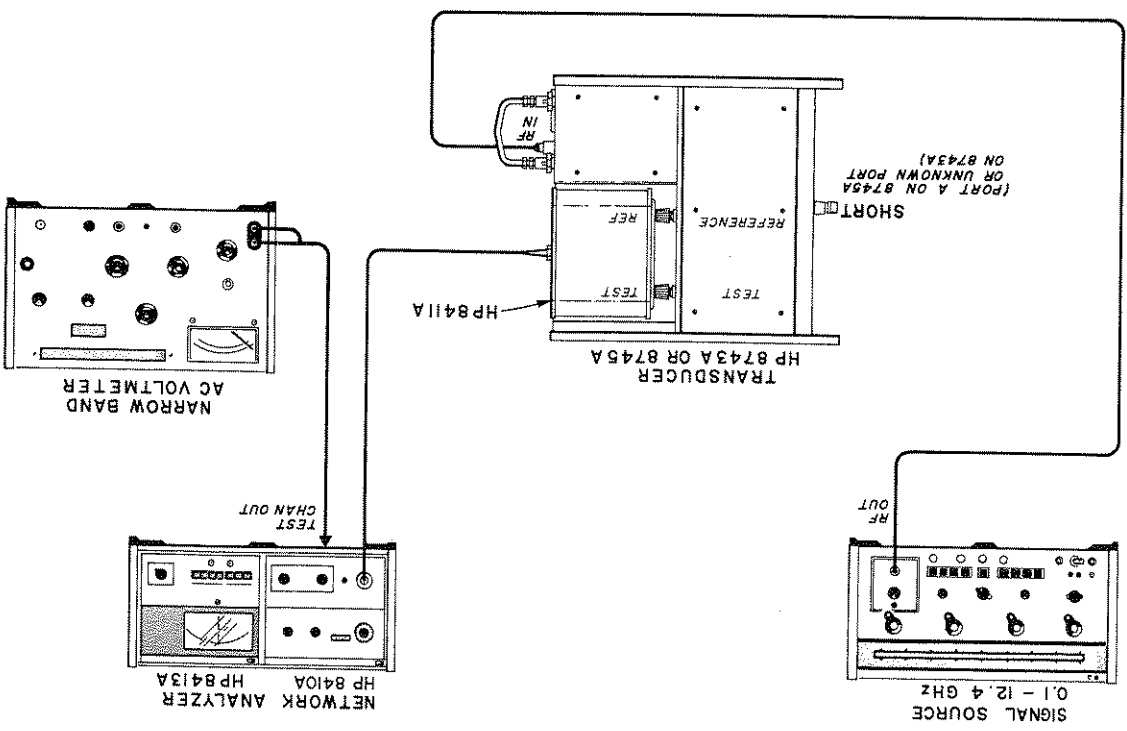

EQUIPMENT: Items 1 and 5, Table 4-1.

PROCEDURE

- a. Change equipment test setup as shown above. Install short on port A of 8745A or UNKNOWN port of 8743A. If 8745A is used, depress INPUT PORT A and S11 pushbuttons. If 8743A is used, depress REFL pushbutton. Set signal source for single-frequency (CW) operation in the range of the transducer used.
- b. Check for phase-locked condition in the 8410 as follows:
  - (1) REF CHANNEL LEVEL meter should indicate in the OPERATE range. If not, adjust signal source power output to obtain OPERATE indication on meter.
  - (2) Depress 8413A PHASE 180 degree pushbutton and adjust PHASE OFFSET for near zero degree meter indication. Adjust the 8410A PHASE VEERNER control: the 8413A phase meter indication should change smoothly, indicating the 8410A is phase locked.
- c. Set the 8410A TEST CHANNEL GAIN 10 dB/step control to 0 dB.

Figure 4-1. Performance Test Procedure Common to all Systems. (Sheet 3 of 20)

Figure 4-1. Performance Test Procedure Common to all Systems. (Sheet 4 of 20)

| TEST                          | DESCRIPTION AND PROCEDURE   |                               |                            |                         |       |        |                              |       |        |                              |       |        |                              |       |        |                              |       |        |                              |       |      |                              |
|-------------------------------|---|-------------------------------|----------------------------|-------------------------|-------|--------|------------------------------|-------|--------|------------------------------|-------|--------|------------------------------|-------|--------|------------------------------|-------|--------|------------------------------|-------|------|------------------------------|
| 2<br>(Contd)                  | <p style="text-align: center;"><u>PROCEDURE</u></p> <p>d. Set narrow band ac voltmeter to 1-kHz bandwidth and frequency to 278 kHz. Adjust 8410A AMPL VERNIER control and TEST CHANNEL GAIN 1 dB/step control for a -60 dB reference indication on the ac voltmeter. (Set ac voltmeter to -60 dB range and adjust reference level, 8410A AMPL VERNIER control, and TEST CHANNEL GAIN 1 dB/step control for a zero dB ac voltmeter indication.)</p> <p>e. Increase 8410A TEST CHANNEL GAIN in 10-dB steps and check accuracy as indicated below.</p> <table border="1" data-bbox="402 1200 1281 1570"> <thead> <tr> <th>Model 8410A TEST CHANNEL GAIN</th> <th>AC Voltmeter Range Setting</th> <th>AC Voltmeter Indication</th> </tr> </thead> <tbody> <tr> <td>10 dB</td> <td>-50 dB</td> <td>0(±0.1) dB ± voltmeter error</td> </tr> <tr> <td>20 dB</td> <td>-40 dB</td> <td>0(±0.2) dB ± voltmeter error</td> </tr> <tr> <td>30 dB</td> <td>-30 dB</td> <td>0(±0.2) dB ± voltmeter error</td> </tr> <tr> <td>40 dB</td> <td>-20 dB</td> <td>0(±0.2) dB ± voltmeter error</td> </tr> <tr> <td>50 dB</td> <td>-10 dB</td> <td>0(±0.2) dB ± voltmeter error</td> </tr> <tr> <td>60 dB</td> <td>0 dB</td> <td>0(±0.2) dB ± voltmeter error</td> </tr> </tbody> </table> <p>f. Set ac voltmeter to -40 dB range, set 8410A TEST CHANNEL GAIN 10 dB/step control to 20 dB, and set 1 dB/step control to zero dB. Adjust AMPL VERNIER control for a reference indication on the ac voltmeter at any one-dB scale division.</p> <p>g. Increase 8410A TEST CHANNEL GAIN 1 dB/step control in 1-dB steps; ac voltmeter indications should increase in corresponding 1-dB steps. If necessary, change ac voltmeter range to a higher or lower scale. Each meter indication must be within ±0.1 dB of a 1-dB major scale division on the meter, ± the error of the voltmeter.</p> <p>h. Using the ac voltmeter, check AMPL VERNIER range. It should be at least 2 dB.</p> | Model 8410A TEST CHANNEL GAIN | AC Voltmeter Range Setting | AC Voltmeter Indication | 10 dB | -50 dB | 0(±0.1) dB ± voltmeter error | 20 dB | -40 dB | 0(±0.2) dB ± voltmeter error | 30 dB | -30 dB | 0(±0.2) dB ± voltmeter error | 40 dB | -20 dB | 0(±0.2) dB ± voltmeter error | 50 dB | -10 dB | 0(±0.2) dB ± voltmeter error | 60 dB | 0 dB | 0(±0.2) dB ± voltmeter error |
| Model 8410A TEST CHANNEL GAIN | AC Voltmeter Range Setting  | AC Voltmeter Indication       |                            |                         |       |        |                              |       |        |                              |       |        |                              |       |        |                              |       |        |                              |       |      |                              |
| 10 dB                         | -50 dB  | 0(±0.1) dB ± voltmeter error  |                            |                         |       |        |                              |       |        |                              |       |        |                              |       |        |                              |       |        |                              |       |      |                              |
| 20 dB                         | -40 dB  | 0(±0.2) dB ± voltmeter error  |                            |                         |       |        |                              |       |        |                              |       |        |                              |       |        |                              |       |        |                              |       |      |                              |
| 30 dB                         | -30 dB  | 0(±0.2) dB ± voltmeter error  |                            |                         |       |        |                              |       |        |                              |       |        |                              |       |        |                              |       |        |                              |       |      |                              |
| 40 dB                         | -20 dB  | 0(±0.2) dB ± voltmeter error  |                            |                         |       |        |                              |       |        |                              |       |        |                              |       |        |                              |       |        |                              |       |      |                              |
| 50 dB                         | -10 dB  | 0(±0.2) dB ± voltmeter error  |                            |                         |       |        |                              |       |        |                              |       |        |                              |       |        |                              |       |        |                              |       |      |                              |
| 60 dB                         | 0 dB  | 0(±0.2) dB ± voltmeter error  |                            |                         |       |        |                              |       |        |                              |       |        |                              |       |        |                              |       |        |                              |       |      |                              |
| 3                             | <p style="text-align: center;"><u>SPECIFICATION TESTED</u></p> <p>REFERENCE CHANNEL INPUT POWER RANGE: 20 dB variation causes less than 1.5 dB amplitude and less than 4 degree phase change at output. The 20-dB range should be between -16 dBm and -44 dBm.</p> <p style="text-align: center;"><u>TEST DESCRIPTION</u></p> <p>The 8410A AGC circuit is checked for a 20-dB range within the input power range of -16 dBm and -44 dBm. This is done by changing RF input power levels to the two operating extremes of the AGC circuit and checking for constant reference channel output. Phase and amplitude are then monitored through the 20 dB AGC range to determine that they remain within specifications through the entire range.</p>   |                               |                            |                         |       |        |                              |       |        |                              |       |        |                              |       |        |                              |       |        |                              |       |      |                              |

TEST

DESCRIPTION AND PROCEDURE

3  
(Contd)

TEST SETUP

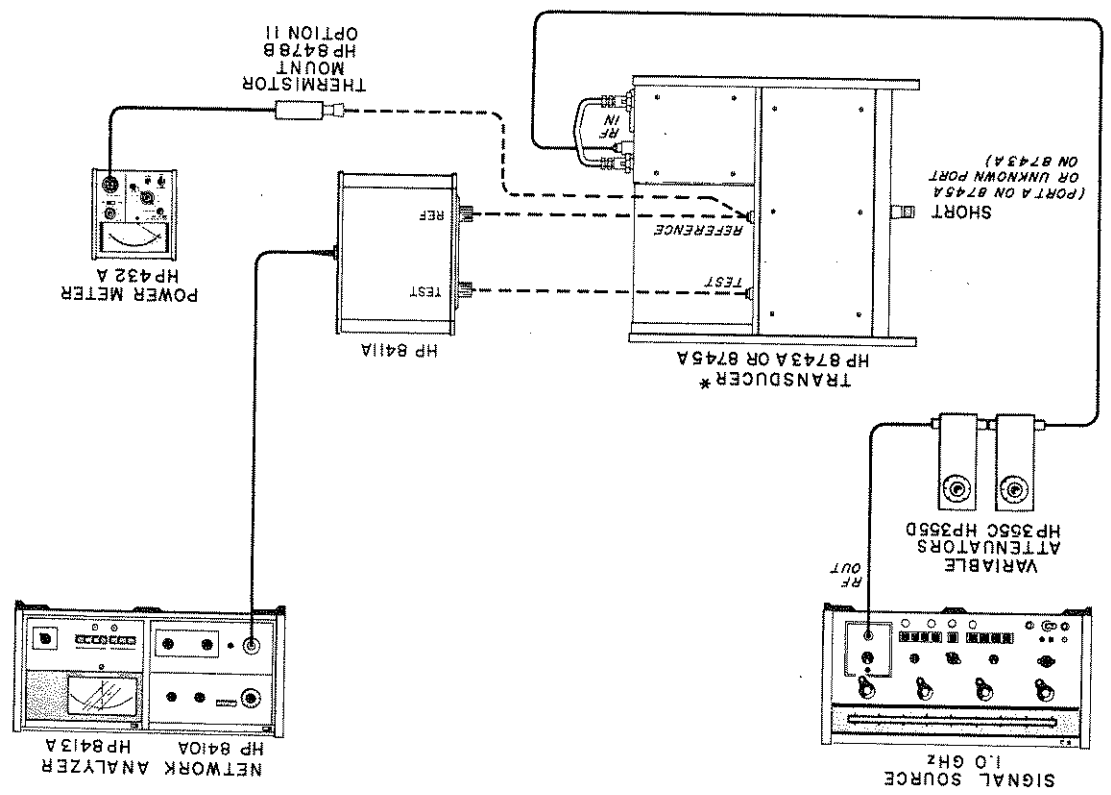

\*The coupling of the 8743A internal directional coupler rolls off below 2.0 GHz; however, this unit may be used at 1.0 GHz for this test.

EQUIPMENT: Items 1, 2, 12, and 13, Table 4-1.

PROCEDURE

- a. Change test setup as shown above. Install short on port A of 8745A or UNKNOWN port of 8743A. If 8745A is used, depress INPUT PORT A and S11 pushbuttons. If 8743A is used, depress REFL pushbutton. Set signal source for single-frequency (CW) operation at 1.0 GHz. Set HP 355C and 355D attenuators to zero dB.
- b. Check for phase-locked condition in the 8410A as follows:
  - (1) The 8410A REF CHANNEL LEVEL meter should indicate in the OPERATE range. If not, adjust signal source power output to obtain an OPERATE indication on meter.
  - (2) Depress 8413A PHASE 180 degree pushbutton. Adjust the PHASE VERNIER control: the 8413A meter indication should change smoothly indicating the 8410A is phase locked.

Figure 4-1. Performance Test Procedure Common to all Systems. (Sheet 5 of 20)

Figure 4-1. Performance Test Procedure Common to all Systems. (Sheet 6 of 20)

| TEST | DESCRIPTION AND PROCEDURE | 3<br>(Contd) | <p><u>PROCEDURE</u></p> <p>c. Depress 8413A AMPLITUDE 10-dB pushbutton and zero meter by adjusting 8410A AMPL VERNIER and AMPLITUDE TEST CHANNEL GAIN controls.</p> <p>d. Slowly increase signal source power until the 8413A meter indication increases rapidly, indicating the top of the AGC range. Reduce signal source power slightly to return the 8413A meter to zero so that the AGC is operating just at the top of its range.</p> <p>e. Disconnect the 8411A from the 8743A or the 8745A and connect power meter thermistor mount to 8743A or 8745A REFERENCE port. Measure and note power meter indication.</p> <p>f. Reconnect 8411A to 8743A or 8745A. Reduce signal source power to 8743A or 8745A by adding attenuation with HP 355C and 355D attenuators until the 8413A meter indication starts to decrease rapidly. This is the lower limit of the AGC range. Increase the signal with the attenuators until the 8413A meter returns to zero reference just at the edge of the AGC lower limit. Record this attenuator setting. Calculate the AGC lower power level at the 8743A or 8745A REFERENCE port by subtracting the total attenuation set at the HP 355C and 355D attenuators from the AGC upper limit noted in step e. The AGC range should be 20 dB or greater and should be between the limits of -16 dBm and -44 dBm. Note the limits of the AGC range.</p> <p>g. Select the middle 20 dB segment from the AGC range noted in step f. (For example, if the measured AGC range were -20 dBm to -44 dBm, the middle 20 dB segment would be -22 dBm to -42 dBm. This would be a range of settings on the 355C and 355D attenuators between 2 dB and 22 dB.) Set the 355C and 355D attenuators for the upper end of selected 20 dB AGC range. (In the example, this would be a 2 dB setting.)</p> <p>h. Press the 8413A PHASE 6 degree pushbutton to select the lowest phase scale. Adjust the 8413A meter to zero by adjusting the 8413A PHASE OFFSET switches, the 8410A PHASE VERNIER control, and the 8743A or 8745A REFERENCE PLANE EXTENSION control.</p> <p>i. Slowly increase attenuation of 355C and 355D attenuators, one dB at a time, until 20 dB of attenuation is added and the lower end of the 20-dB AGC segment is reached. The difference between the maximum and minimum indication on the 8413A meter should not be more than 4 degrees.</p> <p>j. Press the 8413A AMPLITUDE 3 dB pushbutton to select the lowest amplitude range. Adjust the 8410A AMPL VERNIER and AMPLITUDE TEST CHANNEL GAIN controls to obtain a zero indication on the 8413A meter. Adjust the 355C and 355D attenuators through the same 20-dB range used in step i. The difference between the maximum and minimum indication on the 8413A meter should not be more than 1.5 dB.</p> | <p><u>SPECIFICATION TESTED</u></p> <p>TEST CHANNEL DYNAMIC RANGE: 60 dB or greater.</p> | <p><u>TEST DESCRIPTION</u></p> <p>A known signal level of -15 dBm is applied to the 8411A TEST channel RF input. The corresponding amplitude indication on the 8413A meter is noted. This represents the top of the test channel input power range. A variable attenuator is used to reduce the RF signal at the input of the 8411A to -75 dBm (a change of 60 dB). The corresponding indication is</p> |
|------|---------------------------|--------------|--|---|---|
| 4    |                           |              |  |   |   |

4  
(Contd)

then read on the 8413A meter. The indication is corrected by accounting for the ambiguity due to noise at this low signal level, and by using the calibration data from the variable attenuator.

DESCRIPTION AND PROCEDURE

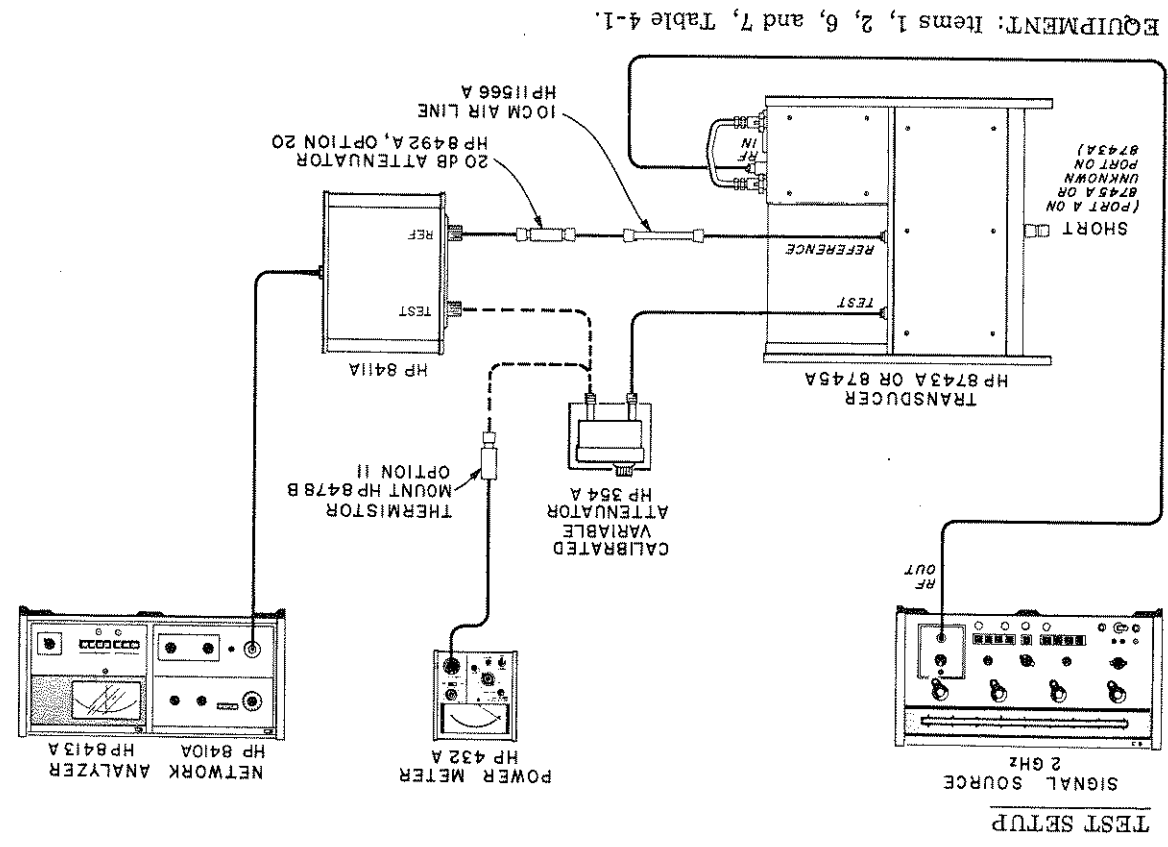

PROCEDURE

- a. Change equipment test setup as shown above. Install short on port A of 8745A or UNKNOWN port of 8743A. If 8745A is used, depress INPUT PORT A and S11 pushbuttons. If 8743A is used, depress REF L pushbutton. Set signal source for single-frequency (CW) operation at 2 GHz.
- b. Check for phase-locked condition in the 8410A as follows:
  - (1) REF CHANNEL LEVEL meter should indicate in the OPERATE range. If not, adjust signal source power output to obtain OPERATE indication on meter.
  - (2) Depress 8413A PHASE 180 degree pushbutton. Adjust the 8410A PHASE VERNIER control: the 8413A meter indication should change smoothly indicating the 8410A is phase locked.
- c. Connect thermistor mount to variable attenuator output.
- d. Set variable attenuator and 8410A TEST CHANNEL GAIN controls to zero dB.

Figure 4-1. Performance Test Procedure Common to all Systems. (Sheet 7 of 20)

Figure 4-1. Performance Test Procedure Common to all Systems. (Sheet 8 of 20)

| TEST         | DESCRIPTION AND PROCEDURE   | SPECIFICATION TESTED  | DESCRIPTION  |
|--------------|---|---|--|
| 4<br>(Contd) | <p><u>PROCEDURE</u></p> <p>e. Adjust signal source for -15 dBm indication on power meter. Signal source output power should not be adjusted again during the remainder of the test. Disconnect the resistor mount from variable attenuator and connect variable attenuator output to 8411A TEST input.</p> <p>f. Depress 8413A AMPLITUDE 3 dB pushbutton. Adjust 8410A AMPL. VERNIER control and TEST CHANNEL GAIN units (1 dB/step) control for zero indication on the 8413A meter.</p> <p>g. Set variable attenuator to 60 dB then set 8410A TEST CHANNEL GAIN tens (10 dB/step) control to 60 dB. The 8413A meter indication should remain at zero. Any deviation should be due only to the effect of signal-to-noise ratio, cross talk, TEST CHANNEL GAIN control error, and variable attenuator error. The deviation limits due to these factors can be calculated as follows:</p> <p>(1) Maximum 8413A meter indication = 0.6 dB noise + 0.2 dB TEST CHANNEL GAIN control tolerance - actual attenuation of variable attenuator at 60-dB setting + 60 dB.</p> <p>(2) Minimum 8413A meter indication = -0.2 dB TEST CHANNEL GAIN tolerance - actual attenuation of variable attenuator at 60 dB setting + 60 dB.</p> <p>For example, if the calibration on the variable attenuator at the 60-dB position is 59.1 dB, then for this example:</p> <p>Maximum = +0.6 dB + 0.2 dB - 59.1 dB + 60 dB = +1.7 dB</p> <p>Minimum = -0.2 dB - 59.1 dB + 60 dB = +0.7 dB</p> <p>Therefore, the 8413A meter indication should be between +0.7 dB and +1.7 dB.</p> | <p><u>PHASE METER AND FRONT-PANEL 10 MV/DEG OUTPUT ACCURACY:</u></p> <p>Phase Meter: ±2% of full scale</p> <p>10 MV/DEG Output: ±2% of DVM indication or ±1 mV, whichever is greater.</p> | <p><u>DESCRIPTION</u></p> <p>An accurate phase shift is established by setting the signal source to a single frequency and inserting electrical length in one channel to unbalance the channels a given portion of a wavelength. The accuracies of the 8413A meter indications and 10 MV/DEG output are compared against these precise phase shifts.</p> |



TEST

DESCRIPTION AND PROCEDURE

5  
(Contd)

TEST SETUP

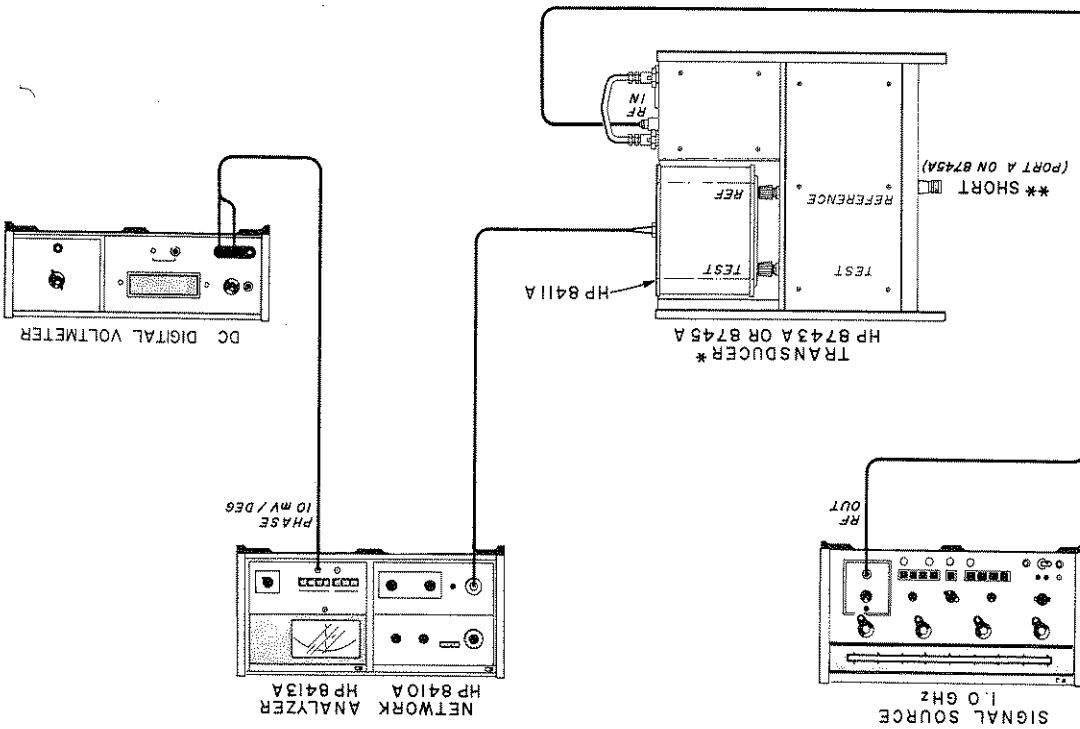

\*The coupling of the 8743A internal directional coupler rolls off below 2.0 GHz; however, this unit may be used at 1.0 GHz for these tests.  
 \*\*If 8743A is used, leave UNKNOWN port open; if 8745A is used, connect short to PORT A.  
 EQUIPMENT: Items 1 and 14, Table 4-1.

PROCEDURE

- a. Change equipment test setup as shown above. If an 8743A is used, leave UNKNOWN port open and depress REF L pushbutton. If an 8745A is used, connect APC-7 short to PORT A and depress INPUT PORT A and S11 pushbuttons. Set signal source for single-frequency (CW) operation at 1.0 GHz.
- b. Check for phase-locked condition in the 8410A as follows:
  - (1) REF CHANNEL LEVEL meter should indicate in the OPERATE range. If not, adjust signal source power output to obtain OPERATE indication on meter.
  - (2) Depress 8413A PHASE 180 degree pushbutton. Adjust the 8410A PHASE VERNIER control; the 8413A phase meter indication should change smoothly, indicating the 8410A is phase locked.
- c. Obtain an RF signal with 30-cm wavelength as follows:

Figure 4-1. Performance Test Procedure Common to all Systems. (Sheet 9 of 20)

Figure 4-1. Performance Test Procedure Common to all Systems. (Sheet 10 of 20)

| TEST         | DESCRIPTION AND PROCEDURE   |
|--------------|---|
| 5<br>(Contd) | <p style="text-align: center;"><u>PROCEDURE</u></p> <p style="text-align: center;">NOTE</p> <p>To eliminate mechanical backlash error when adjusting the transducer REFERENCE PLANE EXTENSION, always approach each setting from the same direction.</p> <p>(1) Adjust transducer REFERENCE PLANE EXTENSION crank for zero digital counter indication, then hold thumbwheel and adjust crank fully counterclockwise.</p> <p>(2) Adjust 8413A PHASE OFFSET and 8410A PHASE VERNIER for a zero <math>\pm 0.5</math> millivolt indication on the DVM.</p> <p>(3) Adjust REFERENCE PLANE EXTENSION for 15.00 cm digital counter indication. DVM should indicate zero <math>\pm 1</math> millivolt. If not, adjust signal source frequency for zero <math>\pm 1</math> millivolt DVM indication. Adjust REFERENCE PLANE EXTENSION fully counterclockwise and repeat steps (2) and (3) until DVM indication is zero when digital counter is set to both zero and 15.00 cm.</p> <p>d. Readjust the REFERENCE PLANE EXTENSION as follows:</p> <p>(1) Adjust the crank to obtain a digital counter indication of 7.5 cm.</p> <p>(2) Hold thumbwheel to retain this indication, and adjust crank fully clockwise.</p> <p>(3) Release thumbwheel and adjust crank counterclockwise until the digital counter indicates zero.</p> <p>e. Adjust the 8413A PHASE OFFSET switch and 8410A PHASE VERNIER control for a zero <math>\pm 0.5</math> millivolt indication on the DVM.</p> <p>f. Check the 8413A phase meter and 10 MV/DEG output voltage accuracy as indicated in table below.</p> <p style="text-align: center;">NOTE</p> <p>The signal source frequency and REFERENCE PLANE EXTENSION settings are critical; therefore, if any indication is out of tolerance, readjust signal source frequency (step c), recheck zero settings (step d), and repeat the digital counter setting.</p> |

| TEST  | DESCRIPTION AND PROCEDURE  |   |                                    |                                    |                                    |         |    |               |             |          |    |               |             |         |     |                |              |          |     |                |              |         |     |                 |              |          |     |                 |              |         |      |                  |               |          |      |                  |               |
|---|--|---|------------------------------------|------------------------------------|------------------------------------|---------|----|---------------|-------------|----------|----|---------------|-------------|---------|-----|----------------|--------------|----------|-----|----------------|--------------|---------|-----|-----------------|--------------|----------|-----|-----------------|--------------|---------|------|------------------|---------------|----------|------|------------------|---------------|
| 5<br>(Contd)                                  | <p style="text-align: center;"><u>PROCEDURE</u></p> <table border="1" style="width: 100%; border-collapse: collapse;"> <thead> <tr> <th style="width: 25%;">8743A or 8745A<br/>Digital Counter<br/>Setting*</th> <th style="width: 25%;">8413A<br/>Phase<br/>Range</th> <th style="width: 25%;">Digital<br/>Voltmeter<br/>Indication</th> <th style="width: 25%;">8413A<br/>Phase Meter<br/>Indication</th> </tr> </thead> <tbody> <tr> <td>0.21 cm</td> <td>6°</td> <td>+50 mV ± 1 mV</td> <td>+5° ± 0.12°</td> </tr> <tr> <td>99.79 cm</td> <td>6°</td> <td>-50 mV ± 1 mV</td> <td>-5° ± 0.12°</td> </tr> <tr> <td>0.62 cm</td> <td>18°</td> <td>+150 mV ± 3 mV</td> <td>+15° ± 0.36°</td> </tr> <tr> <td>99.38 cm</td> <td>18°</td> <td>-150 mV ± 3 mV</td> <td>-15° ± 0.36°</td> </tr> <tr> <td>2.08 cm</td> <td>60°</td> <td>+500 mV ± 10 mV</td> <td>+50° ± 1.20°</td> </tr> <tr> <td>97.92 cm</td> <td>60°</td> <td>-500 mV ± 10 mV</td> <td>-50° ± 1.20°</td> </tr> <tr> <td>6.25 cm</td> <td>180°</td> <td>+1.5 Vdc ± 30 mV</td> <td>+150° ± 3.60°</td> </tr> <tr> <td>93.75 cm</td> <td>180°</td> <td>-1.5 Vdc ± 30 mV</td> <td>-150° ± 3.60°</td> </tr> </tbody> </table> <p>*Adjust the 8743A or 8745A REFERENCE PLANE EXTENSION to obtain digital counter settings. Instructions for obtaining initial setting are given in step d. To eliminate mechanical backlash error, always approach each setting from the same direction.</p> | 8743A or 8745A<br>Digital Counter<br>Setting* | 8413A<br>Phase<br>Range            | Digital<br>Voltmeter<br>Indication | 8413A<br>Phase Meter<br>Indication | 0.21 cm | 6° | +50 mV ± 1 mV | +5° ± 0.12° | 99.79 cm | 6° | -50 mV ± 1 mV | -5° ± 0.12° | 0.62 cm | 18° | +150 mV ± 3 mV | +15° ± 0.36° | 99.38 cm | 18° | -150 mV ± 3 mV | -15° ± 0.36° | 2.08 cm | 60° | +500 mV ± 10 mV | +50° ± 1.20° | 97.92 cm | 60° | -500 mV ± 10 mV | -50° ± 1.20° | 6.25 cm | 180° | +1.5 Vdc ± 30 mV | +150° ± 3.60° | 93.75 cm | 180° | -1.5 Vdc ± 30 mV | -150° ± 3.60° |
| 8743A or 8745A<br>Digital Counter<br>Setting* | 8413A<br>Phase<br>Range  | Digital<br>Voltmeter<br>Indication            | 8413A<br>Phase Meter<br>Indication |                                    |                                    |         |    |               |             |          |    |               |             |         |     |                |              |          |     |                |              |         |     |                 |              |          |     |                 |              |         |      |                  |               |          |      |                  |               |
| 0.21 cm                                       | 6°   | +50 mV ± 1 mV                                 | +5° ± 0.12°                        |                                    |                                    |         |    |               |             |          |    |               |             |         |     |                |              |          |     |                |              |         |     |                 |              |          |     |                 |              |         |      |                  |               |          |      |                  |               |
| 99.79 cm                                      | 6°   | -50 mV ± 1 mV                                 | -5° ± 0.12°                        |                                    |                                    |         |    |               |             |          |    |               |             |         |     |                |              |          |     |                |              |         |     |                 |              |          |     |                 |              |         |      |                  |               |          |      |                  |               |
| 0.62 cm                                       | 18°  | +150 mV ± 3 mV                                | +15° ± 0.36°                       |                                    |                                    |         |    |               |             |          |    |               |             |         |     |                |              |          |     |                |              |         |     |                 |              |          |     |                 |              |         |      |                  |               |          |      |                  |               |
| 99.38 cm                                      | 18°  | -150 mV ± 3 mV                                | -15° ± 0.36°                       |                                    |                                    |         |    |               |             |          |    |               |             |         |     |                |              |          |     |                |              |         |     |                 |              |          |     |                 |              |         |      |                  |               |          |      |                  |               |
| 2.08 cm                                       | 60°  | +500 mV ± 10 mV                               | +50° ± 1.20°                       |                                    |                                    |         |    |               |             |          |    |               |             |         |     |                |              |          |     |                |              |         |     |                 |              |          |     |                 |              |         |      |                  |               |          |      |                  |               |
| 97.92 cm                                      | 60°  | -500 mV ± 10 mV                               | -50° ± 1.20°                       |                                    |                                    |         |    |               |             |          |    |               |             |         |     |                |              |          |     |                |              |         |     |                 |              |          |     |                 |              |         |      |                  |               |          |      |                  |               |
| 6.25 cm                                       | 180°   | +1.5 Vdc ± 30 mV                              | +150° ± 3.60°                      |                                    |                                    |         |    |               |             |          |    |               |             |         |     |                |              |          |     |                |              |         |     |                 |              |          |     |                 |              |         |      |                  |               |          |      |                  |               |
| 93.75 cm                                      | 180°   | -1.5 Vdc ± 30 mV                              | -150° ± 3.60°                      |                                    |                                    |         |    |               |             |          |    |               |             |         |     |                |              |          |     |                |              |         |     |                 |              |          |     |                 |              |         |      |                  |               |          |      |                  |               |
| 6   | <p style="text-align: center;"><u>SPECIFICATION TESTED</u></p> <p>PHASE OFFSET ACCURACY: ±(0.2 degree + 0.3 degree per 10-degree step), not to exceed ±1.5 degrees cumulative, referenced from zero degrees.</p>   |   |                                    |                                    |                                    |         |    |               |             |          |    |               |             |         |     |                |              |          |     |                |              |         |     |                 |              |          |     |                 |              |         |      |                  |               |          |      |                  |               |
|   | <p style="text-align: center;"><u>DESCRIPTION</u></p> <p>An accurate phase shift is established by setting the signal source to a single frequency and inserting electrical length in one channel to unbalance the channels a given portion of a wavelength. The accuracy of the 8413A PHASE OFFSET is compared against these precise phase shifts.</p>  |   |                                    |                                    |                                    |         |    |               |             |          |    |               |             |         |     |                |              |          |     |                |              |         |     |                 |              |          |     |                 |              |         |      |                  |               |          |      |                  |               |

Figure 4-1. Performance Test Procedure Common to all Systems. (Sheet 11 of 20)

Figure 4-1. Performance Test Procedure Common to all Systems. (Sheet 12 of 20)

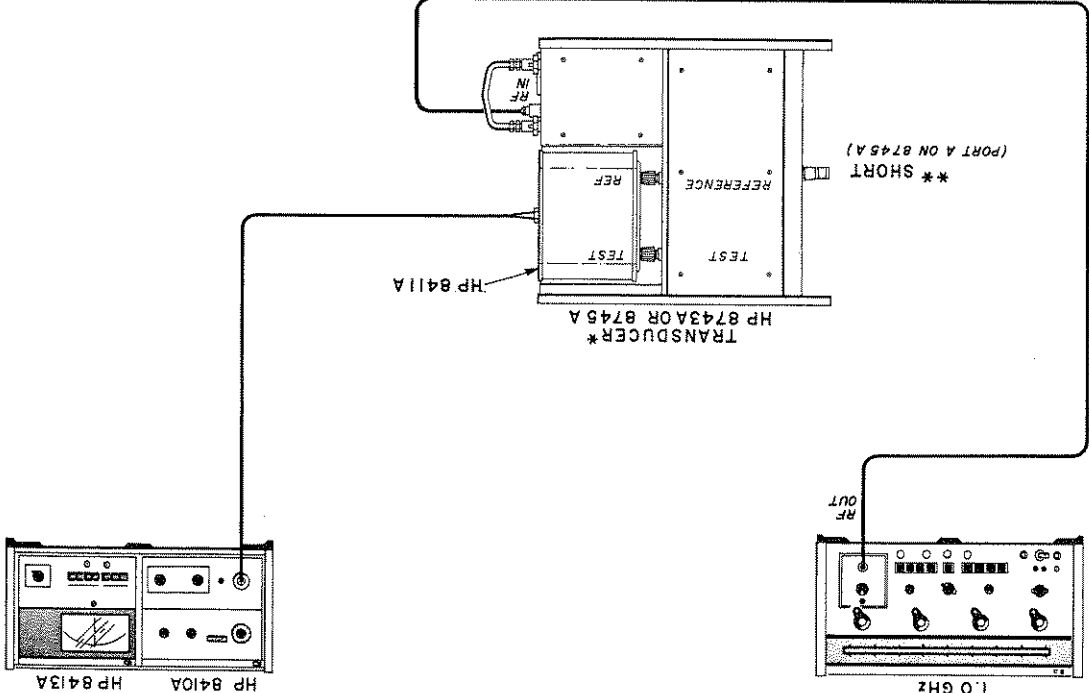
| TEST         | DESCRIPTION AND PROCEDURE   |
|--------------|---|
| 6<br>(Contd) | <p style="text-align: center;"><u>TEST SETUP</u></p>  <p style="text-align: center;">*The coupling of the 8743A internal directional coupler rolls off below 2.0 GHz; however, this unit may be used at 1.0 GHz for these tests.</p> <p style="text-align: center;">**If 8743A is used, leave UNKNOWN port open; if 8745A is used, connect short to PORT A.</p> <p style="text-align: center;">EQUIPMENT: Item 1, Table 4-1.</p>  |
|              | <p style="text-align: center;"><u>PROCEDURE</u></p> <ol style="list-style-type: none"> <li>a. Change equipment test setup as shown above. If an 8743A is used, leave UNKNOWN port open and depress REFLECT pushbutton. If an 8745A is used, connect APC-7 short to PORT A and depress REFLECT pushbutton. Set signal source for single-frequency (CW) operation at 1.0 GHz.</li> <li>b. Check for phase-locked condition in the 8410A as follows:             <ol style="list-style-type: none"> <li>(1) REF CHANNEL LEVEL meter should indicate in the OPERATE range. If not, adjust signal source power output to obtain OPERATE indication on meter.</li> <li>(2) Depress 8413A PHASE 180 degree pushbutton. Adjust the 8410A PHASE VERNIER control; the 8413A phase meter indication should change smoothly, indicating the 8410A is phase locked.</li> </ol> </li> </ol> |

| TEST         | DESCRIPTION AND PROCEDURE   |
|--------------|---|
| 6<br>(Contd) | <p style="text-align: center;"><u>PROCEDURE</u></p> <p>c. If the signal source frequency has not been changed from Test 5, proceed to step d. If the frequency has been changed, obtain an RF signal with 30-cm wavelength as follows:</p> <p style="text-align: center;">NOTE</p> <p>To eliminate mechanical backlash error when adjusting the transducer REFERENCE PLANE EXTENSION, always approach each setting from the same direction.</p> <p>(1) Adjust transducer REFERENCE PLANE EXTENSION crank for zero digital counter indication, then hold thumbwheel and adjust crank fully counterclockwise.</p> <p>(2) Adjust 8413A PHASE OFFSET and 8410A PHASE VERNIER for a zero phase indication on the 8413A 6 degree range.</p> <p>(3) Adjust REFERENCE PLANE EXTENSION for 15.00 cm digital counter indication. Phase indication should be zero. If not, adjust signal source frequency for 8413A zero degree phase indication. Adjust REFERENCE PLANE EXTENSION fully counterclockwise and repeat steps (2) and (3) until 8413A phase indication is zero when digital counter is set to both zero and 15.00 cm.</p> <p>d. Set the 8413A PHASE OFFSET to zero, and depress 180 degree pushbutton.</p> <p>e. Adjust the 8410A PHASE VERNIER to approximately mid-range.</p> <p>f. Adjust the transducer REFERENCE PLANE EXTENSION crank for zero digital counter indication, hold thumbwheel and adjust crank fully counter-clockwise. Continue to hold thumbwheel and adjust crank for a zero 8413A phase indication.</p> <p>g. Depress the 8413A 6 degree pushbutton and adjust the 8410A PHASE VERNIER for a zero degree phase meter indication.</p> <p>h. Check the 8413A + PHASE OFFSET accuracy as indicated in the table below.</p> <p style="text-align: center;">NOTE</p> <p>The signal source frequency and REFERENCE PLANE EXTENSION settings are critical; therefore, if any indication is out of tolerance, recheck the frequency in step c and zero setting in step g, then repeat the digital counter setting.</p> |

Figure 4-1. Performance Test Procedure Common to all Systems. (Sheet 13 of 20)

Figure 4-1. Performance Test Procedure Common to all Systems (Sheet 14 of 20)

- i. Adjust the transducer REFERENCE PLANE EXTENSION for zero digital counter indication, hold thumbwheel and adjust crank fully clockwise.
- j. Set the 8413A PHASE OFFSET to minus (-) zero degrees and adjust the 8410A PHASE VERNIER for a zero phase meter indication on the 8413A 6 degree range.
- k. Check the 8413A minus (-) PHASE OFFSET accuracy as indicated in the table on the following page.

\*Adjust the 8743A or 8745A REFERENCE PLANE EXTENSION to obtain digital counter settings. Instructions for obtaining initial setting, are given in steps d and e. To eliminate mechanical backlash error, always approach each setting from the same direction.

| 8743A or 8745A Digital Counter Setting* | 8413A PHASE OFFSET Setting | 8413A Meter Indication |
|---|----------------------------|------------------------|
| 0.42 cm                                 | +10°                       | 0 ± 0.5°               |
| 0.83 cm                                 | +20°                       | 0 ± 0.8°               |
| 1.25 cm                                 | +30°                       | 0 ± 1.1°               |
| 1.67 cm                                 | +40°                       | 0 ± 1.4°               |
| 2.08 cm                                 | +50°                       | 0 ± 1.5°               |
| 2.50 cm                                 | +60°                       | 0 ± 1.5°               |
| 2.92 cm                                 | +70°                       | 0 ± 1.5°               |
| 3.33 cm                                 | +80°                       | 0 ± 1.5°               |
| 3.75 cm                                 | +90°                       | 0 ± 1.5°               |
| 4.17 cm                                 | +100°                      | 0 ± 1.5°               |
| 4.58 cm                                 | +110°                      | 0 ± 1.5°               |
| 5.00 cm                                 | +120°                      | 0 ± 1.5°               |
| 5.42 cm                                 | +130°                      | 0 ± 1.5°               |
| 5.83 cm                                 | +140°                      | 0 ± 1.5°               |
| 6.25 cm                                 | +150°                      | 0 ± 1.5°               |
| 6.67 cm                                 | +160°                      | 0 ± 1.5°               |
| 7.08 cm                                 | +170°                      | 0 ± 1.5°               |
| 7.50 cm                                 | +180°                      | 0 ± 1.5°               |

PROCEDURE

(Contd)  
6

TEST DESCRIPTION AND PROCEDURE

| TEST                                       | DESCRIPTION AND PROCEDURE   |  |                       |                                 |          |      |          |          |      |          |          |      |          |          |      |          |          |      |          |          |      |          |          |      |          |          |      |          |          |      |          |          |       |          |          |       |          |          |       |          |          |       |          |          |       |          |          |       |          |          |       |          |          |       |          |          |       |          |
|--|---|--|-----------------------|---------------------------------|----------|------|----------|----------|------|----------|----------|------|----------|----------|------|----------|----------|------|----------|----------|------|----------|----------|------|----------|----------|------|----------|----------|------|----------|----------|-------|----------|----------|-------|----------|----------|-------|----------|----------|-------|----------|----------|-------|----------|----------|-------|----------|----------|-------|----------|----------|-------|----------|----------|-------|----------|
| 6<br>(Contd)                               | <p style="text-align: center;"><u>PROCEDURE</u></p> <table border="1" style="width: 100%; border-collapse: collapse;"> <thead> <tr> <th style="width: 33%;">8743A or 8745A<br/>Digital Counter Setting*</th> <th style="width: 33%;">8413A<br/>PHASE OFFSET</th> <th style="width: 33%;">8413A Phase<br/>Meter Indication</th> </tr> </thead> <tbody> <tr><td>99.58 cm</td><td>-10°</td><td>0 ± 0.5°</td></tr> <tr><td>99.17 cm</td><td>-20°</td><td>0 ± 0.8°</td></tr> <tr><td>98.75 cm</td><td>-30°</td><td>0 ± 1.1°</td></tr> <tr><td>98.33 cm</td><td>-40°</td><td>0 ± 1.4°</td></tr> <tr><td>97.92 cm</td><td>-50°</td><td>0 ± 1.5°</td></tr> <tr><td>97.50 cm</td><td>-60°</td><td>0 ± 1.5°</td></tr> <tr><td>96.80 cm</td><td>-70°</td><td>0 ± 1.5°</td></tr> <tr><td>96.67 cm</td><td>-80°</td><td>0 ± 1.5°</td></tr> <tr><td>96.25 cm</td><td>-90°</td><td>0 ± 1.5°</td></tr> <tr><td>95.83 cm</td><td>-100°</td><td>0 ± 1.5°</td></tr> <tr><td>95.42 cm</td><td>-110°</td><td>0 ± 1.5°</td></tr> <tr><td>95.00 cm</td><td>-120°</td><td>0 ± 1.5°</td></tr> <tr><td>94.58 cm</td><td>-130°</td><td>0 ± 1.5°</td></tr> <tr><td>94.17 cm</td><td>-140°</td><td>0 ± 1.5°</td></tr> <tr><td>93.75 cm</td><td>-150°</td><td>0 ± 1.5°</td></tr> <tr><td>93.33 cm</td><td>-160°</td><td>0 ± 1.5°</td></tr> <tr><td>92.92 cm</td><td>-170°</td><td>0 ± 1.5°</td></tr> <tr><td>92.50 cm</td><td>-180°</td><td>0 ± 1.5°</td></tr> </tbody> </table> <p>*Adjust the 8743A or 8745A REFERENCE PLANE EXTENSION to obtain digital counter settings. Instructions for obtaining initial setting are given in steps i and j. To eliminate mechanical backlash error, always approach each setting from the same direction.</p> | 8743A or 8745A<br>Digital Counter Setting* | 8413A<br>PHASE OFFSET | 8413A Phase<br>Meter Indication | 99.58 cm | -10° | 0 ± 0.5° | 99.17 cm | -20° | 0 ± 0.8° | 98.75 cm | -30° | 0 ± 1.1° | 98.33 cm | -40° | 0 ± 1.4° | 97.92 cm | -50° | 0 ± 1.5° | 97.50 cm | -60° | 0 ± 1.5° | 96.80 cm | -70° | 0 ± 1.5° | 96.67 cm | -80° | 0 ± 1.5° | 96.25 cm | -90° | 0 ± 1.5° | 95.83 cm | -100° | 0 ± 1.5° | 95.42 cm | -110° | 0 ± 1.5° | 95.00 cm | -120° | 0 ± 1.5° | 94.58 cm | -130° | 0 ± 1.5° | 94.17 cm | -140° | 0 ± 1.5° | 93.75 cm | -150° | 0 ± 1.5° | 93.33 cm | -160° | 0 ± 1.5° | 92.92 cm | -170° | 0 ± 1.5° | 92.50 cm | -180° | 0 ± 1.5° |
| 8743A or 8745A<br>Digital Counter Setting* | 8413A<br>PHASE OFFSET   | 8413A Phase<br>Meter Indication            |                       |                                 |          |      |          |          |      |          |          |      |          |          |      |          |          |      |          |          |      |          |          |      |          |          |      |          |          |      |          |          |       |          |          |       |          |          |       |          |          |       |          |          |       |          |          |       |          |          |       |          |          |       |          |          |       |          |
| 99.58 cm                                   | -10°  | 0 ± 0.5°                                   |                       |                                 |          |      |          |          |      |          |          |      |          |          |      |          |          |      |          |          |      |          |          |      |          |          |      |          |          |      |          |          |       |          |          |       |          |          |       |          |          |       |          |          |       |          |          |       |          |          |       |          |          |       |          |          |       |          |
| 99.17 cm                                   | -20°  | 0 ± 0.8°                                   |                       |                                 |          |      |          |          |      |          |          |      |          |          |      |          |          |      |          |          |      |          |          |      |          |          |      |          |          |      |          |          |       |          |          |       |          |          |       |          |          |       |          |          |       |          |          |       |          |          |       |          |          |       |          |          |       |          |
| 98.75 cm                                   | -30°  | 0 ± 1.1°                                   |                       |                                 |          |      |          |          |      |          |          |      |          |          |      |          |          |      |          |          |      |          |          |      |          |          |      |          |          |      |          |          |       |          |          |       |          |          |       |          |          |       |          |          |       |          |          |       |          |          |       |          |          |       |          |          |       |          |
| 98.33 cm                                   | -40°  | 0 ± 1.4°                                   |                       |                                 |          |      |          |          |      |          |          |      |          |          |      |          |          |      |          |          |      |          |          |      |          |          |      |          |          |      |          |          |       |          |          |       |          |          |       |          |          |       |          |          |       |          |          |       |          |          |       |          |          |       |          |          |       |          |
| 97.92 cm                                   | -50°  | 0 ± 1.5°                                   |                       |                                 |          |      |          |          |      |          |          |      |          |          |      |          |          |      |          |          |      |          |          |      |          |          |      |          |          |      |          |          |       |          |          |       |          |          |       |          |          |       |          |          |       |          |          |       |          |          |       |          |          |       |          |          |       |          |
| 97.50 cm                                   | -60°  | 0 ± 1.5°                                   |                       |                                 |          |      |          |          |      |          |          |      |          |          |      |          |          |      |          |          |      |          |          |      |          |          |      |          |          |      |          |          |       |          |          |       |          |          |       |          |          |       |          |          |       |          |          |       |          |          |       |          |          |       |          |          |       |          |
| 96.80 cm                                   | -70°  | 0 ± 1.5°                                   |                       |                                 |          |      |          |          |      |          |          |      |          |          |      |          |          |      |          |          |      |          |          |      |          |          |      |          |          |      |          |          |       |          |          |       |          |          |       |          |          |       |          |          |       |          |          |       |          |          |       |          |          |       |          |          |       |          |
| 96.67 cm                                   | -80°  | 0 ± 1.5°                                   |                       |                                 |          |      |          |          |      |          |          |      |          |          |      |          |          |      |          |          |      |          |          |      |          |          |      |          |          |      |          |          |       |          |          |       |          |          |       |          |          |       |          |          |       |          |          |       |          |          |       |          |          |       |          |          |       |          |
| 96.25 cm                                   | -90°  | 0 ± 1.5°                                   |                       |                                 |          |      |          |          |      |          |          |      |          |          |      |          |          |      |          |          |      |          |          |      |          |          |      |          |          |      |          |          |       |          |          |       |          |          |       |          |          |       |          |          |       |          |          |       |          |          |       |          |          |       |          |          |       |          |
| 95.83 cm                                   | -100°   | 0 ± 1.5°                                   |                       |                                 |          |      |          |          |      |          |          |      |          |          |      |          |          |      |          |          |      |          |          |      |          |          |      |          |          |      |          |          |       |          |          |       |          |          |       |          |          |       |          |          |       |          |          |       |          |          |       |          |          |       |          |          |       |          |
| 95.42 cm                                   | -110°   | 0 ± 1.5°                                   |                       |                                 |          |      |          |          |      |          |          |      |          |          |      |          |          |      |          |          |      |          |          |      |          |          |      |          |          |      |          |          |       |          |          |       |          |          |       |          |          |       |          |          |       |          |          |       |          |          |       |          |          |       |          |          |       |          |
| 95.00 cm                                   | -120°   | 0 ± 1.5°                                   |                       |                                 |          |      |          |          |      |          |          |      |          |          |      |          |          |      |          |          |      |          |          |      |          |          |      |          |          |      |          |          |       |          |          |       |          |          |       |          |          |       |          |          |       |          |          |       |          |          |       |          |          |       |          |          |       |          |
| 94.58 cm                                   | -130°   | 0 ± 1.5°                                   |                       |                                 |          |      |          |          |      |          |          |      |          |          |      |          |          |      |          |          |      |          |          |      |          |          |      |          |          |      |          |          |       |          |          |       |          |          |       |          |          |       |          |          |       |          |          |       |          |          |       |          |          |       |          |          |       |          |
| 94.17 cm                                   | -140°   | 0 ± 1.5°                                   |                       |                                 |          |      |          |          |      |          |          |      |          |          |      |          |          |      |          |          |      |          |          |      |          |          |      |          |          |      |          |          |       |          |          |       |          |          |       |          |          |       |          |          |       |          |          |       |          |          |       |          |          |       |          |          |       |          |
| 93.75 cm                                   | -150°   | 0 ± 1.5°                                   |                       |                                 |          |      |          |          |      |          |          |      |          |          |      |          |          |      |          |          |      |          |          |      |          |          |      |          |          |      |          |          |       |          |          |       |          |          |       |          |          |       |          |          |       |          |          |       |          |          |       |          |          |       |          |          |       |          |
| 93.33 cm                                   | -160°   | 0 ± 1.5°                                   |                       |                                 |          |      |          |          |      |          |          |      |          |          |      |          |          |      |          |          |      |          |          |      |          |          |      |          |          |      |          |          |       |          |          |       |          |          |       |          |          |       |          |          |       |          |          |       |          |          |       |          |          |       |          |          |       |          |
| 92.92 cm                                   | -170°   | 0 ± 1.5°                                   |                       |                                 |          |      |          |          |      |          |          |      |          |          |      |          |          |      |          |          |      |          |          |      |          |          |      |          |          |      |          |          |       |          |          |       |          |          |       |          |          |       |          |          |       |          |          |       |          |          |       |          |          |       |          |          |       |          |
| 92.50 cm                                   | -180°   | 0 ± 1.5°                                   |                       |                                 |          |      |          |          |      |          |          |      |          |          |      |          |          |      |          |          |      |          |          |      |          |          |      |          |          |      |          |          |       |          |          |       |          |          |       |          |          |       |          |          |       |          |          |       |          |          |       |          |          |       |          |          |       |          |
| 7  | <p style="text-align: center;"><u>SPECIFICATION TESTED</u></p> <p style="text-align: center;">AMPLITUDE METER AND 50 MV/DB OUTPUT ACCURACY:</p> <p style="text-align: center;">Amplitude Meter: ±3% of full scale.<br/>50 MV/DB Output: ±3% of DVM indication.</p> <p style="text-align: center;"><u>DESCRIPTION</u></p> <p>The 8410A AMPLITUDE TEST CHANNEL GAIN control is used to obtain an accurate change in 8413A input signal amplitude. The accuracy of the 8413A meter indication and the 50 MV/DB voltage output are compared against these precise level changes.</p>  |  |                       |                                 |          |      |          |          |      |          |          |      |          |          |      |          |          |      |          |          |      |          |          |      |          |          |      |          |          |      |          |          |       |          |          |       |          |          |       |          |          |       |          |          |       |          |          |       |          |          |       |          |          |       |          |          |       |          |

Figure 4-1. Performance Test Procedure Common to all Systems. (Sheet 15 of 20)

Figure 4-1. Performance Test Procedure Common to all Systems. (Sheet 16 of 20)

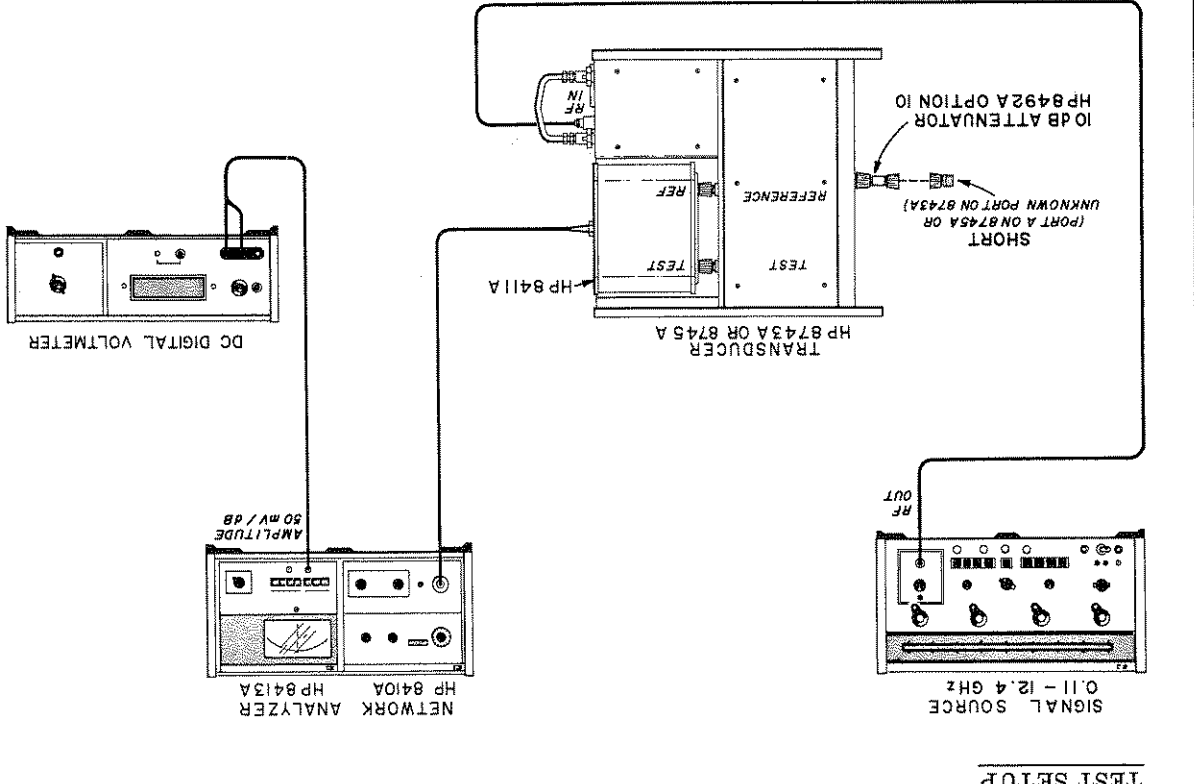
| TEST | DESCRIPTION AND PROCEDURE   | TEST<br>7<br>(Contd) |
|------|---|----------------------|
|      | <p style="text-align: center;"><b>TEST SETUP</b></p>  <p style="text-align: center;"><b>EQUIPMENT:</b> Items 1 and 14, Table 4-1.</p>   |                      |
|      | <p style="text-align: center;"><b>PROCEDURE</b></p> <ol style="list-style-type: none"> <li>a. Change equipment test setup as shown above. Install 10-dB attenuator and short on port A of 8745A or UNKNOWN port of 8743A. If 8745A is used, depress INPUT PORT A and S11 pushbuttons. If 8743A is used, depress REFL pushbutton. Set signal source for single-frequency (CW) operation in the range of the transducer in the test setup.</li> <li>b. Check for phase-locked condition in 8410A as follows:             <ol style="list-style-type: none"> <li>(1) REF CHANNEL LEVEL meter should indicate in the OPERATE range. If not, adjust signal source power output to obtain OPERATE indication on meter.</li> <li>(2) Depress 8413A PHASE 180 degree pushbutton. Adjust the 8410A PHASE VERNIER control: the 8413A phase meter indication should change smoothly, indicating the 8410A is phase locked.</li> </ol> </li> <li>c. Set the 8410A TEST CHANNEL GAIN to 20 dB.</li> <li>d. Adjust the 8410A AMPL VERNIER and the 1 dB/step TEST CHANNEL GAIN control for zero dB indication on the 8413A 3-dB range. Note the 8410A TEST CHANNEL GAIN settings.</li> <li>e. Check the 8413A amplitude meter and 50 MV/DB output voltage accuracy as indicated in the table below.</li> </ol> |                      |



| TEST                                       | DESCRIPTION AND PROCEDURE   |  |                        |                              |                        |       |      |               |                |       |      |               |                |       |       |                  |               |       |       |                  |               |        |       |                 |                |        |       |                 |                |
|--|---|--|------------------------|------------------------------|------------------------|-------|------|---------------|----------------|-------|------|---------------|----------------|-------|-------|------------------|---------------|-------|-------|------------------|---------------|--------|-------|-----------------|----------------|--------|-------|-----------------|----------------|
| 7<br>(Contd)                               | <p style="text-align: center;"><u>PROCEDURE</u></p> <p style="text-align: center;">NOTE</p> <p style="text-align: center;">Recheck zero adjustment (step d above) after each step.</p> <table border="1" data-bbox="243 1234 1128 1659"> <thead> <tr> <th>Change in 8410A TEST CHANNEL GAIN Setting*</th> <th>8413A Amplitude Range</th> <th>Digital Voltmeter Indication</th> <th>8413A Meter Indication</th> </tr> </thead> <tbody> <tr> <td>+2 dB</td> <td>3 dB</td> <td>+100 mV ±3 mV</td> <td>+2 dB ±0.09 dB</td> </tr> <tr> <td>-2 dB</td> <td>3 dB</td> <td>-100 mV ±3 mV</td> <td>-2 dB ±0.09 dB</td> </tr> <tr> <td>+9 dB</td> <td>10 dB</td> <td>+450 mV ±13.5 mV</td> <td>+9 dB ±0.3 dB</td> </tr> <tr> <td>-9 dB</td> <td>10 dB</td> <td>-450 mV ±13.5 mV</td> <td>-9 dB ±0.3 dB</td> </tr> <tr> <td>+20 dB</td> <td>30 dB</td> <td>+1.00Vdc ±30 mV</td> <td>+20 dB ±0.9 dB</td> </tr> <tr> <td>-20 dB</td> <td>30 dB</td> <td>-1.00Vdc ±30 mV</td> <td>-20 dB ±0.9 dB</td> </tr> </tbody> </table> <p style="text-align: center;">*Instructions for obtaining initial setting are given in step d.</p> | Change in 8410A TEST CHANNEL GAIN Setting* | 8413A Amplitude Range  | Digital Voltmeter Indication | 8413A Meter Indication | +2 dB | 3 dB | +100 mV ±3 mV | +2 dB ±0.09 dB | -2 dB | 3 dB | -100 mV ±3 mV | -2 dB ±0.09 dB | +9 dB | 10 dB | +450 mV ±13.5 mV | +9 dB ±0.3 dB | -9 dB | 10 dB | -450 mV ±13.5 mV | -9 dB ±0.3 dB | +20 dB | 30 dB | +1.00Vdc ±30 mV | +20 dB ±0.9 dB | -20 dB | 30 dB | -1.00Vdc ±30 mV | -20 dB ±0.9 dB |
| Change in 8410A TEST CHANNEL GAIN Setting* | 8413A Amplitude Range   | Digital Voltmeter Indication               | 8413A Meter Indication |                              |                        |       |      |               |                |       |      |               |                |       |       |                  |               |       |       |                  |               |        |       |                 |                |        |       |                 |                |
| +2 dB                                      | 3 dB  | +100 mV ±3 mV                              | +2 dB ±0.09 dB         |                              |                        |       |      |               |                |       |      |               |                |       |       |                  |               |       |       |                  |               |        |       |                 |                |        |       |                 |                |
| -2 dB                                      | 3 dB  | -100 mV ±3 mV                              | -2 dB ±0.09 dB         |                              |                        |       |      |               |                |       |      |               |                |       |       |                  |               |       |       |                  |               |        |       |                 |                |        |       |                 |                |
| +9 dB                                      | 10 dB   | +450 mV ±13.5 mV                           | +9 dB ±0.3 dB          |                              |                        |       |      |               |                |       |      |               |                |       |       |                  |               |       |       |                  |               |        |       |                 |                |        |       |                 |                |
| -9 dB                                      | 10 dB   | -450 mV ±13.5 mV                           | -9 dB ±0.3 dB          |                              |                        |       |      |               |                |       |      |               |                |       |       |                  |               |       |       |                  |               |        |       |                 |                |        |       |                 |                |
| +20 dB                                     | 30 dB   | +1.00Vdc ±30 mV                            | +20 dB ±0.9 dB         |                              |                        |       |      |               |                |       |      |               |                |       |       |                  |               |       |       |                  |               |        |       |                 |                |        |       |                 |                |
| -20 dB                                     | 30 dB   | -1.00Vdc ±30 mV                            | -20 dB ±0.9 dB         |                              |                        |       |      |               |                |       |      |               |                |       |       |                  |               |       |       |                  |               |        |       |                 |                |        |       |                 |                |
| 8  | <p style="text-align: center;"><u>SPECIFICATION TESTED</u></p> <p style="text-align: center;">PHASE RESPONSE VERSUS SIGNAL AMPLITUDE: 1.5 degree maximum phase change for 60-dB amplitude change in test channel.</p>   |  |                        |                              |                        |       |      |               |                |       |      |               |                |       |       |                  |               |       |       |                  |               |        |       |                 |                |        |       |                 |                |
|  | <p style="text-align: center;"><u>DESCRIPTION</u></p> <p>Two 278-KHz signals of known amplitude are applied to the 8413A inputs. The 8413A phase indication is observed while the test channel input level is varied by 60 dB.</p>  |  |                        |                              |                        |       |      |               |                |       |      |               |                |       |       |                  |               |       |       |                  |               |        |       |                 |                |        |       |                 |                |

Figure 4-1. Performance Test Procedure Common to all Systems. (Sheet 17 of 20)

Figure 4-1. Performance Test Procedure Common to all Systems. (Sheet 18 of 20)

- a. Remove 8410A top and bottom covers and the cover of rear-panel connector to 8413A plug-in. Disconnect Cable W9 and Cable W4 from J9 and J10 at rear of 8410A bottom casing.
- b. Connect equipment as shown in test setup.
- c. Set 8410A TEST CHANNEL GAIN controls to 00 and AMPL VERNIER control fully counterclockwise.
- d. Adjust output of signal generator set to 278 kHz  $\pm$  0.5 kHz, for 2.3 V p-p at 8410A rear-panel REF CHAN OUTPUT.
- e. Set 0-120 dB variable attenuator to 20 dB.
- f. Set 0-12 dB variable attenuator for 200 mV  $\pm$  10 mV peak-to-peak at 8410A J2, Pin 3.
- g. Turn on the 8410A to supply power to the 8413A.
- h. Set 8413A PHASE OFFSET control for an on-scale meter indication on the  $\pm$ 6 degree range.
- i. Record 8413A meter indication (reference at zero attenuation).
- j. Set the 0-120 dB variable attenuator to 80 dB (an increase of 60 dB). The 8413A

PROCEDURE

EQUIPMENT: Items 4, 11, 12, and 13, Table 4-1

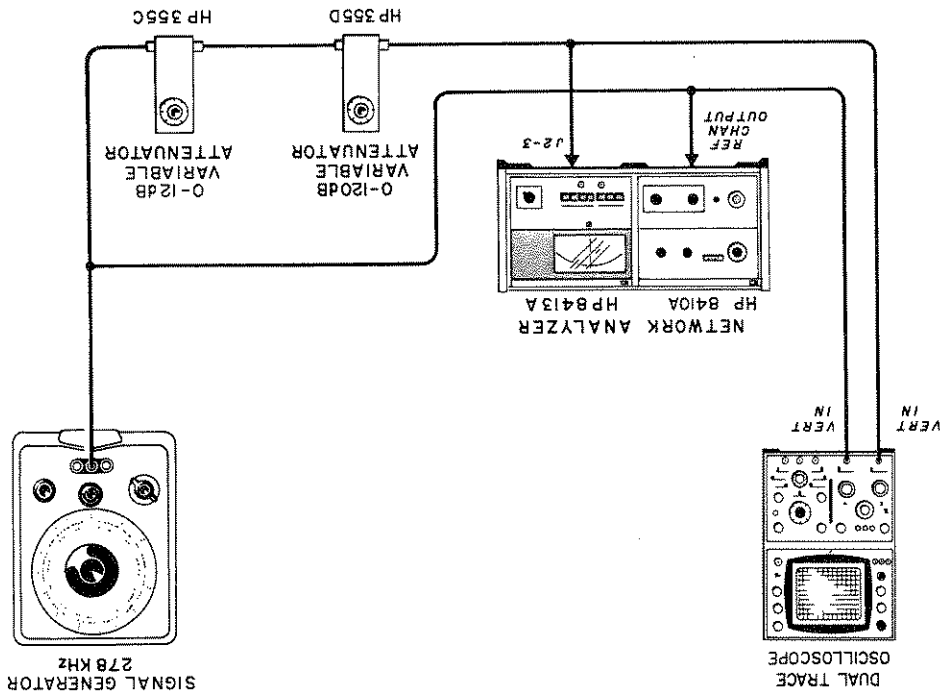

TEST SETUP

8 (Contd)

DESCRIPTION AND PROCEDURE

TEST

|           |   |
|-----------|---|
| TEST      | DESCRIPTION AND PROCEDURE   |
| 8 (Contd) | <p>PROCEDURE</p> <p>indication should not vary more than 1.5 degrees. To compensate for attenuator repeatability, take several sets of readings and average the readings.</p> |

|   |  |
|---|--|
| 9 | <p>SPECIFICATION TESTED</p> <p>HP 8414A POLAR DISPLAY ACCURACY: Error circle on CRT less than 3-mm radius.</p> <p>HORIZONTAL AND VERTICAL OUTPUTS: <math>\pm 2.5</math> Volts</p> <p>BANDWIDTH: Down 3 dB maximum at 10 kHz.</p> |
|---|--|

DESCRIPTION

A 280 kHz signal is mixed with the 278-kHz IF signal to produce a circle trace on the CRT. This trace is superimposed on the outside graticule circle so that any amplitude error may be observed.

The horizontal and vertical output signals are checked for distortion at 5 volts p-p output. Bandwidth of the horizontal and vertical amplifiers is checked by observing the roll-off to 3 dB at a frequency 10 kHz from the IF frequency.

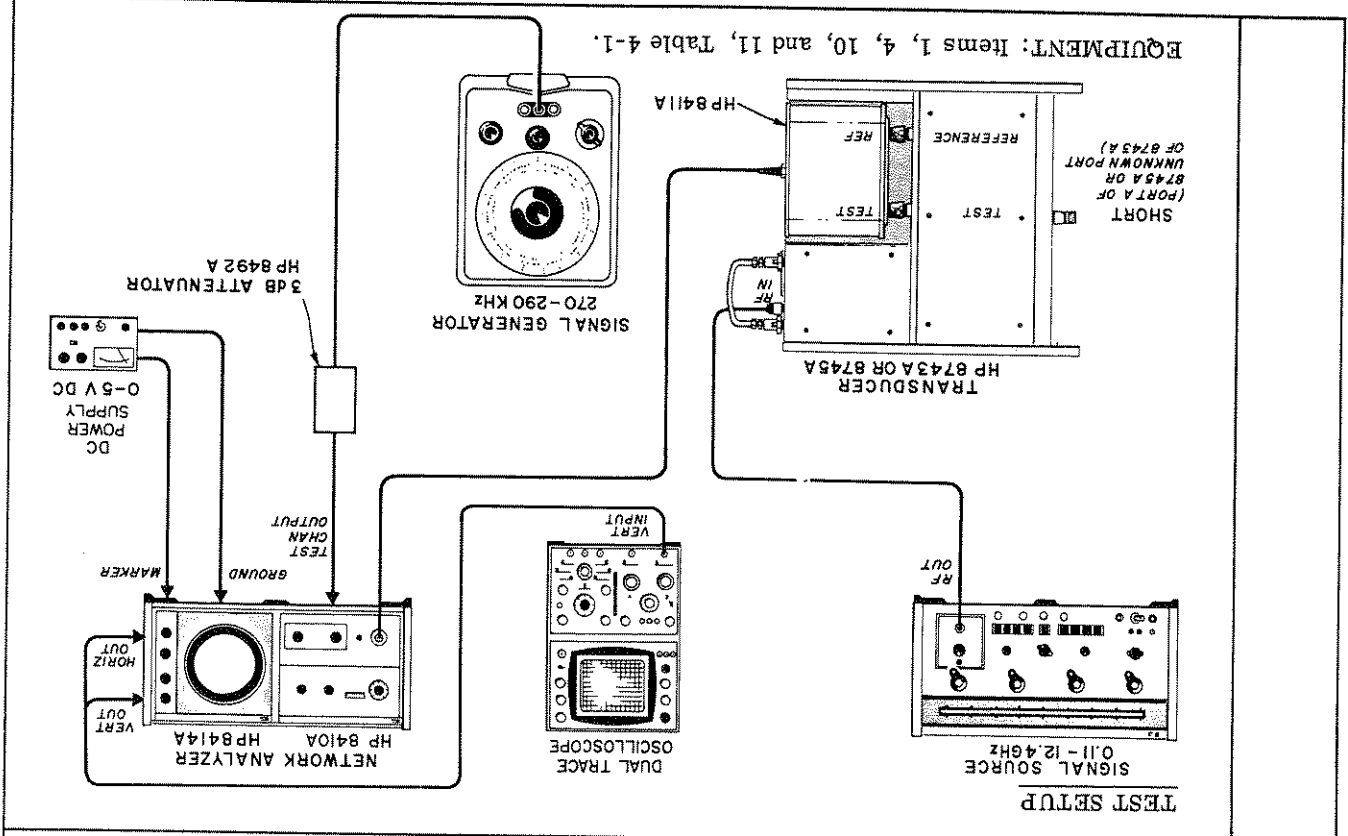

Figure 4-1. Performance Test Procedure Common for all Systems. (Sheet 19 of 20)

Figure 4-1. Performance Test Procedure Common for all Systems. (Sheet 20 of 20)

| TEST         | DESCRIPTION AND PROCEDURE   |
|--------------|---|
| 9<br>(Contd) | <p style="text-align: center;"><u>PROCEDURE</u></p> <p>a. Connect equipment as shown in test setup.</p> <p>b. Set the signal source for single-frequency CW operation in the range of the transducer used. Select reflection mode at transducer (REFL pushbutton on 8743A or A and S11 pushbuttons on 8745A).</p> <p>c. Check for phase-locked condition in the 8410A as follows:<br/>                     (1) The 8410A REF CHANNEL LEVEL meter should indicate in the OPERATE range. If not, adjust signal source power output to obtain OPERATE indication on meter.<br/>                     (2) Adjust the PHASE VERNIER control: the dot on the 8414A should move smoothly, indicating phase lock in the 8410A.</p> <p>d. Depress 8414A BEAM CTR pushbutton and adjust the HORIZ POS and VERT POS controls to place the dot in the center of the CRT.</p> <p>e. Adjust the 270-290 kHz signal generator connected to the 8410A TEST CHAN OUTPUT connector to 280 kHz and increase the amplitude until a trace circle on the 8414A CRT is superimposed on the outside graticule circle.</p> <p>f. Adjust the 8414A HORIZ POS and VERT POS controls if necessary to align the trace on the CRT with the graticule circle.</p> <p>g. The entire trace must be within 3 mm of the outside graticule circle.</p> <p>h. Connect dc-coupled vertical input of oscilloscope to 8414A VERTICAL OUTPUT. Increase 280 kHz signal generator amplitude until a CRT trace of 5 volts peak-to-peak is displayed. There should be no noticeable distortion.</p> <p>i. Connect dc-coupled vertical input of oscilloscope to 8414A HORIZONTAL OUTPUT. If necessary, adjust the 280-kHz signal generator amplitude for a CRT trace of 5 volts peak-to-peak. There should be no noticeable distortion.</p> <p>j. Connect oscilloscope to 8414A VERTICAL output and note peak-to-peak amplitude.</p> <p>k. Connect oscilloscope to TEST CHANNEL OUTPUT connector on 8410A and note peak-to-peak waveform. Change 280-kHz signal generator frequency to 288.0 kHz and adjust waveform to the same peak-to-peak value as noted before frequency change by adjusting signal generator output attenuator.</p> <p>l. Connect oscilloscope to VERTICAL output connector of 8414A and note peak-to-peak amplitude. The waveform must be equal to or greater than 50% of the peak-to-peak amplitude noted in step j.</p> <p>m. Repeat steps j through l with oscilloscope connected to 8414A HORIZONTAL output connector instead of VERTICAL output.</p> <p>n. Adjust 270-290 kHz signal generator near 278 kHz and adjust amplitude to obtain a circle on the 8414A CRT.</p> <p>o. Adjust the power supply to -5 volts. Connect power supply -5V output to 8414A rear-panel MARKER input connector and -5V return to chassis ground. Connect and disconnect -5 volt supply several times. Intensity of CRT trace should brighten when -5 volts is applied.</p> <p>p. Disconnect -5 volts from MARKER input and connect it to BLANKING input. The trace should be blanked off.</p> |

| TEST | DESCRIPTION AND PROCEDURE   |
|------|---|
| 1    | <p><b>NOTE</b></p> <p>The procedures in Figure 4-2 require that all tests in Figure 4-1 be completed successfully.</p> <p><b>NOTE</b></p> <p>The time required to complete the performance test can be significantly reduced by testing across broader frequency ranges than those indicated on the 8410A frequency range selector. Most Network Analyzers can track input frequencies over more than one octave. Factors involved in achieving greater frequency coverage are sweep width and sweep time on the sweep oscillator and the settings of the analyzer. The suggested frequency bands are: 100 to 400 MHz, and 900 MHz to 2.0 GHz. To extend the lower frequency band it may be necessary to adjust the 8410A frequency range selector to the 1.0 to 2.0 GHz range.</p> |
|      | <p><b>SPECIFICATION TESTED</b></p> <p><b>DIRECTIVITY:</b> &gt; 36 dB (<math>T &gt; 0.016</math>) from 0.11 to 1.0 GHz &gt; 32 dB (<math>T &gt; 0.025</math>) from 1.0 to 2.0 GHz</p>  |
|      | <p><b>DESCRIPTION</b></p> <p>Directivity is tested using each internal coupler to measure the reflection coefficient of a standard termination. The reflection coefficient of the termination is cancelled out at single frequencies and the resultant is coupler directivity.</p>  |
|      | <p><b>TEST SETUP</b></p>  <p>Use standard link, HP Part No. 08745-20064.<br/>EQUIPMENT: Items 1, 7, 8, and 9, Table 4-1.</p>   |

Figure 4-2. Performance Test for 8410S-100 System (Sheet 1 of 7)

Figure 4-2. Performance Test for 8410S-100 System. (Sheet 2 of 7)

| TEST         | DESCRIPTION AND PROCEDURE  |
|--------------|--|
| 1<br>(Contd) | <p style="text-align: center;"><u>PROCEDURE</u></p> <p>a. Connect equipment as shown in test setup.</p> <p>b. Calibrate the 8414A display as follows:</p> <p>(1) Connect APC-7 short to 8745A Port A and depress pushbuttons A and S11.</p> <p>(2) Set signal source for automatic sweep.</p> <p style="text-align: center;">NOTE</p> <p>Most network analyzers will phase lock over more than one octave. To cover the entire operating range of the 8745A in a minimum number of frequency segments, set the signal source end frequencies to cover the broadest segment of the 0.1 to 2.0 GHz range to which the network analyzer will phase lock.</p> <p>(3) Adjust the network analyzer and signal source controls for best phase lock over the frequency band selected.</p> <p>(4) Push and hold 8414A BEAM CTR control and adjust HORIZ POS and VERT POS controls to place dot in the center of the polar display.</p> <p>c. Remove APC-7 short and replace with 50-ohm termination.</p> <p>d. Increase 8410A TEST CHANNEL GAIN by 32 dB for 1.0 to 2.0 GHz. This changes the full-scale reflection calibration from 1.0 to 0.025 (directivity of 32 dB) at the outer circle. For 0.1 to 1.0 GHz, increase the TEST CHANNEL GAIN by 36 dB to calibrate the outer circle for a reflection coefficient of 0.016 (directivity of 36 dB).</p> <p style="text-align: center;">NOTE</p> <p>The 8414A display now shows the combination of coupler directivity and reflection coefficient of the 50-ohm termination.</p> <p>e. The 8414A trace of directivity should be within the outer circle. If the trace is within the outer circle, the coupler directivity meets specifications. If the trace is outside of the outer circle, the coupler directivity must be separated from the reflection coefficient vector of the 50-ohm termination to determine if coupler directivity is out of specifications. This is accomplished as follows:</p> <p>(1) Set the signal source for single-frequency (CW) operation and select the frequency which corresponds to the point of greatest reflection on the 8414A display (the point farthest outside the outer circle).</p> <p style="text-align: center;">NOTE</p> <p>In the range of 1 to 2 GHz, a sliding load may be connected in place of the low-reflection 50-ohm load to resolve the directivity vector. For frequencies below 1 GHz, two or more sections of air line are used between the 8745A and load to phase the load reflection vector.</p> <p>(2) Phase the load reflection vector either by adjusting the sliding load or by inserting sections of air line between the 50-ohm load and the 8745A. Use a grease pencil to mark the location on the 8414A display of the circle traced when the sliding load is varied. If sections of air line are used to phase the load reflection vector, obtain a minimum of four points on the 8414A display by connecting different combinations of air lines and mark the points with a grease pencil. Draw a circle connecting the four dots. Variations from a circle are due to reflection variations of the air line. The center of this circle is the tip of the directivity vector. The magnitude at the center of</p> |

| TEST | DESCRIPTION AND PROCEDURE | 1<br>(Contd)  | PROCEDURE  | 2 | SPECIFICATION TESTED   | DESCRIPTION       | TEST SETUP   |
|------|---------------------------|---|--|---|--|-------------------|--|
|      |                           | <p>f. Repeat steps b through e for other frequency segments as necessary to cover the range of 0.1 to 2.0 GHz.</p> <p>g. To check the directivity of the other coupler in the 8745A, connect an APC-7 short to 8745A port B, depress pushbuttons B and S11, and repeat steps b (2) through f.</p> | <p>the circle should not exceed 0.016 from 0.1 to 1.0 GHz or 0.025 from 1.0 to 2.0 GHz (the outer circle limit).</p> <p>&lt; 0.11 (&lt; 1.25 VSWR), 100-200 MHz.<br/>&gt; 0.09 (&lt; 1.20 VSWR), 200-2000 MHz.</p> |   | <p>Input (test) port VSWR is tested using the internal coupler associated with the other port in a reflectometer setup canceling, if necessary, coupler directivity and other reflections at single frequencies.</p> | <p>TEST SETUP</p> | <p>Figure 4-2. Performance Test for 8410S-100 System (Sheet 3 of 7)</p> <p>*Use long link, HP Part No. 11604-20021.<br/>EQUIPMENT: Items 1 and 8, Table 4-1.</p> |

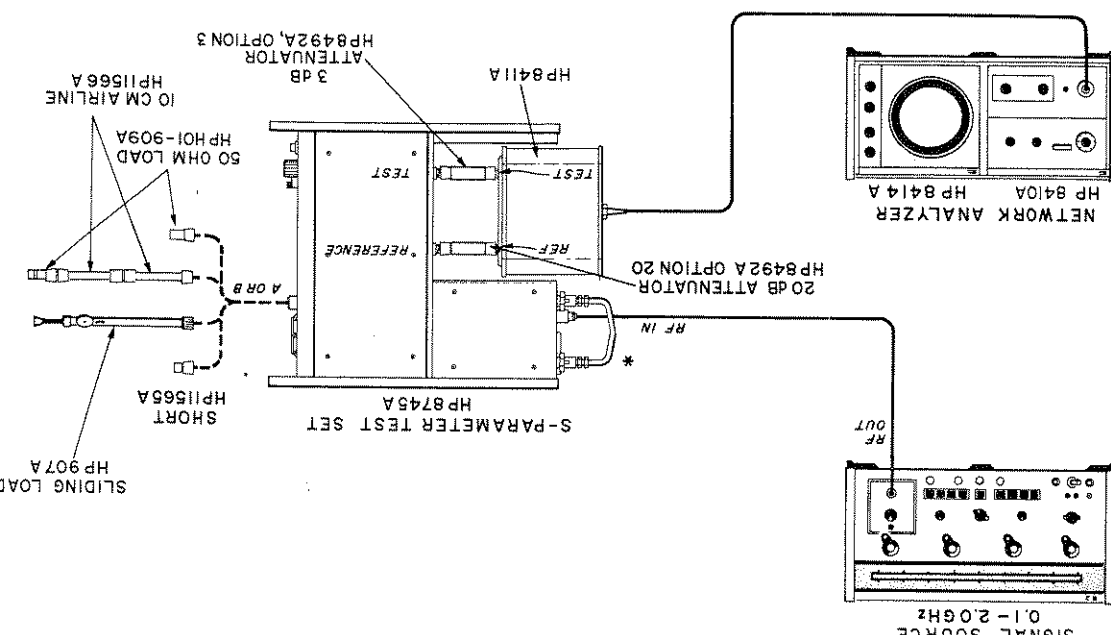
Figure 4-2. Performance Test for 8410S-100 System (Sheet 4 of 7)

| TEST                      | 2<br>(Cont)   |
|---------------------------|---|
| DESCRIPTION AND PROCEDURE | <p style="text-align: center;"><u>PROCEDURE</u></p> <p>a. Connect equipment as shown in test setup.</p> <p>b. Calibrate the 8414A display as follows:</p> <p>(1) Connect APC-7 short to port A arm of universal extension and depress pushbuttons A and S11.</p> <p>(2) Set signal source for automatic sweep.</p> <p style="text-align: center;">NOTE</p> <p>Most network analyzers will phase lock over more than one octave. To cover the entire operating range of the 8745A in a minimum number of frequency segments, set the signal source end frequencies to cover the broadest segment of the 0.1 to 2.0 GHz range to which the network analyzer will phase lock.</p> <p>(3) Adjust the network analyzer and signal source controls for best phase lock over frequency band selected. Adjust signal source for 8410A REF CHANNEL LEVEL meter indication at top (right) edge of OPERATE range.</p> <p>(4) Push and hold 8414A BEAM CTR control and adjust HORIZ POS and VERT POS controls to place dot in the center of the polar display.</p> <p>(5) Adjust the 8410A TEST CHANNEL GAIN and AMPL VERNIER controls for a trace on the outer circle of the CRT graticule.</p> <p>c. Remove the APC-7 short and connect the two arms of the universal extension together (8745A port A connected to port B).</p> <p>d. Increase 8410A TEST CHANNEL GAIN by 19 dB for 0.1 to 0.2 GHz. This changes the full-scale reflection calibration from 1.0 to 0.11 at the outer circle. For 0.2 to 2.0 GHz, increase the TEST CHANNEL GAIN by 21 dB to calibrate the outer circle for reflection coefficient of 0.09.</p> <p>e. The 8414A trace of reflection coefficient should be within the outer circle. If the trace is outside of the outer circle, the reflection coefficient of the input port must be separated from the coupler directivity to determine if the input port reflection coefficient is within specification. This is accomplished as follows:</p> <p>(1) Set the signal source for single frequency (CW) operation and select the frequency which corresponds to the point of greatest reflection on the 8414A display (the point farthest outside the outer circle).</p> <p>(2) Terminate the main line of the reflectometer with a low reflection 50-ohm load HP H01-909A. When checking the input reflection of port A, connect the load to port A arm of universal extension and when checking port B, connect the load to port B arm.</p> <p>(3) Without depressing the BEAM CTR, adjust 8414A HORIZ POS and VERT POS controls to place the dot at the CRT center.</p> <p>(4) Disconnect the 50-ohm load. The 8414A display is now the input reflection coefficient only. The directivity has been cancelled and the only ambiguity is due to the small reflection coefficient of the 50-ohm load. (The H01-909A has a maximum reflection coefficient of 0.005 or 50-dB return loss.) If the dot is within the outer circle of the graticule, the input port meets specifications at that frequency.</p> <p>f. To check the reflection coefficient of the other input port, connect short to port B arm of universal extension, depress 8745A pushbuttons B and S11, and repeat steps b (2) through e.</p> |



| TEST         | DESCRIPTION AND PROCEDURE  | PROCEDURE   | DESCRIPTION   | TEST SETUP  |
|--------------|--|---|---|---|
| 2<br>(Contd) | <p>g. Repeat steps b through f for other frequency segments as necessary to cover the range of 0.1 to 2.0 GHz.</p> | <p>SOURCE REFLECTION COEFFICIENT: <math>&lt; 0.09</math> (<math>&lt; 1.2</math> VSWR), 0.11 - 2.0 GHz.</p>  | <p>Source reflection coefficient is tested by measuring the change in magnitude of a maximum reflection when the phase of the reflected signal is varied.</p> | <p>The diagram illustrates the test setup. A Signal Source (0.11-2.0 GHz) provides an RF signal to the REFERENCE port of an S-Parameter Test Set (HP 8745A). The TEST port of the test set is connected to an HP 8411A Network Analyzer. A SHORT is connected to the REFERENCE port. The Network Analyzer's output is connected to a Dual Trace Oscilloscope (50 mV/Div) for monitoring. Labels include: SIGNAL SOURCE 0.11-2.0 GHz, RF IN, RF OUT, SWEEP, S-PARAMETER TEST SET HP 8745A, REFERENCE, TEST, HP 8411A, NETWORK ANALYZER HP 8410A HP 8413A, AMPLITUDE 50 mV/Div, DUAL TRACE OSCILLOSCOPE, VERT INPUT, and HORIZ INPUT.</p> |
| 3            | <p>SOURCE REFLECTION COEFFICIENT: <math>&lt; 0.09</math> (<math>&lt; 1.2</math> VSWR), 0.11 - 2.0 GHz.</p>         | <p>Source reflection coefficient is tested by measuring the change in magnitude of a maximum reflection when the phase of the reflected signal is varied.</p> | <p>Source reflection coefficient is tested by measuring the change in magnitude of a maximum reflection when the phase of the reflected signal is varied.</p> | <p>EQUIPMENT: Items 1 and 4, Table 4-1.</p>   |

Figure 4-2. Performance Test for 8410S-100 System. (Sheet 5 of 7)

Figure 4-2. Performance Test for 8410S-100 System (Sheet 6 of 7)

| TEST         | DESCRIPTION AND PROCEDURE  |
|--------------|--|
| 3<br>(Contd) | <p style="text-align: center;"><u>PROCEDURE</u></p> <p>a. Connect equipment as shown in test setup.</p> <p>b. Connect APC-7 short to 8745A port A and depress pushbuttons A and S11.</p> <p>c. Set signal source for automatic sweep.</p> <p style="text-align: center;">NOTE</p> <p>Most network analyzers will phase lock over more than one octave. To cover the entire operating range of the 8745A in a minimum number of frequency segments, set the signal source end frequencies to cover the broadest segment of the 0.1 to 2.0 GHz range to which the network analyzer will phase lock.</p> <p>d. Adjust the network analyzer frequency range selector and sweep stability control, the signal source sweep time and sweep width, and the oscilloscope vertical and horizontal positioning controls to display the amplitude output of the 8413A.</p> <p>e. Set the oscilloscope vertical sensitivity to display 0.01 V/cm (0.2 dB/cm).</p> <p>f. Draw the oscilloscope trace on the face of the CRT with a grease pencil.</p> <p>g. Remove the APC-7 short and draw the trace of the open circuit on the face of the CRT.</p> <p>h. The maximum deviation between traces should not exceed 1.6 dB, indicating a VSWR &lt; 1.2.</p> <p style="text-align: center;"><math>VSWR = \log^{-1} (0.05 \times \text{deviation between traces in dB})</math></p> <p>i. Repeat steps b through h for other frequency segments as necessary to cover the range of 0.1 to 2.0 GHz.</p> <p>j. To check the source match of port B, connect APC-7 short to 8745A port B, depress pushbuttons B and S11, and repeat steps f through h for each frequency segment to cover the range of 0.1 to 2.0 GHz.</p> |
| 4            | <p style="text-align: center;"><u>SPECIFICATION TESTED</u></p> <p>CHANNEL ISOLATION: Greater than 65 dB, 0.11 to 2.0 GHz.</p> <p style="text-align: center;"><u>TEST DESCRIPTION</u></p> <p>The 278-kHz test channel signal is monitored by an ac voltmeter with 200-Hz bandwidth. This rejects incoming noise and indicates only the test channel signal level. After a reference level is established at the ac voltmeter, the RF signal to the 8411A test channel is disconnected, and the input is terminated with a 50-ohm load. With the RF signal applied only to the reference channel, any signal present in the test channel is due to signal leakage between channels. Isolation between channels is calculated taking the signal level below zero indicated on the ac voltmeter plus the test channel gain added at the 8410A.</p>   |

TEST

DESCRIPTION AND PROCEDURE

4  
(Contd)

TEST SETUP

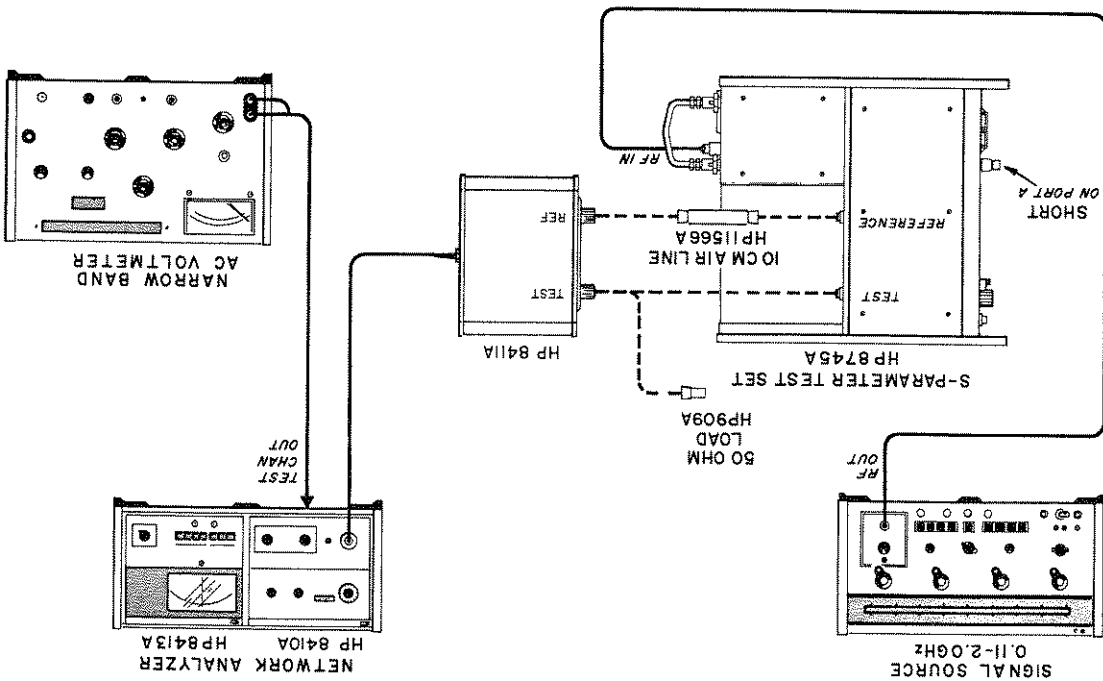

EQUIPMENT: Items 1, 5, 7, and 8, Table 4-1.

PROCEDURE

- a. Change equipment test setup as shown above. Connect 8411A to 8745A without the air line. Depress 8745A pushbuttons A and S11.
- b. Check for phase-locked condition in the 8410A as follows:
  - (1) Set signal source for single-frequency CW operation and adjust output for a REF CHANNEL LEVEL meter indication at the right edge of the OPERATE range.
  - (2) Depress the 8413A PHASE 180 degree pushbutton. Adjust the 8410A PHASE VERNIER control: the 8413A meter indication should change smoothly, indicating phase lock in the 8410A.
- c. Set 8410A TEST CHANNEL GAIN controls to zero. Adjust ac voltmeter for maximum output at 278 kHz, select automatic frequency control mode, and select 200-Hz bandwidth. Adjust 8410A AMPL VERNIER control and up to 4 dB on the TEST CHANNEL GAIN control for zero dB ac voltmeter indication on the meter range selected.
- d. Disconnect 8411A from 8745A and connect 50-ohm termination to 8411A TEST input. Connect 8411A REFERENCE port to 8745A with 10-cm air line.
- e. Increase the 8410A TEST CHANNEL GAIN control setting by 65 dB. The indication on the ac voltmeter should be zero or lower on the meter range selected.

Figure 4-2. Performance Test for 8410S-100 System (Sheet 7 of 7)

Figure 4-3. Performance Tests for 8410S-200 System (Sheet 1 of 6)

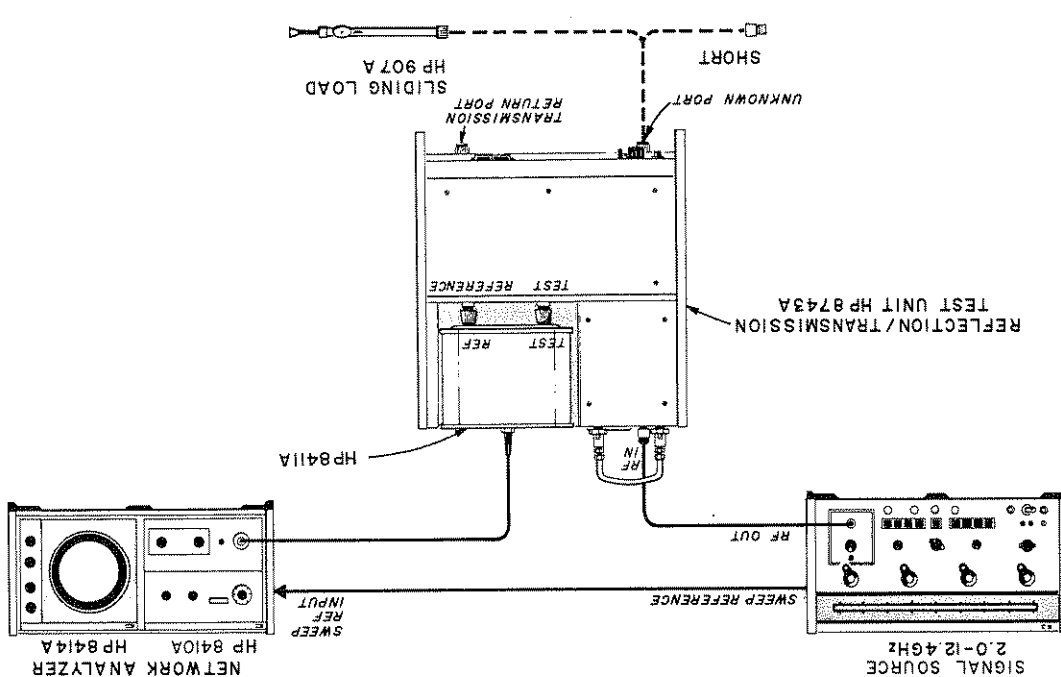
| TEST | DESCRIPTION AND PROCEDURE   |
|------|---|
| 1    | <p style="text-align: center;">NOTE</p> <p>The procedures in Figure 4-3 require that all tests in Figure 4-1 be completed successfully.</p>   |
|      | <p style="text-align: center;"><u>SPECIFICATION TESTED</u></p> <p>DIRECTIVITY: 30 dB or greater.</p>  |
|      | <p style="text-align: center;"><u>DESCRIPTION</u></p> <p>Directivity is measured by sweeping octave bands, using a sliding load. If the average signal due to the combination of directivity of the coupler and reflection of the sliding load is greater than the directivity specification the directivity value may be isolated from the load reflection at single frequencies by phasing the reflection vector with the sliding load.</p> |
|      | <p style="text-align: center;"><u>TEST SETUP</u></p>  <p style="text-align: right;">EQUIPMENT: Items 1 and 9, Table 4-1.</p>   |

| TEST         | DESCRIPTION AND PROCEDURE  |
|--------------|--|
| 1<br>(Contd) | <p align="center"><u>PROCEDURE</u></p> <p>a. Connect equipment as shown in setup above.</p> <p>b. Connect the coaxial short to the 8743A UNKNOWN port and depress the REFL pushbutton.</p> <p>c. Set the sweep oscillator to automatic sweep. Adjust the sweep oscillator and network analyzer controls to phase lock the network analyzer over the segment of the 8743A frequency range covered by the sweep oscillator. Adjust sweep oscillator for an indication on the 8410A REF CHANNEL LEVEL meter to the upper edge of the OPERATE range.</p> <p>d. Push and hold the 8414A BEAM CTR pushbutton and adjust the centering controls to place the dot in the center of the polar display.</p> <p>e. Adjust the REFERENCE PLANE EXTENSION to collapse the trace to a dot or smallest cluster.</p> <p>f. Adjust the 8410A TEST CHANNEL GAIN and AMPLITUDE VERNIER controls to place the dot or the center of the cluster at the outer circle.</p> <p>g. Remove the coaxial short and replace with the sliding load.</p> <p>h. Increase the 8410A test channel gain by 30 dB. Phase the sliding load, noting the CRT display. The average of this display must be inside the outer circle.</p> <p>i. If the swept-display cannot be resolved satisfactorily, make single-frequency measurements as follows:</p> <p>(1) Set the sweep oscillator to single-frequency operation. Select the frequency which corresponds to the point of greatest reflection on the 8414A display.</p> <p>(2) Adjust the 8414A centering controls, while phasing the load, until the circle rotates about the center of the CRT. (See Figure 3-8).</p> <p>(3) Depress the 8414A beam center pushbutton. The dot must be inside the outer circle.</p> <p>j. Repeat steps b through i for other frequency segments as necessary to cover the range of 2.0 to 12.4 GHz.</p> |
| 2            | <p align="center"><u>SPECIFICATION TESTED</u></p> <p>TERMINATION REFLECTION COEFFICIENT: <math>&lt; 0.09</math> (<math>&lt; 1.2</math> VSWR), 2 to 8 GHz;<br/> <math>&gt; 0.13</math> (<math>&lt; 1.3</math> VSWR), 8 to 12.4 GHz.</p>   |
|              | <p align="center"><u>DESCRIPTION</u></p> <p>The signal source RF output is leveled to provide a constant-amplitude signal to the swept slotted line. The swept slotted line resolves out the reflection coefficient of the TRANSMISSION RETURN port. The reflection measurement includes the contributions made by the 8411A input circuit, the flexible arm, and the 10-dB attenuator.</p>  |

Figure 4-3. Performance Tests for 8410S-200 System. (Sheet 2 of 6)

Figure 4-3. Performance Test for 8410S-200 System (Sheet 3 of 6)

| TEST                | DESCRIPTION AND PROCEDURE                              | TEST SETUP  | PROCEDURE |
|---------------------|--|---|-----------|
| <p>2<br/>(Cont)</p> | <p><b>EQUIPMENT:</b> Items 1, 3, and 4, Table 4-1.</p> | <p>a. Connect equipment as shown in setup above.</p> <p>b. Either use signal source internal leveling or level the sweep as follows. Connect the oscilloscope vertical input through a BNC tee to the leveling probe output of the HP 448A. Adjust the signal source RF power output to obtain a 25 mV indication on oscilloscope. Adjust the leveling probe into the HP 448A until a flat response is obtained on the oscilloscope. Tighten the probe in place.</p> <p>c. Reconnect vertical input of oscilloscope to slotted line probe. Adjust depth of slotted line probe to get 5 mV output as displayed on oscilloscope. Do not insert probe far enough to touch center conductor or diode may be burned out.</p> <p>d. Press 8743A REFLECT pushbutton. Move slotted-line carriage to obtain a trace on the oscilloscope similar to Figure 4-4. Select spot of maximum trace width and calculate:</p> $SWR = \frac{E_{max}}{E_{min}}$ |           |

| TEST         | DESCRIPTION AND PROCEDURE   |
|--------------|---|
| 2<br>(Contd) | <p><u>PROCEDURE</u></p> <p>SWR must not be greater than 1.2 in range of 2 to 8 GHz and greater than 1.3 in range of 8 to 12.4 GHz.</p> <p>e. Press 8743A TRANS pushbutton. Move slotted-line carriage and observe trace on oscilloscope. Select spot of maximum trace width and calculate:</p> $SWR = \frac{E_{max}}{E_{min}}$ <p>SWR must not be greater than 1.2 in range of 2 to 8 GHz and greater than 1.3 in range of 8 to 12.4 GHz.</p> |
| 3            | <p><u>SPECIFICATION TESTED</u></p> <p>SOURCE REFLECTION COEFFICIENT: &lt; 0.09 (&lt; 1.2 VSWR), 2-8 GHz,<br/>&lt; 0.13 (&lt; 1.3 VSWR), 8-12.4 GHz</p> <p><u>DESCRIPTION</u></p> <p>Source reflection coefficient is tested by measuring the change in magnitude of a maximum reflection when the phase of the reflected signal is varied.</p>  |
|              | <p><u>TEST SETUP</u></p>  <p><u>EQUIPMENT: Items 1 and 4, Table 4-1.</u></p>   |

Figure 4-3. Performance Test for 8410S-200 System (Sheet 4 of 6)

Figure 4-3. Performance Test for 8410S - 200 System (Sheet 5 of 6)

| TEST         | DESCRIPTION   |
|--------------|---|
| 3<br>(Contd) | <p style="text-align: center;"><u>PROCEDURE</u></p> <p>a. Connect equipment as shown in test setup.</p> <p>b. Connect APC-7 short to 8743A UNKNOWN port and depress REF.L pushbutton.</p> <p>c. Set signal source to automatic sweep.</p> <p style="text-align: center;">NOTE</p> <p>Most network analyzers will phase lock over more than one octave. To cover the entire operating range of the 8743A in a minimum number of frequency segments, set the signal source end frequencies to cover the broadest segment of the 2 to 12.4 GHz range to which the network analyzer will phase lock.</p> <p>d. Adjust the network analyzer frequency range selector and sweep stability control, the signal source sweep time and sweep width, and the oscilloscope vertical and horizontal positioning controls to display the amplitude output of the 8413A.</p> <p>e. Set the oscilloscope vertical sensitivity to display 0.01 V/cm (0.2 dB/cm).</p> <p>f. Draw the oscilloscope trace on the face of the CRT with a grease pencil.</p> <p>g. Remove the APC-7 short and draw the trace of the open circuit on the face of the CRT.</p> <p>h. The maximum deviation between traces in the 2 to 8 GHz range should not exceed 1.6 dB, indicating a VSWR &lt; 1.2 and in the 8 to 12.4 GHz range the deviation should not exceed 2.3 dB, indicating a VSWR &lt; 1.3.</p> <p style="text-align: center;"><math>VSWR = \log^{-1} (0.05 \times \text{deviation between traces in dB})</math></p> <p>i. Repeat steps b through h for other frequency segments as necessary to cover the range of 2 to 12.4 GHz.</p> |
| 4            | <p style="text-align: center;"><u>SPECIFICATION TESTED</u></p> <p>CHANNEL ISOLATION: ≥65 dB, 2.0 to 6.0 GHz; ≥60 dB, 6 to 12.4 GHz.</p>   |
|              | <p style="text-align: center;"><u>TEST DESCRIPTION</u></p> <p>The 278-kHz test-channel signal is monitored by a narrow band ac voltmeter with 200-Hz bandwidth. This narrow bandwidth rejects incoming noise so that only the test channel signal level is indicated. After a reference level is established at the ac voltmeter, the RF signal to the 8411A test channel is disconnected, and the input is terminated with a 50-ohm load. With the RF signal applied only to the reference channel, any signal present in the test channel is due to signal leakage between channels. Isolation between channels is calculated taking the signal level below zero indicated on the ac voltmeter plus the test channel gain added at the 8410A.</p>   |

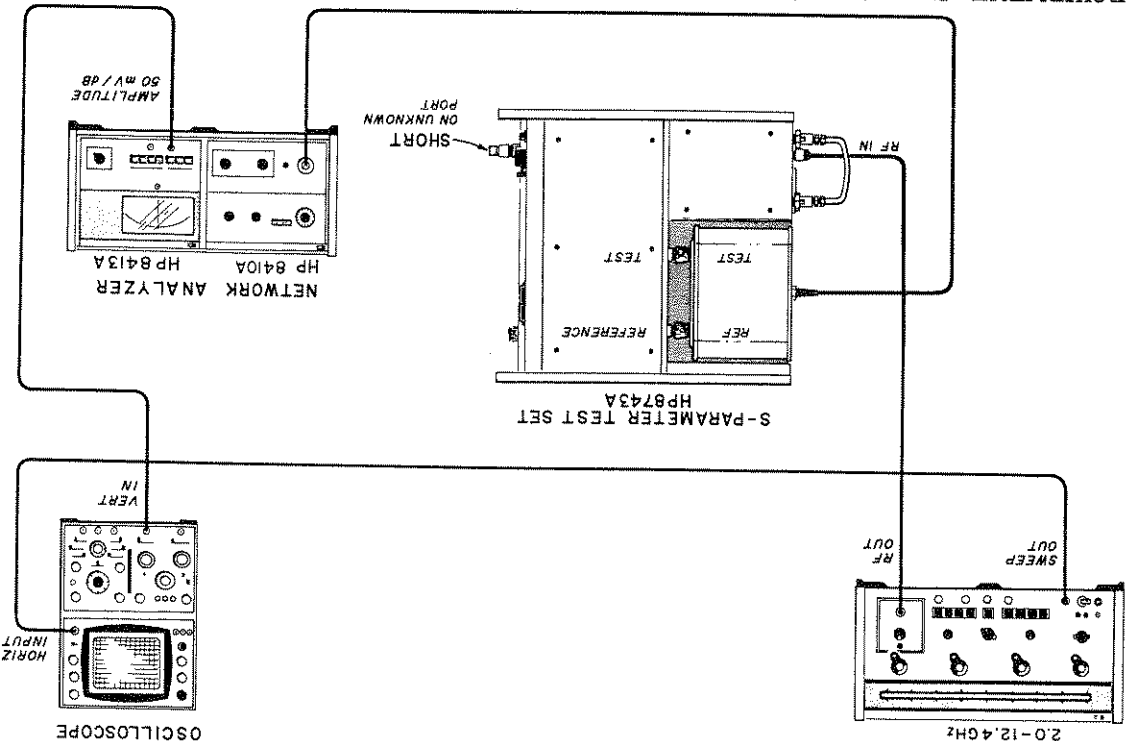

| TEST         | DESCRIPTION AND PROCEDURE  |
|--------------|--|
| 4<br>(Contd) | <p style="text-align: center;"><u>TEST SETUP</u></p> <p style="text-align: center;"><u>EQUIPMENT: Items 1, 5, 7, and 8, Table 4-1.</u></p>   |
|              | <p style="text-align: center;"><u>PROCEDURE</u></p> <ol style="list-style-type: none"> <li>a. Change equipment test setup as shown above. Connect 8411A to 8743A without the air line. Depress 8743A REFL pushbuttons.</li> <li>b. Check for phase-locked condition in the 8410A as follows:             <ol style="list-style-type: none"> <li>(1) Adjust the signal source for a REF CHANNEL LEVEL meter indication at the right edge of the OPERATE range.</li> <li>(2) Depress the 8413A PHASE 180 degree pushbutton. Adjust the 8410A PHASE VERNIER control; the 8413A meter indication should change smoothly, indicating phase lock in the 8410A.</li> </ol> </li> <li>c. Set 8410A TEST CHANNEL GAIN controls to zero. Adjust ac voltmeter for maximum output at 278 kHz, select automatic frequency control mode, and select 200 Hz bandwidth. Adjust 8410A AMPL VERNIER control and up to 4 dB on 1 dB/step TEST CHANNEL GAIN control for zero db ac voltmeter indication on the meter range selected.</li> <li>d. Disconnect 8411A from 8743A and connect 50-ohm termination to 8411A TEST input. Connect 8411A REFERENCE port to 8743A with 10 cm air line.</li> <li>e. Increase the 8410A TEST CHANNEL GAIN setting by 65 dB in the range of 2.0 to 6.0 GHz and 60 dB in the range of 6 to 12.4 GHz. The indication on the ac voltmeter should be zero or lower on the meter range selected.</li> </ol> |

Figure 4-3. Performance Test for 8410S-200 System (Sheet 6 of 6)

Figure 4-4. Typical Pattern of a Swept VSWR Measurement

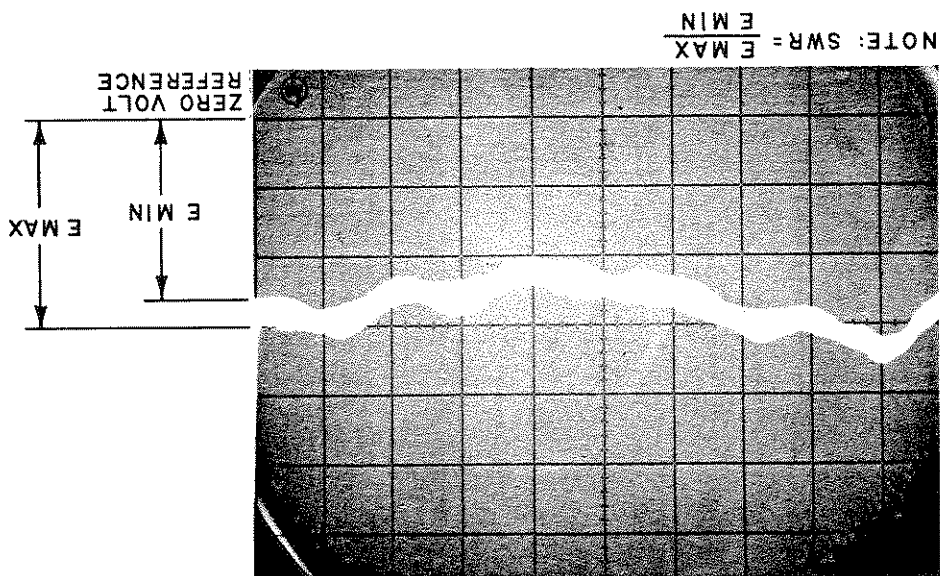

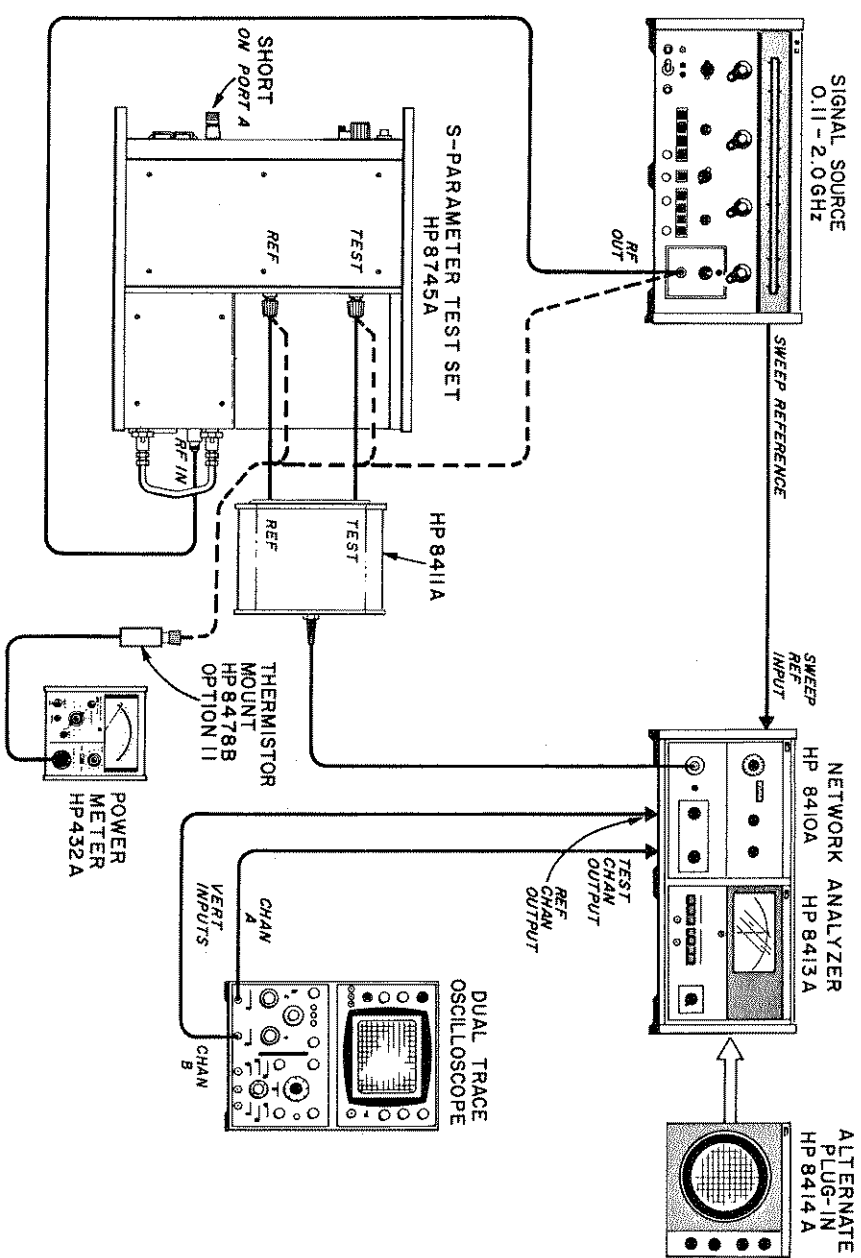
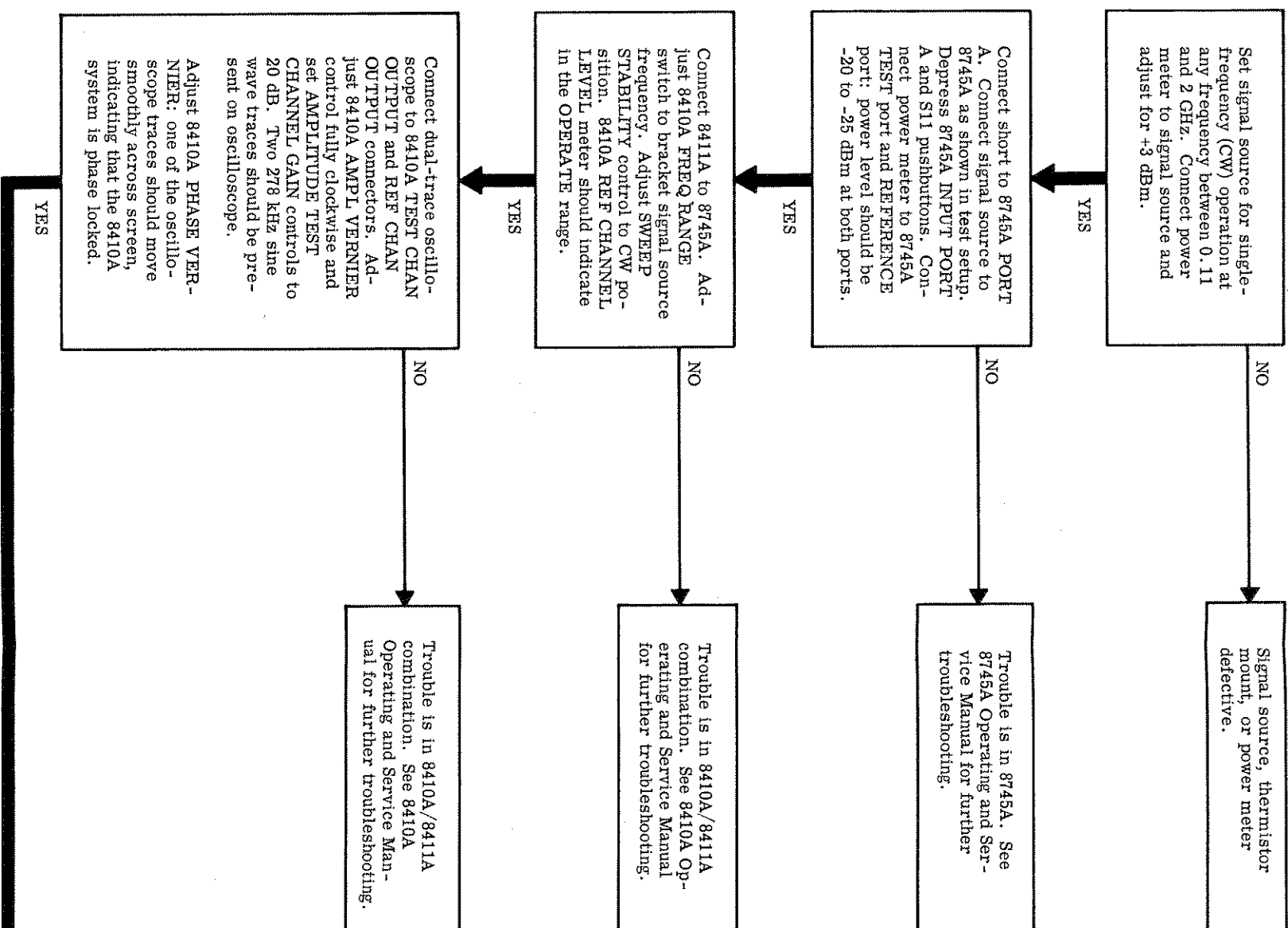

Figure 4-5. Test Setup for Model 8410S-100 and 8410S-300 Troubleshooting



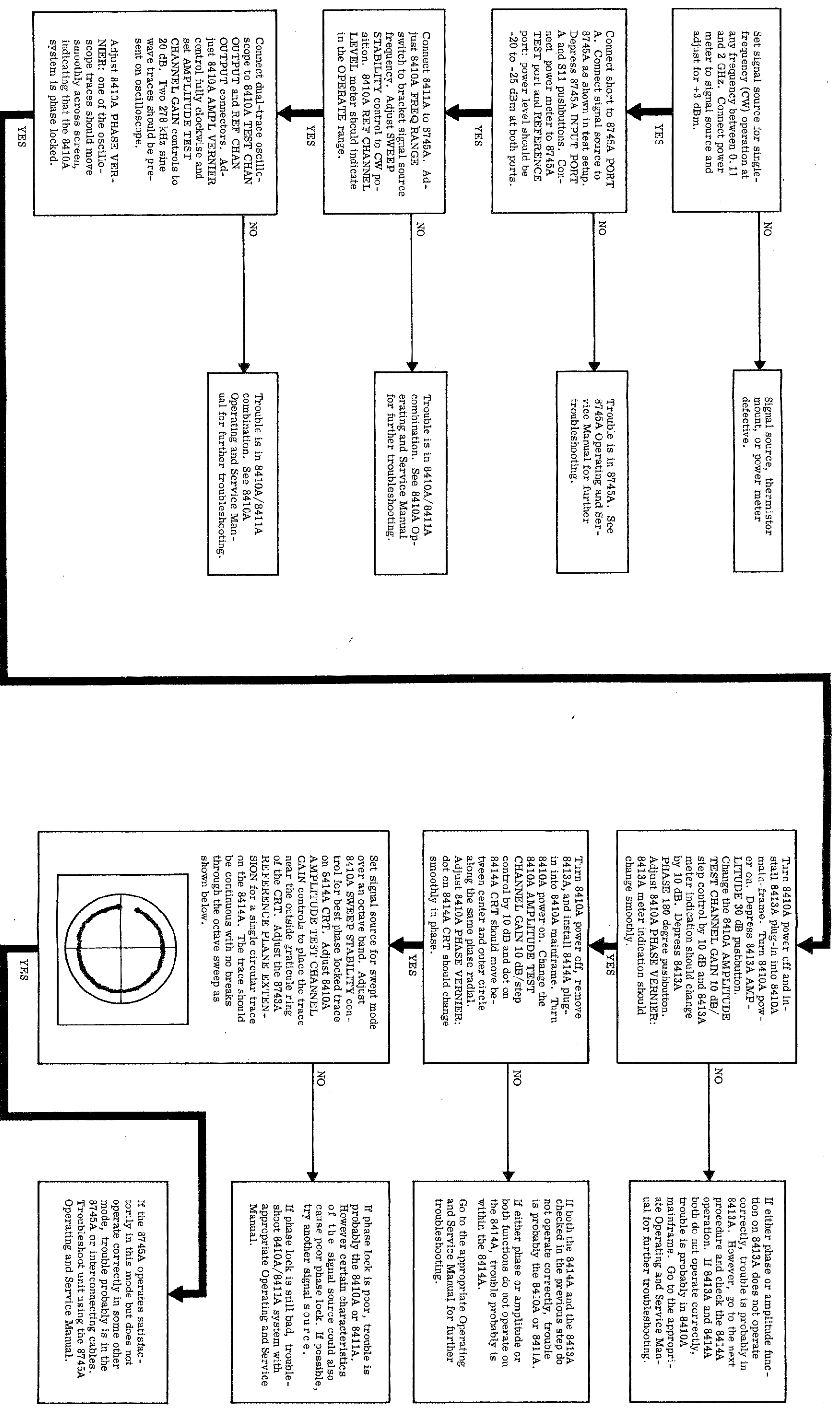

Figure 4-6. Model 8410S-100 and 8410S-300 System Troubleshooting Tree

▶ **MODEL 8410S-100 AND 8410S-300**  
**TROUBLESHOOTING, Figures 4-5 and 4-6**



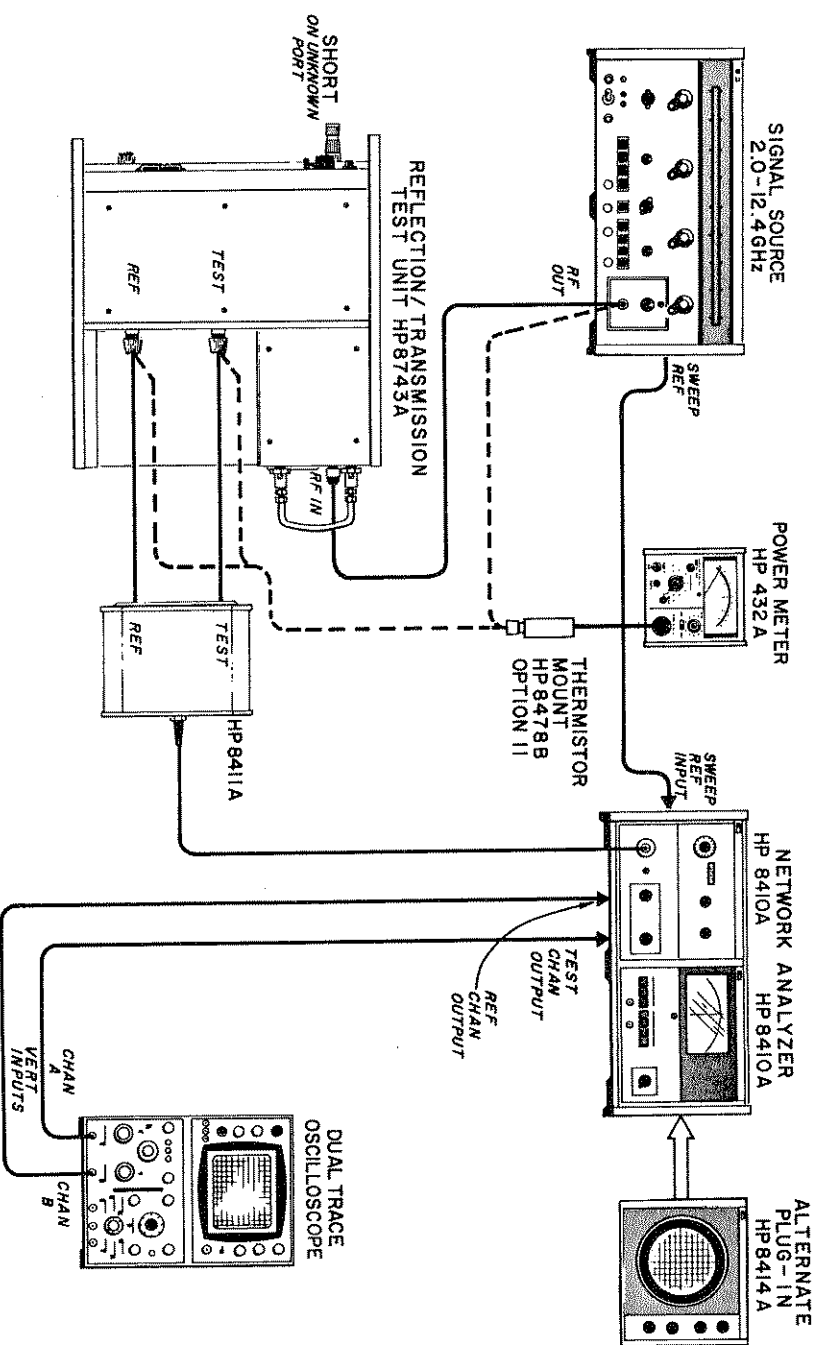
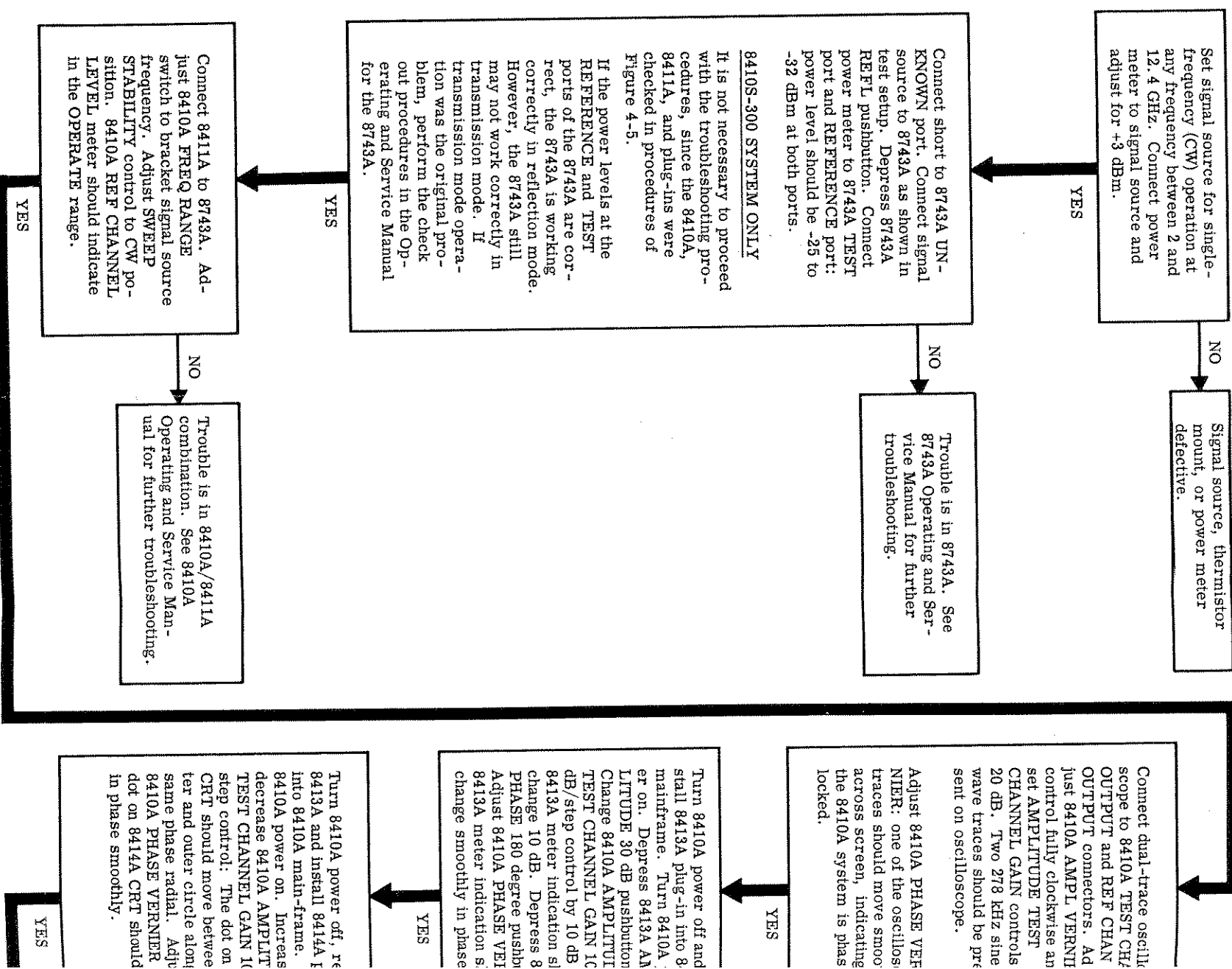

Figure 4-7. Test Setup for Model 8410S-200 and 8410S-300 Troubleshooting



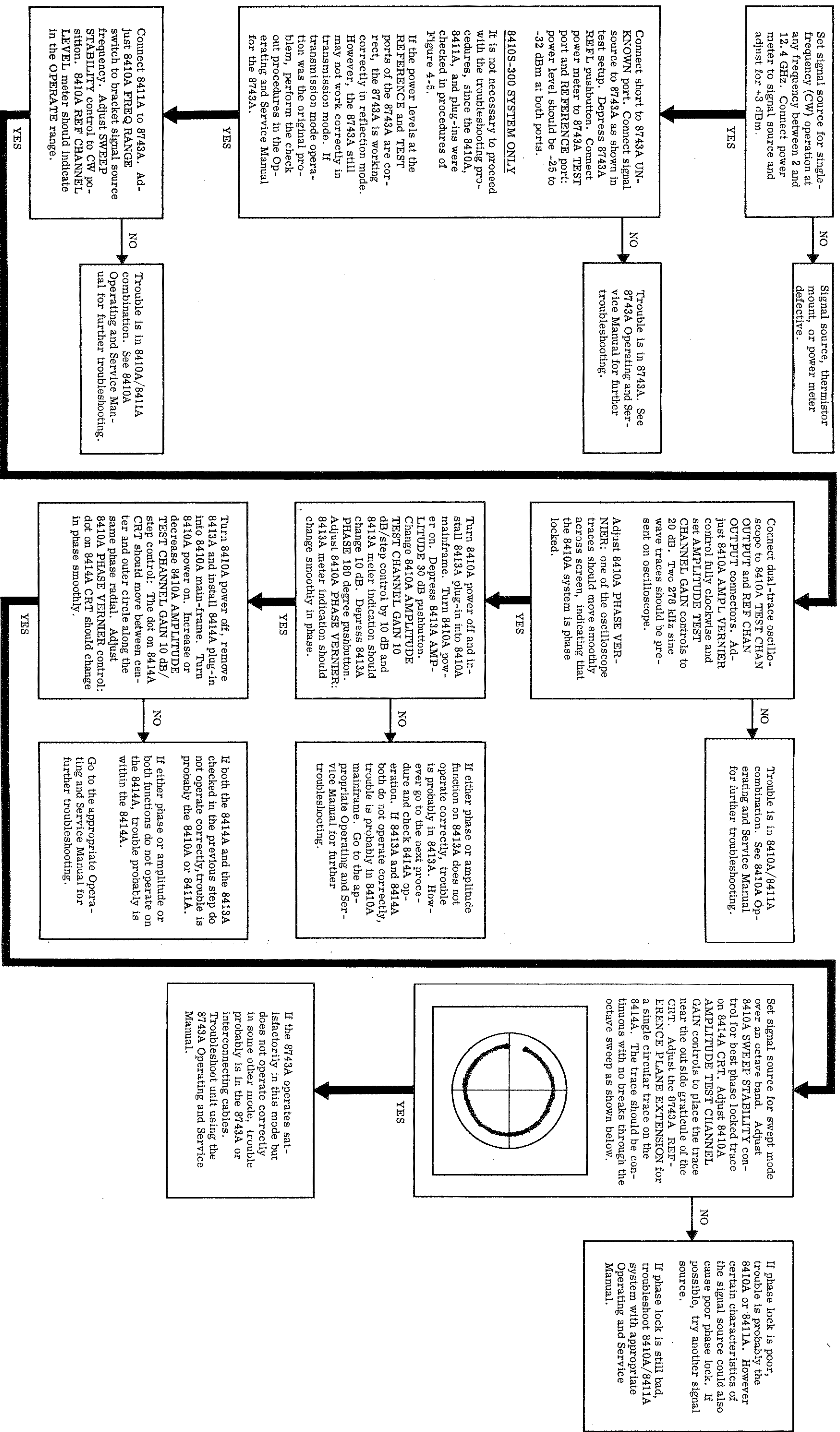

Figure 4-8. Model 8410S-200 and 8410S-300 System Troubleshooting Tree









