

HP 85713A

Digital Radio Measurements

Operating Guide



HP Part No. 85713-90001
Printed in USA Printed December 1989

Hewlett-Packard Software Product License Agreement and Limited Warranty

Important



Please carefully read this License Agreement before opening the media envelope or operating the equipment. Rights in the software are offered only on the condition that the Customer agrees to all terms and conditions of the License Agreement. Opening the media envelope or operating the equipment indicates your acceptance of these terms and conditions. If you do not agree to the License Agreement, you may return the unopened package for a full refund.

License Agreement

In return for payment of the applicable fee, Hewlett-Packard grants the Customer a license in the software, until terminated, subject to the following:

Use

- Customer may use the software on one spectrum-analyzer instrument.
- Customer may not reverse assemble or decompile the software.

Copies and Adaptations

- Customer may make copies or adaptations of the software:
 - For archival purposes, or
 - When copying or adaptation is an essential step in the use of the software with a computer so long as the copies and adaptations are used in no other manner.
- Customer has no other rights to copy unless they acquire an appropriate license to reproduce which is available from Hewlett-Packard for some software.
- Customer agrees that no warranty, free installation, or free training is provided by Hewlett-Packard for any copies or adaptations made by Customer.
- All copies and adaptations of the software must bear the copyright notices(s) contained in or on the original.

Ownership

- Customer agrees that they do not have any title or ownership of the software, other than ownership of the physical media.
- Customer acknowledges and agrees that the software is copyrighted and protected under the copyright laws.
- Customer acknowledges and agrees that the software may have been developed by a third party software supplier named in the copyright notice(s) included with the software, who shall be authorized to hold the Customer responsible for any copyright infringement or violation of this License Agreement.

Transfer of Rights in Software

- Customer may transfer rights in the software to a third party only as part of the transfer of all their rights and only if Customer obtains the prior agreement of the third party to be bound by the terms of this License Agreement.
- Upon such a transfer, Customer agrees that their rights in the software are terminated and that they will either destroy their copies and adaptations or deliver them to the third party.
- Transfer to a U.S. government department or agency or to a prime or lower tier contractor in connection with a U.S. government contract shall be made only upon their prior written agreement to terms required by Hewlett-Packard.

Sublicensing and Distribution

- Customer may not sublicense the software or distribute copies or adaptations of the software to the public in physical media or by telecommunication without the prior written consent of Hewlett-Packard.

Termination

- Hewlett-Packard may terminate this software license for failure to comply with any of these terms provided Hewlett-Packard has requested Customer to cure the failure and Customer has failed to do so within thirty (30) days of such notice.

Updates and Upgrades

- Customer agrees not to export or re-export the software or any copy or adaptation in violation of the U.S. Export Administration regulations or other applicable regulations.

Limited Warranty

Software

Hewlett-Packard warrants for a period of **90 days** from the date of purchase that the software product will execute its programming instructions when properly installed on the spectrum-analyzer instrument indicated on this package. Hewlett-Packard does not warrant that the operation of the software will be uninterrupted or error free. In the event that this software product fails to execute its programming instructions during the warranty period, customer's remedy shall be to return the measurement card ("media") to Hewlett-Packard for replacement. Should Hewlett-Packard be unable to replace the media within a reasonable amount of time, Customer's alternate remedy shall be a refund of the purchase price upon return of the product and all copies.

Media

Hewlett-Packard warrants the media upon which this product is recorded to be free from defects in materials and workmanship under normal use for a period of **90 days** from the date of purchase. In the event any media prove to be defective during the warranty period, Customer's remedy shall be to return the media to Hewlett-Packard for replacement. Should Hewlett-Packard be unable to replace the media within a reasonable amount of time, Customer's alternate remedy shall be a refund of the purchase price upon return of the product and all copies.

Notice of Warranty Claims

Customer must notify Hewlett-Packard in writing of any warranty claim not later than thirty (30) days after the expiration of the warranty period.

Limitation of Warranty

Hewlett-Packard makes no other express warranty, whether written or oral, with respect to this product. Any implied warranty of merchantability or fitness is limited to the **90 day** duration of this written warranty.

This warranty gives specific legal rights, and Customer may also have other rights which vary from state to state, or province to province.

Exclusive Remedies

The remedies provided above are Customer's sole and exclusive remedies. In no event shall Hewlett-Packard be liable for any direct, indirect, special, incidental, or consequential damages (including lost profit) whether based on warranty, contract, tort, or any other legal theory.

Warranty Service

Warranty service may be obtained from the nearest Hewlett-Packard sales office or other location indicated in the owner's manual or service booklet.

HP
11
12

How to Use This Manual

Chapter 1, “Introducing the Personality,” introduces you to the Digital Radio Measurement Personality and its features.

Chapter 2, “Installing the Program,” describes how to install, access, and delete the program.

Chapter 3, “Digital Radio Measurements,” shows you how to make measurements using the personality.

Chapter 4, “User-Defined Masks,” describes how to create your own user-defined masks. An example mask is included.

Chapter 5, “Softkey Reference,” defines each menu softkey in alphabetical order.

Note



If you have not installed or are not familiar with your spectrum analyzer, turn to “Installation and Preparation for Use” in the *HP 8590B/8592B Installation, Verification, and Operation Manual* or the *HP 8591A/8593A Installation, Verification, and Operation Manual*. It describes analyzer preparation and verification, and tells you what to do if something goes wrong. Also, it describes analyzer features and tells you how to make spectrum analyzer measurements. Consult this manual whenever you have a question about standard spectrum analyzer use.

Printing History

Each new edition of this manual incorporates all material updated since the previous edition. Change sheets may be issued between editions, allowing you to correct or insert information in the current edition.

The part number of this manual changes only when a new edition is published. Minor corrections or additions may be made as the manual is reprinted between editions.

Part Number 85713-90001

First Printing December 1989

Contents

1. Introducing the Personality	
Introduction	1-1
What Is a Mask?	1-3
Getting Started	1-3
Personality Features	1-4
Five Built-In Agency Masks	1-4
Eleven User-Created Masks	1-4
Mean Power Level Measurement	1-4
Compare to Mask (Relative or Absolute Level)	1-4
Record Transient Occurrence (Monitor Mode)	1-4
Frequency Response Measurement (Compare to Reference)	1-5
Create Mask at One Frequency, Use at Another	1-5
Print Hardcopy Output with Text	1-5
Manual Terms and Conventions	1-5
If Something Goes Wrong	1-6
Service Options	1-6
2. Installing the Personality	
Installation	2-1
Accessing the Personality	2-2
Exiting the Personality	2-3
Deleting the Personality	2-3
Deleting All Personalities	2-3
3. Digital Radio Measurements	
Selecting a Mask	3-1
Measurement Functions	3-3
EXTERNAL ATTEN	3-3
CENTER 99% BW	3-3
COMPARE TO MASK	3-4
MEAN PWR LEVEL	3-5
TRANSNT ANALYSIS	3-5
FREQ RESPONSE	3-6
Entering the Reference Response	3-7
Comparing the Responses	3-7

4. User-Defined Masks	
Mask Utility Functions	4-3
RECALL USER MSK	4-3
EDIT MASK	4-3
CREATE MASK	4-3
VW BLNK MASK	4-3
LIST MASK	4-3
LIST MASK SET	4-3
Save/Recall Mask Functions	4-4
SAVE MASK SET	4-4
RECALL MASK SET	4-4
Monitor Jack Mask	4-5
Creating a Mask	4-6
Recalling a Mask	4-11
Editing a Mask	4-12
Copying a Mask	4-13
5. Softkey Reference	
A. Digital Radio Measurements Personality Terms	
B. Agency Masks	
Definitions	B-1
4 GHz FCC Mask	B-2
6 GHz FCC Mask	B-3
11 GHz FCC Mask	B-4
13 GHz UK Mask	B-5
13 GHz FRG Mask	B-6
C. Menu Map	
Index	

Figures

1-1. The Main Menu	1-2
2-1. Inserting the Card	2-1
3-1. Agency Menu Selections	3-2
3-2. Main Menu Measurement Selections	3-3
3-3. External Attenuation Softkey Location	3-3
3-4. Display of Absolute Mask (Compare to Mask)	3-4
3-5. Display of Relative Mask (Compare to Mask)	3-4
3-6. Transient Analysis Display	3-5
3-7. Frequency Response Menus	3-6
3-8. Example of Reference Response Display	3-7
3-9. Compared Response	3-8
4-1. Utility and Save/Recall Mask Menus	4-2
4-2. Monitor Jack Example Mask	4-5
4-3. Sample Data Table for User-Created Mask	4-6
4-4. Display After the Last Breakpoint Data Entry	4-9
4-5. Sample of User-Created Mask	4-10
4-6. Recalled Mask Display	4-11
B-1. 4 GHz FCC Mask	B-2
B-2. 6 GHz FCC Mask	B-3
B-3. 11 GHz FCC Mask	B-4
B-4. 13 GHz UK Mask	B-5
B-5. 13 GHz FRG Mask	B-6
C-1. HP 85713A Menu Map	C-1

Introducing the Personality

This chapter introduces the HP 85713A Digital Radio Measurements Personality. It contains the following information.

Introduction	1-1
What Is a Mask?	1-3
Getting Started	1-3
Personality Features	1-4
Five Built-In Agency Masks	1-4
Eleven User-Created Masks	1-4
Mean Power Level Measurement	1-4
Compare to Mask (Relative or Absolute Level)	1-4
Record Transient Occurrence (Monitor Mode)	1-4
Frequency Response Measurement (Compare to Reference) ..	1-5
Create Mask at One Frequency, Use at Another	1-5
Print Hardcopy Output with Text	1-5
Manual Terms and Conventions	1-5
If Something Goes Wrong	1-6

Introduction

When installed in an HP 8593A series spectrum analyzer, the HP 85713A provides all the capabilities and functions of the standard analyzer with the addition of very specific digital radio measurement functions. The personality's main menu is displayed in two pages. See Figure 1-1.

Softkeys in the main menu's first page allow you to recall, save, create, and edit "masks". Softkeys in the second page perform measurements on the signal of interest.

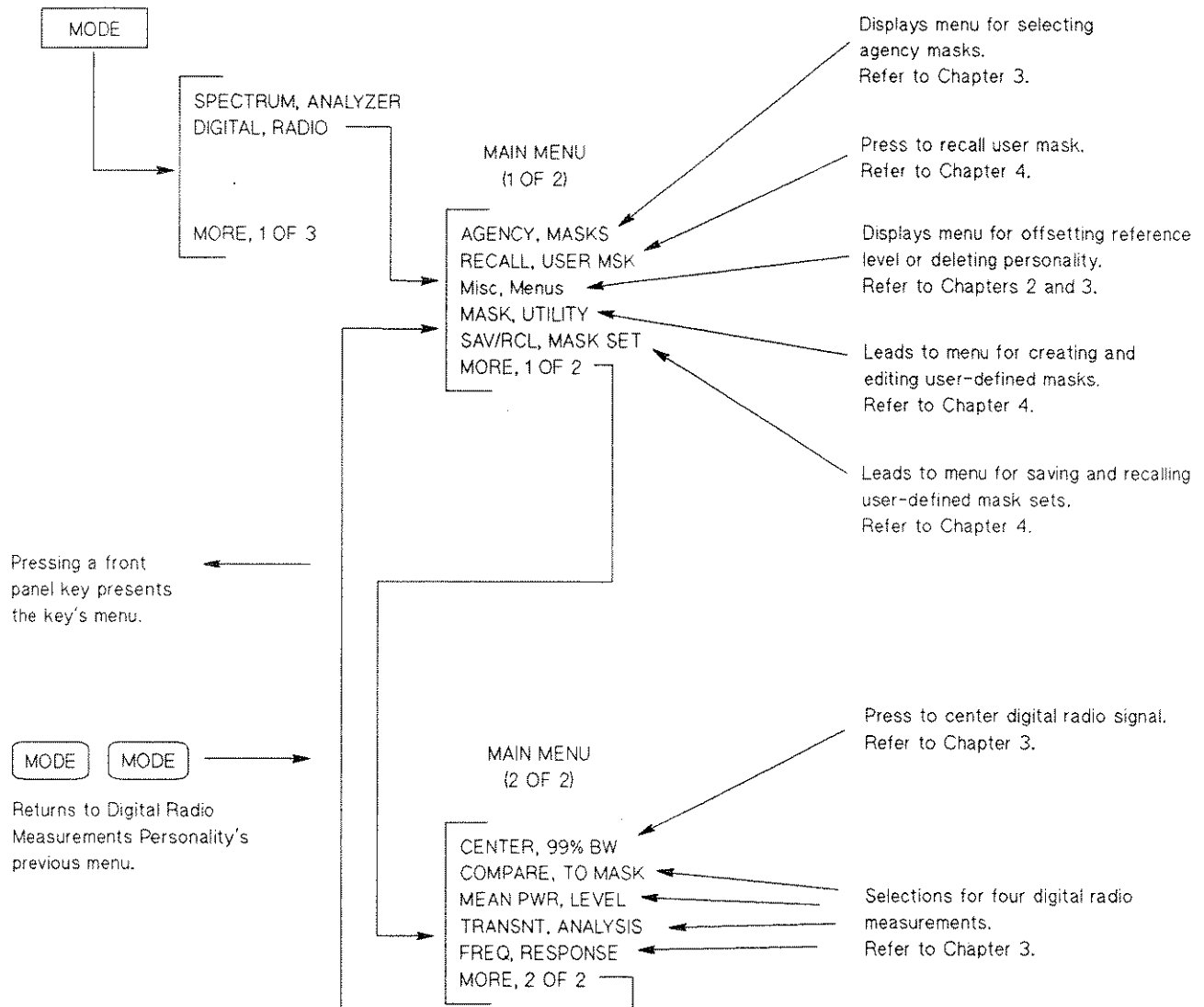

Figure 1-1. The Main Menu

What Is a Mask?

A mask is a graphical representation of the FCC (or other government agency) specifications for the transmitted spectrum of a digital radio system. A mask outlines the authorized bandwidth that must contain the modulated spectrum. The analyzer stores the mask in Trace C.

Note



During operation of the digital radio measurements personality, the softkey menus are blanked. When the analyzer is busy drawing a mask on the screen, the word COMPUTING is displayed. The softkey menu will be re-displayed on the screen when the measurement has been completed.

Getting Started

Refer to Chapter 2 to install the personality. After installation, use one of the following two methods to access the personality:

1. At any time press **MODE** and then **DIGITAL RADIO**.
 2. After leaving the digital radio personality menus (by using any standard spectrum analyzer function), press **MODE** **MODE**.
-

Note



Pressing front-panel keys while using the Digital Radio Measurements Personality causes the spectrum analyzer to activate that key and its menu. You can return to the previous digital radio menu by pressing the **MODE** key twice in succession.

Personality Features

This section lists the main features of the digital radio measurements personality.

Five Built-In Agency Masks

Five major agency masks are built in for ease of use in testing FCC, UK, or FRG digital radio specifications for band occupancy. Masks available are the 4 GHz, 6 GHz, and 11 GHz FCC masks used in the United States, the 13 GHz United Kingdom mask, and the West German 13 GHz FRG mask.

Eleven User-Created Masks

The HP 85713A can store up to 11 custom masks. Masks are entered, by the user, from the front panel and easily tailored to specific measurement needs. Masks may be either relative or absolute (the maximum power level is referenced to the peak of the unmodulated carrier power level).

Each mask may have as many as nine breakpoints on each side of its center frequency. These breakpoints, or test limits, are set when creating a mask by entering the desired frequency and amplitude. The frequency of a breakpoint can increase or remain the same. However the amplitude of a breakpoint can increase, decrease, or remain the same.

Mean Power Level Measurement

Makes automated power level measurements using the modulated spectrum of the digital radio signal. If the signal level is greater than the reference level, an additional 10 dB of attenuation is switched in, and the measurement is repeated automatically.

Compare to Mask (Relative or Absolute Level)

This measurement procedure first makes an automated mean power level measurement, then compares the result to the selected mask limits. After the measurement is complete, a marker indicates either the frequency where the least difference between mask and signal occurred (if the comparison met the mask limits) or the frequency where the most difference between mask and signal occurred (if the comparison failed).

Record Transient Occurrence (Monitor Mode)

The Transient Analysis Monitor Mode looks at the digital radio modulated signal and centers the signal on the 25 dB down point. The spectrum analyzer then is switched to zero span and its sweep time set to 30 seconds. At the end of each sweep a "peaks" command is executed, which looks for signal peaks (transients that occurred if the signal frequency shifted). The number of amplitude peaks that occurred during each sweep are recorded at the top of the spectrum analyzer's display.

Frequency shifts meeting *both* of the following requirements will be recorded as transients:

- shifts beyond the signal's 25 dB bandwidth.

- shifts causing an amplitude change of 5 dB or greater from the signal's -25 dB level.

Frequency Response Measurement (Compare to Reference)

This measurement allows the user to set up a digital signal as a reference on the spectrum analyzer's display with the desired frequency span and center frequency. After this initial setup is complete the reference trace is stored. The instrument may be carried to another site where the frequency response can be tested by comparison to the previously stored reference trace.

Create Mask at One Frequency, Use at Another

Masks that are created, then stored, may easily be recalled by answering the prompt:

ENTER # OF MASK <=11

Once a mask has been recalled by entering a mask number greater than zero but less than or equal to 11, it may be moved to a different center frequency simply by pressing **CENTER FREQ** and using the knob or keying in the new center frequency for the mask.

Print Hardcopy Output with Text

At the completion of a measurement, the user can press **PRINT RECORD**, which initiates a print dump of the screen data without an external controller. The screen remains frozen until the data transfer to the printer is complete.

Note



During operation of the digital radio measurements personality, the softkey menus are blanked. When the analyzer is busy drawing a mask on the screen, the word **COMPUTING** is displayed. The softkey menu will be redisplayed on the screen when the measurement has been completed.

Manual Terms and Conventions

Key

A boxed name in this typeface represents a key physically located on the instrument.

Softkey

A boxed word written in this typeface indicates a "softkey," a key whose label is determined by the instrument's firmware.

Display Text

Text printed in this typeface indicates text displayed on the analyzer's screen.

If Something Goes Wrong

This chapter tells you what to do if you have a problem. Your spectrum analyzer, with its digital radio measurement personality, is built to provide dependable service. It is unlikely you will experience a problem, but in the event something goes wrong, refer to the *HP 8593A Installation, Verification, and Operation Manual* (HP part number 08593-90001) and review "If Something Goes Wrong." It is very important that you complete all basic checks for the analyzer before calling Hewlett-Packard or returning the analyzer. This should avoid unnecessary repair work and waiting time. If the problem still is not resolved, call your nearest HP Sales and Service Office.

Service Options

If you want to service the analyzer yourself after the warranty expires, you can purchase a complete service manual that provides all necessary test and maintenance information. Refer to the description of options in the *HP 8593A Installation, Verification, and Operation Manual*.

Installing the Personality

Installation	2-1
Accessing the Personality	2-2
Exiting the Personality	2-3
Deleting the Personality	2-3
Deleting All Personalities	2-3

Installation

1. Locate the arrow printed on the Digital Radio Measurements Personality card's label.
2. Insert the card into the spectrum analyzer with its arrow matching the raised arrow on the bezel around the card-insertion slot. See Figure 2-1.

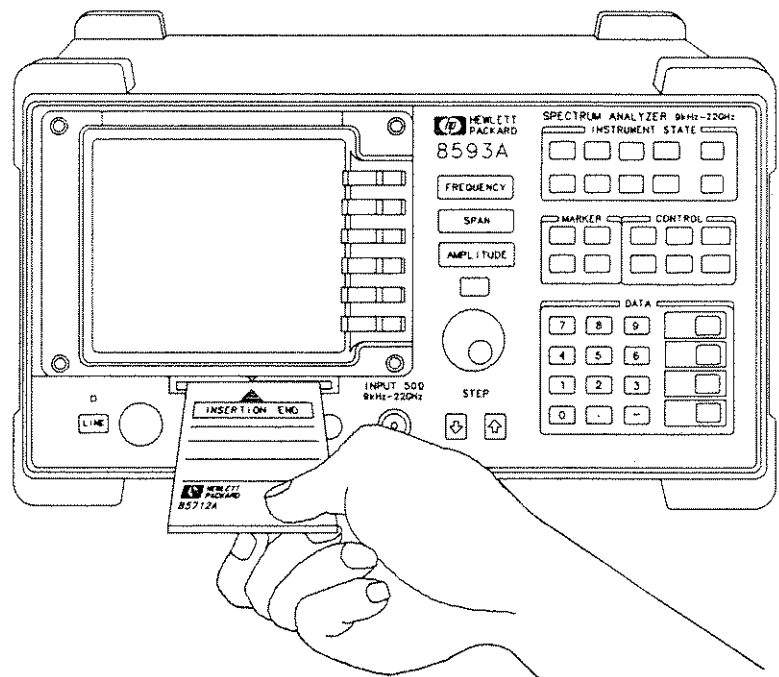

Figure 2-1. Inserting the Card

3. Press the card into the slot. When correctly inserted, about 19 mm (0.75 in) of the card extends from the slot.

4. Press **RECALL**.
5. Select the memory card by pressing **INTRNL CRD** to underline **CRD**.
6. Press **CATALOG CARD CATALOG ALL**.
7. Use the knob to highlight **dDIGRAD_1**, the digital radio measurements personality.
8. Press **LOAD FILE**. It takes approximately 60 seconds to load the file.
9. Press **MODE DIGITAL RADIO LOAD MASK SET**. This loads all the data for the agency masks included with the measurement personality.
10. The masks data and the digital radio measurements personality are now completely loaded and ready for use. To verify, press the following keys:
MODE DIGITAL RADIO AGENCY MASKS 6GHZ FCC MASK.
The 6 GHz FCC mask should appear, as illustrated in Appendix B, "Agency Masks."
11. Remove the card from the spectrum analyzer.

Accessing the Personality

After installing the personality, use one of the following two methods to access it:

1. At any time press **MODE** and then **DIGITAL RADIO**.
2. After leaving the digital radio personality menus (by using any standard spectrum analyzer function), press **MODE MODE**.

Note



Pressing front-panel keys while using the Digital Radio Measurements Personality causes the spectrum analyzer to activate that key and its menu. You can return to the previous digital radio menu by pressing the **MODE** key twice in succession.

The normal spectrum analyzer display can be restored at any time by pressing **MODE** and then **SPECTRUM ANALYZER**.

Exiting the Personality

You can exit from the personality at any time by pressing **MODE** **SPECTRUM ANALYZER**.

Deleting the Personality

To remove the personality, press the following keys from the main menu: **Misc Menu**, **DISPOSE MENU**, and **DISPOSE DGRD** **DISPOSE DGRD**. The personality is now purged from the spectrum analyzer's memory.

Deleting All Personalities

Caution



The following process purges all personalities from the spectrum analyzer's memory. If you have them on a memory card, the desired personalities can be reloaded using the procedure described above.

1. Press **CONFIG** **MORE 1 of 2**.
2. Press **DISPOSE USER MEM** two times.

All personalities have been purged from the spectrum analyzer's memory.

Digital Radio Measurements

To perform a digital radio measurement, you must do the following tasks:

1. Select an Agency or User-defined Mask
2. Select one of four measurements

This chapter describes four measurements and two functions available with the personality. The following topics are discussed:

Selecting a Mask	3-1
Measurement Functions	3-3
EXTERNAL ATTEN	3-3
CENTER 99% BW	3-3
COMPARE TO MASK	3-4
MEAN PWR LEVEL	3-5
TRANSNT ANALYSIS	3-5
FREQ RESPONSE	3-6
Entering the Reference Response	3-7
Comparing the Responses	3-7

Selecting a Mask

The Digital Radio Measurements Personality allows you to use one of five agency masks or one of 11 user-defined custom masks.

To create user-defined masks, refer to Chapter 4. Chapter 4 also documents the Monitor Jack Mask provided with the personality. This is an example mask that allows you to examine digital radio signals before the final power amplifier stage.

Figure 3-1 shows the Agency Menu for selecting an agency mask.

MAIN MENU (1 OF 2)

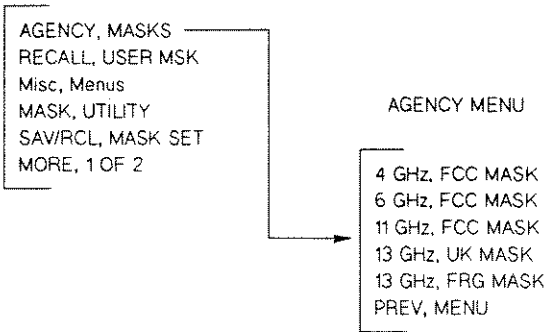

Figure 3-1. Agency Menu Selections

To select an agency mask, select **AGENCY MASKS** from the main menu. This leads to a menu listing the five agency masks. Choosing one of the agency masks automatically sets the analyzer's center frequency and span width.

If a signal with a power level greater than -40 dBm is present, the signal will be centered and the Measurement Menu displayed.

A signal with a power level below -40 dBm is ignored. **NO MEASURABLE SIGNAL DETECTED** appears on screen and the measurement menu is displayed again.

Note



During the operation of the digital radio measurements personality, the softkey menus are blanked. While the analyzer draws a mask on the screen, the word **COMPUTING** is displayed. The softkey menu will be re-displayed on the screen when the measurement has been completed.

Note



Appendix B, "Agency Masks," has sample displays of each agency mask, and includes the data necessary to recreate the agency masks. The agency mask data can be changed and used to create a user-defined custom mask by following the procedure in Chapter 4, "User-Defined Masks."

Measurement Functions

Page two of the main menu provides four measurement functions and a signal centering function. See Figure 3-2.

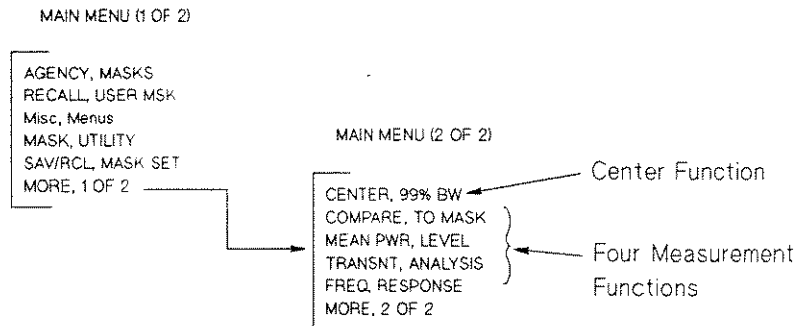

Figure 3-2. Main Menu Measurement Selections

In addition, the Miscellaneous Menu contains a function for reference level offset. See Figure 3-3.

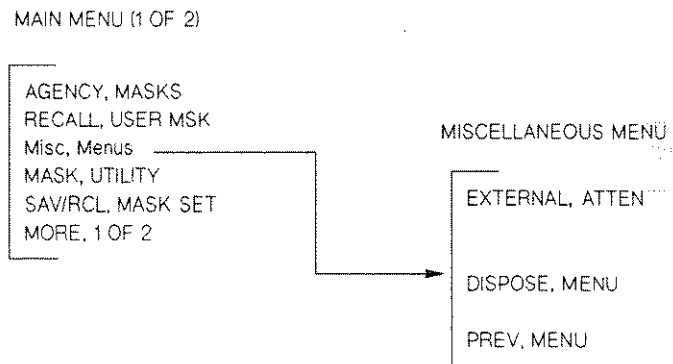

Figure 3-3. External Attenuation Softkey Location

EXTERNAL ATTN

If external attenuation is used in the test setup, use this function to offset the amplitude of the reference level without affecting the trace. The function uses the spectrum analyzer reference level offset function. Figure 3-3 shows the location of the softkey in the Miscellaneous Menu.

CENTER 99% BW

This function centers the 99% power bandwidth of the digital radio signal on the screen. Use this function if the center frequency has been changed or the signal has drifted.

COMPARE TO MASK

Makes a mean power measurement, then compares the result to the selected mask. If the mask is absolute, the top of the mask is referenced to the peak of the unmodulated carrier level and the modulated spectrum is compared to the mask. See Figure 3-4. Figure 3-5 illustrates the display of relative mask.

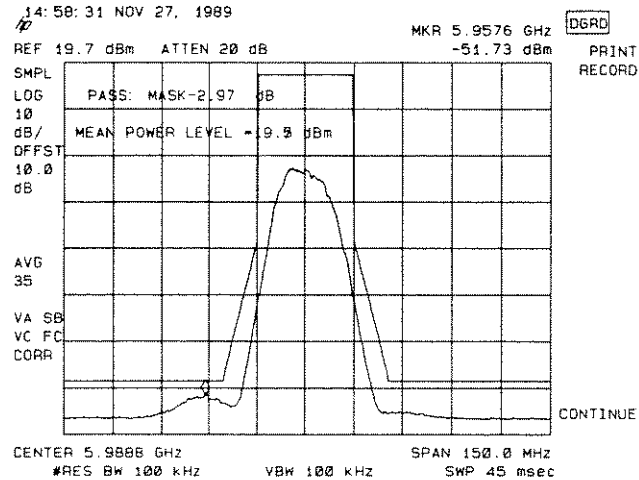

Figure 3-4. Display of Absolute Mask (Compare to Mask)

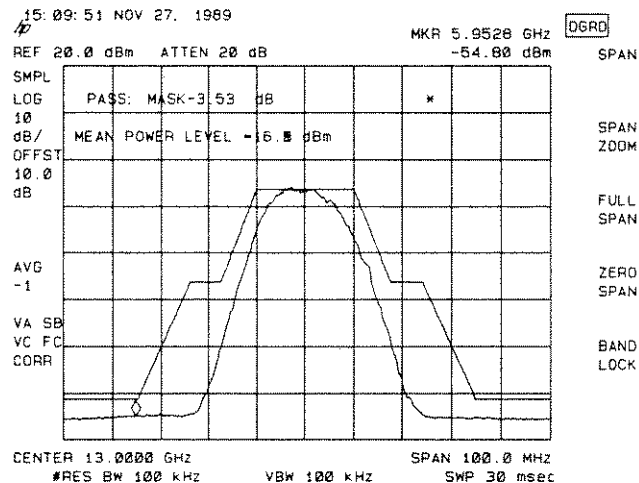

Figure 3-5. Display of Relative Mask (Compare to Mask)

After comparison, the **PRINT RECORD / CONTINUE** menu is displayed, and the mean power level and the **PASS** or **FAIL** message appear on screen. The marker indicates:

- the frequency where the least difference between the mask and signal occurred if the comparison passed, or
- the frequency where the most difference between mask and signal occurred if the comparison failed.

MEAN PWR LEVEL

This function determines the mean power level of the unmodulated carrier. The measurement is made on the modulated spectrum response of the digital radio signal. Incorrect power levels result when using the mean power level routine on a CW signal.

For signal levels greater than 0 dBm up to +30 dBm, additional attenuation is switched in and the measurement is repeated. At the completion of the measurement the **PRINT RECORD / CONTINUE** menu is displayed.

TRANSNT ANALYSIS

This transient analysis measurement looks for a signal within a mask's span on the display. If the signal is greater than -40 dBm, the -25 dB bandwidth is determined, the signal is video-averaged 35 times, then centered on the 25 dB down point. The analyzer is switched to zero span, and its sweep time is set to 30 seconds. At the end of each sweep, amplitude peak excursions of 5 dB or more are recorded.

If the signal is less than -40 dBm, the message **NO SIGNAL?** is displayed.

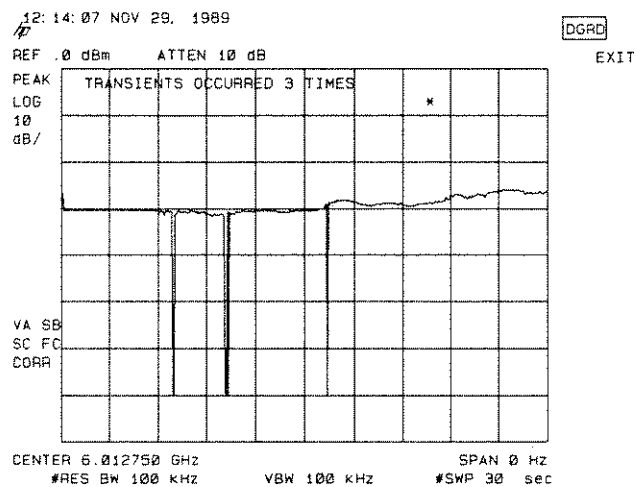

Figure 3-6. Transient Analysis Display

The amplitude changes occur due to signal frequency shifting. Frequency shifts meeting *both* of the following requirements will be recorded as transients:

- shifts beyond the signal's 25 dB bandwidth.
- shifts causing an amplitude change of 5 dB or greater from the signal's -25 dB level.

The number of amplitude excursions of 5 dB or more that occur during each sweep is displayed with the message **TRANSIENTS OCCURRED XXXX TIMES**.

Note



This measurement continues until the **EXIT** key is pressed. To get a hardcopy of this measurement, press **COPY**.

FREQ RESPONSE

Use this function for frequency response comparisons in digital radio systems. The measurement consists of the following two steps:

1. Entering the Reference Response
2. Comparing the Responses

Because the reference response is stored even when the instrument is turned off, frequency responses at different locations can be compared. A digital radio signal must be present to perform this measurement.

Pressing this key displays the frequency response menus shown in Figure 3-7.

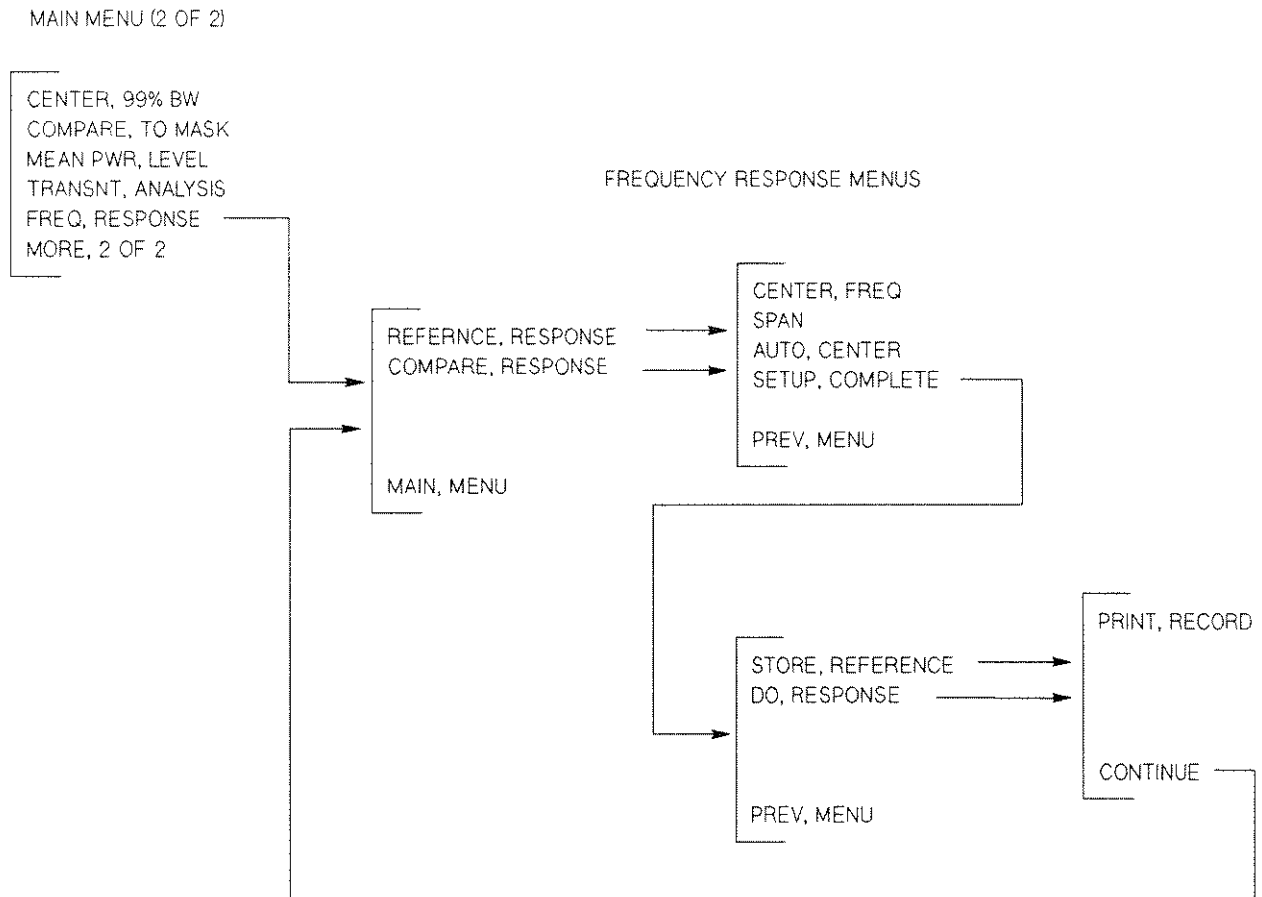

Figure 3-7. Frequency Response Menus

Entering the Reference Response

1. Press **REFERENCE RESPONSE**. Using the softkeys, set the center frequency and span width. Press **AUTO CENTER** to center the signal. If not satisfied with this centering, press **CENTER** and use the knob or **▲** and **▼** to set the center frequency. The spectrum analyzer span width also may be set as desired.
2. After the reference response has been set on screen, press **SETUP COMPLETE**. See Figure 3-8.

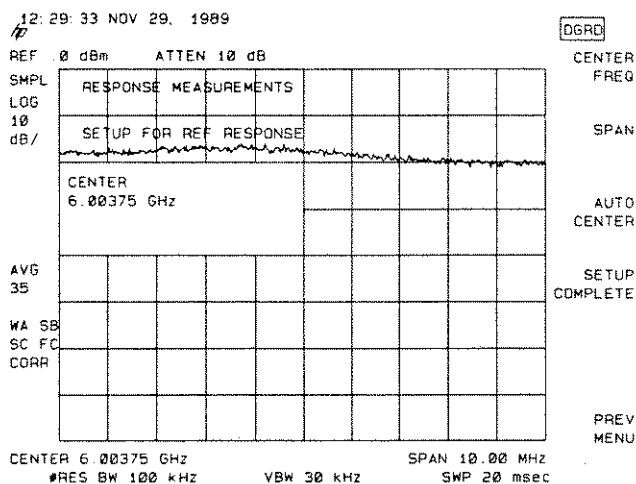

Figure 3-8. Example of Reference Response Display

Note



The left side of the displayed reference trace occasionally may have the incorrect amplitude values assigned to the first one or two display positions. Incorrect amplitude values appear as a vertical discontinuity at the start of the displayed trace. This does not affect the accuracy of the reference response trace, and may be cleared by pressing **REFERENCE RESPONSE**.

3. Press **STORE REFERENCE**. After the response has been stored, the response measurement menu returns. This reference is stored even when the instrument is turned off, so the instrument may be taken to a different location to compare a frequency response with the stored reference trace. The instrument may be used for other measurements.

Note



Using the **SAVE** **0** function with traces A, B, or C erases the stored reference trace.

Comparing the Responses

4. Connect the signal to be measured to the analyzer.

5. Set up the response comparison by pressing:

MODE DIGITAL RADIO MORE 1 of 2 RESPONSE MSRMENT
COMPARE RESPONSE .

6. Set the center frequency of the analyzer. Note that the span width cannot be changed.

7. Press **SETUP COMPLETE DO COMPARE**. The analyzer prompts for a PASS/FAIL criterion. Enter the required \pm tolerance value, and terminate with the dB key. For example, press **2** **dB**.

8. After the response comparison, the Log scale is adjusted to give best resolution to the response difference and PASS or FAIL is displayed on the screen. See Figure 3-9.

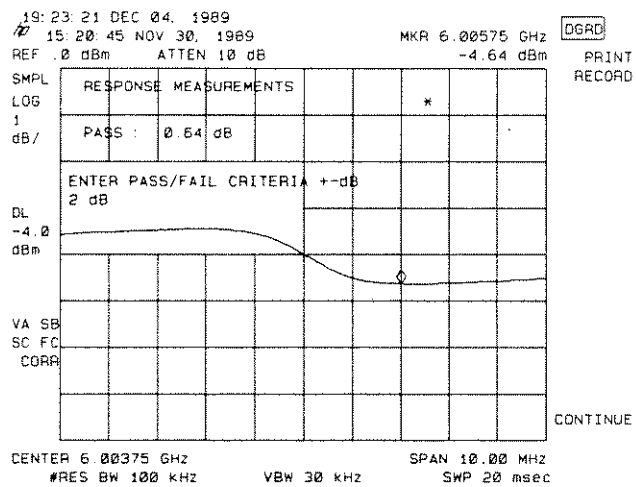

Figure 3-9. Compared Response

User-Defined Masks

This chapter explains how to create and use user-defined masks. User-defined masks allow you to customize digital radio measurements to your needs.

The personality includes user-defined mask 11, the Monitor Jack Mask as an example. Refer to “Monitor Jack Mask.”

The following topics are covered:

Mask Utility Functions	4-3
EDIT MASK	4-3
CREATE MASK	4-3
VW-BLNK MASK	4-3
LIST MASK	4-3
LIST MASK SET	4-3
Save/Recall Mask Functions	4-4
SAVE MASK SET	4-4
RECALL MASK SET	4-4
Monitor Jack Mask	4-5
Creating a Mask	4-6
Recalling a Mask	4-11
Editing a Mask	4-12
Copying a Mask	4-13

Two menus of softkeys, the Mask Utility Menu and the SAV/RCL Mask Menu, provide the functions for working with user-defined masks. Each menu is accessed from page two of the Main Menu. See Figure 4-1. An additional function, for recalling user masks, is accessed from the Main Menu.

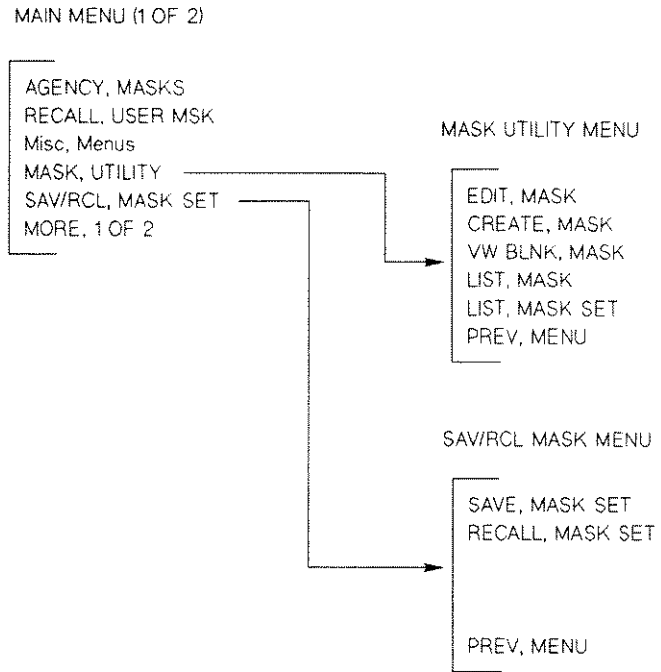

Figure 4-1. Utility and Save/Recall Mask Menus

Mask Utility Functions

RECALL USER MSK

Recall user masks with this function. (The softkey is located on page one of the Main Menu.) After pressing this key, enter the number of the user-defined mask to be recalled (ENTER # OF MASK <=11). Requires a number between 1 and 11 inclusive. An entry from 12 through 16 causes an agency mask to be displayed. When the mask is recalled, it sets the analyzer's state.

EDIT MASK

Using this key you can change any parameter of any mask in the set of 16 masks in the memory of the analyzer.

You enter the number of the mask you wish to change, and then press **NEXT ENTRY** to recall the mask data to make changes, or **PREVIOUS MENU** to start over or make a different choice.

Refer to "Editing a Mask" in this chapter for complete step-by-step instructions on editing a mask.

CREATE MASK

Enters the procedure for creating a mask customized to your specific requirements. The mask is created symmetrically around the center frequency. The first breakpoint is fixed at 0 MHz relative center frequency, and an amplitude of 0 dB. You will start to enter data from the second breakpoint. The frequency for the last breakpoint will be half the span set initially in defining the mask parameters.

Refer to "Creating a Mask" in this chapter for complete step-by-step instructions on creating a sample mask.

VW BLNK MASK

Allows the selected mask to be blanked or viewed as desired during the initial setup of a digital radio signal.

LIST MASK

Displays all the parameters of the selected mask on the display. This includes the mask center frequency, span width, measurement bandwidth, and the number of breakpoints. A table listing each breakpoint frequency, amplitude, and corrected amplitude also is displayed. For absolute masks, the corrected amplitude is the entered amplitude minus $10 \text{ LOG}_{10} (\text{RBW}/\text{Meas BW})$; that is, ten times the log to the base 10 of the ratio of the spectrum analyzer bandwidth to the authorized measurement bandwidth.

LIST MASK SET

Displays a tabular listing of all masks currently stored in the spectrum analyzer's memory. The table shows the mask number, center frequency, span width, and type, where type refers to a relative mask (1) or an absolute mask (2). The last five masks listed are the agency masks included in the digital radio measurements personality.

Save/Recall Mask Functions

SAVE MASK SET

Allows the operator to save the current mask set in one of three files on the memory card. The three possible file names are tMASK_1, tMASK_2, and tMASK_3.

RECALL MASK SET

Allows the operator to recall one of three previously saved mask sets. The three possible file names are tMASK_1, tMASK_2, and tMASK_3. If the file doesn't exist, the current mask set isn't changed.

Note



RECALL MASK SET uses state register 8 during the recall process. Any state stored in register #8 will be lost.

Monitor Jack Mask

The personality includes user-defined mask 11, the Monitor Jack Mask. This mask is provided as an example for using user-defined masks.

Many digital radio transmitters provide a jack for monitoring the RF output before the final power amplifier stage. This output does not include any additional filtering by the final stage. The Monitor Jack Mask, see Figure 4-2, is an example of a mask that might be used to test a signal at this location.

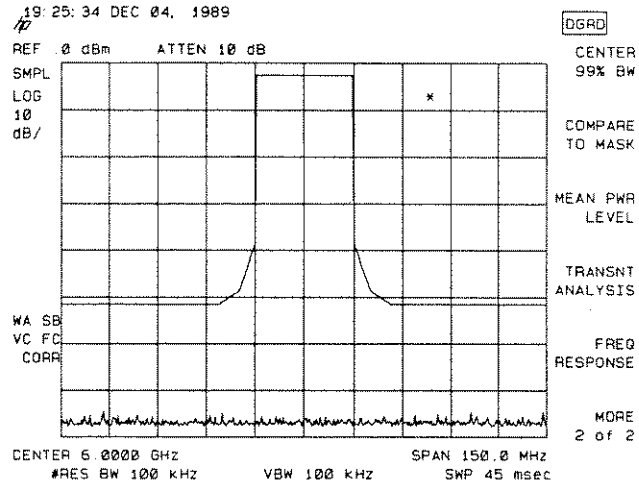

Figure 4-2. Monitor Jack Example Mask

Reference Level	1 (relative)
Center Frequency	6 GHz
Span	150 MHz
Measurement Bandwidth	4 kHz
Number of Breakpoints	6
breakpoint 1	0 MHz, 0 dB
breakpoint 2	15 MHz, 0 dB
breakpoint 3	15 MHz, -50 dB
breakpoint 4	20 MHz, -60 dB
breakpoint 5	26.3 MHz, -63 dB
breakpoint 6	75 MHz, -63 dB

Creating a Mask

The following step-by-step instructions demonstrate creating a sample mask. The sample 6 GHz FCC mask is created symmetrically around the center frequency. The first breakpoint is fixed at 0 MHz relative center frequency and an amplitude of 0 dB. You will start to enter data from the second breakpoint. The frequency for the last breakpoint will be half the span set when defining the mask parameters.

1. To create a new mask, press the following keys in sequence:
MASK UTILITY CREATE MASK.

The analyzer displays the mask parameters screen and, in the lower right corner, a highlighted block with the note "STARTING NEW MASK." See Figure 4-3.

```

15:31:20 NOV 27, 1989
REF 0 dBm   ATTN 10 dB
SMPL Enter value then press
LOG   NEXT or PREV ENTRY to
10    move on to next prompt.
dB/   REL FREQ  AMPLITUDE (dB)
      MHZ      ENTRY  CORR.
      0.0      0      0
ENTER # OF MASK <= 11
1
                                     NEXT
                                     ENTRY

Mask #1
SA SB Absolute Mask
SC FC Center Freq = 6000 MHz
CORR Span = 150 MHz
      Measurement BW = 4 kHz
      Breakpoints = 2
                                     STARTING NEW MASK
                                     MASK NOT SAVED
                                     PREV
                                     MENU
CENTER 6.0000 GHz   SPAN 150.0 MHz
*RES BW 100 kHz   VBW 100 kHz   SWP 45 msec

```

Figure 4-3. Sample Data Table for User-Created Mask

2. Answer all prompts. The first is:

ENTER # OF MASK <=11

Entering a number greater than 11 causes the mask number prompt to be reset to "1", repeating the request to enter a mask number.

For your sample mask, enter **5 Hz**, and press **NEXT ENTRY**.

To correct a mistake made during mask entry:

- a. Press **PREVIOUS ENTRY** until you get the correct prompt.
- b. Reenter data to correct the mistake, then press **NEXT ENTRY**. Continue to press **NEXT ENTRY** until the desired entry is displayed.

c. Continue to enter data for the remaining breakpoints. After the last breakpoint has been entered, press **DRAW USER MASK**.

3. The next prompt sets an ABSOLUTE or RELATIVE mask. The prompt is:

REL OR ABS MASK?
REL = 1, ABS = 2

Entering **2** **Hz** for an absolute mask sets the top of the mask to the unmodulated amplitude LEVEL of the carrier. For a relative mask, enter **1** **Hz**.

*For your sample mask, enter **2** **Hz**, and press **NEXT ENTRY**.*

4. MASK CENTER FREQUENCY?

*For your sample mask, enter **6** **GHz**, and press **NEXT ENTRY**.*

Note



Note that a mask created at one frequency can be used anywhere in the frequency range of the spectrum analyzer.

5. MASK SPAN?

The span entered remains fixed throughout the use of the mask. Any changes made later from the front panel are automatically reset, by the HP 85713A personality, to this entered span value before a measurement.

*For your sample mask, enter **1** **5** **0** **MHz**, then press **NEXT ENTRY**.*

6. MSRMNT BW OF MASK?

This prompt is only for absolute masks. It does not appear for relative mask entries. This feature is provided because absolute masks often are specified for a specific bandwidth. The FCC specifies a 4 kHz bandwidth.

*For your sample mask, enter **4** **kHz**, then press **NEXT ENTRY**.*

If the mask data is in a 4 kHz bandwidth, entering 4 kHz at this prompt corrects the subsequent amplitude data entry to the actual measurement bandwidth of the analyzer. The mask also is drawn to the amplitude values corresponding to the measurement bandwidth used by the analyzer. The user may enter mask data in any bandwidth.

7. ENTER # OF BREAKPTS <=9

The maximum number of breakpoints allowed for a

mask is nine. An entry greater than nine or less than two returns the prompt ENTER # OF BRKPTS <=9 to the screen.

For your sample mask, enter **5** **Hz**, then press **NEXT ENTRY**.

8. The remaining prompts create relative frequency and amplitude of the breakpoints.

For your sample mask, enter the following frequency-amplitude data in sequence:

Note



The mask is created symmetrically around the center frequency. The first breakpoint of 0 MHz and 0 dB amplitude is entered for you. You will start to enter data from the second breakpoint. The frequency for the last breakpoint will be half the span set when defining the mask parameters.

Breakpoint	Frequency	Amplitude
1	0 MHz	0 dB
2	15 MHz	0 dB
3	15 MHz	-50 dB
4	15.1 MHz	-50 dB
5	26.3 MHz	-80 dB
6	75 MHz	-80 dB

After mask amplitude data has been entered, a table is displayed on the screen showing relative frequency, entered amplitude, and corrected amplitude. For absolute masks, the corrected amplitude is the entered amplitude minus $10 \log_{10} (\text{RBW}/\text{Meas BW})$; that is, 10 times the log, base 10, of the ratio of the spectrum analyzer bandwidth to the authorized measurement bandwidth.

Entry of a relative frequency less than the previous frequency causes the previous frequency to be entered. The breakpoint data has to be reentered, with the correct relative frequency. Therefore, the relative frequencies of the breakpoints must increase or remain the same as the previous breakpoint. However, the amplitude can increase, decrease, or remain the same.

When the last breakpoint data entry is terminated, the draw and save user mask menu is displayed. See Figure 4-4.

```

19:05:10 DEC 04, 1989
REF .0 dBm   ATTN 10 dB
SMPL  Enter value then press
LOG  NEXT or PREV ENTRY to
10  move on to next prompt.
dB/      REL FREQ  AMPLITUDE (dB)
OFFST    MHz      ENTRY  CORR.
10.0     0.0      0      0
dB       15.0     0      0
        ENTER RELATIVE AMPLITUDE
        -80 dB      15.0     -50     -36
        POINT # 5  15.1     -50     -36
        Mask # 5   26.3     -80     -66
        Absolute Mask  75.0     -80     -66      DRAW
        SA SB          USER MSK
        SC FC Center Freq = 6000 MHz      SAVE
        CORR          Span = 150 MHz      USER MSK
        Measurement Bw = 4 kHz  EDITING MASK
        Breakpoints = 6  MASK NOT SAVED      PREV
        CENTER 6.0000 GHz      SPAN 150.0 MHz      MENU
        #RES BW 100 KHZ      VBW 100 KHZ      SWP 45 msec

```

Figure 4-4. Display After the Last Breakpoint Data Entry

9. Press **DRAW USER MSK**.

Note



During operation of the digital radio measurements personality, the softkey menus are blanked. When the analyzer is busy drawing a mask on the screen, the word **COMPUTING** is displayed. The softkey menu will be re-displayed on the screen when the measurement has been completed.

If the mask you have created is correct, press **PREVIOUS MENU**, then **SAVE USER MSK**. See Figure 4-5. If you wish to make any changes, press **PREVIOUS ENTRY** or **NEXT ENTRY**, and change the mask data. The user-created mask must be saved if it is to be used. After **SAVE USER MSK**, press **PREVIOUS MENU** twice to display the main menu.

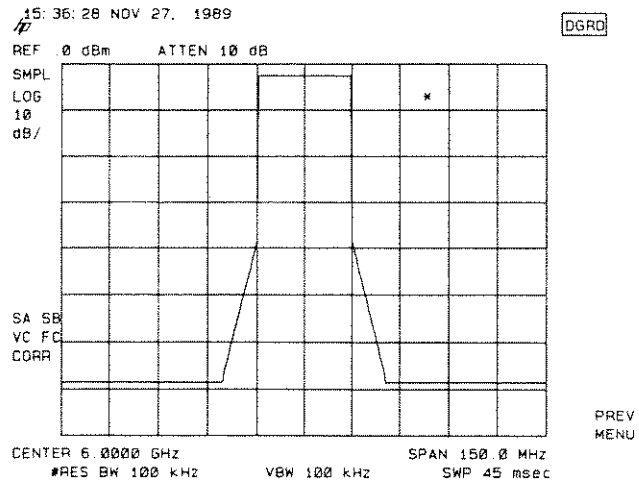

Figure 4-5. Sample of User-Created Mask

10. Press **SAVE USER MSK**. If the mask is not saved, all mask parameters will need to be reentered if the mask is needed later.

Note



The top of the mask is 2.5 dB below the reference level line to adjust for the 2.5 dB correction applied during a mean power level measurement. The 2.5 dB error compensates for the log amplifier noise and peak detector characteristics. For more information, refer to Hewlett-Packard application note AN 150-4, "Noise Measurements."

Recalling a Mask

The following procedure demonstrates recalling a user-defined mask.

1. Load the digital radio measurements personality and recall a user-defined mask by pressing the following keys:

DIGITAL RADIO RECALL USER MSK

2. The following prompt is displayed: **ENTER # OF MASK <=11**. Enter the number of the mask to be recalled and press **ENTER**. The number must be between 1 and 11 inclusive.

After the mask is recalled, the data stored in the mask about the analyzer's center frequency and span width sets the analyzer state. See Figure 4-6.

A signal greater than -40 dBm causes the signal to be centered on the screen and the measurement menu to be displayed.

The presence of a signal with a power level below -40 dBm causes the message **NO MEASURABLE SIGNAL DETECTED** and the measurement softkey menu to be displayed.

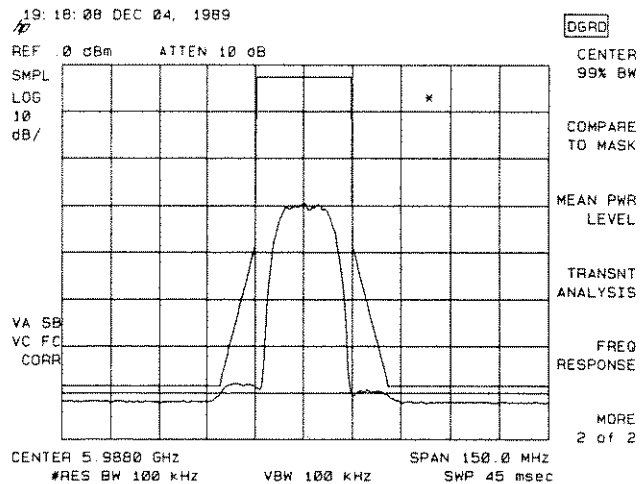

Figure 4-6. Recalled Mask Display

Editing a Mask

Use the following procedure to edit any mask. The procedure first activates a mask and then brings the mask into the editor.

If you are editing a user mask, you can skip activating the mask in steps 1 and 2 and directly enter the mask number in step 3. (Skipping steps 1 and 2 eliminates the need to recall a mask along with its attempt to locate a signal. However, you cannot edit an agency mask if these steps are skipped.)

Note



Entering the number of a mask that has not been created displays the message **Valid mask must be loaded or you must start a new mask**.

1. Activate the mask to be edited using one of the following methods:
 - Press **RECALL USER MSK** and select a user mask.
 - Press **AGENCY MASKS** and select an agency mask.
2. Press **MORE 2 of 2**.
3. Press **MASK UTILITY** and then **EDIT MASK** to display the first edit prompt: **ENTER # OF MASK <= 11**.
4. Press **NEXT ENTRY** or, if step 1 was skipped, enter the number of the mask to edit and press **ENTER**. (Agency mask numbers cannot be entered.)
5. The indicator **EDITING MASK** appears on screen. The mask data is ready to be edited.
6. Locate the appropriate data prompt using the **NEXT ENTRY** and **PREVIOUS ENTRY** softkeys and enter the new data. (The prompts are listed below in the order presented.)

```
ENTER # OF MASK <= 11
REL OR ABS MASK?
MASK CENTER FREQUENCY?
MASK SPAN?
MSRMNT BW OF MASK?
ENTER # OF BREAKPTS <=9
ENTER RELATIVE FREQUENCY
ENTER RELATIVE AMPLITUDE
```

7. To correct a mistake made during editing:
 - a. Press **PREVIOUS ENTRY** until you get the correct prompt.
 - b. Reenter data to correct the mistake, then press **NEXT ENTRY**. Continue to press **NEXT ENTRY** until the desired entry is displayed.
 - c. Continue to enter data for the remaining breakpoints. After the last breakpoint has been entered, press **DRAW USER MASK**.

8. After editing the mask, press **SAVE USER MSK** to save the mask data.

Copying a Mask

Use the following procedure to copy a mask. The procedure first activates a mask and then brings the mask into the editor.

If you are copying data from a user mask, you can skip activating the mask in steps 1 and 2 and directly enter the mask number in step 3. (Skipping steps 1 and 2 eliminates the need to recall a mask along with its attempt to locate a signal. However, you cannot copy from an agency mask if these steps are skipped.)

Note



Entering the number of a mask that has not been created displays the message **Valid mask must be loaded or you must start a new mask**.

1. Activate the mask to be copied using one of the following methods:
 - Press **RECALL USER MSK** and select a user mask.
 - Press **AGENCY MASKS** and select an agency mask.
2. Press **MORE 2 of 2**.
3. Press **MASK UTILITY** and then **EDIT MASK** to display the first edit prompt: **ENTER # OF MASK <= 11**.
4. Press **NEXT ENTRY** or, if step 1 was skipped, enter the number of the mask to copy data from and press **ENTER**. (Agency mask numbers cannot be entered.)
5. The indicator **EDITING MASK** appears on screen.
6. Press **PREVIOUS ENTRY** if displayed.
7. Enter the number of the new mask, and press **ENTER**.
8. Press the **SAVE USER MSK** to save the mask data under the new mask number.

Softkey Reference

This chapter lists in alphabetical order each of the personalities main softkeys. A description of each key is provided.

4 GHZ FCC

This mask conforms to the FCC specifications listed below. Refer to Appendix B Agency Masks for complete mask specifications.

Center Frequency: 4 GHz
 Bandwidth: 20 MHz
 Attenuation below carrier power:

$$A_{dB} = 35 + 0.8(n - 50) + 10\log BW$$

where:

A: attenuation in dB
 n: percent of bandwidth offset from center frequency (up to 250%)
 BW: 20 (specified bandwidth in MHz)

6 GHZ FCC

This mask conforms to the FCC specifications listed below. Refer to Appendix B Agency Masks for complete mask specifications.

Center Frequency: 6 GHz
 Bandwidth: 30 MHz
 Attenuation below carrier power:

$$A_{dB} = 35 + 0.8(n - 50) + 10\log BW$$

where:

A: attenuation in dB
 n: percent of bandwidth offset from center frequency (up to 250%)
 BW: 30 (specified bandwidth in MHz)

11 GHZ FCC

This mask conforms to FCC specifications. Refer to Appendix B Agency Masks for complete mask specifications.

Center Frequency: 11 GHz
 Bandwidth: 40 MHz
 Attenuation below carrier power:

$$A_{dB} = 35 + 0.8(n - 50) + 10\log BW$$

where:

A: attenuation in dB
n: percent of bandwidth offset from center frequency (up to 250%)
BW: 40 (specified bandwidth in MHz)

13 GHZ UK MASK

This mask is the UK MPT 1403 test limits for a 13 GHz, 34 Mb/s QPSK radio system. It is a relative mask, meaning the top of the mask is referenced to the peak of the signal being analyzed. Refer to Appendix B, "Agency Masks," for complete mask specifications.

13 GHZ FRG MASK

This mask is the tolerance mask for a West German QPSK earth station transmitter. It is a relative mask, meaning the top of the mask is referenced to the peak of the signal being analyzed. Refer to Appendix B, "Agency Masks," for complete mask specifications.

ABORT

Allows the operator to leave the frequency response comparison setup and either start over, or return through the frequency response menus to the digital radio measurement personalities main menu.

AGENCY MASKS

Leads to a menu listing the five agency masks. Choosing one of the agency masks automatically sets the analyzer's center frequency and span width. A signal with a power level less than -40 dBm causes "NO MEASURABLE SIGNAL DETECTED" to be displayed. A signal with a power level greater than -40 dBm will be centered. The measurement menu then is displayed.

AUTO CENTER

Invokes a built-in firmware routine that automatically centers a displayed signal on the spectrum analyzer's screen.

CENTER 99% BW

This function centers the 99% power bandwidth of the digital radio signal on the screen. Use this function if the center frequency has been changed or the signal has drifted.

CENTER FREQ

Allows the center frequency of the spectrum analyzer to be set as desired for the signal to be measured.

COMPARE RESPONSE

Leads to a menu for setting the signal measurement conditions prior to making a frequency response measurement. The signal's center frequency and span

width can be set. An **AUTO CENTER** softkey invokes a built-in routine that automatically centers the signal on the spectrum analyzer's screen.

COMPARE TO MASK

Makes a mean power measurement, then compares the result to the selected mask. If the mask is absolute, the top of the mask is referenced to the peak of the unmodulated carrier level and the modulated spectrum is compared to the mask. If the mask is relative, the mask is shifted to the peak of the signal and the comparison made.

After comparison, the **PRINT RECORD/CONTINUE** menu is displayed, and the mean power level and the **PASS** or **FAIL** message appears on screen. The marker indicates:

- the frequency where the least difference between the mask and signal occurred if the comparison passed, or
- the frequency where the most difference between mask and signal occurred if the comparison failed.

CREATE MASK

Enters the procedure for creating a mask customized to your specific requirements. The mask is created symmetrically around the center frequency. The first breakpoint is fixed at 0 MHz relative center frequency, and an amplitude of 0 dB. You will start to enter data from the second breakpoint. The frequency for the last breakpoint will be half the span set initially in defining the mask parameters. Refer to Chapter 4, "Creating a Mask," for complete step-by-step instructions to create a sample mask.

DIGITAL RADIO

Appears on the right side of the display after the spectrum analyzer has been turned on, or **PRESET** has been pressed, and the digital radio measurements personality is loaded in the analyzer memory.

DISPOSE DIGRAD

Removes all of the Digital Radio Personality from the analyzer's internal memory. No other currently loaded

	downloadable programs will be removed from the analyzer.
DISPOSE MENU	Leads to the DISPOSE DIGRAD and PREV MENU softkeys. DISPOSE DIGRAD must be pressed twice to delete the personality.
DO COMPARE	Allows the operator to enter a Pass/Fail criteria in dB. The reference frequency response and the compare frequency response are then compared.
DRAW USER MSK	Draws the current mask being edited or created. This key is invisible when creating a mask until the operator has entered the last amplitude value.
EDIT MASK	Asks you to enter the number of the mask you wish to change. You must then press NEXT ENTRY to recall the mask data to make changes, or PREVIOUS ENTRY to start over or make a different choice.
EXIT	Allows the user to stop a transient analysis measurement.
EXTERNAL ATTEN	Offsets the amplitude of the reference level without affecting the trace when external attenuation is used in the test setup. It uses the spectrum analyzer reference level offset function.
FREQ RESPONSE	Leads to a frequency response measurement setup menu. This measurement allows the user to set up a reference signal response on the spectrum analyzer's display with the desired frequency span and center frequency. After the initial setup is complete, the reference trace is stored. The spectrum analyzer may be carried to another site where the frequency response can be tested by comparison to the previously stored reference trace.
LIST MASK	Displays all the parameters of the selected mask on the display. This includes the mask center frequency, span width, measurement bandwidth, and the number of breakpoints. A table listing each breakpoint frequency, amplitude, and corrected amplitude also is displayed. For absolute masks, the corrected amplitude

is the entered amplitude minus 10 LOG_{10} (RBW/Meas BW;) that is, ten times the log to the base 10 of the ratio of the spectrum analyzer bandwidth to the authorized measurement bandwidth.

LIST MASK SET

Displays a tabular listing of all masks currently stored in the spectrum analyzer's memory. The table shows the mask number, center frequency, span width, and type, where type refers to a relative mask (1) or an absolute mask (2). The last five masks listed are the agency masks included in the digital radio measurements personality.

MASK UTILITY

Leads to the menu that allows the operator to edit a mask, create a mask, view or blank a mask, list a mask and its parameters, list the complete set of masks now in memory, or return to the previous menu.

MEAN PWR LEVEL

Makes a mean power level measurement. For signal levels greater than 0 dBm up to +30 dBm, additional attenuation is switched in and the measurement is repeated. At the completion of the measurement the PRINT RECORD/CONTINUE menu is displayed.

The mean power level measurement is made on the modulated spectrum response of the digital radio signal. It determines the mean power level of the unmodulated carrier. Incorrect power levels result when using the mean power level routine on a CW signal.

Misc Menus

Leads to a menu listing the EXTERNAL ATTEN and DISPOSE MENU softkeys.

NEXT ENTRY

Moves on to the next prompt when creating or editing a mask.

PREV MENU

Returns you to the menu that preceded the last softkey pressed.

PREVIOUS ENTRY

Moves on to the previous prompt when creating or editing a mask.

PRINT RECORD

This key makes a hardcopy of the screen. If the analyzer is connected to a printer, additional text for keeping a record of

the current measurement is added to the bottom of the printout. This key is available under the COMPARE TO MASK, MEAN PWR LEVEL, and RESPONSE MSRMENT keys.

RECALL MASK SET

Recall user masks with this function. Allows the operator to recall one of three previously saved mask sets. The three possible file names are tMASK_1, tMASK_2, and tMASK_3. If the file doesn't exist, the current mask set isn't changed.

RECALL USER MSK

After pressing this key, enter the number of the user-defined mask to be recalled (ENTER # OF MASK <=11). Requires a number between 1 and 11 inclusive. When the mask is recalled, it sets the analyzer's state.

REFERENCE RESPONSE

Leads to a menu for setting the signal comparison conditions prior to making a frequency response measurement. The signal's center frequency and span width can be set. An AUTO CENTER softkey invokes a built-in firmware routine that automatically centers a displayed signal on the spectrum analyzer's screen.

SAVE MASK SET

Allows the operator to save the current mask set in one of three files on the memory card. The three possible file names are tMASK_1, tMASK_2, and tMASK_3.

SAVE USER MSK

Saves and draws the mask being editing or creating. This key is invisible when creating a mask until the operator has entered the last amplitude value.

SAV/RCL MASK SET

Leads to the SAVE MASK SET and RECALL MASK SET softkeys that allow the operator to save or recall a set of masks to or from a RAM memory card.

SETUP COMPLETE

Proceeds to video-average 35 sweeps of the signal conditions set after pressing the COMPARE RESPONSE or REFERENCE RESPONSE softkey. If part of the COMPARE RESPONSE procedure, the spectrum analyzer will again do a video average of 35 sweeps of the signal trace compared to the reference trace. After

completing the video average and pressing **DO COMPARE**, the operator will be asked to **ENTER PASS/FAIL CRITERIA +-dB**. After entering the comparison criteria, the signal and reference trace comparison will be displayed with the pass or fail criteria in dB.

SPAN

Allows the span width of the spectrum analyzer to be set as desired for the signal to be measured.

STORE REFERENCE

Allows the operator to store the reference frequency response in Trace 0.

TRANSNT ANALYSIS

This transient analysis measurement looks for a signal within a mask's span on the display. If the signal is greater than -40 dBm, the -25 dB bandwidth is determined, the signal is video-averaged 35 times, then centered on the 25 dB down point. The analyzer is switched to zero span, and its sweep time is set to 30 seconds. At the end of each sweep, amplitude peak excursions of 5 dB or more are recorded.

If the signal is less than -40 dBm, the message **NO SIGNAL?** is displayed.

The amplitude changes occur due to signal frequency shifting. Frequency shifts meeting *both* of the following requirements will be recorded as transients:

- shifts beyond the signal's 25 dB bandwidth.
- shifts causing an amplitude change of 5 dB or greater from the signal's -25 dB level.

The number of amplitude excursions of 5 dB or more that occur during each sweep is displayed with the message **TRANSIENTS OCCURRED XXXX TIMES**.

VW BLNK MASK

Allows the selected mask to be blanked or viewed as desired during the initial setup of a digital radio signal. If a mask has not been recalled or has been corrupted, this key will do nothing.

Digital Radio Measurements Personality Terms

ABSOLUTE MASK

An absolute mask references the power level of the modulated spectrum response to the unmodulated carrier power level. The FCC 6 GHz band specification sets the level for the spectrum response 15 MHz away from the carrier frequency at 50 dB down from the absolute carrier power level. This type of mask is used mostly in the United States.

BREAKPOINT

A breakpoint is where a discontinuity occurs in either frequency or amplitude on a mask. The relative frequency of one breakpoint to another can only increase or remain the same. The amplitude of breakpoints can increase, decrease, or remain the same.

CENTER 99% BW

This softkey evokes a built-in routine that computes the bandwidth containing 99% of the total power of the signal response, then centers that bandwidth on the screen.

FIRMWARE

The digital radio measurements personality requires the HP 8593A firmware to be 8593A rev D (dated 26.6.89) or newer. This date is shown on the display when the instrument first is turned on.

MASK

A mask is a graphical representation of the FCC (or other government agency) specifications for the transmitted spectrum of a digital radio system. A mask outlines the authorized bandwidth that must contain the modulated spectrum.

MEAN POWER LEVEL MEASUREMENT

This measurement of mean power is performed by an internal firmware and software routine. This measurement is made on the

modulated spectrum response and determines the mean power level of the unmodulated carrier.

Note



An attempt to use the mean power measurement on a CW signal would result in erroneous power levels.

**MEASUREMENT
BANDWIDTH**

To ensure the spectrum analyzer has enough sensitivity, and the displayed noise level is below the digital radio signal, a narrow bandwidth is normally used, that is, 100 kHz and below. If the mask data is given in a 4 kHz bandwidth, as for the FCC absolute masks, entering 4 kHz to the prompt **ENTER MEASUREMENT BW OF MASK** corrects the entered amplitude data to the actual measurement bandwidth of the spectrum analyzer. The corrected amplitude is equal to the entered amplitude of the mask minus $10 \log_{10} (\text{RBW}/\text{Meas BW})$; that is, 10 times the log, base 10, of the ratio of the spectrum analyzer's bandwidth to the authorized measurement bandwidth.

REFERENCE

HP Application Note 355, *Digital Radio Theory and Measurements*. This application note is suggested as a reference to digital radio principles and practices.

RELATIVE MASK

A relative mask sets the maximum power level of the mask at the peak of the modulated spectrum response, centered within the mask. This type of mask is used primarily outside the United States.

**TRANSIENT ANALYSIS
MEASUREMENT**

This softkey evokes a monitor routine built into the digital radio measurements personality. Any changes in amplitude or frequency that occur will be seen on screen and logged. After the selected time period has passed, the total number of transients that occurred will have been logged on screen.

Agency Masks

Definitions

Mask Number	1 through 11 for user-defined masks; 12 through 16 for agency masks.
Reference Level	1 = mask positioned on peak of displayed modulated signal. 2 = mask positioned relative to peak of unmodulated carrier.
Center Frequency	Desired center frequency of mask.
Span	Desired span; should allow for sidelobes as well as spurs.
Measurement Bandwidth	Noise power bandwidth for which to adjust mask. (Often specified by communications agency; for example, FCC = 4 kHz.)
Number of Breakpoints	≤ 9 ; assumes a symmetrical mask.
Breakpoints	Enter frequency in offset from center of mask. Enter amplitude in \pm dB relative to center point of the mask.

4 GHz FCC Mask

Mask Number	12
Reference Level	2 (absolute)
Center Frequency	4 GHz
Span	100 MHz
Measurement Bandwidth	4 kHz
Number of Breakpoints	6
breakpoint 1	0 MHz, 0 dB
breakpoint 2	10 MHz, 0 dB
breakpoint 3	10 MHz, -50 dB
breakpoint 4	10.5 MHz, -50 dB
breakpoint 5	18 MHz, -80 dB
breakpoint 6	50 MHz, -80 dB

This mask is described as the attenuation below carrier power by the following formula:

$$A_{dB} = 35 + 0.8(n - 50) + 10\log BW$$

where:

A: attenuation in dB

n: percent of bandwidth offset from center frequency (up to 250%)

BW: 20 (specified bandwidth in MHz)

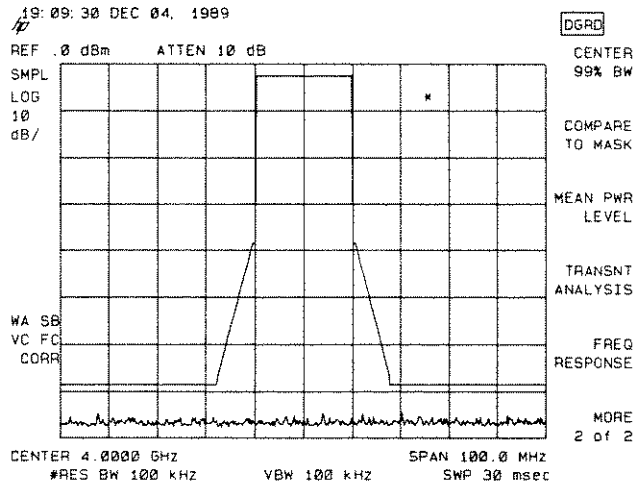

Figure B-1. 4 GHz FCC Mask

6 GHz FCC Mask

Mask Number	13
Reference Level	2 (absolute)
Center Frequency	6 GHz
Span	150 MHz
Measurement Bandwidth	4 kHz
Number of Breakpoints	6
breakpoint 1	0 MHz, 0 dB
breakpoint 2	15 MHz, 0 dB
breakpoint 3	15 MHz, -50 dB
breakpoint 4	15.1 MHz, -50 dB
breakpoint 5	26.3 MHz, -80 dB
breakpoint 6	75 MHz, -80 dB

This mask is described as the attenuation below carrier power by the following formula:

$$A_{dB} = 35 + 0.8(n - 50) + 10\log BW$$

where:

A: attenuation in dB

n: percent of bandwidth offset from center frequency (up to 250%)

BW: 30 (specified bandwidth in MHz)

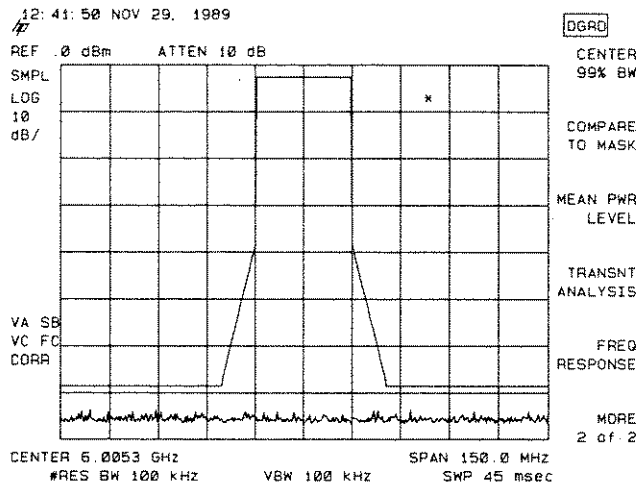

Figure B-2. 6 GHz FCC Mask

11 GHz FCC Mask

Mask Number	14
Reference Level	2 (absolute)
Center Frequency	11 GHz
Span	200 MHz
Measurement Bandwidth	4 kHz
Number of Breakpoints	5
breakpoint 1	0 MHz, 0 dB
breakpoint 2	20 MHz, 0 dB
breakpoint 3	20 MHz, -51 dB
breakpoint 4	34.5 MHz, -80 dB
breakpoint 5	100 MHz, -80 dB

This mask is described as the attenuation below carrier power by the following formula:

$$A_{dB} = 35 + 0.8(n - 50) + 10\log BW$$

where:

A: attenuation in dB

n: percent of bandwidth offset from center frequency (up to 250%)

BW: 40 (specified bandwidth in MHz)

Note



The displayed average noise specification for the HP 8593A in the 100 kHz resolution and video bandwidths, used for this mask, is -79 dB. The typical HP 8593A displayed average noise floor will be at or below the -80 dBm floor of the 11 GHz mask. Signals at this noise floor peak approximately 3 dB above the displayed noise level. Unwanted spurious signals, or signals above the -80 dBm mask floor can be seen on the HP 8593A.

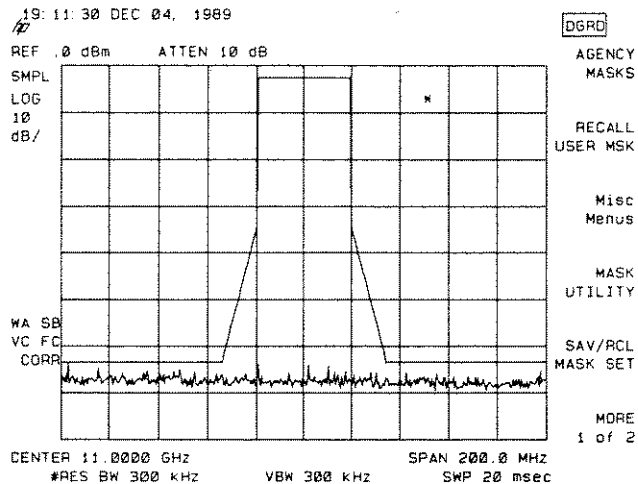

Figure B-3. 11 GHz FCC Mask

13 GHz UK Mask

Mask Number 15
 Reference Level 1 (relative)
 Center Frequency 13 GHz
 Span 100 MHz
 Measurement Bandwidth not applicable
 Number of Breakpoints 6
 breakpoint 1 0 MHz, 0 dB
 breakpoint 2 10 MHz, 0 dB
 breakpoint 3 17.5 MHz, -20 dB
 breakpoint 4 24 MHz, -20 dB
 breakpoint 5 35 MHz, -45 dB
 breakpoint 6 50 MHz, -45 dB

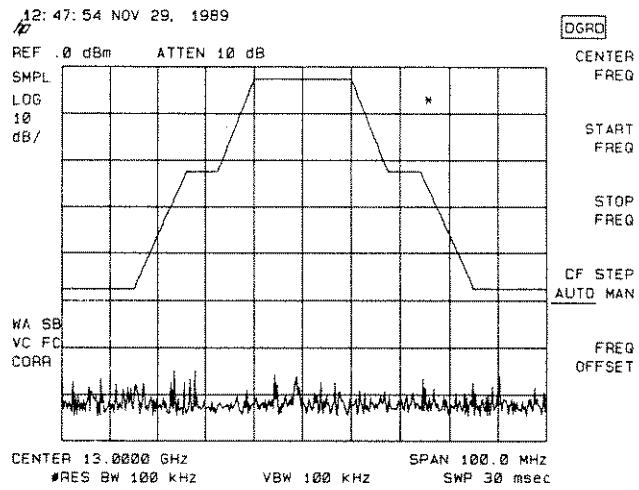

Figure B-4. 13 GHz UK Mask

13 GHz FRG Mask

Mask Number	16
Reference Level	1 (relative)
Center Frequency	13 GHz
Span	100 MHz
Measurement Bandwidth	not applicable
Number of Breakpoints	8
breakpoint 1	0 MHz, 0 dB
breakpoint 2	10 MHz, 0 dB
breakpoint 3	10 MHz, -10 dB
breakpoint 4	19 MHz, -10 dB
breakpoint 5	19 MHz, -20 dB
breakpoint 6	25 MHz, -20 dB
breakpoint 7	45 MHz, -37 dB
breakpoint 8	50 MHz, -37 dB

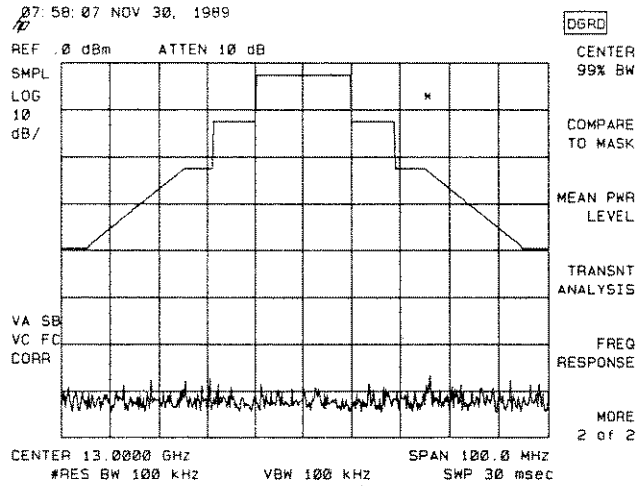

Figure B-5. 13 GHz FRG Mask

Menu Map

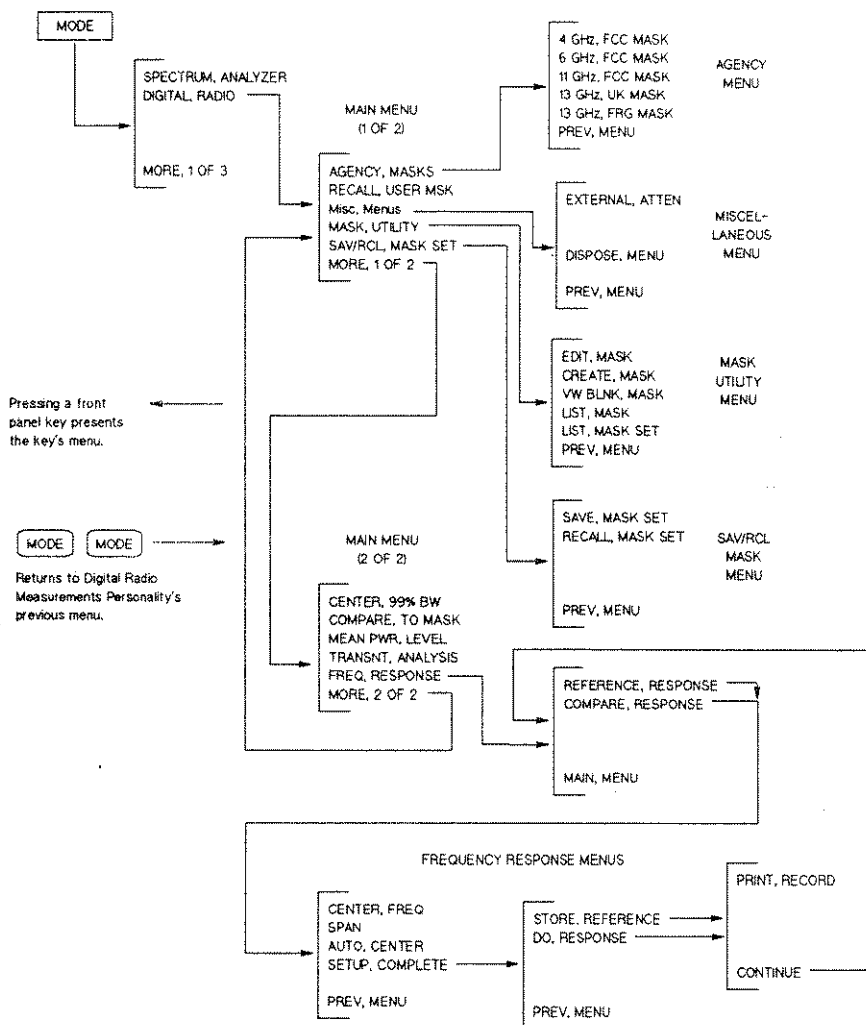

Figure C-1. HP 85713A Menu Map

Index

4

4 GHZ FCC, 5-1

6

6 GHZ FCC, 5-1

10

11 GHZ FCC, 5-1

13 GHZ FRG MASK, 5-2

13 GHZ UK MASK, 5-2

A

ABORT, 5-2

agency mask

 selection, 3-2

agency masks, 1-4

 11 GHz FCC, 5-1, B-4

 13 GHz FRG, 5-2, B-6

 13 GHz UK, 5-2, B-5

 4 GHz FCC, 5-1, B-2

 6 GHz FCC, 5-1, B-3

AGENCY MASKS, 5-2

AUTO CENTER, 5-2

C

CENTER 99% BW, 3-3, 5-2

CENTER FREQ, 5-2

COMPARE RESPONSE, 5-2

COMPARE TO MASK, 3-4, 5-3

computing, 1-3

CREATE MASK, 4-3, 5-3

creating a mask, 4-6

custom masks, 4-3

D

deleting all personalities, 2-3

deleting the personality, 2-3

DIGITAL RADIO, 5-3

DISPOSE DIGRAD, 5-3

DISPOSE MENU, 5-4

DO COMPARE, 5-4

DRAW USER MSK, 5-4

E

EDIT MASK, 4-3, 5-4

EXIT, 5-4

exiting the personality, 2-2

EXTERNAL ATTEN, 3-3, 5-4

F

features, 1-4

FREQ RESPONSE, 3-6, 5-4

frequency response, 3-6

I

installation, 2-1

L

LIST MASK, 4-3, 5-4

LIST MASK SET, 4-3, 5-5

M

manual terms, 1-5

mask parameters

 displaying, 4-3

 listing, B-1

MASK UTILITY, 5-5

mask utility menu, 4-3

mean power level, 3-5

MEAN PWR LEVEL, 3-5, 5-5

Misc Menus, 5-5

mode, 2-2

MODE, 1-3

monitor jack mask, 4-5

N

NEXT ENTRY, 5-5

NO MEASUREABLE SIGNAL DETECTED, 3-2

P

PREVIOUS ENTRY, 5-5

PREV MENU, 5-5

printing, 1-5

PRINT RECORD, 5-5

R

recalling a user mask, 4-11
recalling mask sets, 4-4
RECALL MASK SET, 4-4, 5-6
RECALL USER MSK, 4-3, 5-6
REFERENCE RESPONSE, 5-6

S

SAVE MASK SET, 4-4, 5-6
SAVE USER MSK, 5-6
saving mask sets, 4-4
SAV/RCL MASK SET, 5-6
SETUP COMPLETE, 5-6

SPAN, 5-7

STORE REFERENCE, 5-7

T

transient analyzer, 3-5
TRANSNT ANALYSIS, 3-5, 5-7

U

user-created masks, 1-4
user mask example, 4-5

V

VW BLNK MASK, 4-3, 5-7