

SAFETY CONSIDERATIONS

GENERAL

This product and related documentation must be reviewed for familiarization with safety markings and instructions before operation.

This product is a Safety Class I instrument (provided with a protective earth terminal).

BEFORE APPLYING POWER

Verify that the product is set to match the available line voltage and the correct fuse is installed.

SAFETY EARTH GROUND

An uninterruptible safety earth ground must be provided from the main power source to the product input wiring terminals, power cord, or supplied power cord set.

WARNINGS

Any interruption of the protective (grounding) conductor (inside or outside the instrument) or disconnecting the protective earth terminal will cause a potential shock hazard that could result in personal injury. (Grounding one conductor of a two conductor outlet is not sufficient protection.) In addition, verify that a common ground exists between the unit under test and this instrument prior to energizing either unit.

Whenever it is likely that the protection has been impaired, the instrument must be made inoperative and be secured against any unintended operation.

If this instrument is to be energized via an auto-transformer (for voltage reduction) make sure the common terminal is connected to neutral (that is, the grounded side of the mains supply).

Servicing instructions are for use by service-trained personnel only. To avoid dangerous electric shock, do not perform any servicing unless qualified to do so. Adjustments described in the manual are performed with power supplied to the instrument while protective covers

are removed. Energy available at many points may, if contacted, result in personal injury.

Capacitors inside the instrument may still be charged even if the instrument has been disconnected from its source of supply.

For continued protection against fire hazard, replace the line fuse(s) only with 250V fuse(s) of the same current rating and type (for example, normal blow, time delay, etc.) Do not use repaired fuses or short-circuited fuseholders.

SAFETY SYMBOLS



Instruction manual symbol: the product will be marked with this symbol when it is necessary for the user to refer to the instruction manual (see Table of Contents for page references).



Indicates hazardous voltages.



Indicates earth (ground) terminal.

WARNING

The WARNING sign denotes a hazard. It calls attention to a procedure, practice, or the like, which, if not correctly performed or adhered to, could result in personal injury. Do not proceed beyond a WARNING sign until the indicated conditions are fully understood and met.

CAUTION

The CAUTION sign denotes a hazard. It calls attention to an operating procedure, practice, or the like, which, if not correctly performed or adhered to, could result in damage to or destruction of part or all of the product. Do not proceed beyond a CAUTION sign until the indicated conditions are fully understood and met.

COPYRIGHT AND DISCLAIMER NOTICE

Copyright – Agilent Technologies, Inc. Reproduced with the permission of Agilent Technologies Inc. Agilent Technologies, Inc. makes no warranty of any kind with regard to this material including, but not limited to, the implied warranties of merchantability and fitness for a particular purpose. Agilent Technologies, Inc. is not liable for errors contained herein or for incidental or consequential damages in connection with the furnishing, performance, or use of this material or data.



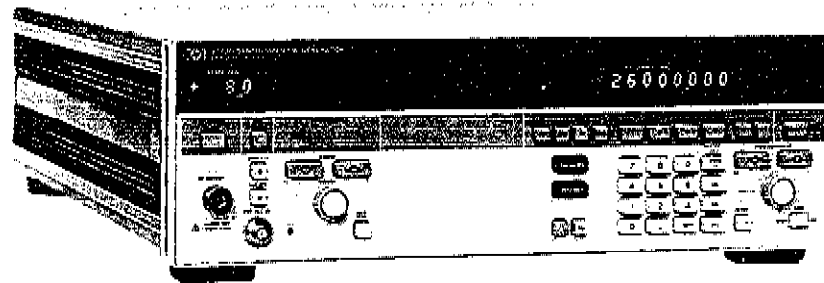

HP 8673G SYNTHESIZED CW GENERATOR

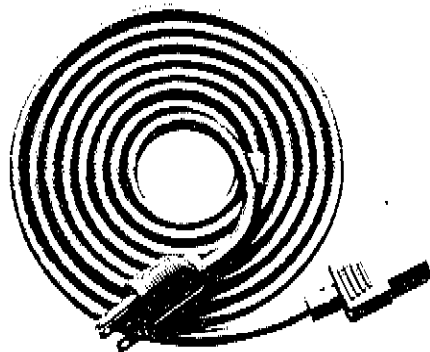

LINE POWER CABLE

APC-3.5 (F) to TYPE-N (F)
ADAPTER

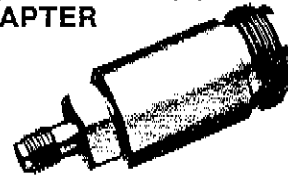

APC-3.5 (F-F)
ADAPTER

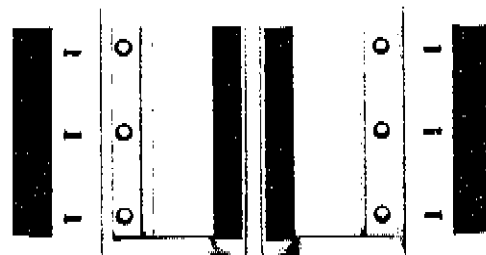

OPTION 907
FRONT HANDLE KIT

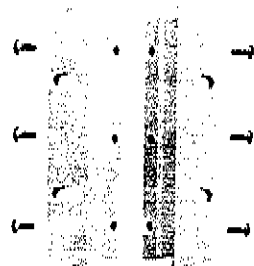

OPTION 908
RACK FLANGE KIT

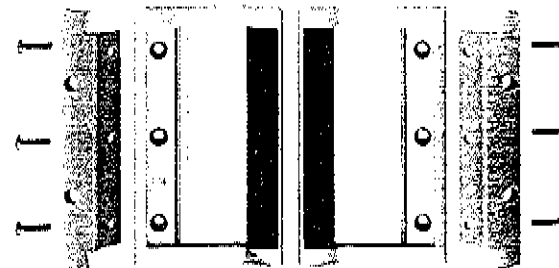

OPTION 909
RACK FLANGE AND FRONT
HANDLE COMBINATION KIT

Figure 1-1. HP 8673G Accessories Supplied, and Options 907, 908, and 909

SECTION 1 GENERAL INFORMATION

1-1. INTRODUCTION

The HP 8673G Operating Manual contains all the information required to install, operate, and test the Hewlett-Packard Model 8673G Synthesized Signal Generator. Figure 1-1 shows an HP 8673G Signal Generator with all of its externally supplied accessories.

The HP 8673G Operating Manual has four sections:

- Section 1, General Information
- Section 2, Installation
- Section 3, Operation
- Section 4, Performance Tests

The HP 8673G Service Manual, which is shipped with the instrument as Option 915 or ordered separately, has four sections:

- Section 5, Adjustments
- Section 6, Replaceable Parts
- Section 7, Manual Changes
- Section 8, Service

Additional copies of the Operating Manual or the Service Manual can be ordered separately through your nearest Hewlett-Packard office.

1-2. SPECIFICATIONS

Instrument specifications are listed in Table 1-1. These specifications are the performance standards or limits against which the instrument may be tested. Supplemental characteristics are listed in Table 1-2. Supplemental characteristics are not warranted specifications, but are typical characteristics included as additional information for the user.

1-3. SAFETY CONSIDERATIONS

This product is a Safety Class I instrument, that is, one provided with a protective earth terminal. The Signal Generator and all related documentation should be reviewed for familiarization with safety markings and instructions before operation. Refer to the Safety Considerations page found at the beginning of this manual for a summary of the safety information. Safety information for installation, operation, performance test-

1-4. MANUAL UPDATES

Manual Updates provide information necessary to update the manual. The supplement is identified by the manual print date and part number, both of which appear on the manual title page.

1-5. DESCRIPTION

The HP 8673G Synthesized Signal Generator has a frequency range of 2.0 to 26.0 GHz (1.95 to 26.5 GHz overrange). The output is leveled and calibrated from +8 dBm to -100 dBm, depending on the frequency and options. For additional information, see Table 1-1. Frequency, output level, and all other functions except line switch can be remotely programmed via HP-IB.

Long-term frequency stability is dependent on the time base, either an internal or external reference oscillator. The internal crystal reference oscillator operates at 10 MHz while an external oscillator may operate at 5 or 10 MHz. The output of the Signal Generator is exceptionally flat due to the action of the internal automatic leveling control (ALC) loop.

The Signal Generator is compatible with HP-IB to the extent indicated by the following code: SI, AH1, T5, TE0, L3, LE0, SR1, RL1, PP1, DC1, D1, and C0. The Signal Generator interfaces with the bus via three-state TTL circuitry. An explanation of the compatibility code can be found in IEEE Standard 488 (1978), "IEEE Standard Digital Interface for Programmable Instrumentation" or the identical ANSI Standard MC1.1. For more detailed information relating to programmed control of the Signal Generator, refer to Remote Operation, Hewlett-Packard Interface Bus in Section 3 of this manual.

1-6. OPTIONS

1-7. Electrical Options

Option 004. The Signal Generator's RF OUTPUT connector is located on the rear panel. Maximum output power is listed in Table 1-1.

Option 008. Option 008 provides +8 dBm level

DESCRIPTION (cont'd)**1-8. Mechanical Options**

The following options may have been ordered and received with the Signal Generator. If they were not ordered with the original shipment and are now desired, they can be ordered from the nearest Hewlett-Packard office using the part numbers included in each of the following paragraphs.

CAUTION

In the options below both English and metric screws are provided. If your instrument's frame is stamped with the word "Metric" or "M", use metric screws; otherwise use English screws. The use of incompatible screws will result in damage to the frame.

Option 006 (Chassis Slide Mount Kit). This kit is extremely useful when the Signal Generator is rack mounted. Access to the internal circuits and components, or the rear panel is possible without removing the Signal Generator from the rack. The chassis Slide Mount Kit part number is 1494-0059. An adapter is needed if the instrument rack mounting slides are to be mounted in a non-HP rack. The slides without the adapter can be directly mounted in the HP system enclosures. The adapter part number is 1494-0061.

Option 907. (Front Handle Kit). Ease of handling is increased with the front panel handles. The Front Handle Kit part number is 5061-9689.

Option 908 (Rack Flange Kit). The Signal Generator can be solidly mounted to the instrument rack without handles, using the flange kit. The Rack Flange Kit part number is 5061-9677.

Option 909 (Rack Flange and Front Handle Combination Kit). This is a unique part which combines both functions. It is not simply a front handle kit and a rack flange kit packaged together. The Rack Flange and Front Panel Combination Kit part number is 5061-9683.

1-9. Miscellaneous Options

Option 910. Provides a service manual and an extra operating manual.

Option 915. Provides a service manual.

Option 916. Provides an extra operating manual.

Option W30. Provides two additional years of return-to-HP service. The first year of normal warranty is combined with this extended service to provide three full continuous years of HP service. All repairs of failures due to defects in materials or workmanship, are covered under this extended service. Repair services do not include routine preventative maintenance or periodic calibrations of the instrument.

1-10. ACCESSORIES SUPPLIED

The accessories supplied with the Signal Generator are shown in Figure 1-1.

a. The line power cable is supplied in several configurations, depending on the destination of the original shipment. Refer to Power Cables in Section 2 of this manual.

b. An additional fuse is shipped only with instruments that are factory configured for 100/120 Vac operation. This fuse has a 2A rating for reconfiguring the instrument for 220/240 Vac operation.

c. Two adapters are provided: APC-3.5(F) to TYP-N(F), HP Part No. 1250-1745 and APC-3.5(F-F), HP Part No. 1250-1749.

1-11. EXTERNAL REFERENCE OSCILLATOR NOT SUPPLIED

An external reference oscillator may be used in place of the internal reference oscillator. The performance of the external reference should at least match the specifications of the internal reference oscillator. In particular, the frequency should be within ± 50 Hz of 10 MHz. When using an external oscillator, microphonically generated or line related spurious signals may increase. SSB phase noise may also be degraded at some offsets from the carrier.

1-12. ELECTRICAL EQUIPMENT AVAILABLE

The Signal Generator has an HP-IB interface and can be used with any HP-IB compatible computing controller or computer for automatic systems applications.

The HP-IB Controller and various ROM's are needed to do the automated SRD Bias, YTM Tune, Flatness and ALC adjustment procedures. Specific equipment needed for automated adjustments are:

ELECTRICAL EQUIPMENT AVAILABLE (cont'd)

- Test Cassette HP Part No. 11726-10002
- HP 85F Controller
- 82903A 16K Memory Module
- 00085-15005 Advanced Programming ROM
- 00085-15002 Plotter/Printer ROM
- 00085-15004 Matrix ROM
- HP 3455A Digital Voltmeter
- HP 436A/HP 8485A Power Meter and Sensor

Although the test cassette is part of the HP 11726A Support Kit, it can be ordered separately through the nearest Hewlett-Packard office. The HP 11726A Support Kit is available for maintaining and servicing the Signal Generator. It consists of cables, adapters, termination, and prerecorded programs, extender boards and test extender boards.

The Synthesizer Interface Cable, part number 5061-5391, provides an interface to the HP 8349B Microwave Amplifier. This provides calibrated output level under control of the system-compatible Signal Generator. This cable (as well as the HP 8349B Microwave Amplifier), is required for use with the HP 83550 family of frequency multipliers. For more information, see paragraph 3-2, System Compatibility.

1-13. RECOMMENDED TEST EQUIPMENT

Table 1-3 lists the test equipment recommended for testing, adjusting and servicing the Signal Generator. Table 1-4 lists the test equipment recommended for Abbreviated Performance Tests. Essential requirements for each piece of test equipment are described in the Critical Specifications column. Other equipment can be substituted if it meets or exceeds the critical specifications.

Table 1-1. Specifications (1 of 5)

Electrical Characteristics	Performance Limits	Conditions
<p>Note: Specifications and characteristics apply after a 1-hour warm-up, over the temperature range 0—55°C (except specifications for harmonically related spurious signals and RF output level, which apply over the range 15—35°C) after an AUTO-PEAK operation has been performed. For additional information concerning the use of AUTO PEAK, refer to paragraphs 3-12 and 3-13. Specifications for output flatness and absolute level accuracy apply only when internal leveling is used.</p>		
FREQUENCY		
Range	2.0—26.0 GHz (1.95—26.5 GHz overrange)	
Resolution	1 kHz 2 kHz 3 kHz 4 kHz	2.0 to 6.6 GHz >6.6 to 12.3 GHz >12.3 to 18.6 GHz >18.6 to 26.0 GHz
Accuracy and Stability	Same as reference oscillator	
Reference Oscillator: Frequency Aging Rate	10 MHz <5 x 10 ⁻¹⁰ /day	After warm-up (typically 24 hours in a normal operating environment)
Switching Time (for frequency to be within specified resolution and output power to be within 3 dB of set level)	<25 ms	AUTO PEAK disabled
SPECTRAL PURITY		
Single-sideband Phase Noise 2.0—6.6 GHz	-58 dBc -70 dBc -78 dBc -86 dBc -110 dBc	1 Hz bandwidth 10 Hz offset from carrier 100 Hz offset from carrier 1 kHz offset from carrier 10 kHz offset from carrier 100 kHz offset from carrier

Table 1-1. Specifications (2 of 5)

Electrical Characteristics	Performance Limits	Conditions
<p>SPECTRAL PURITY (cont'd)</p> <p>>6.6—12.3 GHz</p> <p>>12.3—18.6 GHz</p> <p>>18.6—26.0 GHz</p> <p>Harmonics</p> <p>Subharmonics and Multiples thereof</p> <p>For Option 008: Subharmonics and Multiples thereof</p> <p>Spurious Signals Nonharmonically Related</p> <p>Power line related and fan rotation related within 5 Hz below line frequencies and multiples thereof</p> <p>2.0—18.6 GHz</p> <p>>18.6—26.0 GHz</p>	<p>-52 dBc</p> <p>-64 dBc</p> <p>-72 dBc</p> <p>-80 dBc</p> <p>-104 dBc</p> <p>-48 dBc</p> <p>-60 dBc</p> <p>-68 dBc</p> <p>-76 dBc</p> <p>-100 dBc</p> <p>-46 dBc</p> <p>-58 dBc</p> <p>-66 dBc</p> <p>-74dBc</p> <p>-98 dBc</p> <p><-40 dBc</p> <p><-25 dBc</p> <p><-20 dBc</p> <p><-25 dBc</p> <p><-15 dBc</p> <p><-60 dBc</p> <p><-58 dBc</p> <p><-40 dBc</p> <p><-38 dBc</p>	<p>10 Hz offset from carrier</p> <p>100 Hz offset from carrier</p> <p>1 kHz offset from carrier</p> <p>10 kHz offset from carrier</p> <p>100 kHz offset from carrier</p> <p>10 Hz offset from carrier</p> <p>100 Hz offset from carrier</p> <p>1 kHz offset from carrier</p> <p>10 kHz offset from carrier</p> <p>100 kHz offset from carrier</p> <p>10 Hz offset from carrier</p> <p>100 Hz offset from carrier</p> <p>1 kHz offset from carrier</p> <p>10 kHz offset from carrier</p> <p>100 kHz offset from carrier</p> <p>Up to 26 GHz; output level at or below 0 dBm</p> <p>2.0 to 18.6 GHz</p> <p>18.6 to 26.0 GHz</p> <p>2.0 to 26 GHz</p> <p>18.6 to 26 GHz (1/2 and 3/4 subharmonics only)</p> <p>2.0 to 18.6 GHz</p> <p>>18.6 to 26.0 GHz</p>
<p>RF OUTPUT</p> <p>Output Level:</p> <p>Standard Leveled Output</p> <p>Option 004 Leveled Output</p> <p>Option 008 Level Output</p>	<p>+8 dBm to -100 dBm</p> <p>+4 dBm to -100 dBm</p> <p>+1 dBm to -100 dBm</p> <p>+7 dBm to -100 dBm</p> <p>+2 dBm to -100 dBm</p> <p>-1 dBm to -100 dBm</p> <p>+8 dBm to -100 dBm</p>	<p>+15 to +35°C</p> <p>2.0 to 18.0 GHz</p> <p>18.0 to 22.0 GHz</p> <p>22.0 to 26.0 GHz</p> <p>2.0 to 18.0 GHz</p> <p>18.0 to 22.0 GHz</p> <p>22.0 to 26.0 GHz</p> <p>2.0 to 26.0 GHz</p>

Table 1-1. Specifications (3 of 5)

Electrical Characteristics	Performance Limits	Conditions
RF OUTPUT (cont'd)		
Absolute Level Accuracy		+15 to +35°C
2.0 — 6.6 GHz	±1.25 dB	+10 dBm output level range (Highest)
	±1.00 dB	0 dBm output level range
	±1.50 dB	-10 dBm output level range
	±1.70 dB	-20 dBm output level range
	±2.00 dB	-30 dBm output level range
	±2.00 dB plus ±0.1 dB per 10 dB step below -30 dBm	<-30 dBm output range
>6.6 — 12.3 GHz	±1.50 dB	+10 dBm output level range (Highest)
	±1.25 dB	0 dBm output level range
	±1.75 dB	-10 dBm output level range
	±1.95 dB	-20 dBm output level range
	±2.25 dB	-30 dBm output level range
	±2.25 dB plus ±0.1 dB per 10 dB step below -30 dBm	<-30 dBm output range
>12.3 — 18.6 GHz	±1.75 dB	+10 dBm output level range (Highest)
	±1.50 dB	0 dBm output level range
	±2.10 dB	-10 dBm output level range
	±2.30 dB	-20 dBm output level range
	±2.70 dB	-30 dBm output level range
	±2.70 dB plus ±0.2 dB per 10 dB step below -30 dBm	<-30 dBm output range
>18.6 — 26.0 GHz	±2.25 dB	+10 dBm range (Opt. 008)
	±2.00 dB	0 dBm output level range
	±2.55 dB	-10 dBm output level range
	±2.85 dB	-20 dBm output level range
	±3.30 dB	-30 dBm output level range
	±3.30 dB plus ±0.2 dB per 10 dB step below -30 dBm	<-30 dBm output range
Remote Programming		
Output Level Resolution	0.1 dB	
For Option 008	0.1 dB	+7 to -100 dBm, plus 6 dB of overrange
Flatness		
	±0.75 dB	0 dBm range; +15 to +35°C
	±1.00 dB	2.0 to 6.6 GHz
	±1.25 dB	2.0 to 12.3 GHz
	±1.75 dB	2.0 to 18.6 GHz
		2.0 to 26.0 GHz
		(Min. to max. variation in power level across specified frequency limits is less than 2 times flatness spec.)
Output Level Switching Time	<25 ms	
(to be within ±1 dB of final level)		

Table 1-1. Specifications (4 of 5)

Electrical Characteristics	Performance Limits	Conditions
DIGITAL SWEEP Sweep Function Sweep Modes Step Size Sweep Width Dwell Time Markers	Start/Stop or ΔF (Span) Sweep Manual, Auto, Single Maximum 9999 frequency points per sweep; minimum step size equals Frequency Resolution Min: Frequency Resolution Max: 2.0 to 26.0 GHz Set from 1 to 255 ms per step 5 independent, fixed frequency markers set from front panel	Set directly or as number of points per sweep For Opt. 008, 16.0 to 26.0 GHz in AUTO only Resolution and accuracy are identical to RF output
REAR PANEL AUXILIARY CONTROL CONNECTOR 14-Pin Connector Input Required Outputs	<ul style="list-style-type: none"> · Trigger Output · Stop Sweep Input · End Sweep Output · Trigger Sweep Input · Negative Z-axis Blanking · Service Function · Frequency Increment · Frequency Decrement · Blank Frequency Display · Recall Register 1 · Sequential Register Recall · Ground Contact closure to ground or 5 μ s, negative true TTL pulse 5 μ s negative true TTL pulse	(Internal debounce circuit available to debounce external inputs.)
REMOTE PROGRAMMING	Interface Functions: SH1, AH1, T5, TE0, L3, LE0, SR1, RL1, PP1, DC1, DT1, C0, E1	All functions HP-IB programmable, except LINE switch
REAR PANEL CONNECTORS Frequency Reference Output Sweep Output Tone Marker Output Z-Axis Blanking Marker Penlift 10 MHz Output 100 MHz Output	0.5 V/GHz 0 to +10V ramp, start to stop 5 kHz sine wave output Z-Axis control for CRT Compatible with devices that have penlift control 0 dBm (nominal) into 50 ohms 0 dBm (nominal) into 50 ohms	

Table 1-1. Specifications (5 of 5)

Electrical Characteristics	Performance Limits	Conditions
GENERAL Operating Temperature Range Power Requirements: Line Voltage (100, 120, 220, or 240V) Power Dissipation Conducted and Radiated Electromagnetic Interference Net Weight Dimensions: Height Width Depth	0 to +55°C +5, -10% 400 V · A maximum MIL-STD 461A-1968 29 kg (64 lb) 146 mm (5.7 in.) 425 mm (16.8 in.) 620 mm (24.4 in.)	48-66 Hz Conducted and radiated interference is within the requirements of methods CE03 and RE02 of MIL-STD 461A, VDE 0871, and CISPR publication 11. For ordering cabinet accessories, module sizes are 5-1/4H, 1MW, 23D.

Table 1-2. Supplemental Characteristics

Supplemental characteristics are intended to provide information useful in applying the instrument by giving typical, but non-warranted, performance parameters.

FREQUENCY

Internal Reference: The internal reference oscillator accuracy is a function of time base calibration \pm aging rate, \pm temperature effects, and \pm line voltage effects. Typical temperature and line voltage effects are $<1 \times 10^{-10}/^{\circ}\text{C}$ and $<5 \times 10^{-10}/+5\%$ to -10% line voltage change. Reference oscillator is kept at operating temperature in STANDBY mode with the instrument connected to mains power. For instruments disconnected from mains power less than 24 hours, the aging rate is $<5 \times 10^{-10}/\text{day}$ after a 24-hour warm-up.

External Reference: 5 or 10 MHz at a level of 0.1 to 1 Vrms into 50 ohms. Stability and spectral purity of the microwave output will be partially determined by characteristics of the external reference frequency.

Reference Outputs: 10 MHz and 100 MHz at a level of 0.2 Vrms into 50 ohms.

SPECTRAL PURITY

Single-sideband Phase Noise (1 Hz BW, 2.0 to 6.6 GHz*):

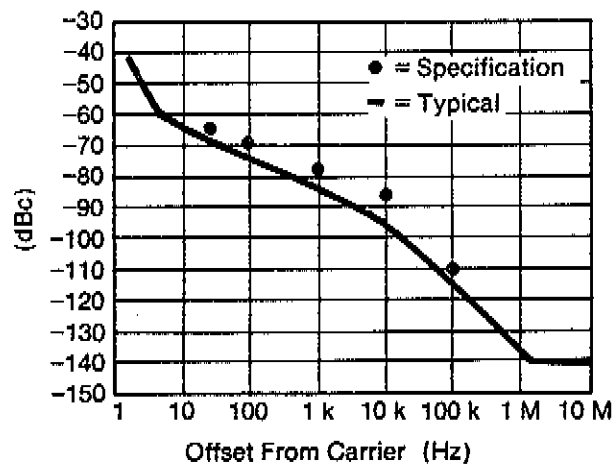

* Add 6 dB for 6.6 to 12.3 GHz, 10 dB for 12.3 to 18.6 GHz, and 12 dB for 18.6 to 26.0 GHz.

Residual FM, 2.0 to 6.6 GHz* (noise and power line related):

Post-Detection Bandwidth	Residual FM
300 Hz — 3 kHz	12 Hz rms
50 Hz — 15 kHz	60 Hz rms

* Residual FM doubles for 6.6 to 12.3 GHz, triples for 12.3 to 18.6 GHz, and quadruples for 18.6 to 26.0 GHz.

SPECTRAL PURITY

For power settings > 0 dBm, changes in frequency of several GHz in one step may require additional AUTO PEAK enabling to stabilize power at the desired level. Spurious output oscillations may occur for settings above +8 dBm.

External leveling device characteristics will determine output flatness, absolute level accuracy, and switching time in external leveling modes.

Impedance: 50 ohms

Source SWR: < 2.0

Output Level Accuracy:

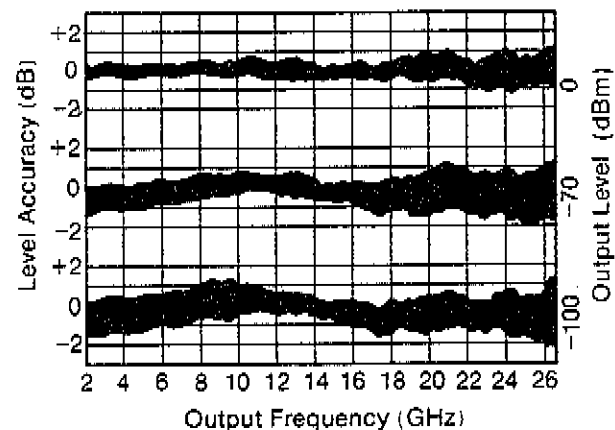

Typical HP 8673G output level accuracy at 0, -70, and -100 dBm level settings.

DIGITAL SWEEP

Rear Panel BNC Sweep Connections:

Sweep Out: 0 to +10V ramp start to stop (maximum adjustable from +4 to +12V)

Sweep Reference: 1 V/GHz ramp (+18V maximum)

Z-Axis Blanking/Markers

Tone Marker Output

Penlift

Table 1-3. Recommended Test Equipment (1 of 3)

Instrument	Critical Specifications	Recommended Model	Use*
ALC Amplifier	Special (see Figure 1-3)	Locally fabricated	A
Amplifier, 40 dB	Frequency: 100 kHz Gain: 45 ± 5 dB Output Power: > -10 dBm Impedance: 50 Ω	HP 8447F	P
Attenuator, Fixed 20 dB	Range: dc to 26 GHz Accuracy: ± 1.0 dB SWR: < 1.6	HP 8493C Option 020	P
Attenuator, 10 dB Step	Range: dc to 26 GHz Accuracy: $\pm 7\%$ SWR: < 2.2	HP 8495D Option 004	P
Cable, Special Interconnect	Special (see Figure 1-2)	Locally Fabricated	A
Controller, HP-IB	HP-IB compatibility as defined by IEEE Standard 488-1978 and the identical ANSI Standard MC1.1: SH1, AH1, T2, TE0, L2, LE0, SR0, RL0, PP0, DC0, DT0, and C1, 2, 3, 4, 5. Automated adjustment programs require specific test equipment. Therefore no substitute is recommended	HP 85A/82937A/ 00085-15001/ 00085-15002/ 00085-15003/ 00085-15004/ 00085-15005 or HP 85B/82937A/ 00085-15002, 00085-15004, 00085-15005	C, A
Crystal Detector	Frequency Range: 2 to 26 GHz Frequency Response: ± 1.5 dB	HP 8473C	P
Current Probe	Frequency Range: 2 to 35 MHz	HP 1110B	A
Digital Voltmeter	Automated adjustment programs require specific test equipment. No substitute is recommended.	HP 3456A or HP 3455A	A, T
Foam Pads (2 required)	43 x 58 cm (17 x 23 in.), 5 cm (2 in.) thick		P
Frequency Counter	Range: 10 MHz to 26.5 GHz Resolution: 100 Hz 10 MHz Frequency Standard Output: ≥ 0.1 Vrms	HP 5343A	P, A
Frequency Standard	Long Term Stability: Better than 10^{-10} /day	HP 5065A	P, A

Table 1-3. Recommended Test Equipment (2 of 3)

Instrument	Critical Specifications	Recommended Model	Use*
Logic Pulser	TTL compatible	HP 546A	T
Mixer	Response: 1 to 26 GHz VSWR, LO: < 2.5:1 VSWR, RF: < 4.0:1	RHG DMS1-26 ¹	P
Oscilloscope	Bandwidth: 100 MHz Vertical Sensitivity: 5 mV/div Vertical Input: ac, dc or 50Ω dc coupled External Trigger Capability Delayed Sweep Capability One-Shot Digitizer	HP 1980B/19860A	C, P, A, T
Power Meter	Automated adjustment programs require specific test equipment. Therefore, no substitute is recommended.	HP 436A	P, A
Power Sensor	Frequency Range: 2 to 26 GHz Input Impedance: 50Ω SWR: < 1.25 Must be compatible with power meter	HP 8485A	P, A
Power Source, Variable Frequency AC	Range: 60 Vac to 240 Vac Frequency: 48 to 400 Hz Accuracy ± 2 Hz	California Instruments 501TC/800T ²	P
Power Supply	0 to 40 Vdc	HP 6200B	A, T
Probe, 10:1	Must be compatible with the oscilloscope.	HP 10081A	C, P, A
Pulse Generator	Rate: 10 Hz to 4 MHz Rise and Fall Times: < 5 ns Output Impedance: 50Ω Output Level: 0 to 3.5V Pulse Width: 80 ns to 2 μs	HP 8116A or HP 8013B	C
Signature Analyzer	Because signatures depend upon the model selected, only the models listed are approved for usage.	HP 5005A/B, HP 5006A	T
Spectrum Analyzer	Frequency Range: 20 Hz to 300 kHz Resolution Bandwidth: 3 Hz minimum Frequency Span/Division: 20 Hz minimum Noise Sidebands: > 90 dB below CW signal, 3 kHz offset, 100 Hz IF bandwidth Input Level Range: 0 to -70 dBm Log Reference: 70 dB dynamic range in 10 dB steps Accuracy: ± 0.2 dB Tracking Generator: 0 dBm to -11 dBm	HP 3585A	P, A, T

Table 1-3. Recommended Test Equipment (3 of 3)

Instrument	Critical Specifications	Recommended Model	Use*
Spectrum Analyzer System	Frequency Range: 10 MHz to 22 GHz Frequency Span/Division: 1 kHz minimum Amplitude Range: 0 to -70 dB Noise Sideband: > 75 dB down 30 kHz from signal at 1 kHz resolution bandwidth	HP 8566B	P, A
Support Kit	Required for servicing and troubleshooting.	HP 11726A	A, T
Sweep Oscillator	Center Frequency: 150 to 200 MHz Center Frequency Resolution: 0.1 MHz Sweep Range: 10 and 200 MHz	HP 8340A or HP 86222B/8620C	A
Termination 50Ω	50Ω APC-3.5 (f)	HP 909D Opt. 011	A
Test Oscillator	Level: 0 to 3V into 50Ω or 300Ω Range: 10 kHz to 10 MHz	HP 3335A	C, A
<p>* C = Operator's Check, P = Performance Tests, A = Adjustments, T = Troubleshooting</p> <p>¹ RHG Electronics Laboratory, Inc., 161 East Industry Court, Deer Park, NY 11729, Tel. (516) 242-1100, TWX 510-227-6083.</p> <p>² California Instruments, 5150 Convoy Street, San Diego, CA 92111, Tel. (714) 279-8620.</p>			

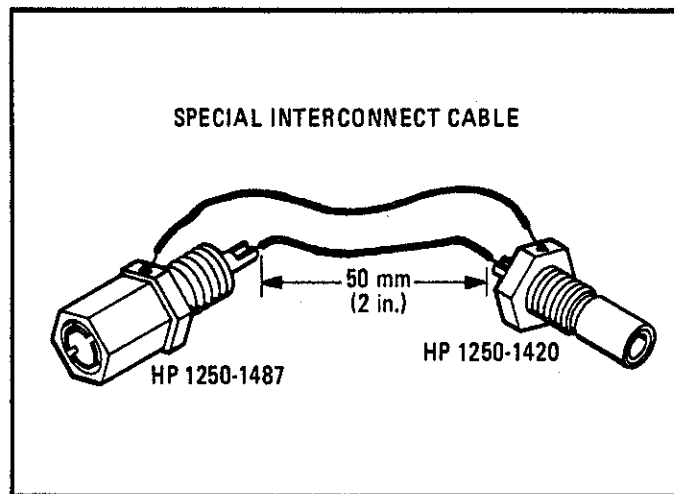
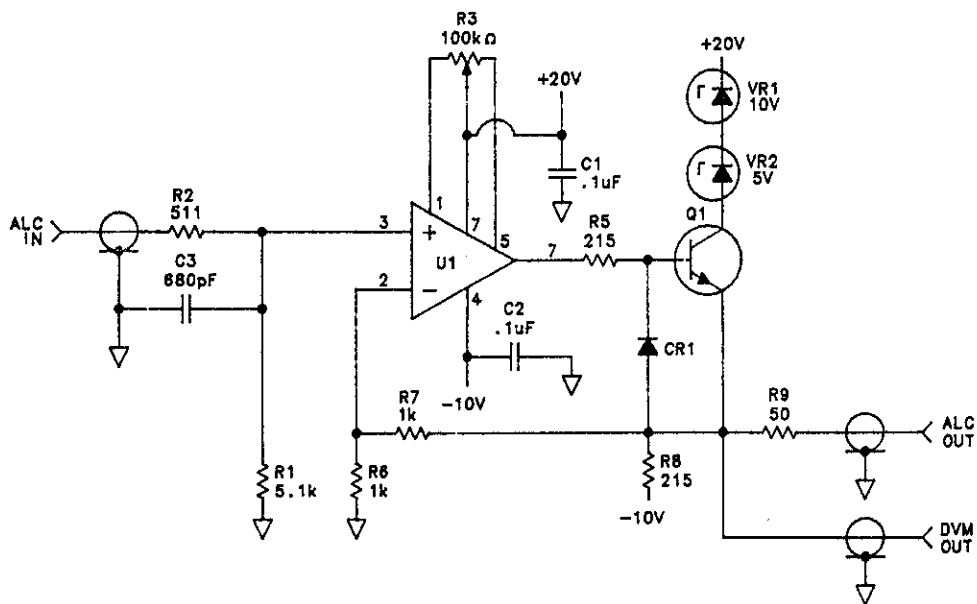

Figure 1-2. Special Interconnect Cable



Material List

R1	5.11k Ω , 1%, .125W	HP 0757-0438
R2	511 Ω , 1%, .125W	HP 0757-0416
R3	100k Ω , variable	HP 2100-3094
R5	215 Ω , 1%, .05W	HP 0698-7220
R6	1k Ω , 1%, .125W	HP 0757-0280
R7	1k Ω , 1%, .125W	HP 0757-0280
R8	215 Ω , 1%, 5W	HP 0698-3401
R9	50 Ω , 1%, .1W	HP 0699-0452
C1	0.1 μ F	HP 0160-0576
C2	0.1 μ F	HP 0160-0576
C3	680pF	HP 0160-4824
CR1	Switching Diode	HP 1901-0050
U1	Operational Amplifier	HP 1826-0413
Q1	2N5943, NPN .125W	HP 1854-0597
VR1	Zener Diode, 10V	HP 1902-0958
VR2	Zener Diode, 5.1V	HP 1902-0951

Figure 1-3. External ALC Amplifier

Table 1-4. Abbreviated Performance Test Recommended Test Equipment

Instrument	Critical Specifications	Recommended Model
Attenuator, Fixed 20 dB	Range: dc to 26 GHz Accuracy: ± 1.0 dB SWR: < 1.6	HP 8493C Option 020
Frequency Counter	Range: 10 MHz to 26.5 GHz Resolution: 100 Hz 10 MHz Frequency Standard Output ≥ 1 Vrms	HP 5340A or HP 5343A
Local Oscillator	Range: 2 GHz to 19 GHz Level: $> +5$ dBm	HP 8340A
Mixer	Response: 1 to 26 GHz VSWR, LO: $\leq 2.5:1$ VSWR, RF: $\leq 4.0:1$	RHG DMS1-26 ¹
Power Meter and Sensor	Frequency Range: 50 MHz to 26 GHz Input Impedance: 50 Ω SWR: < 1.25 Max Input Level: 15 dBm	HP 436A/HP 8485A
40 dB Power Amp	Power Amp Frequency: 100 kHz Gain: 45 ± 5 dB Output Power: > -10 dBm Impedance: 50 Ω	HP 8447F
Spectrum Analyzer	Frequency Range: 50 MHz to 7 GHz Frequency Span/Division: 1 kHz minimum Amplitude Range: 0 to -70 dB	HP 8566B

¹ RHG Electronics Laboratory, Inc., 161 East Industry Court, Deer Park, NY 11729, Tel. (516) 242-1100, TWX 510-227-6083.

SECTION 4 PERFORMANCE TESTS

4-1. INTRODUCTION

The procedures in this section test the instrument's electrical performance using the specifications of Table 1-1 as the performance standards. These tests are suitable for incoming inspection, troubleshooting, and preventive maintenance. All tests can be performed without accessing the interior of the instrument. A simpler operational test is included in Section 3 under Operator's Checks.

NOTE

To consider the performance tests valid, the following conditions must be met:

- a. The Signal Generator must have a 1-hour warm-up for all specifications.*
- b. The line voltage must be 100, 120, 220, or 240 Vac +5%, -10%.*
- c. The ambient temperature must be +15 to +35°C for Harmonically Related Spurious signals, RF Output Level; 0 to 55°C for all other tests.*

4-2. ABBREVIATED PERFORMANCE TEST

In most cases, it is not necessary to perform all of the tests in this section. Paragraph 4-7 contains the abbreviated performance tests. These tests can be used for operation verification. Results of these tests may be recorded in Table 4-1, Abbreviated Performance Test Record.

These tests can also be used for incoming inspections and preventative maintenance. They are not intended to be a complete check of specifications, but will provide 90% confidence that the Signal Generator is meeting its major performance specifications. These tests can be performed with less time and equipment than the full Performance Tests.

4-3. CALIBRATION CYCLE

This instrument requires periodic verification of performance to ensure that it is operating within

specified tolerances. The performance tests described in this section should be performed at least once each year; under conditions of heavy usage or severe operating environments, the tests should be more frequent. Adjustments that may be required are described in Section 5, Adjustments. Annual and biannual cleaning procedures are detailed in Section 8, Service.

4-4. PERFORMANCE TEST RECORD

Results of the performance tests may be tabulated in Table 4-4, Performance Test Record. The Performance Test Record lists all of the performance test specifications and the acceptable limits for each specification. If performance test results are recorded during an incoming inspection of the instrument, they can be used for comparison during periodic maintenance or troubleshooting. The test results may also prove useful in verifying proper adjustments after repairs are made.

4-5. EQUIPMENT REQUIRED

Equipment required for the performance tests is listed in Table 1-3, Recommended Test Equipment. Any equipment that satisfies the critical specifications given in the table may be substituted.

4-6. TEST PROCEDURES

It is assumed that the person performing the following tests understands how to operate the specified test equipment. Equipment settings, other than those for the Signal Generator, are stated in general terms. For example, a test might require that a spectrum analyzer's resolution bandwidth be set to 100 Hz; however, the sweep time would not be specified and the operator would be expected to set that control and other controls as required to obtain an optimum display. It is also assumed that the technician will select the cables, adapters, and probes required to complete the test setups illustrated in this section.

ABBREVIATED PERFORMANCE TESTS

4-7. ABBREVIATED PERFORMANCE TESTS**TURN-ON CHECKS****Procedure**

1. Set the LINE switch to ON.
2. Ensure that the message key indicator is not flashing. If the message key indicator is flashing, refer to "Messages" in Section 3's Detailed Operating Instructions.
3. Press RCL 0. Verify that the instrument is now preset to the following conditions:
 - RF OUTPUT to ON
 - ALC to INTERNAL
 - OUTPUT LEVEL RANGE to -70 dB
 - AUTO PEAK to ON
 - FREQUENCY to 3000.000 MHz
 - FREQ INCR to 1.000 MHz
 - START to 2000.000 MHz
 - STOP to 4000.000 MHz
 - ΔF to 2000.000 MHz
 - SWEEP mode to OFF
 - STEP to 100 Steps (20.000 MHz)
 - DWELL to 20 ms
 - TUNE Knob to ON
 - All Status Annunciators off
 - MESSAGE key indicator off

ABBREVIATED PERFORMANCE TESTS

FREQUENCY RANGE AND RESOLUTION TEST

- Description** This test checks the tuning resolution and phase lock capabilities of the baseband (2.0 to 6.6 GHz) frequency generation circuitry using a frequency counter.
- Equipment** Frequency Counter HP 5343A

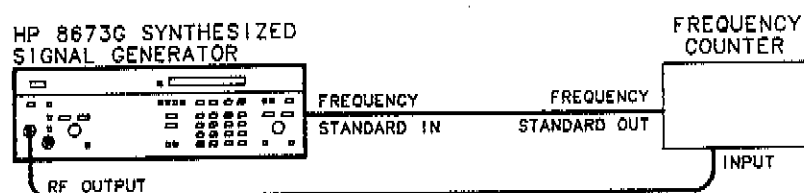

Figure 4-1. Frequency Range and Resolution Test Setup

Procedure

1. Connect the equipment as shown in Figure 4-1. Set the Signal Generator rear panel **FREQ STANDARD INT/EXT** switch to **EXT**. Remove the **FREQ STANDARD** jumper and connect **A3J10** to the 10 MHz frequency standard output of the frequency counter. With the Signal Generator and the frequency counter sharing a common timebase, the frequency counter should agree with the Signal Generator **FREQUENCY MHz** display ± 1 count with any selected frequency counter resolution.
2. Select 1 kHz display resolution on the frequency counter.
3. Press **RCL0** on the Signal Generator. Tune the Signal Generator to 2000 MHz at an output level of 0 dBm.
4. Verify that the frequency counter reads 2000.000 MHz ± 1 count (due to the accuracy of the frequency counter).

1999.999 MHz _____ 2000.001 MHz
5. Tune the Signal Generator to each of the frequencies listed in the following table. Verify that the ϕ **UNLOCKED** annunciator remains off at each frequency and that the frequency counter agrees with the Signal Generator **FREQUENCY MHz** display ± 1 count. Record the readings.

NOTE

Fast tuning of the frequency may cause the ϕ UNLOCKED annunciator to flash on momentarily. This is normal and does not indicate a malfunction.

ABBREVIATED PERFORMANCE TESTS

FREQUENCY RANGE AND RESOLUTION TEST (cont'd)Procedure
(cont'd)

Frequency (MHz)	Minimum Frequency (MHz)	Actual Frequency (MHz)	Maximum Frequency (MHz)
2 090.000	2 089.999	_____	2 090.001
2 280.001	2 280.000	_____	2 280.002
2 471.112	2 471.111	_____	2 471.113
2 662.223	2 662.222	_____	2 662.224
2 853.334	2 853.333	_____	2 853.335
3 044.445	3 044.444	_____	3 044.446
3 235.556	3 235.555	_____	3 235.557
3 426.667	3 426.666	_____	3 426.668
3 617.778	3 617.777	_____	3 617.779
3 808.889	3 808.888	_____	3 808.890
3 999.999	3 999.998	_____	4 000.000
4 180.000	4 179.999	_____	4 180.001
4 370.000	4 369.999	_____	4 370.001
4 560.000	4 559.999	_____	4 560.001
4 750.000	4 749.999	_____	4 750.001
4 940.000	4 939.999	_____	4 940.001
5 130.000	5 129.999	_____	5 130.001
5 320.000	5 319.999	_____	5 320.001
5 510.000	5 509.999	_____	5 510.001
5 700.000	5 699.999	_____	5 700.001
5 900.000	5 899.999	_____	5 900.001
6 100.000	6 099.999	_____	6 100.001
6 600.000	5 999.999	_____	6 600.001

ABBREVIATED PERFORMANCE TESTS

OUTPUT LEVEL AND FLATNESS TESTS

Description This test checks output level (maximum leveled power) and output level flatness. The output level test uses a power meter to verify that the specified maximum leveled output power can be generated over the full frequency range. Level flatness measures the variation in output power level as the frequency is changed.

Equipment Power Meter HP 436A
 Power Sensor HP 8485A

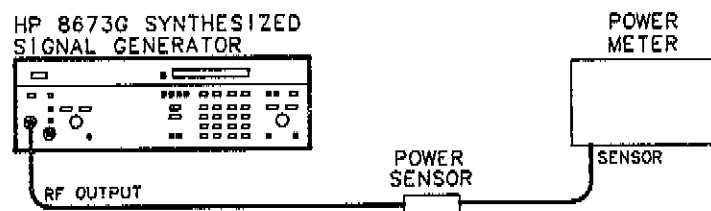

Figure 4-2. Output Level and Flatness Test Setup

Procedure

Output Level Test

1. Connect the equipment as shown in Figure 4-2.
2. Zero and calibrate the power meter.
3. Tune the Signal Generator frequency to 2000.0 MHz.
4. Set the OUTPUT LEVEL RANGE and VERNIER for a power meter reading of +8 dBm (+7 dBm for Option 004).
5. Peak the Signal Generator output with the AUTO PEAK key.
6. Tune the Signal Generator in 100 MHz steps from 2.0 to 18.0 GHz while observing the power meter readings. Record the frequency at which minimum power occurs.

Frequency _____

7. Tune the Signal Generator to the recorded frequency. Adjust the VERNIER for a power meter reading of +8 dBm (+7 dBm for Option 004).
8. Tune the Signal Generator from 2.0 GHz to 18.0 GHz in 100 MHz steps while observing the power meter readings. Ensure that the specified maximum leveled output power level is met.
9. Adjust the VERNIER for a power meter reading of +4 dBm (+2 dBm for Option 004, +8 dBm for Option 008). Then press AUTO PEAK.
10. Tune the CW Generator in 200 MHz steps from 18.0 to 22.0 GHz while observing the power meter readings. Record the frequency at which minimum power occurs.

Frequency _____

ABBREVIATED PERFORMANCE TESTS

OUTPUT LEVEL AND FLATNESS TESTS (cont'd)**Procedure
(cont'd)****Output Level Test**

11. Tune the CW Generator to the recorded frequency. Adjust the VERNIER for a power meter reading of +4 dBm (+2 dBm for Option 004, +8 dBm for Option 008).
12. Tune the CW Generator from 18.0 to 22.0 GHz in 200 MHz steps while observing the power meter reading. Ensure that the specified maximum leveled output power level is met.
13. Adjust the VERNIER for a power meter reading of +1 dBm (-1 dBm for Option 004, +8 dBm for Option 008). Then press AUTO PEAK.
14. Tune the CW Generator in 200 MHz steps from 22.0 to 26.0 GHz while observing the power meter reading. Record the frequency at which minimum power occurs.

Frequency _____

15. Tune the CW Generator to the recorded frequency. Adjust the VERNIER for a power meter reading of +1 dBm (-1 dBm for Option 004, +8 dBm for Option 008).
16. Tune the CW Generator from 22.0 to 26.0 GHz in 200 MHz steps while observing the power meter reading. Ensure that the specified maximum leveled output power level is met.

Level Flatness Test**NOTE**

The flatness specification for power output is not referenced to a particular frequency. The specification represents the total power variation over the entire frequency range.

17. Tune the Signal Generator to 2.0 GHz. Set the OUTPUT LEVEL RANGE and VERNIER for a power meter reading of -5 dBm.
 18. Set the power meter mode to dB Relative.
 19. Tune the Signal Generator from 2.0 to 6.6 GHz in 100 MHz steps while observing the power meter readings. Record the minimum and maximum output power levels in the following table. Maximum power variation must be within 1.5 dB (highest point to lowest point).
 20. Continue tuning the Signal Generator to 12.3 GHz in 100 MHz steps while observing the power meter readings. Maximum power variation must be within 2.0 dB. Record the minimum and maximum output power levels in the following table.
 21. Continue tuning the Signal Generator to 18.6 GHz in 100 MHz steps while observing the power meter readings. Maximum power variation must be within 2.5 dB. Record the minimum and maximum output power levels in the following table.
 22. Continue tuning the Signal Generator to 26.0 GHz in 100 MHz steps while observing the power meter readings. Maximum power variation must be within 3.5 dB. Record the minimum and maximum output power levels in the following table.
-

ABBREVIATED PERFORMANCE TESTS

OUTPUT LEVEL AND FLATNESS TESTS (cont'd)**Procedure
(cont'd)**

Frequency Range	Power Variation
2.0 — 6.6 GHz	Maximum _____ Minimum _____ Total Variation _____ 1.50 dB
2.0 — 12.3 GHz	Maximum _____ Minimum _____ Total Variation _____ 2.00 dB
2.0 — 18.6 GHz	Maximum _____ Minimum _____ Total Variation _____ 2.5 dB
2.0 — 26.0 GHz	Maximum _____ Minimum _____ Total Variation _____ 3.5 dB

ABBREVIATED PERFORMANCE TESTS

LEVEL ACCURACY TESTS

Description This test checks level accuracy of the RF output signal. The first test uses a power meter to verify that power levels between 0 dBm and -20 dBm are within specification. Power levels of -30 dBm and below are checked using a spectrum analyzer. The output level of the Signal Generator is adjusted to -20 dBm using the power meter. The Signal Generator output is then mixed with a local oscillator to produce an IF frequency. The IF frequency is displayed on the spectrum analyzer. A reference level corresponding to the -20 dBm output is set on the spectrum analyzer and each 10 dB decrease in range is checked for a 10 dB decrease on the spectrum analyzer display.

Equipment	Power Meter	HP 436A
	Power Sensor	HP 8485A
	Local Oscillator	HP 8340A
	Mixer	RHG DMS1-26
	Spectrum Analyzer	HP 8566B
	40 dB Amplifier	HP 8447F
	20 dB Attenuator	HP 8493C Option 020

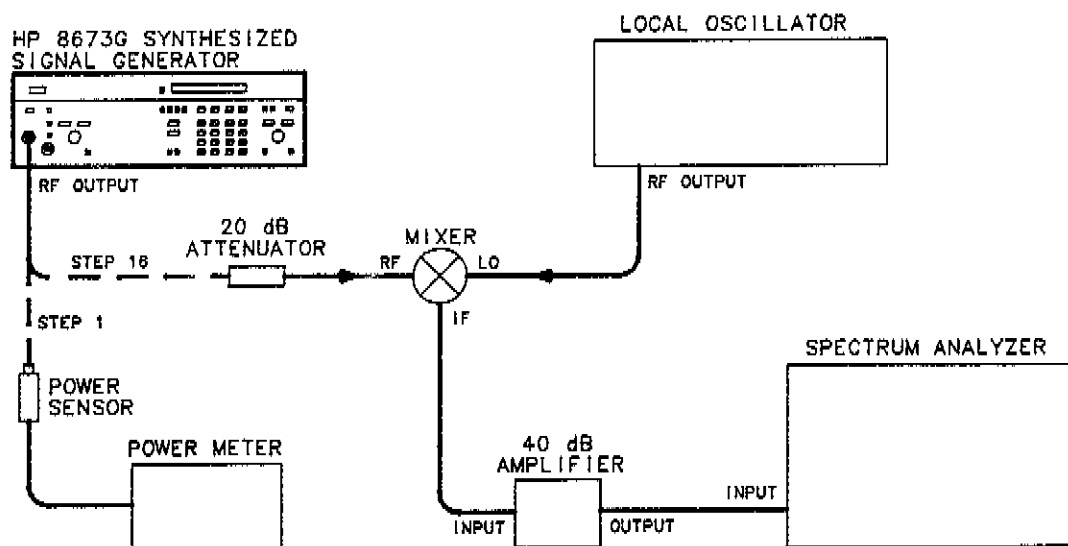

Figure 4-3. Level Accuracy Test Setup

Procedure

High Level Accuracy Test

1. Zero and calibrate the power meter. Set the power meter to dBm mode.
2. Connect the Signal Generator to the power meter as shown in Figure 4-3.
3. Tune the Signal Generator to 2.0 GHz.
4. Set the OUTPUT LEVEL to 0 dBm using the second RANGE position (that is, the 0 dB RANGE position).
5. Peak the Signal Generator output with the AUTO PEAK key.

ABBREVIATED PERFORMANCE TESTS

LEVEL ACCURACY TESTS (cont'd)**Procedure
(cont'd)****High Level Accuracy Test (cont'd)**

6. Observe the power meter reading. The reading should be within the limits specified.
Record the reading.

(2.0 GHz, 0 dBm) -1.00 dBm _____ +1.00 dBm

7. Adjust the Signal Generator's VERNIER for a front panel meter reading of -10 dBm.

8. Observe the power meter reading. The reading should be within the limits specified.
Record the reading.

(2.0 GHz, -10 dBm) -11.00 dBm _____ -9.00 dBm

9. Tune the Signal Generator to 18.6 GHz.

10. Adjust the VERNIER for a front panel meter reading of 0 dBm.

11. Observe the power meter reading. The reading should be within the specified limits.
Record the reading.

(18.6 GHz, 0 dBm) -1.50 dBm _____ +1.50 dBm

12. Adjust the Signal Generator's RANGE one position lower (that is, the third RANGE position or -10 dB).

13. Observe the power meter reading. The reading should be within the limits specified.
Record the reading.

(18.6 GHz, -10 dBm) -12.10 dBm _____ -7.90 dBm

14. Adjust the RANGE one position lower (that is, the fourth RANGE position or -20 dB).

15. Observe the power meter reading. The reading should be within the limits specified.
Record the reading.

(18.6 GHz, -20 dBm) -22.30 dBm _____ -17.70 dBm

Low Level Accuracy Test

16. Disconnect the power meter and connect the Signal Generator to the attenuator and mixer as shown in Figure 4-3.

NOTE

Connect the mixer directly to the local oscillator to avoid any power loss.

17. Tune the local oscillator to 18.7 GHz. Set the output power to +7 dBm.

18. Set the resolution bandwidth on the spectrum analyzer to 300 Hz or less. Adjust the vertical sensitivity to place the peak of the 100 kHz IF signal on the center horizontal graticule line. This calibrates the center graticule line for an absolute reference power level of -20 dBm.
-

ABBREVIATED PERFORMANCE TESTS

LEVEL ACCURACY TESTS (cont'd)**Procedure
(cont'd)****Low Level Accuracy Test (cont'd)**

19. Set the RANGE of the Signal Generator 10 dB lower and adjust the VERNIER for a front panel reading of 0 dBm.
20. Set the spectrum analyzer reference level 10 dB lower to bring the signal level near the reference graticule line.
21. Read the difference between the new signal level and the center reference graticule line. Calculate the actual power as follows:

NOTE

The difference is positive if the signal is above the reference graticule; negative if below.

$$\begin{aligned} & \text{_____ Output level set in step 18.} \\ + & \text{_____ Difference measured in step 21.} \\ & \text{_____ Actual level.} \end{aligned}$$

Record the actual level calculated in the following table. The level reading should be within the limits specified.

22. Repeat steps 19 through 21 with Signal Generator RANGE settings of -40 dB and -50 dB in step 19. Record the output level readings in the following table.
23. Note the Signal Generator's signal level (at -50 dBm) on the spectrum analyzer display. Remove the 20 dB attenuator, set the spectrum analyzer's IF sensitivity 20 dB higher, and reset the vertical sensitivity to the level noted before removing the 20 dB attenuator.
24. Repeat steps 19 through 21 with Signal Generator RANGE settings of -60 dB through -90 dB. Record the output level readings in the following table.

Test	Results		
	Min	Actual	Max
18.6 GHz			
-30 dBm	-32.70 dBm	_____	-27.30 dBm
-40 dBm	-42.90 dBm	_____	-37.10 dBm
-50 dBm	-53.10 dBm	_____	-46.90 dBm
-60 dBm	-63.30 dBm	_____	-56.70 dBm
-70 dBm	-73.50 dBm	_____	-66.50 dBm
-80 dBm	-83.70 dBm	_____	-76.30 dBm
-90 dBm	-94.90 dBm	_____	-86.10 dBm

Table 4-1. Abbreviated Performance Test Record (1 of 2)

Test	Results		
	Min.	Actual	Max.
FREQUENCY RANGE AND RESOLUTION			
Baseband Test			
2 000.000 MHz	1 999.999	_____	2 000.001
2 090.000 MHz	2 089.999	_____	2 090.001
2 280.001 MHz	2 280.000	_____	2 280.002
2 471.112 MHz	2 471.111	_____	2 471.113
2 662.223 MHz	2 662.222	_____	2 662.224
2 853.334 MHz	2 853.333	_____	2 853.335
3 044.445 MHz	2 044.444	_____	3 044.446
3 235.556 MHz	3 235.555	_____	3 235.557
3 426.667 MHz	3 426.666	_____	3 426.668
3 617.778 MHz	3 617.777	_____	3 617.776
3 808.889 MHz	3 808.888	_____	3 808.890
3 999.999 MHz	3 999.998	_____	4 000.000
4 180.000 MHz	4 179.999	_____	4 180.001
4 370.000 MHz	4 369.999	_____	4 370.001
4 560.000 MHz	4 559.999	_____	4 560.001
4 750.000 MHz	4 749.999	_____	4 750.001
4 940.000 MHz	4 939.999	_____	4 940.001
5 130.000 MHz	5 129.999	_____	5 130.001
5 320.000 MHz	5 319.999	_____	5 320.001
5 510.000 MHz	5 509.999	_____	5 510.001
5 700.000 MHz	5 699.999	_____	5 700.001
5 900.000 MHz	5 899.999	_____	5 900.001
6 100.000 MHz	6 099.999	_____	6 100.001
6 600.000 MHz	5 999.999	_____	6 600.001
OUTPUT LEVEL AND FLATNESS			
Output Level			
Frequency and Power at Minimum Power Point			
2.0—18.0 GHz			
Frequency _____			
Minimum Power	(Standard)	+8 dBm	_____ (✓)
	(Option 004)	+7 dBm	_____ (✓)
	(Option 008)	+8 dBm	_____ (✓)
18.0—22.0 GHz			
Frequency _____			
Minimum Power	(Standard)	+4 dBm	_____ (✓)
	(Option 004)	+2 dBm	_____ (✓)
	(Option 008)	+8 dBm	_____ (✓)
22.0—26.0 GHz			
Frequency _____			
Minimum Power	(Standard)	+1 dBm	_____ (✓)
	(Option 004)	-1 dBm	_____ (✓)
	(Option 008)	+8 dBm	_____ (✓)

Table 4-1. Abbreviated Performance Test Record (2 of 2)

Test	Results		
	Min.	Actual	Max.
OUTPUT LEVEL AND FLATNESS (cont'd)			
Level Flatness (total variation)			
2.0–6.6 GHz, ± 0.75 dB		_____	1.50 dB
2.0–12.3 GHz, ± 1.00 dB		_____	2.00 dB
2.0–18.6 GHz, ± 1.25 dB		_____	2.50 dB
2.0–26.0 GHz, ± 1.75 dB		_____	3.50 dB
LEVEL ACCURACY			
High Level Accuracy			
2.0 GHz, 0 dBm	-1.00 dBm	_____	+1.00 dBm
2.0 GHz, -10 dBm	-11.00 dBm	_____	-9.00 dBm
18.6 GHz, 0 dBm	-1.50 dBm	_____	+1.50 dBm
18.6 GHz, -10 dBm	-12.10 dBm	_____	-7.90 dBm
18.6 GHz, -20 dBm	-22.30 dBm	_____	-17.70 dBm
Low Level Accuracy			
18.6 GHz			
-30 dBm	-32.70 dBm	_____	-27.30 dBm
-40 dBm	-42.90 dBm	_____	-37.10 dBm
-50 dBm	-53.10 dBm	_____	-46.90 dBm
-60 dBm	-63.30 dBm	_____	-56.70 dBm
-70 dBm	-73.50 dBm	_____	-66.50 dBm
-80 dBm	-83.70 dBm	_____	-76.30 dBm
-90 dBm	-94.90 dBm	_____	-86.10 dBm

PERFORMANCE TESTS

4-8. FREQUENCY RANGE AND RESOLUTION TEST

Specification

Electrical Characteristics	Performance Limits	Conditions
FREQUENCY Range	2.0—26.0 GHz (1.95—26.5 GHz Overrange)	
Resolution	1 kHz 2 kHz 3 kHz 4 kHz	2.0 to 6.6 GHz >6.6 to 12.3 GHz >12.3 to 18.6 GHz >18.6 to 26.0 GHz

Description

This test checks the tuning resolution in each of four internal frequency bands using a frequency counter. The performance test is divided into a baseband check (2.0 to 6.6 GHz) and a check for bands 2, 3, and 4 (6.6 to 12.3 GHz, 12.3 to 18.6 GHz and 18.6 to 26.0 GHz respectively).

Equipment

Frequency Counter HP 5343A

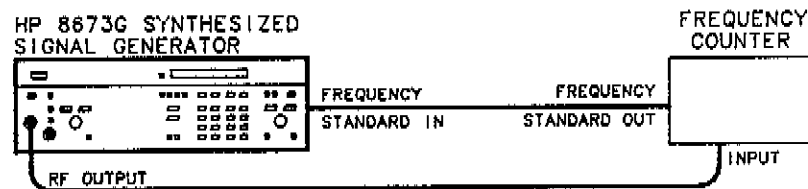

Figure 4-4. Frequency Range and Resolution Test Setup

Procedure

Baseband Test

1. Connect the equipment as shown in Figure 4-4. Set the Signal Generator rear panel FREQ STANDARD INT/EXT switch to EXT. Remove the FREQ STANDARD jumper and connect A3J10 to the 10 MHz frequency standard output of the frequency counter. With the Signal Generator and the frequency counter sharing a common timebase, the frequency counter should agree with the Signal Generator FREQUENCY MHz display ± 1 count with any selected frequency counter resolution.
2. Select 1 kHz display resolution on the frequency counter.
3. Press RCL 0 on the Signal Generator. Set the Signal Generator to 2000 MHz at an output level of 0 dBm.
4. Verify that the frequency counter reads 2 000.000 MHz ± 1 count (due to the accuracy of the frequency counter).

1 999.999 MHz _____ 2 000.001 MHz

PERFORMANCE TESTS

FREQUENCY RANGE AND RESOLUTION TEST (cont'd)**Procedure
(cont'd)**

5. Set the Signal Generator frequency increment to 1 kHz. Using the TUNE knob, tune the Signal Generator to each of the frequencies listed below. Verify that the ϕ UNLOCKED annunciator remains off at each frequency and that the frequency counter agrees with the Signal Generator FREQUENCY MHz display ± 1 count.

Frequency (MHz)	Minimum Frequency (MHz)	Actual Frequency (MHz)	Maximum Frequency (MHz)
2 000.001	2 000.000	_____	2 000.002
2 001.112	2 001.111	_____	2 001.113
2 002.223	2 002.222	_____	2 002.224
2 003.334	2 003.333	_____	2 003.335
2 004.445	2 004.444	_____	2 004.446
2 005.556	2 005.555	_____	2 005.557
2 006.667	2 006.666	_____	2 006.668
2 007.778	2 007.777	_____	2 007.779
2 008.889	2 008.888	_____	2 008.890
2 009.999	2 009.998	_____	2 010.000

6. Set the Signal Generator frequency increment to 10.000 MHz. Using the TUNE knob, tune the Signal Generator to each of the frequencies listed below. Verify that the ϕ UNLOCKED annunciator remains off at each frequency and that the frequency counter agrees with the Signal Generator FREQUENCY MHz display ± 1 count.

Frequency (MHz)	Minimum Frequency (MHz)	Actual Frequency (MHz)	Maximum Frequency (MHz)
2 090.000	2 089.999	_____	2 090.001
2 280.000	2 279.999	_____	2 280.001
2 470.000	2 469.999	_____	2 470.001
2 660.000	2 659.999	_____	2 660.001
2 850.000	2 849.999	_____	2 850.001
3 040.000	3 039.999	_____	3 040.001
3 230.000	3 229.999	_____	3 230.001
3 420.000	3 419.999	_____	3 420.001
3 610.000	3 609.999	_____	3 610.001
3 800.000	3 799.999	_____	3 800.001
3 990.000	3 989.999	_____	3 990.001
4 180.000	4 179.999	_____	4 180.001
4 370.000	4 369.999	_____	4 370.001
4 560.000	4 559.999	_____	4 560.001
4 750.000	4 749.999	_____	4 750.001
4 940.000	4 939.999	_____	4 940.001
5 130.000	5 129.999	_____	5 130.001
5 320.000	5 319.999	_____	5 320.001
5 510.000	5 509.999	_____	5 510.001
5 700.000	5 699.999	_____	5 700.001
5 900.000	5 899.999	_____	5 900.001
6 100.000	6 099.999	_____	6 100.001
6 600.000	5 999.999	_____	6 600.001

PERFORMANCE TESTS

FREQUENCY RANGE AND RESOLUTION TEST (cont'd)**Procedure
(cont'd)****NOTE**

Fast tuning of frequency may cause the ϕ UNLOCKED annunciator to flash on momentarily. This is normal and does not indicate a malfunction.

Bands 2 and 3 Test

7. Tune the Signal Generator to 10 000.000 MHz and set the frequency increment (FREQ INCR) to 1 kHz.
8. Tune the frequency down one increment and verify that the Signal Generator frequency display changes to 9 999.998 MHz and the frequency counter reading agrees within ± 1 count.
9. Tune the frequency up two increments and verify that the Signal Generator frequency display changes to 10 000.002 MHz. Verify also that the frequency counter reading agrees within ± 1 count.

10 GHz frequency resolution, 2 kHz _____ (✓)

10. Tune the Signal Generator to 18 599.997 MHz and set the frequency increment (FREQ INCR) to 1 kHz.
11. Tune the frequency down one increment and verify that the Signal Generator frequency display indicates 18 599.994 MHz and the frequency counter reading agrees within ± 1 count.
12. Tune the frequency up two increments and verify that the Signal Generator frequency display changes to 18 600.000 MHz. Verify also that the frequency counter reading agrees within ± 1 count.

18.599 995 GHz frequency resolution, 3 kHz _____ (✓)

Band 4 Test

13. Tune the Signal Generator to 25 999.996 MHz and set the frequency increment (FREQ INCR) to 1 kHz.
14. Tune the frequency down one increment and verify that the Signal Generator frequency display indicates 25 999.992 MHz and the frequency counter reading agrees within ± 1 count.
15. Tune the frequency up two increments and verify that the Signal Generator frequency display changes to 26 000.000 MHz. Verify also that the frequency counter reading agrees within ± 1 count.

25.999 996 GHz frequency resolution, 4 kHz _____ (✓)

16. Disconnect the frequency counter and replace the FREQ STANDARD jumper between A3J9 and A3J10. Set the FREQ STANDARD INT/EXT switch to INT.
-

PERFORMANCE TESTS

4-9. INTERNAL TIME BASE AGING RATE

Specification

Electrical Characteristics	Performance Limits	Conditions
FREQUENCY Reference Oscillator Frequency	10 MHz	After a warm-up (typically 24 hours in a normal operating environment)
Aging Rate	$< 5 \times 10^{-10}$ /day	
Accuracy and Stability	Same as reference oscillator	

Description

A reference signal from the Signal Generator (10 MHz OUT) is connected to the oscilloscope's vertical input. A frequency standard (with long term stability greater than 1×10^{-10} /day) is connected to the trigger input. The time required for a specific phase change is measured immediately and after a period of time. The aging rate is inversely proportional to the absolute value of the difference in the measured times.

Equipment

Oscilloscope HP 1980B
 Frequency Standard HP 5065A

NOTE

The internal 10 MHz reference oscillator will typically take 24 to 48 hours to reach its specified rate after instrument storage or shipment. In some cases, if extreme environmental conditions were encountered during storage, the reference oscillator could take as long as one week to achieve its specified aging rate.

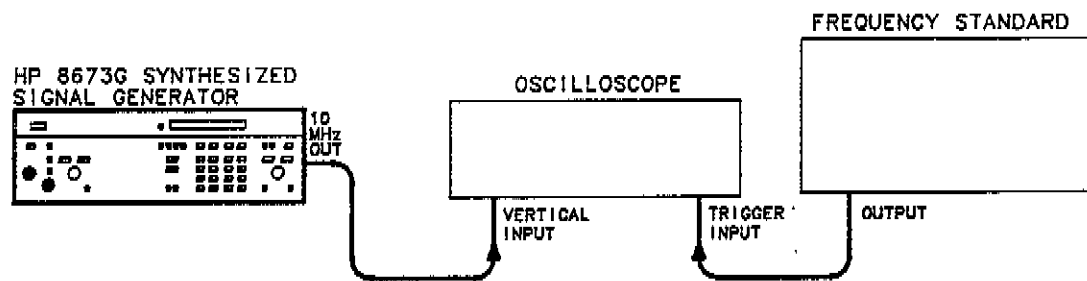

Figure 4-5. Internal Time Base Aging Rate Test Setup

Procedure

1. Connect the equipment as shown in Figure 4-5.

NOTE

This test requires a waiting period of 3 to 24 hours between initial and final measurements.

2. Set the rear panel FREQ REFERENCE INT/EXT switch to the INT position.

PERFORMANCE TESTS

INTERNAL TIME BASE AGING RATE (cont'd)**Procedure
(cont'd)**

3. Adjust the oscilloscope controls for a stable display of the 10 MHz Signal Generator reference output.
4. Measure the time required for a phase change of 360° (one cycle). Record the time (T₁) in seconds.

$$T_1 = \text{_____ s}$$

5. Wait for a period of time (from 3 to 24 hours) and re-measure the phase change time. Record the period of time between measurements (T₂) in hours and the new phase change time (T₃) in seconds.

$$T_2 = \text{_____ h}$$

$$T_3 = \text{_____ s}$$

6. Calculate the aging rate from the following equation:

$$\text{Aging Rate} = \left| \left(\frac{1 \text{ cycle}}{f} \right) \left(\frac{1}{T_1} - \frac{1}{T_3} \right) \left(\frac{T}{T_2} \right) \right|$$

where: 1 cycle = the phase change reference for the time measurement (in this case, 360°)

f = Signal Generator's reference output frequency (10 MHz)

T = specified time for aging rate (24h)

T₁ = initial time measurement for a 360° (1 cycle) change

T₂ = time between measurements

T₃ = final time measurement for a 360° (1 cycle) change

for example:

$$\text{if } T_1 = 351\text{s}$$

$$T_2 = 3\text{h}$$

$$T_3 = 349\text{s}$$

then:

$$\text{Aging Rate} = \left| \left(\frac{1 \text{ cycle}}{10 \text{ MHz}} \right) \left(\frac{1}{351\text{s}} - \frac{1}{349\text{s}} \right) \left(\frac{24\text{h}}{3\text{h}} \right) \right|$$

$$= 1.306 \times 10^{-11}/\text{day}$$

7. Verify that the aging rate is less than $5 \times 10^{-10}/\text{day}$.

NOTE

If the absolute frequencies of the frequency standard and the Signal Generator's reference oscillator are extremely close, the measurement time in steps 4 and 5 (T₁ and T₃) can be reduced by measuring the time required for a phase change of something less than 360°. Change 1 cycle in the formula (e.g.: 180° = ½-cycle, 90° = ¼-cycle).

PERFORMANCE TESTS

4-10. FREQUENCY SWITCHING TIME TEST**Specification**

Electrical Characteristics	Performance Limits	Conditions
SWITCHING TIME Frequency to be within the specified resolution and amplitude to be within 3 dB of final level.	< 25 ms	AUTO PEAK disabled

Description

This test measures the frequency switching speed of the Signal Generator. The Signal Generator output is mixed with a local oscillator whose output frequency is set to the frequency resolution specification above (or below) the destination frequency. The difference frequency (IF) is displayed on the oscilloscope.

Frequency switching speed is measured using a digitizing oscilloscope. The oscilloscope is set to trigger the digitizing process at the beginning of the frequency change. Delayed sweep is used to improve the measurement resolution. As the unit under test is switched from the starting frequency to the destination frequency, the IF signal will pass through zero (when the unit under test frequency is equal to the local oscillator frequency). This will generate a phase reversal. The last phase reversal of the IF frequency is the time that the unit under test is within the specified frequency resolution.

The amplitude recovery time is tested using the same measurement setup. The ± 3 dB amplitude points of the IF signal are calibrated on the oscilloscope display and the amplitude recovery time is tested to ensure that the IF level is within ± 3 dB of the final level.

NOTE

A storage oscilloscope simplifies these tests because it only needs two sweeps to display the switching time. This is especially important for Option 008 where many sweeps cause undue wear on internal relays. If you perform these tests with a non-storage scope, keep the number of sweeps to a minimum.

Equipment

Local Oscillator HP 8340A
 Mixer RHG DMS1-26
 Digitizing Oscilloscope HP 1980B/19860A

Procedure

1. Set up the equipment as shown in Figure 4-6. The external trigger input of the oscilloscope is connected to the Signal Generator's rear panel Blanking/Marker output. This signal will trigger the oscilloscope at the start of a frequency change when any sweep mode is selected.
-

PERFORMANCE TESTS

FREQUENCY SWITCHING TIME TEST (cont'd)**Procedure
(cont'd)**

Figure 4-6. Frequency Switching Time Test Setup

2. Set the oscilloscope as follows:

Channel 1:

Vertical Sensitivity to 50 mV/Division

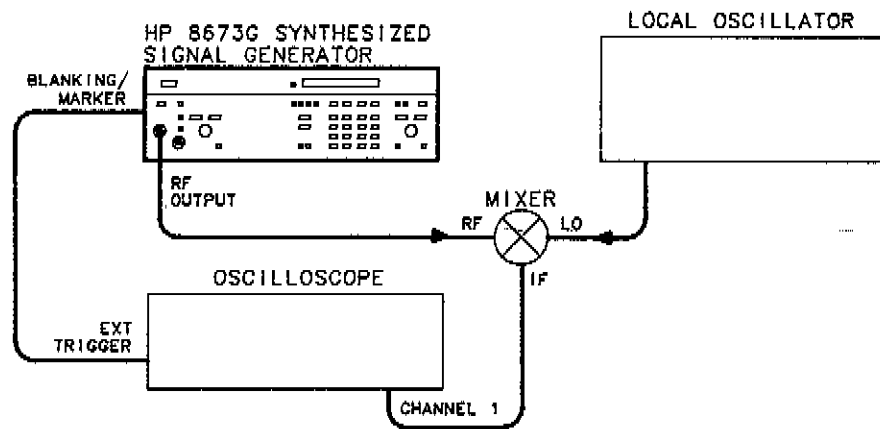
Coupling to AC

Set sweep to delayed

Main Sweep Parameters:

External trigger with DC coupling

Positive slope trigger

Auto sweep mode

Set Trigger Level to E1.00

Delayed Sweep Parameters:

Internal trigger with AC coupling

Positive slope trigger

Auto sweep mode

NOTE

Triggered main sweep must be used to trigger the digitizer at the start of frequency change. If auto trigger mode is selected while digitizing, the oscilloscope will trigger the sweep even without an external trigger signal and the waveform digitized will not be valid for this measurement.

3. Set the oscilloscope's main sweep to 5 ms/per division and delayed sweep to 1 ms/per division. The delayed sweep will be used once the approximate delay required is determined from the main sweep.
 4. Set the Signal Generator to the following conditions:

Output Level	0 dBm
ALC	Internal
Sweep Mode	Manual
Start Frequency	3 000.000 MHz
Stop Frequency	2 000.000 MHz
Step	1 Step
Dwell	20 ms
Auto Peak	Off
-

PERFORMANCE TESTS

FREQUENCY SWITCHING TIME TEST (cont'd)**Procedure
(cont'd)**

5. Set the local oscillator to 2 000.001 MHz CW with an output level of +8 dBm.
6. Using the **FREQ INCREMENT** keys, set the Signal Generator to the stop frequency (2 000.000 MHz).
7. Set the oscilloscope to main sweep mode and **AUTO**. Adjust the oscilloscope's channel 1 vertical sensitivity for a 2 division peak-to-peak display of the IF frequency.
8. Set the oscilloscope's main sweep mode to triggered (or **NORM**). This sweep mode will not trigger the digitizer until the external trigger signal is received.
9. Using the **FREQ INCREMENT** keys, reset the Signal Generator's frequency to the start frequency (3 000.000 MHz). Press the digitizer (**STORE M1**) key on the oscilloscope and then use the appropriate **FREQ INCREMENT** key to step the Signal Generator to the stop frequency (2 000.000 MHz). The oscilloscope should digitize the switching waveform as the frequency changes. The waveform should be similar to the waveform shown in Figure 4-7.

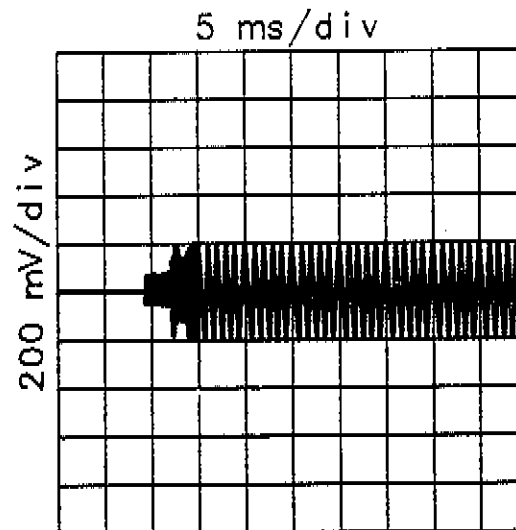
**Figure 4-7. Frequency Switching Waveform**

10. Set the oscilloscope to delayed sweep mode.
 11. Using the digitized signal displayed on the oscilloscope, measure the time to the point at which the IF frequency amplitude suddenly increases and remains more than 1 division peak-to-peak. Set the oscilloscope's delay time to the measured time.
 12. Using the **FREQ INCREMENT** keys, reset the Signal Generator's frequency to the start frequency.
-

PERFORMANCE TESTS

FREQUENCY SWITCHING TIME TEST (cont'd)**Procedure
(cont'd)**

13. Press the digitizer (STORE M1) key on the oscilloscope and step the Signal Generator to the stop frequency with the appropriate FREQ INCREMENT key. The oscilloscope should digitize the switching waveform as the frequency changes. The waveform should now look like that shown in Figure 4-8.

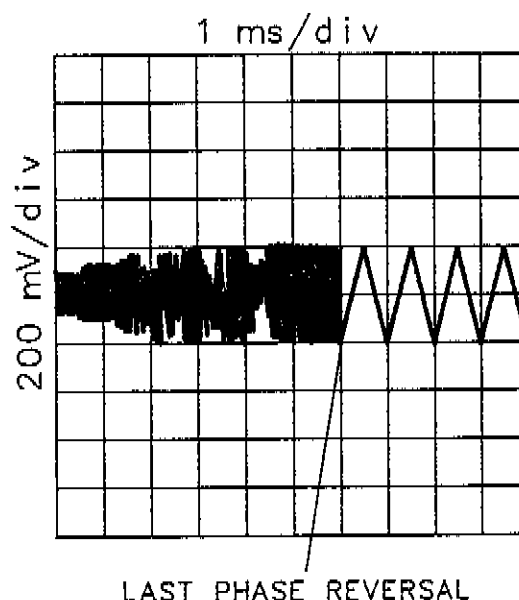

Figure 4-8. Frequency Switching Time Measurement Waveform

14. Measure the frequency switching time by observing the digitized signal on the oscilloscope display. The external trigger is the reference for determining switching speed. The switching time is measured from the display's left graticule to the last phase reversal (as the Signal Generator frequency passes the local oscillator frequency) before the IF signal settles into a steady frequency. Refer to Figure 4-8. Record the frequency switching time.

NOTE

With the oscilloscope in delayed sweep mode, the left graticule of the display corresponds to the delay time. This delay must be added to the time from the left graticule to the last phase reversal to obtain the frequency switching time.

_____ < 25 ms

15. Repeat steps 5 through 12 for each of the start and stop frequencies listed in the following table. Record the switching time for each indicated frequency change.

Amplitude Recovery Time

16. Set the local oscillator to 6 599.999 MHz.
17. Set the Signal Generator start frequency to 2 000.000 MHz and stop frequency to 6 600.000 MHz.
-

PERFORMANCE TESTS

FREQUENCY SWITCHING TIME TEST (cont'd)

Procedure
(cont'd)

Start Frequency (MHz)	Stop Frequency (MHz)	LO Frequency (MHz)	Measured Switching Time
4 000.000	2 000.000	2 000.001	_____ <25 ms
18 000.000	2 000.000	2 000.001	_____ <25 ms
6 200.000	2 090.000	2 090.001	_____ <25 ms
6 000.000	2 100.000	2 100.001	_____ <25 ms
6 500.000	2 100.000	2 100.001	_____ <25 ms
6 490.000	2 200.000	2 200.001	_____ <25 ms
2 000.000	3 000.000	2 999.999	_____ <25 ms
2 200.000	6 490.000	6 489.999	_____ <25 ms
2 100.000	6 500.000	6 499.999	_____ <25 ms
6 610.000	6 590.000	6 590.001	_____ <25 ms
6 590.000	6 610.000	6 609.998	_____ <25 ms
3 999.000	12 400.000	12 399.998	_____ <25 ms
19 500.000	2 100.000	2 100.001	_____ <25 ms
26 000.000	2 100.000	2 100.001	_____ <25 ms
2 100.000	19 500.000	19 499.999	_____ <25 ms
2 000.000	26 000.000	25 999.996	_____ <25 ms
2 100.000	26 000.000	25 999.996	_____ <25 ms

18. Set the oscilloscope to main sweep with auto sweep mode. This allows viewing the IF signal without using the external trigger signal.
19. Using the **FREQ INCREMENT** keys, set the Signal Generator to 6.6 GHz and set the output level to +3 dBm.
20. Adjust the vertical sensitivity and position of the oscilloscope display (main sweep) until a change in output level from +3 dBm to -3 dBm indicates an IF signal amplitude change of exactly 4 divisions peak-to-peak. This calibrates the oscilloscope display to ± 3 dB about 0 dBm. The smaller signal represents -3 dBm and the larger signal represents +3 dBm.
21. Set the Signal Generator to 0 dBm. Set the top of the displayed signal to a convenient reference near the center of the display. Note the +3 dBm and -3 dBm levels for reference. The measurement will be determined by the time required before the amplitude of the IF signal stays between these two levels.
22. Set the oscilloscope's sweep mode to triggered (or NORM). This sweep mode will not trigger the digitizer until the external trigger signal is received.
23. Using the **FREQ INCREMENT** keys, set the Signal Generator to the start frequency (2 000.000 MHz).

PERFORMANCE TESTS

FREQUENCY SWITCHING TIME TEST (cont'd)

Procedure
(cont'd)

24. Press the digitizer (STORE M1) key on the oscilloscope and then step the Signal Generator to the stop frequency (6 600.000 MHz). The oscilloscope should digitize the switching waveform as the frequency changes. The waveform should be as shown in Figure 4-9.

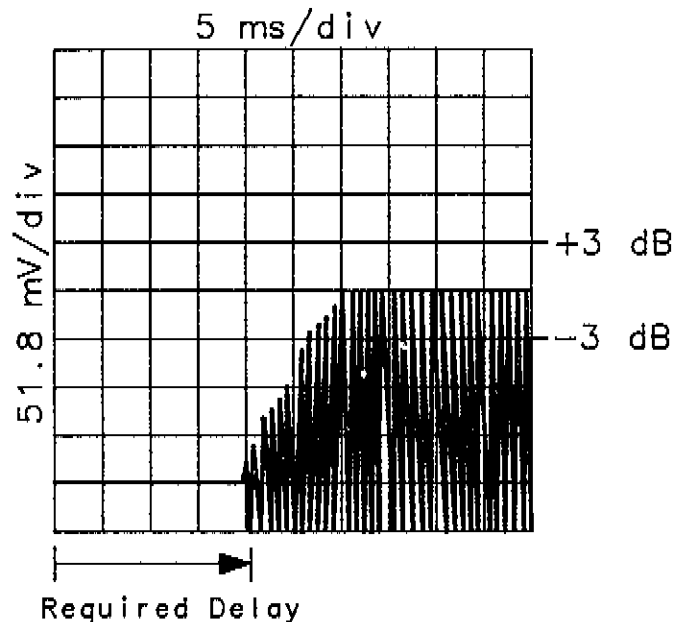

Figure 4-9. Amplitude Recovery Switching Waveform

25. Set the oscilloscope to delayed sweep. Set the oscilloscope's delay time to the time the IF frequency amplitude suddenly increases.
26. Using the **FREQ INCREMENT** keys, reset the Signal Generator's frequency to the start frequency.
27. Press the digitizer (**STORE M1**) key on the oscilloscope and step the Signal Generator to the stop frequency with the **FREQ INCREMENT** key. The oscilloscope should digitize the switching waveform as the frequency changes. The waveform should now look like that shown in Figure 4-10.
28. Measure the amplitude recovery time. The measurement is the time from the left graticule of the display to the last time the IF signal amplitude is outside the reference points noted in step 16.

NOTE

With the oscilloscope in delayed sweep mode, the left graticule of the display corresponds to the delay time. This delay must be added to the time from the left graticule to the last point the IF amplitude is outside of the references to obtain the amplitude recovery time.

_____ <25 ms

PERFORMANCE TESTS

FREQUENCY SWITCHING TIME TEST (cont'd)

Procedure (cont'd)

29. Repeat steps 22 through 28 for each of the start and stop frequencies listed in the following table. Record the amplitude recovery time for each indicated frequency change.

Start Frequency (MHz)	Stop Frequency (MHz)	LO Frequency (MHz)	Measured Recovery Time
6 601.000	12 300.000	12 299.998	_____ <25 ms
8 000.000	4 000.000	3 999.999	_____ <25 ms
4 000.000	10 000.000	9 999.998	_____ <25 ms
12 301.000	18 600.000	18 599.997	_____ <25 ms
18 601.000	26 000.000	25 999.996	_____ <25 ms
2 000.000	26 000.000	25 999.996	_____ <25 ms
6 601.000	26 000.000	25 999.996	_____ <25 ms
2 000.000	18 600.000	18 599.997	_____ <25 ms

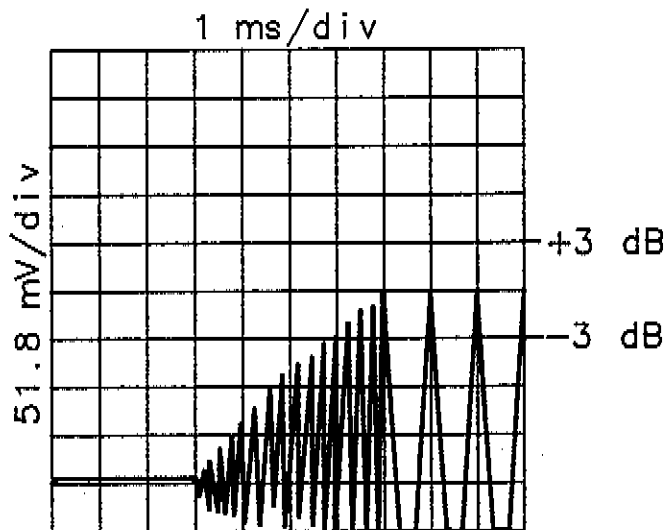

Figure 4-10. Amplitude Recovery Measurement Waveform

PERFORMANCE TESTS

4-11. SINGLE-SIDEBAND PHASE NOISE TEST**Specification**

Electrical Characteristics	Performance Limits	Conditions
SPECTRAL PURITY Single-sideband Phase Noise		1 Hz Bandwidth
2.0 — 6.6 GHz	-58 dBc -70 dBc -78 dBc -86 dBc -110 dBc	10 Hz offset from carrier 100 Hz offset from carrier 1 kHz offset from carrier 10 kHz offset from carrier 100 kHz offset from carrier
6.6 — 12.3 GHz	-52 dBc -64 dBc -72 dBc -80 dBc -104 dBc	10 Hz offset from carrier 100 Hz offset from carrier 1 kHz offset from carrier 10 kHz offset from carrier 100 kHz offset from carrier
12.3 — 18.6 GHz	-48 dBc -60 dBc -68 dBc -76 dBc -100 dBc	10 Hz offset from carrier 100 Hz offset from carrier 1 kHz offset from carrier 10 kHz offset from carrier 100 kHz offset from carrier
18.6 — 26.0 GHz	-46 dBc -58 dBc -66 dBc -74 dBc -98 dBc	10 Hz offset from carrier 100 Hz offset from carrier 1 kHz offset from carrier 10 kHz offset from carrier 100 kHz offset from carrier

Description

The RF output of the Signal Generator is mixed with a local oscillator to obtain a 40 kHz or 200 kHz IF signal. The noise sidebands are observed on a spectrum analyzer. Correction factors are applied to the readings to compensate for using the spectrum analyzer in the log mode, local oscillator noise contributions, and bandwidths wider than 1 Hz.

NOTE

Normally, phase quadrature needs to be maintained between the Signal Generator and the local oscillator for true phase noise measurement. However, the additional amplitude noise components are so small that they are not significant in these tests.

Equipment

Local Oscillator HP 8340A
Spectrum Analyzer HP 3585A
Mixer RHG DMS1-26

PERFORMANCE TESTS

SINGLE-SIDEBAND PHASE NOISE TEST (cont'd)

NOTE

The signal-to-phase noise ratio as measured must be corrected to compensate for 3 errors contributed by the measurement system. These are

- Using the spectrum analyzer in the log mode requires a +2.5 dB correction.
- Equal noise contributed by the local oscillator requires a -3 dB correction.
- The spectrum analyzer noise measurement must be normalized to a 1 Hz noise equivalent bandwidth. The noise equivalent bandwidth for HP spectrum analyzers is 1.2 times the 3 dB bandwidth.

For a 3 Hz bandwidth, the correction factor for the normalized measurement bandwidth would be:

$$\text{Normalizing Factor dB} = 10 \log (1.2 \times 3 \text{ Hz} / 1 \text{ Hz}) = 5.56 \text{ dB.}$$

The total correction for 3 Hz bandwidth would be:

$$\text{True measurement (dBc)} = \text{Reading (dBc)} - 5.56 + 2.5 - 3 = \text{Reading (dBc)} - 6.06 \text{ dB.}$$

Procedure

1. Connect the equipment as shown in Figure 4-11.

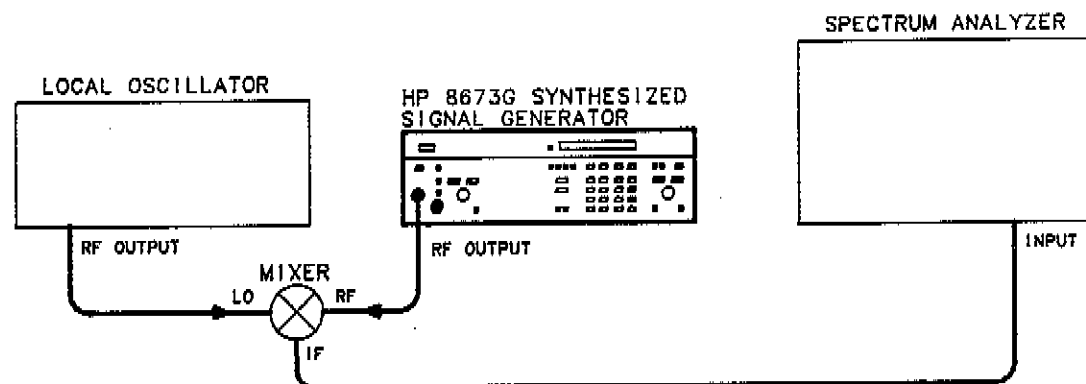

Figure 4-11. Single-Sideband Phase Noise Test Setup

NOTE

Connect the mixer directly to the local oscillator to avoid any power loss.

2. Set the spectrum analyzer's start frequency to 40 kHz, resolution bandwidth to 3 Hz, and stop frequency of 40.05 kHz.
3. Tune the Signal Generator to 6600 MHz. Set the RANGE to -20 dB. Set the VERNIER to 0 dBm as read on the front panel meter.
4. Tune the local oscillator to 6 599.960 MHz with an output amplitude +8 dBm.
5. Set the spectrum analyzer controls so that the peak of the 40 kHz signal is at the top graticule line.

PERFORMANCE TESTS

SINGLE-SIDEBAND PHASE NOISE TEST (cont'd)**Procedure
(cont'd)**

6. Observe the noise level 10 Hz from the carrier. The displayed level should be greater than 51.94 dB below the carrier (<-51.94 dBc). Record the measured and actual level after correction.

Measured _____ dBc
 Correction -6.06 dB
 Actual Level _____ dBc

7. Tune the Signal Generator to 12 300 MHz.

8. Tune the local oscillator to 12 299.960 MHz.

9. Observe the noise level 10 Hz from the carrier. The displayed level should be greater than 45.94 dB below the carrier (<-45.94 dBc). Record the measured and actual level.

Measured _____ dBc
 Correction -6.06 dB
 Actual Level _____ dBc

10. Tune the Signal Generator to 18 600 MHz.

11. Tune the local oscillator to 18 599.960 MHz.

12. Observe the noise level 10 Hz from the carrier. The displayed level should be greater than 41.94 dB below the carrier (<-41.94 dBc). Record the measured and actual level.

Measured _____ dBc
 Correction -6.06 dB
 Actual Level _____ dBc

13. Tune the Signal Generator to 26 000 MHz.

14. Tune the local oscillator to 25 999.960 MHz.

15. Observe the noise level 10 Hz from the carrier. The displayed level should be greater than 39.94 dB below the carrier (<-39.94 dBc). Record the measured and actual level.

Measured _____ dBc
 Correction -6.06 dB
 Actual Level _____ dBc

16. Set the spectrum analyzer controls for a resolution bandwidth of 3 Hz and a frequency span per division of 20 Hz. Using a 3 Hz resolution bandwidth requires a 6.06 dB correction factor.

17. Repeat steps 3 through 15 while observing the noise 100 Hz from the carrier. Record the results in the following table.
-

PERFORMANCE TESTS

SINGLE-SIDEBAND PHASE NOISE TEST (cont'd)**Procedure
(cont'd)**

Frequency	Measured	Correction	Actual	Limit
6600 MHz	_____	-6.06 dB =	_____	<-70 dBc
12300 MHz	_____	-6.06 dB =	_____	<-64 dBc
18600 MHz	_____	-6.06 dB =	_____	<-60 dBc
26000 MHz	_____	-6.06 dB =	_____	<-58 dBc

18. Set the spectrum analyzer resolution bandwidth to 30 Hz and frequency span per division to 200 Hz. The 30 Hz bandwidth requires 16.06 dB correction.

19. Tune the Signal Generator to 6 599.800 MHz.

20. Tune the local oscillator to 6 600.000 MHz

21. Adjust the spectrum analyzer to place the 200 kHz IF signal at the left edge of the display. Set the spectrum analyzer controls to place the peak of the signal at the top graticule line. Increase the log reference level control to move the peak of the IF signal 20 dB above the top graticule line. (The top graticule line is now -20 dBc.)

22. Observe the noise level 1 kHz from the carrier. The displayed level should be greater than 61.94 dB below the carrier (<-61.94 dBc). Record the measured and actual level.

Measured _____ dBc
Correction -16.06 dB
Actual level _____ dBc

23. Tune the Signal Generator to 12 300 MHz.

24. Tune the local oscillator to 12 299.800 MHz.

25. Observe the noise level 1 kHz from the carrier. The displayed level should be greater than 55.94 dB below the carrier (<-55.94 dBc). Record the measured and actual level.

Measured _____ dBc
Correction -16.06 dB
Actual level _____ dBc

26. Tune the Signal Generator to 18 600 MHz.

27. Tune the local oscillator to 18 599.800 MHz.

28. Observe the noise level 1 kHz from the carrier. The displayed level should be greater than 51.94 dB below the carrier (<-51.94 dBc). Record the measured and actual level.

Measured _____ dBc
Correction -16.06 dB
Actual level _____ dBc

PERFORMANCE TESTS

SINGLE-SIDEBAND PHASE NOISE TEST (cont'd)

Procedure (cont'd)

- 29. Tune the Signal Generator to 26 000 MHz.
- 30. Tune the local oscillator to 25 999.800 MHz.
- 31. Observe the noise level 1 kHz from the carrier. The displayed level should be greater than 49.94 dB below the carrier (<-49.94 dBc). Record the measured and actual level.

Measured _____ dBc
 Correction -16.06 dB
 Actual level _____ dBc
- 32. Set the spectrum analyzer controls for a resolution bandwidth of 300 Hz and a frequency span per division of 2 kHz. Using a 300 Hz bandwidth requires a 26.06 dB correction factor.
- 33. Repeat steps 19 through 31 while observing the noise 10 kHz from the carrier. Record the results in the table below.

Frequency	Measured	Correction	Actual	Limit
6600 MHz	_____	-26.06 dB =	_____	<-86 dBc
12 300 MHz	_____	-26.06 dB =	_____	<-80 dBc
18 600 MHz	_____	-26.06 dB =	_____	<-76 dBc
26 000 MHz	_____	-26.06 dB =	_____	<-74 dBc

- 34. Set the spectrum analyzer controls for a resolution bandwidth of 3 kHz and a frequency span per division of 20 kHz. Using a 3 kHz bandwidth requires a 36.06 dB correction factor.
- 35. Repeat steps 19 through 31 while observing the noise 100 kHz from the carrier. Record the results in the table below.

Frequency	Measured	Correction	Actual	Limit
6600 MHz	_____	-36.06 dB =	_____	<-110 dBc
12 300 MHz	_____	-36.06 dB =	_____	<-104 dBc
18 600 MHz	_____	-36.06 dB =	_____	<-100 dBc
26 000 MHz	_____	-36.06 dB =	_____	$<- 98$ dBc

PERFORMANCE TESTS

4-12. HARMONICS, SUBHARMONICS, & MULTIPLES TEST

Specification

Electrical Characteristics	Performance Limits	Conditions
SPECTRAL PURITY Harmonics	<-40 dBc	Up to 26 GHz; output level at or below 0 dBm.
Subharmonics and Multiples Thereof	<-25 dBc <-20 dBc	2.0 to 18.6 GHz 18.6 to 26.0 GHz
For Option 008 Subharmonics and Multiples Thereof	<-25 dBc <-15 dBc	2.0 to 26.0 GHz 18.6 to 26.0 GHz (1/2 and 3/4 subharmonics only)

Description

This test checks the amplitude of various harmonics of the Signal Generator's output signal. In the multiplied frequency bands (>6.6 GHz), subharmonics and multiples (harmonics of the internal fundamental signal) are also checked for specific levels. Reasonable care must be taken to ensure that the harmonics are not being generated by the spectrum analyzer.

Harmonics are tested at high VERNIER settings (+3 dBm). Subharmonics and multiples are tested at low VERNIER settings (-10 dBm) where the feedthrough of the fundamental signal is largest in relation to the multiplied signal.

Equipment

Spectrum Analyzer HP 8566B

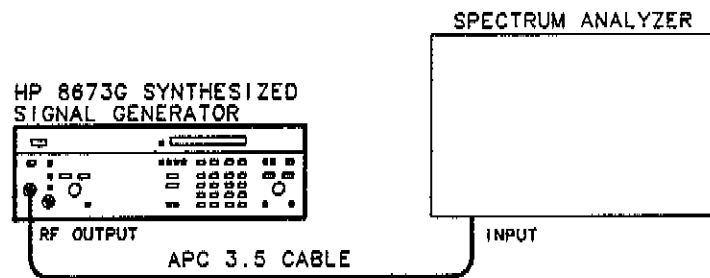

Figure 4-12. Harmonics, Subharmonics, and Multiples Test Setup

Procedure

1. Connect the equipment as shown in Figure 4-12.
2. Tune the Signal Generator to 4 000.000 MHz and set the output level to 0.0 dBm.
3. Set the spectrum analyzer's controls to display the fundamental signal. Set the resolution bandwidth to 10 kHz, the input attenuation to 40 dB, and the sweep span to 100 MHz. Adjust the controls to set the displayed signal to the top graticule line of the display.

PERFORMANCE TESTS

HARMONICS, SUBHARMONICS, & MULTIPLES TEST (cont'd)

Procedure (cont'd)

4. Tune the Signal Generator to 2000.000 MHz. The second harmonic, now displayed on the spectrum analyzer at 4000.000 MHz, should be greater than 40 dB below the reference (top graticule line).

_____ <-40 dBc

5. Repeat steps 2 through 4 for each of the frequencies listed below. Using the VERNIER only, set OUTPUT LEVEL to 0.0 dBm to check harmonics and -10 dBm to check subharmonics and multiples. Record the measurements in Table 4-4.

NOTE

This procedure may be repeated for any fundamental frequency of interest within the Signal Generator frequency range. The worst case performance for harmonics is at high VERNIER settings while the worst case performance for subharmonics and multiples is at low VERNIER settings. Use the appropriate VERNIER setting for each test.

Output Frequency (MHz)	Harmonic Frequency (MHz)	Subharmonic			Multiple	
		1/4	1/3	1/2	2/3	3/4
2000.000	4000.000					
4000.000	8000.000					
6000.000	12000.000					
8000.000	16000.000			4000.000		
10000.000	20000.000			5000.000		
11000.000	22000.000			5500.000		
14000.000			4666.667		9333.333	
16000.000			5333.333		10666.667	
18000.000			6000.000		12000.000	
20000.000		5000.000		10000.000		15000.000
22000.000		5500.000		11000.000		16500.000
24000.000		6000.000		12000.000		18000.000
26000.000		6500.000		13000.000		19500.000

PERFORMANCE TESTS

4-13. NON-HARMONICALLY RELATED SPURIOUS SIGNALS TESTS

Specification

Electrical Characteristics	Performance Limits	Conditions
Spurious Non-harmonically Related	<-60 dBc <-58 dBc	>2.0 to 18.6 GHz >18.6 to 26.0 GHz

Description

A spectrum analyzer is calibrated for -50 dBc and then tuned to any frequency from 12.3 to 18.6 GHz in search of spurious signals.

NOTE

The non-harmonically related spurious signals will always decrease in amplitude below 12.3 GHz and increase above 18.6 GHz. This is due to multiplication in the internal YIG-tuned multiplier. The increase and decrease is determined by a strict mathematical relationship. Therefore, satisfactory performance in the 12.3 to 18.6 GHz range will always ensure meeting the specification in the other bands.

Equipment

Spectrum Analyzer HP 8566B

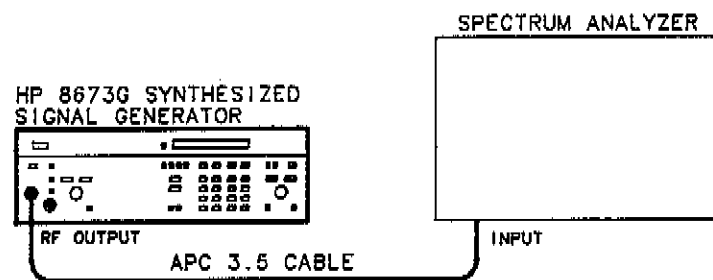

Figure 4-13. Non-harmonically Related Spurious Test Setup

Procedure

1. Connect the equipment as shown in Figure 4-13.
2. Tune the Signal Generator to 1 3000.000 MHz.
3. Set the OUTPUT LEVEL to -60 dBm using the eighth RANGE position.
4. Set the spectrum analyzer controls to display the fundamental signal. Set the resolution bandwidth to 1 kHz and the frequency span per division to 10 kHz.
5. Set the spectrum analyzer controls so that the displayed signal is at the top graticule line.
6. Increase the Signal Generator's RANGE six steps and adjust the VERNIER to -10 dBm. Do not adjust the spectrum analyzer amplitude calibration. The top graticule line now represents -50 dBc.

PERFORMANCE TESTS

NON-HARMONICALLY RELATED SPURIOUS SIGNALS TESTS (cont'd)

**Procedure
(cont'd)**

7. Tune the spectrum analyzer to any desired frequency in search of non-harmonically related spurious signals. Verify that any signals found are non-harmonically related and are not generated by the spectrum analyzer. Verify that the spurious signals are below the specified limits. Record the results.

Carrier Frequency	Spurious Signal Frequency	Spurious Signal Amplitude
_____	_____	_____
_____	_____	_____
_____	_____	_____
_____	_____	_____

8. Repeat steps 2 through 7 for any desired carrier frequency from 12.3 to 18.6 GHz. Record the results. (Checking non-harmonically related spurious signals from 12.3 to 18.6 GHz provides a high level of confidence that the instrument meets its published specifications from 2.0 to 26 GHz.)

Carrier Frequency	Spurious Signal Frequency	Spurious Signal Amplitude
_____	_____	_____
_____	_____	_____
_____	_____	_____
_____	_____	_____

PERFORMANCE TESTS

4-14. POWER LINE RELATED SPURIOUS SIGNALS TESTS

Specification

Electrical Characteristics	Performance Limits	Conditions
SPECTRAL PURITY Power line related and fan rotation related within 5 Hz below line frequencies and multiples thereof. 2.0 — 18.6 GHz >18.6 — 26.0 GHz	<-40 dBc <-38 dBc	

Description

The RF output of the Signal Generator is mixed with a local oscillator to obtain a 20 kHz IF signal. The line related sidebands are observed on a spectrum analyzer.

NOTE

The Signal Generator and local oscillator are isolated from vibration on a two-inch thick foam pad. The Signal Generator must be operated from a separate power line source (52 to 58 Hz) in order to differentiate its spurious signals from other line related spurious signals.

Equipment

- Local Oscillator HP 8340A
- Spectrum Analyzer HP 3585A
- Mixer RHG DMS1-26
- Variable Frequency AC Power Supply 501TC/800T, California Instruments

Procedure

1. Connect the equipment as shown in Figure 4-14.

NOTE

Connect the mixer directly to the local oscillator to avoid any power loss.

2. Place the Signal Generator and the local oscillator on separate two-inch thick foam pads.
3. Tune the Signal Generator to 3 000.000 MHz.
4. Set the OUTPUT LEVEL to -20 dBm using the fourth RANGE position.
5. Tune the local oscillator to 3 000.020 MHz with an output amplitude of +7 dBm.
6. Set the spectrum analyzer start frequency to 20 kHz, frequency span to 500 Hz, and resolution bandwidth to 3 Hz.
7. Adjust the spectrum analyzer controls to place the peak of the 20 kHz IF signal on the top graticule line. Verify that the line related harmonics of the Signal Generator do not exceed the values shown below. Record the highest spurious signal level in each offset band.

2.0 — 6.6 GHz <300 Hz offset _____ <-40 dBc

PERFORMANCE TESTS

POWER LINE RELATED SPURIOUS SIGNALS TESTS (cont'd)

Procedure (cont'd)

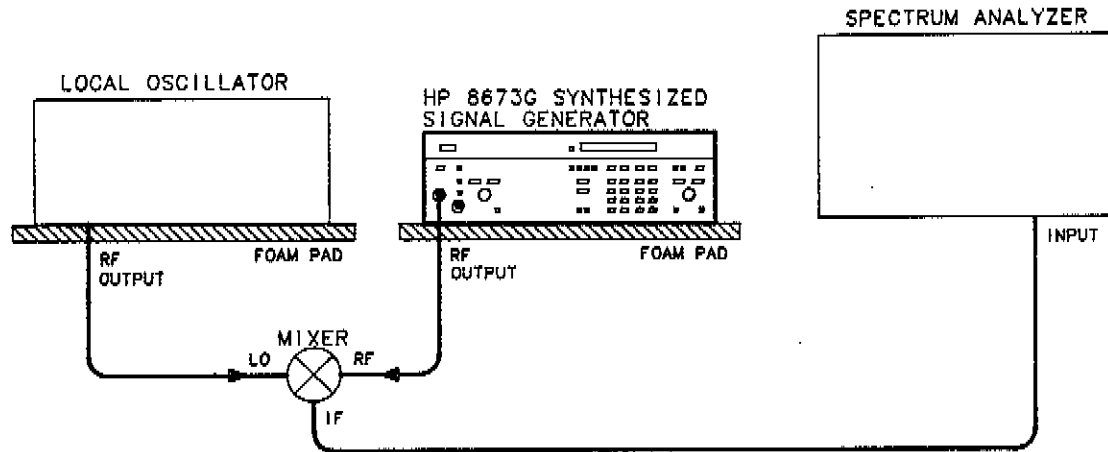

Figure 4-14. Power Line Related Spurious Signals Test Setup

8. Set the spectrum analyzer frequency span to 1 kHz. Ensure that the start frequency is 20 kHz. Measure and record the highest spurious signal level.

300 Hz — 1 kHz offset _____ < -40 dBc

9. Set the spectrum analyzer frequency span to 5 kHz. Ensure that the start frequency is 20 kHz. Measure and record the highest spurious signal level.

>1 kHz offset _____ < -40 dBc

10. Tune the Signal Generator to 7000 MHz.

11. Tune the local oscillator to 7000.020 MHz.

12. Set the spectrum analyzer frequency span per division to 500 Hz. Adjust the spectrum analyzer controls to place the peak of the 20 kHz IF signal on the top graticule line. Verify that the line related harmonics of the Signal Generator do not exceed the values shown below. Record the highest spurious signal level in each offset band.

6.6 — 12.3 GHz <300 Hz offset _____ < -40 dBc

13. Set the spectrum analyzer frequency span to 1 kHz. Ensure that the start frequency is 20 kHz. Measure and record the highest spurious signal level.

300 Hz — 1 kHz offset _____ < -40 dBc

14. Set the spectrum analyzer frequency span to 5 kHz. Ensure that the start frequency is 20 kHz. Measure and record the highest spurious signal level.

>1 kHz offset _____ < -40 dBc

PERFORMANCE TESTS

POWER LINE RELATED SPURIOUS SIGNALS TESTS (cont'd)**Procedure
(cont'd)**

15. Tune the Signal Generator to 16 000.000 MHz.
16. Tune the local oscillator to 16 000.020 MHz.
17. Set the spectrum analyzer frequency span to 500 Hz. Adjust the spectrum analyzer controls to place the peak of the 20 kHz IF signal on the top graticule line. Verify that the line related harmonics of the Signal Generator do not exceed the values shown below. Record the highest spurious signal level in each offset band.

12.3 — 18.6 GHz <300 Hz offset _____ <-40 dBc

18. Set the spectrum analyzer frequency span to 1 kHz. Ensure that the start frequency is 20 kHz. Measure and record the highest spurious signal level.

300 Hz — 1 kHz offset _____ <-40 dBc

19. Set the spectrum analyzer frequency span to 5 kHz. Ensure that the start frequency is 20 kHz. Measure and record the highest spurious signal level.

>1 kHz offset _____ <-40 dBc

20. Tune the Signal Generator to 20 000.000 MHz.

21. Tune the local oscillator to 20 000.020 MHz.

22. Set the spectrum analyzer frequency span to 500 Hz. Adjust the spectrum analyzer controls to place the peak of the 20 kHz IF signal on the top graticule line. Verify that the line related harmonics of the Signal Generator do not exceed the values shown below. Record the highest spurious signal level in each offset band.

18.6 — 26.0 GHz <300 Hz offset _____ <-38 dBc

23. Set the spectrum analyzer frequency span to 1 kHz. Ensure that the start frequency is 20 kHz. Measure and record the highest spurious signal level.

300 Hz — 1 kHz offset _____ <-38 dBc

24. Set the spectrum analyzer frequency span to 5 kHz. Ensure that the start frequency is 20 kHz. Measure and record the highest spurious signal level.

>1 kHz offset _____ <-38 dBc

PERFORMANCE TESTS

4-15. OUTPUT LEVEL AND FLATNESS TESTS

Specification

Electrical Characteristics	Performance Limits	Conditions
RF OUTPUT		
Output Level:		+15 to +35°C
Standard Leveled Output	+8 dBm to -100 dBm +4 dBm to -100 dBm +1 dBm to -100 dBm	2.0 to 18.0 GHz 18.0 to 22.0 GHz 22.0 to 26.0 GHz
Option 004 Leveled Output	+7 dBm to -100 dBm +2 dBm to -100 dBm -1 dBm to -100 dBm	2.0 to 18.0 GHz 18.0 to 22.0 GHz 22.0 to 26.0 GHz
Option 008 Leveled Output	+8 dBm to -100 dBm	2.0 to 26.0 GHz
Flatness		0 dBm range; +15 to +35°C
	±0.75 dB	2.0 to 6.6 GHz
	±1.00 dB	2.0 to 12.3 GHz
	±1.25 dB	2.0 to 18.6 GHz
	±1.75 dB	2.0 to 26.0 GHz
		(Min. to max. variation in power level across specified frequency limits is less than 2 times flatness spec.)

Description

This test checks output level (maximum leveled power) and output level flatness. The output level test uses a power meter to verify that the specified maximum leveled output power can be generated over the full frequency range. Level flatness measures the variation in output power level as the frequency is changed.

Equipment

Power Meter HP 436A
Power Sensor HP 8485A

Procedure

Output Level Test

1. Connect the equipment as shown in Figure 4-15.
2. Zero and calibrate the power meter.
3. Tune the Signal Generator frequency to 2000.0 MHz.
4. Set OUTPUT LEVEL to +8 dBm (+7 dBm for Option 004).
5. Peak the Signal Generator output with the AUTO PEAK key.
6. Tune the Signal Generator in 100 MHz steps from 2000.0 MHz to 18 000 GHz while observing the power meter reading. Record the frequency at which minimum power occurs.

Frequency _____

PERFORMANCE TESTS

OUTPUT LEVEL AND FLATNESS TESTS (cont'd)**Procedure
(cont'd)**

Figure 4-15. Output Level and Flatness Test Setup

7. Tune the Signal Generator to the recorded frequency. Adjust the VERNIER for a power meter reading of +8 dBm (+7 dBm for Option 004).
 8. Tune the Signal Generator from 2000.0 MHz to 18 000 MHz in 100 MHz steps while observing the power meter readings. Ensure that the specified maximum leveled output power level is met.
 9. Tune the Signal Generator to 18 000 MHz.
 10. Adjust the VERNIER for a power meter reading of +4 dBm (+2 dBm for Option 004, +8 dBm for Option 008).
 11. Tune the Signal Generator in 200 MHz steps from 18 000 to 22 000 MHz while observing the power meter readings. Record the frequency at which minimum power occurs.
Frequency _____
 12. Tune the Signal Generator to the recorded frequency. Adjust the VERNIER for a power meter reading of +4 dBm (+2 dBm for Option 004, +8 dBm for Option 008).
 13. Tune the Signal Generator from 18 000 to 22 000 MHz in 200 MHz steps while observing the power meter readings. Ensure that the specified maximum leveled output power level is met.
 14. Tune the Signal Generator to 22 000 MHz.
 15. Adjust the VERNIER for a power meter reading of +1 dBm (-1 dBm for Option 004, +8 dBm for Option 008).
 16. Tune the Signal Generator in 200 MHz steps from 22 000 to 26 000 MHz while observing the power meter readings. Record the frequency at which minimum power occurs.
Frequency _____
 17. Tune the Signal Generator to the recorded frequency. Adjust the VERNIER for a power meter reading of +1 dBm (-1 dBm for Option 004, +8 dBm for Option 008).
 18. Tune the Signal Generator in 200 MHz steps from 22 000 to 26 000 MHz while observing the power meter readings. Ensure that the specified maximum leveled output power level is met.
-

PERFORMANCE TESTS

OUTPUT LEVEL AND FLATNESS TESTS (cont'd)
**Procedure
(cont'd)**
Level Flatness Test**NOTE**

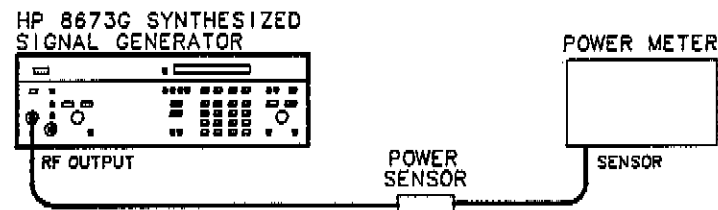
The flatness specification for power output is not referenced to a particular frequency. The specification represents the total power variation over the entire frequency range.

19. Tune the Signal Generator to 2000.0 MHz. Set the OUTPUT LEVEL RANGE and VERNIER for a power meter reading of -5 dBm.
20. Set the power meter mode to dB Relative.
21. Tune the Signal Generator from 2000.0 to 6 600.0 GHz in 100 MHz steps while observing the power meter readings. Record the minimum and maximum output power levels in the following table. Maximum power variation must be within 1.5 dB (highest point to lowest point).
22. Continue tuning the Signal Generator to 12 300 MHz 100 MHz steps while observing the power meter readings. Maximum power variation must be within 2.0 dB. Record the minimum and maximum output power levels in the following table.
23. Continue tuning the Signal Generator to 18 600 MHz in 100 MHz steps while observing the power meter readings. Maximum power variation must be within 2.5 dB. Record the minimum and maximum output power levels in the following table.
24. Continue tuning the Signal Generator to 26 000 MHz in 100 MHz steps while observing the power meter readings. Maximum power variation must be within 3.5 dB. Record the minimum and maximum output power levels in the following table.

Frequency Range	Power Variation
2.0 — 6.6 GHz	Maximum _____ Minimum _____ Total Variation _____ 1.50 dB
2.0 — 12.3 GHz	Maximum _____ Minimum _____ Total Variation _____ 2.00 dB
2.0 — 18.6 GHz	Maximum _____ Minimum _____ Total Variation _____ 2.50 dB
2.0 — 26.0 GHz	Maximum _____ Minimum _____ Total Variation _____ 3.50 dB

PERFORMANCE TESTS

4-16. ABSOLUTE LEVEL ACCURACY TESTS

Specification

Electrical Characteristics	Performance Limits	Conditions
RF OUTPUT Absolute Level Accuracy (+15 to +35°C)	± 1.25 dB	2.0 to 6.6 GHz
	± 1.00 dB	+10 dB RANGE (Highest)
	± 1.50 dB	0 dB RANGE
	± 1.70 dB	-10 dB RANGE
	± 2.00 dB	-20 dB RANGE
	± 2.00 dB & 0.1 dB / 10 dB step	-30 dB RANGE
		<-30 dB RANGE
	± 1.50 dB	6.6 to 12.3 GHz
	± 1.25 dB	+10 dB RANGE
	± 1.75 dB	0 dB RANGE
	± 1.95 dB	-10 dB RANGE
	± 2.25 dB	-20 dB RANGE
	± 2.25 dB & 0.1 dB / 10 dB step	-30 dB RANGE
		<-30 dB RANGE
	± 1.75 dB	12.3 to 18.6 GHz
	± 1.50 dB	+10 dB RANGE
	± 2.10 dB	0 dB RANGE
	± 2.30 dB	-10 dB RANGE
	± 2.70 dB	-20 dB RANGE
	± 2.70 dB & 0.2 dB / 10 dB step	-30 dB RANGE
		<-30 dB RANGE
	± 2.25 dB	18.6 to 26.0 GHz
	± 2.00 dB	+10 dB RANGE
	± 2.55 dB	0 dB RANGE
	± 2.85 dB	-10 dB RANGE
	± 3.30 dB	-20 dB RANGE
	± 3.30 dB & 0.2 dB / 10 dB step	-30 dB RANGE
		<-30 dB RANGE
		Absolute level accuracy specifications include allowances for detector linearity, temperature, flatness, attenuator accuracy, and measurement uncertainty.

Description

This test checks absolute level accuracy of the RF output signal. The first test uses a power meter to verify that power levels between the maximum leveled power and -20 dBm are within specification. Power levels of -30 dBm and below are checked using a spectrum analyzer. The output level of the Signal Generator is adjusted to -20 dBm using the power meter. The Signal Generator output is mixed with a local oscillator to

PERFORMANCE TESTS

ABSOLUTE LEVEL ACCURACY TESTS (cont'd)

Description
(cont'd)

produce an IF frequency. The IF frequency is displayed on the spectrum analyzer. A reference level corresponding to the -20 dBm output is set on the spectrum analyzer and each 10 dB decrease in range is checked for a 10 dB decrease on the spectrum analyzer display.

Equipment

Power Meter	HP 436A
Power Sensor	HP 8485A
Local Oscillator	HP 8340A
Mixer	RHG DMS1-26
Spectrum Analyzer	HP 8566B
40 dB Amplifier	HP 8447F
20 dB Attenuator	HP 8493C Option 020

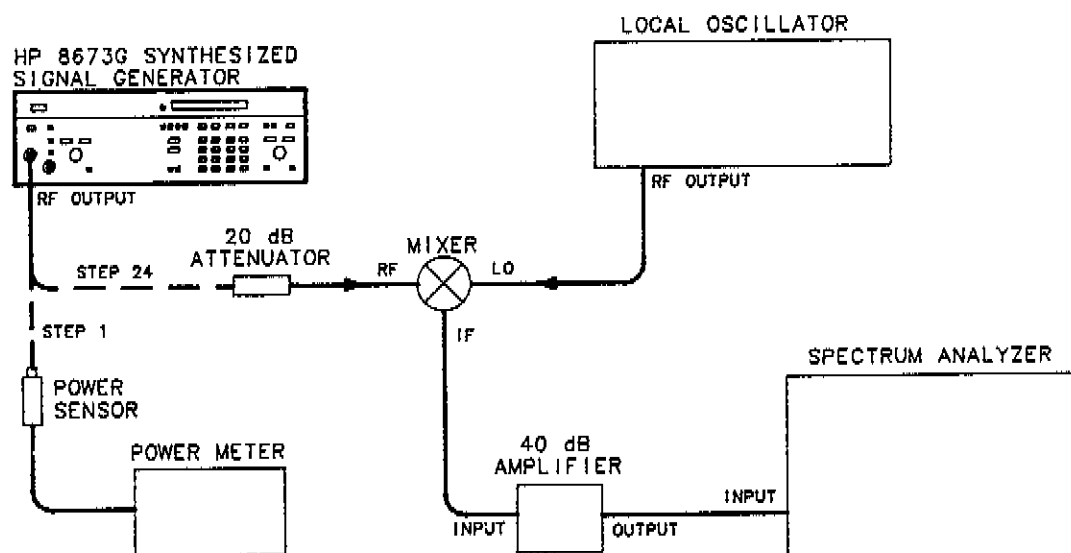

Figure 4-16. Absolute Level Accuracy Test Setup

Procedure

High Level Accuracy Test

1. Connect the equipment as shown in Figure 4-16.
2. Zero and calibrate the power meter. Set the power meter to dBm mode.
3. Tune the Signal Generator to 2.0 GHz.
4. Set the OUTPUT LEVEL RANGE and VERNIER for a power meter reading of $+8$ dBm ($+7$ dBm for Option 004).
5. Peak the Signal Generator output with the AUTO PEAK key.
6. Set the power meter to dB Relative.

PERFORMANCE TESTS

ABSOLUTE LEVEL ACCURACY TESTS (cont'd)**Procedure
(cont'd)**

7. Adjust the VERNIER for an output amplitude of +8 dBm (+7 dBm for Option 004).
8. Tune the Signal Generator from 2.0 to 6.6 GHz in 1 GHz steps while noting the power meter readings at each frequency step. Do not readjust the VERNIER. The power meter readings should be within the limits specified.

(2.0 — 6.6 GHz) -1.25 dB _____ +1.25 dB
9. Tune the Signal Generator to 2.0 GHz.
10. Set the power meter to dBm mode.
11. Adjust the VERNIER for a power meter reading of +5.0 dBm and press the AUTO PEAK key.
12. Set the power meter mode to dB Relative.
13. Adjust the Signal Generator's VERNIER for an output amplitude of +5 dBm.
14. Tune the Signal Generator from 2.0 to 6.6 GHz in 1 GHz steps while noting the power meter readings at each frequency step. Do not readjust the VERNIER. The power meter readings should be within the limits specified.

(2.0 — 6.6 GHz) -1.25 dB _____ +1.25 dB
15. Tune the Signal Generator from 6.6 to 12.3 GHz in 1 GHz steps while noting the power meter readings at each frequency step. The power meter readings should be within the limits specified.

(6.6 — 12.3 GHz) -1.50 dB _____ +1.50 dB
16. Tune the Signal Generator from 12.3 to 18.6 GHz in 1 GHz steps while noting the power meter readings at each frequency step. The power meter readings should be within the limits specified.

(12.3 — 18.6 GHz) -1.75 dB _____ +1.75 dB
17. Tune the Signal Generator from 18.6 to 26.0 GHz in 1 GHz steps while noting the power meter readings at each frequency step. The power meter readings should be within the limits specified.

(18.6 — 26.0 GHz) -2.25 dB _____ +2.25 dB
18. Repeat steps 9 through 17 using the power levels and frequency ranges listed in Table 4-2.

Low Level Accuracy Test

19. Tune the Signal Generator to 2.0 GHz.
 20. Set the OUTPUT LEVEL -20 dBm on the fourth RANGE position.
-

PERFORMANCE TESTS

ABSOLUTE LEVEL ACCURACY TESTS (cont'd)

Procedure
(cont'd)

Table 4-2. High Level Accuracy Test Record

Output Power	Frequency Range	Min.	Actual	Max.
+2.0 dBm (+10 dB RANGE — Highest RANGE)	2.0—6.6 GHz	-1.25 dB	_____	+1.25 dB
	6.6—12.3 GHz	-1.50 dB	_____	+1.50 dB
	12.3—18.6 GHz	-1.25 dB	_____	+1.25 dB
	18.6—26.0 GHz	-2.25 dB	_____	+2.25 dB
-5.0 dBm (0 dB RANGE)	2.0—6.6 GHz	-1.00 dB	_____	+1.00 dB
	6.6—12.3 GHz	-1.25 dB	_____	+1.25 dB
	12.3—18.6 GHz	-1.50 dB	_____	+1.50 dB
	18.6—26.0 GHz	-2.00 dB	_____	+2.00 dB
-10 dBm (0 dB RANGE)	2.0—6.6 GHz	-1.00 dB	_____	+1.00 dB
	6.6—12.3 GHz	-1.25 dB	_____	+1.25 dB
	12.3—18.6 GHz	-1.50 dB	_____	+1.50 dB
	18.6—26.0 GHz	-2.00 dB	_____	+2.00 dB
-10 dBm (-10 dB RANGE)	2.0—6.6 GHz	-1.50 dB	_____	+1.50 dB
	6.6—12.3 GHz	-1.75 dB	_____	+1.75 dB
	12.3—18.6 GHz	-2.10 dB	_____	+2.10 dB
	18.6—26.0 GHz	-2.55 dB	_____	+2.55 dB
-20 dBm (-20 dB RANGE)	2.0—6.6 GHz	-1.70 dB	_____	+1.70 dB
	6.6—12.3 GHz	-1.95 dB	_____	+1.90 dB
	12.3—18.6 GHz	-2.30 dB	_____	+2.30 dB
	18.6—26.0 GHz	-2.85 dB	_____	+2.85 dB

21. Peak the Signal Generator with the AUTO PEAK key.
22. Adjust the VERNIER for a power meter reading of $-20.0 \text{ dBm} \pm 0.1 \text{ dB}$.
23. Disconnect the power meter and connect the Signal Generator to the attenuator and mixer as shown in Figure 4-16.

NOTE

Connect the mixer directly to the local oscillator to avoid any power loss.

24. Tune the local oscillator to a frequency $100 \text{ kHz} \pm 1 \text{ kHz}$ higher than the Signal Generator setting in step 19.
25. Set the local oscillator output power to $+7 \text{ dBm}$.

PERFORMANCE TESTS

ABSOLUTE LEVEL ACCURACY TESTS (cont'd)**Procedure
(cont'd)**

26. Set the resolution bandwidth on the spectrum analyzer to 300 Hz or less. Adjust the vertical sensitivity to place the peak of the 100 kHz IF signal on the center horizontal graticule line. This calibrates the center graticule line for an absolute reference power level of -20 dBm.
27. Set the RANGE of the Signal Generator 10 dB lower and adjust the VERNIER for a front panel reading of -30 dBm.
28. Set the spectrum analyzer reference level 10 dB lower to bring the signal level near the reference graticule line.
29. Read the difference between the new signal level and the center reference graticule line. Calculate the actual power as follows:

NOTE

The difference is positive if the signal is above the reference graticule; negative if below. Use the spectrum analyzer marker, if available, for best accuracy.

$$\begin{array}{r}
 \text{_____ Output level set in step 26.} \\
 + \text{_____ Difference measured in step 29.} \\
 \text{_____ Actual level.}
 \end{array}$$

Record the actual level calculated in Table 4-3. The level reading should be within the limits specified.

30. Repeat steps 27 through 29 with Signal Generator settings of -40 dBm and -50 dBm in step 27. Record the output level readings in Table 4-3.
 31. Note the Signal Generator's signal level (at -50 dBm) on the spectrum analyzer display. Remove the 20 dB attenuator, set the spectrum analyzer's reference level 20 dB lower, and reset the vertical sensitivity to the level noted before removing the 20 dB attenuator.
 32. Repeat steps 27 through 29 with Signal Generator RANGE settings of -60 dBm through -90 dBm. Record the output level readings in Table 4-3.
 33. Repeat steps 19 through 32 with Signal Generator frequencies of 4 GHz, 10 GHz, 14 GHz and 20 GHz.
-

PERFORMANCE TESTS

ABSOLUTE LEVEL ACCURACY TESTS (cont'd)

Procedure
(cont'd)

Table 4-3. Low Level Accuracy Test Record

Test	Results		
	Min	Actual	Max
2.0 GHz			
-30 dBm	-32.00 dBm	_____	-28.00 dBm
-40 dBm	-42.10 dBm	_____	-37.90 dBm
-50 dBm	-52.20 dBm	_____	-47.80 dBm
-60 dBm	-62.30 dBm	_____	-57.70 dBm
-70 dBm	-72.40 dBm	_____	-67.60 dBm
-80 dBm	-82.50 dBm	_____	-77.50 dBm
-90 dBm	-92.60 dBm	_____	-87.40 dBm
4.0 GHz			
-30 dBm	-32.00 dBm	_____	-28.00 dBm
-40 dBm	-42.10 dBm	_____	-37.90 dBm
-50 dBm	-52.20 dBm	_____	-47.80 dBm
-60 dBm	-62.30 dBm	_____	-57.70 dBm
-70 dBm	-72.40 dBm	_____	-67.60 dBm
-80 dBm	-82.50 dBm	_____	-77.50 dBm
-90 dBm	-92.60 dBm	_____	-87.40 dBm
10 GHz			
-30 dBm	-32.25 dBm	_____	-27.75 dBm
-40 dBm	-42.35 dBm	_____	-37.65 dBm
-50 dBm	-52.45 dBm	_____	-47.55 dBm
-60 dBm	-62.55 dBm	_____	-57.45 dBm
-70 dBm	-72.65 dBm	_____	-67.35 dBm
-80 dBm	-82.75 dBm	_____	-77.25 dBm
-90 dBm	-92.85 dBm	_____	-87.15 dBm
14 GHz			
-30 dBm	-32.70 dBm	_____	-27.30 dBm
-40 dBm	-42.90 dBm	_____	-37.10 dBm
-50 dBm	-53.10 dBm	_____	-46.90 dBm
-60 dBm	-63.30 dBm	_____	-56.70 dBm
-70 dBm	-73.50 dBm	_____	-66.50 dBm
-80 dBm	-83.70 dBm	_____	-76.30 dBm
-90 dBm	-93.90 dBm	_____	-86.10 dBm
20 GHz			
-30 dBm	-33.30 dBm	_____	-26.70 dBm
-40 dBm	-43.50 dBm	_____	-36.50 dBm
-50 dBm	-53.70 dBm	_____	-46.30 dBm
-60 dBm	-63.90 dBm	_____	-56.10 dBm
-70 dBm	-74.10 dBm	_____	-65.90 dBm
-80 dBm	-84.30 dBm	_____	-75.70 dBm
-90 dBm	-94.50 dBm	_____	-85.50 dBm

PERFORMANCE TESTS

4-17. OUTPUT LEVEL SWITCHING TIME TEST

Specification

Electrical Characteristics	Performance Limits	Conditions
SWITCHING TIME Output level to be within ± 1 dB of final output level.	< 25 ms	

Description

This test measures the output level switching speed of the Signal Generator. The Signal Generator output is detected using a crystal detector. The detected amplitude is displayed on the oscilloscope.

Level switching speed is measured using a digitizing oscilloscope. The oscilloscope is set to trigger the digitizing process at the beginning of a small frequency change which produces a trigger signal at the Signal Generator's Blanking/Marker rear panel output. As the unit under test is switched, the RF output signal will be blanked and then rise and settle at a fixed amplitude (the final level). The oscilloscope is calibrated to display the ± 1 dB points about the final level. The switching time is the time required before the IF signal amplitude remains within the reference levels.

NOTE

A storage oscilloscope simplifies these tests because it needs only two sweeps to display the switching time. This is especially important for Option 008 where many sweeps cause undue wear on internal relays. If you perform these tests with a non-storage scope, keep the number of sweeps to a minimum.

Equipment

- Crystal Detector HP 8473C
- Digitizing Oscilloscope HP 1980B/19860A
- Controller HP 85B or HP 9836A

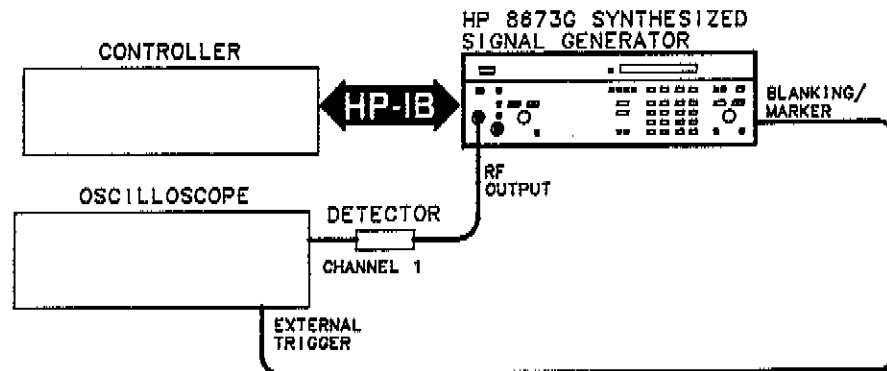

Figure 4-17. Output Level Switching Time Test Setup

PERFORMANCE TESTS

OUTPUT LEVEL SWITCHING TIME TEST (cont'd)**Procedure
(cont'd)**

1. Set up the equipment as shown in Figure 4-17. The external trigger input of the oscilloscope is connected to the Signal Generator's rear panel Blanking/Marker output. This signal will trigger the oscilloscope at the start of a frequency change when any sweep mode is selected. By making a simultaneous frequency and level change, the oscilloscope can be triggered to view the level switching process.
2. Set the oscilloscope as follows:
 - Channel 1:
 - Vertical Sensitivity to 5 mV/Division
 - Coupling to DC
 - Set sweep to delayed
 - Main Sweep Parameters:
 - External trigger with DC coupling
 - Positive slope trigger
 - Auto sweep mode
 - Set Trigger Level to E 1.00
 - Delayed Sweep Parameters:
 - Internal trigger with AC coupling
 - Positive slope trigger
 - Auto sweep mode

NOTE

Triggered sweep mode must be used to trigger the digitizer at the start of the simultaneous level and frequency change. If auto sweep mode is selected on the oscilloscope while digitizing, the oscilloscope will trigger the sweep even without an external trigger signal and the waveform digitized will not be valid for this measurement.

3. Set the oscilloscope's main sweep to 5 ms per division and delayed sweep to 1 ms per division. The delayed sweep will be used once the approximate delay required is determined from the main sweep.
 4. Set the Signal Generator to the following conditions:
 - Output Level 0 dBm
 - ALC Internal
 - Sweep Mode Manual
 - Start Frequency 3 000.000 MHz
 - Stop Frequency 3 000.010 MHz
 - Step 10 Steps
 - Dwell 20 ms
 5. Set the oscilloscope to main sweep with auto sweep mode to view the signal without using the external trigger signal.
 6. Enter and run the following HP-IB controller program.
-

PERFORMANCE TESTS

OUTPUT LEVEL SWITCHING TIME TEST (cont'd)

**Procedure
(cont'd)**

```

10 L2=0
20 FOR I=1 TO 20
30 OUTPUT 719;"LE";L2+1;"DB"
40 NEXT I
50 FOR I=1 TO 20
60 OUTPUT 719;"LE";L2-1;"DB"
70 NEXT I
80 GOTO 20
90 ! NEXT PROGRAM
100 L1=-99
110 L2=0
120 OUTPUT 719;"LE";L1;"DB;UP"
130 PRINT "PLEASE PRESS THE DIGITIZER KEY."
140 PRINT "PRESS THE CONTINUE KEY ON THE"
150 PRINT "CONTROLLER WHEN DONE."
160 PAUSE
170 OUTPUT 719;"DN;LE";L2;"DB"
180 END

```

7. While the program is executing, adjust channel 1 vertical controls for an amplitude change of exactly two divisions centered about the middle horizontal graticule. This calibrates the display for a ± 1 dB reference about 0 dBm.
8. Set the oscilloscope's main sweep mode to triggered (or NORM). This sweep mode will not trigger the digitizer until the external trigger signal is received.
9. Press the pause key on the controller to stop the first part of the program. Run the second part of the program by executing the statement "RUN 100". Press the digitizer key on the oscilloscope when instructed to by the program.

The program will set the output level to the starting value (L1) and step the frequency up. The program will then pause to allow the digitizer key on the oscilloscope to be pressed. After the key is pressed, the program triggers the oscilloscope as the level is switched from the start level (L1) to the stop level (L2). The oscilloscope should digitize the switching waveform as the frequency and level changes. The waveform should be similar to the waveform shown in Figure 4-18.

NOTE

If a negative detector is used, channel 1 should be inverted. If channel 1 is not inverted, the actual waveforms will be the inverse of those shown.

10. Set the oscilloscope to delayed sweep mode. Set the oscilloscope's delay time to the time corresponding to about \div a division before the digitized signal's amplitude settles into the final value. The measurement will be the time required before the signal stays within ± 1 division of the middle horizontal graticule (the final amplitude). Setting the delay time to begin the sweep at this point will allow more detail to be digitized since the oscilloscope will digitize a smaller portion of the switching waveform.

PERFORMANCE TESTS

OUTPUT LEVEL SWITCHING TIME TEST (cont'd)

Procedure
(cont'd)

Figure 4-18. Output Level Switching Waveform

11. Rerun the program entered in step 9 by executing the command "RUN 100." Press the digitizer key on the oscilloscope when instructed to by the program. The oscilloscope should digitize the switching waveform with greater detail. The waveform should now look like that shown in Figure 4-19.
12. Measure the level switching time by observing the digitized signal on the oscilloscope display. The external trigger is the reference for determining switching speed. The switching time is measured from the display's left graticule to the last point that the signal is more than ± 1 division from the middle horizontal graticule. Refer to Figure 4-19. Record the level switching time.

NOTE

With the oscilloscope in delayed sweep mode, the left graticule of the display corresponds to the delay time. This delay must be added to the time from the left graticule to the last time the signal is more than ± 1 division from the middle graticule to obtain the level switching time.

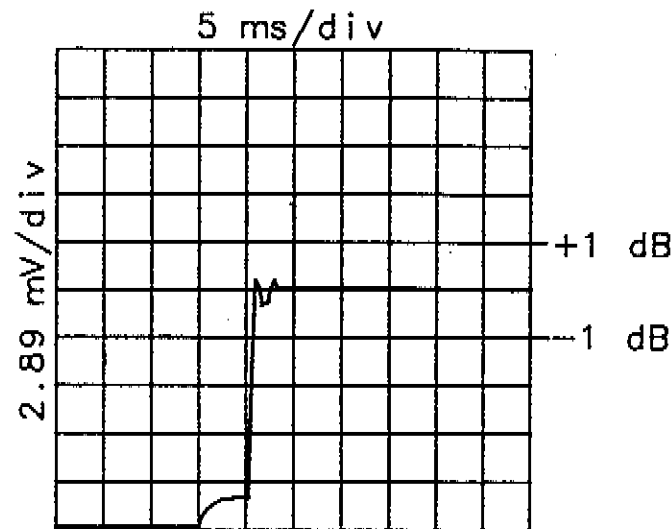
_____ <25 ms

13. Repeat steps 5 through 12 for each of the start and stop levels listed below. Instead of re-entering the program, modify lines 10, 100 and 110 and then run the program as directed. Modify line 10 and 110 of the program by setting L2 to the stop level (i.e. L2=0). Modify line 100 of the program by setting L1 to the start level (i.e. L1=-88). Record the switch time for each indicated level change.

PERFORMANCE TESTS

OUTPUT LEVEL SWITCHING TIME TEST (cont'd)

**Procedure
(cont'd)**

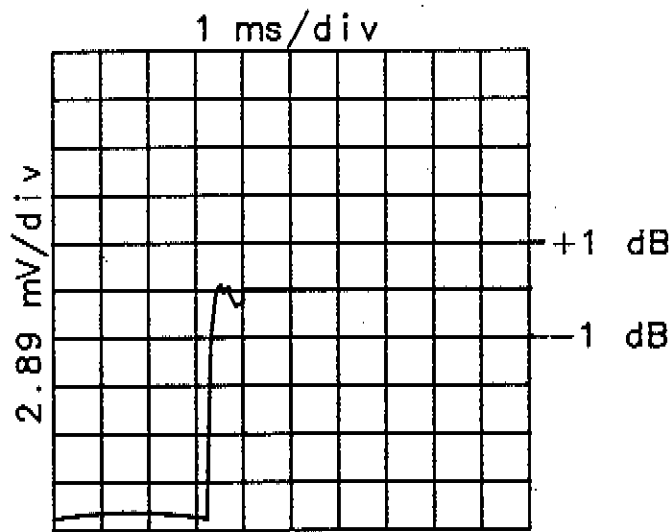

Figure 4-19. Level Switching Time Measurement Waveform

Start Level (dBm)	Stop Level (dBm)	Measured Switching Time
-99.0	0.0	<25 ms
-88.0	0.0	<25 ms
-77.0	0.0	<25 ms
-66.0	0.0	<25 ms
-50.0	-2.0	<25 ms
-40.0	0.0	<25 ms
-30.0	0.0	<25 ms
-20.0	4.0	<25 ms
-10.0	2.0	<25 ms
- 9.9	7.0	<25 ms
- 8.0	6.0	<25 ms
- 9.9	0.0	<25 ms
- 7.0	3.0	<25 ms

Table 4-4. Performance Test Record (1 of 7)

Hewlett-Packard Company Model HP 8673G Signal Generator Serial Number _____		Tested by _____ Date _____		
Para. No.	Test	Results		
		Min.	Actual	Max.
4-8.	FREQUENCY RANGE AND RESOLUTION			
	Baseband Test			
	2 000.000 MHz	1 999.999	_____	2 000.001
	2 000.001 MHz	2 000.000	_____	2 000.002
	2 001.112 MHz	2 001.111	_____	2 001.113
	2 002.223 MHz	2 002.222	_____	2 002.224
	2 003.334 MHz	2 003.333	_____	2 003.335
	2 004.445 MHz	2 004.444	_____	2 004.446
	2 005.556 MHz	2 005.555	_____	2 005.557
	2 006.667 MHz	2 006.666	_____	2 006.668
	2 007.778 MHz	2 007.777	_____	2 007.779
	2 008.889 MHz	2 008.888	_____	2 008.890
	2 009.999 MHz	2 009.998	_____	2 010.000
	2 090.000 MHz	2 089.999	_____	2 090.001
	2 280.000 MHz	2 279.999	_____	2 280.001
	2 470.000 MHz	2 469.999	_____	2 470.001
	2 660.000 MHz	2 659.999	_____	2 660.001
	2 850.000 MHz	2 849.999	_____	2 850.001
	3 040.000 MHz	2 039.999	_____	3 040.001
	3 230.000 MHz	3 229.999	_____	3 230.001
	3 420.000 MHz	3 419.999	_____	3 420.001
	3 610.000 MHz	3 609.999	_____	3 610.001
	3 800.000 MHz	3 799.999	_____	3 800.001
	3 990.000 MHz	3 989.999	_____	3 990.001
	4 180.000 MHz	4 179.999	_____	4 180.001
	4 370.000 MHz	4 369.999	_____	4 370.001
	4 560.000 MHz	4 559.999	_____	4 560.001
	4 750.000 MHz	4 749.999	_____	4 750.001
	4 940.000 MHz	4 939.999	_____	4 940.001
	5 130.000 MHz	5 129.999	_____	5 130.001
	5 320.000 MHz	5 319.999	_____	5 320.001
	5 510.000 MHz	5 509.999	_____	5 510.001
	5 700.000 MHz	5 699.999	_____	5 700.001
	5 900.000 MHz	5 899.999	_____	5 900.001
6 100.000 MHz	6 099.999	_____	6 100.001	
6 600.000 MHz	5 999.999	_____	6 600.001	
Bands 2 and 3 Test				
10 GHz, 2 kHz Resolution		_____ (✓)		
18 GHz, 3 kHz Resolution		_____ (✓)		
25 GHz, 4 kHz Resolution		_____ (✓)		

Table 4-4. Performance Test Record (2 of 7)

Para. No.	Test	Results		
		Min.	Actual	Max.
4-9.	INTERNAL TIME BASE AGING RATE		_____	5×10^{-10} /day
4-10.	FREQUENCY SWITCHING TIME			
	Frequency Switching			
	3.0 to 2.0 GHz		_____	25 ms
	4.0 to 2.0 GHz		_____	25 ms
	18.0 to 2.0 GHz		_____	25 ms
	6.2 to 2.09 GHz		_____	25 ms
	6.0 to 2.1 GHz		_____	25 ms
	6.5 to 2.1 GHz		_____	25 ms
	6.49 to 2.2 GHz		_____	25 ms
	2.0 to 3.0 GHz		_____	25 ms
	2.2 to 6.49 GHz		_____	25 ms
	2.1 to 6.5 GHz		_____	25 ms
	6.61 to 6.59 GHz		_____	25 ms
	6.59 to 6.61 GHz		_____	25 ms
	3.999 to 12.4 GHz		_____	25 ms
	19.5 to 2.1 GHz		_____	25 ms
	26.0 to 2.1 GHz		_____	25 ms
	2.1 to 19.5 GHz		_____	25 ms
	2.0 to 26.0 GHz		_____	25 ms
	2.1 to 26.0 GHz		_____	25 ms
	Amplitude Recovery			
	2.0 to 6.6 GHz		_____	25 ms
	6.601 to 12.3 GHz		_____	25 ms
3.0 to 4.0 GHz		_____	25 ms	
4.0 to 10.0 GHz		_____	25 ms	
12.301 to 18.6 GHz		_____	25 ms	
18.601 to 26.0 GHz		_____	25 ms	
2.0 to 26.0 GHz		_____	25 ms	
6.601 to 26.0 GHz		_____	25 ms	
2.0 to 18.6 GHz		_____	25 ms	
4-11.	SINGLE-SIDEBAND PHASE NOISE			
	10 Hz offset from carrier			
	6600 GHz		_____	-58 dBc
	12 300 GHz		_____	-52 dBc
	18 600 GHz		_____	-48 dBc
	26 000 GHz		_____	-46 dBc
	100 Hz offset from carrier			
	6600 GHz		_____	-70 dBc
12 300 GHz		_____	-64 dBc	
18 600 GHz		_____	-60 dBc	
26 000 GHz		_____	-58 dBc	

Table 4-4. Performance Test Record (3 of 7)

Para. No.	Test	Results		
		Min.	Actual	Max.
4-11.	SINGLE-SIDEBAND PHASE NOISE (cont'd)			
	1 kHz offset from carrier			
	6600 GHz		_____	-78 dBc
	12 300 GHz		_____	-72 dBc
	18 600 GHz		_____	-68 dBc
	26 000 GHz		_____	-66 dBc
	10 kHz offset from carrier			
	6600 GHz		_____	-86 dBc
	12 300 GHz		_____	-80 dBc
	18 600 GHz		_____	-76 dBc
	26 000 GHz		_____	-74 dBc
	100 kHz offset from carrier			
6600 GHz		_____	-110 dBc	
12 300 GHz		_____	-104 dBc	
18 600 GHz		_____	-100 dBc	
26 000 GHz		_____	-98 dBc	
4-12.	HARMONICS, SUBHARMONICS, AND MULTIPLES			
	Fundamental (MHz)	Harmonic or Subharmonic Number		
	2000.000	2	_____	-40 dBc
	4000.000	2	_____	-40 dBc
	6000.000	2	_____	-40 dBc
	8000.000	2	_____	-40 dBc
	8000.000	1/2	_____	-25 dBc
	10000.000	2	_____	-40 dBc
	10000.000	1/2	_____	-25 dBc
	11000.000	2	_____	-40 dBc
	11000.000	1/2	_____	-25 dBc
	14000.000	1/3	_____	-60 dBc
	14000.000	2/3	_____	-25 dBc
	16000.000	1/3	_____	-25 dBc
	16000.000	2/3	_____	-25 dBc
	18000.000	1/3	_____	-25 dBc
	18000.000	2/3	_____	-25 dBc
	20000.000	1/4	_____	-20 dBc
20000.000	1/2	_____	-20 dBc*	
20000.000	3/4	_____	-20 dBc*	
22000.000	1/4	_____	-20 dBc	
22000.000	1/2	_____	-20 dBc*	
22000.000	3/4	_____	-20 dBc*	

* For Option 008, maximum subharmonic or multiples level is -15 dBc.

Table 4-4. Performance Test Record (4 of 7)

Para. No.	Test	Results		
		Min.	Actual	Max.
4-12.	HARMONICS, SUBHARMONICS, AND MULTIPLES (cont'd)			
	Fundamental (MHz)	Harmonic or Subharmonic Number		
	24000.000	1/4	_____	-20 dBc
	24000.000	1/2	_____	-20 dBc*
	24000.000	3/4	_____	-20 dBc*
	26000.000	1/4	_____	-20 dBc
26000.000	1/2	_____	-20 dBc*	
26000.000	3/4	_____	-20 dBc*	
4-13.	NON-HARMONICALLY RELATED SPURIOUS SIGNALS			
	Carrier Frequency	Spurious Signal Frequency		
	13 000.000 MHz	_____	_____	-60 dBc
	13 000.000 MHz	_____	_____	-60 dBc
	(12.3 - 18.6 GHz)	_____	_____	-60 dBc
(12.3 - 18.6 GHz)	_____	_____	-60 dBc	
4-14.	POWER LINE RELATED SPURIOUS SIGNALS			
	2.0-6.6 GHz	< 300 Hz offset	_____	-40 dBc
		300 Hz - 1 kHz offset	_____	-40 dBc
		> 1 kHz offset	_____	-40 dBc
	6.6-12.3 GHz	< 300 Hz offset	_____	-40 dBc
		300 Hz - 1 kHz offset	_____	-40 dBc
		> 1 kHz offset	_____	-40 dBc
	12.3-18.6 GHz	< 300 Hz offset	_____	-40 dBc
		300 Hz - 1 kHz offset	_____	-40 dBc
		> 1 kHz offset	_____	-40 dBc
	18.6-26.0 GHz	< 300 Hz offset	_____	-38 dBc
		300 Hz - 1 kHz offset	_____	-38 dBc
> 1 kHz offset		_____	-38 dBc	
4-15.	OUTPUT LEVEL AND FLATNESS			
	Output Level			
	Frequency and power at minimum power point			
	2000.0 - 18 000 MHz			
Frequency _____				
Minimum power	(Standard)	+8 dBm	_____ (✓)	
	(Option 004)	+7 dBm	_____ (✓)	
	(Option 008)	+8 dBm	_____ (✓)	

* For Option 008, maximum subharmonic or multiples level is -15 dBc.

Table 4-4. Performance Test Record (5 of 7)

Para. No.	Test	Results		
		Min.	Actual	Max.
4-15.	OUTPUT LEVEL AND FLATNESS (cont'd)			
	Output Level (cont'd)			
	18 000—22 000 MHz			
	Frequency _____			
	Minimum power (Standard)	+4 dBm	_____ (✓)	
	(Option 004)	+2 dBm	_____ (✓)	
	(Option 008)	+8 dBm	_____ (✓)	
	22 000—26 000 MHz			
	Frequency _____			
	Minimum power (Standard)	+1 dBm	_____ (✓)	
(Option 004)	-1 dBm	_____ (✓)		
(Option 008)	+8 dBm	_____ (✓)		
Level Flatness (total variation)				
2.0—6.6 GHz, ±0.75 dB		_____	1.50 dB	
6.6—12.3 GHz, ±1.00 dB		_____	2.00 dB	
12.3—18.6 GHz, ±1.25 dB		_____	2.50 dB	
18.6—26.0 GHz, ±1.75 dB		_____	3.50 dB	
4-16.	ABSOLUTE LEVEL ACCURACY			
	High Level Accuracy			
	+8 dBm (+7 dBm for Option 004)			
	2.0—6.6 GHz	-1.25 dB	_____	1.25 dB
	+5 dBm			
	2.0—6.6 GHz	-1.25 dB	_____	1.25 dB
	6.6—12.3 GHz	-1.50 dB	_____	1.50 dB
	12.3—18.6 GHz	-1.75 dB	_____	1.75 dB
	18.6—26.0 GHz	-2.25 dB	_____	2.25 dB
	+2 dBm (+10 dB range)			
	2.0—6.6 GHz	-1.25 dB	_____	1.25 dB
	6.6—12.3 GHz	-1.50 dB	_____	1.50 dB
	12.3—18.6 GHz	-1.75 dB	_____	1.75 dB
	18.6—26.0 GHz	-2.25 dB	_____	2.25 dB
	-5.0 dBm (0 dB range)			
	2.0—6.6 GHz	-1.00 dB	_____	1.00 dB
	6.6—12.3 GHz	-1.25 dB	_____	1.25 dB
	12.3—18.6 GHz	-1.50 dB	_____	1.50 dB
18.6—26.0 GHz	-2.00 dB	_____	2.00 dB	
-10 dBm (0 dB range)				
2.0—6.6 GHz	-1.00 dB	_____	1.00 dB	
6.6—12.3 GHz	-1.25 dB	_____	1.25 dB	
12.3—18.6 GHz	-1.50 dB	_____	1.50 dB	
18.6—26.0 GHz	-2.00 dB	_____	2.00 dB	

Table 4-4. Performance Test Record (6 of 7)

Para. No.	Test	Results			
		Min.	Actual	Max.	
4-16.	ABSOLUTE LEVEL ACCURACY (cont'd)				
	High Level Accuracy (cont'd)				
	-10 dBm (-10 dB range)				
	2.0-6.6 GHz	-1.50 dB	_____	1.50 dB	
	6.6-12.3 GHz	-1.75 dB	_____	1.75 dB	
	12.3-18.6 GHz	-2.10 dB	_____	2.10 dB	
	18.6-26.0 GHz	-2.55 dB	_____	2.55 dB	
	-20 dBm (-20 dB range)				
	2.0-6.6 GHz	-1.70 dB	_____	1.70 dB	
	6.6-12.3 GHz	-1.95 dB	_____	1.95 dB	
	12.3-18.6 GHz	-2.30 dB	_____	2.30 dB	
	18.6-26.0 GHz	-2.85 dB	_____	2.85 dB	
	Low Level Accuracy				
	2.0 GHz	-30 dBm	-32.00 dBm	_____	-23.00 dBm
		-40 dBm	-42.10 dBm	_____	-37.90 dBm
		-50 dBm	-52.20 dBm	_____	-47.80 dBm
		-60 dBm	-62.30 dBm	_____	-57.70 dBm
		-70 dBm	-72.40 dBm	_____	-67.60 dBm
		-80 dBm	-82.50 dBm	_____	-77.50 dBm
		-90 dBm	-92.60 dBm	_____	-87.40 dBm
		4.0 GHz	-30 dBm	-32.00 dBm	_____
	-40 dBm		-42.10 dBm	_____	-37.90 dBm
	-50 dBm		-52.20 dBm	_____	-47.80 dBm
	-60 dBm		-62.30 dBm	_____	-57.70 dBm
	-70 dBm		-72.40 dBm	_____	-67.60 dBm
	-80 dBm		-82.50 dBm	_____	-77.50 dBm
	-90 dBm		-92.60 dBm	_____	-87.40 dBm
	10 GHz		-30 dBm	-32.25 dBm	_____
		-40 dBm	-42.35 dBm	_____	-37.65 dBm
		-50 dBm	-52.45 dBm	_____	-47.55 dBm
		-60 dBm	-62.55 dBm	_____	-57.45 dBm
		-70 dBm	-72.65 dBm	_____	-67.35 dBm
		-80 dBm	-82.75 dBm	_____	-77.25 dBm
		-90 dBm	-92.85 dBm	_____	-87.15 dBm
		14 GHz	-30 dBm	-32.70 dBm	_____
	-40 dBm		-42.90 dBm	_____	-37.10 dBm
	-50 dBm		-53.10 dBm	_____	-46.90 dBm
	-60 dBm		-63.30 dBm	_____	-56.70 dBm
	-70 dBm		-73.50 dBm	_____	-66.50 dBm
	-80 dBm		-83.70 dBm	_____	-76.30 dBm
-90 dBm	-93.90 dBm		_____	-86.10 dBm	

Table 4-4. Performance Test Record (7 of 7)

Para. No.	Test	Results			
		Min.	Actual	Max.	
4-16.	ABSOLUTE LEVEL ACCURACY (cont'd)				
	Low Level Accuracy (cont'd)				
	20 GHz	-30 dBm	-33.30 dBm	_____	-26.70 dBm
		-40 dBm	-43.50 dBm	_____	-36.50 dBm
		-50 dBm	-53.70 dBm	_____	-46.30 dBm
		-60 dBm	-63.90 dBm	_____	-56.10 dBm
		-70 dBm	-74.10 dBm	_____	-65.90 dBm
		-80 dBm	-84.30 dBm	_____	-75.70 dBm
	-90 dBm	-94.50 dBm	_____	-85.50 dBm	
4-17.	OUTPUT LEVEL SWITCHING TIME				
	Start Level (dBm)	Stop Level (dBm)			
	-99.0	0.0		_____	< 25 ms
	-88.0	0.0		_____	< 25 ms
	-77.0	0.0		_____	< 25 ms
	-66.0	0.0		_____	< 25 ms
	-50.0	-2.0		_____	< 25 ms
	-40.0	0.0		_____	< 25 ms
	-30.0	0.0		_____	< 25 ms
	-20.0	4.0		_____	< 25 ms
	-10.0	2.0		_____	< 25 ms
	-9.9	7.0		_____	< 25 ms
	-8.0	6.0		_____	< 25 ms
-9.9	0.0		_____	< 25 ms	
-7.0	3.0		_____	< 25 ms	