

Figure 11-11. Marker Function Menu

MARKER → START (MARKSTAR) changes the stimulus start value to the stimulus value of the active marker.

MARKER → STOP (MARKSTOP) changes the stimulus stop value to the stimulus value of the active marker.

MARKER → CENTER (MARKCENT) changes the stimulus center value to the stimulus value of the active marker, and centers the new span about that value.

MARKER → SPAN (MARKSPAN) changes the Start and Stop values of the stimulus span to the values of the active marker and the delta reference marker. If there is no reference marker, the message "NO MARKER DELTA - SPAN NOT SET" is displayed.

MARKER → REFERENCE (MARKREF) equals the reference value to the active marker's response value, without changing the reference position. In the polar format, the full scale value at the outer circle is changed to the active marker response value. This softkey also appears in the scale reference menu.

SEARCH RANGE leads to the search range menu, which defines the range for partial search and to turn the partial search ON or OFF.

MKR SEARCH leads to the marker search menu, which searches the trace for a particular value or bandwidth.

STATISTICS (MEASTATON, MEASTATOFF) calculates and displays the mean, standard deviation, and peak-to-peak values of the section of the displayed trace in the search range defined in Search Range Menu. If Partial Search is off, the statistics are calculated for the entire trace. A convenient use of this feature is to find the peak-to-peak value of passband ripple without searching separately for the maximum and minimum values.

The statistics are absolute values: For the polar format, the statistics are calculated using the first value of the complex pair (magnitude or real part).

Search Range Menu

This menu specifies and activates the range over which the marker search functions are effective. This function is useful if a part of the entire stimulus range is analyzed.

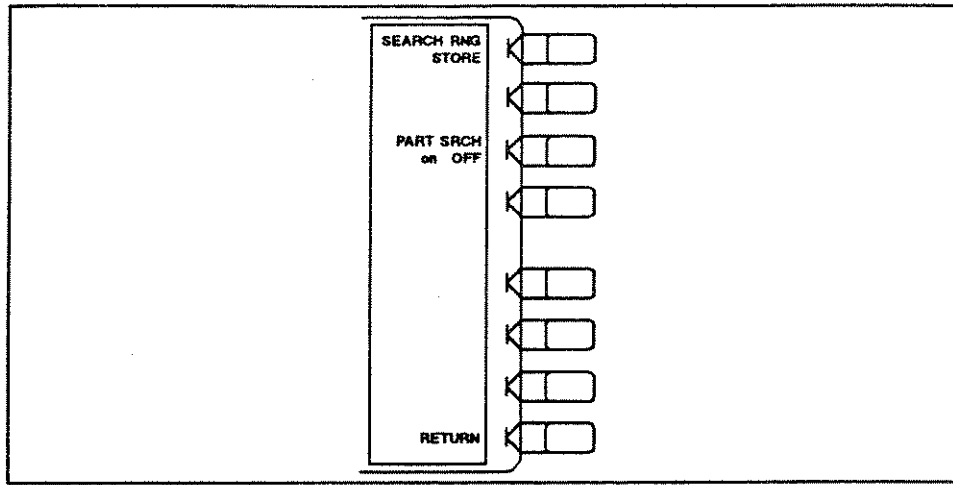

Figure 11-12. Search Range Menu

SEARCH RNG STORE (SEARSTOR) stores a search range, which is defined between the active marker and the delta reference marker. If there is no reference marker, the message "NO MARKER DELTA - RANGE NOT SET" is displayed.

PART SRCH on OFF (PARSON, PARSOFF) turns partial search ON or OFF. The search range is displayed by two small triangles, " Δ ", at the bottom of the graticule. If no search range is defined, the search range is the entire trace.

RETURN goes back to the marker function menu.

Marker Search Menu

This menu searches the trace for a specific amplitude-related point, and places the marker on that point, and to lead more menu for searching in a partial range of the trace. The capability of searching for a specified bandwidth is also provided. Tracking is available for a continuous sweep-to-sweep search. If there is no occurrence of a specified value or bandwidth, the message "TARGET VALUE NOT FOUND" is displayed.

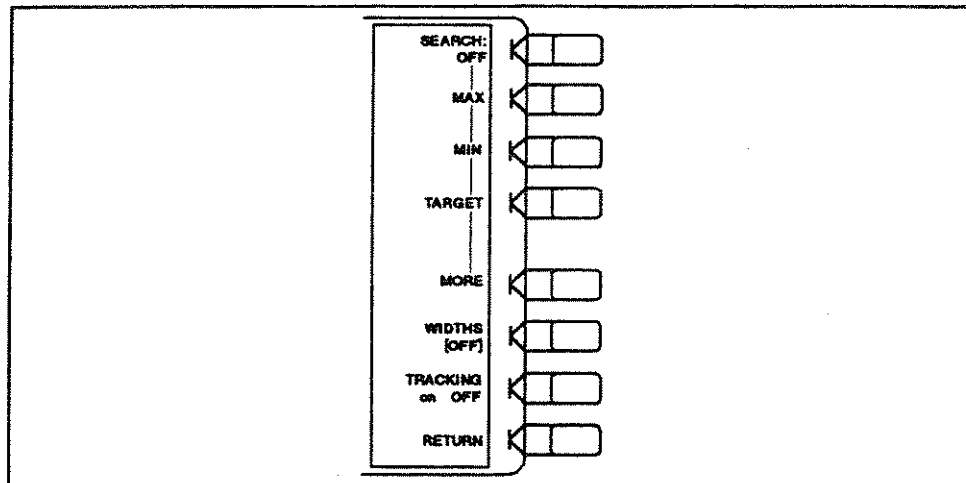

Figure 11-13. Marker Search Menu

SEARCH: OFF (SEAOFF) turns OFF the marker search function.

MAX (SEAMAX) moves the active marker to the maximum point on the trace. In polar format, LIN and LOG markers searches on $|\Gamma|$, and other types of marker searches on real part of measurement parameter.

MIN (SEAMIN) moves the active marker to the minimum point on the trace. In polar format, LIN and LOG markers searches on $|\Gamma|$.

TARGET (SEATARG) places the active marker at a specified target point on the trace. The target menu is presented, providing search right and search left options to resolve multiple solutions.

For relative measurements, a search reference must be defined with a delta marker or a fixed marker before the search is activated.

MORE goes to the marker search more menu.

WIDTHS leads to the width menu, which is used to define the START and STOP points for a bandwidth search, and to turn bandwidth search ON and OFF.

TRACKING on OFF (TRACKON, TRACKOFF) is used in conjunction with other search features to track the search with each new sweep. Turning ON tracking makes the analyzer search every new trace for the specified target value and put the active marker on that point.

When tracking is OFF, the target is found on the current sweep and remains at the same stimulus value regardless of changes in trace response value with subsequent sweeps.

A maximum and a minimum point can be tracked simultaneously using two channels and uncoupled markers.

RETURN goes back to the marker function menu.

Target Menu

The target menu places the marker at a specified target response value on the trace, and provides search right and search left options. If there is no occurrence of the specified value, the message "TARGET VALUE NOT FOUND" is displayed.

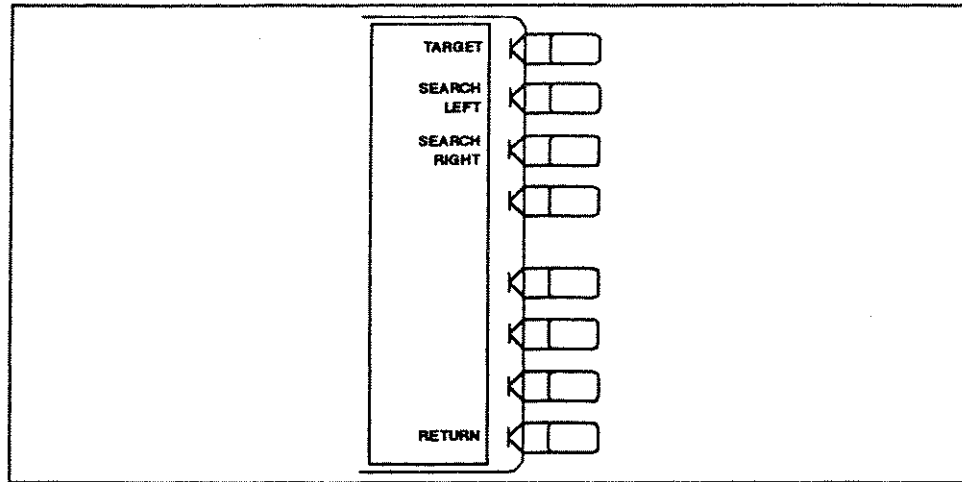

Figure 11-14. Target Menu

TARGET (SEATARG) places the marker at the specified target response value. If tracking is ON (see previous menu) the target is automatically tracked with each new trace. If tracking is OFF, the target is found each time this key is pressed. The target value is in units appropriate to the current format. The default target value is -3 dB.

In delta marker mode, the target value is the value relative to the reference marker. If no delta reference marker is ON, the target value is an absolute value.

SEARCH LEFT (SEAL) searches the trace for the next occurrence of the target value to the left.

SEARCH RIGHT (SEAR) searches the trace for the next occurrence of the target value to the right.

RETURN goes back to the marker search menu.

Marker Search More Menu

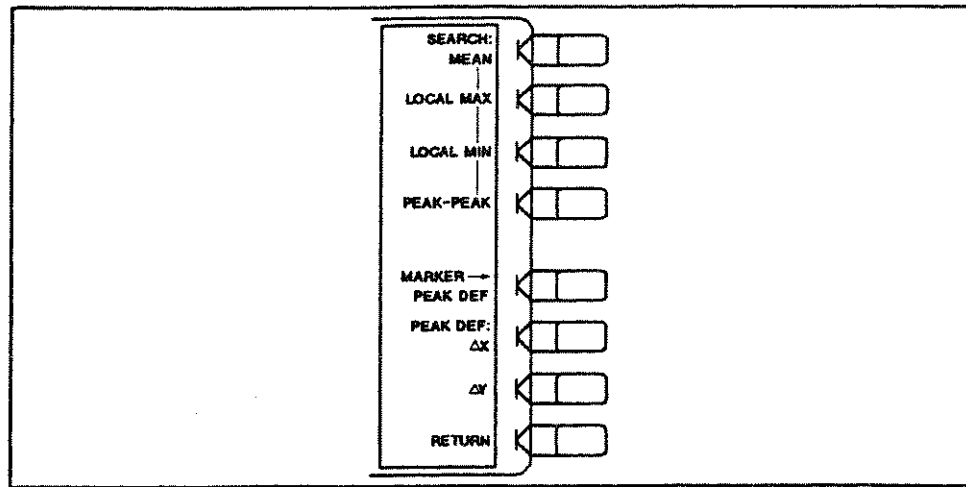

Figure 11-15. Marker Search More Menu

SEARCH: MEAN (SEAMEAN) moves the active marker to the mean point on the trace (in the search range if it has been specified).

LOCAL MAX (SEALMAX) moves the active marker to the maximum *peak* point on the trace in the search range stored in the search range menu. The applicable peak profile is defined by the **MARKER → PEAK DEF** or **PEAK DEF: ΔX** and **ΔY** keys described below.

LOCAL MIN (SEALMIN) moves the active marker to the minimum *peak* point on the trace in the search range stored in the search range menu. The applicable peak profile is defined by the **MARKER → PEAK DEF** or **PEAK DEF: ΔX** and **ΔY** keys described below.

PEAK-PEAK (SEAPPEAK) moves the active marker and the delta reference marker to the maximum peak point and the minimum peak point on the trace in the search range. The applicable peak profile is defined by the **MARKER → PEAK DEF** or **PEAK DEF: ΔX** and **ΔY** keys described below. This turns ON the delta mode regardless of the current marker mode.

MARKER → PEAK DEF (MARKPEAD) changes the differential stimulus value (ΔX) and response value (ΔY) of the peak for searching for the local max, min, and peak-to-peak to the respective differential values between active and reference markers.

PEAK DEF: ΔX (PEADX) defines the differential stimulus value (ΔX) of the peak for searching for the local max, min, and peak-to-peak.

ΔY (PEADY) defines the differential response value (ΔY) of the peak for searching for the local max, min, and peak-to-peak.

Note For Peak Define

The **PEAK DEF: ΔX** and **ΔY** softkeys define the peak profile to be applicable for the **LOCAL MAX**, **LOCAL MIN**, and **PEAK-PEAK** functions. These functions search a peak where, the positive-going shoulder gradient is greater than $\Delta Y/\Delta X$, and the negative-going shoulder gradient is less than $-\Delta Y/\Delta X$. Therefore, the peak define function can limit the applicable peak to certain sharpness regardless its absolute value. The greater $\Delta Y/\Delta X$, the sharper the peak.

Example: To analyze a spurious peak on a trace, shown in Figure 11-16, using the **LOCAL MAX** softkey, specify $\Delta Y/\Delta X$, larger than that of the fundamental peak $\Delta Y_1/\Delta X_1$, (expected not to be detected) and smaller than that of the spurious peak $\Delta Y_2/\Delta X_2$ (expected to detect). This filters out the fundamental peak from the search.

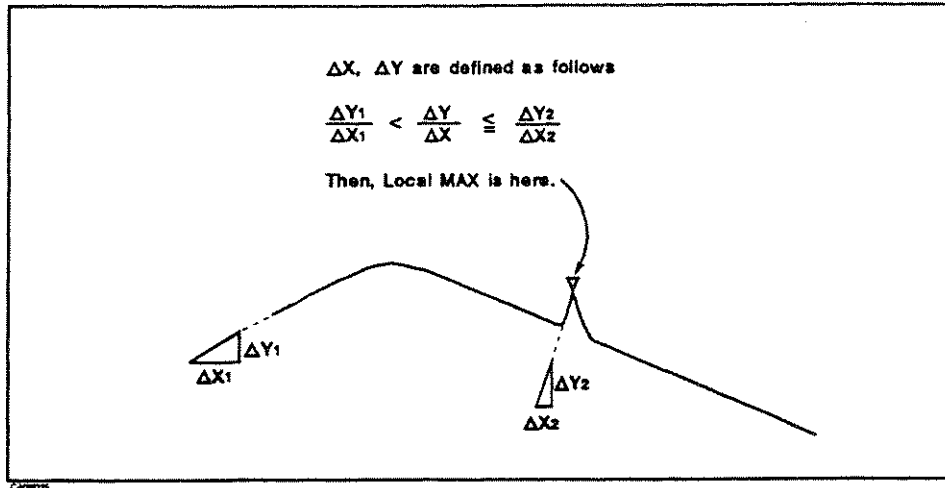

Figure 11-16. Peak Definition Example

The applicable peak is only specified by the ratio, $\Delta x/\Delta y$. The absolute values of Δx and Δy do not matter.

RETURN goes back to the marker search menu.

Width Menu

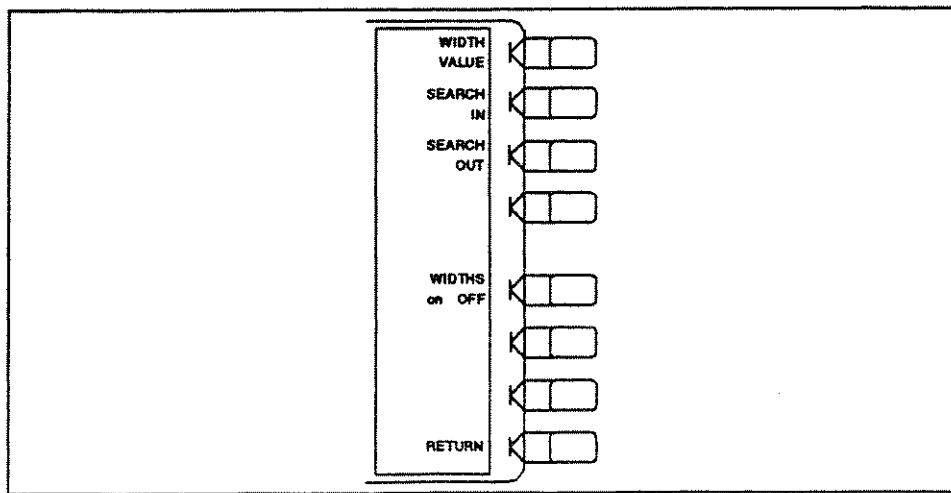

Figure 11-17. Width Menu

WIDTH VALUE (WIDV) sets the amplitude parameter (for example -3 dB) that defines the Start and Stop points for a bandwidth search. The bandwidth Search feature analyzes a bandpass or band reject trace and calculates the center point, bandwidth, and Q (quality factor) for the

specified bandwidth. Bandwidth units are in the units of the current format. When Δ mode is ON, the bandwidth value specified is the deference from the delta reference.

SEARCH IN (WIDSIN) searches for the cutoff point on the trace within the current cutoff points.

SEARCH OUT (WIDSON) searches for the cutoff point on the trace outside of the current cutoff points.

WIDTHS ON OFF (WIDTON, WIDTOFF) turns ON the bandwidth search feature and calculates the center stimulus value, bandwidth, Q, insertion loss, and cutoff point deviation from the center of a bandpass or band reject shape on the trace. The amplitude value that defines the passband or rejectband is set using the **WIDTH VALUE** softkey.

When **WIDTHS** is turned ON, if the active marker is 1, 2, 3, or 4, markers 1, 2, 3, and 4 are turned ON, and each is assigned to a dedicated use. Marker 1 is the starting point from which the search is begun. Marker 2 is the bandwidth center point. Marker 3 is the bandwidth cutoff point on the left, and marker 4 is the cutoff point on the right. If the active marker is the 5, 6, 7, or 8, markers 5, 6, 7, and 8 move in the same manner as above for markers 1, 2, 3, and 4.

The width parameters obtained are also listed on the display as follows:

- BW** displays the bandwidth value set by the **WIDTH VALUE** softkey.
- cent** displays the center stimulus value between cutoff points, which is marked by the marker 2 (, or 6).
- Q** displays the Q value (= cent/BW) of the trace.
- Insertion Loss** displays the absolute value of the marker 1 (, or 5).
- ΔF (left)** displays the stimulus value difference between markers 3 (or 5) and center frequency specified by the **CENTER** key.
- ΔF (right)** displays the stimulus value difference between markers 4 (or 8) and center frequency specified by the **CENTER** key.

Figure 11-18 shows an example of the bandwidth search feature.

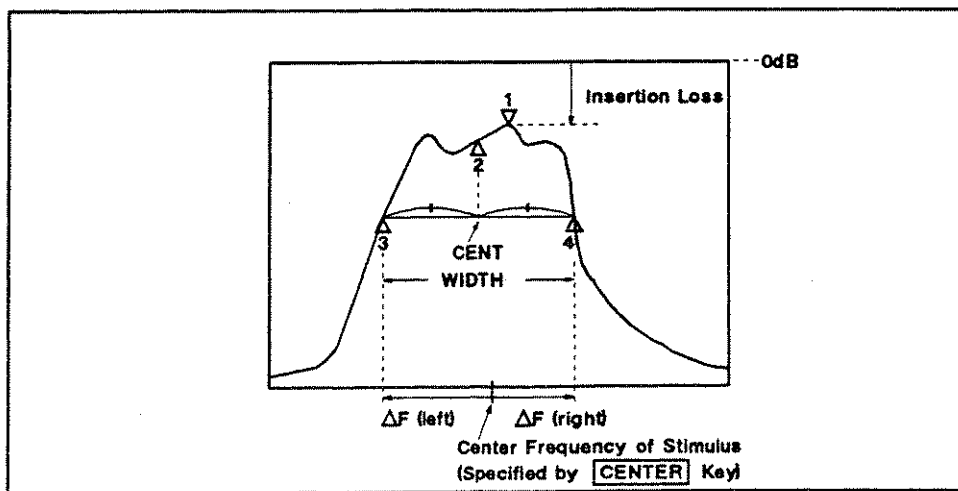

Figure 11-18. Bandwidth Search Example

If a delta marker or fixed marker is ON, it is used as the reference point from which the bandwidth amplitude is measured. For example, if marker 1 is the delta marker and is set at the passband maximum, and the width value is set to -3 dB, the bandwidth search finds the bandwidth cutoff points 3 dB below the maximum and calculates the 3 dB bandwidth and Q.

If marker 2 (the dedicated bandwidth center point marker) is the delta reference marker, the search finds the points 3 dB down from the center.

If no delta reference marker is set, the bandwidth values are absolute values.

In the expanded phase mode, this function searches the two cutoff points whose values are "+ WIDTH VALUE", and "-WIDTH VALUE". For example, when the width value is 45°, the cutoff points' values are $\pm 45^\circ$.

RETURN goes back to the marker search menu.



Instrument State Function Block

Introduction

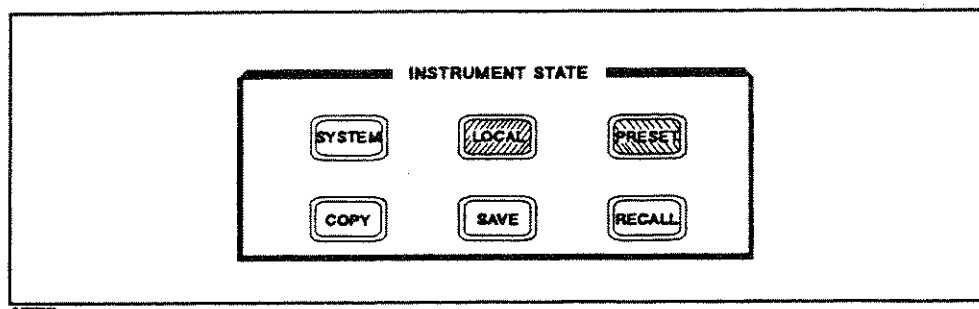

Figure 12-1. Instrument State Function Block

The instrument state function block keys and associated menus provide control of channel-independent system functions. These include controller modes, instrument addresses, real time clock, BIN sorting, limit lines, and limit testing, Instrument BASIC, plotting or printing, saving instrument states and trace data on a built-in disk and a RAM disk memory.

Instrument State Functions and Where They Are Described

Functions accessible in the instrument state function block are described in several different chapters of this Reference, and in other manuals.

Table 12-1 lists each function and where it is discussed. Unless otherwise noted, all references are in this Reference and are marked with the acronym "REF".

Table 12-1. Instrument State Function Descriptions

Instrument State Key	Function	Chapter or Manual
(SYSTEM)	Instrument BASIC Clock BIN Sorting Limit Lines and Limit Testing Service Menu	<i>HP Instrument BASIC Manual Set</i> Using HP Instrument BASIC with the HP 87510A This Chapter This Chapter This Chapter <i>Maintenance Manual</i>
(COPY)	All Features - including printing and plotting	Chapter 10, REF
(SAVE)	All Features - including saving instrument states and saving to built-in disk and RAM disk memory.	Chapter 14, REF
(RECALL)	All Features - including recall of instrument state and data from built-in disk drive and RAM disk memory.	Chapter 14, REF
(LOCAL)	All features - including HP-IB and address menus.	This Chapter
(PRESET)	Preset State	Appendix B, REF

(LOCAL) Key

(LOCAL) key leads to the following menus:

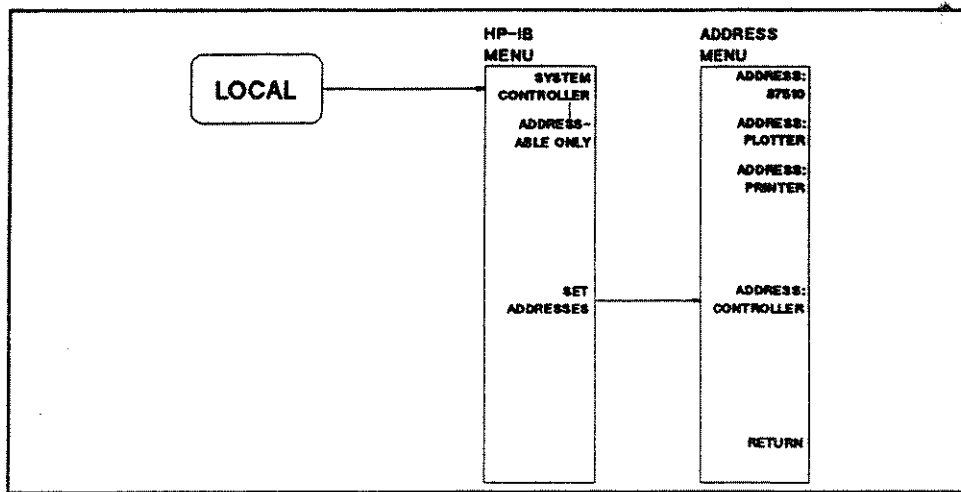

Figure 12-2. Softkey Menus Accessed from the (LOCAL) Key

This key performs the following functions:

- Returns front panel control to the user. The instrument ignores all front panel keys (except the local key) when under the control of an external computer. The instrument is in “local mode” when the user has front panel control. The instrument is in the “remote mode” when an external computer controls the instrument.

- Gives access to the HP-IB menu, which sets the controller mode, and to the address menu, where the HP-IB addresses of peripheral devices are entered. The controller mode determines which device controls the HP-IB bus, the instrument or computer. Only one of them can control the bus at a time.

Local Lockout

Local lockout is a remote (computer generated) command that disables the **LOCAL** key, making it impossible to interfere with the instrument (except for the Power Switch) while it is under computer control.

HP-IB Menu

The analyzer is factory-equipped with a remote programming interface using the Hewlett-Packard Interface Bus (HP-IB). This enables communication between the analyzer and a controlling computer as well as other peripheral devices. This menu indicates the present HP-IB controller mode of the analyzer. Two HP-IB modes are possible: system controller and addressable only.

Preset and cycling the power does not affect the selected controller mode.

Information on usable peripherals is provided in Chapter 2.

System Controller Mode

In the system controller mode, the analyzer itself can use HP-IB to control peripherals usable with the HP 87510A, without the use of an external computer. For example, the analyzer can output measurement results directly to a printer or plotter.

Addressable Mode

This is the mode of operation most often used. In this mode, a computer can take control of and communicate with the analyzer and other peripherals on the bus. The computer can send commands or instructions to and receive data from the analyzer. All of the capabilities available from the analyzer front panel can be used in this operation mode. Exceptions are some special functions such as internal tests.

Information on HP-IB operation is provided in Chapter 15 and in the *HP-IB Programming Manual*.

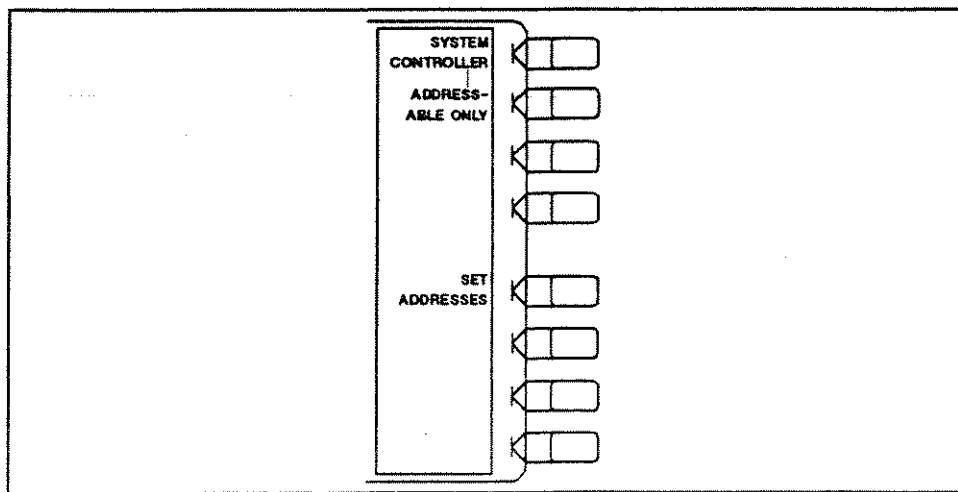

Figure 12-3. HP-IB Menu

SYSTEM CONTROLLER is the mode used when peripheral devices are to be used and there is no external controller. See the description above.

The system controller mode can be used without knowledge of HP-IB programming. However, the HP-IB address must be entered for each peripheral device.

This mode can only be selected manually from the analyzer's front panel, and can be used only if no active system controller is connected to the system through HP-IB. If you try to set system controller mode when another system controller is present, the message "CAUTION: CAN'T CHANGE - ANOTHER CONTROLLER ON BUS" is displayed.

ADDRESSABLE ONLY is the mode used when an external controller controls peripheral devices or the analyzer. This mode is also used when the external computer passes control of the bus to the analyzer.

SET ADDRESSES goes to the address menu, which sets the HP-IB address of the analyzer, and to display and modify the addresses of peripheral devices in the system.

Address Menu

In communications through the Hewlett-Packard Interface Bus (HP-IB), each instrument on the bus is identified by an HP-IB address. This decimal-based address code must be different for each instrument on the bus.

This menu sets the HP-IB address of the analyzer. It also sets the HP-IB addresses the analyzer will use when talking to each peripheral.

Most of the HP-IB addresses are set at the factory and need not be modified for normal system operation. The standard factory-set addresses for instruments that may be part of the system are as follows:

Table 12-2. Default HP-IB Addresses

Instrument	HP-IB Address (decimal)
Analyzer	17
Plotter	05
Printer	01
Controller	21

The address displayed in this menu for each peripheral device must match the address set on the device itself. If the addresses do not match, they can be matched in one of two ways. Either the address set in the analyzer can be changed using the entry controls; or the address of the device can be changed using instructions provided in its manual. The analyzer's HP-IB address is changed through the keyboard controls, there is no physical HP-IB switch.

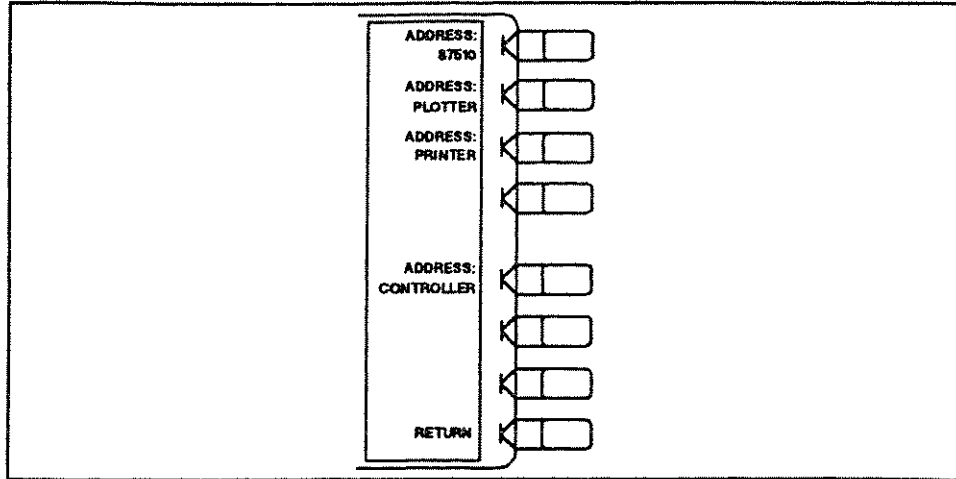

Figure 12-4. Address Menu

ADDRESS: 87510 sets the HP-IB address of the analyzer, using the entry controls. There is no physical address switch to set in the analyzer.

ADDRESS: PLOTTER (ADDRPLOT) sets the HP-IB address the analyzer will use to communicate with the plotter.

ADDRESS: PRINTER (ADDRPRIN) sets the HP-IB address the analyzer will use to communicate with the printer.

ADDRESS: CONTROLLER (ADDRCONT) sets the HP-IB address the analyzer will use to communicate with the external controller.

RETURN goes back to the HP-IB menu. *

SYSTEM Key

The HP-IB programming command is shown in parenthesis following the key or softkey. This key presents the system menu.

System Menu

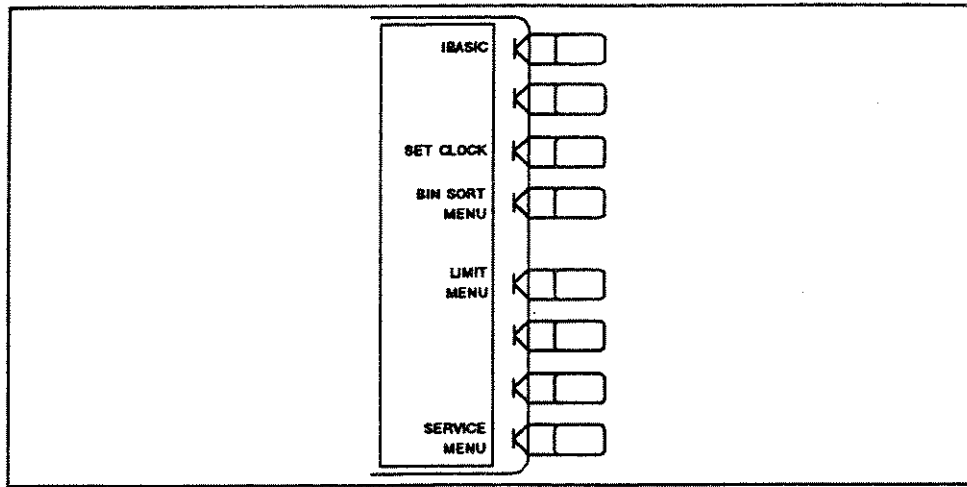

Figure 12-5. System Menu

IBASIC leads to a series of menus used to operate Instrument BASIC. See "Instrument BASIC" in this chapter.

SET CLOCK leads to a series of menus as shown in Figure 12-7, which sets an internal clock. See "Real Time Clock" in this chapter.

BIN SORT MENU leads to a series of menus as shown in Figure 12-23, which defines BINs and specifications with which to compare a test device. See "BIN Sort Function".

LIMIT MENU leads to a series of menus as shown in Figure 12-15, which defines limits or specifications with which to compare a test device. See "Limit Line and Limit Testing".

SERVICE MENU leads to a series of service menus described in detail in the *Maintenance Manual*.

Instrument BASIC

HP Instrument BASIC gives the analyzer programmability without using an external controller. The softkeys shown in the Figure 12-6 allows performing basic operations of HP Instrument BASIC. When you are developing more complex programs, the HP-HIL key board (Option 002) must be used. HP Instrument BASIC is subset of HP BASIC and allows all of the analyzer's measurement capabilities and any other HP-IB compatible instrument to be programmed. For more information about Instrument BASIC, see *Using HP Instrument BASIC with the HP 87510A* in this manual, and the *HP Instrument BASIC Users Handbook* furnished with Option 002.

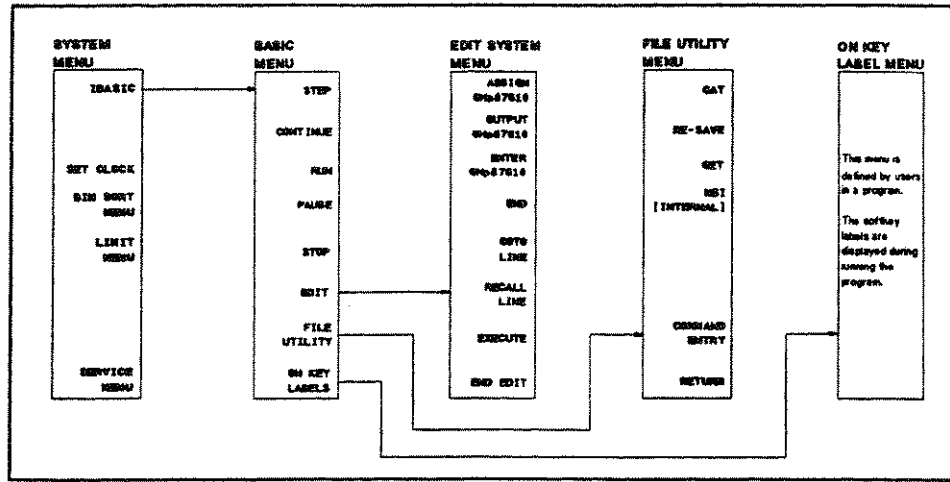

Figure 12-6. Softkey Menus Accessed from the **IBASIC** Softkey

BASIC Menu

Step allows you to execute one program line at a time. This is particularly useful for debugging.

Continue resumes program execution from the point where it was paused.

Run starts a program from its beginning.

Pause pauses program execution after the current program line has executed.

Stop stops program execution after the current line. To restart the program, press **Run**.

Edit enters into the EDIT mode.

FILE UTILITY leads to File Utility menu.

ON KEY LABEL leads to a softkey menu defined during program execution, if the softkey menu has been defined.

Edit System Menu

In the edit mode, the key sequence pressing **SYSTEM** and **IBASIC** leads to the softkey menu to produce the character which are the BASIC commands and editor control commands most often used in developing and running BASIC programs.

ASSIGN @Hp87510 produces the command "ASSIGN @Hp87510 TO 800" at the cursor's current position.

OUTPUT @Hp87510 produces the command "OUTPUT @Hp87510;" at the cursor's current position.

ENTER @Hp87510 produces the command "ENTER @Hp87510;" at the cursor's current position.

END produces the command "END".

GOTO LINE allows you to move the cursor to any line number or label, after pressing **GOTO LINE**, type a line number or a label and then press **Return**, the cursor moves to the specified line or label.

COMMAND ENTRY leads to the Command Entry menu. (See "Command Entry Menu".)

END EDIT exits the edit mode.

ON KEY LABEL Menu

Softkeys in this menu are defined in a program, and the softkeys are labeled during program execution. For more information on using this feature, see "ON KEY" in Chapter 2 of the *HP Instrument BASIC Language Reference* furnished with Option 002.

File Utility Menu

CAT produces the command "CAT". CAT lists the contents of a mass storage directory.

RE-SAVE produces the command "RE-SAVE". RE-SAVE creates a specified ASCII file if it does not exist; otherwise, it re-writes a specified ASCII file by copying program lines as strings into that file.

GET produces the command "GET". GET reads the specified ASCII file and attempts to store the strings into memory as program lines.

MSI [DISK] selects between the flexible disk drive and the RAM disk memory as the storage device used from Instrument BASIC programs. This setting is independent of the setting of the **STOR DEV** under the **SAVE** key.

COMMAND ENTRY leads to the Command entry menu, which allows you to execute Instrument BASIC commands from the front panel keys.

RETURN goes back to the BASIC menu.

Command Entry Menu

HP 87510A Instrument BASIC allows you to enter and execute statements from the front panel keys, if the external HP-HIL keyboard is not connected.

The Command Entry menu is displayed on the softkey menu area, and the active entry area displays the letters, the digits 0 through 9, and some special characters including mathematical symbols. Three sets of letters can be scrolled using the step keys, \uparrow and \downarrow . To enter a statement, press the step keys for the desired letter set, rotate the knob until the arrow "↑" points at the first letter, then press **SELECT LETTER**. Repeat this until the complete statement is entered, then press **DONE** to execute the statement.

SELECT LETTER selects the character pointed to by "↑".

SPACE inserts a space.

BACK SPACE deletes the last character entered.

ERASE TITLE deletes all characters entered.

DONE terminates command entry, and executes the command you entered.

CANCEL cancels command entry and returns to the BASIC menu.

Real Time Clock

This analyzer provides a real time clock to print time and date on the hard copy by Copy function.

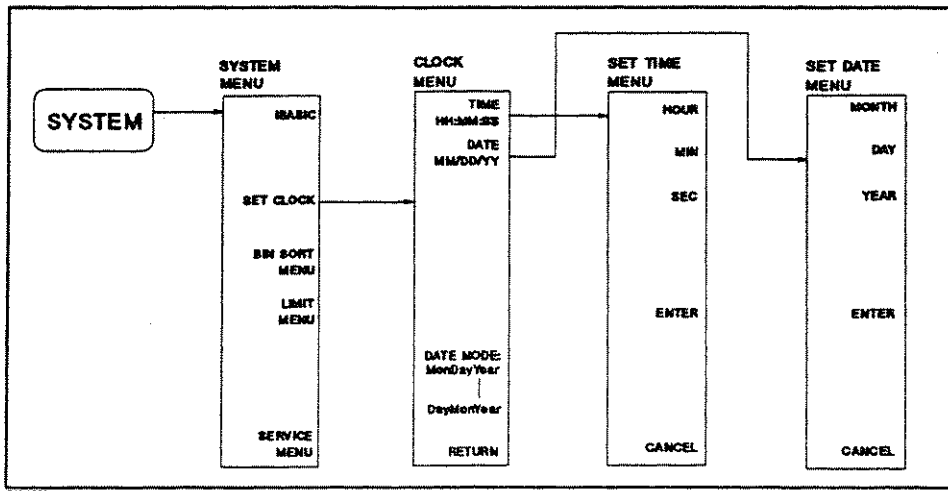

Figure 12-7. Softkey Menus Accessed from the **SET CLOCK** Softkey

Clock Menu

This menu is used to print the current time and date. When the analyzer prints or plots the data, the current time and date is printed or plotted before the information on the screen, if **COPY TIME** under the **COPY** key is turned on.

TIME HH:MM:SS (SETCTIME) displays the current time when pressed. To adjust the time, see "Set Time Menu".

DATE MM/DD/YY (SETCDATE) displays the current date when pressed. To adjust the date, see "Set Date Menu".

DATE MODE: MonDayYear (MONDYEAR) changes the displayed date to the "month:day:year" format.

DayMonYear (DAYMYEAR) changes the displayed date to the "day:month:year" format.

RETURN returns to the system menu.

Set Time Menu

This menu is used to set the internal clock.

HOUR enables changing the hour setting using the knob or the numeric entry keys. After you change the hour setting, press **ENTER** to restart the clock.

MIN enables changing the minute setting using the knob or the numeric entry keys. After you change the minute setting, press **ENTER** to restart the clock.

SEC enables changing the second setting using the knob or the numeric entry keys. After you change the second setting, press **ENTER** to restart the clock.

ENTER restarts the internal clock.

CANCEL returns to the clock menu. Pressing this key will not affect the internal clock setting.

Set Date Menu

MONTH enables changing the month setting using the knob or the numeric entry keys. After you change the month setting, press **ENTER** to restart the clock.

DAY enables changing the day setting using the knob or the numeric entry keys. After you change the day setting, press **ENTER** to restart the clock.

YEAR enables changing the year setting using the knob or the numeric entry keys. After you change the year setting, press **ENTER** to restart the clock.

ENTER restarts the internal clock.

CANCEL returns to the clock menu. Pressing this key will not affect the internal clock setting.

BIN Sort Function

The BIN sort function specifies multiple ranges (BINs), which define both upper and lower limits for various characteristics of a sample for comparison checks between the BIN limits and measurements (BIN sort testing). BIN sort testing is implemented for each measurement point.

Up to 16 BINs may be assigned to each channel (a total of 32 BINs may be specified for both channels). If different BINs cover the same range, the range of the BIN having the lowest number is given priority.

The upper and lower limits of a specified BIN can be displayed as BIN lines overlaying the measurement trace on the screen.

The result of BIN sort testing for each measurement point is output to the I/O port. The bit pattern output to the I/O port can be defined for each BIN. If a measurement is not within all of the BIN limits, it is considered to be in the out-of-BIN range and the bit pattern defined for the out-of-BIN range is output to the I/O port.

A bit of the HP-IB Event Status register B (ESB) can be set when measurement result is within the BIN specified. Setting bit of ESB causes an interrupt during execution of a BASIC program and the program can detect when a measurement result is within the BIN specified.

Either port A or B can be selected as a bit pattern output I/O port. For more information on I/O ports, see Appendix C "I/O Ports."

Note

Option 005, Parallel I/O Mode A (8 bit I/O port) can not be used for an output port.



All BIN sort functions can be specified for each channel.

Example of Using the BIN Sort Function

An example of using the BIN sort function is given here. Figure Figure 12-8 shows an example of sorting ranges by deviation from a reference point. In this example, the upper and lower limits of BIN1 are set to +10 dB and -10 dB, those of BIN2 are set to +20 dB and -20 dB, and those of BIN3 are set to +30 dB and -30 dB respectively. When different BINs cover the same range, the range of the BIN having the lowest number is given priority. Therefore, actual ranges of BIN2 and BIN3 can be sorted by deviation from the central value as shown in Figure 12-8. Setting the span to 0, specifying different measurement conditions for each measurement point, or exchanging samples allows you to sort measurements or multiple samples.

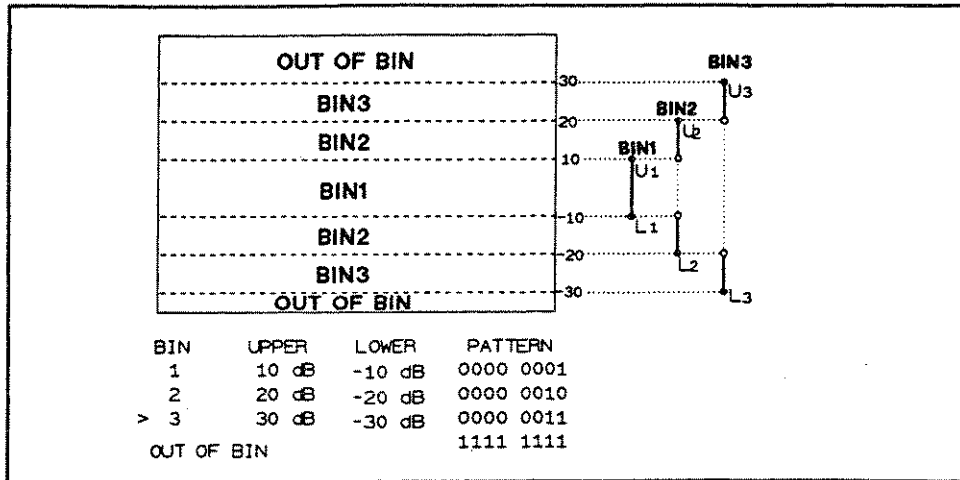

Figure 12-8. Example of Sorting by Deviation

Figure 12-9 shows an example of specifying slightly complicated BINs. Since BIN1 does not overlap any of the other BIN ranges, the ranges between BIN1 and other BINs become out-of-BIN ranges. On the other hand, BIN2 and BIN3 do overlap. Since the range of the BIN having the lowest number is given priority, BIN3 actually ranges from -30 dB to -50 dB.

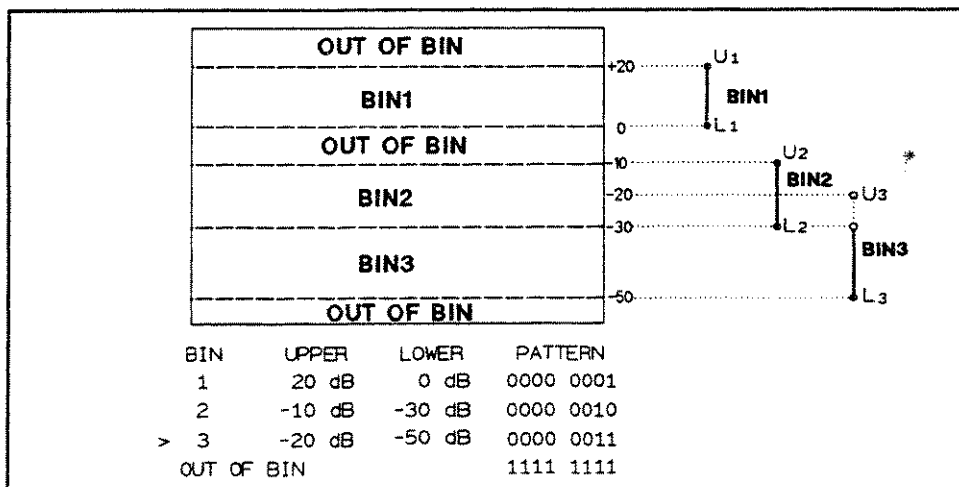

Figure 12-9. A Complex Example

BIN Sort Softkey Menu

The **SYSTEM** softkey provides access to the BIN sort function menu. Figure 12-10 shows this menu.

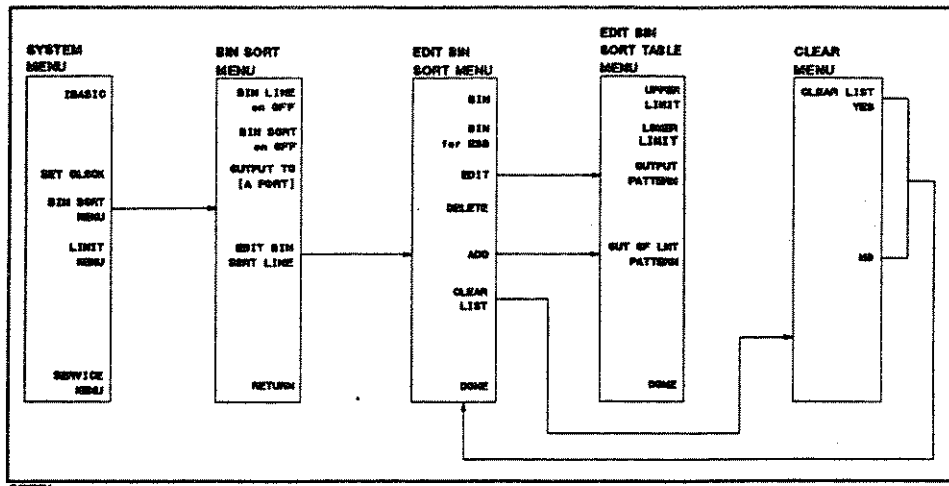

Figure 12-10. Softkey Menu Accessed from the **BIN SORT MENU** Softkey

BIN Sort Menu

This menu is used to turn BIN lines ON or OFF, turn BIN sort testing ON or OFF, or select an output port. It also leads to the BIN sort edit menu.

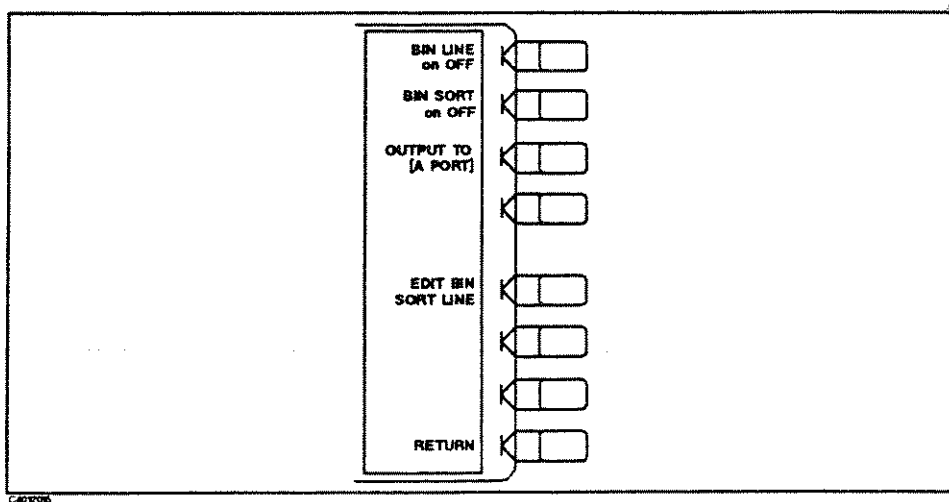

Figure 12-11. BIN Sort Menu

BIN LINE on OFF (BINSLINE) turns BIN lines ON or OFF.

BIN SORT on OFF (BINS) turns BIN sort testing ON or OFF. To define upper and lower limits of a BIN or an I/O pattern, use the **EDIT BIN SORT LINE** softkey described below.

OUTPUT TO B (BINOA for **A PORT**, BINOB for **B PORT**) selects an I/O port to which the BIN sort testing result is to be output. Either I/O port A or B may be selected. The length of the bit pattern that can be output to the I/O port is 8 bits.

EDIT BIN SORT LINE (EDITBINL) displays the BIN setting (BIN sort table) on the lower half of the display. It leads to the BIN sort edit menu, used to specify or modify BINs.

RETURN returns to the system menu.

Edit BIN Sort Menu

This menu is used to add a new BIN or select the BIN to be modified. Use the **ADD** or **EDIT** softkey in this menu to call the BIN sort table edit menu, which specifies BIN's upper and lower limits and the output bit pattern.

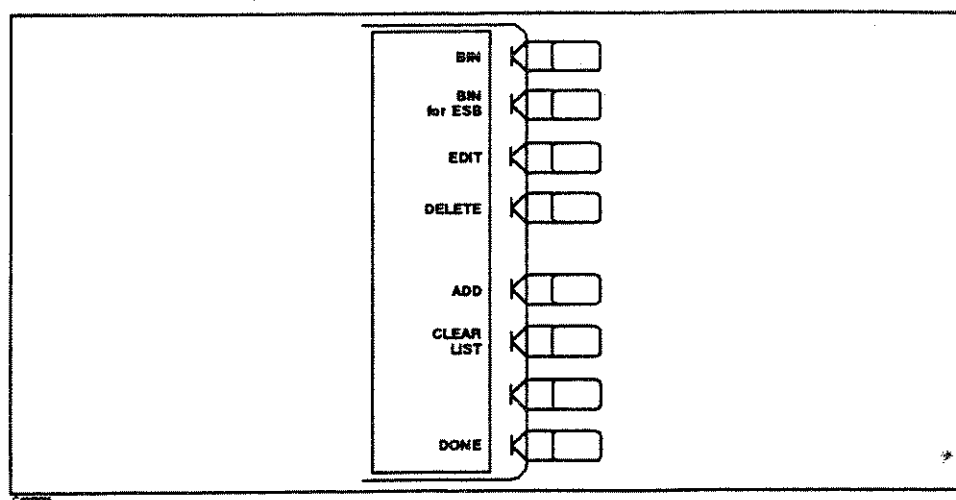

Figure 12-12. Edit BIN Sort Menu

BIN (BINSEDI) selects the BIN to be edited. Generally, up to seven BINs may be displayed. Using the entry block controls, move the pointer ">" next to the BIN to be edited. The indicated BIN can then be modified or deleted. If "EMPTY" is displayed, specify a new BIN using the **ADD** or **EDIT** softkey.

BIN for ESB (BINESB) selects the BIN number to set a bit of the event status register B (ESB) when a result of testing is in the BIN selected by this key. When "0" is set as the BIN number, ESB is set when a result is OUT OF BIN. When "17" is set, ESB is not set.

EDIT displays the BIN sort table edit menu, which defines or changes the upper and lower limits of the specified BIN and the output pattern. When the BIN table is empty, a default BIN is displayed.

DELETE (BINSDEL) deletes the BIN indicated by the pointer ">".

ADD (BINSADD) displays the BIN sort table edit menu to add a new BIN. The initial value of the added BIN is the same as that of the BIN indicated by the pointer. If the BIN table is empty, a default BIN is displayed.

CLEAR LIST leads to the clear menu, which clears all BINs in the BIN sort table.

DONE (BINSDON) returns to the BIN sort menu.

Edit BIN Sort Table Menu

This menu is used to set the upper and lower limits and output bit pattern of each BIN and the bit pattern output for measurements in the out-of-BIN range. The BIN to be edited is selected in the BIN sort edit menu.

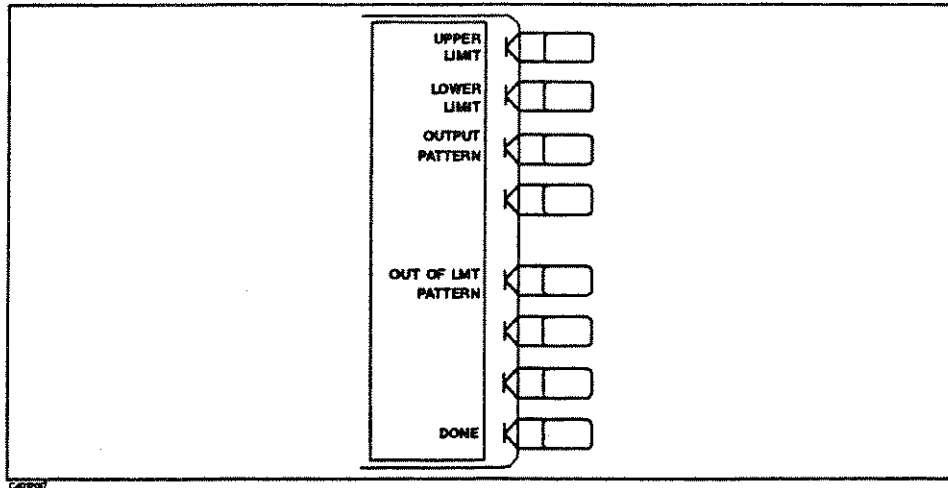

Figure 12-13. Edit BIN Sort Table Menu

UPPER LIMIT (BINU) sets the upper limit of the BIN. If the upper limit is specified, the lower limit must also be specified. If the upper limit is not required, set an extremely large value; for example, 500 dB.

LOWER LIMIT (BINL) sets the lower limit of the BIN. If the lower limit is specified, the upper limit must also be specified. If the lower limit is not required, set an extremely small value; for example, -500 dB.

OUTPUT PATTERN (BINP) sets the bit pattern to be output from the I/O port when the measurement obtained through BIN sort testing is included in this BIN. The bit pattern is displayed in binary numbers on the edit screen.

OUT OF LMT PATTERN (BIN0) sets the bit pattern to be output from the I/O port when the measurement obtained through BIN sort testing is outside all BINs.

DONE returns to the BIN sort edit menu.

Clear Menu

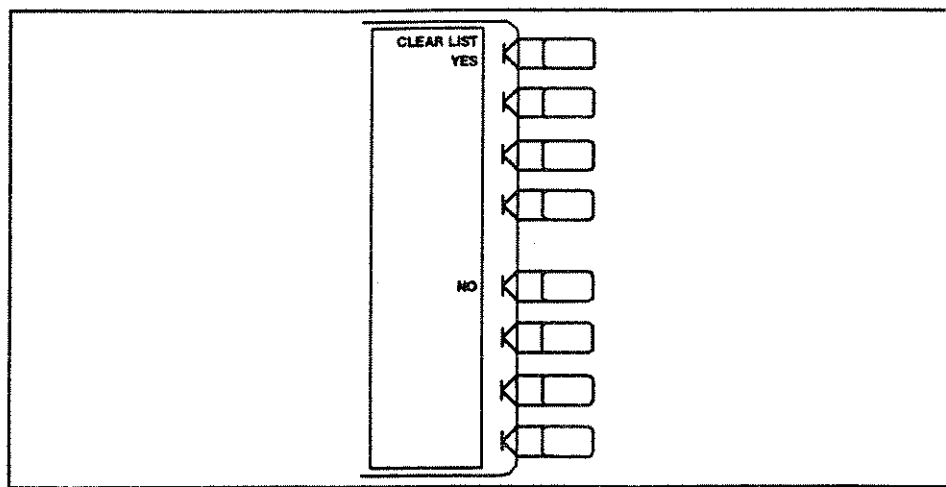

Figure 12-14. Clear Menu

CLEAR LIST YES (BINCEL) clears all BIN settings and returns to the BIN edit menu.

NO returns to the BIN edit menu without clearing BIN settings.

Limit Line and Limit Testing

These are lines drawn on the display to represent upper and lower limits or device specifications with which to compare the device under test. Limits are defined by specifying several segments, where each segment is a portion of the stimulus span. Each limit segment has an upper and a lower starting limit value.

Limits can be defined independently for the two channels, up to 18 segments for each channel (a total of 36 for both channels). These can be in any combination of the two limit types.

Limit testing compares the measured data with the defined limits, and provides pass or fail information for each measurement point. The results are indicated when sweep ends or each data point is measured. An out-of-limit test condition is indicated in the following ways:

- Displaying a FAIL message on the screen
- Emitting a beep
- Displaying an asterisk in tabular listings of data
- Writing a bit into HP-IB event status register B
- Writing LOW-status of PASS/FAIL signal line of the I/O port on the analyzer rear panel. See Appendix C and D.

Limits are entered in tabular form. Limit lines and limit testing can be either ON or OFF while limits are defined. As new limits are entered, the tabular columns on the display are updated, and the limit lines (if on) are modified to the new definitions. The complete limit set can be offset in either stimulus or amplitude value.

An example of a measurement using limit lines and limit testing is provided at the end of this section (See "Using Limit Line Testing").

The series of menus for defining limits are accessed using the **SYSTEM** key. These menus are illustrated in Figure 12-15.

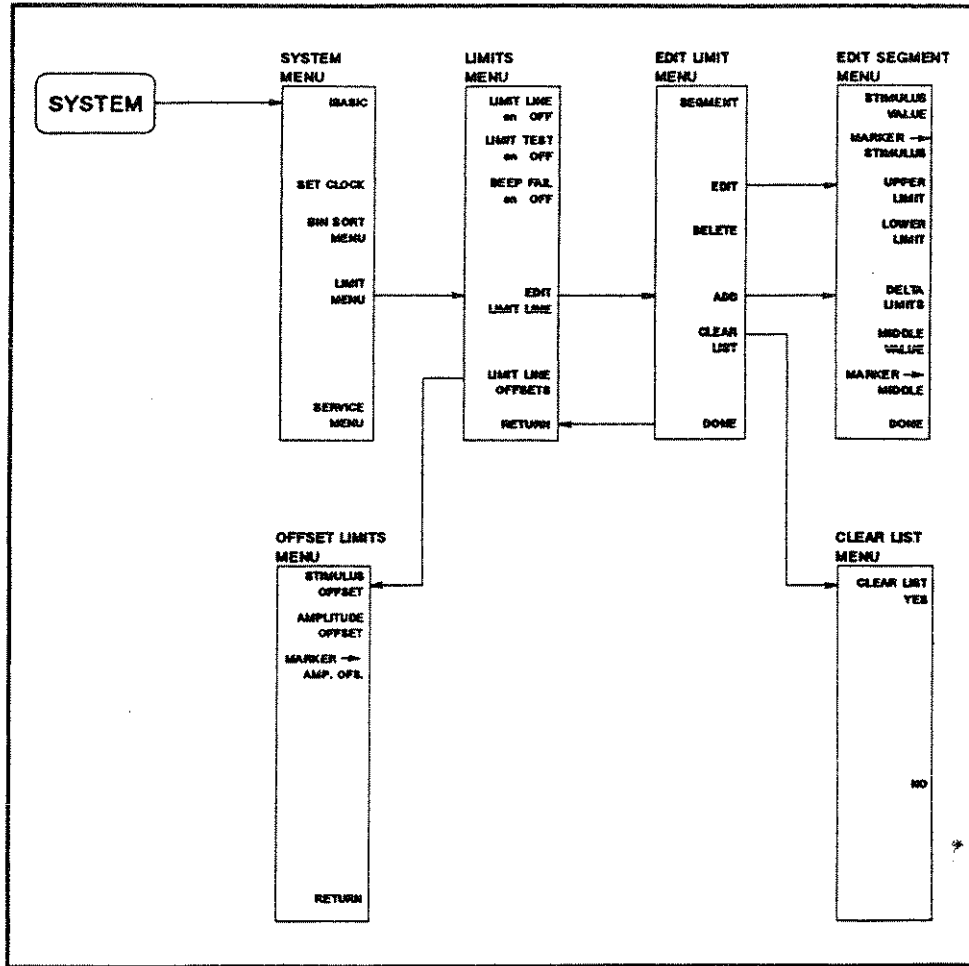

Figure 12-15. Softkey Menus Access from the **LIMIT MENU** softkey.

How Limit Lines are Entered

Before limit lines can be explained, the concept of “segments” must be understood. A segment is the node of two limit lines. See Figure 12-16.

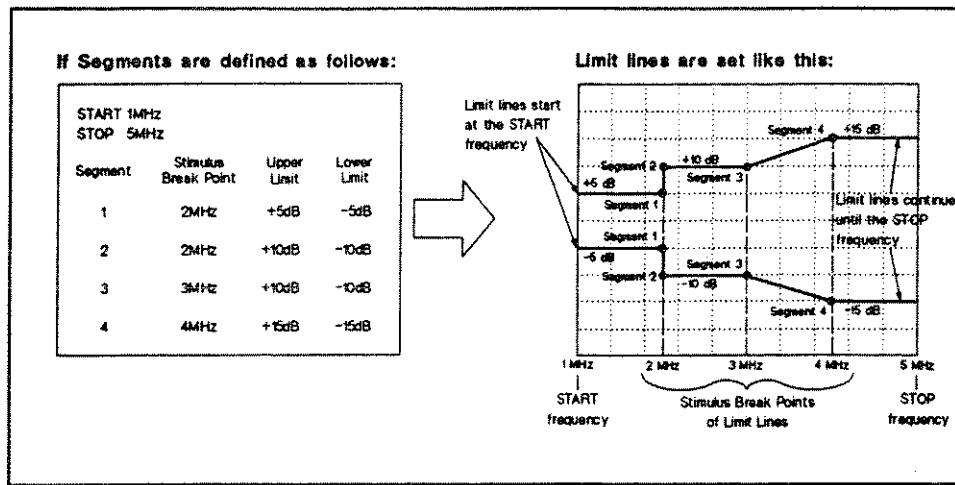

Figure 12-16. The Concept of Segments as a Point between Two Sets of Limit Lines

As you can see in Figure 12-16, segments are distinct points that define where limit lines begin or end. Limit lines span the distance between segments and represent the upper and lower test limits. Figure 12-16 shows another important aspect of limit lines: The most left hand side of set of limit lines will continue from the minimum stimulus value (START), and the most right hand side of set of limit lines will continue until the maximum stimulus value (STOP).

A segment is placed at a specific stimulus value (a single frequency for example). The first segment defines the limit line value from the start frequency to the frequency entered for the first segment. Once its stimulus value is entered, the upper and lower test limit, +5 dB and -5 dB for example, needs to be supplied. The limit line will start at the start frequency and the upper and lower limits set for the first segment and will extend to the frequency and limits values set for the first segment.

Defining a second segment defines where the first set of limit lines ends. This process is repeated to create different sets of limit lines, each having new upper and lower limits. Up to 18 segments can be entered.

Limits can be defined independently for the two channels.

The example in Figure 12-16 shows a combination of limit lines which change instantly and gradually.

Segment 1 is at 2 MHz has upper and lower limits of +5 and -5 dB, respectively. Notice that the upper and lower limit lines start at the START frequency (1 MHz) and end at segment 1.

Segment 2 is also set to at 2 MHz with different upper and lower limits of +10 dB and -10 dB, the limit line value's change is discontinuous from segment 1 to segment 2, creating a step in the limit line.

Segment 3 is at 3 MHz with the same limit value as segment 2 to obtain flat limit lines.

Segment 4 is at 4 MHz with the upper and lower limit values of +15 dB and -15 dB, the limit values change gradually from segment 3 to segment 4. Notice that the upper and lower limit lines then extend from segment 4 to the STOP frequency (5 MHz) while maintaining the same upper and lower limits set for segment 4.

Note

Limit lines cannot be broken along the stimulus axis, so when limit lines are needed partially along the stimulus axis, the non-limit-testing portion must be entered also. Set the non-limit-testing portion by forcing the upper and lower limit values out of range, +500 dB and -500 dB for example.

Both an upper limit and a lower limit (or delta limits) must be defined: if only one limit is required for a particular measurement, force the other limit out of range, +500 dB or -500 dB for example.

Turning Limit Lines Limit Testing On and Off

Limit lines and limit testing features are **OFF** unless explicitly turned **ON** by the user. After entering the limit line data, you may turn **ON** the limit line feature and optionally the limit testing features. Turning these features **OFF** has no effect on the entered limit line data.

Segments Entering Order Needs Notice

Generally, the segments do not have to be entered in any particular order: the analyzer automatically sorts them and lists them on the display in increasing order of stimulus value.

One exception is when two segments have the same stimulus value as described in Figure 12-16. If the same stimulus values exist, the analyzer draws the limit lines according to entered segment order. For example in Figure 12-16, segment 1 should be entered in advance of segment 2.

Saving the Limit Line Table

Limit line data is lost if **PRESET** is pressed or if the line switch is turned **OFF**. However, the **SAVE** and **RECALL** keys can save limit line data along with all other current analyzer settings. Limit line table information can be saved in a disk file.

Offsetting the Stimulus or Amplitude of the Limit Lines

All limit line entries can be offset in either stimulus or amplitude values. An offset will affect all segments simultaneously.

Supported Display Formats

Limit *lines* are displayed only in Cartesian format. In polar format, limit testing at a single value *is* available: the value tested depends on the marker mode and is the magnitude or the first value in a complex pair. The message "NO LIMIT LINES DISPLAYED" is shown on the display using the polar format.

Use a Sufficient Number of Points or Errors May Occur

Limits are checked only at the actual measured data points. If you do not select a sufficient number of points, it is possible for a device to be out of specification without a limit test failure indication.

To avoid this, be sure to specify enough limit points. In addition, if specific stimulus points must be checked, use the list sweep features described in Chapter 8 so that the actual measured data points are checked, exactly.

Displaying, Printing, or Plotting Limit Test Data

The "list values" feature in the copy menu prints or displays a table of each measured stimulus value. The table includes limit line and/or limit test information (if these functions are turned ON). If limit testing is ON, an asterisk "*" is listed next to any measured value that is out of limits.

If the limit lines are ON, and other listed data allows sufficient space, the following will also be displayed:

- Upper limit and lower limit
- The margin by which the device passes or fails the nearest limit

For more information about the list values feature, see "Copy More Menu" in Chapter 13.

Results of Plotting or Printing the Display with Limit Lines ON

If the limit lines are ON, they are included when you print or plot the display. If limit testing is ON, the PASS or FAIL message is included as well.

Limit Menu

This menu independently toggles the limit lines, limit testing, and limit fail beeper. It also leads to the menus that define and modify the limits.

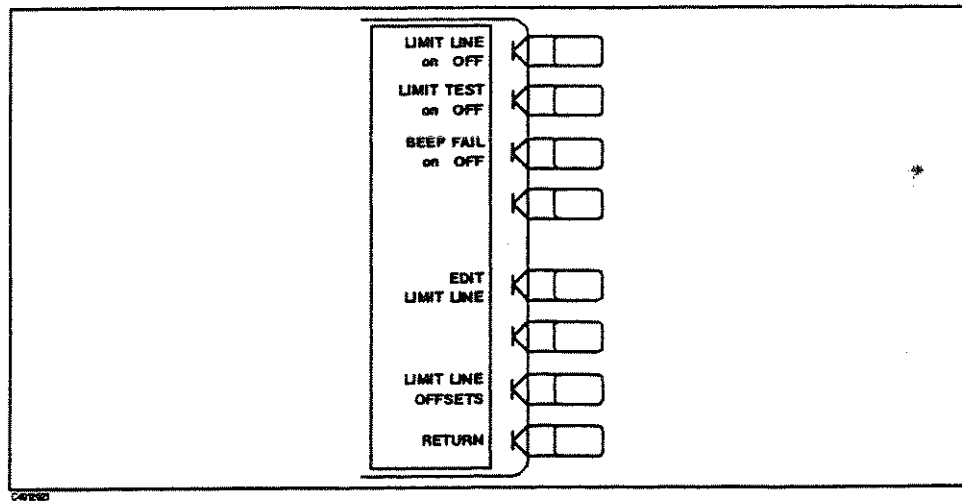

Figure 12-17. Limits Menu

LIMIT LINE on OFF (LIMILINEON, LIMILINEOFF) turns limit lines ON or OFF. To define limits, use the **EDIT LIMIT LINE** softkey described below. If limits have been defined and limit lines are turned ON, the limit lines are shown on the display for visual comparison of the measured data in all Cartesian formats.

If limit lines are ON, they can be saved on the disk with an instrument state. In a listing of values from the copy more menu with limit lines ON and limit test ON, the upper and lower limits are listed together with the pass or fail margins, as long as other listed data allows sufficient space.

LIMIT TEST on OFF (LIMITESTON, LIMITESTOFF) turns limit testing ON or OFF. When limit testing is ON, the data is compared with the defined limits at each measurement point. Limit

tests occur at the end of each sweep, whenever the data is updated and when limit testing is first turned ON.

Limit testing is available for both magnitude and phase values in Cartesian formats. In polar format, the value tested depends on the marker mode and is the magnitude or the first value in a complex pair. The message "NO LIMIT LINES DISPLAYED" is displayed in polar format if limit lines are turned ON.

Five different ways of indications of pass or fail status are provided when limit testing is ON.

- A PASS or FAIL message is displayed at the right of the display.
- The limit fail beeper sounds if it is turned ON.
- In a listing of values using the copy menu, an asterisk * is shown next to any measured point that is out of limits.
- A bit is set in the HP-IB status byte.
- The PASS/FAIL line in the I/O port on the analyzer rear panel goes to a TTL LOW logic level.

BEEP FAIL on OFF (BEEPFAILON, BEEPFAILOFF) turns the limit fail beeper ON or OFF.

When limit testing is ON and the fail beeper is ON, a beep is emitted each time a limit test is performed and a failure is detected. The limit fail beeper is independent of the warning beeper and the operation complete beeper, both of which are described in "Display More Menu" in Chapter 9.

LMT TST ON [] (LIMIOSEND, LIMIOPOIN) toggles when the pass or fail status is indicated, either the end of sweep or the end of measurement at each measurement point. When **[SWP END]** is displayed, the status is indicated when sweep ends. When **[POINT]** is displayed, the status is indicated when the measurement at each point ends.

EDIT LIMIT LINE (EDITLIML) displays a table of limit segments on the lower half of the display. The edit limits menu is presented so that limits can be defined or changed.

LIMIT LINE OFFSETS leads to the offset limits menu, which offsets the complete limit set in either stimulus or amplitude value.

RETURN goes back to the system menu.

Edit Limits Menu

This menu is used to add new segments or select existing segments to be edited. The **ADD** and **EDIT** softkeys in this menu provides the edit segment menu (described later), which lets you select stimulus and limit values.

Note



Before editing the limit lines, it is convenient to turn the limit lines ON using the **LIMIT LINE on OFF** softkey. This displays the limit lines while you are editing.

A table of limit values appears on the display when this menu is provided. A thorough description of how segments work is described at the beginning of this section. Read that information before continuing.

For each segment, the table lists the segment number, stimulus value, upper limit, and lower limit. Limit values can be entered as upper and lower limits or as delta limits with a midpoint values.

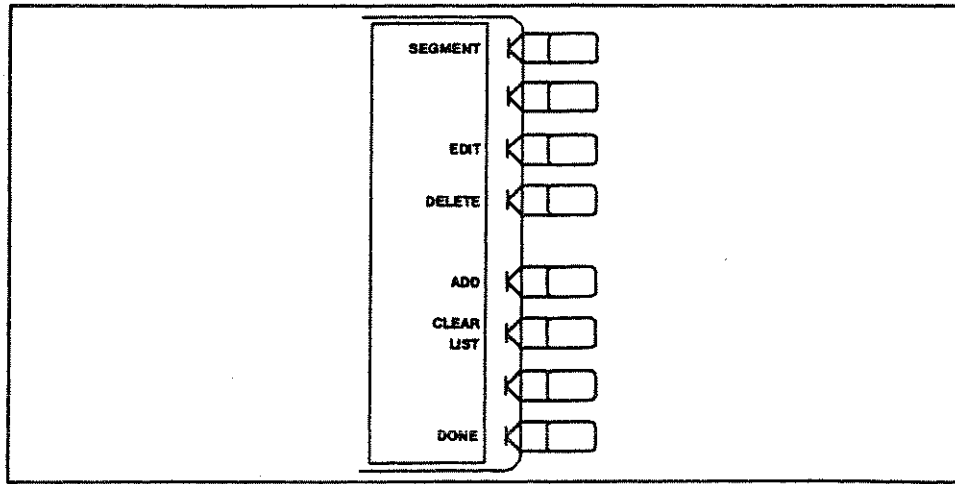

Figure 12-18. Edit Limits Menu

SEGMENT specifies which limit segment in the table is to be edited. A maximum of eight sets of segment values are displayed at one time, and the list can be scrolled up or down to show other segment entries. Use the entry block controls to move the pointer ">" next to the required segment number. The indicated segment can then be edited or deleted. If the table of limits is designated "EMPTY", new segments can be added using the **ADD** or **EDIT** softkey.

EDIT (LIMSEDI) displays the edit segment menu, which defines or modifies the stimulus value and limit values of a specified segment. If the table was empty, a default segment is displayed.

DELETE (LIMSDEL) deletes the segment indicated by the pointer ">".

ADD (LIMSADD) displays the edit segment menu and adds a new segment to the end of the list. The new segment is initially a duplicate of the segment indicated by the pointer ">" and selected with the **SEGMENT** softkey. If the table was empty, a default segment is displayed.

CLEAR LIST leads to the clear list menu, which clears all of the segments in the limit test.

DONE (LIMEDONE) sorts the limit segments and displays them on the display in increasing order of stimulus values. The limits menu is returned to the screen.

Edit Segment Menu

This menu is used to set the value of the individual limit segments. The segment to be modified, or a default segment, is selected in the edit limits menu.

The stimulus value can be set with the controls in the entry block or with a marker (the marker is turned ON automatically when this menu is presented). The limit values can be defined as upper and lower limits, or as delta limits and midpoint values.

As new values are entered, the tabular listing of limit values is updated.

As described in the beginning of this section, generally segments do not have to be listed in any particular order: the analyzer sorts them automatically in increasing order of start stimulus value when the **DONE** key in the edit limits menu is pressed. However, the easiest way to enter a set of limits is to start with the lowest stimulus value and define the segments from left to right of the display, with limit lines turned ON as a visual check.

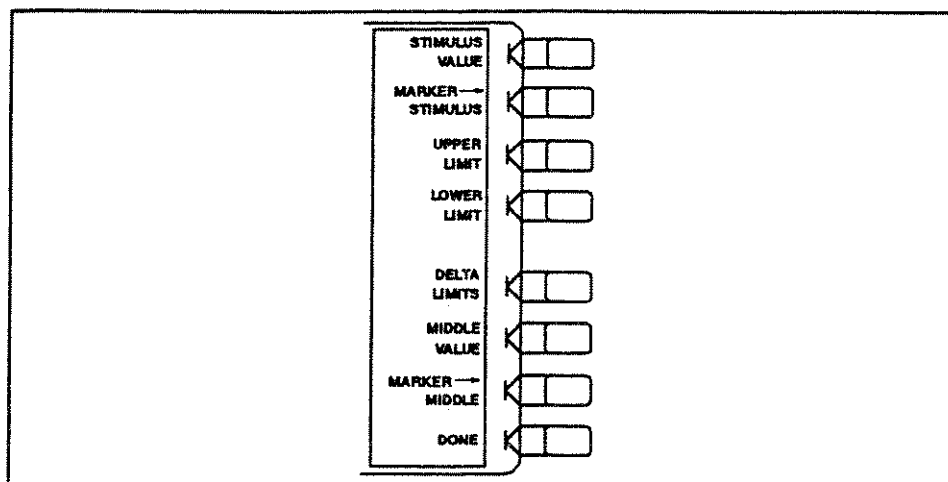

Figure 12-19. Edit Segment Menu

STIMULUS VALUE (LIMS) sets the starting stimulus value of a segment, using entry block controls.

MARKER → STIMULUS (MARKSTIM) sets the stimulus value of a segment using the active marker. Move the marker to the desired starting stimulus value before pressing this key, and the marker stimulus value is entered as the segment stimulus value.

UPPER LIMIT (LIMU) sets the upper limit value for the segment. If a lower limit is specified, an upper limit must also be defined. If no upper limit is required for a particular measurement, force the upper limit value out of range (for example +500 dB)

When **UPPER LIMIT** or **LOWER LIMIT** is pressed, all the segments in the table are displayed in terms of upper and lower limits, even if they were defined as delta limits and midpoint values.

If you attempt to set an upper limit that is lower than the lower limit, or vice versa, both limits will be automatically set to the same value.

LOWER LIMIT (LIML) sets the lower limit value for the segment. If an upper limit is specified, a lower limit must also be defined. If no lower limit is required for a particular measurement, force the lower limit value out of range (for example -500 dB).

DELTA LIMITS (LIMD) sets the limits an equal amount above and below a specified middle value, instead of setting upper and lower limits separately. This is used in conjunction with **MIDDLE VALUE** or **MARKER → MIDDLE**, to set the limits for testing a device that is specified at a particular value plus or minus an equal tolerance.

For example, a device may be specified at -5 dB ±3 dB. Enter the midpoint value as -5 dB and the delta limits as 3 dB.

When **DELTA LIMITS** or **MIDDLE VALUE** is pressed, all the segments in the table are displayed in these terms, even if they were defined as upper and lower limits.

MIDDLE VALUE (LIMM) sets the midpoint for **DELTA LIMITS**. It uses the entry controls to set a specified amplitude value vertically centered between the limits.

MARKER → MIDDLE (MARKMIDD) sets the midpoint for **DELTA LIMITS** using the active marker to set the middle amplitude value of a limit segment. Move the marker to the desired value or device specification, and press this key to make that value the midpoint of the delta limits. The limits are automatically set an equal amount above and below the marker.

DONE (LIMSDON) terminates a limit segment definition, and returns to the edit limits menu.

Clear List Menu

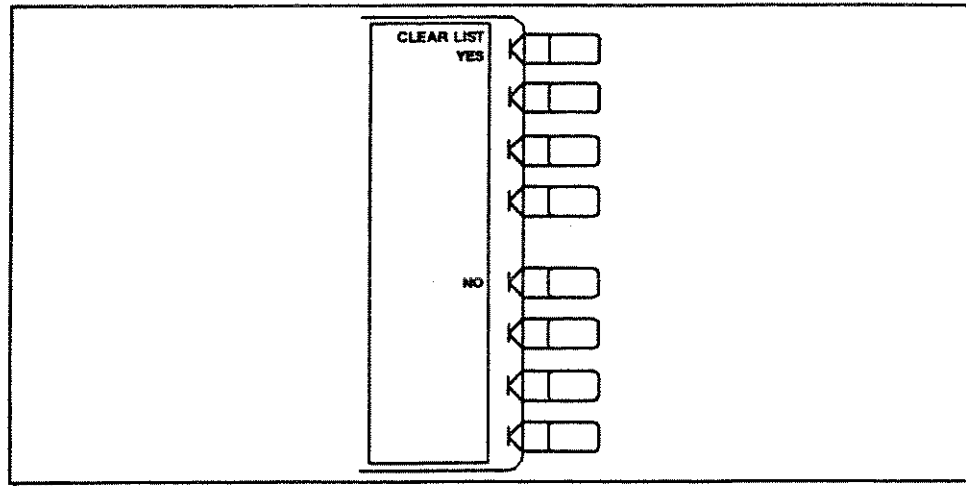

Figure 12-20. Clear List Menu

CLEAR LIST YES (LINCLEL) clears all of the segments in the limit line and returns to the edit limit menu.

NO cancels clearing the segment and returns to the edit limit menu.

Offset Limit Menu

This allows all segments to be offset in either stimulus value or amplitude value. This is useful for changing the limits to correspond with a change in the test setup, or for device specifications that differ in stimulus or amplitude.

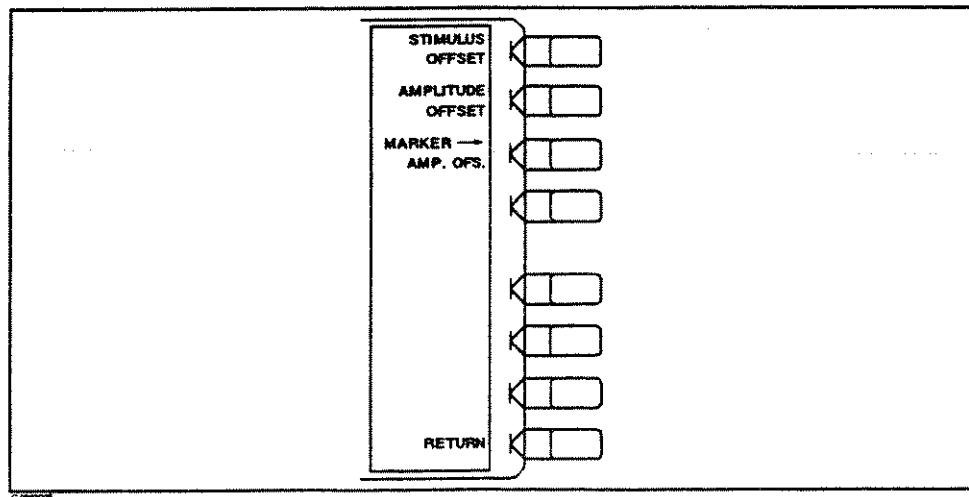

Figure 12-21. Offset Limit Menu

STIMULUS OFFSET (LIMISTIO) adds to or subtracts an offset from the stimulus value. This allows limits already defined to be used for testing in a different stimulus range. Use the entry block controls to specify the offset required.

AMPLITUDE OFFSET (LIMIAMP0) adds or subtracts an offset in amplitude value. This allows previously defined limits to be used at a different power level. For example, if attenuation is added to or removed from a test setup, the limits can be offset an equal amount.

MARKER → AMP. OFS. (LIMIMAOF) uses the active marker to set the amplitude offset. Move the marker to the desired middle value of the limits and press this softkey. The limits are then moved so that they are centered an equal amount above and below the marker at that stimulus value.

RETURN goes back to the limit line menu.

Using Limit Line Testing

The analyzer has limit line/testing functions for go/no-go testing. The limit lines define upper and lower limits, and the limit testing function compares the measured data to the limit lines and indicates the result. The following is a practical example of setting up limit lines for testing a bandpass filter.

Example of Limit Lines for Filter Testing

The following is an example of creating limit lines to test a 70 MHz crystal bandpass filter.

Instrument Setting

Press **PRESET** and then change these measurement settings:

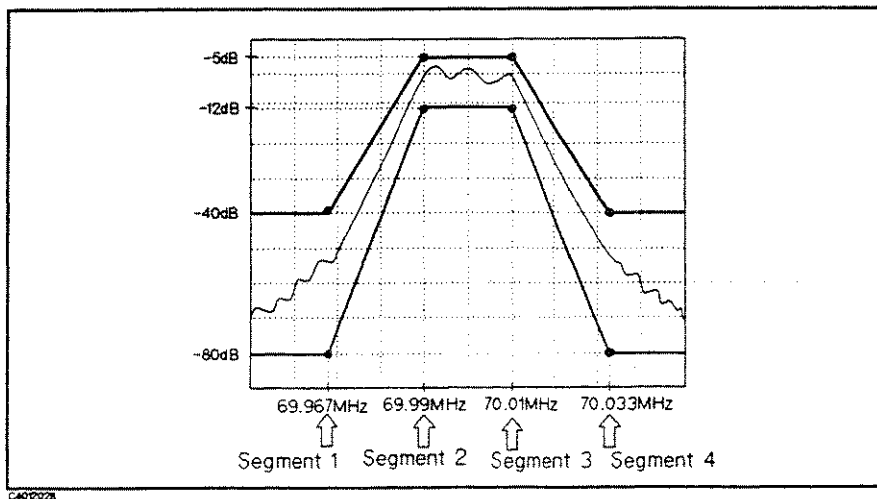

Figure 12-22. Limit Line Example

	Desired Setting	Key Strokes
Channel Block	Select channel 1	CH 1 (default)
Response Block	Select A/R measurement Select LOG MAG format	Press MEAS A/R FORMAT LOG MAG (default)
Stimulus Block	Center frequency 70 MHz Span frequency 100 kHz Number of points 401	Press CENTER 70 (M/μ) Press SPAN 100 (k/m) Press MENU NUMBER of POINTS 401 (x1)

Creating Limit Lines

Perform the following procedure, see Figure 12-23.

1. Press **(SYSTEM)** **LIMIT MENU** **LIMIT LINE** on **OFF** to **ON**
2. Press **EDIT LIMIT LINE** **EDIT**
3. For segment 1:
 - Press **STIMULUS VALUE** 69.967 **(M/μ)**
 - Press **UPPER LIMIT** -40 **(x1)**
 - Press **LOWER LIMIT** -80 **(x1)** **DONE**
4. For segment 2:
 - Press **ADD STIMULUS VALUE** 69.99 **(M/μ)**
 - Press **UPPER LIMIT** -5 **(x1)**
 - Press **LOWER LIMIT** -12 **(x1)** **DONE**
5. For segment 3:
 - Press **ADD STIMULUS VALUE** 70.01 **(M/μ)** **DONE**
6. For segment 4:
 - Press **ADD STIMULUS VALUE** 70.033 **(M/μ)**
 - Press **UPPER LIMIT** -40 **(x1)**
 - Press **LOWER LIMIT** -80 **(x1)** **DONE**
7. Press **DONE**

Note



The limit line segments do not have to be entered in any particular order: the analyzer automatically sorts them and lists them on the display in increasing order of stimulus value.

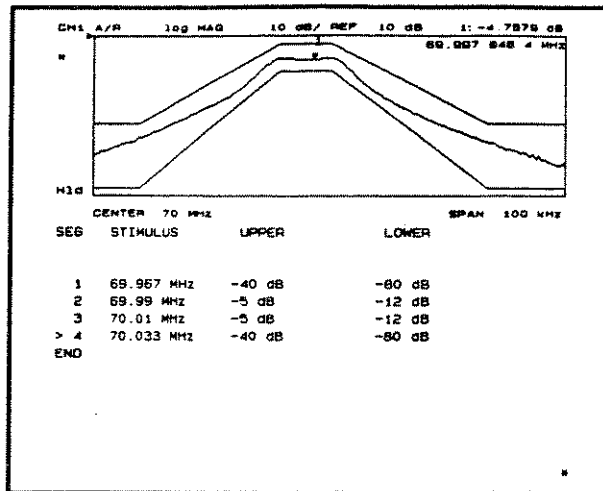

Figure 12-23. Editing the Limit Lines

Modifying Limit Lines Using The Rotary Knob and Marker

Any individual segment (and its associated limit lines) can be edited after creation. Using the marker and rotary knob is a very convenient way to modify limit lines. Use the following procedure:

1. To enter the actual measurement point for segments, press **(MKR) MARKER MODE MENU** **MARKER-DISCRETE** to place the marker on an actual measurement point only.
2. Press **(SYSTEM) LIMIT MENU EDIT LIMIT LINE**
3. Press **SEGMENT** (appropriate number) **(X1) EDIT**
4. To modify the upper/lower values:
Press **UPPER LIMIT** or **LOWER LIMIT** and rotate the knob.
5. To modify the stimulus point:
Press **(ENTRY OFF)** and move the marker to appropriate point, then press **MARKER-STIMULUS**.
Or press **STIMULUS VALUE** and rotate the knob.
6. Press **DONE**

Performing Limit Test

Press **LIMIT TEST** on **OFF** to **ON** to perform limit testing using the just edited limit lines. When the limit lines and testing are turned ON, an out-of-limit test result is normally indicated in six ways:

- With a FAIL message on the screen.
- With a beep (on/off selectable).
- With an asterisk in tabular listings of data (under **(COPY)**).
- With a bit in HP-IB event status register B.
- With a bit in the I/O port on the rear panel.
- With HP-IB commands OUTPLIMF?, OUTPLIMIL? and OUTPLIMM?.

Example 2. Separated Limit Lines

Figure 12-24 shows separated limit lines and its editing table example. This can be used for filter testing which only requires insertion loss limits. Dummy limit values (+500000 for upper and -500000 for lower, for example) should be entered for the no limit areas.

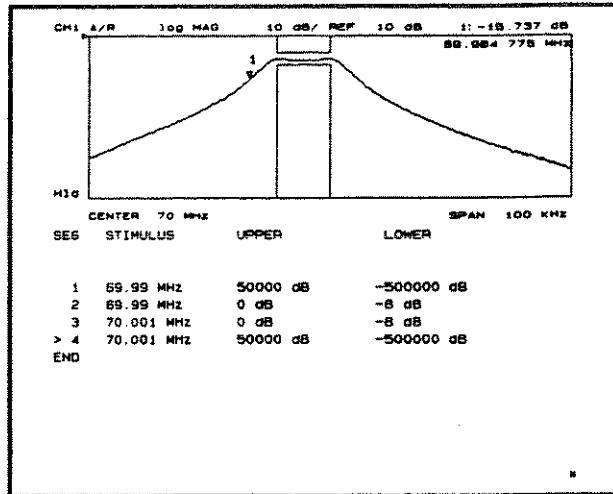

Figure 12-24. Limit Lines Example 2 (Separated Limit Lines)

Note



Limits are checked only at each of the actual measured data points. It is possible for a device to be out of specification without a limit test failure indication if you do not select sufficient stimulus points within a segment.

Note



Combining the limit test and the list sweep function, high throughput limit line/testing can be performed for go/no-go testing. For detail information on the list sweep, see Chapter 8.

Note



Limit line information is lost if you press **PRESET** or turn OFF the power. However, the **SAVE** keys can save the limit line information along with all other current instrument settings when the limit lines are on. See Chapter 14 for details.

Making Hard Copies

Introduction

About Making Hard Copies, Where Compatible Printers and Plotters are Mentioned

The analyzer can use HP-IB to output measurement results directly to a compatible printer or plotter, without the use of an external controller. The information shown on the display can be copied to a compatible Hewlett-Packard plotter or graphics printer. A plotter provides better resolution than a printer for data displays, while a printer provides higher speed for tabular listings. See Chapter 2 for information about compatible plotters and printers.

Where to Find Tutorial Information

Tutorial information on how to plot or print is supplied in "Using Printer and Plotter"

Printing/Plotting with or without a Controller on the Bus

To generate a plot or printout from the front panel when there is no other controller on the bus, the analyzer must be in the system controller HP-IB mode. If a controller is connected to the analyzer, the analyzer must take control from the controller to initiate a hard copy. To do this, the analyzer must be in the addressable mode by receiving a pass control command from the controller. The controller essentially gives the analyzer permission to control the bus.

See "Bus Mode" in Chapter 15 for HP-IB controller modes and "(LOCAL) Key" in Chapter 12 for setting addresses.

Note



The ASCII Save menu is provided under the (SAVE) key to save the graphics image on the screen in an HP-GL file on the disk. For more information, see Chapter 14.

Print/Plot Buffer

The analyzer can continue operation while a hard copy is in progress. To abort a hard copy before it is finished, press **COPY ABORT**. If a hard copy is in progress and a second hard copy is attempted, the message "PRINT/PLOT IN PROGRESS, ABORT WITH COPY ABORT" is displayed and the second attempt is ignored. An aborted hard copy cannot be continued: the process must be initiated again if a copy is still required.

COPY Key

The HP-IB programming command is shown in parenthesis following the key or softkey.

The **COPY** key provides access to the menus used for controlling external plotters and printers and defining the plot parameters.

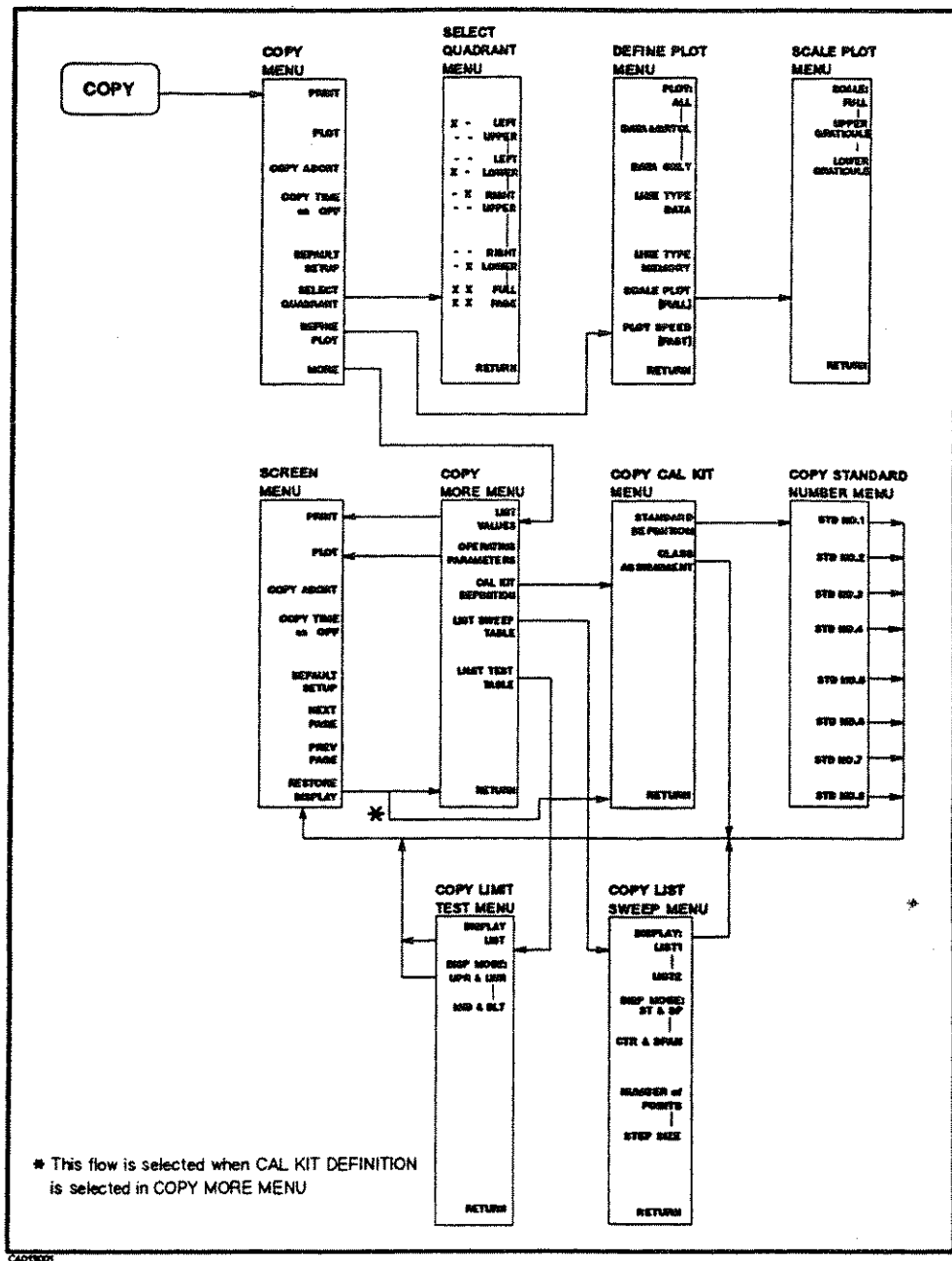

Figure 13-1. Softkey Menus Accessed from the **COPY** Key

Copy Menu

This copies the display to a printer or to a plotter using the default plot parameters, without the need to access other menus. For user-defined plot parameters, a series of additional menus is available.

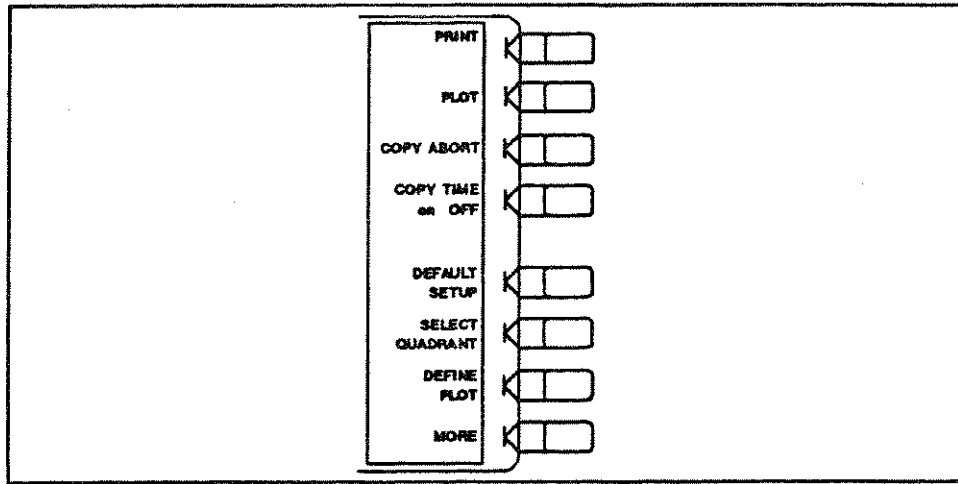

Figure 13-2. Copy Menu

When the print or plot function is engaged, the analyzer takes a “snapshot” of the display and sends it to the printer or plotter through a buffer. Once the data is transferred to the buffer, the analyzer is free to continue measurements while the data is being printed or plotted.

PRINT (PRINALL) causes an exact copy of the display to be printed.

PLOT (PLOT) plots the display to a compatible HP graphics plotter, using the currently defined plot parameters (or default parameters). Any or all displayed information can be plotted, except the softkey labels and the frequency list table in EDIT mode, or limit table in EDIT mode. (List values, operating parameters, or cal kit definition can be plotted using the screen menu explained later in this chapter. However, this is considerably slower than printing.)

Note Before pressing **PRINT** or **PLOT**, you must:



- set the analyzer to the system controller mode.
- make sure the analyzer's plotter HP-IB address and the plotter set HP-IB address match.

COPY ABORT (COPA) aborts a plot or print in progress.

COPY TIME on OFF (COPTON, COPTOFF) turns the “time stamp” ON or OFF for a print or plot. When you select print, the time and date are printed out first, followed by the information shown on the display. When you select plot, the time and date are plotted on the message area. See “(SYSTEM) Key” in Chapter 12 for setting the internal clock.

DEFAULT SETUP (DFLT) resets the plotting parameters to their default values. These defaults are as follows:

Table 13-1. Default Plotting Parameters

- Select quadrant: Full page
- Define plot: All plot elements ON
- Plot scale: Full
- Plot speed: Fast
- Line type: 7 (solid line) for both trace and memory

Default setups do not apply to printing.

SELECT QUADRANT leads to the select quadrant menu, which provides the capability of drawing quarter-page plots. This is not used for printing.

DEFINE PLOT leads to the define plot menu, which specifies which elements of the display are to be plotted. This is not used for printing.

MORE leads to the copy more menu, which prints or plots the measurement value list, operation parameter list, calibration kit definition list, list sweep table, or limit test table.

Select Quadrant Menu

This selects a full-page plot, or a quarter-page plot in any quadrant of the page.

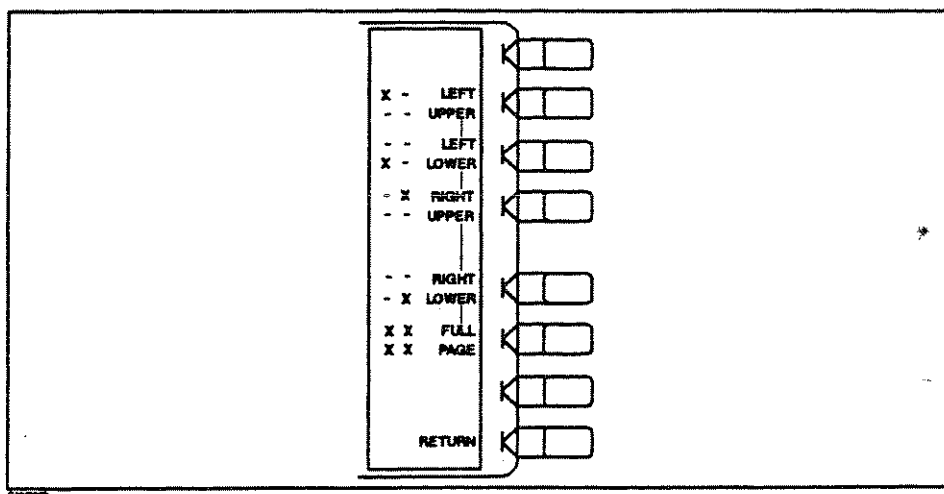

Figure 13-3. Select Quadrant Menu

LEFT UPPER (LEFU) draws a quarter-page plot in the upper left quadrant of the page.

LEFT LOWER (LEFL) draws a quarter-page plot in the lower left quadrant of the page.

RIGHT UPPER (RIGU) draws a quarter-page plot in the upper right quadrant of the page.

RIGHT LOWER (RIGL) draws a quarter-page plot in the lower right quadrant of the page.

FULL PAGE (FULP) draws a full-size plot according to the scale defined with **SCALE PLOT** in the define plot menu (described next).

RETURN returns to the copy menu.

Define Plot Menu

This menu allows selective plotting of portions of the measurement display. Different plot elements can be turned ON or OFF as required. In addition, different selections are available for plot speed and plot scale, to allow plotting on transparencies and preprinted forms.

The definition selected in this menu affects the save graphics function under the **SAVE** key, which saves a graphics screen image in an HP-GL file on the disk.

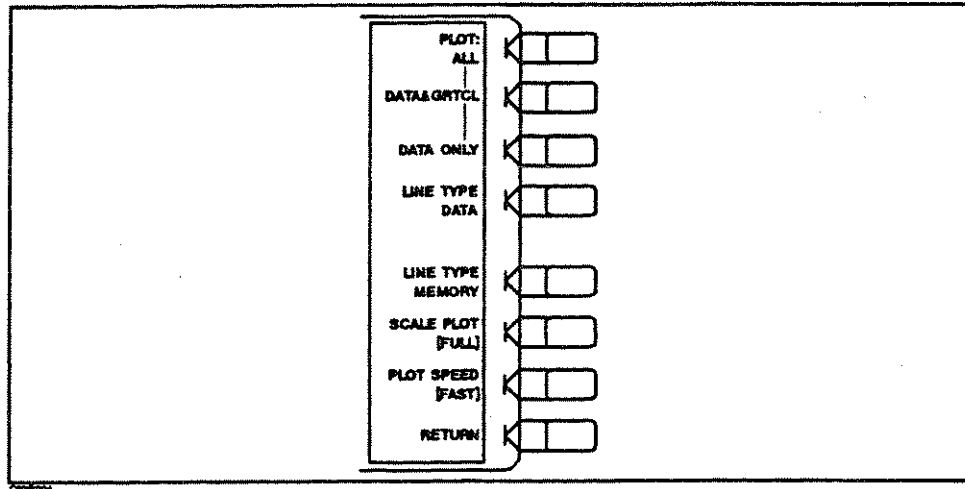

Figure 13-4. Define Plot Menu

Pen Numbers

Pen numbers for each display elements are fixed as follows:

Table 13-2. Pen Numbers

Display Element	Channel 1	Channel 2
Data	1	2
Memory	5	6
Graticule	3	3
Text	1 / 4 / 5	2 / 4 / 6
Marker	1 / 5	2 / 6

PLOT: ALL (PLOTALL) selects to plot all the information displayed on the display except for the softkey labels.

DATA & GRATCL (PLOTGRAT) selects to plot the measured data and memory data, and also the graticules.

DATA ONLY (PLOTONLY) selects to plot only the measured data and memory data.

LINE TYPE DATA (LINTDATA) selects the line type of the trace data for plotting. The default line is a solid unbroken line. If line type is set to zero, the trace data on the screen is also specified dots only at measurement points.

LINE TYPE MEMORY (LINTMEMO) selects the line type of the trace memory for plotting. The default line type is a solid unbroken line. If line type is set to zero, the trace memory on the screen is also specified dots only at measurement points.

SCALE PLOT leads to the scale plot menu, which selects a plot scale.

PLOT SPEED (PLOSFAST, PLOSSLOW) provides two plot speeds, **FAST** and **SLOW**. Fast is the proper plot speed for normal plotting. Slow plot speed is used for plotting directly on transparencies: the slower speed provides a more consistent line width.

RETURN returns to the copy menu.

Scale Plot Menu

This menu selects a plot scale, **FULL**, **UPPER GRATICULE**, and **LOWER GRATICULE**.

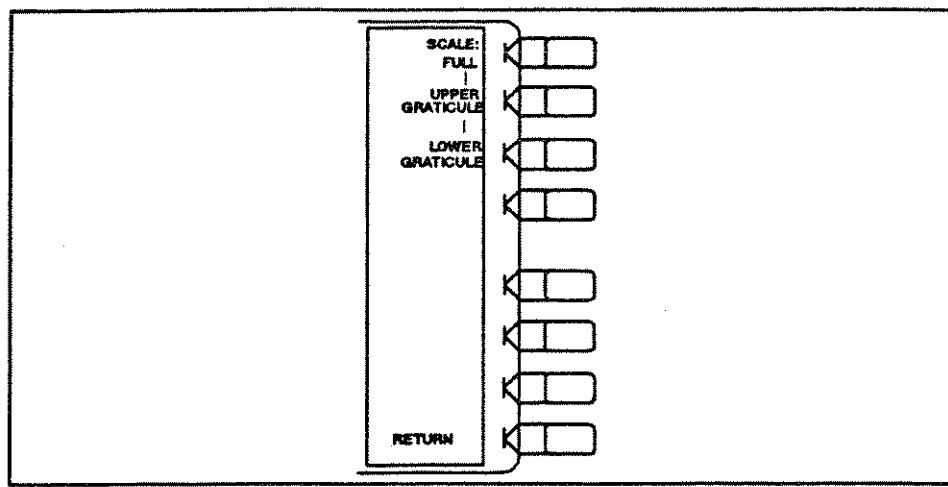

Figure 13-5. Scale Plot Menu

SCALE: FULL (SCAPFULL) selects the normal full size scale for plotting on blank paper, and includes space for all display annotations such as marker values, stimulus values, etc. The entire display fits within the user-defined boundaries of P1 and P2 on the plotter, while maintaining the exact same aspect ratio as the display.

UPPER GRATICULE, **LOWER GRATICULE** (SCAPGU, SCAPGL) expands or reduces the horizontal and vertical scale so that the graticule lower left and upper right corners exactly correspond to the user-defined P1 and P2 scaling points on the plotter. In the dual display mode, the applicable graticule is channel 1 for **UPPER GRATICULE**, or channel 2 for **LOWER GRATICULE**. This is convenient for plotting on preprinted rectangular or polar forms.

To plot on a rectangular preprinted graticule, set P1 of the plotter at the lower left corner of the preprinted graticule, and set P2 at the upper right corner.

To plot on a polar format as an accurate circle, set P1 and P2 so that a rectangle defined by P1 and P2 become a square because the outer circumference is identical to an inscribed circle in the rectangle.

When the display is split (for example, **SPLIT DISP ON**, **MKR LIST ON**), **UPPER** set the upper graticule to the plot area defined P1 and P2 and **LOWER** set the lower graticule to the plot area. When the display is not split, **UPPER** and **LOWER** are the same. (See Figure 13-6.)

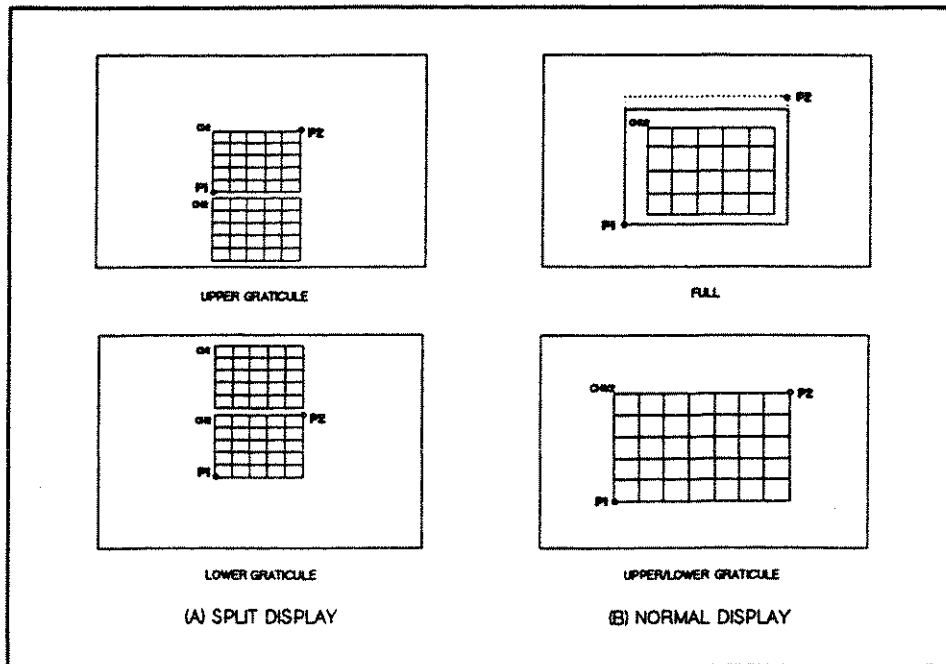

Figure 13-6. Full, Upper, and Lower Graticule

Copy More Menu

This menu provides tables of operating parameters, measured data values, and cal kit definitions, which can be copied from the screen to a printer or plotter.

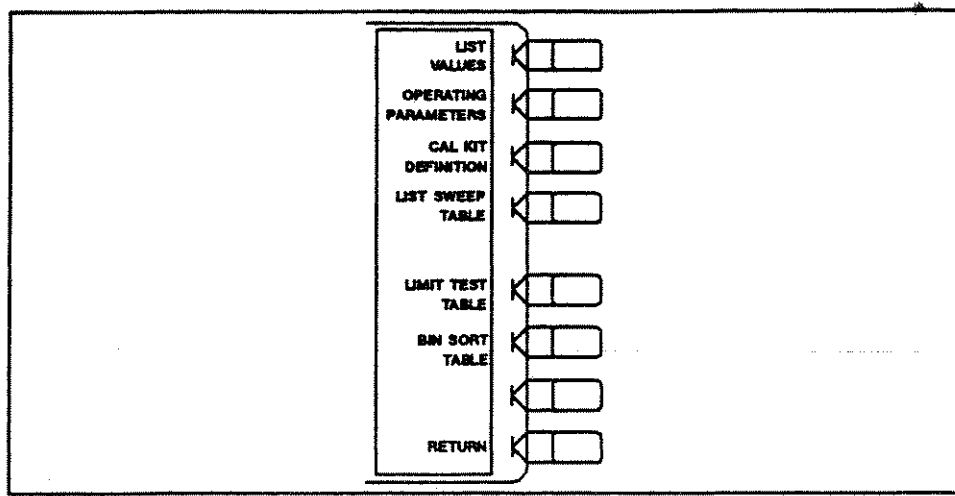

Figure 13-7. Copy More Menu

LIST VALUES (LISV) provides a tabular listing of all the measured data points and their current values, together with limit information if the limit test is ON. At the same time, the screen menu is presented to enable hard copy listings and access new pages of the table. Twenty one lines of data are listed on each page, and the number of pages is determined by the number of measurement points specified in the stimulus menu.

Table 13-3 shows data listed on the screen when **DUAL CHAN** is **OFF**. The margin listed is smaller difference value between measurement value and either upper limit or lower limit. When plus margin means the test is pass, and minus means fail.

LIST VALUES lists log magnitude values when the log magnitude format is selected as the display format, even if impedance (Z:trans) or admittance (Y:trans) is displayed using Conversion function (and markers show absolute values).

Table 13-3. List Value Format

Display Format	Column Number				
	1	2	3	4	5
LOG MAG PHASE DELAY LIN MAG REAL IMAGINARY EXPANDED PHASE	Stimulus	Measurement Data ¹	Margin ²	Upper Limit Value ²	Lower Limit Value ²
POLAR LOG MAG & PHASE LOG MAG & DELAY	Stimulus	Measurement Data ¹	Measurement Data	Upper Limit Value ²	Lower Limit Value ²

1 * is displayed at the left hand of measurement value when the it fails in the limit testing.

2 This is listed when the limit test is ON.

When **DUAL CHAN** is **ON**, stimulus values are listed in the first column, measurement data of the active channel are listed in the second and third columns, and the non-active channel data are listed in the fourth and fifth columns. The value listed for each channel are the same as data listed in the second and third columns in Table 13-3.

If **DUAL CHAN** is **ON** and **COUPLED CH IS OFF**, only active channel measurement data is listed.

OPERATING PARAMETERS (OPEP) provides a tabular listing on the display of the key parameters for both channels. The screen menu is presented to allow hard copy listings and access new pages of the table. Four pages of information are supplied. These pages list operating parameters, marker parameters, lists, and system parameters that relate to control of peripheral devices rather than selection of measurement parameters. The listed parameters are as follows:

- Number of points
- Sweep time
- Source power
- IF bandwidth
- Averaging factor
- Averaging switch
- Smoothing aperture
- Smoothing switch
- Group delay aperture
- Calibration kit
- Z₀
- Calibration type
- Stimulus conditions when the calibration was performed
- Phase offset
- Input R and A extension

■ Velocity factor

CAL KIT DEFINITION provides the copy cal kit menu which prints/plots the calibration kit definitions.

LIST SWEEP TABLE provides a tabular listing on the display of the list sweep table.

LIMIT TEST TABLE provides a tabular listing on the display of the limit value for limit testing.

BIN SORT TABLE provides a tabular listing on the display of the BIN definition value for the BIN sorting.

RETURN returns to the copy menu.

Copy Cal Kit Menu

This provides a tabular listing of the calibration kit definitions. The lists can be hard copied using the copy function. The elements are all the standard and class assignments.

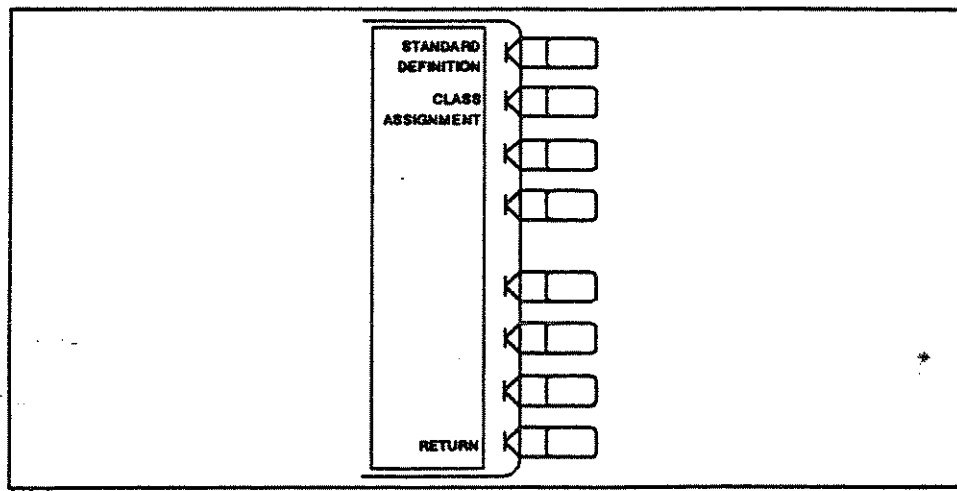

Figure 13-8. Copy Cal Kit Menu

STANDARD DEFINITION provides the copy standard number menu which selects which standard settings are to be hard copied.

CLASS ASSIGNMENT (CALCASSI) shows the tabular listing of the calibration kit class assignment, and provides the screen menu to prepare for hard copy.

RETURN returns to the copy more menu.

Copy Standard Number Menu

This selects which standard is to be hard copied.

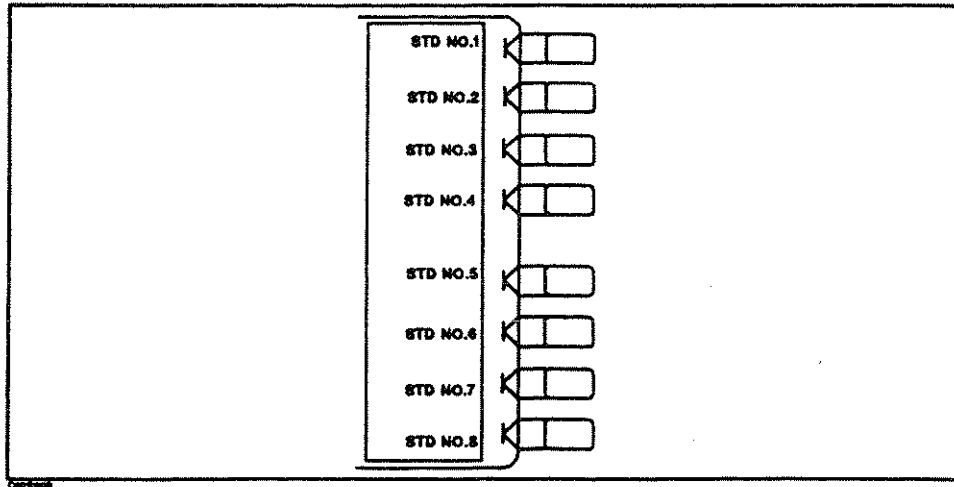

Figure 13-9. Copy Standard Number Menu

STD NO. n (CAL) provides the tabular listing of the standard definitions of the standard number *n*, and provides the screen menu to prepare for hard copy.

Copy List Sweep Menu

This selects one applicable list sweep table, and defines in what format the list sweep table is to be displayed and hard copied.

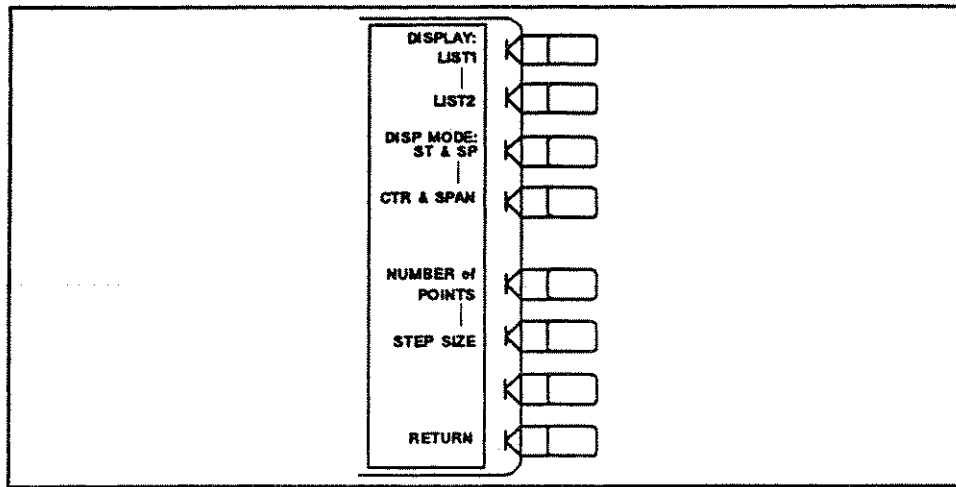

Figure 13-10. Copy List Sweep Menu

DISPLAY: LIST1 (DISL1) selects list sweep Table 1 to be displayed and hard copied.

LIST2 (DISL2) selects list sweep Table 2 to be displayed and hard copied.

DISP MODE: ST & SP (DISMSTSP) displays the list sweep stimulus range in terms of Start and Stop.

CTR & SPAN (DISMCTSP) displays the list sweep stimulus range in terms of Center and Span.

NUMBER of POINTS (DISMNUM) displays the list sweep stimulus resolution in terms of Number of Points.

STEP SIZE (DISMSTEP) displays the list sweep stimulus resolution in terms of Step Size.

Copy Limit Test Menu

This defines in what format the limit testing table is to be displayed and hard copied.

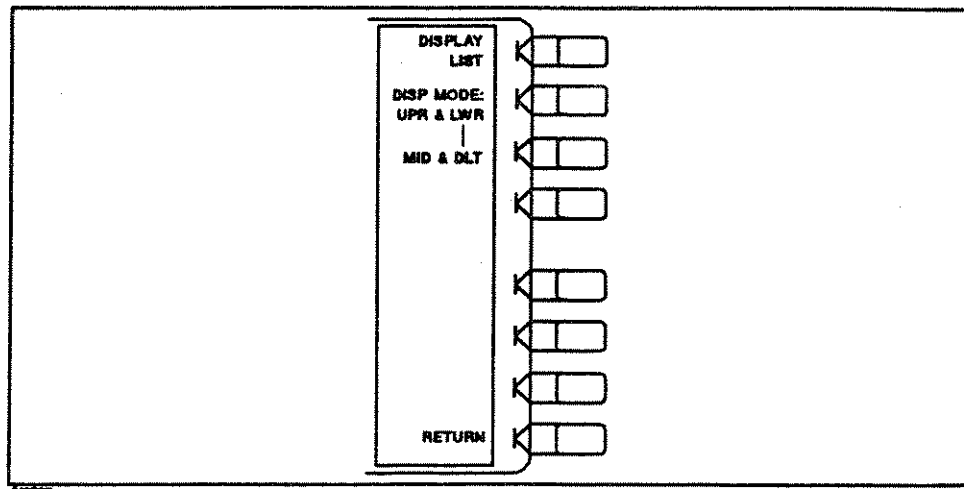

Figure 13-11. Copy Limit Test Menu

DISPLAY LIST (DISLLIST) displays the limit testing table on the display, and provides the screen menu to prepare for hard copy.

DISP MODE: UPR & LWR (DISMUL) selects the upper and lower format, which displays the limit values by upper limit and lower limit.

MID & DLT (DISMMD) selects the middle and delta format, which displays the limit values by middle value and maximum deviation (limit value) from the midpoint value.

Screen Menu

This menu is used in conjunction with the **LIST VALUES**, **OPERATING PARAMETERS**, **CAL KIT DEFINITION**, **LIST SWEEP TABLE**, and **LIMIT TEST TABLE** features, to make hard copy listings of the tables displayed on the screen. To make copies from the front panel, make sure that the analyzer is the system controller (see Chapter 12).

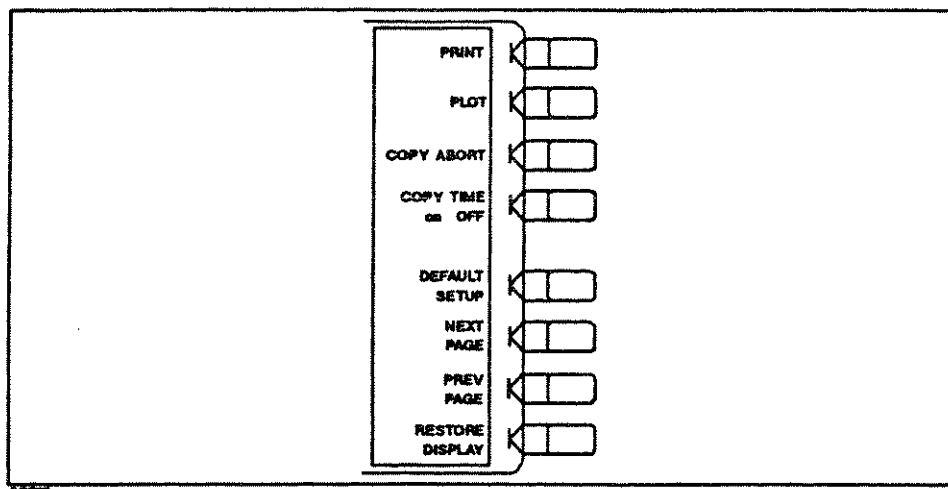

Figure 13-12. Screen Menu

PRINT (PRINALL) copies one page of the tabular listings to a compatible HP graphics printer.

PLOT (PLOT) plots one page of the tabular listing on the display using the current setup (defined in **SELECT QUADRANT** and **DEFINE PLOT**). Plot size and speed can be change in **DEFINE PLOT MENU** if you want.

Note Before pressing **PRINT** and **PLOT**, you must:



- set the analyzer to the system controller mode.
- make sure the analyzer's printer HP-IB address and the printer set HP-IB address match.

COPY ABORT (COPA) aborts a plot or print in progress.

COPY TIME on OFF (COPTON, COPTOFF) turns printing or plotting time and date ON or OFF. When you select print, the time and date are printed first, then the information displayed on display. When you select plot, time and date are plotted just below the title area. See "**SYSTEM Key**" in Chapter 12 for setting the internal clock.

PRINT/PLOT SETUPS presents the print/plot setups menu. Graphics printer and plotter are set from this menu.

NEXT PAGE (NEXP) displays the next page of information in a tabular listing onto the display.

PREV PAGE (PREP) displays the previous page of information in a tabular listing onto the display.

RESTORE DISPLAY (RESD) turns OFF the tabular listing and returns the measurement display to the screen.

Using Printer and Plotter

This section describes key features and the basic procedure of using the printing/plotting functions.

Preparing Printers/Plotters

The HP graphics printers and plotters that have an HP-IB interface can be used (See Chapter 2). Connect a printer or plotter to the HP 87510A with an HP-IB cable. The HP-IB address should be set as follows:

- Printer : set to address 1
- Plotter : set to address 5

Available Displays To Print/Plot

- The display on any of the display formats
- List values (tabular format) All the measured data points and limit information (if it is turned ON) are listed.
- Operating parameters (tabular format) The instrument states (key parameters for both channels) are listed.
- Calibration kit definition (tabular format)

The sweep list and limit lines editing display can be output only by using an external computer.

To display the tabular format, press **COPY** **MORE**, and **LIST VALUES**, **OPERATING PARAMETERS**, or **CAL KIT DEFINITION**.

Output with The Time/Date

The analyzer can print or plot the display with the time and date by pressing **COPY** **COPY TIME on OFF** to **ON**.

Adding a Title

To print or plot a display with a comment, you can enter a *title* on the display. Create a title using **TITLE** under the **DISPLAY**. (See Chapter 9.) The title will be printed or plotted with the data.

Printing Procedure

1. To set the analyzer to the system controller mode, press **LOCAL** **SYSTEM CONTROLLER**.
2. If needed, set the time and title (see "Output with The Time/Date" and "Adding a Title").
3. Press **COPY**.
4. Press **PRINT** to start printing.

If you need to abort printing, press **COPY ABORT**.

Plotting Procedure

1. To set the analyzer to the system controller mode, press **LOCAL** **SYSTEM CONTROLLER**.
2. If needed, set the time and title (see "Output with The Time/Date" and "Adding a Title").
3. Press **COPY**.
4. If needed, press **DEFINE PLOT** to select the display elements to be plotted.
 - a. To plot all information on the display, press **PLOT: ALL**.
 - b. To plot traces and graticules only, press **DATA & GRATCL**.
 - c. To plot traces only, press **DATA ONLY**.

Then press **RETURN**.

5. Press **PLOT** to start plotting.

Printing and Plotting Troubleshooting

1. Look for an error message on the CRT. (See *Error Messages*.)
2. Make sure the printer/plotter is plugged in, turned ON, connected to the analyzer, and loaded with paper.
3. Make sure the analyzer is in the system controller mode. Press **LOCAL** **SYSTEM CONTROLLER**.
4. Make sure the HP-IB address of the device and the address recognized by the analyzer match (see Chapter 1).
5. Replace the HP-IB cable.
6. If all of the above fails, contact Hewlett-Packard for assistance.

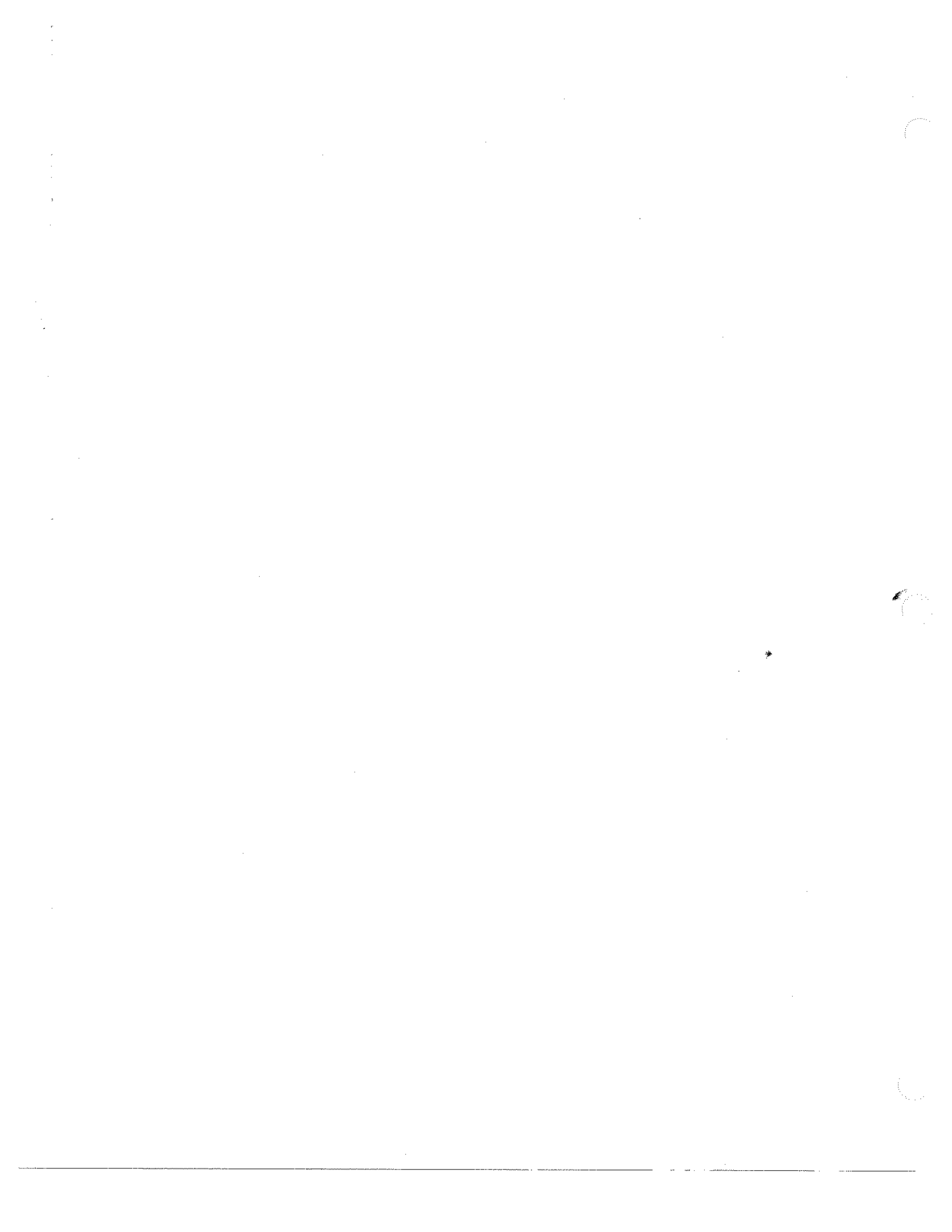

Saving and Recalling Instrument States and Data

Introduction

This chapter describes how to save and recall instrument states and data for later retrieval using the built-in disk drive and the RAM disk memory.

This chapter explains the following:

- What information is saved
- **SAVE**, **RECALL** key menu description

Note



The **SAVE** and **RECALL** keys do not access Instrument BASIC programs. Instrument BASIC has its own menus (under **SYSTEM** key) for accessing the built-in disk drive. See "Instrument BASIC" in Chapter 12 for detail.

Storage Devices

The analyzer supports two storage devices, a built-in flexible disk drive and a RAM disk memory. The flexible disk drive is suited to storing large numbers of files and long term data storage. RAM disk is suited to storing tentative data and instrument states and to store or get data quickly.

Note



Use the built-in flexible disk to store important data, because the RAM disk data is lost when the power to the RAM disk memory is lost for more than 72 hours. The operating time of the battery backup for RAM disk memory is approximately 72 hours after the analyzer is turned OFF.

File Types and Data Saved

Binary Files and ASCII Files

The analyzer supports two file formats, binary and ASCII, in which to save data on a disk and memory. Binary files are used to save measurement conditions and data using the SAVE function, and to retrieve binary data using the RECALL function. External controllers and Instrument BASIC can read measurement data from binary data files. ASCII measurement data or screen image files can be read by commonly available IBM PC based software for data analysis or other secondary functions. The RECALL function can NOT read ASCII files.

Note



ASCII data files can not be recalled on the HP 87510A. If you need to recall the data, save the file in binary format. This binary data can be recalled and saved as an ASCII file at any time.

Data Groups

You can select and save one of the following five combinations between two file types and four data groups to a disk.

- Binary File
 - Instrument states
 - Internal data arrays
 - Instrument states and internal data arrays
- ASCII File
 - Internal data arrays (ASCII format)
 - Graphics image

Note



DATA ONLY does not save the instrument settings such as Start and Stop frequencies. BE CAREFUL! When you first start a series of measurements Always make sure that you save ALL for your first measurement with a particular setting.

Instrument States

The instrument state group consists of all front panel settings and the calibration coefficient arrays. This data group can retrieve identical measurement conditions for later use.

Internal Data Arrays

The internal data arrays which are essentially stored in the analyzer's memory consists of the following three data arrays. See "Data Processing" in Chapter 4 for complete information on each data array and their relationships.

- *Calibration Coefficients arrays* hold the expanded calibration coefficients obtained by calibration.
- *Trace arrays* hold the formatted data. This is identical with the "Data trace arrays" described in "Data Processing" in Chapter 4.
- *Sub trace arrays* hold the formatted data of the "sub trace arrays".

These arrays can be saved selectively to suit the application. For example, when measuring a number of devices with the same measurement settings, you may need to save only the *trace arrays* for each device.

Saving only the necessary arrays reduces the disk space required and the disk access time.

In addition, saving internal data also allows the analysis of the measurement results using an external controller. See "File Structure of Internal Data Arrays File for Binary Files" for more information.

Instrument States and Internal Data Arrays

These consist of the instrument states which includes measurement data. However, saving and retrieving the complete states and data, occupies a lot of disk space.

Internal Data Arrays (ASCII file)

The internal data arrays saved in an ASCII file consists of the same three data arrays as saved in a binary file.

Graphics

Graphics consists of graphic images on the screen created using HP-GL (Hewlett-Packard Graphics Language). The HP-GL format is supported by most drawing software, and is the format used by most plotters.

Additional Information

RAM Disk Memory Capacity

The RAM disk memory capacity is 63 kbytes which includes the directory area. The capacity of data area depends on the disk format type. The following table shows the capacity of the data area by disk formats:

RAM Disk Memory Capacity

LIF Format	DOS format
58.75 kbyte	58 kbyte

Operating Time of the Battery Backup for RAM Disk Memory

The operating time of the battery backup for RAM disk memory is approximately 72 hours after the analyzer is turned OFF.

Disk Requirements

The analyzer disk drive uses a 720 k, or 1.44 Mbyte 3.5 inch micro-flexible disk. See the "System Accessories Available" section in Chapter 2 for disk part numbers.

Disk Formats

The analyzer's built in disk drive can access both LIF (logical interchange format) and DOS formatted disks. The disk drive can also initialize a new disk in either LIF or DOS format. The RAM disk memory can also use a format of either LIF or DOS.

The following list shows the applicable DOS formats for the HP 87510A.

- 720 kbyte, 80 tracks, double-sided, 9 sectors/track
- 1.44 Mbyte, 80 tracks, double-sided, 18 sectors/track

File Names

All data saved using the built in disk drive has an identifying file name. A file name consists of the lower and upper case alphabet, numbers, and valid symbol characters. Up to 8 characters can be used for a file name. The following table shows the valid characters for LIF and DOS file names.

Table 14-1. Valid Characters for File Names

Valid Characters		Description
LIF	DOS Format	
A - Z	A - Z	Upper case alphabet
a - z	a - z	Lower case alphabet
0 - 9	0 - 9	Numeric characters
-	\$ & # % ' ! () - _ @ ^ { } ~	Symbol characters

One of the following suffixes or extensions is automatically added to the file name depending on the data group type stored in the file.

Table 14-2. Suffixes and Extensions Added Automatically

Data Groups	Suffixes for LIF	Extensions for DOS
Instrument States (STATE ONLY)	_S	.STA
Internal Data Arrays (DATA ONLY (binary))	_D	.DTA
Instrument States And Internal Data Arrays (ALL)	_A	.ALL
Internal Data Arrays as an ASCII File (DATA ONLY (ASCII))	_I	.TXT
Graphics Image as an HP-GL File (GRAPHICS)	_G	.HPG

Copy Files Between the RAM Disk and the Flexible Disk

A copy function is provided to copy files between the RAM disk and the flexible disk.

FILE UTILITY in the SAVE menu leads the softkey to copy files. The HP-IB command "file" is also available to copy files.

Note



Use the same disk format type between the RAM disk and the flexible disk when you copy files using this function. This copy function can not copy files when the format type of the RAM disk is different from the format of the flexible disk.

Auto Recall Function

When the analyzer is turned on, it looks for a file named "AUTOREC" from the built-in flexible disk, and if found, the analyzer automatically reads the file to retrieve its data. If the analyzer does not find the file, the analyzer looks for the file from RAM disk.

File Size

The maximum number of files that can be saved on a disk depends on the disk capacity and the total size of the files to be saved. The file size depends on the analyzer settings, such as number of points, calibration type, etc.

Table 14-3 shows the approximate file sizes (in bytes) of binary files versus the number of points when the default settings are stored.

Table 14-3. File Size Versus Number of Points (binary files)

Number of Points	State only	Data only			All
		Cal	Data Trace	Sub Trace	
201	3.4 k	19 k	6.5 K	6.5 k	17 k
401	3.4 k	33.6 k	13 k	13 k	30 k
801	3.4 k	77 k	26 k	26 k	55 k

Table 14-4 shows the approximate file sizes (in bytes) of ASCII files versus the number of points when the default setting is stored.

Table 14-4. File Size Versus Number of Points (ASCII files) 1/2

Number of Points	Data only	
	Data Trace	Sub Trace
201	9 k	9 k
401	18.5 k	18.5 k
801	25.7 k	25.7 k

Table 14-5 lists the approximate file sizes (in bytes) versus the number of points when calibration data is saved in an ASCII file with each calibration type turn on.

Table 14-5. File Size Versus Number of Points (ASCII files) 2/2

Number of Points	Calibration Data only			
	Correction Off	Response	Response and Isolation	3-term
201	4 k	9 k	15 k	20 k
401	8 k	18 k	30 k	40 k
801	16 k	36 k	60 k	80 k

File Structure of Internal Data Arrays File for Binary Files

Note Binary and ASCII file structures are not compatible.



When internal data arrays are saved as a binary file, the arrays' file consists of a file header at the top of the file and the data groups following the file header.

See *HP-IB Programming Manual* for an example BASIC program you can use to access the data.

File Header

Every internal data array file begins with a file header. Figure 14-1 shows the header structure.

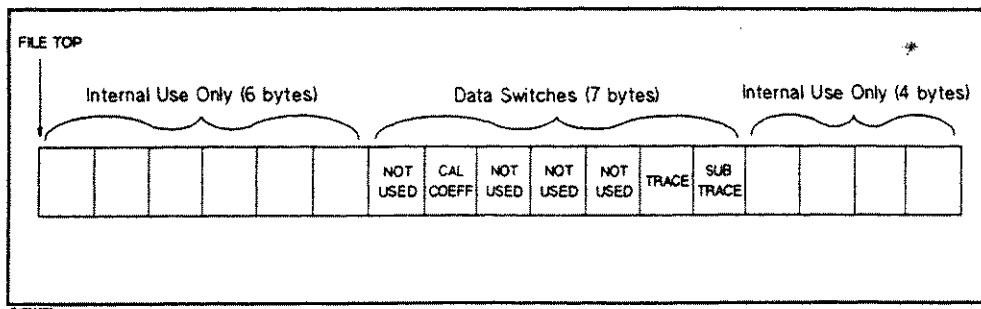

Figure 14-1. File Header Structure

Seven data switches define which data groups follow the file head. Each one-byte switch is either 1 or 0 (decimal value) if the applicable data group exists or not, respectively (if a bit is not used, it is always zero). The data group to be followed is in the same order of these switches. For example, when the data switch, TRACE is 1 (ON), while the others are OFF, only the TRACE (in this order) group will follow the header.

Data Group

Every data group consists of the same structured data segments. The number of data segments depends on the data group type as follows:

- *CAL* consists of six data segments as shown in Figure 14-2. The first half of the segments are for channel 1, and the second half of the segments are for channel 2. The contents of each segment depends on the type of calibration performed. (See Chapter 10.)

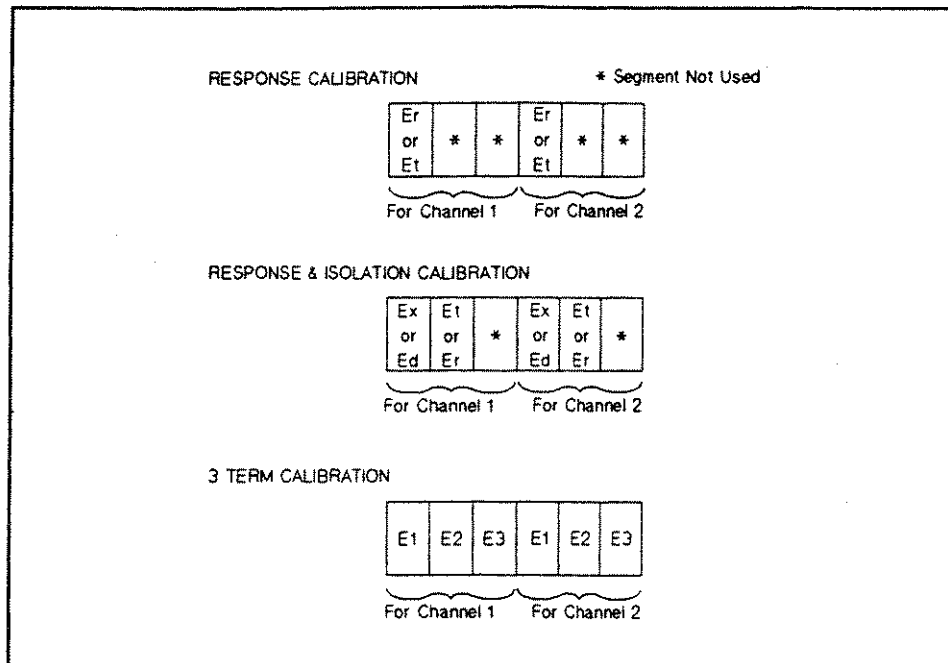

Figure 14-2. CAL Data Group Structure

- *DATA TRACE* consists of two data segments.
- *SUB TRACE* consists of two data segments.

Data Segment

The data segment structure is as shown in Figure 14-3.

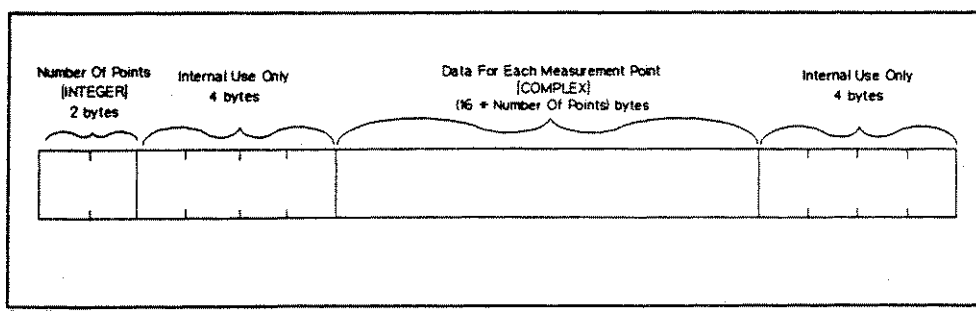

Figure 14-3. Data Segment

- *Number Of Points (NOP)* is a two-byte INTEGER value. This number is equal to the number of complex data which follows.
- *DATA* is a set of the values for each measurement point. The values are two IEEE 754 double precision floating numbers (first value as real part, second value as imaginary part). The data size in bytes can be determined by $16 \times \text{NOP}$.

File Structure of Internal Data Arrays File for ASCII File

Numerical data and strings in an ASCII data file are separated by a tab, and a string is bound by double quotation marks.

Status Block and Data Block

An ASCII data file consists of a status block and data blocks. The status block consists of two lines, the revision number and the date code. The Data block consists of three parts, the state part, the title line, and the data part.

■ State

The state part consists of the following instrument states:

- Channel number
- Title on the screen
- Measurement type
- Format type
- Number of points
- Sweep time
- Sweep type
- Source power
- IF bandwidth

■ Title

The title part consists of the data array names saved. Data array names are described in the next section.

■ Data

The data part consists of stimulus and measurement numerical data.

Table 14-6 shows an example of an ASCII data file.

Table 14-6. Contents of ASCII Files

Block Names		Contents
Status Block		"87510A REV1.00" "DATE: Apr 21 1992" ¹
Data Block	State	"CHANNEL: 1" "TITLE: This is a title." ² "MEAS TYPE: A/R" "FORMAT TYPE: LOG MAG" "NUMBER of POINTS: 201" "SWEEP TIME: 12.2 ms" "SWEEP TYPE: LIST FREQ" "SOURCE POWER: 0 dBm" "IF BANDWIDTH: 4 kHz"
	Title	"Frequency"→"Raw [S11] Real"→"Raw [S11] Imag"→... ^{3,4}
	Data ⁵	3.00000E+5→8.20007E-1→4.09729E-1→... ³ 1.52238E+7→9.32143E-1→-4.1914E-2→... : :

1 This is the date when the file is saved.

2 This line is listed when the title is defined (displayed).

3 "→" means tab code. Data is separated by the tab code.

4 This line lists the names of the data array saved in this file. Titles used in the ASCII files are shown in Table 14-5 through Table 14-8.

5 Each line lists the measurement data at each measurement point. The number of Lines in the data block is the same as the number of points.

Recalling

File Structure for Single Channel and Dual Channel

If you save an ASCII file when DUAL CHANNEL is turned OFF, the ASCII data file consists of the active channel's data. If DUAL CHANNEL is turned ON, the ASCII data file consists of the data of both channels 1 and 2. The channel 2 data follows the channel 1 data as follows:

File Structures for Single and Dual Channels

Dual Channel OFF	Dual Channel ON
Status Block	Status Block
Data Block of Active Channel	Data Block of Channel 1
(end of file)	Data Block of Channel 2

Data Array Names

Data array names are used in the title line of the data block. Each real and imaginary part of the internal data array has one name, Table 14-7 lists all names.

Table 14-7. Data Groups and Data Array Names

Data Groups	Data Array Names		Descriptions
	Real Part	Imaginary Part	
Calibration Data	Cal[1] Real	Cal[1] Imag	Et, ¹ Ex, ² E ₁ ³
	Cal[2] Real	Cal[2] Imag	Et, ² E ₂ ³
	Cal[3] Real	Cal[3] Imag	E ₃ ³
Trace	Trace Real	Trace Imag	Trace (format) arrays
Sub Trace	Sub Trace Real	Sub Trace Imag	Sub Trace (format) arrays

1 When response calibration are used.

2 When response and isolation calibration are used.

3 When 3-term calibration is used.

Data Groups

Every data group consists of data arrays. The number of data arrays depend on the data group types. The saved data array CAL depend on the instrument state.

- CAL DATA consists of twenty data arrays. The data arrays saved depend on the calibration type used. Table 14-8 lists the CAL data arrays, which are saved for each calibration type selected.

Table 14-8. Calibration Type Versus CAL Data Saved

Calibration Type	CAL Data Saved	Error Terms ¹
Response	"Cal[1] Real", "Cal[1] Imag"	Et
Response and Isolation	"Cal[1] Real", "Cal[1] Imag"	Ex
	"Cal[2] Real", "Cal[2] Imag"	Et
1 port Calibration	"Cal[1] Real", "Cal[1] Imag"	E ₁
	"Cal[2] Real", "Cal[2] Imag"	E ₂
	"Cal[3] Real", "Cal[3] Imag"	E ₃

¹ For more information on error terms, see "Appendix to Chapter 7"

SAVE and **RECALL** Keys

The HP-IB programming command is shown in parenthesis following the key or softkey.

The **SAVE** key provides access to all the menus used for saving instrument states and data on the disk. This includes the menus used to define titles for disk files, to define the content of disk files, to initialize disks for storage, and to purge files from a disk.

The **RECALL** key leads to the menus that recall the contents of disk files back into* the analyzer.

Caution



NEVER remove a disk from the disk drive, when the drive is accessing the disk. During disk access, the yellow LED on the drive lights.

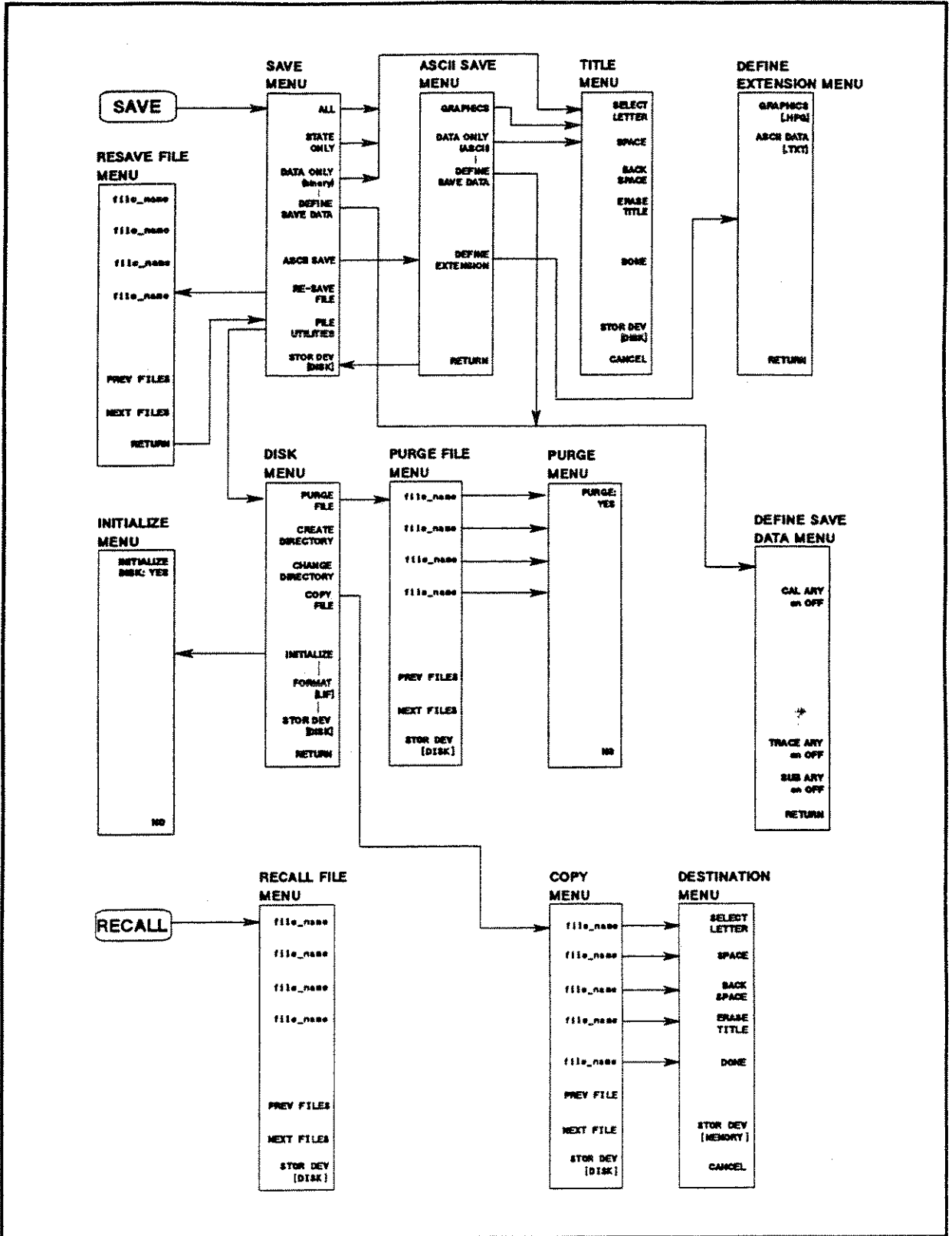

C4014004

Figure 14-4. Softkey Menus Accessed from the **SAVE** and **RECALL** Keys

Save Menu

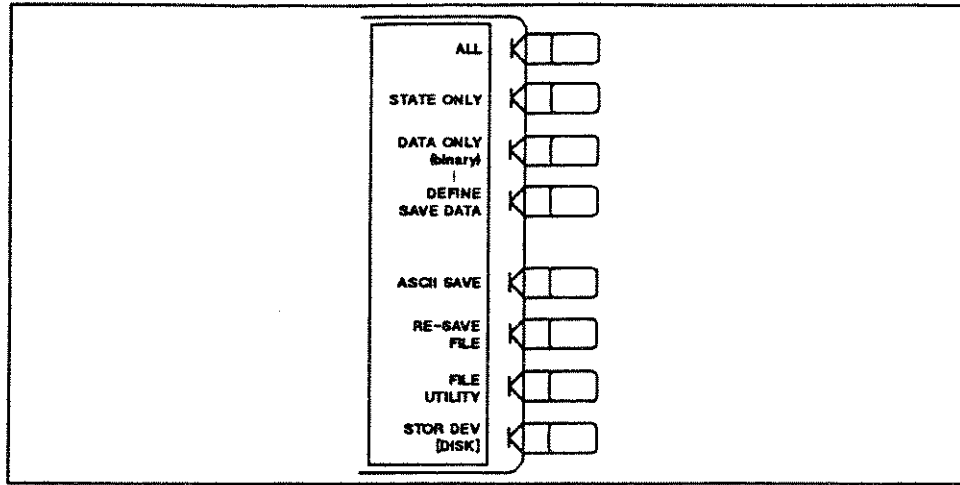

Figure 14-5. Save Menu

ALL (SAVDAL) specifies saving the instrument states, calibration coefficients, and data trace, and sub trace.

STATE ONLY (SAVDSTA) specifies saving only the instrument states and the calibration coefficients.

DATA ONLY (binary) (SAVDDAT) specifies saving the internal data arrays which are defined using the **DEFINE SAVE DATA** key.

DEFINE SAVE DATA provides the define save data menu, which selects the applicable data arrays to be saved.

ASCII SAVE leads to the ASCII Save Menu, from which to save data or graphic screen images to an ASCII file.

RE-SAVE FILE (RESAVD) leads to the Re-save File menu, to update a file which is already saved.

FILE UTILITIES provides the disk menu, which initializes a new disk, and purges a file from a disk.

STOR DEV (STODDISK STODMEM0) selects between the flexible disk drive and the RAM disk memory as the storage device. **[DISK]** shows the built-in flexible disk is selected and **[MEMORY]** shows the RAM disk memory is selected. This setting does not change even when the line power is cycled or the **PRESET** key is pressed.

Title Menu

This menu defines the file name to be saved.

The file name can be up to eight characters long, alphabetic (upper and lower case), numeric, special characters, see Table of Valid Characters in the file names section. If more than eight characters are entered, the last character is over written each time you type in a character.

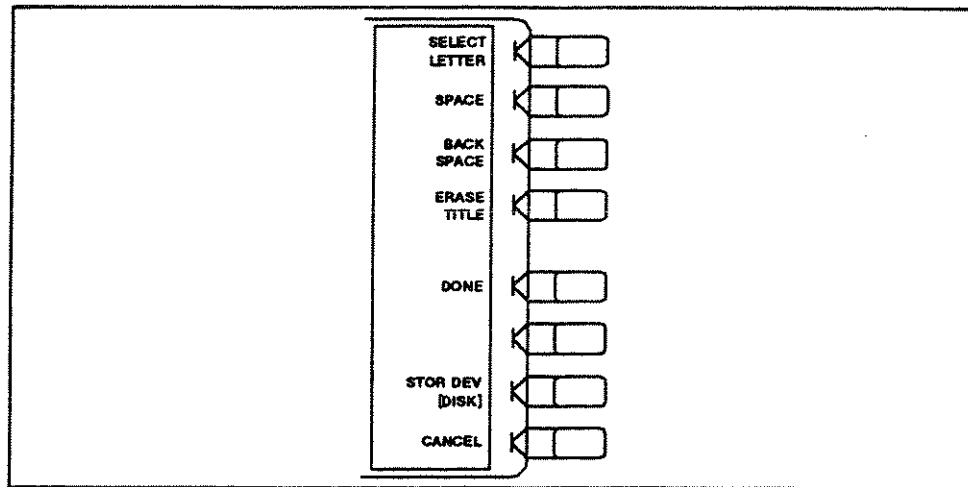

Figure 14-6. Title Menu

SELECT LETTER The active entry area displays the letters of the alphabet, numerals, etc. To define a title, rotate the knob until the arrow ↑ points to the desired letter, then press **SELECT LETTER**. Repeat this procedure until the file name is defined, for a maximum of eight characters.

SPACE Don't use this key because LIF and DOS file formats don't allow spaces in file names.

BACK SPACE deletes the last character entered.

ERASE TITLE deletes the entire file name.

DONE saves the data specified in the define save menu and returns to the Save menu.

STOR DEV [] (STODDISK STODMEMO) selects between the flexible disk drive and the RAM disk memory as the storage device. **[DISK]** shows the built-in flexible disk is selected and **[MEMORY]** shows the RAM disk memory is selected. This setting does not change even when the line power is cycled or the **PRESET** key is pressed.

CANCEL quits this menu without saving the file, and returns to the Save menu.

ASCII Save Menu

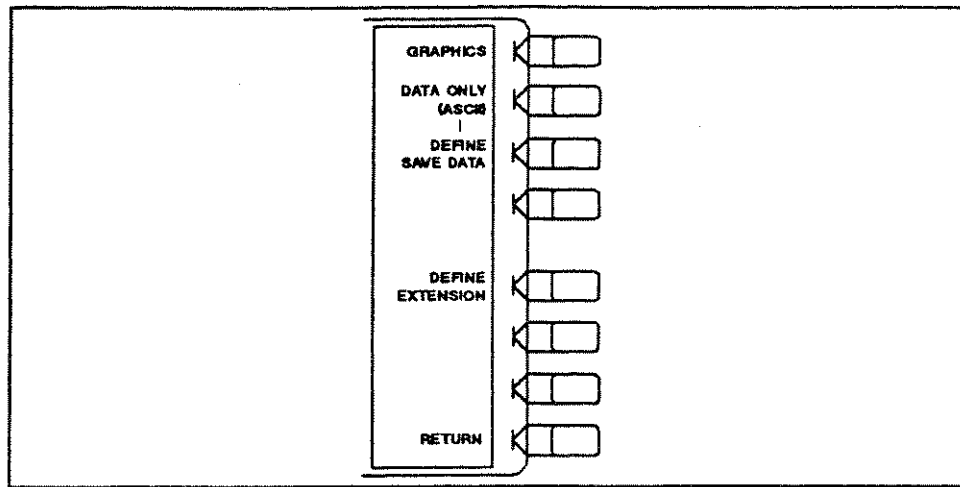

Figure 14-7. ASCII Save Menu

GRAPHICS (SAVDGRA) specifies saving the graphics image on the screen as an HP-GL file. The graphics portion saved is selected in the define plot menu under the **COPY** key. (See Chapter 10.)

DATA ONLY (ASCII) (SAVDASC) specifies saving the internal data arrays as an ASCII file. The arrays saved are defined by the **DEFINE SAVE DATA** key.

DEFINE SAVE DATA provides the define save data menu, which selects the applicable data arrays to be saved.

DEFINE EXTENSION provides the define extension menu, which changes the file extensions of ASCII files.

RETURN returns to the Save menu.

Define Extension Menu

DOS format ASCII default file extensions are changed from this menu. The analyzer stores the changed extensions in its battery backed memory, the changed extensions are saved even when the instrument is turned off.

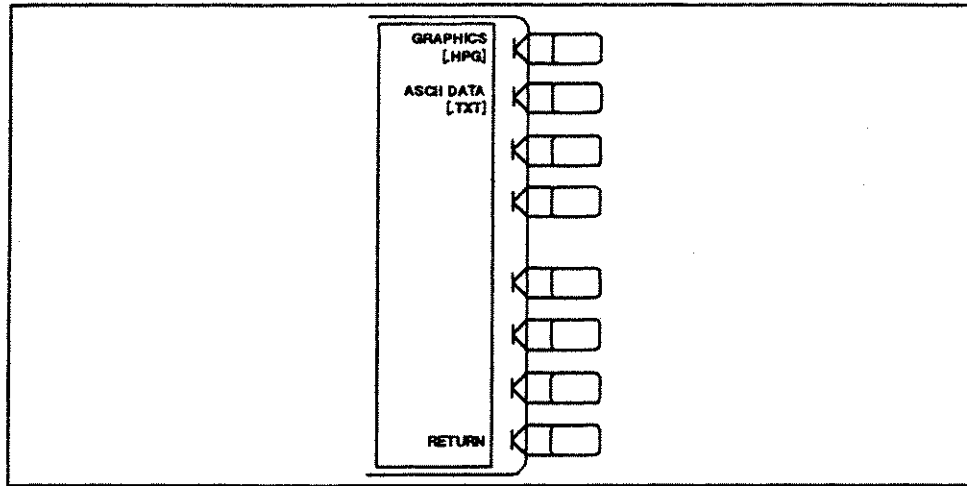

Figure 14-8. Define Extension Menu

GRAPHICS [] (ASCE) changes the extension of HP-GL files for DOS format. The extension is automatically attached to the file name when an HP-GL file is saved. The factory setting is ".HPG".

ASCII DATA [] (GRAE) changes the extension of an ASCII data file for DOS format. The extension is automatically attached to the file name when an ASCII data file is saved. The factory setting is ".TXT".

RETURN returns to the ASCII Save menu.

Define Save Data Menu

This menu defines which data arrays are saved on the disk using the **SAVE DATA ONLY** softkey. See "Internal Data Arrays" for description of each data arrays.

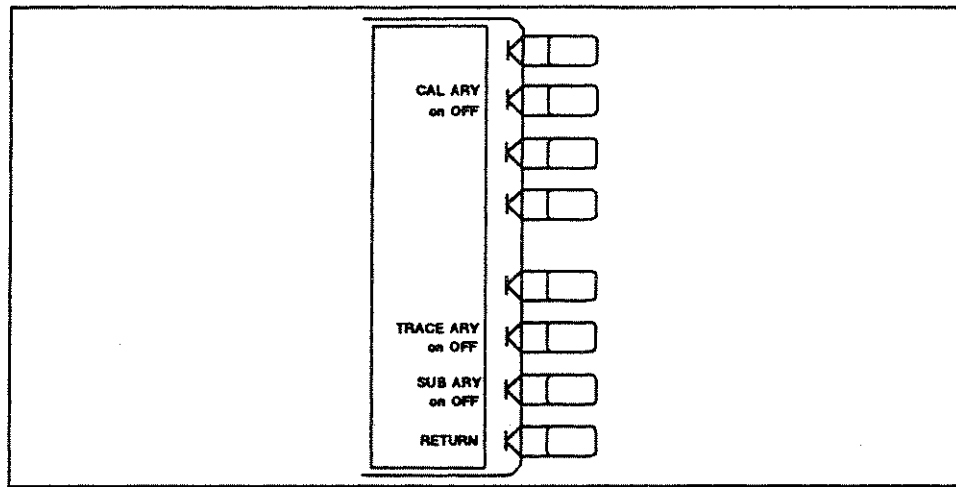

Figure 14-9. Define Save Data Menu

CAL ARY on OFF (SAVCAON, SAVCAOFF) toggles saving or not saving the calibration coefficients arrays.

TRACE ARY on OFF (SAVTAON, SAVTAOFF) toggles saving or not saving the trace arrays.

SUB ARY on OFF (SAVTMAON, SAVTMAOFF) toggles saving or not saving the memory trace arrays.

RETURN returns to the save file menu.

Re-save File Menu

This menu lists the sorted file names, which were previously saved, on the softkey label area and allows updating the file with the current instrument states or data.

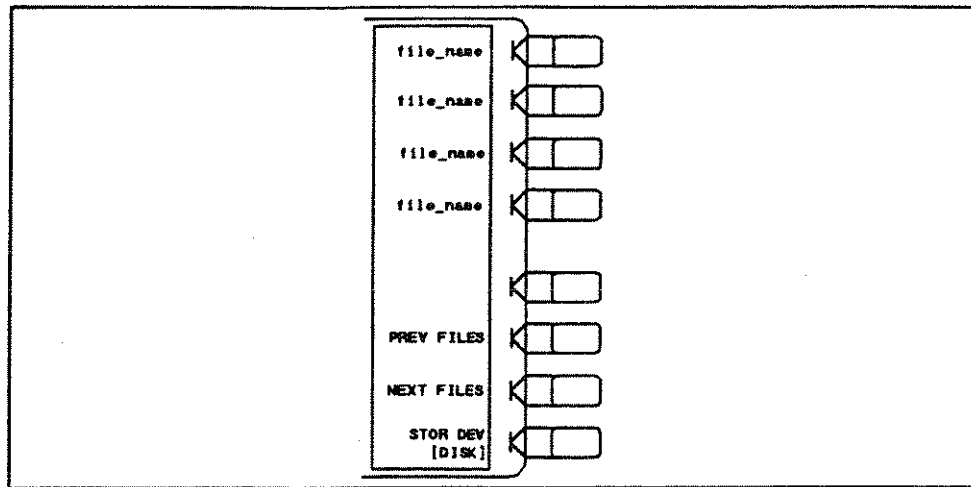

Figure 14-10. Re-save File Menu

file_name updates the file previously saved with the current instrument states or data. The data group to be saved is determined by the file name's extension. See "File Names" for more details about file name extensions.

PREV FILES displays the previous file names in the softkey label to re-save data.

NEXT FILES displays the next file names in the softkey label to re-save data. *

STOR DEV (STODDISK STODMEMO) selects between the flexible disk drive and the RAM disk memory as the storage device. **[DISK]** shows the built-in flexible disk is selected and **[MEMORY]** shows the RAM disk memory is selected. This setting does not change even when the line power is cycled or the **PRESET** key is pressed.

Note



For DOS formatted disks, all available files and directories under the current directory are listed. A "\ " is attached at the end of the label if the softkey label shows a directory name.

Pressing a softkey directory listing label changes the current directory to the directory selected, and the files and directories under the new directory are listed.

Disk Menu

This menu provides the Purge File and Initialize menus from which to purge a file and initialize a disk, respectively.

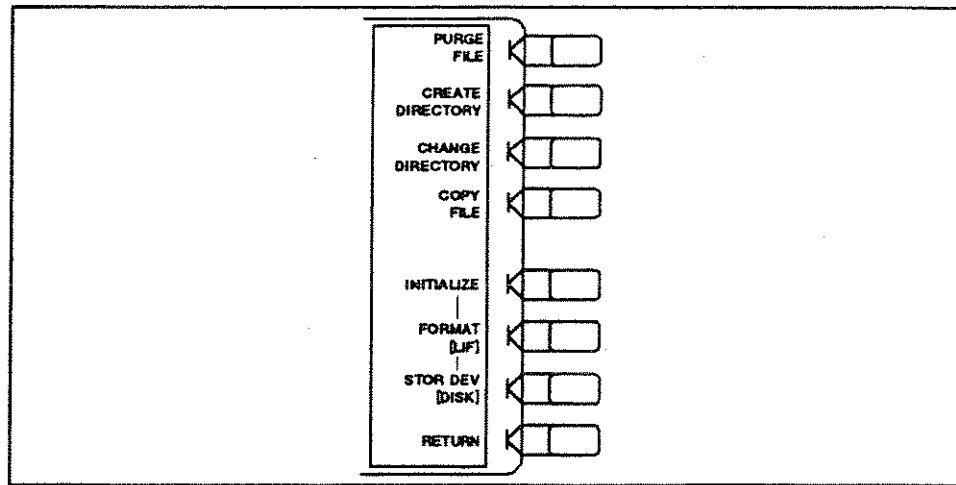

Figure 14-11. Disk Menu

PURGE FILE (PURG) leads to the Purge File menu, from which to remove a file saved on the disk.

CREATE DIRECTORY (CRED) specifies creating a new directory in a DOS format disk. This function is not available for LIF files.

CHANGE DIRECTORY (CHAD) specifies changing the current directory of a DOS format disk. This function is not available for LIF files.

COPY FILE (FILC) leads to the Copy File menu which copies files in the built-in disk drive and the RAM disk memory.

INITIALIZE (INID) leads to the Initialize menu. A new disk must be initialized before data is stored on it. The RAM disk memory also must be initialized at the first time to use or after the power of the backup battery to the RAM disk memory is lost. The disk can be formatted in either LIF or DOS format.

FORMAT [] (INDLIF, INDDOS) selects the disk format to be used when initializing a new disk and the RAM disk memory.

STOR DEV [] (STODDISK STODMEMO) selects between the flexible disk drive and the RAM disk memory as the storage device. **[DISK]** shows the built-in flexible disk is selected and **[MEMORY]** shows the RAM disk memory is selected. This setting does not change even when the line power is cycled or the **[PRESET]** key is pressed.

RETURN returns to the Save menu.

Purge File Menu

This menu lists the sorted file names, which were previously saved, on the softkey label area and allows selecting a file to be removed from the disk.

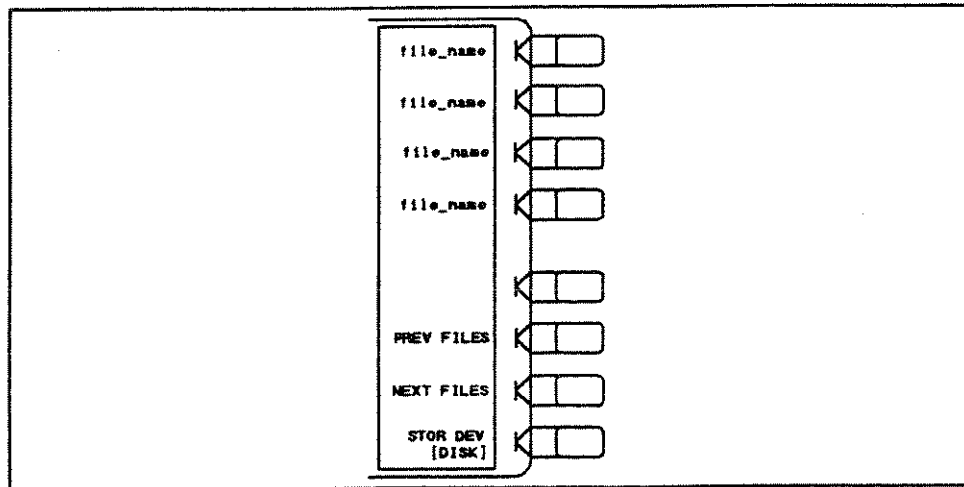

Figure 14-12. Purge File Menu

file_name selects the file name to be removed and provides the purge menu to remove the selected file.

PREV FILES displays set of previous file names in the softkey label area.

NEXT FILES displays next file names in the softkey labels area.

STOR DEV (STODDISK STODMEMO) selects between the flexible disk drive and the RAM disk memory as the storage device. **[DISK]** shows the built-in flexible disk is selected and **[MEMORY]** shows the RAM disk memory is selected. This setting does not change even when the line power is cycled or the **(PRESET)** key is pressed.

Note



All available files and directories under the current directory are listed for DOS format disk. A “\” is attached at end of the label if the softkey label represents a directory name.

Pressing a softkey listing directory changes the current directory to the directory pressed, the files and directories under the new directory are then listed.

Note



Before recalling a binary data file, set the trigger (under **(MENU)**) to hold to avoid only momentary recall of data.

Purge Menu

This menu confirms the purge operation and removes the selected file.

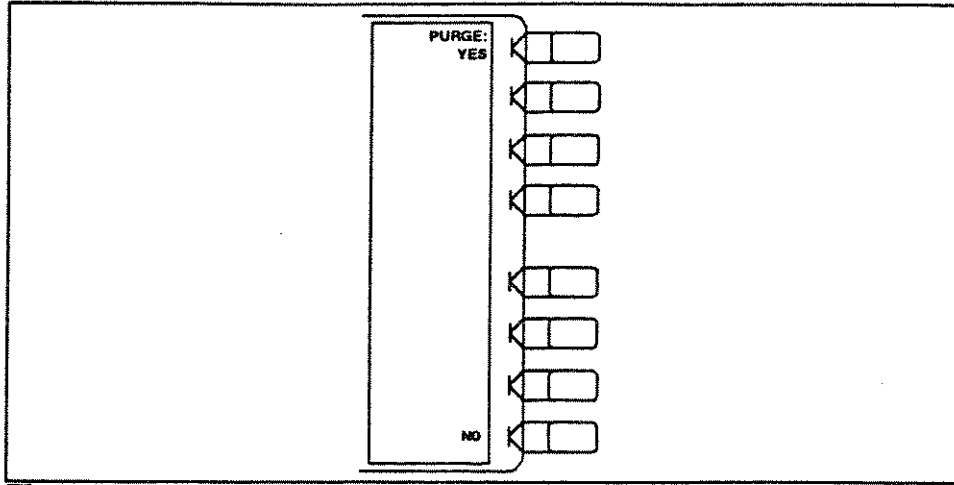

Figure 14-13. Purge Menu

PURGE: YES remove the file and return to the purge file menu.

NO returns to the purge file menu without purging the file.

Initialize Menu

A new disk must be initialized in either the LIF or DOS format before it is used. The initialization format is selected from the Define Format menu.

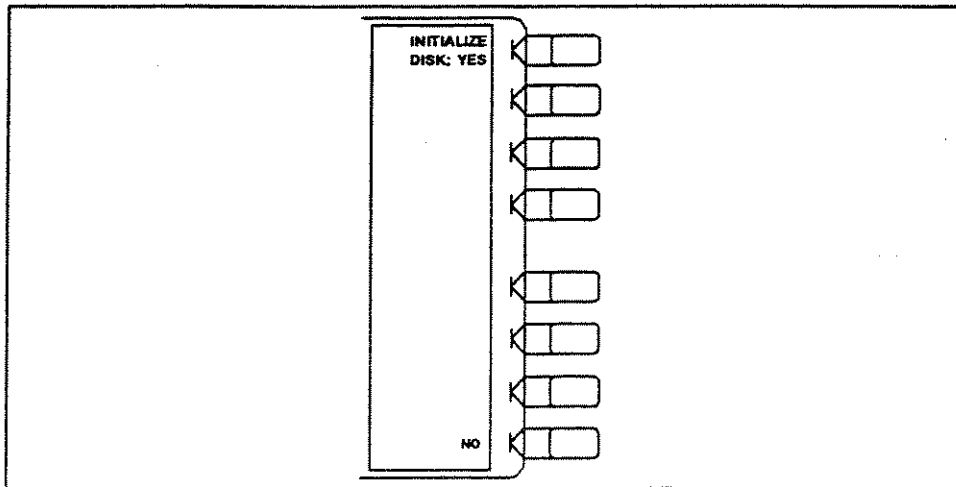

Figure 14-14. Initialize Menu

Caution



If a disk is initialized, all data on the disk is cleared. Be sure no needed data is saved on the disk before initialize a disk.

INITIALIZE YES initializes the disk, then returns to the disk menu.

NO returns to the disk menu without initializing the disk.

Recall File Menu

This menu lists sorted file names, which were previously saved, on the softkey label for selection, and recalls the selected file. The data group to be recalled depends on the file name extension or suffix. See "File Names" for more detail.

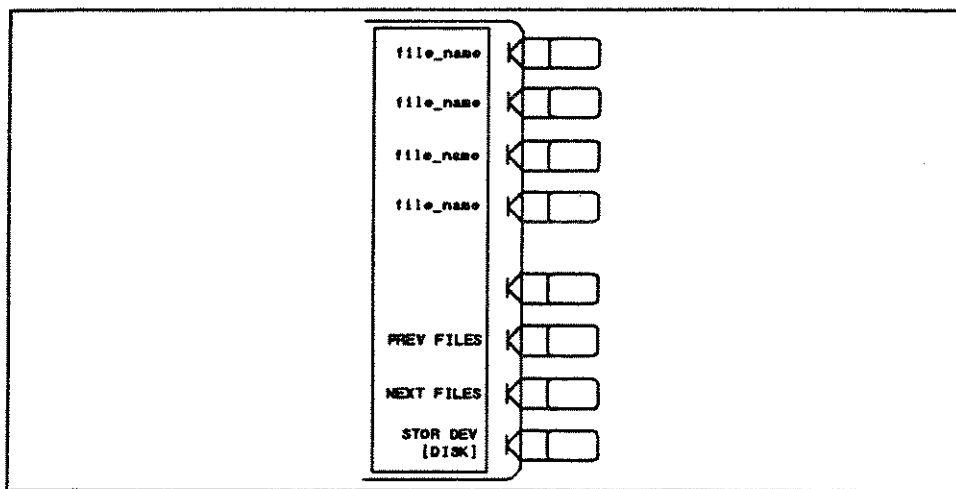

Figure 14-15. Recall File Menu

file_name selects a file to be loaded and loads the instrument state or data.

PREV FILES displays the previous set of file names on the softkey label to load data.

NEXT FILES displays the next set of file names on the softkey label to load data.

STOR DEV (STODDISK for **DISK**, STODMEMO for **MEMORY**) selects between the flexible disk drive and the RAM disk memory as the storage device. **[DISK]** shows the built-in flexible disk is selected and **[MEMORY]** shows the RAM disk memory is selected. This setting does not change even when the line power is cycled or the **[PRESET]** key is pressed.

Note



All available files and directories under the current directory are listed for a DOS formatted disk. A "\ " is attached at end of the label if the softkey label shows a directory name.

Pressing a softkey listing directory changes the current directory to the directory name selected, the files and directories under new directory are then listed.

Copy Menu

This menu lists sorted source file names to copy in the softkey label for selection. When you select a file as the source file, the Destination menu will be displayed. The storage device of the destination file is automatically selected to the other type of storage device for the source file, or you can select a same type of storage device using **STOR DEV**.

The disk formats must be the same between the flexible disk and RAM disk memory, when this copy function copies a file from one device to the other.

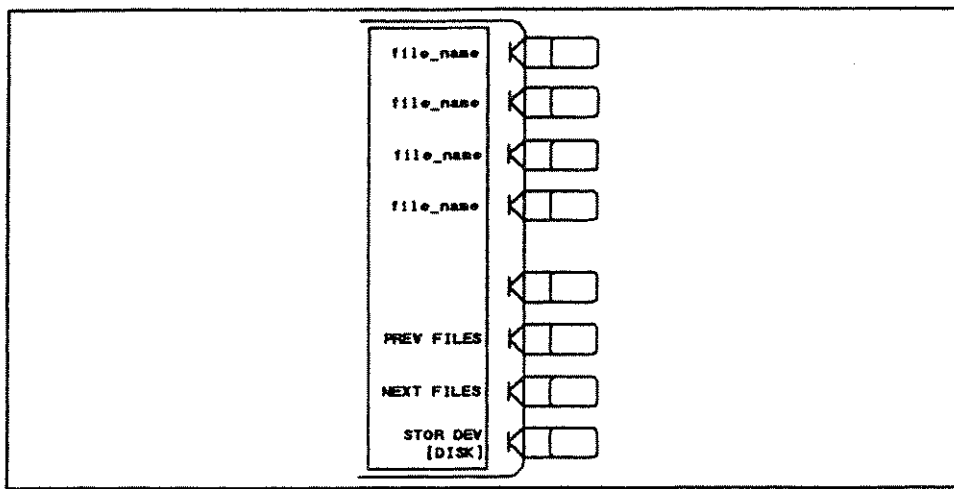

Figure 14-16. Copy Menu

file_name selects a file as the source file to be copied.

PREV FILES displays the previous set of file names on the softkey label to copy files.

NEXT FILES displays the next set of file names on the softkey label to copy files.

STOR DEV[] (STODDISK for **DISK**, STODMEMO for **MEMORY**) selects between the flexible disk drive and the RAM disk memory as the storage device on which the source file is to be stored.

[DISK] shows the built-in flexible disk is selected and **[MEMORY]** shows the RAM disk memory is selected.

Destination Menu

This menu defines destination file names.

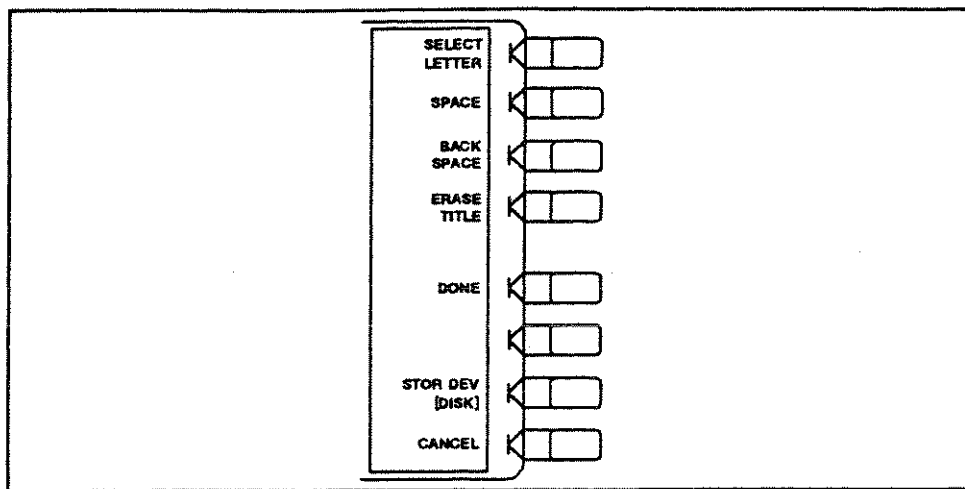

Figure 14-17. Destination Menu

SELECT LETTER The active entry area displays the letters of the alphabet, numerals, etc. To define a destination file name, rotate the knob until the arrow ↑ points to the desired letter, then press **SELECT LETTER**. Repeat this procedure until the file name is defined, for a maximum of eight characters.

SPACE Don't use this key because LIF and DOS file formats don't allow spaces in file names.

BACK SPACE deletes the last character entered.

DONE copies the file specified in the Copy menu to the file specified in the Destination menu.

STOR DEV[] (STODDISK for **DISK**, STODMEMO for **MEMORY**) selects between the flexible disk drive and the RAM disk memory as the storage device a destination file will be stored. **[DISK]** shows the built-in flexible disk is selected and **[MEMORY]** shows the RAM disk memory is selected.

HP-IB Remote Programming

Introduction

The analyzer is factory-equipped with a remote programming digital interface using the Hewlett-Packard Interface Bus (HP-IB). (HP-IB is Hewlett-Packard's hardware, software, documentation, and support for IEEE 488.1, IEC-625, IEEE 488.2, and JIS-C1901 worldwide standards for interfacing instruments.) This allows the analyzer to be controlled by an external computer to send commands or instructions to, and receive data from the HP-IB controlled instrument. In this way, a remote operator has the same control of the instrument available to a local operator using the front panel controls, except for the line power switch.

In addition, the analyzer itself can use HP-IB to directly control compatible peripherals, without the use of an external controller or Instrument BASIC. It can output measurement results directly to a compatible printer or plotter.

This chapter provides an overview of HP-IB operation. Chapter 9 provides information on different controller modes, and on setting up the analyzer as a controller of peripherals. It also explains how to use the analyzer as a controller to print and plot. HP-IB equivalent commands for front panel functions are provided in parentheses throughout this manual.

More complete information on programming the analyzer remotely over HP-IB is provided in *HP-IB Programming Manual*. The *HP-IB Programming Manual* includes examples of remote measurements using an HP 9000 series 200 or 300 computer using the BASIC programming language. The *HP-IB Programming Manual* assumes familiarity with front panel operation of the instrument.

A complete general description of the HP-IB is available in *Tutorial Description of the Hewlett-Packard Interface Bus*, HP publication 5952-0156. For more information on the IEEE 488.1 standard, see *IEEE Standard Digital Interface for Programmable Instrumentation*, published by the Institute of Electrical and Electronics Engineers, Inc., 345 East 47th Street, New York 10017, USA.

How HP-IB Works

The HP-IB uses a party-line bus structure in which up to 15 separately addressable devices can be connected on one contiguous bus. The interface consists of 16 signal lines and 6 grounded lines in a shielded cable. With this cabling system, many different types of devices including instruments, computers, plotters, and printers can be connected in parallel.

Every HP-IB device must be capable of performing one or more of the following interface functions:

Talker

A talker is a device capable of sending device-dependent data when addressed to talk. There can be only one active talker at any given time. Examples of this type of device are voltmeters, counters, and tape readers. The analyzer is a talker when it sends trace data or marker information over the bus.

Listener

A listener is a device capable of receiving device-dependent data when addressed to listen. There can be any number of active listeners at any given time. Examples of this type of device are printers, power supplies, and signal generators. The analyzer is a listener when it is controlled over the bus by a computer.

Controller

A controller is a device capable of managing the operation of the bus and addressing talkers and listeners. There can be only one active controller at any time. Examples of controllers include desktop computers and minicomputers. In a multiple-controller system, active control can be passed between controllers, but there can only be one *system controller*, which acts as the master, and can regain active control at any time. The analyzer is an active controller when it plots or prints in the addressable mode. The analyzer is a system controller when it is in the system controller mode. These modes are discussed in more detail in "HP-IB Menu" in Chapter 12.

HP-IB Requirements

Number of Interconnected Devices:	15 maximum.
Interconnection Path/ Maximum Cable Length:	20 meters maximum or 2 meters per device, whichever is less.
Message Transfer Scheme:	Byte serial/bit parallel asynchronous data transfer using a 3-line handshake system.
Data Rate:	Maximum of 1 megabyte per second over limited distances with tri-state drivers. Actual data rate depends on the transfer rate of the slowest device involved.
Address Capability:	Primary addresses: 31 talk, 31 listen. A maximum of 1 active talker and 14 active listener at one time.
Multiple Controller Capability:	In systems with more than one controller (like the analyzer system), only one can be active at any given time. The active controller can pass control to another controller, but only one system controller is allowed.

Analyzer HP-IB Capabilities

As defined by the IEEE 488.1 standard, the analyzer has the following capabilities:

SH1	Full source handshake.
AH1	Full acceptor handshake.
T6	Basic talker, answers serial poll, unaddresses if MLA is issued. No talk-only mode.
L4	Basic listener, unaddresses if MTA is issued. No listen-only mode.
SR1	Complete service request (SRQ) capabilities.
RL1	Complete remote/local capability including local lockout.
PP0	Does not respond to parallel poll.
DC1	Complete device clear.
DT1	Responds to a group execute trigger.
C1, C2, C3	System controller capabilities in system controller mode.
C11	Pass control capabilities in addressable mode.
E2	Tri-state drivers.

Bus Mode

The analyzer uses a single-bus architecture. The single bus allows both the analyzer and the host controller to have complete access to the peripherals in the system.

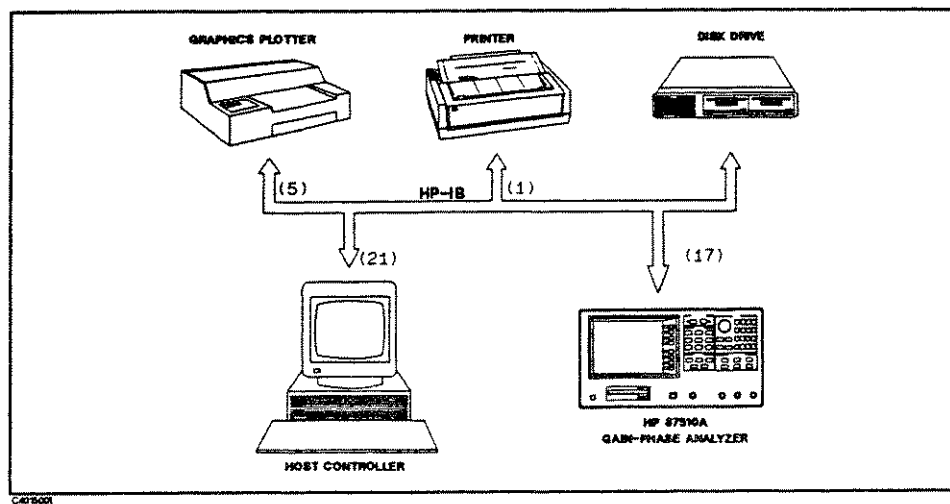

Figure 15-1. Analyzer Single Bus Concept

Two different modes are possible, system controller, and addressable.

System Controller	This mode allows the analyzer to control peripherals directly in a stand-alone environment (without an external controller). This mode can only be selected manually from the analyzer front panel. Use this mode for operation when no computer is connected to the analyzer. Printing and plotting use this mode.
-------------------	---

Addressable This is the traditional programming mode, in which the computer is involved in all peripheral access operations. When the external controller is connect the analyzer through HP-IB (as shown in Figure 15-1), this mode allows you to control the analyzer over HP-IB in the talker mode in order to send data, and in the listener mode to receive commands, and also allows the analyzer to take or pass control in order to plot and print.

Chapter 9 explains the two different bus modes in detail, and provides information on setting the correct bus mode. Programming information for the addressable mode is provided in the *HP-IB Programming Manual*.

Setting Addresses

In communications though HP-IB, each instrument on the bus is identified by an HP-IB address. This address code must be different for each instrument on the bus. See "Address Menu" in Chapter 12 for information on default addresses, and on setting and changing addresses. These addresses are not affected when you press **PRESET** or cycle the power.

Manual Changes

Introduction

This appendix contains the information required to adapt this manual to earlier versions or configurations of the HP 87510A than the current printing date of this manual. The information in this manual applies directly to the HP 87510A Gain-Phase Analyzer serial number prefix listed on the title page of this manual.

Manual Changes

To adapt this manual to your HP 87510A, *see* Table A-1 and Table A-2, and make all of the manual changes listed opposite your instrument's serial number and firmware version.

Instruments manufactured after the printing of this manual may be different than those documented in this manual. Later instrument versions will be documented in a manual changes supplement that will accompany the manual shipped with that instrument. If your instrument's serial number is not listed on the title page of this manual or in Table A-1, it may be documented in a *yellow MANUAL CHANGES* supplement.

Turn on the instrument or execute the "*IDN?" HP-IB command to confirm the firmware version. *See* the HP-IB Programming Manual for information on the "*IDN?" command. For additional information on serial number coverage, *see* Chapter 2. *

Table A-1. Manual Changes by Serial Number

Serial Prefix or Number	Make Manual Changes
	There are no earlier configurations than the printing date of this manual

Table A-2. Manual Changes by Firmware Version

Version	Make Manual Changes
	There are no earlier versions than the printing date of this manual.



Default

Preset State

When the **PRESET** key is pressed, or the analyzer is turned on, the analyzer reverts to a known state. There are subtle differences between the preset state and the power-up state, and these states are defined in Table B-1 to Table B-5.

Some power-up states are recalled from non-volatile memory (battery backup memory). If power to the non-volatile memory is lost, the analyzer will have certain parameters set to factory settings. Table B-7 lists the factory settings. The operating time of the battery backup memory is approximately 72 hours. The battery is automatically recharged while the instrument is ON. The recharge time (time required to fully recharge the battery) is approximately 10 minutes.

When line power is cycled the analyzer performs a self-test routine. Upon successful completion of the self-test routine, the instrument state is set to the following preset conditions. The same conditions are true following a "PRES" or "*RST" command over the HP-IB bus.

Table B-1. Preset Conditions

Operating Parameter	Initialization Method	
	Power-On	PRESET key
Stimulus Conditions		
Sweep Type	Linear frequency	Linear Frequency
Display Mode	Start/Stop	Start/Stop
Trigger Type	Continuous	Continuous
External Trigger	OFF	OFF
Sweep Time	50.25 ms	50.25 ms
Start Frequency	100 kHz	100 kHz
Frequency Span	299.9 MHz	299.9 MHz
Source Power	0 dBm	0 dBm
Power trip	Clear	Clear
Coupled Channels	ON	ON
Frequency List		
Frequency List	Empty	Empty
Edit Mode	Start/Stop, Number of Points	Start/Stop, Number of Points

Table B-2. Preset conditions

Operating Parameter	Initialization Method	
	Power-On	(PRESET) key
Response Conditions		
Parameter		
Channel 1	A/R	A/R
Channel 2	A/R	A/R
Conversion	OFF	OFF
Format	Log magnitude (all inputs)	Log magnitude (all inputs)
Display	Data	Data
Dual Channel	OFF	OFF
Active Channel	Channel 1	Channel 1
Frequency Blank	Disabled	Disabled
Split Display	ON	ON
Intensity	83 %	No effect (same as before preset)
Background Intensity	0 %	No effect (same as before preset)
Color Selections		
Channel 1 Data	Yellow	No effect (same as before preset)
Channel 1 Sub	Green	No effect (same as before preset)
Channel 2 Data	Blue	No effect (same as before preset)
Channel 2 Sub	Pink	No effect (same as before preset)
Graticule	Gray	No effect (same as before preset)
Warning	Red	No effect (same as before preset)
Text	White	No effect (same as before preset)
Beeper:Done	ON	ON
Beeper:Warning	OFF	OFF
Title	Empty	Empty
Number of Points	201	201
IF Bandwidth	8 kHz	8 kHz
IF Averaging Factor	16; OFF	16; OFF
Smoothing Aperture	1% Span; OFF	1% Span; OFF
Group Delay Aperture	1% Span	1% Span
Phase Offset	0°	0°
Electrical Delay	0 s	0 s
Conjugate Matching	OFF	OFF

Table B-3. Preset conditions

Operating Parameter	Initialization Method	
	Power-On	PRESET key
Calibration		
Correction	OFF	OFF
Calibration Type	None	None
Calibration Kit	7 millimeter	7 millimeter
System Impedance	50 Ω	50 Ω
Velocity Factor	1	1
Extensions	OFF	OFF
Input R	0 s	0 s
Input A	0 s	0 s
Scale		
Log Magnitude	10 dB	10 dB
Phase	90°	90°
Group Delay	10 nsec	10 nsec
Polar Chart	1	1
Linear Magnitude	0.1	0.1
Real	0.2	0.2
Imaginary	0.2	0.2
Reference Line Position		
Log Magnitude	5 dB	5 dB
Phase	5°	5°
Group Delay	5 nsec	5 nsec
Polar Chart	-	-
Linear Magnitude	0	0
Real	5	5
Imaginary	5	5
Reference Value		
Log Magnitude	0 dB	0 dB
Phase	0°	0°
Group Delay	0 nsec	0 nsec
Polar Chart	1	1
Linear Magnitude	0	0
Real	0	0
Imaginary	0	0

Table B-4. Preset conditions

Operating Parameter	Initialization Method	
	Power-On	(PRESET) key
Markers		
Markers 1,2,3,4,5,6,7,8	100 kHz all markers off	100 kHz all markers off
Markers ON	Data	Data
Active Marker	1	1
Reference Marker	None	None
Marker Mode	Continuous	Continuous
Delta Marker Mode	OFF	OFF
Coupling	ON	ON
Marker List	OFF	OFF
Marker Time	OFF	OFF
Marker Search	OFF	OFF
Marker Target Value	-3 dB	-3 dB
Marker Width Value	-3 dB; OFF	-3 dB; OFF
Marker Tracking	OFF	OFF
Marker Stimulus Offset	0 Hz	0 Hz
Marker Value Offset	0 dB	0 dB
Marker Aux Offset (Phase)	0°	0°
Marker Statistics	OFF	OFF
Polar Marker	LIN MKR	LIN MKR
Limit Lines		
Limit Lines	OFF	OFF
Limit Testing	OFF	OFF
Limit Line Table	Clear	No effect (Same as before preset)
Edit Mode	Upper/Lower Limits	Upper/Lower Limits
Stimulus Offset	0 Hz	0 Hz
Amplitude Offset	0 dB	0 dB
Beep Fail	OFF	OFF
BIN Sort		
BIN Sort Line	OFF	OFF
BIN Sort Test	OFF	OFF
Output I/O Port	Port A	Port A
BIN Sort Table	Empty	Empty

Table B-5. Preset conditions

Operating Parameter	Initialization Method	
	Power-On	PRESET key
System Parameters		
HP-IB Addresses	Battery backup memory	No effect (same as before preset)
HP-IB Mode	Battery backup memory	No effect (same as before preset)
Plot		
Copy Time	OFF	OFF
Define Plot	All	All
Plot Quadrant	Full page	Full page
Scale Plot	Full	Full
Plot Speed	Fast	Fast
Line Type for Data	7 (solid)	7 (solid)
Line Type for Memory	7 (solid)	7 (solid)
Print	Standard	Standard

Table B-6. Preset Conditions

Operating Parameter	Initialization Method	
	Power-On	PRESET key
Waveform Analysis		
Analysis range	Full	Full
Analysis data	CH1	CH1
Disk Format		
Format	LIF	LIF
Parallel I/O		
Direction of Port C and D	Input	No effect (Same as before preset)
Positive and Negative Logic Setting	Negative	No effect (Same as before preset)
OUTPUT1 and 2 output level	High	No effect (Same as before preset)

Table B-7.
Results of Power Loss to Battery Backup Memory (Factory Setting)

Parameter	Factory Setting
HP-IB Address, HP 8751A	17
HP-IB Address, Plotter	5
HP-IB Address, Printer	1
HP-IB Address, Controller	21
DC Detect or Calibration Coefficients	Reset
Calibration Kit Definitions	Factory set default (See Table B-8 to Table B-13.)
Real Time Clock	1991.1.1
Extension name, ASCII data file	.TXT
Extension name, HP-GL file	.HPG

Predefined Calibration Kit

Predefined Standards

Table B-8. 7 mm Standard Cal Kit

NO.	STANDARD TYPE	C0 $\times 10^{-15}F$	C1 $\times 10^{-27}F/Hz$	C2 $\times 10^{-36}F/Hz^2$	OFFSET DELAY ps	OFFSET LOSS M Ω /s	OFFSET Z ₀ Ω	STANDARD LABEL
1	SHORT				0	700	50	SHORT
2	OPEN	92.85	0	7.2	0	700	50	OPEN
3	LOAD				0	700	50	BROADBAND
4	DELAY/THRU				0	700	50	THRU
5	LOAD				0	700	50	SLIDING
6	LOAD				0	700	50	LOWBAND
7	SHORT				0	700	50	
8	OPEN	79.4	0	40	0	700	50	OPEN

Table B-9. 50 Ω Type-N Standard Cal Kit

NO.	STANDARD TYPE	C0 $\times 10^{-15}F$	C1 $\times 10^{-27}F/Hz$	C2 $\times 10^{-36}F/Hz^2$	OFFSET DELAY ps	OFFSET LOSS MΩ/s	OFFSET Z ₀ Ω	STANDARD LABEL
1	SHORT				0	700	50	SHORT[M]
2	OPEN	108	55	130	0	700	50	OPEN[M]
3	LOAD				0	700	50	BROADBAND
4	DELAY/THRU				0	700	50	THRU
5	LOAD				0	700	50	SLIDING
6	LOAD				0	700	50	LOWBAND
7	SHORT				17.544	700	50	SHORT[F]
8	OPEN	62	17	28	17.544	700	50	OPEN[F]

Table B-10. 75 Ω Type-N Standard Cal Kit

NO.	STANDARD TYPE	C0 $\times 10^{-15}F$	C1 $\times 10^{-27}F/Hz$	C2 $\times 10^{-36}F/Hz^2$	OFFSET DELAY ps	OFFSET LOSS MΩ/s	OFFSET Z ₀ Ω	STANDARD LABEL
1	SHORT				0	1.13×10^3	75	SHORT[M]
2	OPEN	63.5	84	56	0	1.13×10^3	75	OPEN[M]
3	LOAD				0	1.13×10^3	75	BROADBAND
4	DELAY/THRU				0	1.13×10^3	75	THRU
5	LOAD				0	1.13×10^3	75	SLIDING
6	LOAD				0	1.13×10^3	75	LOWBAND
7	SHORT				17.544	1.13×10^3	75	SHORT[F]
8	OPEN	41	40	5	17.544	1.13×10^3	75	OPEN[F]

Predefined Standard Class Assignments

Table B-11. Standard Class Assignments Table (7 mm)

CLASS	A	B	C	D	E	F	G	STANDARD CLASS LABEL
S _{11A}	2							OPEN
S _{11B}	1							SHORT
S _{11C}	3							LOAD
S _{22A}	2							OPEN
S _{22B}	1							SHORT
S _{22C}	3							LOAD
Forward Transmission	4							THRU
Reverse Transmission	4							THRU
Forward Match	4							THRU
Reverse Match	4							THRU
Response	1	2	4					RESPONSE
Response & Isolation	1	2	4					RESPONSE

Table B-12. Standard Class Assignments Table (50 Ω Type-N)

CLASS	A	B	C	D	E	F	G	STANDARD CLASS LABEL
S _{11A}	2	8						OPENS
S _{11B}	1	7						SHORTS
S _{11C}	3							LOAD
S _{22A}	2	8						OPENS
S _{22B}	1	7						SHORTS
S _{22C}	3							LOAD
Forward Transmission	4							THRU
Reverse Transmission	4							THRU
Forward Match	4							THRU
Reverse Match	4							THRU
Response	1	7	2	8	4			RESPONSE
Response & Isolation	1	7	2	8	4			RESPONSE

Table B-13. Standard Class Assignments Table (75 Ω Type-N)

CLASS	A	B	C	D	E	F	G	STANDARD CLASS LABEL
S _{11A}	2	8						OPENS
S _{11B}	1	7						SHORTS
S _{11C}	3							LOAD
S _{22A}	2	8						OPENS
S _{22B}	1	7						SHORTS
S _{22C}	3							LOAD
Forward Transmission	4							THRU
Reverse Transmission	4							THRU
Forward Match	4							THRU
Reverse Match	4							THRU
Response	1	7	2	8	4			RESPONSE
Response & Isolation	1	7	2	8	4			RESPONSE

6

6

6

Parallel I/O (STANDARD and OPTION 006)

Using a parallel I/O port on the rear panel of HP 87510A enables information communication with external devices such as a handler on a production line.

Note



There are three types of parallel I/O ports: a standard parallel I/O port and two optional parallel I/O ports (Options 005 and 006). Two or more parallel I/O ports cannot be used at the same time. Appendix C explains the standard parallel I/O port and Option 006 Parallel I/O Mode B. For optional parallel I/O port (Option 005 Parallel I/O Mode A), *see* Appendix D.

The parallel I/O port consists of four independent parallel input/output ports, some control signal lines, and a power supply line. Since all signals are TTL-compatible, data input/output ports consist of two 8-bit output ports and two 4-bit bidirectional ports. Using these ports simultaneously provides a 24-bit maximum bandwidth output port or an 8-bit maximum bandwidth input port. Input/output signals are factory-set to negative logic. They can be reset to positive logic using an HP-IB command. The control signal lines consist of sweep end output, limit testing result (PASS/FAIL) output, and hand-shaking control signal input/output lines.

HP-IB commands are used to control the parallel I/O ports. These HP-IB commands are summarized at the end of this Appendix.

This Appendix describes the following:

- Input/Output Ports
- Control Signal Lines
- Parallel I/O Port Pin Definition
- HP-IB Commands for Controlling Parallel I/O Ports

I/O Ports

The HP 87510A has two output ports and two bidirectional ports.

- Output-Only Port
 - Port A: 8 bits wide
 - Port B: 8 bits wide

Signals are output from latches at the TTL level. When BIN sort testing is turned ON, the BIN sort testing result is output. (Related HP-IB commands: OUTAIO, OUTBIO, BINOA, and BINOB)

- Bidirectional ports
 - Port C: 4 bits wide
 - Port D: 4 bits wide

Output signals (latch output signals) are TTL-compatible. Use an HP-IB command to switch between input/output directions. When the HP 87510A is turned ON, both ports C and D are defined as input ports. (Related HP-IB commands: OUTCIO, OUTDIO, OUTPINPCIO?, and OUTPINPDIO?)

Combining the above ports using HP-IB commands provides the following four different ports:

- Bidirectional Port
 - Port E: 8 bits wide (Port C + Port D)
- Output Ports
 - Port F: 16 bits wide (Port A + Port B)
 - Port G: 20 bits wide (Port A + Port B + Port C)
 - Port H: 24 bits wide (Port A + Port B + Port C + Port D)

Control Signal Lines

I/O ports include nine types (10 types for Option 006) of output signal lines and one input signal line. Control signals are TTL-compatible (excluding the power supply line). These signals are described below.

Port C Status Output Signal or Port D Status Output Signal

This signal is set at the low level when port C or D is defined as an input port. It is set at the high level when port C or D is defined as an output port. This signal is used to report the direction (input or output) of port C or D to external devices. (Related HP-IB commands: CIN, COUNT, DIN, and DOUT)

WRITE STROBE Output Signal for Output Port

When data is output to any output port, a negative pulse is output to WRITE STROBE OUTPUT. This negative output pulse notifies external devices of output to the parallel I/O port. Figure C-1 shows the write strobe output signal and data output timing.

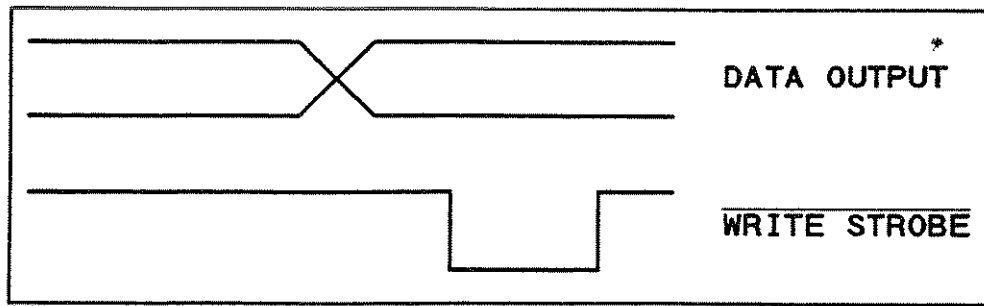

Figure C-1. Write strobe signal timing chart

INPUT1 Input Signal

When a negative pulse is input to INPUT1, OUTPUT1, and OUTPUT2 are set at the low or high level. An HP-IB signal is used to determine whether the high or low level is to be set. The width of the signal input to INPUT1 must be 1 μ s or more. (Related HP-IB commands: OUT1ENVH, OUT1ENVL, OUT2ENVH, and OUT2ENVL)

OUTPUT1 Output Signal or OUTPUT2 Output Signal

This signal (latch output signal) can be set at the low or high level by inputting a negative pulse to INPUT1 or using an HP-IB command. (Related HP-IB commands: OUT1H, OUT1L, OUT2H and OUT2L)

PASS/FAIL Output Signal

This signal is set at the high level when the limit testing result is OK (PASS). It is set at the low level when the test result is NG (FAIL). This signal is effective only when the limit test function is ON.

WRITE STROBE Output Signal for PASS/FAIL Output

When the limit testing result is output to the PASS/FAIL output line, a negative pulse is output to WRITE STROBE OUTPUT. This output signal notifies external devices of the limit testing result output to the PASS/FAIL OUTPUT.

SWEEP END Output Signal

When the HP 87510A completes a sweep, a negative pulse is output. The pulse width is 10 μ s.

A +5 V output pin is provided for an external device. A maximum of 100 mA current may be supplied. This line has no phase. However, if an excess current flows, a protective circuit functions to cut off the main power of the HP 87510A. When the overcurrent subsides, the main power is turned ON again. In this case, all device settings are initialized.

Figure C-2 shows the schematic drawing of input/output ports and control signal lines.

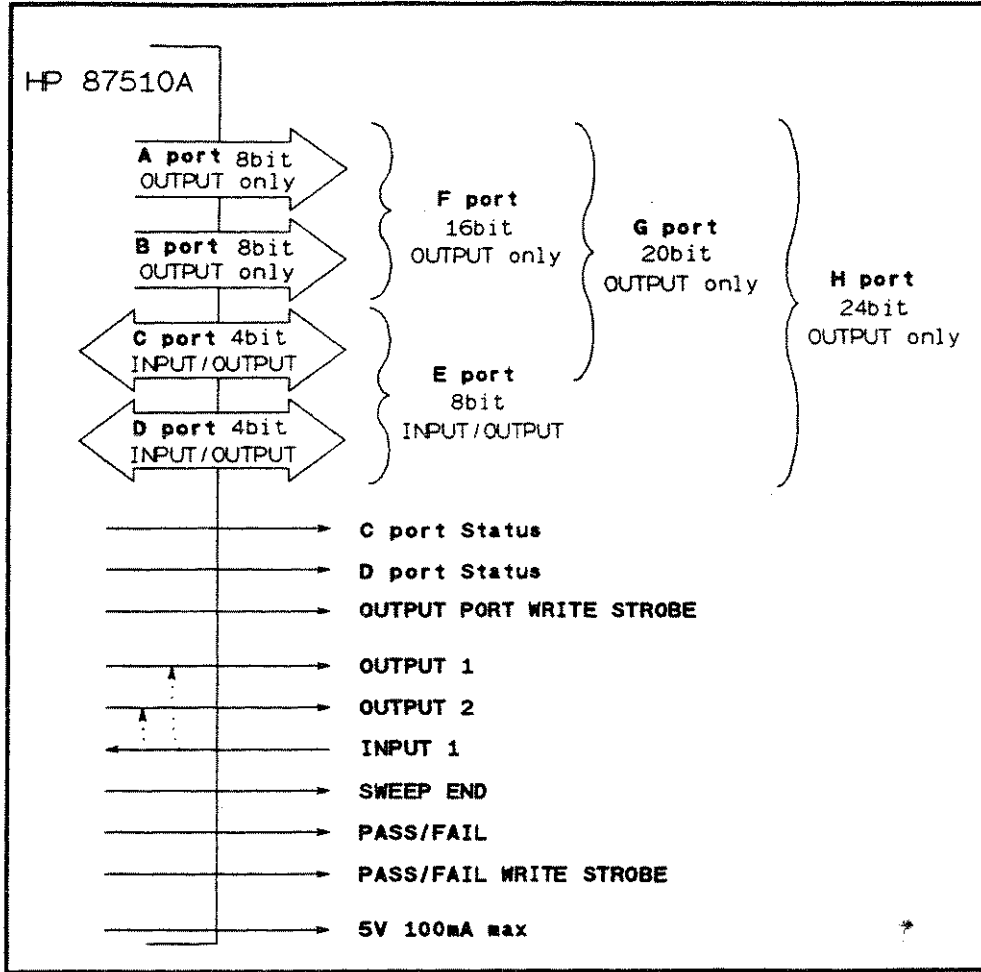

Figure C-2. Schematic Drawing of Parallel I/O Ports

Pin Assignment

Figure C-2 shows pin numbers. Table C-1 shows assignment of signals to pins.

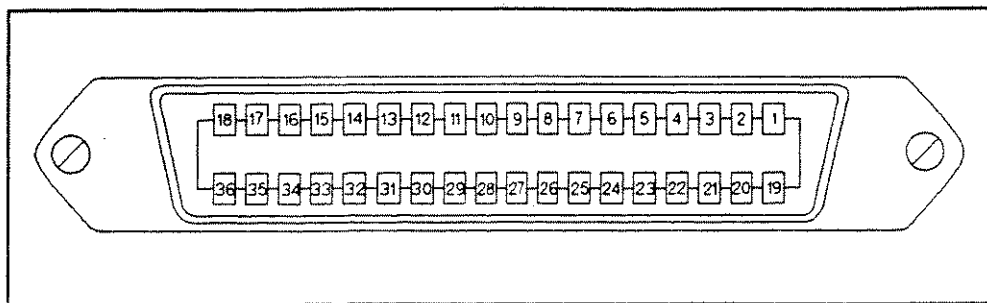

Figure C-3. Parallel I/O Port Connector Pin Numbers

Table C-1. Assignment of Signals to Pins (Standard)

Pin No.	Signal Name	Signal Standard
1	GND	0 V
2	INPUT1	TTL level, Pulse input, Pulse width of 1 μ s or more
3	OUTPUT1	TTL level, Latch output
4	OUTPUT2	TTL level, Latch output
5	Output port A0	TTL level, Latch output
6	Output port A1	TTL level, Latch output
7	Output port A2	TTL level, Latch output
8	Output port A3	TTL level, Latch output
9	Output port A4	TTL level, Latch output
10	Output port A5	TTL level, Latch output
11	Output port A6	TTL level, Latch output
12	Output port A7	TTL level, Latch output
13	Output port B0	TTL level, Latch output
14	Output port B1	TTL level, Latch output
15	Output port B2	TTL level, Latch output
16	Output port B3	TTL level, Latch output
17	Output port B4	TTL level, Latch output
18	Output port B5	TTL level, Latch output
19	Output port B6	TTL level, Latch output
20	Output port B7	TTL level, Latch output
21	Input/output port C0	TTL level, Latch output
22	Input/output port C1	TTL level, Latch output
23	Input/output port C2	TTL level, Latch output
24	Input/output port C3	TTL level, Latch output
25	Input/output port D0	TTL level, Latch output
26	Input/output port D1	TTL level, Latch output
27	Input/output port D2	TTL level, Latch output
28	Input/output port D3	TTL level, Latch output
29	Port C status	TTL level, Input mode: Low, Output mode: High
30	Port D status	TTL level, Input mode: Low, Output mode: High
31	Write strobe signal	TTL level, Negative logic, Pulse output
32	+5 V pull-up	
33	PASS/FAIL signal	TTL level, PASS: High, FAIL: Low, Latch output
34	+5 V	+5 V, 100 mA max.
35	SWEEP END signal	TTL level, Negative logic, Pulse output (Width: 10 μ s or more)
36	Write strobe signal	TTL level, Negative logic, Pulse (for PASS/FAIL) output

Table C-2. Assignment of Signals to Pins (Option 006)

Pin No.	Signal Name	Signal Standard
1	GND	0 V
2	INPUT1	TTL level, Pulse input, Pulse width of 1 μ s or more
3	OUTPUT1	TTL level, Latch output
4	OUTPUT2	TTL level, Latch output
5	Output port A0	TTL level, Latch output
6	Output port A1	TTL level, Latch output
7	Output port A2	TTL level, Latch output
8	Output port A3	TTL level, Latch output
9	Output port A4	TTL level, Latch output
10	Output port A5	TTL level, Latch output
11	Output port A6	TTL level, Latch output
12	Output port A7	TTL level, Latch output
13	Output port B0	TTL level, Latch output
14	Output port B1	TTL level, Latch output
15	Output port B2	TTL level, Latch output
16	Output port B3	TTL level, Latch output
17	Output port B4	TTL level, Latch output
18	Not used	
19	Output port B5	TTL level, Latch output
20	Output port B6	TTL level, Latch output
21	Output port B7	TTL level, Latch output
22	Input/output port C0	TTL level, Latch output
23	Input/output port C1	TTL level, Latch output
24	Input/output port C2	TTL level, Latch output
25	Input/output port C3	TTL level, Latch output
26	Input/output port D0	TTL level, Latch output
27	Input/output port D1	TTL level, Latch output
28	Input/output port D2	TTL level, Latch output
29	Input/output port D3	TTL level, Latch output
30	Port C status	TTL level, Input mode:Low, Output mode:High
31	Port D status	TTL level, Input mode:Low, Output mode:High
32	Write strobe signal	TTL level, Negative logic, Pulse output
33	PASS/FAIL signal	TTL level, PASS:High, FAIL: Low, Latch output
34	SWEEP END signal	TTL level, Negative logic, Pulse output (Width:10 μ s or more)
35	+5 V	+5 V, 100 mA max.
36	Write strobe signal	TTL level, Negative logic, Pulse output

HP-IB Commands for Parallel I/O Port Control

The HP-IB commands related to parallel I/O ports are summarized below. For more information on HP-IB commands, see the *HP-IB Programming Manual*.

Note



The HP-IB commands summarized below are used to control the standard Parallel I/O and Option 006. For the HP-IB commands related to Option 005 (8-bit I/O), see Appendix D.

Data Output Commands

The following commands output data to the corresponding ports (A to H). When ports C, D, E, F, G, and H are used as output ports, ports C and D must be defined as output ports using HP-IB commands (COUT and DOUT).

- OUTAIO outputs 8-bit data to port A.
- OUTBIO outputs 8-bit data to port B.
- OUTCIO outputs 4-bit data to port C.
- OUTDIO outputs 4-bit data to port D.
- OUTEIO outputs 8-bit data to port E.
- OUTFIO outputs 16-bit data to port F.
- OUTGIO outputs 20-bit data to port G.
- OUTHIO outputs 24-bit data to port H.

Data Input Commands

The following commands read data from the corresponding input ports (C to E) and returns the values to the HP-IB. Before receiving data, ports C and D must be defined as input ports using HP-IB commands (CIN and DIN).

- OUTPINPCIO? reads 4-bit data from port C and returns its value to the HP-IB.
- OUTPINPDIO? reads 4-bit data from port D and returns its value to the HP-IB.
- OUTPINPEIO? reads 8-bit data from port E and returns its value to the HP-IB.

Commands for Setting Input/Output Directions of Ports C and D

The following commands set the input/output directions of ports C and D. When the power is turned ON, ports C and D are defined as input ports. Pressing **PRESET** key do not affect this setting. This setting is saved to an instrument state file using the Save function.

- CIN defines port C as an input port.
- COUT defines port C as an output port.
- DIN defines port D as an input port.
- DOUT defines port D as an output port.

Positive and Negative Logic Setting Commands

The following commands set positive or negative logic for port input/output signals. When the power is turned ON, negative logic is set. Pressing **PRESET** key do not affect this setting. This setting is saved to an instrument state file using the Save function.

- NEGL sets negative logic.
- POSL sets positive logic.

OUTPUT1 and OUTPUT2 Level Setting Commands

The following commands set OUTPUT1 and OUTPUT2 levels:

- OUT1H sets OUTPUT1 at the high level.
- OUT1L sets OUTPUT1 at the low level.
- OUT2H sets OUTPUT2 at the high level.
- OUT2L sets OUTPUT2 at the low level.

Commands for Setting OUTPUT1 and OUTPUT2 at the High or Low Level upon input of a Pulse to INPUT1

The following commands set OUTPUT1 and OUTPUT2 at the high or low when a negative pulse is input to INPUT1. When the power is turned ON, both OUTPUT1 and OUTPUT2 are set at the high level. Pressing **PRESET** key do not affect this setting. This setting is saved to an instrument state file using the Save function.

- OUT1ENVH sets OUTPUT1 at the high level when a pulse is input to INPUT1.
- OUT1ENVL sets OUTPUT1 at the low level when a pulse is input to INPUT1.
- OUT2ENVH sets OUTPUT2 at the high level when a pulse is input to INPUT1.
- OUT2ENVL sets OUTPUT2 at the low level when a pulse is input to INPUT1.

Command for Checking Input to INPUT1

This command checks whether a pulse has been input to INPUT1. Sending this command after a pulse is input to INPUT1 will return a HIGH. If no pulse has been input to INPUT1, the return values will be LOW. After HIGH is received, succeeding values will be cleared. (set to LOW)

D

Option 005 Parallel I/O Mode A (8-bit)

This appendix provides information on the HP 87510A with Option 005 Parallel I/O Mode A (8-bit I/O port).

I/O Port

The I/O port on the analyzer rear panel communicates with the external devices such as a handler on a production line.

Pin Assignment

The 8-bit I/O port consists of 15 TTL compatible signals, which are 8-bit output, 4-bit input, sweep end, pass/fail, and ground. The pin assignments are shown in Figure D-1.

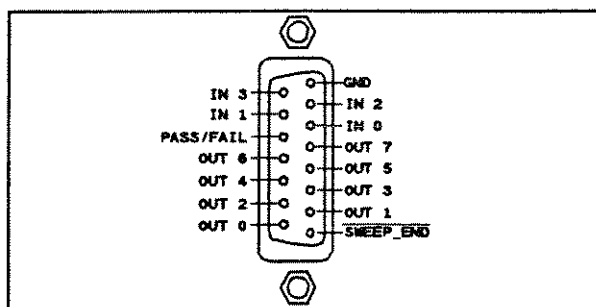

Figure D-1. 8-bit I/O Port Pin Assignments

The signals carried through each pin are described below.

SWEEP_END	outputs a negative pulse when the analyzer completes a sweep. The pulse width is $> 10 \mu\text{s}$.
OUT 0 thru 7	output signals to external devices and are controlled by two HP-IB commands, OUT8IO, as described below. Once OUT8IO is executed, the signal is latched until OUT8IO is executed again.
IN 0 thru 4	input signals from external devices and are read by the HP-IB command INP8IO, as described below.
PASS/FAIL	is affected only when the Limit Testing, described in "Limit Line and Limit Testing" in Chapter 12, is active. This signal presents HIGH and LOW if the test result is PASS and FAIL, respectively.

Related HP-IB Commands

There are three HP-IB commands which directly control an I/O port.

- OUT8IO** outputs 8-bit data to the OUT 0 thru 7 lines. The OUT 0 signal is the LSB (least significant bit), while the OUT 7 signal is the MSB (most significant bit).
- INP8IO** inputs 4-bit data from the IN 0 thru 3 signals to the analyzer's memory. The IN 0 signal is the LSB (least significant bit), while the IN 3 signal is the MSB (most significant bit).
- INP8IO?** inputs data from the 4-bit parallel input port to the HP 87510A, and outputs the data to the controller.
- OUTPINP8IO?** is a query command which outputs 8-bit data to the controller. The data is obtained as 4-bit data by the INP8IO command and four upper significant bits (value = 0) are attached to extend the 4-bit data to 8-bit data.

Softkey Tree

STIMULUS Block

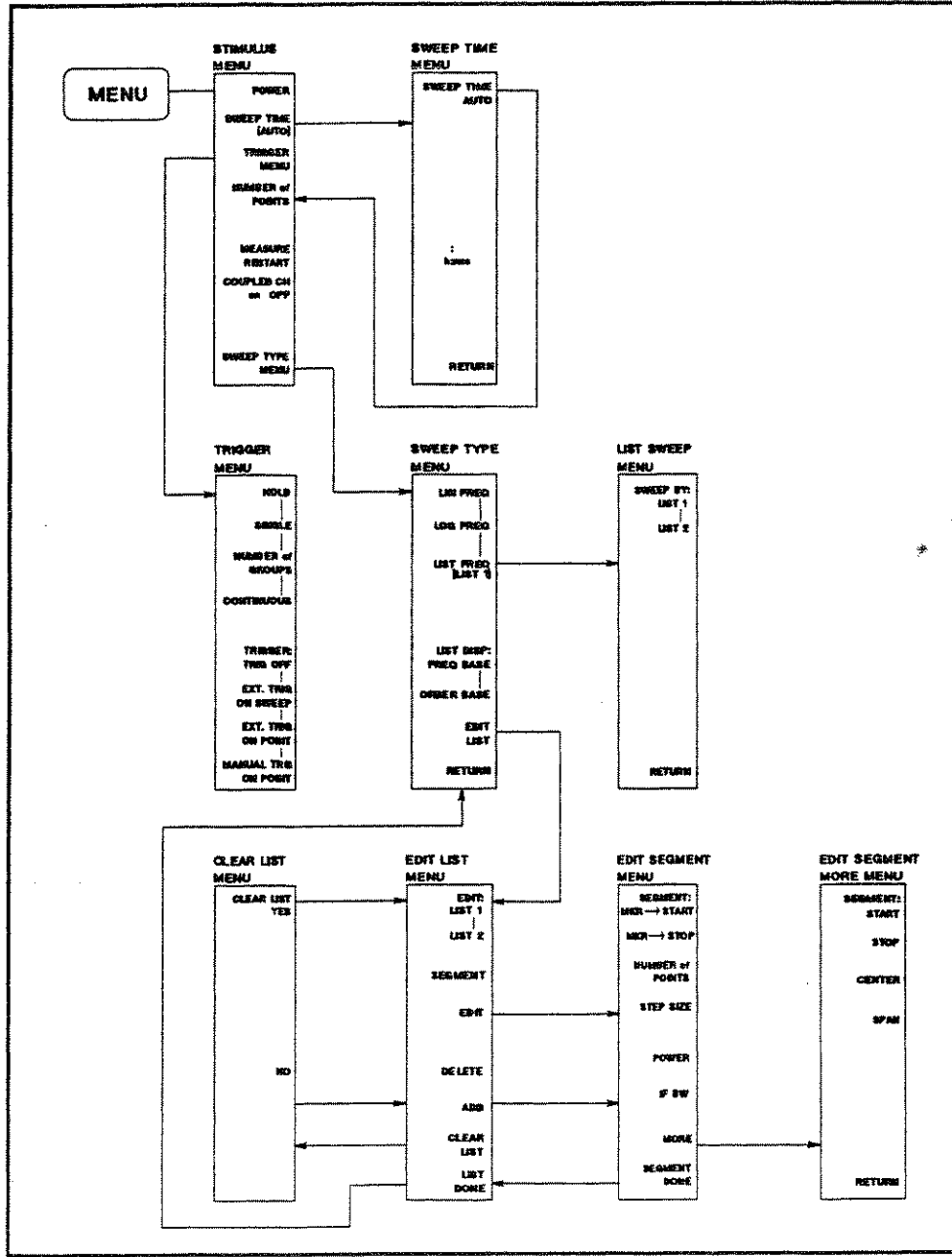

Figure E-1. MENU key

RESPONSE Block

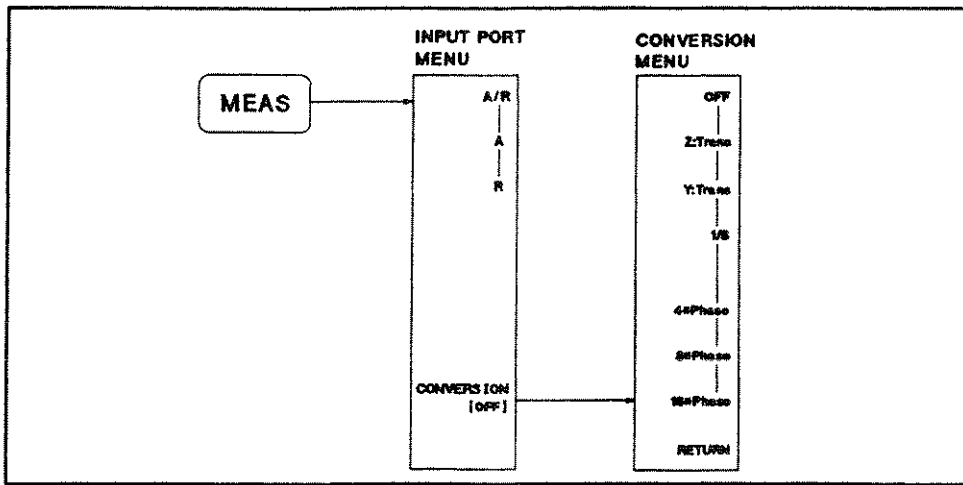

Figure E-2. **MEAS** Key

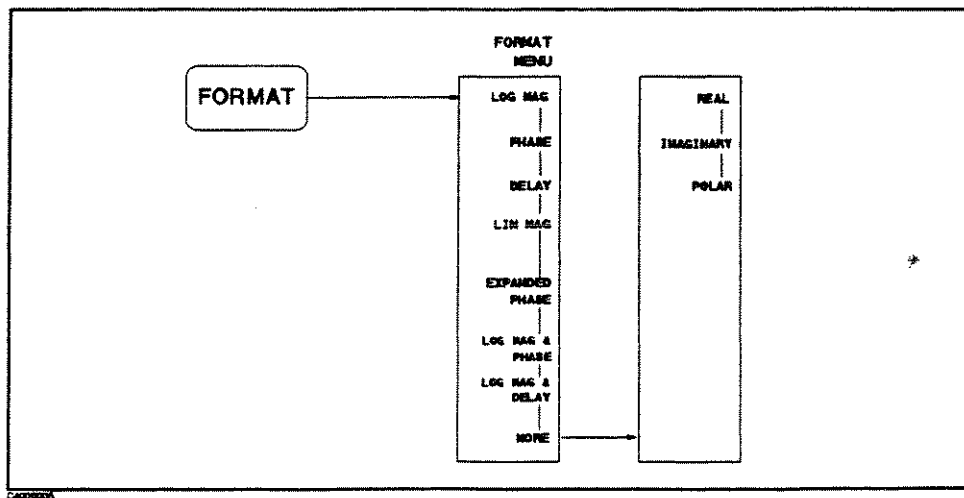

Figure E-3. **FORMAT** Key

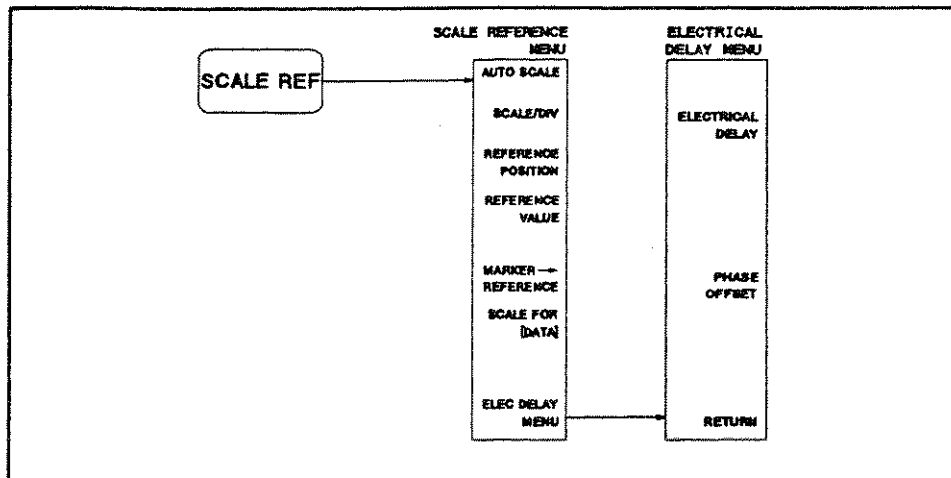

Figure E-4. **SCALE REF** Key

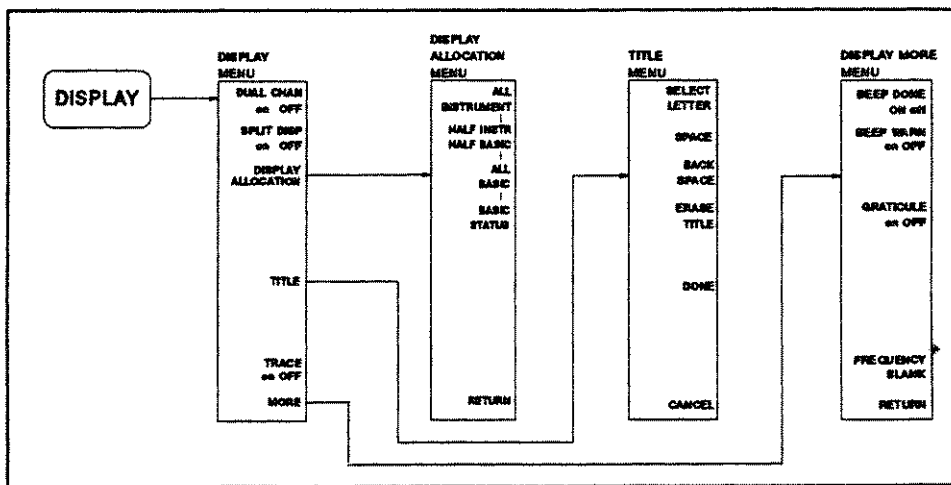

Figure E-5. **DISPLAY** Key

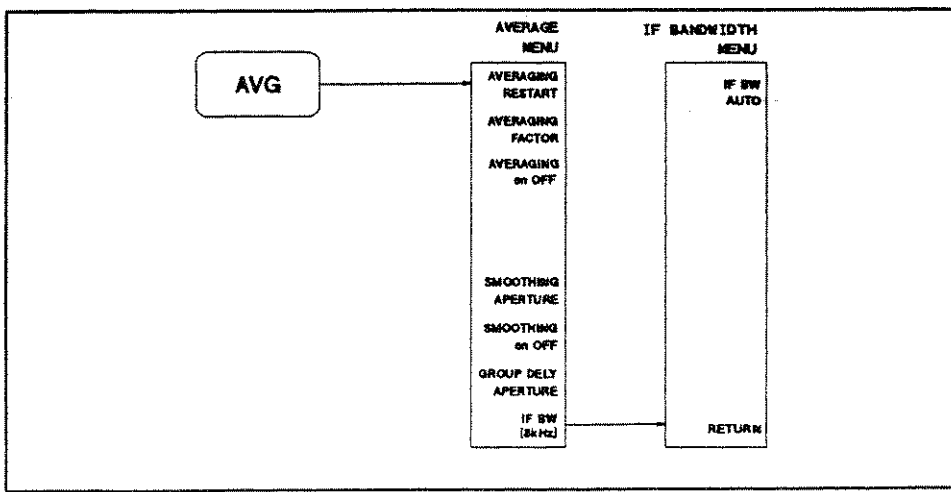

Figure E-6. **AVG** Key

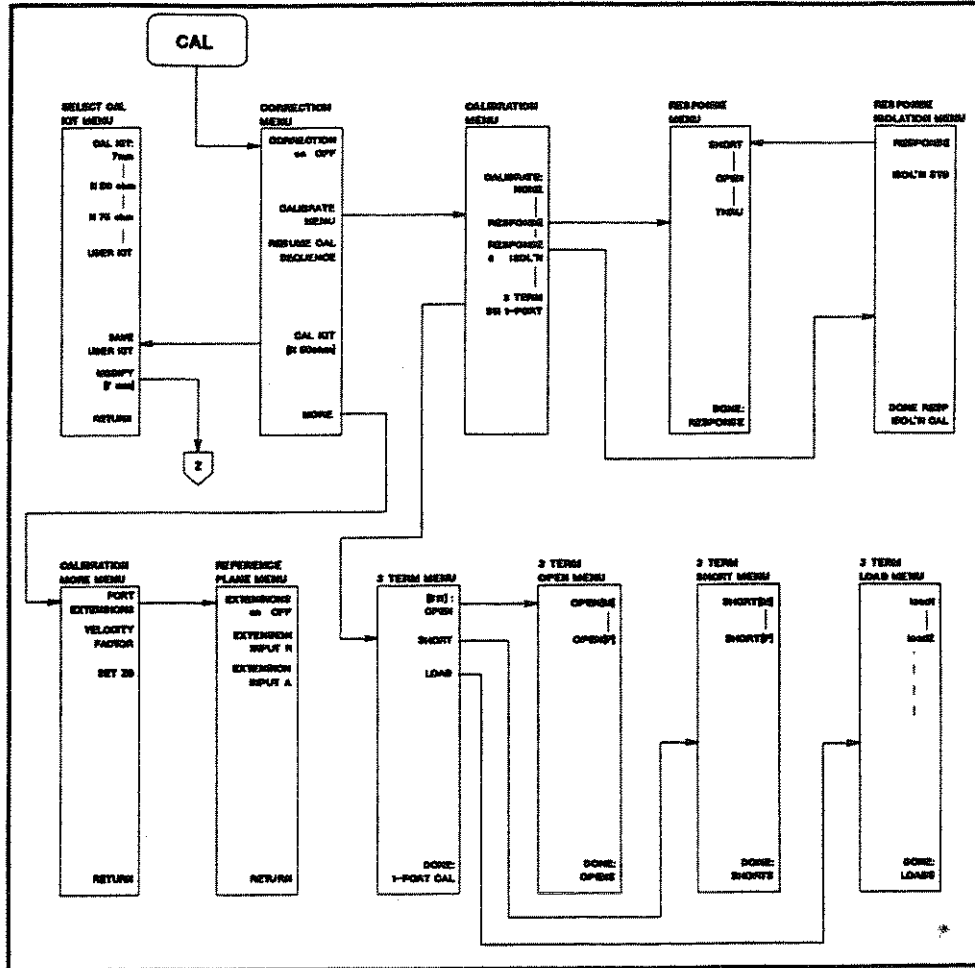

Figure E-7. **CAL** Key (1/2)

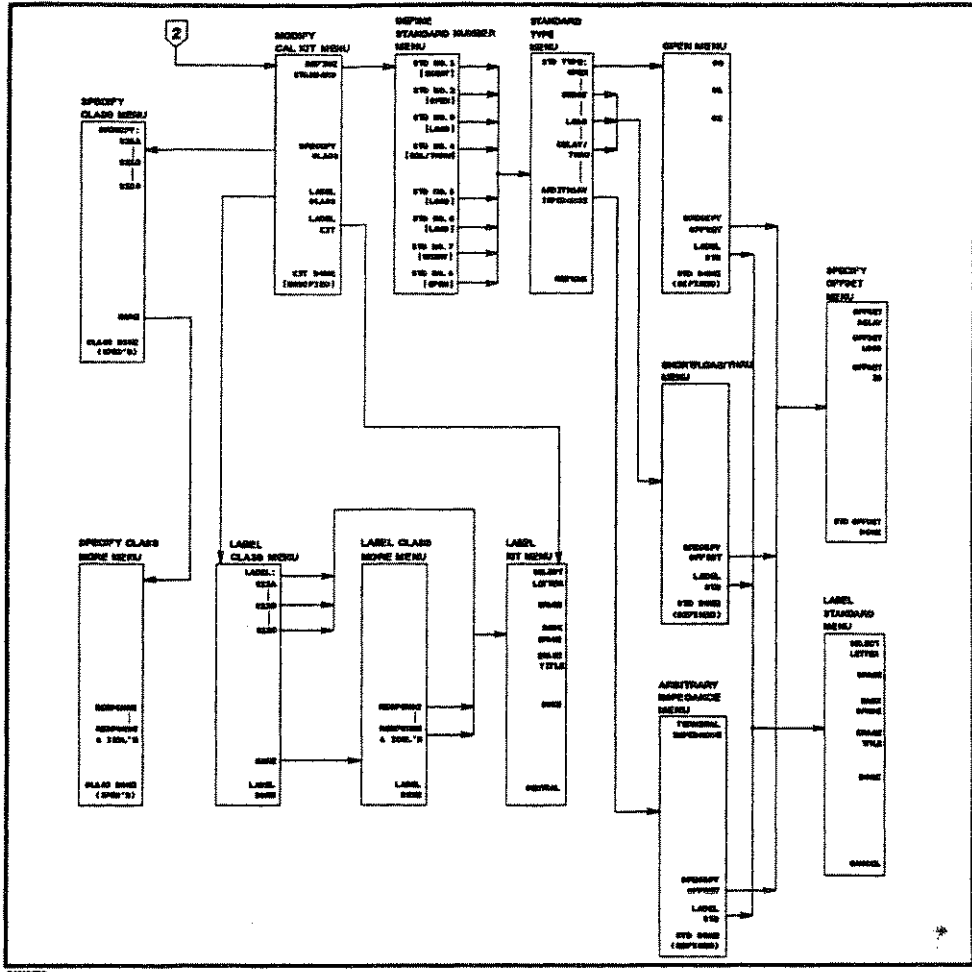

Figure E-8. CAL Key (2/2)

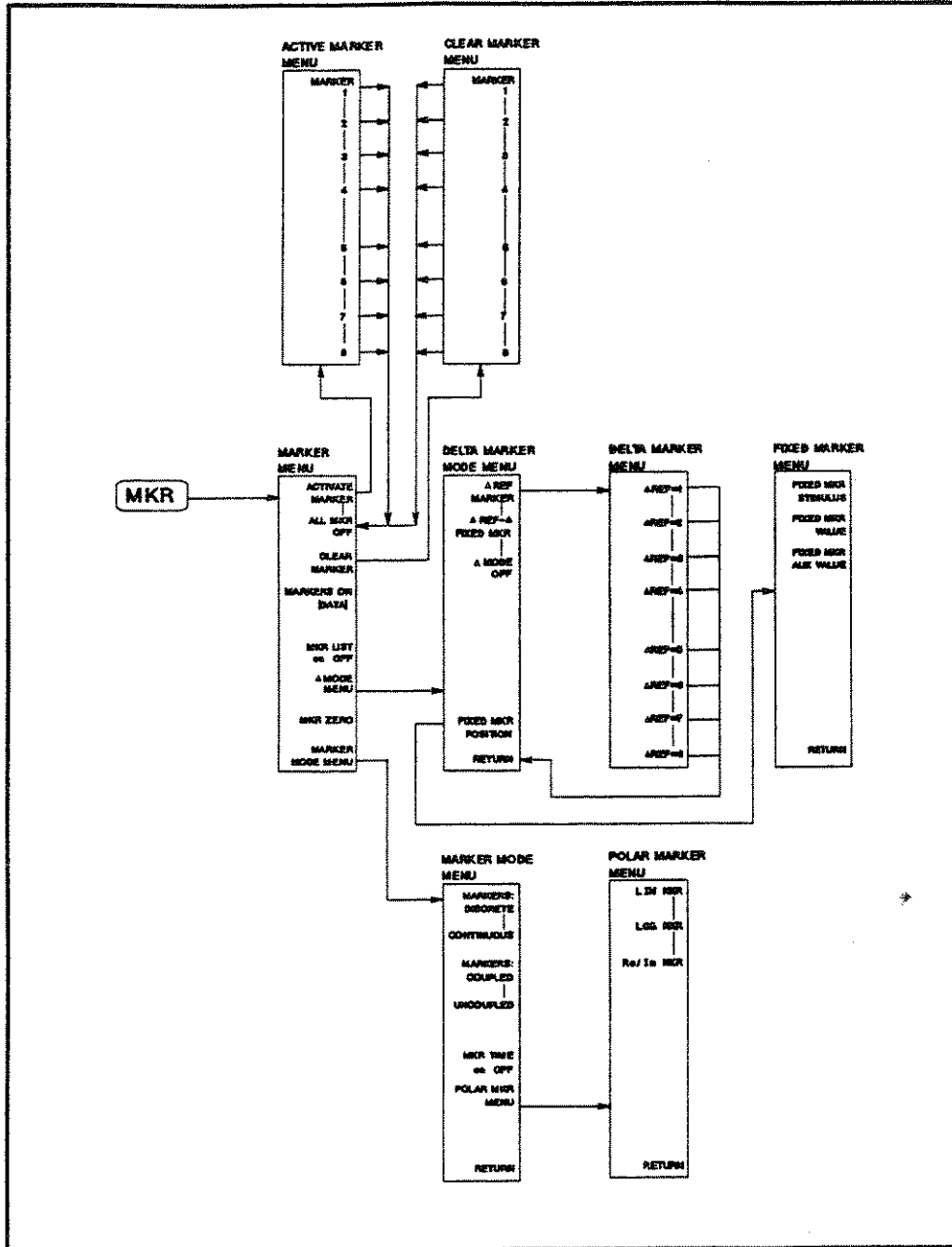

Figure E-9. **MKR** Key

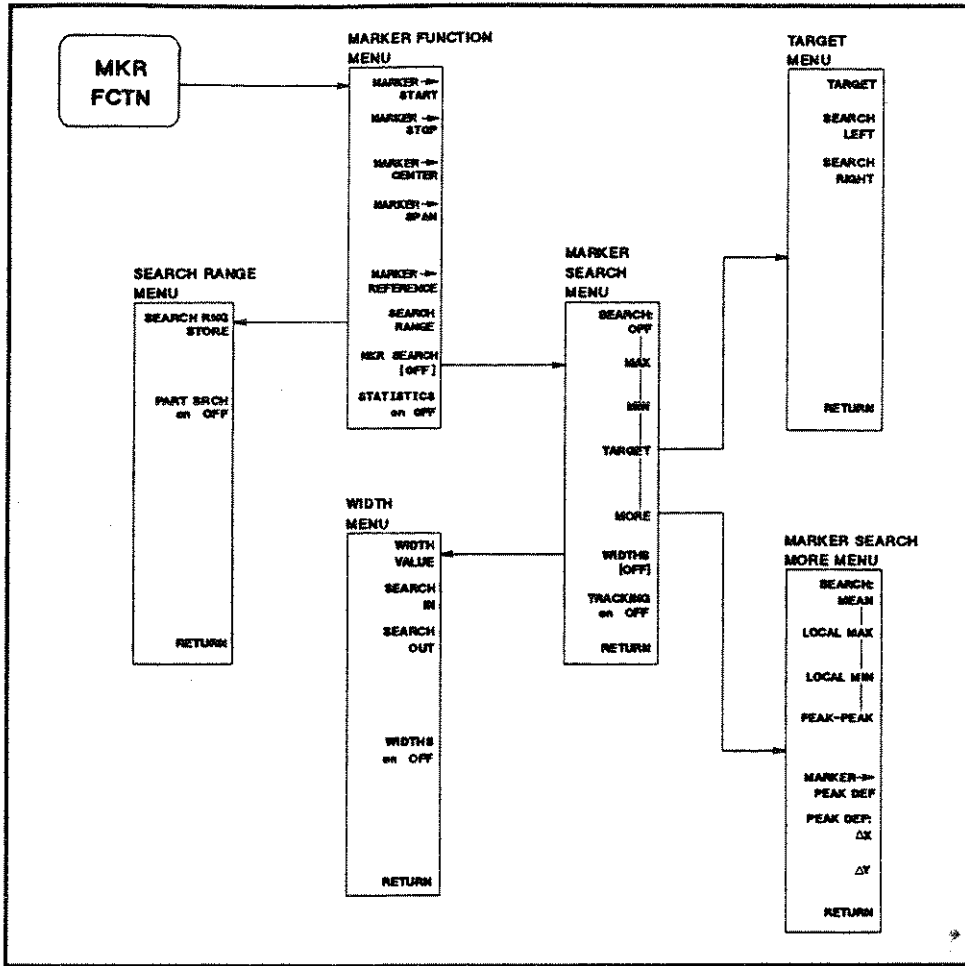

Figure E-10. MKR FCTN Key

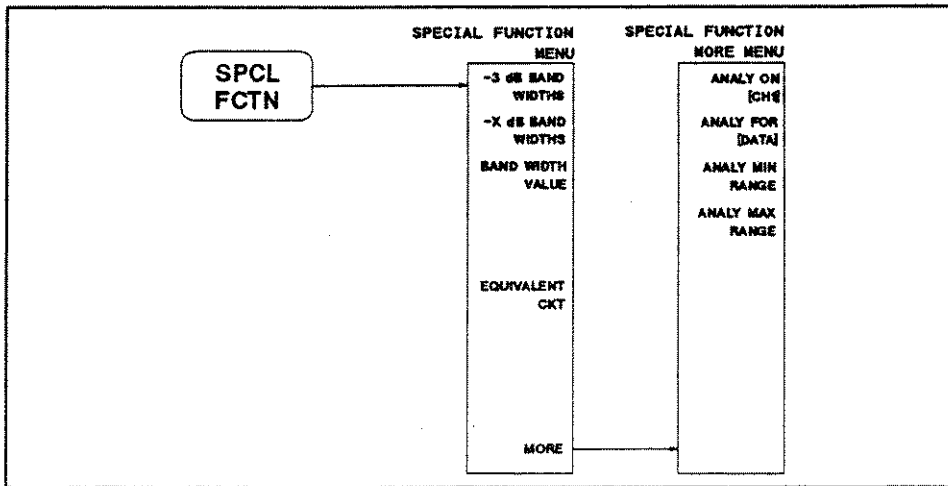

Figure E-11. SPCL FCTN Key

INSTRUMENT STATE FUNCTION Block

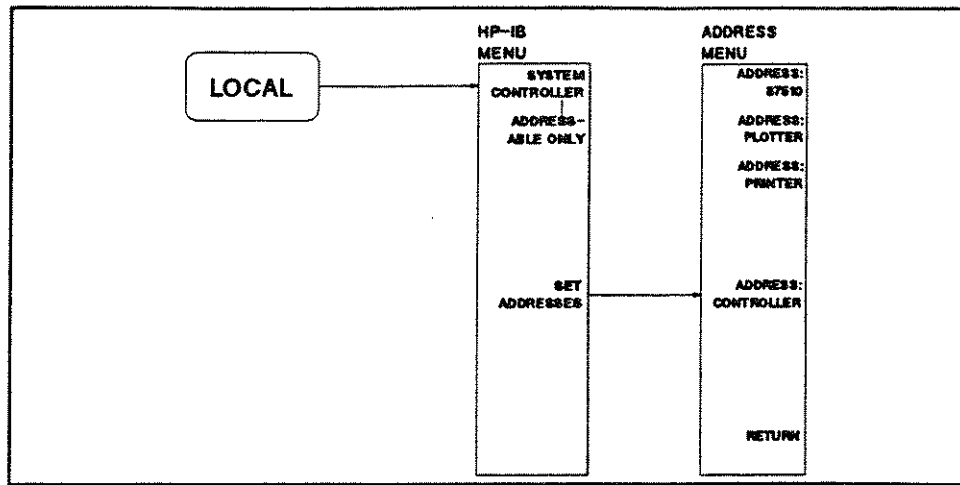

Figure E-12. LOCAL Key

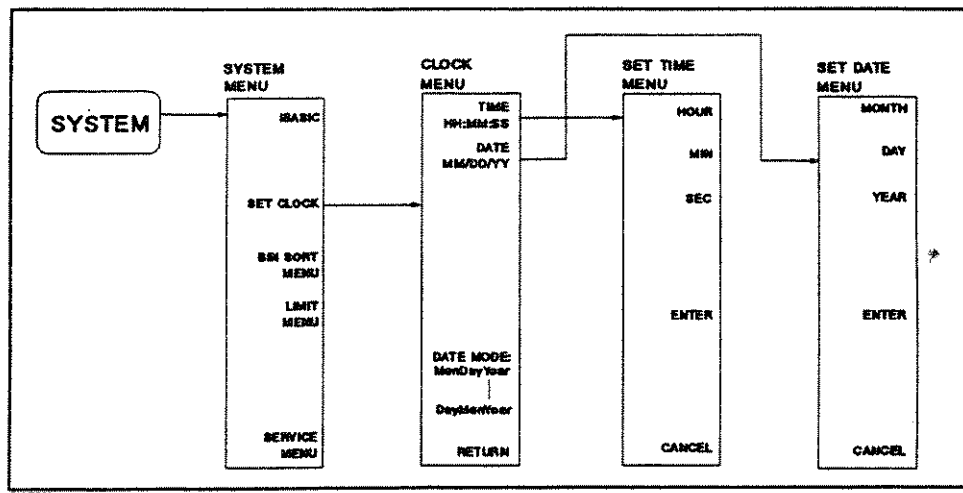

Figure E-13. SYSTEM Key (1/4)

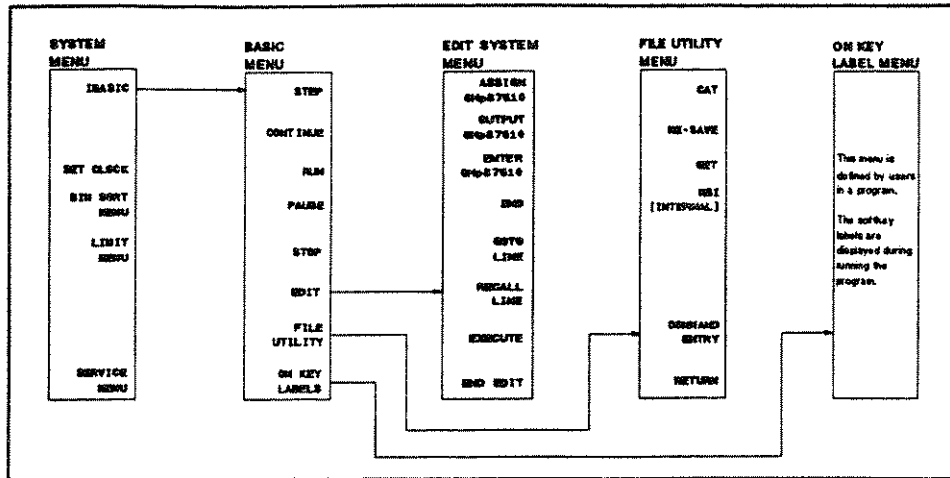

Figure E-14. (SYSTEM) Key (2/4)

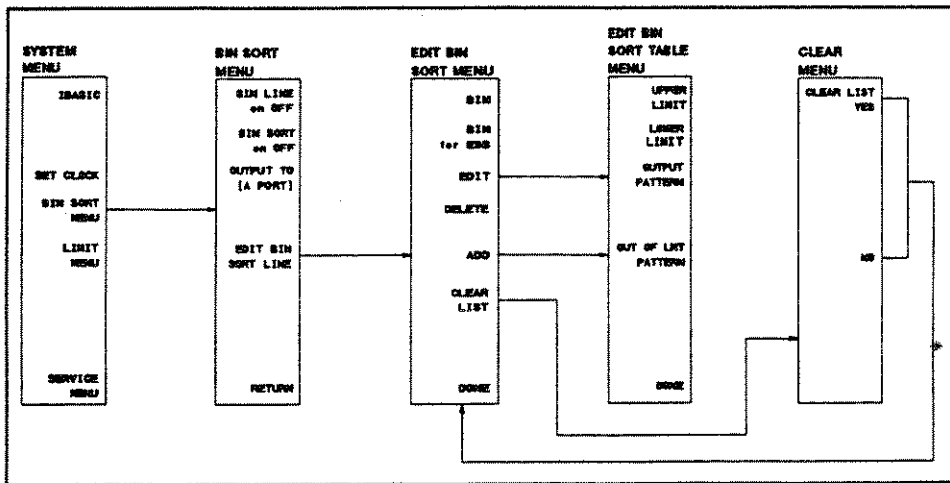

Figure E-15. (SYSTEM) Key (3/4)

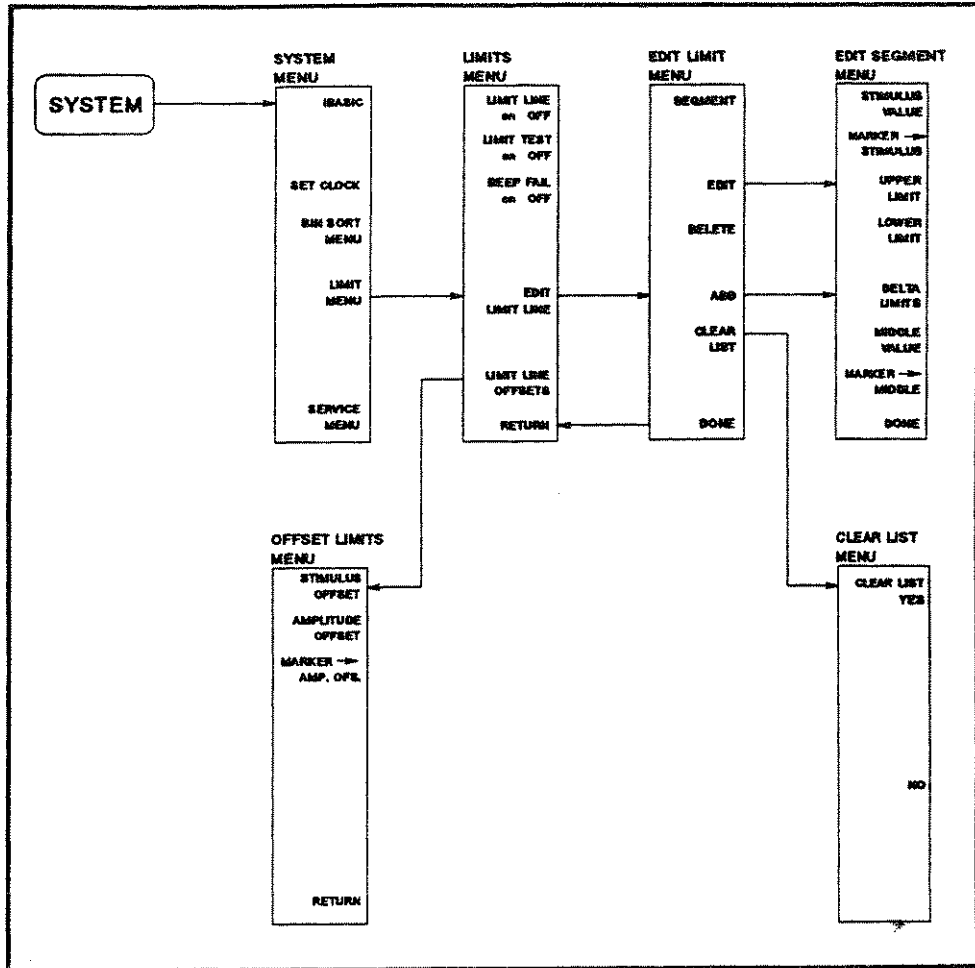

Figure E-16. **SYSTEM** Key (4/4)

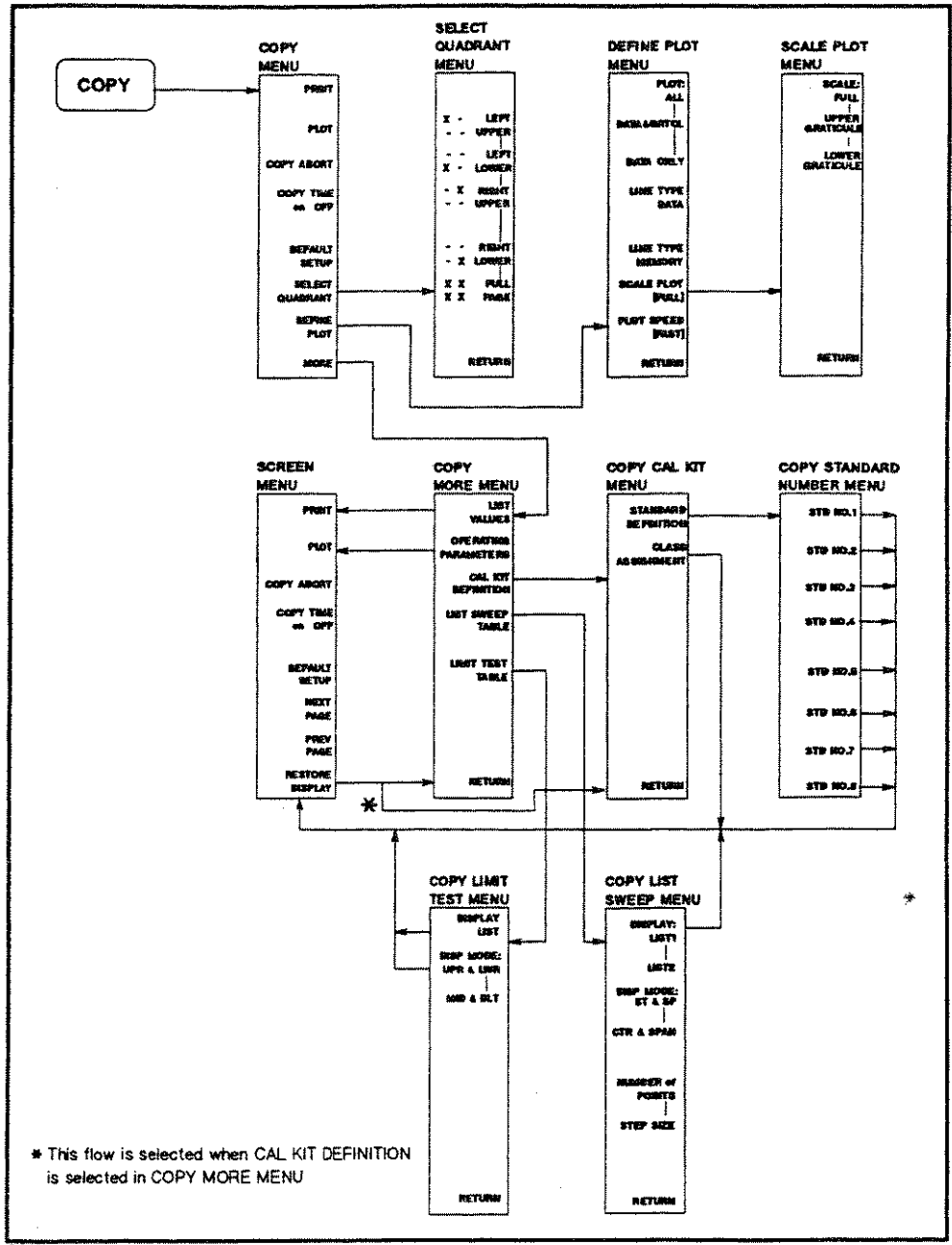
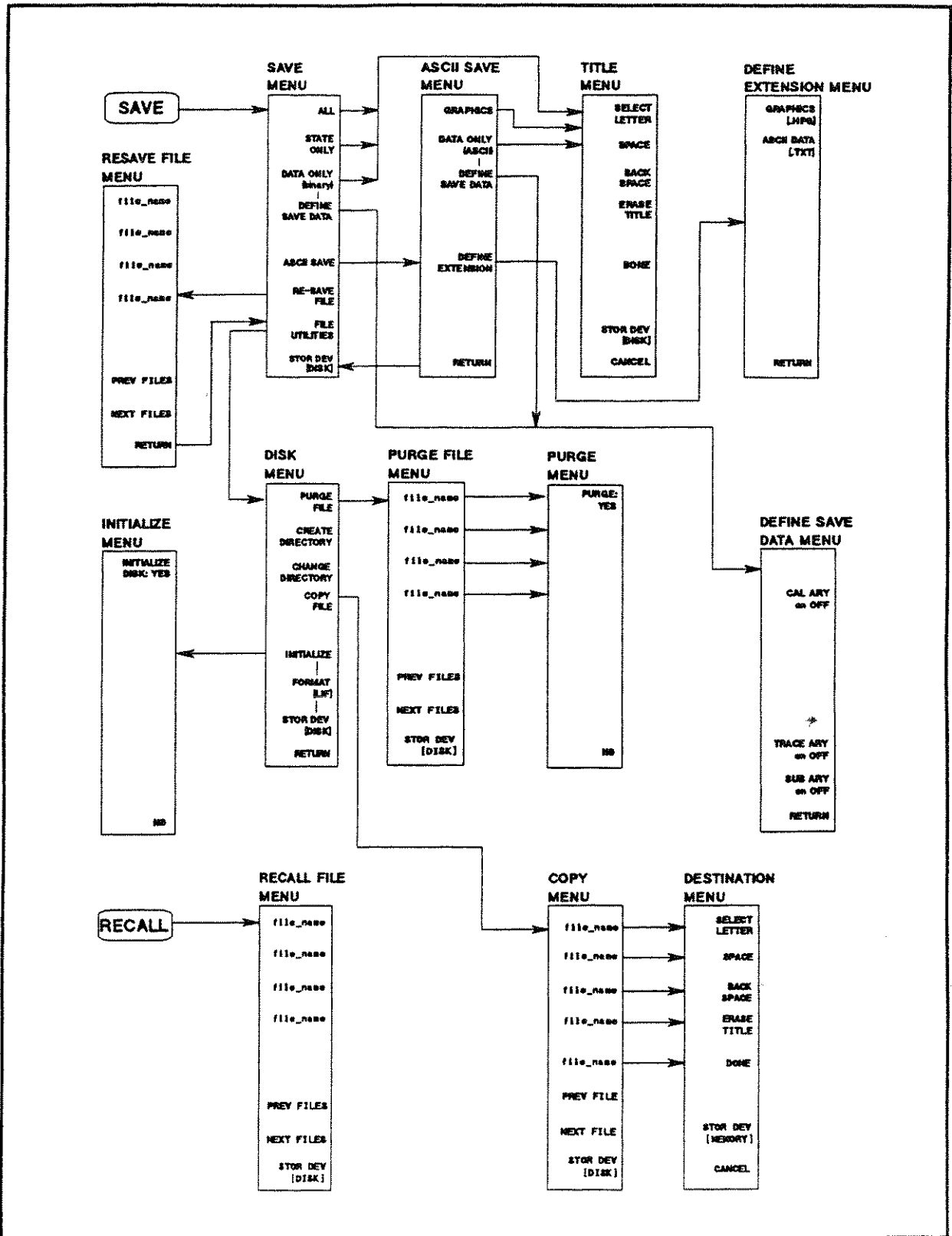

Figure E-17. COPY Key



C4014004

Figure E-18. **SAVE** and **RECALL** Key

Error Messages

This section lists the error messages that are displayed on the analyzer display or transmitted by the instrument over HP-IB. Each error message is accompanied by an explanation, and suggestions are provided to help in solving the problem. Where applicable, references are given to related sections of the Operation and Maintenance manuals.

When displayed, error messages are usually preceded with the word "CAUTION:". That part of the error message has been omitted here for the sake of brevity. Some messages are for information only, and do not indicate an error condition. Two listings are provided: the first is in alphabetical order, and the second in numerical order.

In addition to error messages, instrument status is indicated by status notations in the left margin of the display. Examples are "*", "msH", and "P↓". Sometimes these appear in conjunction with error messages. A complete listing of status and notations and their meanings is provided in "Front and Rear Panel" in the *Reference Manual*.

Error Messages in Alphabetical Order

160 +12V OUT OF SPEC

Severe error. Contact your nearest Hewlett-Packard office.

161 +15V(A) OUT OF SPEC

Severe error. Contact your nearest Hewlett-Packard office.

163 +15.3V OUT OF SPEC

Severe error. Contact your nearest Hewlett-Packard office.

158 +18V OUT OF SPEC

Severe error. Contact your nearest Hewlett-Packard office.

162 +22V OUT OF SPEC

Severe error. Contact your nearest Hewlett-Packard office.

166 +5V(A) OUT OF SPEC

Severe error. Contact your nearest Hewlett-Packard office.

164 +5V(D) OUT OF SPEC

Severe error. Contact your nearest Hewlett-Packard office.

157 -12.6V OUT OF SPEC

Severe error. Contact your nearest Hewlett-Packard office.

156 -15V OUT OF SPEC

Severe error. Contact your nearest Hewlett-Packard office.

168 -5.3V(A) OUT OF SPEC

Severe error. Contact your nearest Hewlett-Packard office.

193 1st IF OFFSET OSC TEST FAILED

Severe error. Contact your nearest Hewlett-Packard office.

195 1st LOCAL OSC TEST FAILED

Severe error. Contact your nearest Hewlett-Packard office.

150 A1 CPU EXT BUS TEST FAILED

Severe error. Contact your nearest Hewlett-Packard office.

142 A1 ROM TEST FAILED

Severe error. Contact your nearest Hewlett-Packard office.

A40 HEAT SINK TOO HOT

The temperature sensors on the A4 post-regulator assembly have detected an over-temperature condition. Turn the power OFF and let the instrument cool down for approximately 10 minutes. If this message is displayed again, contact your nearest Hewlett-Packard office.

174 Ach A/D LINEARITY POOR

Severe error. Contact your nearest Hewlett-Packard office.

167 Ach A/D REF VOLTAGE OUT OF SPEC

Severe error. Contact your nearest Hewlett-Packard office.

171 Ach RECEIVER FUNCTIONALLY POOR

Severe error. Contact your nearest Hewlett-Packard office.

6 ADDITIONAL STANDARD NEEDED

Error correction for the selected calibration class cannot be computed until all the necessary standards have been measured.

14 BACKUP DATA LOST

Data check-sum error on the battery backup memory has occurred. The battery is recharged for approximately 10 minutes after power was turned ON.

144 BACKUP RAM TEST FAILED

Severe error. Contact your nearest Hewlett-Packard office.

-160 Block data error

Block data is improper.

-168 Block data not allowed

Block data is not allowed.

9 CALIBRATION ABORTED

The calibration in progress was terminated due to the change of the active channel or the stimulus parameters.

7 CALIBRATION REQUIRED

No valid calibration coefficients were found when user attempted to turn calibration on. See "Measurement Calibration" in the *Reference Manual*.

61 CAN'T CHANGE-ANOTHER CONTROLLER ON BUS

The analyzer cannot assume the mode of system controller until the active controller is removed from the bus or relinquishes the bus.

107 CAN'T SAVE GRAPHICS WHEN COPY IN PROGRESS

If user attempts to save graphics when a print or plot is in progress, this error message is displayed.

-148 Character data not allowed

Character data not allowed for this operation.

-144 Character data too long

Character data is too long (maximum length is 12 characters).

137 CONTINUOUS SWITCHING NOT ALLOWED

The current measurement requires the S-parameter test set to switch automatically between forward and reverse measurements (driving test port 1 and, then test port 2). See "Stimulus Function Block" in the *Reference Manual*.

-253 CORRUPT MEDIA

A legal program command could not be executed because of corrupt media; for example, a bad disk or wrong format.

13 CURRENT PARAMETER NOT IN CAL SET

HP-IB only. Correction is not valid for the selected measurement parameter. See "Measurement Calibration" in the *Reference Manual*.

-222 Data out of range

Numerical parameter of HP-IB command is out of the range defined.

-104 Data type error

Improper data type used (for example, string data was expected, but numeric data was received).

98 DC OVERLOAD ON INPUT A

99 DC OVERLOAD ON INPUT R

The DC voltage at one of the three receiver inputs approach the DC voltage damage level. See "Instrument Specifications" in the *General Information* section for DC damage level information.

-255 DIRECTORY FULL

A legal program command could not be executed because the media directory was full.

143 DRAM TEST FAILED

Severe error. Contact your nearest Hewlett-Packard office.

145 EEPROM TEST FAILED

Severe error. Contact your nearest Hewlett-Packard office.

183 EEPROM WRITE FAILED

Severe error. Contact your nearest Hewlett-Packard office.

12 EXCEEDED 7 STANDARDS PER CLASS

A maximum of seven standards can be defined for any class. See "Measurement Calibration" in the *Reference Manual*.

5 EXTERNAL REFERENCE UNLOCKED

The frequency of the external reference signal input to the connector on the rear panel deviates from $10/N$ MHz, where N is an integer between 1 to 10, and phase lock can no longer be maintained. See "Front and Rear Panel" in the *Reference Manual* for details about the signal requirements.

197 FAILURE FOUND ON A2 BOARD

Severe error. Contact your nearest Hewlett-Packard office.

199 FAILURE FOUND ON FLOPPY DISK DRIVER

Contact your nearest Hewlett-Packard office.

159 FAN POWER OUT OF SPEC

Severe error. Contact your nearest Hewlett-Packard office.

154 FDC CHIP TEST FAILED

Severe error. Contact your nearest Hewlett-Packard office.

-257 FILE NAME ERROR

A legal program command could not be executed because the file name on the device media was in error; for example, an attempt was made to copy to a duplicate file name.

-256 FILE NAME NOT FOUND

A legal program command could not be executed because the file name on the device media was not found; for example, an attempt was made to read or copy a nonexistent file.

192 FN FREQ TEST FAILED

Severe error. Contact your nearest Hewlett-Packard office.

182 FN PRETUNE-DAC/MONITOR FAILURE

Severe error. Contact your nearest Hewlett-Packard office.

200 FN SPURIOUS TEST FAILED

Sever error. Contact your nearest Hewlett-Packard office.

148 FPC TEST FAILED

Severe error. Contact your nearest Hewlett-Packard office.

-105 GET not allowed

GET is not allowed inside a program message.

151 GSP I/F TEST FAILED

Severe error. Contact your nearest Hewlett-Packard office.

155 HPIB CHIP TEST FAILED

Severe error. Contact your nearest Hewlett-Packard office.

147 INTR TIMER TEST FAILED

Severe error. Contact your nearest Hewlett-Packard office.

-161 Invalid block data

Invalid block data was received (for example, END received before length satisfied).

-141 Invalid character data

Bad character data or unrecognized character data was received.

-121 Invalid character in number

Invalid character in numeric data.

-101 Invalid character

Invalid character was received.

214 INVALID DATE

Invalid date was set.

105 INVALID FILE NAME

HP-IB only. The file name for the RECALL, PURGE, or RE-SAVE function must have an "_A", "_D", or "_S" extension. See "Saving and Recalling Instrument States and Data" in the *Reference Manual* for more information.

-103 Invalid separator

The message unit separator (for example, ";", ",", ") is improper.

-151 Invalid string data

Invalid string data was received (for example, END received before close quote).

-131 Invalid suffix

Units are unrecognized, or the units are not appropriate.

153 KEY CHIP TEST FAILED

Severe error. Contact your nearest Hewlett-Packard office.

108 LIF-DOS COPY NOT ALLOWED

If the user tries to copy a file between the RAM disk and the flexible disk when the format of the RAM disk is different from the format of the flexible disk, this message is displayed.

67 LIST TABLE EMPTY OR INSUFFICIENT TABLE

The frequency list is empty. To implement the list frequency mode, add segments to the list table. See "Stimulus Function Block" in the *Reference Manual*.

61 LOCAL MAX NOT FOUND

The maximum peak whose sharpness is defined by the peak define function cannot be found.

62 LOCAL MIN NOT FOUND

The minimum peak whose sharpness is defined by the peak define function cannot be found.

-250 MASS STORAGE ERROR

A mass storage error occurred. This error message is used when the device cannot detect the more specific errors described for errors -251 through -259.

-254 MEDIA FULL

A legal program command could not be executed because the media was full.

-258 **MEDIA PROTECTED**

A legal program command could not be executed because the media was protected; for example, the disk was write-protected.

-251 **MISSING MASS STORAGE**

A legal program command could not be executed because of missing mass storage; for example, attempt to access an external disk drive by using Instrument BASIC.

-252 **MISSING MEDIA**

A legal program command could not be executed because of a missing media; for example, no disk.

-109 **Missing parameter**

A command with an improper number of parameters received.

179 **MIXER LINEARITY POOR**

Severe error. Contact your nearest Hewlett-Packard office.

8 **NO CALIBRATION CURRENTLY IN PROGRESS**

The **RESUME CAL SEQUENCE** softkey is not valid unless a calibration was already in progress. Start a new calibration. See "Measurement Calibration" in the *Reference Manual*.

77 **NO DATA TRACE**

The **MARKER ON [DATA]** is selected while the data trace is not displayed.

106 **NO LEGAL FILES ON DISK**

There are no files on the disk with extensions, "_A", "_D", or "_S". See "Saving and Recalling Instrument States and Data" in the *Reference Manual* for more information.

83 **NO MARKER DELTA - PEAK DEF NOT SET**

The **MARKER → PEAK DEF** softkey requires that delta marker mode be turned ON, with at least two markers displayed. See "Using Markers" in the *Reference Manual*.

80 **NO MARKER DELTA - RANGE NOT SET**

The **SEARCH RNG STORE** softkey requires that delta marker mode be turned ON, with at least two markers displayed. See "Using Markers" in the *Reference Manual*.

79 **NO MARKER DELTA - SPAN NOT SET**

The **MARKER → SPAN** softkey requires that delta marker mode be turned ON, with at least two markers displayed. See "Using Markers" in the *Reference Manual*.

78 **NO SUB TRACE**

The **MARKER FOR [SUB]** is selected while the sub trace is not displayed.

113 NO SUB TRACE DISPLAYED

The **SCALE FOR [SUB]** is selected while the memory trace is not displayed.

118 NO VALID Ach ABS MAG CORRECTION CONSTANTS

Severe error. Contact your nearest Hewlett-Packard office.

126 NO VALID FN PRETUNE CORRECTION CONSTANTS

Severe error. Contact your nearest Hewlett-Packard office.

30 NO VALID MEMORY

If a memory array is to be displayed or otherwise used, a data must first be stored to memory by HP-IB.

124 NO VALID PWR LIN CORRECTION CONSTANTS

Severe error. Contact your nearest Hewlett-Packard office.

120 NO VALID RATIO A/R CORRECTION CONSTANTS

Severe error. Contact your nearest Hewlett-Packard office.

117 NO VALID Rch ABS MAG CORRECTION CONSTANTS

Severe error. Contact your nearest Hewlett-Packard office.

31 NOT AVAILABLE FOR THIS FORMAT

The **D&M SCALE [COUPLED]** softkey is not valid when the format is either LOG MAG & PHASE, or LOG MAG & DELAY.

41 NOT ENOUGH DATA

HP-IB only. The amount of data sent to the analyzer is less than that expected.

-128 Numeric data not allowed

Numerical data not allowed for this operation.

-123 Numeric overflow

Numerical data value was too large (exponent magnitude >32,000).

-108 Parameter not allowed

Too many parameters for the command received.

25 PLOTTER NOT READY-PINCH WHEELS UP

If user attempts to plot when the plotter's pinch wheels are up, this message is displayed.

23 PLOTTER: not on, not connected, wrong address

The plotter does not respond to control. Verify power to the plotter, and check the HP-IB connection between the analyzer and the plotter. Ensure that the plotter address recognized by the analyzer matches the HP-IB address set on the plotter itself. See "Instrument State Function Block" in the *Reference Manual* for instruction on setting peripheral addresses.

186 POWER LINEARITY TEST FAILED

Severe error. Contact your nearest Hewlett-Packard office.

POWER SHUT DOWN (ANALOG SYSTEM)

Severe error. Contact your nearest Hewlett-Packard office.

4 POWER SHUT DOWN (FDD, FRONT PANEL)

Severe error. Contact your nearest Hewlett-Packard office.

22 PRINTER: not on, not connected, wrong address

The printer does not respond to control. Verify power to the plotter, and check the HP-IB connection between the analyzer and the printer. Ensure that the printer address recognized by the analyzer matches the HP-IB address set on the printer itself. See "Instrument State Function Block" in the *Reference Manual* for instruction on setting peripheral addresses.

-112 Program mnemonic too long

Program mnemonic is too long (maximum length is 12 characters).

-430 Query DEADLOCKED

Input buffer and output buffer are full; cannot continue.

-400 Query error

Query is improper.

-410 Query INTERRUPTED

Query is followed by DAB or GET before the response was completed.

-440 Query UNTERMINATED after indefinite response

The query which requests arbitrary data response (*IDN? and *OPT? queries) was sent before usual queries in a program message. (for example, FREQ?; *IDN? was expected, but *IDN?; FREQ? is received.)

-420 Query UNTERMINATED

Addressed to talk, incomplete program message received.

146 RATE TIMER TEST FAILED

Severe error. Contact your nearest Hewlett-Packard office.

173 Rch A/D LINEARITY POOR

Severe error. Contact your nearest Hewlett-Packard office.

165 Rch A/D REF VOLTAGE OUT OF SPEC

Severe error. Contact your nearest Hewlett-Packard office.

170 Rch RECEIVER FUNCTIONALLY POOR

Severe error. Contact your nearest Hewlett-Packard office.

149 REALTIME CLOCK TEST FAILED

Severe error. Contact your nearest Hewlett-Packard office.

REAR PANEL FAN STOPPED

The analyzer detected that the rear panel fan stopped and automatically shut down the power.

104 RECALL ERROR: INSTR STATE PRESET

A serious error, for example corrupted data, is detected on recalling a file, and this forced the analyzer to be PRESET.

194 RF OSC TEST FAILED

Severe error. Contact your nearest Hewlett-Packard office.

189 RF POWER LEVEL (LF) TEST FAILED

Severe error. Contact your nearest Hewlett-Packard office.

103 SAVE ERROR

A serious error, for example physically damaged disk surface, is detected on saving a file.

-150 String data error

String data is improper.

-158 String data not allowed

String data is not allowed.

-138 Suffix not allowed

A suffix is not allowed for this operation.

-102 Syntax error

Unrecognized command or data type was received.

-124 Too many digits

Numerical data length was too long (more than 255 digits received).

224 TOO MANY ENTRY

The maximum number of BINs for BIN sorting is 16.

-350 Too many errors

Too many errors occurred in HP-IB commands.

50 TOO MANY SEGMENTS

The maximum number of segments for the limit line table is 18. See "Instrument State Function Block" in the *Reference Manual*.

68 TOO MANY SEGMENTS OR POINTS

Frequency list mode is limited to 31 segments or 801 points. See "Stimulus Function Block" in the *Reference Manual* for more information.

-223 Too much data

Either there is too much binary data to send to the analyzer when the data transfer format is FORM 2, FORM 3 or FORM 5, or the amount of data is greater than the number of points.

41 TOO MUCH DATA

The number of data to be sent to the analyzer is greater than that expected.

-113 Undefined header

Undefined header or an unrecognized command was received (operation not allowed).

180 VCO MISADJUSTED, RETRY THIS TEST

Severe error. Contact your nearest Hewlett-Packard office.

152 VRAM TEST FAILED

Severe error. Contact your nearest Hewlett-Packard office.

235 WRONG I/O PORT DIRECTION

The direction of I/O port C or D is opposite.

Error Messages in Numerical Order

POWER SHUT DOWN (ANALOG SYSTEM)

Severe error. Contact your nearest Hewlett-Packard office.

A40 HEAT SINK TOO HOT

The temperature sensors on the A4 post-regulator assembly have detected an over-temperature condition. Turn the power off and let the instrument cool down for approximately 10 minutes. If this message is displayed again, contact your nearest Hewlett-Packard office.

REAR PANEL FAN STOPPED

The analyzer detected that the rear panel fan stopped and automatically shut down the power.

4 POWER SHUT DOWN (FDD, FRONT PANEL)

Severe error. Contact your nearest Hewlett-Packard office.

5 EXTERNAL REFERENCE UNLOCKED

The frequency of the external reference signal input to the connector on the rear panel deviates from $10/N$ MHz, where N is an integer between 1 to 10, and phase lock can no longer be maintained. See "Front and Rear Panel" in the *Reference Manual* for details about the signal requirements.

6 ADDITIONAL STANDARDS NEEDED

Error correction for the selected calibration class cannot be computed until all the necessary standards have been measured.

7 CALIBRATION REQUIRED

No valid calibration coefficients were found when user attempted to turn calibration on. See "Measurement Calibration" in the *Reference Manual*.

8 NO CALIBRATION CURRENTLY IN PROGRESS

The **RESUME CAL SEQUENCE** softkey is not valid unless a calibration was already in progress. Start a new calibration. See "Measurement Calibration" in the *Reference Manual*.

9 CALIBRATION ABORTED

The calibration in progress was terminated due to change of the active channel or stimulus parameters.

12 EXCEEDED 7 STANDARDS PER CLASS

A maximum of seven standards can be defined for any class. See "Measurement Calibration" in the *Reference Manual*.

13 CURRENT PARAMETER NOT IN CAL SET

HP-IB only. Correction is not valid for the selected measurement parameter. See "Measurement Calibration" in the *Reference Manual*.

14 BACKUP DATA LOST

Data check-sum error on the battery backup memory has occurred. The battery is recharged for approximately 10 minutes after power was turned on.

22 PRINTER: not on, not connect, wrong address

The printer does not respond to control. Verify power to the plotter, and check the HP-IB connection between the analyzer and the printer. Ensure that the printer address recognized by the analyzer matches the HP-IB address set on the printer itself. See "Instrument State Function Block" in the *Reference Manual* for instruction on setting peripheral addresses.

23 PLOTTER: not on, not connect, wrong address

The plotter does not respond to control. Verify power to the plotter, and check the HP-IB connection between the analyzer and the plotter. Ensure that the plotter address recognized by the analyzer matches the HP-IB address set on the plotter itself. See "Instrument State Function Block" in the *Reference Manual* for instruction on setting peripheral addresses.

25 PLOTTER NOT READY-PINCH WHEELS UP

If user attempts to plot when the plotter's pinch wheels are up, this message is displayed.

30 NO VALID MEMORY

If a memory array is to be displayed or otherwise used, a data must first be stored to memory by HP-IB.

40 TOO MUCH DATA

The amount of data to be sent to the analyzer is greater than that expected.

41 NOT ENOUGH DATA

HP-IB only. The amount of data sent to the analyzer is less than that expected.

50 TOO MANY SEGMENTS

The maximum number of segments for the limit line table is 18. See "Instrument State Function Block" in the *Reference Manual*.

61 CAN'T CHANGE- ANOTHER CONTROLLER ON BUS

The analyzer cannot assume the mode of system controller until the active controller is removed from the bus or relinquishes the bus.

67 LIST TABLE EMPTY OR INSUFFICIENT TABLE

The frequency list is empty. To implement the list frequency mode, add segments to the list table. See "Stimulus Function Block" in the *Reference Manual*.

68 TOO MANY SEGMENTS OR POINTS

Frequency list mode is limited to 31 segments or 801 points. See "Stimulus Function Block" in the *Reference Manual* for more information.

77 NO DATA TRACE

The **MARKER ON [DATA]** is selected while the data trace is not displayed.

78 NO MEMORY TRACE

The **MARKER ON [MEMORY]** is selected while the memory trace is not displayed.

79 NO MARKER DELTA - SPAN NOT SET

The **MARKER → SPAN** softkey requires that delta marker mode be turned ON, with at least two markers displayed. See "Using Markers" in the *Reference Manual*.

80 NO MARKER DELTA - RANGE NOT SET

The **SEARCH RNG STORE** softkey requires that delta marker mode be turned ON, with at least two markers displayed. See "Using Markers" in the *Reference Manual*.

81 LOCAL MAX NOT FOUND

The maximum peak whose sharpness is defined by the peak define function cannot be found.

82 LOCAL MIN NOT FOUND

The minimum peak whose sharpness is defined by the peak define function cannot be found.

83 NO MARKER DELTA - PEAK DEF NOT SET

The **MARKER → PEAK DEF** softkey requires that delta marker mode be turned ON, with at least two markers displayed. See "Using Markers" in the *Reference Manual*.

95 OVERLOAD ON INPUT A, POWER REDUCED

96 OVERLOAD ON INPUT R, POWER REDUCED

When the power level at one of the three receiver inputs exceeds a certain level greater than the maximum input level, the RF output power level is automatically reduced to minimum and the annotation "P↓" appears in the left margin of the display. See "Stimulus Function Block" in the *Reference Manual*.

103 SAVE ERROR

A serious error, for example physically damaged disk surface, is detected on saving a file.

104 RECALL ERROR: INSTR STATE PRESET

A serious error, for example corrupted data, is detected on recalling a file, and this forced the analyzer to be PRESET.

105 INVALID FILE NAME

HP-IB only. The file name for the RECALL, PURGE, or RE-SAVE function must have an "_A", "_D", or "_S" extension. See "Saving and Recalling Instrument States and Data" in the *Reference Manual* for more information.

106 NO LEGAL FILES ON DISK

There are no files on the disk with extensions, "_A", "_D", or "_S". See "Saving and Recalling Instrument States and Data" in the *Reference Manual* for more information.

107 CAN'T SAVE GRAPHICS WHEN COPY IN PROGRESS

If user attempts to save graphics when a print or plot is in progress, this error message is displayed.

108 LIF-DOS COPY NOT ALLOWED

If the user tries to copy a file between the RAM disk and the flexible disk when the format of the RAM disk is different from the format of the flexible disk, this message is displayed.

112 NO DATA TRACE DISPLAYED

The **SCALE FOR [DATA]** is selected while the data trace is not displayed.

113 NO MEMORY TRACE DISPLAYED

The **SCALE FOR [MEMORY]** is selected while the memory trace is not displayed.

117 NO VALID Rch ABS MAG CORRECTION CONSTANTS

Severe error. Contact your nearest Hewlett-Packard office.

118 NO VALID Ach ABS MAG CORRECTION CONSTANTS

Severe error. Contact your nearest Hewlett-Packard office.

120 NO VALID RATIO A/R CORRECTION CONSTANTS

Severe error. Contact your nearest Hewlett-Packard office.

124 NO VALID HF PWR LIN CORRECTION CONSTANTS

Severe error. Contact your nearest Hewlett-Packard office.

126 NO VALID FN PRETUNE CORRECTION CONSTANTS

Severe error. Contact your nearest Hewlett-Packard office.

142 A1 ROM TEST FAILED

Severe error. Contact your nearest Hewlett-Packard office.

143 DRAM TEST FAILED

Severe error. Contact your nearest Hewlett-Packard office.

144 BACKUP RAM TEST FAILED

Severe error. Contact your nearest Hewlett-Packard office.

145 EEPROM TEST FAILED

Severe error. Contact your nearest Hewlett-Packard office.

146 RATE TIMER TEST FAILED

Severe error. Contact your nearest Hewlett-Packard office.

147 INTR TIMER TEST FAILED

Severe error. Contact your nearest Hewlett-Packard office.

148 FPC TEST FAILED

Severe error. Contact your nearest Hewlett-Packard office.

149 REALTIME CLOCK TEST FAILED

Severe error. Contact your nearest Hewlett-Packard office.

150 A1 CPU EXT BUS TEST FAILED

Severe error. Contact your nearest Hewlett-Packard office.

151 GSP I/F TEST FAILED

Severe error. Contact your nearest Hewlett-Packard office.

152 VRAM TEST FAILED

Severe error. Contact your nearest Hewlett-Packard office.

153 KEY CHIP TEST FAILED

Severe error. Contact your nearest Hewlett-Packard office.

154 FDC CHIP TEST FAILED

Severe error. Contact your nearest Hewlett-Packard office.

155 HPIB CHIP TEST FAILED

Severe error. Contact your nearest Hewlett-Packard office.

156 -15V OUT OF SPEC

Severe error. Contact your nearest Hewlett-Packard office.

157 -12.6V OUT OF SPEC

Severe error. Contact your nearest Hewlett-Packard office.

158 +18V OUT OF SPEC

Severe error. Contact your nearest Hewlett-Packard office.

159 FAN POWER OUT OF SPEC

Severe error. Contact your nearest Hewlett-Packard office.

160 +12V OUT OF SPEC

Severe error. Contact your nearest Hewlett-Packard office.

161 +15V(A) OUT OF SPEC

Severe error. Contact your nearest Hewlett-Packard office.

162 +22V OUT OF SPEC

Severe error. Contact your nearest Hewlett-Packard office.

163 +65V OUT OF SPEC

Severe error. Contact your nearest Hewlett-Packard office.

164 +5V(D) OUT OF SPEC

Severe error. Contact your nearest Hewlett-Packard office.

165 Rch A/D REF VOLTAGE OUT OF SPEC

Severe error. Contact your nearest Hewlett-Packard office.

166 +5V(A) OUT OF SPEC

Severe error. Contact your nearest Hewlett-Packard office.

167 Ach A/D REF VOLTAGE OUT OF SPEC

Severe error. Contact your nearest Hewlett-Packard office.

168 -5.2V(A) OUT OF SPEC

Severe error. Contact your nearest Hewlett-Packard office.

170 Rch RECEIVER FUNCTIONALLY POOR

Severe error. Contact your nearest Hewlett-Packard office.

171 Ach RECEIVER FUNCTIONALLY POOR

Severe error. Contact your nearest Hewlett-Packard office.

173 Rch A/D LINEARITY POOR

Severe error. Contact your nearest Hewlett-Packard office.

174 Ach A/D LINEARITY POOR

Severe error. Contact your nearest Hewlett-Packard office.

177 IF GAIN OUT OF SPEC

Severe error. Contact your nearest Hewlett-Packard office.

179 MIXER LINEARITY POOR

Severe error. Contact your nearest Hewlett-Packard office.

180 VCO MISADJUSTED, RETRY THIS TEST

Severe error. Contact your nearest Hewlett-Packard office.

182 FN PRETUNE-DAC/MONITOR FAILURE

Severe error. Contact your nearest Hewlett-Packard office.

183 EEPROM WRITE FAILED

Severe error. Contact your nearest Hewlett-Packard office.

186 POWER LINEARITY TEST FAILED

Severe error. Contact your nearest Hewlett-Packard office.

189 RF POWER LEVEL ALC(LF) TEST FAILED

Severe error. Contact your nearest Hewlett-Packard office.

192 FN FREQ TEST FAILED

Severe error. Contact your nearest Hewlett-Packard office.

193 1st IF OFFSET OSC TEST FAILED

Severe error. Contact your nearest Hewlett-Packard office.

194 RF OSC TEST FAILED

Severe error. Contact your nearest Hewlett-Packard office.

195 1st LOCAL OSC TEST FAILED

Severe error. Contact your nearest Hewlett-Packard office.

197 FAILURE FOUND ON A2 BOARD

Severe error. Contact your nearest Hewlett-Packard office.

199 FAILURE FOUND ON FLOPPY DISK DRIVER

Severe error. Contact your nearest Hewlett-Packard office.

200 FN SPURIOUS TEST FAILED

Severe error. Contact your nearest Hewlett-Packard office.

201 +5V (I/O OUT) OUT OF SPEC

Severe error. Contact your nearest Hewlett-Packard office.

202 +5V (I/O BD) OUT OF SPEC

Severe error. Contact your nearest Hewlett-Packard office.

214 INVALID DATE

Invalid date was set.

224 TOO MANY ENTRY

The maximum number of BINs for BIN sorting is 16.

235 WRONG I/O PORT DIRECTION

The direction of I/O port C or D is opposite.

-440 Query UNTERMINATED after indefinite response

The query which requests arbitrary data response (*IDN? and *OPT? queries) was sent before usual queries in a program message. (for example, FREQ?;*IDN? was expected, but *IDN?;FREQ? is received.)

-430 Query DEADLOCKED

Input buffer and output buffer are full; cannot continue.

-420 Query UNTERMINATED

Addressed to talk, incomplete program message received.

-410 Query INTERRUPTED

Query is followed by DAB or GET before the response was completed.

-400 Query error

Query is improper.

-350 Too many errors

Too many errors occurred in HP-IB commands.

-258 MEDIA PROTECTED

A legal program command could not be executed because the media was protected; for example, the disk was write-protected.

-257 FILE NAME ERROR

A legal program command could not be executed because the file name on the device media was in error; for example, an attempt was made to copy to a duplicate file name.

-256 FILE NAME NOT FOUND

A legal program command could not be executed because the file name on the device media was not found; for example, an attempt was made to read or copy a nonexistent file.

-255 DIRECTORY FULL

A legal program command could not be executed because the media directory was full.

-254 MEDIA FULL

A legal program command could not be executed because the media was full.

-253 CORRUPT MEDIA

A legal program command could not be executed because of corrupt media; for example, a bad disk or wrong format.

-252 MISSING MEDIA

A legal program command could not be executed because of a missing media; for example, no disk.

-251 MISSING MASS STORAGE

A legal program command could not be executed because of missing mass storage; for example, attempt to access an external disk drive by using Instrument BASIC.

-250 MASS STORAGE ERROR

A mass storage error occurred. This error message is used when the device cannot detect the more specific errors described for errors -251 through -259.

-223 Too much data

Either there is too much binary data to send to the analyzer when the data transfer format is FORM 2, FORM 3 or FORM 5, or the amount of data is greater than the number of points.

-222 Data out of range

Numerical parameter of HP-IB command is out of the range defined.

-168 Block data not allowed

Block data is not allowed.

-161 Invalid block data

Invalid block data was received (for example, END received before length satisfied).

-160 Block data error

Block data is improper.

-158 String data not allowed

String data is not allowed.

-151 Invalid string data

Invalid string data was received (for example, END received before close quote).

-150 String data error

String data is improper.

-148 Character data not allowed

Character data not allowed for this operation.

-144 Character data too long

Character data is too long (maximum length is 12 characters).

-141 Invalid character data

Bad character data or unrecognized character data was received.

-138 Suffix not allowed

A suffix is not allowed for this operation.

-131 Invalid suffix

Units are unrecognized, or the units are not appropriate.

-128 Numeric data not allowed

Numerical data not allowed for this operation.

-124 Too many digits

Numerical data length was too long (more than 255 digits received).

-123 Numeric overflow

Numerical data value was too large (exponent magnitude > 32,000).

-121 Invalid character in number

Invalid character in numeric data.

-113 Undefined header

Undefined header or an unrecognized command was received (operation not allowed).

-112 Program mnemonic too long

Program mnemonic is too long (maximum length is 12 characters).

-109 Missing parameter

A command with an improper number of parameters was received.

-108 Parameter not allowed

Too many parameters for the command received.

-105 GET not allowed

GET is not allowed inside a program message.

-104 Data type error

Improper data type used (for example, string data was expected, but numeric data was received).

-103 Invalid separator

The message unit separator (for example, ";", ",", ") is improper.

-102 Syntax error

Unrecognized command or data type was received.

-101 Invalid character

Invalid character was received.

Index

Special characters

*****, 5-7, 8-6

⏏, 7-2

⏏, 7-2

Δ MODE MENU, 11-3

Δ MODE OFF, 11-6

Δ REF MARKER, 11-6

ΔREF=Δ FIXED MKR, 11-6

↑, 8-5

ⓧ, 7-2

Numbers

1/S, 9-4

3 term calibration, 10-2

3 TERM S11 1-PORT, 10-9

A

A, 9-3

Accessory, 1-1

ACTIVATE MARKER, 11-3

Active channel, 5-5, 6-1

Active channel key, 5-4, 6-1

Active Entry Area, 5-7

Active marker, 11-3, 11-4

ADD, 8-9, 12-22

ADDRCONT, 12-5

ADDRESS: 87510, 12-5

Addressable, 12-3, 15-3

ADDRESSABLE ONLY, 12-4

ADDRESS: CONTROLLER, 12-5

ADDRESS: PLOTTER, 12-5

ADDRESS: PRINTER, 12-5

ADDRPLOT, 12-5

ADDRPRIN, 12-5

ALL, 14-13

ALL BASIC, 9-17

ALL INSTRUMENT, 9-17

ALL MKR OFF, 11-3

AMPLITUDE OFFSET, 12-25

Aperture, 9-10

A/R, 9-3

AR, 9-3

AUTO, 9-12

AUTOREC, 14-5

Auto recall, 14-5

AUTO SCALE, 9-12

Auto sweep time, 8-5

Averaging, 4-4, 9-19

Averaging factor, 9-19, 9-21

AVERAGING FACTOR, 9-21

AVERAGING on OFF, 9-22

AVERAGING RESTART, 9-21, 9-22

AVERFACT, 9-21

AVEROFF, 9-22

AVERON, 9-22

AVERREST, 9-21

Avg, 5-7, 9-22

AVG, 9-1, 9-11, 9-19

B

BACK SPACE, 7-2

BACK SPACE, 9-18, 14-14

BASIC STATUS, 9-17

Battery backup, B-1

Beep, 12-27

BEEPDONEOFF, 9-16

BEEPDONEON, 9-16

BEEP DONE ON off, 9-16

BEEPFAILOFF, 12-21

BEEPFAILON, 12-21

BEEP FAIL on OFF, 12-21

BEEPWARNOFF, 9-16

BEEPWARNON, 9-16

BEEP WARN on OFF, 9-16

BINCEL, 12-16

BINL, 12-15

BIN LINE on OFF, 12-13

BINO, 12-15

BINOA, 12-13

BINOB, 12-13

BINP, 12-15

BINS, 12-13

BINSLINE, 12-13

BIN sort function, 12-11
BIN SORT MENU, 12-6
BIN SORT on OFF, 12-13
BIN SORT TABLE, 13-10
 BINU, 12-15
 Built-in Flexible Disk Drive, 5-4
 Built-in power splitter, 4-2

C
 C!, 5-7
 C?, 5-7
CAL, 10-3
CAL ARY on OFF, 14-17
 CALCASSI, 13-10
CALIBRATE MENU, 10-5
CALIBRATE: NONE, 10-9
 Calibration, 10-1, 10-9
 Calibration coefficients arrays, 14-2
 Calibration kit, 10-11
 CALIRAI, 10-9
 CALIRESP, 10-9
 CALIS111, 10-9
 CALK7MM, 10-6
 Cal kit, 10-11
CAL KIT, 10-6, 10-13
CAL KIT: 7mm, 10-6
CAL KIT DEFINITION, 13-10, 13-14
 CALKN50, 10-6
 CALKN75, 10-6
 CALKUSED, 10-6
 CALN, 10-9
 CALS, 13-11
 CENT, 8-1, 8-11
CENTER, 8-11
CH 1, 6-1
CH 2, 6-1
 CHAD, 14-19
 CHAN1, 6-1
 CHAN2, 6-1
CHANGE DIRECTORY, 14-19
 Channel coupling, 10-4
 Class assignment, B-8
CLASS ASSIGNMENT, 13-10
CLEAR LIST, 8-9, 12-16
 Clear list menu, 8-12, 12-24
CLEAR LIST YES, 8-12, 12-24
CLEAR MARKER, 11-3
 Clear marker menu, 11-5
 CLEL, 8-9, 8-12
 CLEM1, 11-5

CLEM2, 11-5
 CLEM3, 11-5
 CLEM4, 11-5
 CLEM5, 11-5
 CLEM6, 11-5
 CLEM7, 11-5
 CLEM8, 11-5
 Clock menu, 12-10
COMMAND ENTRY, 12-9
 CONT, 8-6
CONTINUOUS, 8-6, 11-9
 Controller, 15-2
 CONV1DS, 9-4
CONVERSION, 9-3
 Conversion menu, 9-3
 CONVOFF, 9-4
 CONVYTRA, 9-4
 CONVZTRA, 9-4
 COPA, 13-4, 13-13
 COPTOFF, 13-4, 13-13
 COPTON, 13-4, 13-13
 Copy
 Address, 13-14
 Comment, 13-14
 Date, 13-14
 Plotter, 13-14
 Printer, 13-14
 Time, 13-14
 Title, 13-14
 Troubleshooting, 13-15
COPY, 12-10, 13-2, 13-14
COPY ABORT, 13-4, 13-13, 13-14
 Copy cal kit menu, 13-10
COPY FILE, 14-19
 Copy limit test menu, 13-12
 Copy list sweep menu, 13-11
 Copy menu, 13-4
 Copy more menu, 13-8
 Copy standard number menu, 13-11
COPY TIME, 12-10
COPY TIME on OFF, 13-4, 13-13
COPY TIME ON off, 13-14
 Cor, 5-7
 Correction menu, 10-5
CORRECTION on OFF, 10-5
 CORROFF, 10-5
 CORRON, 10-5
 COUCOFF, 8-4
 COUCON, 8-4
COUPLED CH on OFF, 8-4
CREATE DIRECTORY, 14-19
 CRED, 14-19

Crosstalk, 10-9
CRT display, 5-4, 5-5
CTR & SPAN, 13-12

D

DATA & GRATCL, 13-6, 13-15
DATA ONLY, 13-6, 13-15
DATA ONLY (ASCII), 14-15
Data point, 4-2
DATE MM/DD/YY, 12-10
DATE MODE: MonDayYear, 12-10
DAY, 12-10
DayMonYear, 12-10
DAYMYEAR, 12-10
Default, B-1
DEFAULT SETUP, 13-4
DEFINE EXTENSION, 14-15
DEFINE PLOT, 13-5, 13-15
Define plot menu, 13-6
DEFINE SAVE DATA, 14-13, 14-15
Define save data menu, 14-17
DEFINE STANDARD, 10-14
Define standard menu, 10-15
Define standard number menu, 10-15
DEFS, 10-14
Del, 5-7
DELA, 9-6
DELAY, 9-6
DELETE, 8-9, 12-22
DELO, 11-6
DELR1, 11-7
DELR2, 11-7
DELR3, 11-7
DELR4, 11-7
DELR5, 11-7
DELR6, 11-7
DELR7, 11-7
DELR8, 11-7
DELRFIXM, 11-6
DELTA LIMITS, 12-23
Delta marker menu, 11-6
Delta marker mode, 11-1, 11-5
DFLT, 13-4
Directivity, 10-9
DISAALLB, 9-17
DISAALLI, 9-17
DISABASI, 9-17
DISAHIHB, 9-17
Disk capacity, 14-4
Disk copy, 14-23

Disk format, 14-4
Disk menu, 14-19
DISL1, 13-11
DISL2, 13-11
DISLLIST, 13-12
DISMCTSP, 13-12
DISMMD, 13-12
DISMNUM, 13-12
DISMSTEP, 13-12
DISMSTSP, 13-11
DISMUL, 13-12
DISPLAY, 9-1, 9-14
DISPLAY ALLOCATION, 9-15
Display allocation menu, 9-17
DISPLAY LIST, 13-12
DISPLAY: LIST1, 13-11
Display menu, 9-14
DISP MODE: ST & SP, 13-11
DISP MODE: UPR & LWR, 13-12
DUACOFF, 9-14
DUACON, 9-14
DUAL CHAN on OFF, 9-14
DUT, 4-1

E

EDIT, 8-9, 12-22
EDIT:, 8-9
EDITBINL, 12-14
EDIT BIN SORT LINE, 12-14
EDITDONE, 8-10
EDIT LIMIT LINE, 12-21, 12-26
Edit limits menu, 12-21
EDITLIML, 12-21
EDITLIS1, 8-9
EDITLIS2, 8-9
EDIT LIST, 8-8
EDITLIST, 8-8
Edit list menu, 8-9
Edit segment menu, 8-10, 12-22
ELEC DELAY MENU, 9-12
Electrical delay, 4-4, 9-12
ELECTRICAL DELAY, 9-13, 10-7
ELED, 9-13
Entry, 5-4, 7-1
ENTRY OFF, 7-2, 12-27
ERASE TITLE, 9-18, 14-14
EXPANDED PHASE, 9-7
Expanded Phase format, 9-7
EXPP, 9-7
Ext, 5-7
EXTENSION, 10-8

EXTENSIONS on OFF, 10-8
EXT PROG RUN/CONT connector, 5-8
EXT REF INPUT connector, 5-8
EXTTOFF, 8-6
EXTTON, 8-6
EXTTPOIN, 8-7
EXT TRIGGER connector, 5-8
EXT. TRIG ON POINT, 8-7
EXT. TRIG ON SWEEP, 8-6

F

Factory setting, B-1
FAIL message, 12-27
Fan, 5-9
FILC, 14-19
File name, 14-4
File size, 14-5
FILE UTILITIES, 14-13
Filter measurement, 12-25
Fixed marker menu, 11-7
FIXED MKR AUX VALUE, 11-8
FIXED MKR STIMULUS, 11-8
FIXED MKR VALUE, 11-8
Format, 5-6, 9-5
FORMAT, 9-1, 9-5
Format more menu, 9-8
FREQ, 9-16
FREQUENCY BLANK, 9-16
Frequency list mode, 8-7
Frequency response, 10-9
Front panel, 5-3
FULL PAGE, 13-5
FULP, 13-5
Fuse, 1-3

G

G, 7-2
G/n, 7-2
Go/no-go testing, 12-25
GRAPHICS, 14-15
GRODAPER, 9-22
Group delay, 9-9
GROUP DELAY APERTURE, 9-11, 9-22

H

HALF INSTR HALF BASIC, 9-17
Hard copy, 13-1
Hewlett-Packard Interface Bus, 12-3, 15-1
Hld, 5-7, 8-6
HOLD, 8-6
HOLD, 8-6

HOOR, 12-10
HP-HIL connector, 5-4
HP-IB, 5-3, 12-3, 15-1
HP-IB address, 15-4
HP-IB connector, 5-8

I

IBASIC, 12-6
IF bandwidth, 4-3, 9-20, 9-22, 9-23
IF BW, 8-11, 9-22
IFBW, 8-11, 9-22
IF BW AUTO, 9-23
IFBWAUTO, 9-23
IF (Intermediate frequency), 4-2
IMAG, 9-8
IMAGINARY, 9-8
Imaginary format, 9-8
Incoming Inspection, 1-1
INID, 14-19
Initialize, B-1
INITIALIZE DISK [], 14-19
Initialize menu, 14-21
INITIALIZE YES, 14-21
Input port menu, 9-2
inputs R and A, 5-4
Insertion loss, 12-28
Instrument BASIC, 12-7
Instrument data arrays, 14-2
Instrument state, 5-2
Instrument state data, 14-2
Instrument state function, 5-4, 12-1
Instrument states and internal data arrays,
14-3
Intensity, 5-4
Interpolated error correction, 8-7, 10-3
INT REF OUTPUT connector, 5-8
I/O port, 12-27
Isolation, 10-9
Isolation calibration, 10-4

K

K, 7-2
KEY 15, 10-3
KEY 17, 11-11
KEY 19, 8-2
KEY 24, 7-2
KEY 25, 7-2
KEY 26, 7-2
KEY 27, 7-2
KEY 41, 7-2
KEY 42, 7-2
KEY 43, 7-2
KITD, 10-14

KIT DONE, 10-14

(k/m), 7-2

L

LABEL CLASS, 10-14

Label class menu, 10-19

LABEL KIT, 10-14, 10-19

Label kit menu, 10-19

Label standard menu, 10-18

LABK, 10-14

LEFL, 13-5

LEFT LOWER, 13-5

LEFT UPPER, 13-5

LEFU, 13-5

LIF (logical inter change format), 14-4

LIMCLEL, 12-24

LIMD, 12-23

LIMIAMP0, 12-25

LIMILINEOFF, 12-20

LIMILINEON, 12-20

LIMIMAOF, 12-25

LIMIOPOIN, 12-21

LIMIOSEND, 12-21

LIMISTIO, 12-24

LIMITESTOFF, 12-20

LIMITESTON, 12-20

Limit line, 12-16

Limit line function, 12-25

 Check points, 12-28

 Editing display, 13-14

 Insertion loss testing, 12-28

 Lower limit, 12-25

 Segment, 12-25

 Segment order, 12-26

 Upper limit, 12-25

LIMIT LINE OFFSETS, 12-21

LIMIT LINE on OFF, 12-20

LIMIT LINE ON off, 12-26

LIMIT MENU, 12-6, 12-26

Limits menu, 12-20

Limit test, 12-16

Limit test function, 12-25

LIMIT TEST on OFF, 12-20

LIMIT TEST ON off, 12-27

LIMIT TEST TABLE, 13-10

LIML, 12-23

LIMM, 12-23

LIMS, 12-23

LIMSADD, 12-22

LIMSDEL, 12-22

LIMSDON, 12-23

LIMSEDI, 12-22

LIMU, 12-23

Linear frequency sweep mode, 8-7

LINE switch, 5-4

LINE TYPE DATA, 13-6

LINE TYPE MEMORY, 13-6

LIN FREQ, 8-7

LINFREQ, 8-7

LINM, 9-6

LIN MAG, 9-6

LINTDATA, 13-6

LINTMEMO, 13-6

LISDFBASE, 8-8

LISDOBASE, 8-8

LISFREQ, 8-7

LISSLIS1, 8-8

LISSLIS2, 8-8

LIST2, 13-11

LIST DISP: FREQ BASE, 8-8

LIST DONE, 8-10

Listener, 15-2

LIST FREQ [], 8-7

List sweep function

 Editing display, 13-14

List sweep menu, 8-8

LIST SWEEP TABLE, 8-8, 13-10

LIST VALUES, 13-8, 13-14

LISV, 13-8

LMT TST ON [], 12-21

(LOCAL), 12-2, 12-3

LOCAL MAX, 11-16

LOCAL MIN, 11-16

Local mode, 12-2

Logarithmic frequency sweep mode, 8-7

LOG FREQ, 8-7

LOGFREQ, 8-7

LOGM, 9-5

LOG MAG, 9-5

LOG MAG & DELAY, 9-7

Log magnitude and delay format, 9-8

Log magnitude and Phase Format, 9-7

LOG MAG & PHASE, 9-7

LOGMD, 9-7

LOGMP, 9-7

LOWER GRATICULE, 13-7

LOWER LIMIT, 12-15, 12-23

M

M, 7-2
MA, 7-2
man, 5-7, 8-7
MANTRIG, 8-7
Manual Changes, A-1
Manual sweep time, 8-5
MANUAL TRG ON POINT, 8-7
MARK1, 11-4
MARK2, 11-4
MARK3, 11-4
MARK4, 11-4
MARK5, 11-4
MARK6, 11-4
MARK7, 11-4
MARK8, 11-4
MARKCENT, 11-12
MARKCONT, 11-9
MARKCOUP, 11-9
MARKDISC, 11-9
Marker data readout, 5-6
MARKER: DISCRETE, 12-27
Marker function menu, 11-11
Marker list, 11-1
Marker menu, 11-3
Marker mode menu, 11-9
MARKER MODE MENU, 11-4, 12-27
MARKER → AMP. OFS., 12-25
MARKER → CENTER, 11-12
MARKER → DELAY, 9-13
MARKER → MIDDLE, 12-23
MARKER → REFERENCE, 9-12, 11-12
MARKER → SPAN, 11-12
MARKER → START, 11-12
MARKER → STIMULUS, 12-23
MARKER → STIMULUS, 12-27
MARKER → STOP, 11-12
MARKERS: COUPLED, 11-9
MARKERS: DISCRETE, 11-9
Marker Search menu, 11-14
MARKERS ON [DATA], 11-3
Marker statistics, width value, 5-6
Marker time mode, 11-1
MARKFAUV, 11-8
MARKFSTI, 11-8
MARKFVAL, 11-8
MARKLOFF, 11-3
MARKLON, 11-3
MARKMIDD, 12-23

MARKODATA, 11-3
MARKOFF, 11-3
MARKOMEMO, 11-3
MARKPEAD, 11-16
MARKREF, 9-12, 11-12
MARKSPAN, 11-12
MARKSTAR, 8-10, 11-12
MARKSTIM, 12-23
MARKSTOP, 8-11, 11-12
MARKTIMEOFF, 11-9
MARKTIMEON, 11-9
MARKUNCO, 11-9
MARKZERO, 11-3
MAX, 11-14
MEAS, 9-1, 9-2
MEASA, 9-3
MEASTATOFF, 11-12
MEASTATON, 11-12
Measured input, 5-5
MEASURE RESTART, 8-3
Memory trace arrays, 14-2
MENU, 8-2
Message area, 5-7
MIDDLE VALUE, 12-23
MID & DLT, 13-12
MIN, 11-14, 12-10
Minimum sweep time, 8-5
MKR, 11-1
MKR FCTN, 11-11
MKR LIST on off, 11-3
MKR → START, 8-10
MKR → STOP, 8-11
MKR SEARCH, 11-12
MKR TIME on OFF, 11-9
MKR ZERO, 11-3
M/μ, 7-2
MODI1, 10-6
MODIFY, 10-6, 10-13
Modify cal kit menu, 10-13
MONDYEAR, 12-10
MONTH, 12-10

N
N, 7-2
N 50Ω, 10-6
N 75Ω, 10-6
NEXP, 13-13
NEXT PAGE, 13-13
Non-volatile memory, B-1
NUMBER of GROUPS, 8-6

Number of points, 12-28
NUMBER of POINTS, 8-3, 8-11, 13-12
NUMG, 8-6

O

OFF, 9-4
OFFSET DELAY, 10-17
Offset limit menu, 12-24
OFFSET LOSS, 10-18
OFFSET ZO, 10-18
OFSD, 10-17
OFSL, 10-18
OFSZ, 10-18
Omitting isolation calibration, 10-4
OPEP, 13-9
Operating conditions, 1-2
OPERATING PARAMETERS, 13-9, 13-14
Option 001, 1-1, 1-4, 5-9
OPTION 006, C-1
ORDER BASE, 8-8
OUT OF LMT PATTERN, 12-15
OUTPUT PATTERN, 12-15
Output power level, 8-3
OUTPUT TO , 12-13

P

Parallel I/O, C-1
PARSOFF, 11-13
PARSON, 11-13
PART SRCH on OFF, 11-13
Pass/Fail, 5-6
PASS/FAIL output signal, C-3
PASS message, 12-27
P₁, 5-7
PEADX, 11-16
PEADY, 11-16
PEAK DEF: ΔX(Y), 11-16
PEAK-PEAK, 11-16
PHAO, 9-13
PHAS, 9-5
PHASE, 9-5
PHASE OFFSET, 9-13
PLOALL, 13-6
PLODGRAT, 13-6
PLODONLY, 13-6
PLOSFAST, 13-7
PLOSSLOW, 13-7
PLOT, 13-4, 13-13
PLOT, 13-4, 13-13
PLOT: ALL, 13-6, 13-15

PLOT SPEED, 13-7
Plotting, 13-14
POIN, 8-3
Point, 4-2
POINT, 8-11
POLA, 9-8
POLAR, 9-8
Polar marker menu, 11-10
POLAR MKR MENU, 11-9
POLMLIN, 11-10
POLMLOG, 11-10
POLMRI, 11-10
POREOFF, 10-8
POREON, 10-8
Port A, C-1
PORTA, 10-8
Port B, C-1
Port C, C-1
Port D, C-1
Port E, C-2
PORT EXTENSIONS, 10-7
Port F, C-2
Port G, C-2
Port H, C-2
PORTR, 10-8
POWE, 8-3, 8-11
POWER, 8-3
Power Cable, 1-3
power splitter, 4-2
PREP, 13-13
PRESET, 5-4, B-1
Preset state, B-1
PREV FILES, 14-18
PREV PAGE, 13-13
PRINALL, 13-4, 13-13
PRINT, 13-13
PRINT [color], 13-14
Printing, 13-14
PRINT/PLOT SETUPS, 13-13, 13-14
PRINT [STANDARD], 13-4, 13-14
PURG, 14-19
PURGE FILE, 14-19
Purge file menu, 14-20
PURGE: YES, 14-21

R

REAL, 9-8
REAL, 9-8
Real format, 9-8
Rear panel, 5-8
RECALL, 14-11

Recall file menu, 14-22
Recharge time, B-1
Reference level, 5-6
Reference plane menu, 10-8
REFERENCE POSITION, 9-12
REFERENCE VALUE, 9-12
REF OVEN (Option 001) connector, 5-9
REFP, 9-12
REFV, 9-12
Remote mode, 12-2
RESAVD, 14-13
RE-SAVE FILE, 14-13
Re-save file menu, 14-18
RESC, 10-5
RESD, 13-13
Response, 5-2
RESPONSE, 10-9, 10-19
Response and isolation calibration, 10-2,
10-10, 10-19
Response calibration, 10-2, 10-10, 10-19
Response function, 5-4, 9-1
RESPONSE & ISOL'N, 10-9, 10-19
REST, 8-3
RESTORE DISPLAY, 13-13
RESUME CAL SEQUENCE, 10-5
RF OUT connector, 5-4
RIGHT LOWER, 13-5
RIGHT UPPER, 13-5
RIGL, 13-5
RIGU, 13-5
RMT, 5-7

S

S₁₁ 1-port calibration, 10-19
S11B, 10-19
S11C, 10-19
SADD, 8-9
SAVCAOFF, 14-17
SAVCAON, 14-17
SAVDAL, 14-13
SAVDASC, 14-15
SAVDDAT, 14-13
SAVDGRA, 14-15
SAVDSTA, 14-13
SAVE, 12-28, 14-11
SAVE DATA ONLY, 14-13
SAVE FILE, 14-13
SAVE STATE ONLY, 14-13
SAVEUSEK, 10-6
SAVE USER KIT, 10-6, 10-14
SAVTAOFF, 14-17

SAVTAON, 14-17
SAVTMAOFF, 14-17
SAVTMAON, 14-17
SCAFDATA, 9-12
SCAFMEMO, 9-12
SCAL, 9-12
Scale/Div, 5-6
SCALE/DIV, 9-12
SCALE FOR, 9-12
SCALE: FULL, 13-7
SCALE PLOT, 13-6
Scale plot menu, 13-7
SCALE REF, 9-1, 9-11
Scale reference menu, 9-11
SCAPFULL, 13-7
SCAPGL, 13-7
SCAPGU, 13-7
Screen menu, 13-13
SDEL, 8-9
SDON, 8-11
SEAL, 11-15
SEALMAX, 11-16
SEALMIN, 11-16
SEAMAX, 11-14
SEAMEAN, 11-16
SEAMIN, 11-14
SEAOFF, 11-14
SEAPPEAK, 11-16
SEAR, 11-15
SEARCH IN, 11-18
SEARCH LEFT, 11-15
SEARCH: MEAN, 11-16
SEARCH: OFF, 11-14
SEARCH OUT, 11-18
SEARCH RANGE, 11-12
Search Range menu, 11-13
SEARCH RIGHT, 11-15
SEARCH RNG STORE, 11-13
SEARSTOR, 11-13
SEATARG, 11-14, 11-15
SEC, 12-10
SEDI, 8-9
Segment, 12-18
SEGMENT, 8-9, 12-22
SEGMENT DONE, 8-11
SEGMENT:POWER, 8-11
SEGMENT START, 8-11
Select cal kit menu, 10-6
SELECT LETTER, 9-18, 14-14

SELECT QUADRANT, 13-5
Serial number plate, 5-8
SERVICE MENU, 12-6
SET ADDRESSES, 12-4
SETCDATE, 12-10
SET CLOCK, 12-6
SETCTIME, 12-10
Set date menu, 12-10
Set time menu, 12-10
SETZ, 10-7
SET Z0, 10-7
SING, 8-6
SINGLE, 8-6
Smo, 5-7, 9-22
SMOOPER, 9-22
SMOOFF, 9-22
SMOON, 9-22
Smoothing, 4-5, 9-20
Smoothing aperture, 9-22
SMOOTHING APERTURE, 9-22
SMOOTHING on OFF, 9-22
Softkey, 5-4
Softkey label, 5-6
SPACE, 9-18, 14-14
SPAN, 8-1, 8-11
SPAN, 8-1
SPAN, 8-11
SPCL FCTN, 9-1, 9-24
SPECIFY CLASS, 10-14
Specify class menu, 10-18
Specify offset menu, 10-17
SPECIFY S11A, 10-19
SPECRESI, 10-19
SPECRESP, 10-19
SPECS11A, 10-19
SPECS11B, 10-19
SPECS11C, 10-19
SPLDOFF, 9-14
SPLDON, 9-14
Split display, 9-14
SPLIT DISP on OFF, 9-14
SPLIT DISP ON off, 9-14
Standard class assignment, B-8
STANDARD DEFINITION, 13-10
Standard device, 10-6
Standard kit, B-6
STAR, 8-1, 8-11
START, 8-1
STATISTICS, 11-12
Status output, C-2
STD DONE(DEFINED), 10-17

STD NO.n, 10-15, 13-11
STDTARBI, 10-17
STDTDELA, 10-17
STDTLOAD, 10-17
STDTOPEN, 10-16
STDTSHOR, 10-17
STEP SIZE, 8-11, 13-12
Stimulus, 4-2, 5-2, 8-3
Stimulus function, 5-4, 8-1
STIMULUS OFFSET, 12-24
Stimulus start value, 5-6
Stimulus stop value, 5-6
STIMULUS VALUE, 12-23
STODDISK, 14-13, 14-14
STODMEMO, 14-13, 14-14
STOP, 8-11
STOP, 8-1
STOP, 8-11
STOR DEV , 14-13, 14-14
STPSIZ, 8-11
SUB ARY on OFF, 14-17
Svc, 5-7
Sweep, 4-2, 8-7
SWEEP by:, 8-8
Sweep end output signal, C-3
SWEEP TIME, 8-5
SWEEP TIME [], 8-3
SWEEP TIME AUTO, 8-5
Sweep time menu, 8-5
SWEEP TYPE MENU, 8-4
SWET, 8-5
SWETAUTO, 8-5
SYSTEM, 12-6
System controller, 12-3, 15-2, 15-3
SYSTEM CONTROLLER, 12-4, 13-14

T

Tabular format, 13-14
Talker, 15-2
TARGET, 11-14, 11-15
Target menu, 11-15
TERI, 10-17
TERMINAL IMPEDANCE, 10-17
TIME HH:MM:SS, 12-10
TITL, 9-15
Title, 5-7, 9-18, 14-14
TITLE, 9-15, 13-14
Trace arrays, 14-2
TRACE ARY on OFF, 14-17
TRACE on OFF, 9-15

TRACKING on OFF, 11-14
TRACKOFF, 11-14
TRACKON, 11-14
TRADOFF, 9-15
TRADON, 9-15
Trigger menu, 8-6
TRIGGER MENU, 8-3
TRIGGER: TRIG OFF, 8-6

U

U, 7-2
UNCOUPLED, 11-9
UPPER GRATICULE, 13-7
UPPER LIMIT, 12-15, 12-23
User-defined cal kit, 10-11
USER KIT, 10-6

V

VELOCITY FACTOR, 10-7
VELOFACT, 10-7

W

WIDSIN, 11-18
WIDSON, 11-18
Width menu, 11-17
WIDTHS on OFF, 11-18
WIDTH VALUE, 11-17
WIDTOFF, 11-18
WIDTON, 11-18
WIDV, 11-17
Write strobe, C-2

Y

YEAR, 12-10
Y: Trans, 9-4

Z

Z: Trans, 9-4

HP 87510A Gain Phase Analyzer
HP-IB Programming Manual



Printed in Japan December 1991

Notice

The information contained in this document is subject to change without notice.

This document contains proprietary information which is protected by copyright. All rights are reserved. No part of this document may be photocopied, reproduced, or translated to another language without the prior written consent of the Hewlett-Packard Company.

Customer shall have the personal, non-transferable rights to use, copy or modify SAMPLE PROGRAM in this manual for Customer's internal operations. Customer shall use the SAMPLE PROGRAM solely and exclusively for its own purpose and shall not license, lease, market or distribute the SAMPLE PROGRAM or modification or any part thereof.

HP shall not be liable for the quality, performance or behavior of the SAMPLE PROGRAM. HP especially disclaims that the operation of the SAMPLE PROGRAM shall be uninterrupted of error free. This SAMPLE PROGRAM is provided AS IS.

HP DISCLAIMS THE IMPLIED WARRANTIES OF MERCHANTABILITY AND FITNESS FOR A PARTICULAR PURPOSE.

HP shall not be liable for any infringement of any patent, trademark, copyright or other proprietary rights by the SAMPLE PROGRAM or its use. HP does not warrant that the SAMPLE PROGRAM is free from infringements or such rights of third parties. However, HP will not knowingly infringe or deliver a software that infringes the patent, trademark, copyright or other proprietary right of a third party

MS-DOS[®] is a U.S. registered trademark of Microsoft Corporation.

© Copyright 1991, Yokogawa-Hewlett-Packard, LTD.

Manual Printing History

The manual printing date and part number indicate its current edition. The printing date changes when a new edition is printed. (Minor corrections and updates which are incorporated at reprint do not cause the date to change.) The manual part number changes when extensive technical changes are incorporated.

December 1991. . . . 1st. Edition



Contents

1. Guide of HP-IB Programming Manual	
2. Programming Basics	
<i>Preparing for HP-IB Control</i>	2-1
<i>Required Equipment</i>	2-1
<i>Optional Equipment</i>	2-1
<i>Powering Up the System</i>	2-2
<i>Measurement Programming</i>	2-3
<i>Basic Programming Examples</i>	2-5
<i>Setting Up a Measurement</i>	2-5
<i>Performing a THRU Calibration</i>	2-7
<i>Frequency Response Calibration</i>	2-7
<i>Data Transfer from the HP 87510A to a Computer</i>	2-9
<i>Using Markers to Obtain Trace Data at Specific Points</i>	2-9
<i>Trace Transfer</i>	2-11
<i>Data Format</i>	2-11
<i>Data Levels</i>	2-12
<i>Data Transfer Using ASCII Transfer Format (Form 4)</i>	2-14
<i>Data Transfer using IEEE 64-bit Floating Point Format (Form 3)</i>	2-15
<i>Application Example</i>	2-17
<i>Advanced Programming Examples</i>	2-19
<i>Using List Frequency Mode</i>	2-19
<i>Using Limit Lines to Perform Limit Testing</i>	2-22
<i>Storing and Recalling Instrument States</i>	2-25
<i>Coordinating disk storage</i>	2-25
<i>Reading Calibration Data</i>	2-26
<i>Miscellaneous Programming Examples</i>	2-29
<i>Controlling Peripherals</i>	2-29
<i>Transferring disk data files</i>	2-31
<i>Status Reporting</i>	2-33
3. HP-IB Programming Reference	
<i>HP-IB Command Syntax</i>	3-1
<i>Query Commands</i>	3-2
<i>Suffix</i>	3-3
<i>Code Naming Conventions</i>	3-3
<i>HP 87510A Instrument Command Reference</i>	3-4
<i>ADDRCONT value</i>	3-4
<i>ADDRPLOT value</i>	3-4
<i>ADDRPRIN value</i>	3-4
<i>ANAOCHI</i>	3-4
<i>ANAOCH2</i>	3-4
<i>ANAODATA</i>	3-4
<i>ANAOMEMO</i>	3-4
<i>ANARANG value[suffix], value[suffix]</i>	3-4
<i>ANARFULL</i>	3-5

AR	3-5
ASCE string	3-5
AUTO	3-5
AVER {ON OFF}	3-5
AVERFACT value	3-5
AVERREST	3-5
BEEPDONE {ON OFF}	3-5
BEEPFAIL {ON OFF}	3-6
BEEPWARN {ON OFF}	3-6
BINCLEL	3-6
BINEDONE	3-6
BINESB value	3-6
BINL value	3-6
BINO value	3-6
BINOA	3-7
BINO B	3-7
BINP value	3-7
BINS {ON OFF}	3-7
BINSADD	3-7
BINSDEL	3-7
BINSDON	3-7
BINSEDI value	3-7
BINSLINE {ON OFF}	3-8
BINU value[suffix]	3-8
C0 value	3-8
C1 value	3-8
C2 value	3-8
CALCASSI	3-8
CALI parameter	3-9
CALIRAI	3-9
CALIRESP	3-9
CALIS111	3-9
CALK parameter	3-9
CALK7MM	3-9
CALKN50	3-9
CALKN75	3-10
CALKUSED	3-10
CALN	3-10
CALS value	3-10
CENS value1 [suffix], value2 [suffix]	3-10
CENT value [suffix]	3-10
CHAD string	3-10
CHANI	3-11
CHAN2	3-11
CIN	3-11
CLAD	3-11
CLASS11 {A B C}	3-11
CLEL	3-11
CLEM {1-8}	3-11
CLES	3-11
CONT	3-11
CONV parameter	3-12
CONVIDS	3-12
CONVMP {4 8 16}	3-12
CONVOFF	3-12

CONVYTRA	3-12
CONVZTRA	3-12
COPA	3-12
COPT {ON OFF}	3-13
CORR {ON OFF}	3-13
COUC {ON OFF}	3-13
COUT	3-13
CRED string	3-13
CURD?	3-13
DATAMSTER	3-13
DATAMNONE	3-14
DATAMTHRU	3-14
DAYMYEAR	3-14
DCBUS value	3-14
DEFS value	3-14
DELA	3-14
DELO	3-14
DELR {1-8}	3-15
DELRFIXM	3-15
DESTOFF	3-15
DESTON	3-15
DFLT	3-15
DIN	3-15
DISA parameter	3-15
DISAALLB	3-15
DISAALLI	3-16
DISABASS	3-16
DISAHIHB	3-16
DISBLIST	3-16
DISFDOS	3-16
DISFLIF	3-16
DISG {ON OFF}	3-16
DISL {1 2}	3-16
DISLLIST	3-17
DISMCTSP	3-17
DISMMD	3-17
DISMNUM	3-17
DISMSTEP	3-17
DISMSTSP	3-17
DISMUL	3-17
DISP parameter	3-17
DISPDATA	3-18
DISPDATM	3-18
DISPDDM	3-18
DISPDMM	3-18
DISPMEMO	3-18
DIST {ON OFF}	3-18
DONE	3-18
DOUT	3-18
DSKEY	3-18
DUAC {ON OFF}	3-18
EDITBINL	3-19
EDITDONE	3-19
EDITLIML	3-19
EDITLISI	3-19

EDITLIS2	3-19
EDITLIST	3-19
ELED value [s]	3-19
ENKEY	3-19
EQUCPARA?	3-20
EQUCPARS?	3-20
ESB?	3-20
ESNB value	3-20
EXET	3-20
EXPP	3-20
EXTRLOCK?	3-20
EXTT parameter	3-20
EXTTOFF	3-21
EXTTON	3-21
EXTTPOIN	3-21
FBUS value	3-21
FILC string1,string2,string3,string4	3-21
FIRLPNOR	3-21
FIRLPOPE	3-21
FIRR?	3-22
FMT parameter	3-22
FNDAUTO	3-22
FNDMANU	3-22
FNDVALU value	3-22
FNVNARR	3-22
FNVNORM	3-22
FNVOPEN	3-23
FNVWIDE	3-23
FORM2	3-23
FORM3	3-23
FORM4	3-23
FORM5	3-23
FREQ	3-23
FULP	3-23
GRAE string	3-23
GRODAPER value [pct]	3-24
HOLD	3-24
IFBW value [suffix]	3-24
IFBWAUTO	3-24
IFRAUTO	3-24
IFRCH?	3-24
IFRX1	3-24
IFRX1X8	3-25
IFRX64	3-25
IFRX8X1	3-25
IMAG	3-25
INID	3-25
INP8IO	3-25
INP8IO?	3-25
INPT?	3-25
INPUCALC {01-03} value	3-26
INPUCALK value	3-26
INPUD	3-26
INPUDATTP value1,value2[suffix]	3-26
INPUDATM1 value	3-26

<i>INPU</i> ATM2 value	3-26
<i>INPU</i> ATM3 value	3-26
<i>INPU</i> ATM4 value	3-27
<i>INPU</i> FORM value	3-27
<i>INPU</i> LOAA value	3-27
<i>INPU</i> MEM value	3-27
<i>INPU</i> MEMTP	3-27
<i>INPU</i> OEPA value	3-27
<i>INPU</i> SHOA value	3-27
<i>INPU</i> TMEM value	3-27
<i>IOPO</i> ?	3-28
<i>KEY</i> value	3-28
<i>KTTD</i>	3-28
<i>LABERES</i> {I P} string	3-28
<i>LABES11</i> {A B C} string	3-28
<i>LABK</i> string	3-28
<i>LABS</i> string	3-28
<i>LEFL</i>	3-29
<i>LEFU</i>	3-29
<i>LIMCLEL</i>	3-29
<i>LIMD</i> value [suffix]	3-29
<i>LIMEDONE</i>	3-29
<i>LIMI</i> AMPO value [suffix]	3-29
<i>LIMILINE</i> {ON OFF}	3-30
<i>LIMMAOF</i>	3-30
<i>LIMIOPOIN</i>	3-30
<i>LIMIOSEND</i>	3-30
<i>LIMISTIO</i> value [suffix]	3-30
<i>LIMITEST</i> {ON OFF}	3-30
<i>LIML</i> value [suffix]	3-30
<i>LIMM</i> value [suffix]	3-31
<i>LIMS</i> value [suffix]	3-31
<i>LIMSADD</i>	3-31
<i>LIMSDEL</i>	3-31
<i>LIMSDON</i>	3-31
<i>LIMSEDI</i> value	3-31
<i>LIMU</i> value [suffix]	3-32
<i>LINFREQ</i>	3-32
<i>LINM</i>	3-32
<i>LINT</i> {DATA MEMO} value	3-32
<i>LISDFBASE</i>	3-32
<i>LISDOBASE</i>	3-32
<i>LISFREQ</i>	3-32
<i>LISLIS1</i>	3-33
<i>LISLIS2</i>	3-33
<i>LISV</i>	3-33
<i>LMAX?</i> value	3-33
<i>LMIN?</i> value	3-33
<i>LOGFREQ</i>	3-33
<i>LOGM</i>	3-33
<i>LOGMD</i>	3-33
<i>LOGMP</i>	3-34
<i>MANTRIG</i>	3-34
<i>MARD</i> {ON OFF}	3-34
<i>MARK</i> {1-8} value [suffix]	3-34

MARK {STAR STOP}	3-34
MARKBUCK value	3-34
MARKCENT	3-34
MARKCONT	3-34
MARKCOUP	3-35
MARKDISC	3-35
MARKFAUV value [suffix]	3-35
MARKFSTI value [suffix]	3-35
MARKFVAL value [suffix]	3-35
MARKL {ON OFF}	3-35
MARKMIDD	3-36
MARKODATA	3-36
MARKOFF	3-36
MARKOMEMO	3-36
MARKPEAD	3-36
MARKREF	3-36
MARKSPAN	3-36
MARKSTIM	3-36
MARKTIME {ON OFF}	3-37
MARKUNCO	3-37
MARKZERO	3-37
MEAS parameter	3-37
MEASA	3-37
MEASR	3-37
MEASTAT {ON OFF}	3-37
MODII	3-38
MONDYEAR	3-38
NEGL	3-38
NEXP	3-38
NEXPK?	3-38
NUMG value	3-38
NUMLMAX?	3-38
NUMLMIN?	3-38
OFS value [s]	3-39
OFSL value	3-39
OFSZ value [ohm]	3-39
OPEP	3-39
OPTI?	3-39
OSE value	3-39
OSER?	3-39
OSNT	3-39
OSPT	3-40
OSR?	3-40
OUT1ENVH	3-40
OUT1ENVL	3-40
OUT1H	3-40
OUT1L	3-40
OUT2ENVH	3-40
OUT2ENVL	3-40
OUT2H	3-40
OUT2L	3-40
OUT8IO value	3-40
OUTAIO value	3-41
OUTBIO value	3-41
OUTCIO value	3-41

OUTDIO value	3-41
OUTEIO value	3-41
OUTFIO value	3-41
OUTGIO value	3-41
OUTHIO value	3-41
OUTPCALC {01-03}?	3-41
OUTPCALK?	3-42
OUTPCFIL? value1,value2,value3,value4,value5,value6	3-42
OUTPDATAT?	3-42
OUTPDATTP?	3-42
OUTPERRO?	3-42
OUTPFAIP?	3-42
OUTPFBUS?	3-42
OUTPFILT? value[suffix]	3-43
OUTPFORM?	3-43
OUTPFORMP? value	3-43
OUTPIFORM?	3-43
OUTPINP8IO?	3-43
OUTPINPCIO?	3-43
OUTPINPDIO?	3-43
OUTPINPEIO?	3-43
OUTPIRFORM?	3-43
OUTPIRTMEM?	3-43
OUTPITMEM?	3-44
OUTPLIMF?	3-44
OUTPLIML?	3-44
OUTPLIMM?	3-44
OUTPMARK?	3-44
OUTPMAX?	3-44
OUTPMEAN?	3-44
OUTPMEMO?	3-44
OUTPMEMOT?	3-44
OUTPMEMTP? value	3-44
OUTPMIN?	3-45
OUTPMINMAX?	3-45
OUTPMSTA?	3-45
OUTPMWID?	3-45
OUTPMWIL?	3-45
OUTPMWLF?	3-45
OUTPRESF? value1,value2	3-45
OUTPRESO?	3-45
OUTPRESR?	3-46
OUTPRFORM?	3-46
OUTPRTMEM?	3-46
OUTPSTIM?	3-46
OUTPTESS? value	3-46
OUTPTITL?	3-46
OUTPTMEM?	3-46
OUTPTMEMP? value	3-46
OUTPXFIL? value1,value2,value3,value4,value5	3-46
PARS {ON OFF}	3-47
PEADX value [suffix]	3-47
PEADY value [suffix]	3-47
PEAK?	3-47
PHAO value [deg]	3-47

PHAS	3-47
PLOALL	3-48
PLOC parameter	3-48
PLODGRAT	3-48
PLODONLY	3-48
PLOS {FAST SLOW}	3-48
PLOT	3-48
POIN value	3-48
POLA	3-49
POLE? value	3-49
POLM parameter	3-49
POLMLIN	3-49
POLMLOG	3-49
POLMRI	3-49
PORE {ON OFF}	3-49
PORTA value [s]	3-50
PORTR value [s]	3-50
POSL	3-50
POWE value [dBm]	3-50
PREP	3-50
PRES	3-50
PRINALL	3-50
PSOFT {ON OFF}	3-50
PURG string	3-51
QUAD parameter	3-51
RAID	3-51
RAISOL	3-51
RAIRESP	3-51
REAL	3-51
RECCOFF	3-51
RECCON	3-52
RECD string	3-52
REFP value	3-52
REFV value [suffix]	3-52
RESAVD string	3-52
RESC	3-52
RESD	3-53
RESPDONE	3-53
REST	3-53
RFOPNORM	3-53
RFOPEN	3-53
RIGL	3-53
RIGU	3-53
RPLENV?	3-53
RPLHEI?	3-54
RPLLHEI?	3-54
RPLMEA?	3-54
RPLPP?	3-54
RPLRHEI?	3-54
RPLVAL?	3-54
SADD	3-54
SAVI	3-54
SAVC	3-55
SAVCA {ON OFF}	3-55
SAVDALL string	3-55

SAVDASC "string"	3-55
SAVDDAT string	3-55
SAVDGRA "string"	3-55
SAVDSTA string	3-55
SAVEUSEK	3-56
SAVTA {ON OFF}	3-56
SAVTMA {ON OFF}	3-56
SCAC	3-56
SCAFDATA	3-56
SCAFMEMO	3-56
SCAL value [suffix]	3-56
SCAPFULL	3-57
SCAPGL	3-57
SCAPGU	3-57
SCAU	3-57
SDEL	3-57
SDON	3-57
SEAL	3-57
SEALMAX	3-57
SEALMIN	3-58
SEAM parameter	3-58
SEAMAX	3-58
SEAMEAN	3-58
SEAMIN	3-58
SEAOFF	3-58
SEAPPEAK	3-58
SEAR	3-59
SEARSTOR	3-59
SEATARG value [suffix]	3-59
SEDI value	3-59
SELD	3-59
SETGDATE year, month, day	3-59
SETCTIME hour, min, sec	3-60
SETZ value [ohm]	3-60
SING	3-60
SMOO {ON OFF}	3-60
SMOOPER value [pct]	3-60
SOUCOFF	3-60
SOUCON	3-60
SPAN value [suffix]	3-61
SPECRESI value, [value], [value], [value], [value], [value], [value]]]]]]	3-61
SPECRESP value, [value], [value], [value], [value], [value], [value]]]]]]	3-61
SPECSI1A value, [value], [value], [value], [value], [value], [value]]]]]]	3-61
SPECSI1B value, [value], [value], [value], [value], [value], [value]]]]]]	3-61
SPECSI1C value, [value], [value], [value], [value], [value], [value]]]]]]	3-61
SPLD {ON OFF}	3-62
STAN {A-C}	3-62
STAR value [suffix]	3-62
STAS value1 [suffix], value2 [suffix]	3-62
STDD	3-62
STDT parameter	3-62
STDTARBI	3-63
STDTDELA	3-63
STDTLOAD	3-63
STDTOPEN	3-63

<i>STDTSHOR</i>	3-63
<i>STIDROUT</i> parameter value [suffix]	3-63
<i>STIMROUT</i> parameter value [suffix]	3-63
<i>STODDISK</i>	3-64
<i>STODMEMO</i>	3-64
<i>STOP</i> value [suffix]	3-64
<i>STPSIZE</i> value [suffix]	3-64
<i>SWET</i> value [s]	3-64
<i>SWETAUTO</i>	3-64
<i>SWPT</i> parameter	3-64
<i>TARL?</i> value	3-65
<i>TARR?</i> value	3-65
<i>TERI</i> value [ohm]	3-65
<i>TESC</i>	3-65
<i>TEST</i> value	3-65
<i>THRR</i> value	3-65
<i>TITL</i> string	3-66
<i>TRACK</i> {ON OFF}	3-66
<i>VELOFACT</i> value	3-66
<i>WIDSIN</i>	3-66
<i>WIDSOUT</i>	3-66
<i>WIDT</i> {ON OFF}	3-66
<i>WIDV</i> value [suffix]	3-66
* <i>CLS</i>	3-67
* <i>ESE</i> value	3-67
* <i>ESR?</i>	3-67
* <i>IDN?</i>	3-67
* <i>OPC</i>	3-67
* <i>PCB</i> value	3-67
* <i>RST</i>	3-67
* <i>SRE</i> value	3-67
* <i>STB?</i>	3-67
* <i>TRG</i>	3-67
* <i>TST?</i>	3-67
* <i>WAI</i>	3-67

A. HP-IB Commands Summary

<i>Active Channel Block</i>	A-1
<i>Response Function Block</i>	A-1
MEAS Key	A-1
<i>Input Port Menu</i>	A-1
<i>Conversion Menu</i>	A-1
FORMAT Key	A-2
<i>Format Menu</i>	A-2
<i>Format More Menu</i>	A-2
SCALE REF Key	A-2
<i>Scale Reference Menu</i>	A-2
<i>Electrical Delay Menu</i>	A-2
DISPLAY Key	A-2
<i>Display Menu</i>	A-2
<i>Display More Menu</i>	A-3
<i>Display Allocation Menu</i>	A-3
AVG Key	A-3
<i>Average Menu</i>	A-3
<i>IF Bandwidth Menu</i>	A-3

CAL Key	A-3
Correction Menu	A-3
Select Cal Kit Menu	A-3
Calibrate More Menu	A-4
Reference Plane Menu	A-4
Calibration Menu	A-4
Response Cal Menu	A-4
Response and Isolation Cal Menus	A-4
3-Term Cal Menus	A-4
Modify Cal Kit Menu	A-4
Define Standard Menu	A-4
Specify Offset Menu	A-5
Specify Class Menus	A-5
Label Class Menus	A-5
MKR Key	A-5
Marker Menu	A-5
Active Marker Menu	A-6
Clear Marker Menu	A-6
Delta Marker Mode Menu	A-6
Delta Marker Menu	A-6
Fixed Marker Menu	A-6
Marker Mode Menu	A-6
Polar Marker Menu	A-6
MKR FCTN Key	A-6
Marker Function Menu	A-6
Search Range Menu	A-7
Marker Search Menu	A-7
Target Menu	A-7
Marker Search More Menu	A-7
Width Menu	A-7
SPCL FNCT Key	A-7
Special Function Menu	A-7
Waveform Analysis Setting Menu	A-8
Stimulus Function Block	A-8
MENU Key	A-8
Stimulus Menu	A-8
Sweep Time Menu	A-8
Trigger Menu	A-8
Sweep Type Menu	A-9
List Sweep Menu	A-9
Edit List Menu	A-9
Edit Segment Menu	A-9
Edit Segment More Menu	A-9
Clear List Menu	A-9
Instrument State Function Block	A-10
SYSTEM Key	A-10
Real Time Clock Menu	A-10
BIN Sort Menu	A-10
BIN Sort Edit Menu	A-10
BIN Sort Table Edit Menu	A-10
Clear Menu	A-10
Limits Menu	A-10
Edit Limits Menu	A-11
Edit Segment Menu	A-11
Clear List Menu	A-11

Offset Limit Menu	A-11
LOCAL Key	A-11
PRESET Key	A-11
COPY Key	A-12
Copy Menu	A-12
Select Quadrant Menu	A-12
Define Plot Menu	A-12
Scale Plot Menu	A-12
Copy More Menu	A-12
Copy Cal Kit Menu	A-12
Copy Standard Number Menu	A-13
Copy List Sweep Menu	A-13
Copy Limit Test Menu	A-13
Screen Menu	A-13
SAVE and RECALL Keys	A-13
Save Menu	A-13
Title Menu	A-13
ASCII Save Menu	A-14
Define Extension Menu	A-14
Define Save Data Menu	A-14
Disk Menu	A-14
Recall Menu	A-14
Service Function	A-15
IEEE 488.2 Common Commands	A-15
Commands Which Don't Have Equivalent Softkey Labels	A-16

B. Status Reporting

OSPT, OSNT	B-5
OSPT (Operational Status Positive Transition Filter)	B-5
OSNT (Operational Status Negative Transition Filter)	B-5

C. Key Codes

D. Calibration Types and Standard Classes, and Calibration Arrays

E. Waveform Analysis Commands

Setting Commands for Waveform Analysis	E-1
ANARANG and ANARFULL	E-1
ANAOCH1/ANAOCH2	E-2
ANAOATA and ANAOMEMO	E-2
THRR	E-2
Ripple Analysis Command	E-2
RPLPP?	E-3
RPLHEI?	E-4
RPLRHEI? and RPLLHEI?	E-5
RPLENV?	E-6
RPLMEA?	E-7
RPLVAL?	E-8
POLE?	E-8
Maximum/Minimum/Mean Value Search Command	E-9
OUTPMAX?/OUTPMIN?/OUTPMINMAX?	E-9
OUTPMEAN?	E-10
PEAK?	E-10
NEXPK?	E-10
NUMLMAX?	E-10

NUMLMIN?	E-10
LMAX?	E-10
LMIN?	E-10
TARR?	E-10
TARL?	E-10
<i>Filter and Resonator Analysis Command</i>	E-11
OUTPFILT? <i>value[suffix]</i>	E-11
OUTPXFIL?	E-12
OUTPCFIL?	E-13
OUTPRESO?	E-14
OUTPRESR?	E-16
OUTPRESF?	E-17
<i>Equivalent Circuit Analysis Commands</i>	E-17
EQUCPARA?	E-17
EQUCPARS?	E-19
F. HP-IB EXECUTE Commands	
<i>Execute Command and HP-IB Command</i>	F-1
EXECUTE <i>Specific Command</i>	F-2
SING	F-2
<i>EXECUTE Unique Commands</i>	F-2
INPUDATTP	F-2
INPUMEMTP	F-2
OUTPDATTP?	F-2
OUTPMEMTP?	F-2
G. One-Point Correction	
<i>1 Coefficient Command</i>	G-1
HP-IB Command	G-1
INPUDATM1 <i>real,imaginary</i>	G-1
DATAMTHRU	G-1
<i>3-Coefficient Command</i>	G-1
HP-IB Command	G-2
INPUDATM2 <i>real,imaginary</i>	G-2
INPUDATM3 <i>real,imaginary</i>	G-2
INPUDATM4 <i>real,imaginary</i>	G-2
DATAM3TER	G-2
<i>Cancel of 1-Point Correction</i>	G-2
<i>Sample Program</i>	G-2
<i>Difference between 1-Point Correction and Calibration</i>	G-3

Figures

2-1. HP-IB Connections in a Typical Setup	2-2
2-2. Typical Measurement Sequence	2-3
2-3. Sample Program: Setting Up a Measurement	2-6
2-4. Sample Program: Frequency Response Calibration	2-7
2-5. Sample Program: Using Markers to Obtain Trace Data at Specific Points	2-9
2-6. Form 2 Data Transfer Format	2-11
2-7. Form 3 Data Transfer Format	2-11
2-8. Data Processing Flow	2-13
2-9. Sample Program: Data Transfer using ASCII Transfer Format (Form 4)	2-14
2-10. Sample Program: Data Transfer using IEEE 64-bit Floating Point Format (Form 3) (1/2)	2-15
2-11. Sample Program: Application Example (Bandpass Filter Test) (1/2)	2-17
2-12. Sample Program: Using List Frequency Mode (1/2)	2-19
2-13. Sample Program: Setting up Limit Lines (1/2)	2-22
2-14. Sample Program: Storing Instrument States	2-25
2-15. Reading Calibration Data (1/2)	2-27
2-16. Sample Program: Controlling Peripherals	2-30
2-17. Sample Program: Transferring Disk Data Files	2-31
2-18. Sample Program: Generating Interrupts	2-34
B-1. Status Reporting Structure	B-1
B-2. Example of Reading Status Byte (1)	B-2
B-3. Example of Reading Status Byte (2)	B-2
B-4. Example of Generating a Service ReQuest (SRQ)	B-5
C-1. Key Codes	C-1
E-1. RPLPP?	E-3
E-2. Sample Program for RPLPP	E-3
E-3. RPLHEI?	E-4
E-4. Sample Program for RPLHEI	E-4
E-5. RPLRHEI?	E-5
E-6. RPLLHEI?	E-5
E-7. RPLENV?	E-6
E-8. RPLMEA?	E-7
E-9. Sample Program for RPLRHEI, RPLLHEI, RPLENV and RPLMEA	E-7
E-10.	E-8
E-11. POLE?	E-9
E-12. Output Filter Parameters Example	E-11
E-13. Sample Program for OUTPFILT	E-12
E-14. OUTPXFIL?	E-13
E-15. OUTPCFIL?	E-14
E-16. OUTPRESO?	E-15
E-17. Sample Program for OUTPRESO	E-15
E-18. OUTPRESR?	E-16
E-19. OUTPRESF?	E-17
E-20. Four-Device Equivalent Circuit for Crystal Resonator	E-18
E-21. Admittance Characteristic Chart	E-19

Tables

<i>2-1. Units as a Function of Display Format</i>	<i>2-10</i>
<i>2-2. HP-IB Commands to Output Data Array</i>	<i>2-13</i>
<i>3-1. HP-IB Code Naming Conventions</i>	<i>3-3</i>
<i>B-1. Status Bit Definitions of the Status Byte (STB)</i>	<i>B-2</i>
<i>B-2. Status Bit Definitions of the Event Status Register (ESR)</i>	<i>B-3</i>
<i>B-3. Status Bit Definitions of the Event Status Register B (ESB)</i>	<i>B-4</i>
<i>B-4. Status Bit Definitions of the Operational Status Register (OSR)</i>	<i>B-4</i>
<i>D-1. Calibration Types and Standard Classes</i>	<i>D-1</i>
<i>D-2. Calibration Array</i>	<i>D-1</i>

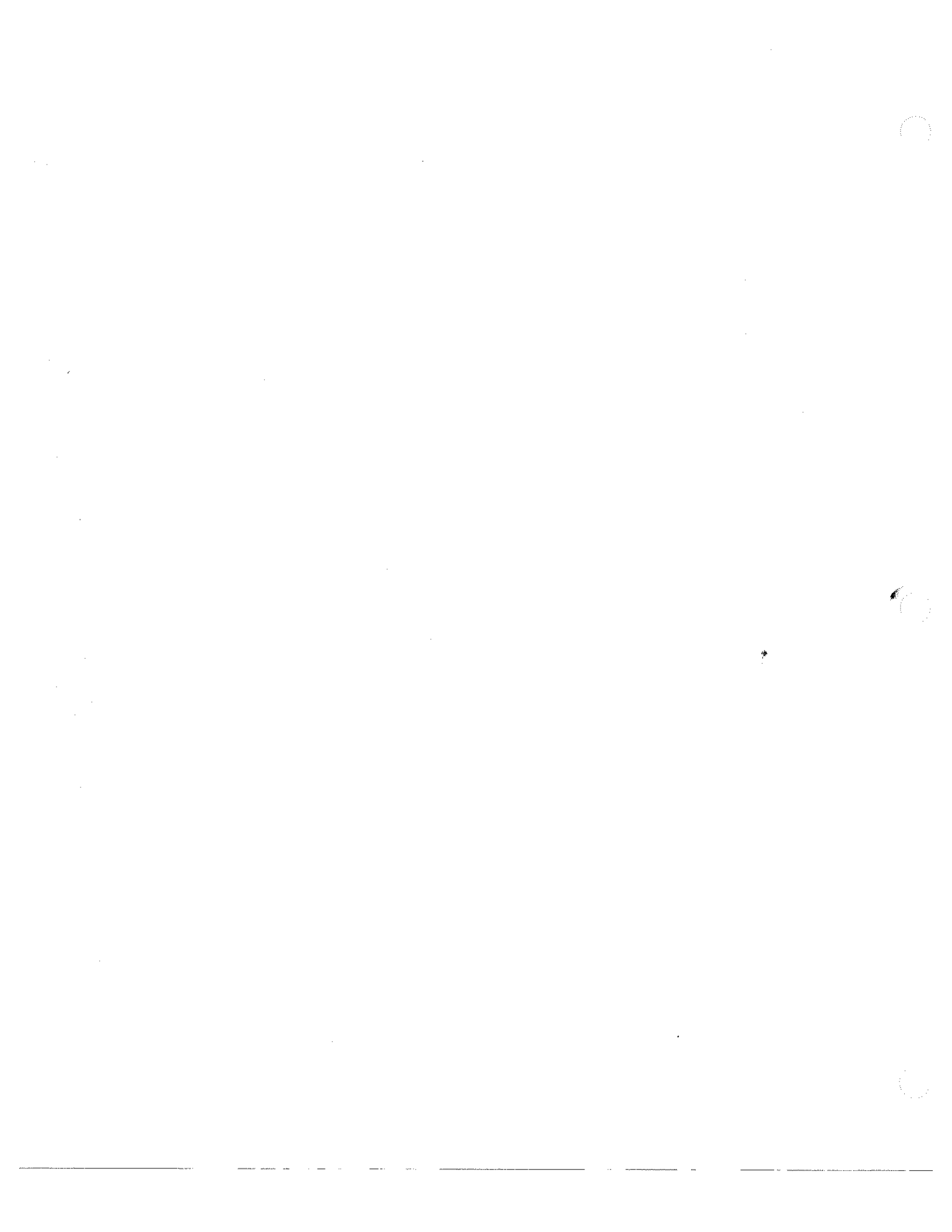

Guide of HP-IB Programming Manual

This manual is a tutorial introduction to remote operation of the HP 87510A Gain Phase Analyzer using an HP 9000 series 200 or 300 computer with BASIC programming examples. The following is a brief description of each chapter and appendix.

Chapter 2 describes programming basics and provides example programs.

Chapter 3 lists HP-IB commands in alphabetic order.

Appendix A summarizes HP-IB commands according to their softkey labels.

Appendix B describes the status byte register and the other registers of the HP 87510A.

Appendix C provides the codes of the front panel keys for using the KEY HP-IB command.

Appendix D describes the calibration types and the standard classes, and the calibration coefficients.

Appendix E provides information about the waveform analysis function.

The reader should become familiar with the operation of the HP 87510A before controlling it by HP-IB. This manual is not intended to teach the BASIC programming language or to discuss HP-IB theory of operation; refer to the following documents which are better suited to these tasks.

- For more information concerning the operation of the HP 87510A, refer to the following:

HP 87510A Reference Manual

- For more information concerning BASIC, refer to the manual set for the BASIC revision being used:

BASIC Programming Techniques

BASIC Language Reference

- For more information concerning HP-IB, refer to the following:

BASIC Interfacing Techniques

Tutorial Description of the Hewlett-Packard Interface Bus

Condensed Description of the Hewlett-Packard Interface Bus



Programming Basics

This chapter describes programming basics and provides example programs.

Preparing for HP-IB Control

To run the examples in this chapter, the following equipment is required:

Required Equipment

1. HP 87510A Gain Phase Analyzer
2. HP 9000 Series 200 or 300 computer or an IBM compatible PC with a measurement co-processor or card (HP 82300 or 82324) with enough memory to hold BASIC, needed binaries (refer to "Powering Up the System"), and at least 64 kilobytes of program space.
A disk drive is required to load BASIC, if no internal disk drive is available.
3. BASIC 3.0 or higher operating system.
4. HP 10833A/B/C/D HP-IB cables to interconnect the computer, the HP 87510A, and any peripherals.

Optional Equipment

1. HP 85032B 50 Ω type-N calibration kit
2. HP 11857D Cable Kit
3. Accessory kit
4. Device under test (DUT)
5. Cables to connect DUT
6. Printer

Powering Up the System

1. Set up the HP 87510A as shown in Figure 2-1.

Connect the HP 87510A to the computer with an HP-IB cable.

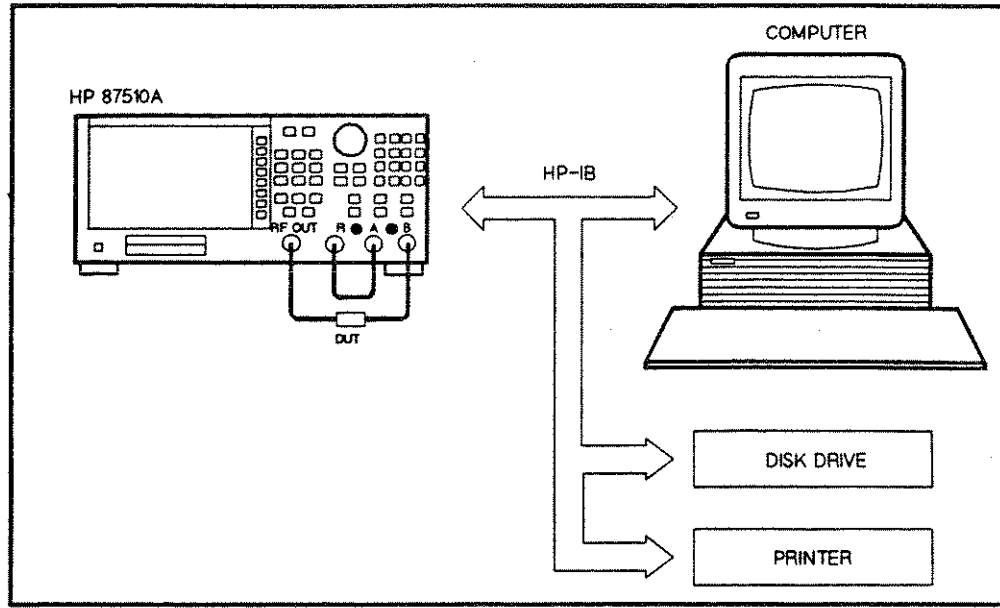

Figure 2-1. HP-IB Connections in a Typical Setup

2. Turn on the computer and load the BASIC operating system.

Load the following BASIC binary extensions:

HPIB, GRAPH, IO, KBD, and ERR.

Depending on the disk drive, a binary such as CS80 may be required.

3. Turn the HP 87510A ON.

To verify the HP 87510A's address, press **LOCAL** and select **SET ADDRESSES**

ADDRESS: 87510. If the address has been changed from the default value (17), return it to 17 while performing the examples in this document by pressing **1 7 x1**.

Make sure the HP 87510A is in the **ADDRESSABLE ONLY** mode, as indicated under the **LOCAL** key. This is the only mode in which the HP 87510A will accept HP-IB commands.

4. On the computer, type the following:

```
OUTPUT 717;"PRES" Return (or EXECUTE)
```

This will preset the HP 87510A. If preset does not occur, there is a problem. First check all HP-IB addresses and connections: most HP-IB problems are caused by an incorrect address and bad or loose HP-IB cables.

Note



Only the HP 9000 Model 226 and 236 computers have an **EXECUTE** key. The Model 216 has an **EXEC** key with the same function. All other computers use the **Return** key for both the execute and enter functions. The notation **Return** is used in this document.

Measurement Programming

This section describes how to organize the commands into a measurement sequence. Figure 2-2 shows a typical measurement sequence.

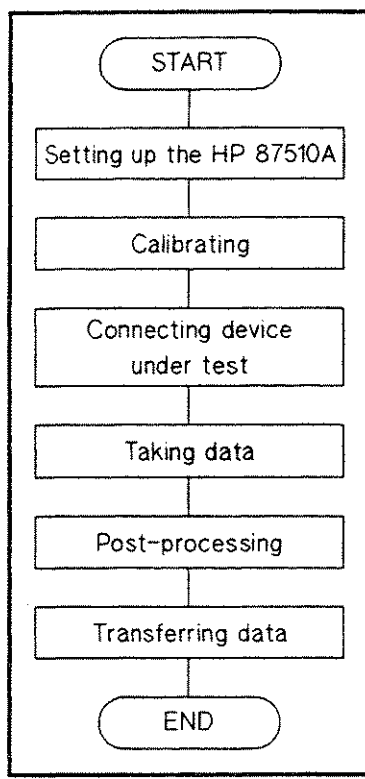

Figure 2-2. Typical Measurement Sequence

■ Setting up the HP 87510A

Define the measurement by setting all of the basic measurement parameters. These include all the stimulus parameters: sweep type, span, sweep time, number of points, and RF power level. They also include the parameter to be measured, and both IF averaging and IF bandwidth. These parameters define the way data is gathered and processed within the instrument, and to change one of these parameters requires that a new sweep be triggered.

There are other parameters that can be set within the HP 87510A that do not affect data gathering directly, such as smoothing, trace scaling or trace math. These functions are classed as post processing functions: they can be changed with the HP 87510A in the hold mode, and the data will correctly reflect the current state.

The save/recall registers provide a rapid way of setting up an entire instrument state.

■ Calibrating

Measurement calibration is normally performed once the HP 87510A state has been defined. Measurement calibration is not required to make a measurement, but it does improve measurement accuracy.

There are several ways to calibrate the HP 87510A as follows:

- The simplest is to stop the program and have the operator perform the calibration from the front panel.

- Alternatively, the computer can be used to guide the operator through the calibration, as discussed in "Frequency Response Calibration".
 - The last option is to transfer calibration data from a previous calibration back into the instrument, as discussed in "Reading Calibration Data".
- **Connecting device under test**

Have the operator connect and adjust the device. The computer can be used to speed the adjustment process by setting up such functions such as limit testing, bandwidth searches, and trace statistics. All adjustments take place at this stage so that there is no danger of taking data from the device while it is being adjusted.
 - **Taking data**

With the device connected and adjusted, measure its frequency response, and store the data in the HP 87510A so that there is a valid trace to analyze. The single sweep command SING is designed to ensure a valid sweep. All stimulus changes are completed before the sweep is started, and the HP-IB hold state is not released until the formatted trace is displayed. When the sweep is complete, the HP 87510A is put into the hold mode, storing the data inside the HP 87510A.

The number of groups command NUMG n is designed to work the same as single sweep, except that it triggers n sweeps. This is useful, for example, in making a measurement with an averaging factor of n. Both single sweep and number of groups restart averaging.
 - **Post-processing**

With valid data to operate on, the post-processing functions can be used. Referring ahead to Figure 2-8, any function that affects the data after the error correction stage can be used. The most useful functions are trace statistics, marker searches, and electrical delay offset.
 - **Transferring data**

Lastly, read the results out of the HP 87510A. All the data output commands are designed to ensure that the data transmitted reflects the current state of the HP 87510A:

 - OUTPFORM, etc., will not transmit data until all formatting functions have been completed.
 - OUTPLIML, OUTPLIMM, and OUTPLIMF will not transmit data until the limit test has occurred, if limit testing is turned ON.
 - OUTPMARK will activate a marker if one is not already selected, and it will make sure that any current marker searches have completed before transmitting data.
 - OUTPMSTA makes sure that statistics have been calculated for the current trace before transmitting data. If statistics is not turned ON, it will turn statistics ON to update the current values, and then turn it OFF.
 - OUTPMWID makes sure that a bandwidth search has been executed for the current trace before transmitting data. If bandwidth search is not turned ON, it will turn the search ON to update the current values, and then turn it OFF.

Data transfer is discussed further in "Data Transfer from the HP 87510A to a Computer".

Basic Programming Examples

Note



Because the sample programs are design to control the HP 87510A from external controller using HP-IB, you will have to change some statements when you use HP 87510A Instrument BASIC to control the internal gain phase function.

Change as follows:

```
"ASSIGN @Hp87510 TO 717" to "ASSIGN @Hp87510 TO 800"  
"ASSIGN @Dt TO 717;FORMAT OFF" to "ASSIGN @Dt TO 800;FORMAT OFF"  
"ABORT 7" to "ABORT 8"
```

Where 717 is an external controller's device selector (HP-IB interface code 7 and HP-IB address 17). 800 is the internal HP-IB device selector when Instrument BASIC controls the internal gain phase function.

Setting Up a Measurement

In general, the procedure for setting up measurements on the HP 87510A via HP-IB follows the same sequence as if the setup was performed manually. There is no required order, as long as the desired frequency range, number of points and power level are set prior to performing the calibration.

By interrogating the HP 87510A to determine the actual values of the start and stop frequencies, or the center frequency and frequency span, the computer can keep track of the actual frequencies.

This example illustrates how a basic measurement can be set up on the HP 87510A. The program will first select the desired parameter, the measurement format, and then the frequency range.

This example sets up a measurement of transmission(A/R) log magnitude on channel 1. When prompted for the center frequency and the frequency span, enter any value in Hz from 1.0×10^3 to 3.0×10^8 . These will be entered into the HP 87510A, and the frequencies will be displayed.

```

10      !
20      ! Setting Up a Measurement
30      !
40      ASSIGN @Hp87510 TO 717 ! If you use iBASIC, replace "717" with "800".
50      ABORT 7                ! If you use iBASIC, replace "7" to "8"
60      CLEAR @Hp87510
70      !
80      OUTPUT @Hp87510;"PRES"           ! Preset HP 87510A
90      OUTPUT @Hp87510;"CHAN1; AR; LOGM"
100     INPUT "Enter center frequency (Hz).",F_cent
110     INPUT "Enter frequency span (Hz).",F_span
120     OUTPUT @Hp87510;"CENT ";F_cent    ! Set Center frequency
130     OUTPUT @Hp87510;"SPAN ";F_span    ! Set frequency span
140     !
150     OUTPUT @Hp87510;"CENT?"
160     ENTER @Hp87510;F_cent
170     OUTPUT @Hp87510;"SPAN?"
180     ENTER @Hp87510;F_span
190     PRINT "Center frequency:",F_cent;"Hz"
200     PRINT "Frequency span:",F_span;"Hz"
210     END

```

Figure 2-3. Sample Program: Setting Up a Measurement

Line 40	Assign the HP 87510A HP-IB address. If you are using the Instrument BASIC to control the internal gain phase function, change 717 to 800
Lines 50 and 60	Prepare for HP-IB control.
Line 80	Preset the HP 87510A.
Line 90	Make channel 1 the active channel, and measure transmission parameter, A/R, display its magnitude in dB.
Lines 100 and 110	Input the center frequency and the frequency span.
Lines 120 and 130	Send the center frequency and the frequency span to the HP 87510A.
Lines 150 through 180	Query the center frequency and the frequency span.
Lines 190 and 200	Show the current center frequency and the frequency span.

Performing a THRU Calibration

This section will demonstrate how to coordinate a THRU measurement calibration by HP-IB control. The HP-IB program follows the key strokes required to calibrate from the front panel: there is a command for every step.

Frequency Response Calibration

The following program does a response calibration using a THRU calibration device. This program simplifies the calibration for the operator by giving explicit directions on the computer's display.

```

10  !
20  ! Frequency Response Calibration
30  !
40  ASSIGN @Hp87510 TO 717 ! If you use iBASIC, change "717" to "800".
50  ABORT 7                ! If you use iBASIC, change "7" to "8".
60  CLEAR 717
70  !
80  OUTPUT @Hp87510;"PRES"
90  OUTPUT @Hp87510;"CHAN1; AR; LOGM"
100 INPUT "Enter center frequency (Hz).",F_cent
110 INPUT "Enter frequency span (Hz).",F_span
120 OUTPUT @Hp87510;"CENT ";F_cent ! Set Center frequency
130 OUTPUT @Hp87510;"SPAN ";F_span ! Set Span frequency
140 !
150 OUTPUT @Hp87510;"HOLD"          ! Sweep mode is HOLD
160 OUTPUT @Hp87510;"CALKN50"      ! Select 50 ohm type-N Cal. kit
170 OUTPUT @Hp87510;"CALIRESP"     ! Select Response cal.
180 INPUT "Connect THRU, then press [Return].",Dum$ *
190 ON INTR 7 GOTO Sweep_end       ! Define branch when interrupt occurs
200 OUTPUT @Hp87510;"CLES"         ! Clear all status register
210 OUTPUT @Hp87510;"*SRE 4;ESNB 1" ! Set enable STB and ESB
220 REPEAT                          ! Wait for register is cleared
230 UNTIL SPOLL(@Hp87510)=0        ! Check STB
240 ENABLE INTR 7;2                ! Enable interrupt
250 OUTPUT @Hp87510;"STANC"        ! Measure THRU
260 Loop_top: GOTO Loop_top        ! Wait until the meas. end
270 Sweep_end: !
280 !
290 OUTPUT @Hp87510;"RESPDONE"     ! Calculating cal coefficient
300 OUTPUT @Hp87510;"*OPC?"       ! \ Wait until calculating ends
310 ENTER @Hp87510;Dum             ! /
320 OUTPUT @Hp87510;"CONT"        !
330 DISP "Response cal completed."
340 END

```

Figure 2-4. Sample Program: Frequency Response Calibration

Line 150	Set the trigger to the HOLD mode.
Line 160	Select the 50 Ω type-N calibration kit.
Line 170	Open the calibration by calling the response calibration.
Line 180	Ask for a THRU, and wait for the operator to connect it.

Line 200 through 240	Clear all status registers.
Line 250	Select and measure the THRU. There is more than one standard in this calibration, so you must identify the specific standard within this calibration. The THRU is the third softkey selection from the top in the menu, so use the STANC command to select THRU as the standard.
Lines 260 through 270	Wait for the standard to be measured. This is indicated by bit 0 (Cal std. complete) of event status register B (ESB).
Lines 290 through 310	Affirm completion of the calibration, and wait for calculation completion.
Line 320	Set the trigger to the CONTINUOUS mode.

Data Transfer from the HP 87510A to a Computer

Trace information can be read out of the HP 87510A in several ways. Data can be read off the trace selectively using the markers, or the entire trace can be read out.

Using Markers to Obtain Trace Data at Specific Points

If only specific information such as a single point off the trace or the result of a marker search is needed, the marker output command can be used to read the information.

Marker data is read out with the command OUTPMARK. This command causes the HP 87510A to transmit three numbers: marker value 1, marker value 2, and marker stimulus value. Refer to Table 2-1 for all the different possibilities for values one and two.

```

10      !
20      ! Using Markers to Obtain Trace Data at Specific Points
30      !
40      ASSIGN @Hp87510 TO 717 ! If you use iBASIC, change "717" to "800".
50      ABORT 7                ! If you use iBASIC, change "7" to "8".
60      CLEAR @Hp87510
70      !
80      OUTPUT @Hp87510;"PRES" ! Preset HP 87510A
90      OUTPUT @Hp87510;"CHAN1; AR; LOGM"
100     INPUT "Enter center frequency (Hz).",F_cent
110     INPUT "Enter frequency span (Hz).",F_span
120     OUTPUT @Hp87510;"CENT ";F_cent
130     OUTPUT @Hp87510;"SPAN ";F_span
140     !
150     ON INTR 7 GOTO Sweep_end      ! Define branch when interrupt occurs
160     OUTPUT @Hp87510;"CLES"        ! Clear status registers *
170     OUTPUT @Hp87510;"*SRE 4;ESNB 1" ! Set enable bits of STB and ESB
180     REPEAT                        ! Wait for registers are cleared
190     UNTIL SPOLL(@Hp87510)=0      ! Check STB
200     ENABLE INTR 7;2              ! Set enable interrupt
210     OUTPUT @Hp87510;"SING"       ! Sweep mode is SINGLE
220     Loop_top:GOTO Loop_top        ! Wait until sweep end
230     Sweep_end:                   !
240     !
250     OUTPUT @Hp87510;"AUTO"        ! Auto scale
260     OUTPUT @Hp87510;"MARK1"      ! Marker 1 ON
270     OUTPUT @Hp87510;"SEAMAX"     ! Search MAX
280     OUTPUT @Hp87510;"OUTPMARK?"  ! Output marker value
290     ENTER @Hp87510;Val1,Val2,Stim
300     DISP "Min val:",Val1;"dB"
310     DISP "Stim:",Stim;"Hz"
320     END

```

Figure 2-5. Sample Program: Using Markers to Obtain Trace Data at Specific Points

- Lines 150 through 230 Collect one sweep of data, and wait for completion.
- Line 250 Bring the trace data in view on the HP 87510A's display.
- Line 260 Activate marker 1.
- Line 270 Have the HP 87510A search for the trace maximum.
- Line 280 Output the marker values at that point.

Table 2-1. Units as a Function of Display Format

Display Format	Marker Mode	OUTPMARK value 1, value 2	OUTPFORM value 1, value 2	Marker Readout ¹ value, aux value
LOG MAG		dB, ²	dB, ²	dB, ²
PHASE		degrees, ²	degrees, ²	degrees, ²
DELAY		seconds, ²	seconds, ²	seconds, ²
POLAR	LIN MKR LOG MKR Re/Im	lin mag, degrees dB, degrees real, imag	real, imag real, imag real, imag	lin mag, degrees dB, degrees real, imag
LIN MAG		lin mag, ²	lin mag, ²	lin mag, ²
REAL		real, ²	real, ²	real, ²

¹ The marker readout values are the marker values displayed in the upper left hand corner of the display. They also correspond to the value and aux value associated with the fixed marker.

² Value not significant in this form, but is included in data transfers.

Trace Transfer

Getting trace data out of the HP 87510A with a 200/300 series computer can be broken down into three steps:

1. Setting up the receive array.
2. Telling the HP 87510A to transmit the data.
3. Accepting the transferred data.

Data inside the HP 87510A is always stored in pairs, to accommodate real/imaginary values, for each data point. Therefore, the receiving array has to be two elements wide, and as deep as the number of points being measured. The memory space for this array must be declared before any data is transferred from the HP 87510A to the computer.

Data Format. The HP 87510A can transmit data over HP-IB in four different formats. The type of format affects what kind of data array is declared (real or integer), since the format determines what type of data is transferred.

■ Form 2

IEEE 32-bit floating point format. In this mode, each number takes 4 bytes. This means that a 201 point transfer takes 1,608 bytes. Figure 2-6 shows the data transfer format of Form 2.

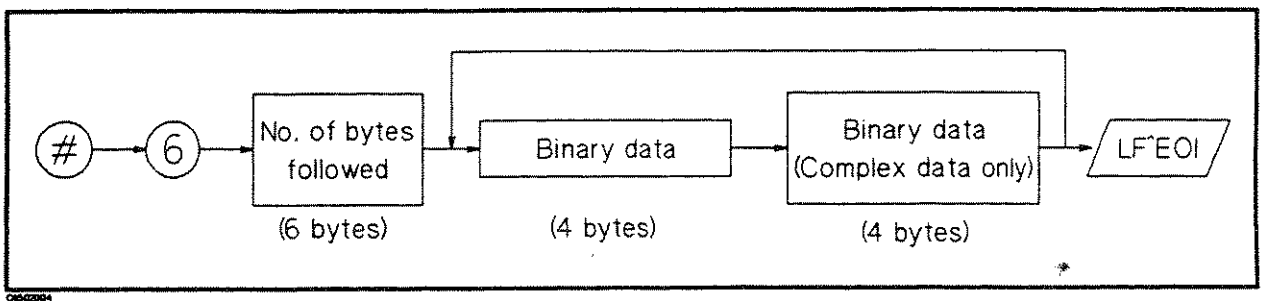

Figure 2-6. Form 2 Data Transfer Format

■ Form 3

IEEE 64-bit floating point format. In this mode, each number takes 8 bytes. This means that a 201-point transfer takes 3,216 bytes. Data is stored internally in the 200/300 series computer with the IEEE 64-bit floating point format, eliminating the need for any reformatting by the computer. Figure 2-7 shows the data transfer format of Form 3.

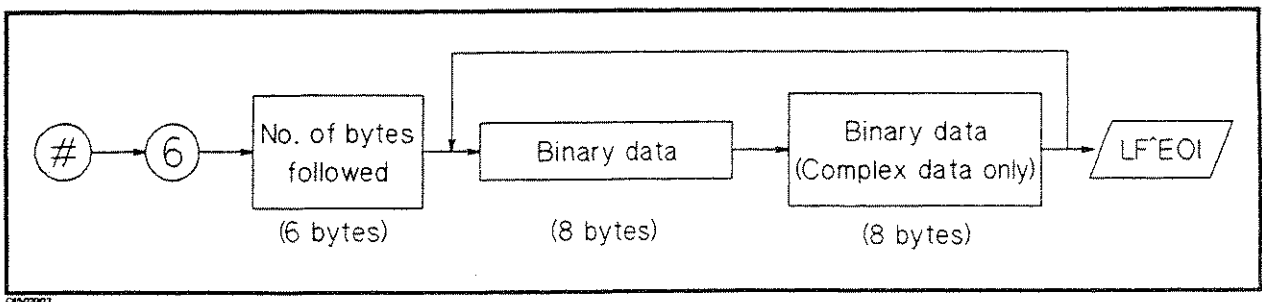

Figure 2-7. Form 3 Data Transfer Format

■ Form 4

ASCII data transfer format. In this mode, each number is sent as a 24 character string, each character being a digit, sign, or decimal point.

- Form 5

MS-DOS[®] personal computer format. This mode is a modification of IEEE 32-bit floating point format with the byte order reversed. Form 5 also has a four byte header which must be read in so that data order is maintained. In this mode, an MS-DOS[®] PC can store data internally without reformatting it.

Data Levels. HP 87510A has following data arrays in internal memory:

- Formatted data

This is the array of data being displayed. It reflects all post-processing functions such as electrical delay, and the units of the array read out depends on the current display format. Refer to Table 2-1 for various units as a function of display format. The formatted data is read out with `OUTPFORM?`, `OUTPRFORM?`, `OUTPFORMP?`, `OUTPTMEM?`, `OUTPRTMEM?`, `OUTPTMEMP?`, `OUTPIFORM?`, `OUTPIRFORM?`, `OUTPITMEM?` or `OUTPIRTMEM?`.

- Calibration coefficients

The results of a calibration are stored arrays of calibration coefficients which are used by the error correction routines. Each array corresponds to a specific error term in the error model. The calibration coefficients are read out with `OUTPCALK{01-03}?`.

Formatted data is generally the most useful, being the same information seen on the display. However, if post-processing is not necessary, as may be the case with smoothing, error corrected data is more desirable. Error corrected data also gives you the opportunity to load the data into the instrument and apply post-processing at a later time.

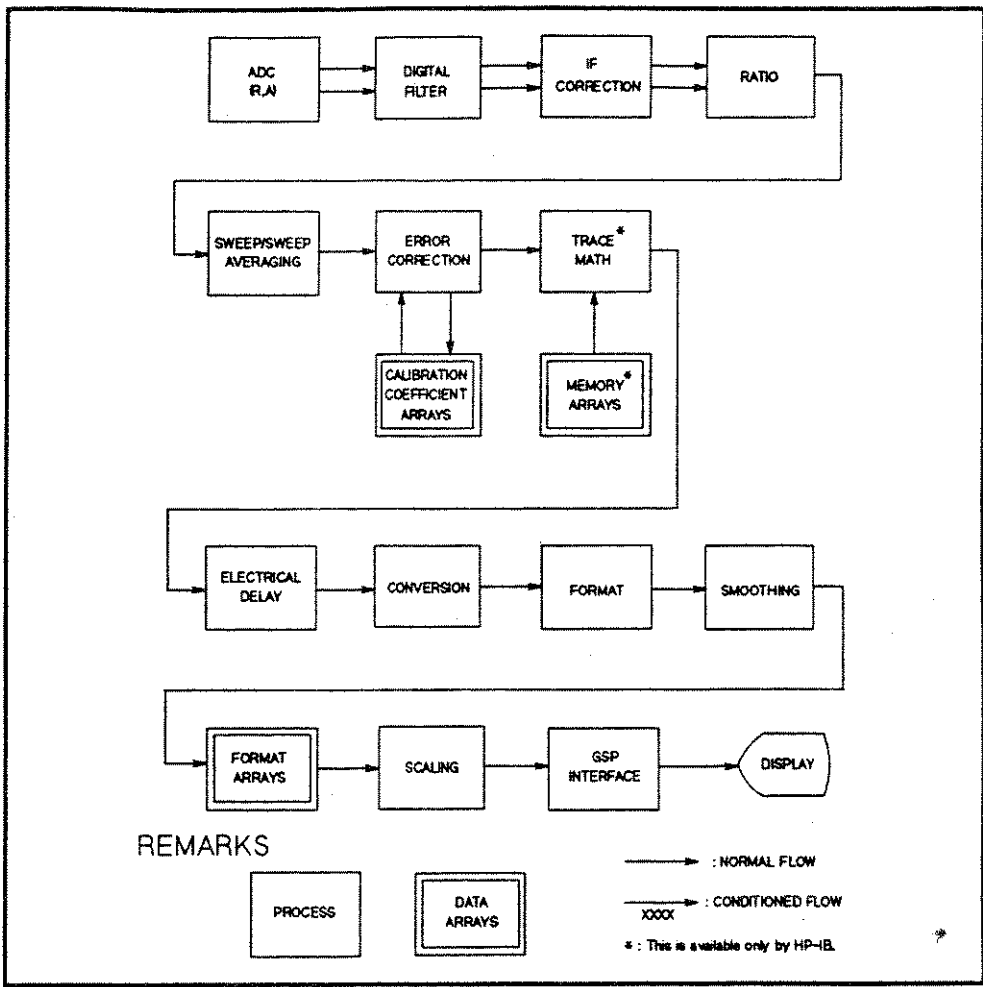

Figure 2-8. Data Processing Flow

Table 2-2. HP-IB Commands to Output Data Array

Data Output	Active Channel		Inactive Channel	
	Formatted Data		Formatted Data	
	Data Trace	Sub Trace	Data Trace	Sub Trace
Complex Data at All Points ¹	OUTPFORM?	OUTPTMEM?	OUTPPIFORM?	OUTPITMEM?
Complex Data at Specified Point ²	OUTPFORMP?	OUTPTMEMP?		
Real Data at All Point ³	OUTPRFORM?	OUTPRTMEM?	OUTPIRFORM?	OUTPIRTMEM?

1 Number of data output is two times of the Number Of Points (NOP).
 2 Number of data output is two (a real part and an imaginary part).
 3 Number of data output is equal to NOP.

Data Transfer Using ASCII Transfer Format (Form 4). When Form 4 is used, each number is sent as a 24 character string, each character being a digit, or decimal point.

```

10  !
20  ! Data Transfer Using ASCII Transfer Format
30  !
40  DIM Dat(1:201),Stim(1:201)
50  ASSIGN @Hp87510 TO 717 ! When iBASIC is used, change "717" to "800".
60  ABORT 7 ! When iBASIC is used, change "7" to "8".
70  CLEAR @Hp87510
80  !
90  OUTPUT @Hp87510;"PRES" ! Preset HP 87510A
100 OUTPUT @Hp87510;"CHAN1; AR; LOGM"
110 INPUT "Enter center frequency (Hz).",F_cent
120 INPUT "Enter frequency span (Hz).",F_span
130 OUTPUT @Hp87510;"CENT ";F_cent
140 OUTPUT @Hp87510;"SPAN ";F_span
150 !
160 ON INTR 7 GOTO Sweep_end ! Define branch when interrupt occurs
170 OUTPUT @Hp87510;"CLES" ! Clear status registers
180 OUTPUT @Hp87510;"*SRE 4;ESNB 1" ! Set enable bits of STB and ESB
190 REPEAT ! Wait for registers are cleared
200 UNTIL SPOLL(@Hp87510)=0 ! Check STB
210 ENABLE INTR 7;2 ! Set enable interrupt
220 OUTPUT @Hp87510;"SING" ! Sweep mode is SINGLE
230 Loop_top:GOTO Loop_top ! Wait until sweep end
240 Sweep_end: !
250 !
260 OUTPUT @Hp87510;"POIN?" ! Query NOP
270 ENTER @Hp87510;Nop
280 OUTPUT @Hp87510;"FORM4" ! Set ASCII Transfer Format
290 !
300 OUTPUT @Hp87510;"OUTPRFORM?" ! Real part of the formatted trace data
310 ENTER @Hp87510;Dat(*)
320 !
330 OUTPUT @Hp87510;"OUTPSTIM?" ! Stimulus data
340 ENTER @Hp87510;Stim(*)
350 !
360 FOR I=1 TO Nop
370 PRINT Stim(I);"Hz",Dat(I);"dB"
380 NEXT I
390 END

```

Figure 2-9. Sample Program: Data Transfer using ASCII Transfer Format (Form 4)

Lines 260 and 270	Find out how many points to expect.
Line 280	Tell the HP 87510A to use the ASCII transfer format.
Line 300	Request the real part of the formatted trace data.
Line 310	Transfer the data from the HP 87510A to the computer, and put it in the receiving array Dat(*).
Lines 330 and 340	Request and transfer the stimulus data.
Lines 340 through 380	Display data.

Data Transfer using IEEE 64-bit Floating Point Format (Form 3). To use Form 3, the computer is told to stop formatting the incoming data with the ENTER statement. This is done by defining an I/O path with formatting OFF. Form 3 also has an eight-byte header to deal with. The first two bytes are the ASCII characters "#6" that indicate that a fixed length block transfer follows, and the next 6 bytes form an integer containing number of bytes in the block to follow. The header must be read in so that data order is maintained.

```

10      !
20      ! Data Transfer Using IEEE 64-bit Floating Point Format
30      !
40      DIM Dat(1:201),Stim(1:201)
50      ASSIGN @Hp87510 TO 717 ! When iBASIC is used,, change "717" to "800".
60      ABORT 7                ! When iBASIC is used, change "7" to "8".
70      CLEAR @Hp87510        ! When iBASIC is used,, change "717" to "800".
80      !
90      OUTPUT @Hp87510;"PRES"          ! Preset HP 87510A
100     OUTPUT @Hp87510;"CHAN1; AR; LOGM"
110     INPUT "Enter center frequency (Hz)",F_cent
120     INPUT "Enter frequency span (Hz)",F_span
130     OUTPUT @Hp87510;"CENT ";F_cent
140     OUTPUT @Hp87510;"SPAN ";F_span
150     !
160     ON INTR 7 GOTO Sweep_end        ! Define branch when interrupt occurs
170     OUTPUT @Hp87510;"CLES"         ! Clear all status register
180     OUTPUT @Hp87510;"*SRE 4;ESNB 1" ! Set enable bits of STB and ESB
190     REPEAT                          ! Wait for registers are cleared
200     UNTIL SPOLL(@Hp87510)=0        ! Check STB
210     ENABLE INTR 7;2                ! Set enable interrupt
220     OUTPUT @Hp87510;"SING"         ! Sweep mode is SINGLE
230     Loop_top:GOTO Loop_top         ! Wait until measurement ends
240     Sweep_end:                    !
250     !
260     OUTPUT @Hp87510;"POIN?"        ! Query NOP
270     ENTER @Hp87510;Nop
280     OUTPUT @Hp87510;"FORM3"        ! IEEE 64-bit Floating Point Format
290     ASSIGN @Dt TO 717;FORMAT OFF   ! Define a data I/O path
300     !                               ! If iBASIC is used, change 717 to 800.
310     OUTPUT @Hp87510;"OUTPRFORM?"   ! Real part of formatted data trace
320     ENTER @Dt USING "#,8A";A$      ! Enter header
330     ENTER @Dt;Dat(*)              ! Enter data
340     ENTER @Dt USING "#,1A";B$     ! Enter terminator
350     !
360     OUTPUT @Hp87510;"OUTPSTIM?"    ! Stimulus data
370     ENTER @Dt USING "#,8A";A$      ! Enter header
380     ENTER @Dt;Stim(*)              ! Enter data
390     ENTER @Dt USING "#,1A";B$     ! Enter terminator
400     !

```

Figure 2-10.

Sample Program: Data Transfer using IEEE 64-bit Floating Point Format (Form 3) (1/2)

```

410  ASSIGN @Dt TO *           ! Clear I/O path
420  FOR I=1 TO Nop
430    PRINT Stim(I);"Hz",Dat(I);"dB"
440  NEXT I
450  END

```

Figure 2-10. Sample Program: Data Transfer using IEEE 64-bit Floating Point Format (Form 3) (2/2)

Line 280	Tell the HP 87510A to output data using Format 3.
Line 290	Define a data I/O path with ASCII formatting OFF. The I/O path points to the HP 87510A, and can be used to read or write data to the HP 87510A, as long as that data is in binary rather than ASCII format.
Line 320	Enter the header.
Line 330	Enter the data.
Line 340	Enter the terminator.
Line 420 through 440	Display data.

Application Example

The following example measures the transmission parameter of a bandpass filter and obtains the typical parameters: -3 dB bandwidth, Center frequency, and Insertion loss.

```
10      !
20      ! Bandpass Filter Test
30      !
40      ASSIGN @Hp87510 TO 800 ! When iBASIC is used, change "717" to "800".
50      ABORT 7                ! When iBASIC is used, change "7" to "8".
60      CLEAR @Hp87510
70      !
80      OUTPUT @Hp87510;"PRES" ! Preset HP 87510A
90      OUTPUT @Hp87510;"CHAN1; AR; LOGM" ! Set up measurement parameters
100     INPUT "Enter center frequency (Hz).",F_cent
110     INPUT "Enter frequency span (Hz).",F_span
120     OUTPUT @Hp87510;"CENT ";F_cent
130     OUTPUT @Hp87510;"SPAN ";F_span
140     !
150     OUTPUT @Hp87510;"HOLD"      ! Perform cal measurement
160     OUTPUT @Hp87510;"CALKN50"
170     OUTPUT @Hp87510;"CALIRESP"
180     INPUT "Connect THRU, then press [Return].",Dum$
190     !
200     Command$="STANC"
210     GOSUB Pre_end
220     OUTPUT @Hp87510;"RESPDONE"
230     INPUT "Cal completed. Connect DUT, then press [Return].",Dum$
240     !
250     Command$="SING"             ! Trigger a sweep
260     GOSUB Pre_end             ! Wait until sweep ends
270     !
280     OUTPUT @Hp87510;"MARK1"    ! Marker 1 ON
290     OUTPUT @Hp87510;"SEAMAX"   ! Search MAX.
300     OUTPUT @Hp87510;"OUTPMARK?" ! Query marker value
310     ENTER @Hp87510;Loss
320     !
330     OUTPUT @Hp87510;"DELR1"    ! Select MKR1 as delta ref. marker
340     OUTPUT @Hp87510;"WIDV -3"  ! Width value is -3
350     OUTPUT @Hp87510;"WIDTON"   ! Width ON
360     OUTPUT @Hp87510;"OUTPMWID?" ! Query width parameters
370     ENTER @Hp87510;Bw,Cent,Q
380     !
```

Figure 2-11. Sample Program: Application Example (Bandpass Filter Test) (1/2)

```

390 PRINT "-3dB bandwidth= ",Bw;"Hz"
400 PRINT "Center frequency= ",Cent;"Hz"
410 PRINT "Insertion loss= ",Loss;"dB"
420 STOP
430 !
440 Pre_end: !
450 IN INTR 7 GOTO Sweep_end
460 OUTPUT @Hp87510;"CLES"
470 OUTPUT @Hp87510;"*SRE 4;ESNB 1"
480 REPEAT
490 UNTIL SPOLL(@Hp87510)=0
500 ENABLE INTR 7;2
510 OUTPUT @Hp87510;Command$
520 Loop_top:GOTO Loop_top
530 Sweep_end:
540 RETURN
550 END

```

Figure 2-11. Sample Program: Application Example (Bandpass Filter Test) (2/2)

Lines 80 through 130	Set up measurement.
Lines 150 through 230	Do a response calibration.
Lines 250 through 260	Collect one sweep of data.
Lines 280 through 310	Get the insertion loss value using the marker search function.
Lines 330 through 370	Take the -3 dB bandwidth value and the center frequency value using the bandwidth search function.

Advanced Programming Examples

Using List Frequency Mode

The list frequency mode lets you select the specific points or frequency spacing between points at which measurements are to be made. Sampling specific points reduces the measurement time since additional time is not spent measuring device characteristics at unnecessary frequencies.

This example shows how to create a list frequency table and send it to the HP 87510A. The command sequence for entering a list frequency table imitates the key sequence followed when entering a table from the front panel: there is a command for every key press. Editing a segment is also the same as the key sequence, but the HP 87510A automatically reorders each edited segment in order of increasing start frequency.

This example takes advantage of the computer's capabilities to simplify creating and editing the table. The table is entered and completely edited before being transmitted to the HP 87510A. To simplify the programming task, options such as entering step size are not included.

```
10      !
20      ! Using List Frequency Mode
30      !
40      DIM Table(1:31,1:3)
50      ASSIGN @Hp87510 TO 717 ! When iBASIC is used, change "717" to "800".
60      ABORT 7                ! When iBASIC is used, change "7" to "8".
70      CLEAR @Hp87510
80      !
90      INPUT "Number of segments?",Numb
100     !
110     PRINTER IS CRT
120     CLEAR SCREEN
130     PRINT USING "10A,10A,10A,20A";"Segment","Start(Hz)","Stop(Hz)"
        ,"Number of points"
140     !
150     FOR I=1 TO Numb
160         GOSUB Loadpoin
170     NEXT I
180     !
190     LOOP
200     INPUT "Do you want to edit? (Y/N)",An$
210     EXIT IF An$="N" OR An$="n"
220     INPUT "Segment Number?",I
230     GOSUB Loadpoin
240     END LOOP
250     !
```

Figure 2-12. Sample Program: Using List Frequency Mode (1/2)

```

260 OUTPUT @Hp87510;"PRES"           ! Preset HP 87510A
270 OUTPUT @Hp87510;"CHAN1; AR; LOGM"
280 !
290 OUTPUT @Hp87510;"EDITLIST"       ! Freq. List Edit mode
300 OUTPUT @Hp87510;"CLEL"           ! Clear list
310 FOR I=1 TO Numb
320   OUTPUT @Hp87510;"SADD"          ! Add new segment
330   OUTPUT @Hp87510;"STAR ";Table(I,1) ! Start freq. of segment
340   OUTPUT @Hp87510;"STOP ";Table(I,2) ! Stop freq. of segment
350   OUTPUT @Hp87510;"POIN ";Table(I,3) ! Number of points
360   OUTPUT @Hp87510;"SDON"          ! Complete editing segment
370 NEXT I
380 OUTPUT @Hp87510;"EDITDONE"        ! Complete editing list
390 OUTPUT @Hp87510;"LISFREQ"         ! List freq. mode ON
400 OUTPUT @Hp87510;"LISDOBASE"       ! List Display Order Base
410 !
420 ON INTR 7 GOTO Sweep_end          ! Define branch when interrupt occurs
430 OUTPUT @Hp87510;"CLES"           ! Clear all status registers
440 OUTPUT @Hp87510;"*SRE 4;ESNB 1" ! Set enable bits of STB and ESB
450 REPEAT                             ! Wait for registers are cleared
460 UNTIL SPOLL(@Hp87510)=0          ! Check STB
470 ENABLE INTR 7;2
480 OUTPUT @Hp87510;"SING"           ! Trigger a sweep
490 Loop_top:GOTO Loop_top
500 Sweep_end:                          !
510 !
520 OUTPUT @Hp87510;"AUTO"           ! Auto scale
530 STOP
540 !
550 Loadpoin: !
560 INPUT "Enter start frequency (Hz)",Table(I,1)
570 INPUT "Enter stop frequency (Hz)",Table(I,2)
580 INPUT "Enter number of points",Table(I,3)
590 IF Table(I,3)=1 THEN Table(I,2)=Table(I,1)
600 PRINT TABXY(0,I+1);I;TAB(10);Table(I,1);TAB(20);Table(I,2);TAB(35)
    ;Table(I,3)
610 RETURN
620 END

```

Figure 2-12. Sample Program: Using List Frequency Mode (2/2)

Line 90	Find out how many segments to expect.
Lines 120 through 140	Clear the screen and print the table header.
Lines 160 through 180	Read in each segment.
Lines 200 through 250	Edit the table until editing is no longer needed.
Line 300	Activate the frequency list edit mode, and open the list frequency table for editing.
Line 310	Delete any existing segments.
Lines 320 through 380	Enter the segment values.
Line 390	Close the table.
Line 400	Turn on the list frequency mode.
Line 410	Display the trace for only the listed frequency ranges.
Lines 550 through 600	This is a segment input routine.

Line 590

Set the stop frequency equal to the start frequency to avoid ambiguity, if only one point is in the segment.

Using Limit Lines to Perform Limit Testing

This example shows how to create a limit table and send it to the HP 87510A. The command sequence for entering a limit table imitates the key sequence followed when entering a table from the front panel: there is a command for every key press. Editing a limit is also the same as the key sequence, but remember that the HP 87510A automatically reorders the table in order of increasing start frequency.

This example takes advantage of the computer's capabilities to simplify creating and editing the table. The table is entered and completely edited before being transmitted to the HP 87510A. To simplify the programming task, options such as entering offsets are not included.

```
10      !
20      ! Setting Up Limit Lines
30      !
40      DIM Table(1:31,1:3)
50      ASSIGN @Hp87510 TO 717 ! When iBASIC is used, change "717" to "800".
60      ABORT 7                ! When iBASIC is used, change "7" to "8".
70      CLEAR @Hp87510
80      !
90      OUTPUT @Hp87510;"PRES"  ! Preset HP 87510A
100     OUTPUT @Hp87510;"CHAN1; AR; LOGM"
110     OUTPUT @Hp87510;"SING"  ! Sweep mode is SINGLE
120     INPUT "Enter start frequency (Hz)",F_start
130     INPUT "Enter stop frequency (Hz)",F_stop
140     OUTPUT @Hp87510;"STAR ";F_start
150     OUTPUT @Hp87510;"STOP ";F_stop
160     !
170     INPUT "Number of limits?",Numb
180     !
190     PRINTER IS 1
200     CLEAR SCREEN
210     PRINT USING "10A,15A,15A,15A";"Segment","Stimulus(Hz)","Upper(dB)"
        ,"Lower(dB)"
220     !
230     FOR I=1 TO Numb
240         GOSUB Loadlimit
250     NEXT I
260     !
270     LOOP
280         INPUT "Do you want to edit? (Y/N)",An$
290     EXIT IF An$="N" OR An$="n"
300         INPUT "Segment Number?",I
310         GOSUB Loadlimit
320     END LOOP
330     !
```

Figure 2-13. Sample Program: Setting up Limit Lines (1/2)

```

340  OUTPUT @Hp87510;"EDITLIML"      ! Edit limit line table
350  OUTPUT @Hp87510;"LIMCLEL"      ! Delete limit table
360  FOR I=1 TO Numb
370      OUTPUT @Hp87510;"LIMSADD"      ! Add segment
380      OUTPUT @Hp87510;"LIMS ";Table(I,1) ! Stimulus break point
390      OUTPUT @Hp87510;"LIMU ";Table(I,2) ! Upper limit value
400      OUTPUT @Hp87510;"LIML ";Table(I,3) ! Lower limit value
410      OUTPUT @Hp87510;"LIMSDON"      ! Complete editing segment
420  NEXT I
430  !
440  OUTPUT @Hp87510;"LIMEDONE"      ! Complete editing limit table
450  OUTPUT @Hp87510;"LIMILINEON"    ! Display limit line
460  OUTPUT @Hp87510;"LIMITESTON"    ! Limit test ON
470  ON INTR 7 GOTO Sweep_end        ! Define branch when interrupt occurs
480  OUTPUT @Hp87510;"CLES"          ! Clear all status register
490  OUTPUT @Hp87510;"*SRE 4;ESNB 1" ! Set enable bits of STB and ESB
500  REPEAT                          ! Wait for registers are cleared
510  UNTIL SPOLL(@Hp87510)=0        ! Check STB
520  ENABLE INTR 7;2                ! Set enable interrupt
530  OUTPUT @Hp87510;"SING"          ! Trigger a sweep
540  Loop_top: GOTO Loop_top
550  Sweep_end:                      !
560  !
570  OUTPUT @Hp87510;"OUTPFAIP?"     ! Ask number of failed points
580  ENTER @Hp87510;Result          ! Enter number of failed points
590  IF Result=0 THEN
600      PRINT "PASS"
610  ELSE
620      PRINT "FAIL"
630  END IF
640  STOP
650  !
660  Loadlimit:                      !
670  INPUT "Enter stimulus value (Hz)",Table(I,1)
680  INPUT "Enter upper limit value (dB)",Table(I,2)
690  INPUT "Enter lower limit value (dB)",Table(I,3)
700  PRINT TABXY(0,I+1);I;TAB(11);Table(I,1);TAB(27);Table(I,2);TAB(42)
      ;Table(I,3)
710  RETURN
720  END

```

Figure 2-13. Sample Program: Setting up Limit Lines (2/2)

Line 40	Create a table to hold the limit values. It will contain the stimulus value (frequency), the upper limit value, and the lower limit value.
Line 170	Ask for number of limits to expect.
Lines 190 through 210	Clear the screen and print the table header.
Lines 230 through 250	Read in each segment.
Lines 270 through 320	Edit the table until editing is no longer needed.
Line 340	Begin editing the limit line table.
Line 350	Delete any existing limits.
Lines 360 through 420	Enter the segment values.
Line 440	Close the table.

Line 450	Display the limits.
Line 460	Activate the limit testing.
Lines 570 through 640	Detect result of the test and display PASS or FAIL.

Storing and Recalling Instrument States

This example demonstrates ways of storing and recalling entire instrument states using HP-IB.

Coordinating disk storage

This example shows how to save and recall the instrument STATES from the disk installed in the built-in disk drive.

```
10  !
20  ! Storing Instrument States
30  !
40  DIM Err$(50)
50  ASSIGN @Hp87510 TO 717 ! When iBASIC is used, replace "717" with "800".
60  ABORT 7 ! When iBASIC is used, replace "7" to "8".
70  CLEAR @Hp87510
80  OUTPUT @Hp87510;"*CLS"
90  OUTPUT @Hp87510;"PRES" ! Preset HP 87510A
100 OUTPUT @Hp87510;"CHAN1; AR; LOGM"
110 INPUT "Enter center frequency (Hz).",F_cent
120 INPUT "Enter frequency span (Hz).",F_span
130 OUTPUT @Hp87510;"CENT ";F_cent
140 OUTPUT @Hp87510;"SPAN ";F_span
150 !
160 INPUT "File name? (up to 8 char.)",Name$
170 OUTPUT @Hp87510;"STODDISK" ! Storage device is DISK
180 OUTPUT @Hp87510;"SAVDSTA """;Name$,""""" ! Save Instrument states
190 OUTPUT @Hp87510;"*OPC?"
200 ENTER @Hp87510;Dum
210 OUTPUT @Hp87510;"OUTPERRO?"
220 ENTER @Hp87510;Err,Err$
230 IF Err THEN
240     PRINT "Error occurred."
250     PRINT Err$
260     STOP
270 ELSE
280     INPUT "Save done. Press [Return] to recall.",Dum$
290 END IF
300 !
310 OUTPUT @Hp87510;"PRES"
320 OUTPUT @Hp87510;"RECD """;Name$,"_S"""" ! Recall instrument state
330     ! If DOS format disk is used, replace "_S" with ".STA".
340 OUTPUT @Hp87510;"*OPC?"
350 ENTER @Hp87510;Dum
360 DISP "Done."
370 END
```

Figure 2-14. Sample Program: Storing Instrument States

Line 160	Get the name of the file to be created.
Line 170	Select an internal flexible disk drive for storage device.
Line 180	Save the instrument states and the calibration coefficients with the file name. The file name must be preceded and followed by double

	quotation marks, and the only way to do that with an OUTPUT statement is to use two sets of quotation marks: "".
Lines 190 and 200	Wait for completion of the save operation.
Lines 210 and 220	Check whether or not an error occurred.
Lines 230 through 290	If an error is detected, print the error number and the error message. If an error is not detected, prompt the user to continue the program.
Line 320	Add the extension to the file name and recall the file.

Reading Calibration Data

This example demonstrates how to read measurement calibration data out of the HP 87510A, and how to return the data to the HP 87510A.

The data used to perform measurement error correction is stored inside the HP 87510A in up to three calibration coefficient arrays. Each array stores a specific error coefficient, and is stored and transmitted as an error corrected data array: each point is a real/imaginary pair, and the number of points in the array is the same as the number of points in the sweep. The four data formats also apply to the transfer of calibration coefficient arrays. Appendix D specifies where the calibration coefficients are stored for different calibration types.

A computer can read out the error coefficients using the OUTPCALC{01-03} commands. Each calibration type uses only as many arrays as needed, starting with array 1. Therefore, it is necessary to know the type of calibration about to be read out: attempting to read an array not being used in the current calibration causes the "REQUESTED DATA NOT CURRENTLY AVAILABLE" warning to be displayed.

A computer can also store calibration coefficients in the HP 87510A. To do this, declare the type of calibration data about to be stored in the HP 87510A just as if you were about to perform that calibration. Then, instead of calling up different classes, transfer the calibration coefficients using the INPUCALC{01-03} commands. When all the coefficients are in the HP 87510A, activate the calibration by issuing the command SAVC, to have the HP 87510A take a sweep measurement.

This example reads the response calibration coefficients into a very large array, from which they can be examined, modified, stored, or returned to the HP 87510A.

```

10  !
20  ! Reading Calibration Data
30  !
40  DIM Dat(1:201,1:2)
50  DIM Head$(6)
60  ASSIGN @Hp87510 TO 717 ! When iBASIC is used, replace "717" to "800".
70  ABORT 7 ! When iBASIC is used, replace "7" to "8".
80  CLEAR @Hp87510
90  !
100 INPUT "Connect THRU and press [Return] to do cal.",Dum$
110 GOSUB Setup
120 GOSUB Cal
130 OUTPUT @Hp87510;"SAVC" ! Re-draw trace
140 OUTPUT @Hp87510;"POIN?" ! Ask Number of points
150 ENTER @Hp87510;Nop ! Enter NOP
170 !
180 INPUT "Press [Return] to transmit cal data.",Dum$
190 ASSIGN @Dt TO 717;FORMAT OFF ! Set data I/O path
200 OUTPUT @Hp87510;"FORM3" ! IEEE 64-bit Floating Point Format
210 OUTPUT @Hp87510;"OUTPCALC01?" ! Query calibration array
220 ENTER @Dt USING "#,8A";A$ ! Enter header
230 ENTER @Dt;Dat(*) ! Enter data
240 ENTER @Dt USING "#,1A";B$ ! Enter terminator
250 INPUT "Transmit done. Disconnect THRU and press [Return].",Dum$
260 !
270 GOSUB Setup
280 GOSUB Cal
290 OUTPUT @Hp87510;"SAVC" ! Re-draw trace
300 !
310 INPUT "Press [Return] to retransmit cal data.",Dum$
320 V$=VAL$(Nop*2*8)
330 Numv=LEN(V$)
340 Head$="000000" ! Initialize header value
350 FOR I=1 TO Numv
360 Head$[7-I,7-I]=V$[Numv-I+1,Numv-I+1]
370 NEXT I
380 !
390 OUTPUT @Hp87510;"INPUCALC01 "; ! Store cal data by HP-IB
400 OUTPUT @Dt USING "#,8A";"#6"&Head$ ! Send header
410 OUTPUT @Dt;Dat(*),END ! Send data
420 OUTPUT @Hp87510;"SAVC" ! Re-draw trace
430 !
440 ASSIGN @Dt TO * ! Clear I/O path
460 DISP "Retransmit completed. Connect DUT."
470 OUTPUT @Hp87510;"CONT" ! Sweep mode is CONT
480 STOP
490 !

```

Figure 2-15. Reading Calibration Data (1/2)

```

500 Setup: !
510 F_cent=7.E+7
520 F_span=200000.
530 OUTPUT @Hp87510;"PRES;"
540 OUTPUT @Hp87510;"CHAN1; AR; LOGM"
550 OUTPUT @Hp87510;"CENT ";F_cent
560 OUTPUT @Hp87510;"SPAN ";F_span
570 OUTPUT @Hp87510;"SING"
580 RETURN
590 !
600 Cal: !
610 OUTPUT @Hp87510;"swet 4"
620 OUTPUT @Hp87510;"CALIRESP"
630 ON INTR 7 GOTO Sweep_end
640 OUTPUT @Hp87510;"CLES"
650 OUTPUT @Hp87510;"*SRE 4;ESNB 1"
660 REPEAT
670 UNTIL SPOLL(@Hp87510)=0
680 ENABLE INTR 7;2
690 OUTPUT @Hp87510;"STANC"
700 Loop_top:GOTO Loop_top
710 Sweep_end: !
720 !
730 OUTPUT @Hp87510;"*0PC?"
740 ENTER @Hp87510;Dum
750 OUTPUT @Hp87510;"RESPDONE"
760 RETURN
770 END

```

Figure 2-15. Reading Calibration Data (2/2)

Line 50	Declare the dimension part of the file header.
Line 110	Preset and set up the HP 87510A, and hold the trigger.
Line 120	Perform a response calibration.
Line 130	Re-draw the trace with the calibration data.
Line 210	Request outputting the calibration data.
Line 220	Enter the file header.
Line 230	Enter the calibration data.
Line 240	Enter the file terminator.
Line 280	Perform the calibration to set the correction ON.
Line 320	Calculate the number of bytes transferred, and represents it in the string format.
Line 330	Count the number of characters in the string which contains the number of bytes transferred.
Line 340	Enter 0 as the initial value in all header arrays.
Line 350 through 370	Place the number of bytes transferred to the header array digit by digit from the sixth array to the first array of the header.
Line 390 through 410	Send the file header and calibration data.

Miscellaneous Programming Examples

Controlling Peripherals

The purpose of this section is to demonstrate how to coordinate printers or plotters with the HP 87510A.

The HP 87510A has two operating modes with respect to HP-IB, as set under the **LOCAL** menu: System controller mode and Addressable only mode. The system controller mode is used when no controller is present. The addressable only mode is how a computer can control the HP 87510A and passes active control to the HP 87510A so that the HP 87510A can plot or print.

Note that the HP 87510A assumes that the address of the computer is correctly stored in its HP-IB addresses menu under the **ADDRESS: CONTROLLER** entry. If this address is incorrect, control will not return to the computer.

If the HP 87510A is in Addressable only mode and receives a command telling it to plot or print, it sets bit 1 in the event status register to indicate that it needs control of the bus. If the computer then uses the HP-IB control command to pass control to the HP 87510A, the HP 87510A will take control of the bus, and access the peripheral. When the HP 87510A no longer needs control, it will pass it back to the computer.

Control should not be passed to the HP 87510A before it has set event status register bit 1, Request Active Control. If the HP 87510A receives control before the bit is set, control is passed immediately back.

While the HP 87510A has control, it is free to address devices to talk and listen as needed. The only functions denied it are the ability to assert the interface clear line (IFC), and remote line (REN). These are reserved for the system controller. As active controller, the HP 87510A can send messages to and read replies back from printers and plotters.

This example prints the display.

```

10      !
20      ! Controlling Peripherals
30      !
40      DIM Err$(100)
50      ASSIGN @Hp87510 TO 717
60      !
70      OUTPUT @Hp87510;"*CLS"      ! Clear status reporting system
80      OUTPUT @Hp87510;"*ESE 2" ! Enable Request Active Control bit of ESE
90      !
100     OUTPUT @Hp87510;"PRINALL"
110     REPEAT
120         Stat=SPOLL(@Hp87510)
130     UNTIL BIT(Stat,5)
140     !
150     PASS CONTROL @Hp87510      ! Pass active control to HP 87510
160     DISP "Printing."
170     REPEAT
180         STATUS 7,6;Hpib
190     UNTIL BIT(Hpib,6)
200     DISP "Done."
205     ABORT 7                      ! Return active control to system controller
210     !
220     OUTPUT @Hp87510;"OUTPERRO?"
230     ENTER @Hp87510;Err,Err$
240     IF Err THEN DISP Err$
250     END

```

Figure 2-16. Sample Program: Controlling Peripherals *

Line 70	Clear the status reporting system.
Line 80	Enable the Request Active Control bit in the event status register.
Line 100	Request printing.
Lines 110 through 130	Wait until the HP 87510A requests control.
Line 150	Pass active control to the HP 87510A.
Line 170 through 190	Wait until the print is finished and control is returned.
Line 205	Return active control to the system controller.
Line 220 through 240	If an error occurred, print the error number and the error message.

Transferring disk data files

The built-in disk drive is often used to store data files in addition to instrument states. The file name is then appended with two characters to indicate what is in the file. "_D" indicates the file contains the internal data array using the **SAVE DATA ONLY** or the SAVDDAT command. Refer to "Saving and Recalling Instrument States and Data" in the *Reference Manual* for the file structure.

This example demonstrates how to recall a data file stored by the built-in disk drive into a computer using the disk drive connected to the computer.

Before running the program, store the data to the disk installed in the built-in disk drive, remove the disk, and put the disk in to the computer's disk drive.

```

10      !
20      ! Transferring Disk Data Files
30      !
50      INTEGER Nop
60      DIM Sw$(1:7)[8],Numseg(1:7)
70      DATA "Raw",8,"Cal",24,"Data",2,"Mem",2,"Uniform",2,"Trace",2
      , "Tracemem",2
80      !
90      INPUT "File name (with extension)?",File$
100     ASSIGN @Path TO File$
110     ENTER @Path USING "6X,#"
120     Numdat=0
130     PRINT "Data contained:"
140     FOR I=1 TO 7
150         READ Dat$,Num
160         GOSUB Datasw
170     NEXT I
180     PRINT
190     ENTER @Path USING "4X,#"
200     !
210     INPUT "Press [Return] to read data.",Dum$
220     FOR J=1 TO Numdat
230         FOR I=1 TO Numseg(J)
240             PRINT Sw$(J);I
250             GOSUB Dataseg
260             PRINT
270         NEXT I
280         PRINT
290         IF J=Numdat THEN INPUT "Press [Return] to read next data.",Dum$
300     NEXT J
310     ASSIGN @Path TO *
320     STOP
330     !

```

Figure 2-17. Sample Program: Transferring Disk Data Files

```

340 Dataseg: !
350  ENTER @Path;Nop
360  ENTER @Path USING "4X,#"
370  FOR K=1 TO Nop
380    ENTER @Path;X,Y
390    PRINT K,X,Y
400  NEXT K
410  ENTER @Path USING "4X,#"
420  RETURN
430  !
440 Datasw: !
450  ENTER @Path USING "B,#";Sw
460  IF Sw THEN
470    Numdat=Numdat+1
480    Sw$(Numdat)=Dat$
490    Numseg(Numdat)=Num
500    PRINT Sw$(Numdat)
510  END IF
520  RETURN
530  END

```

Figure 2-17. Sample Program: Transferring Disk Data Files (2/2)

Lines 50 and 60	Set up the data of possible data groups.
Line 90	Get the file name to load. The file name must be included the extension: "_D"(for LIF) or .DAT(for DOS).
Line 100	Define an I/O path which points to the chosen file.
Line 120 through 170	Read the data switches and examine the data contained.
Line 220 through 300	Enter a data group.
Line 230 through 270	Enter a data segment.
Line 310	Close the I/O path.
Lines 340 through 420	Read a data switch.
Lines 440 through 510	Enter a data segment.

Status Reporting

The HP 87510A has a status reporting mechanism that gives information about specific functions and events inside the HP 87510A. The status byte is an 8-bit register with each bit summarizing the state of one aspect of the HP 87510A. For example, the error queue summary bit will always be set if there are any errors in the queue. The value of the status byte can be read with the SPOLL statement. This command does not automatically put the HP 87510A into the remote mode, thus giving the operator access to the HP 87510A front panel functions. Reading the status byte does not affect its value. The sequencing bit can be set by the operator during execution of a test sequence.

The status byte also summarizes two event status registers and one operational status register that monitor specific conditions inside the HP 87510A. The status byte also has a bit that is set when the HP 87510A is issuing a service request over HP-IB, and a bit that is set when the HP 87510A has data to send out over HP-IB. Refer to Appendix B for a definition of the status registers.

The error queue holds up to 20 instrument errors and warnings in the order that they occurred. Each time the HP 87510A detects an error condition and displays a message on the CRT, it also puts the error in the error queue. If there are any errors in the queue, bit 3 of the status byte will be set. The errors can be read from the queue with the OUTPERR? command, which causes the HP 87510A to transmit the error number and the error message of the oldest error in the error queue (first in first out).

It is also possible to generate interrupts using the status reporting mechanism. The status byte bits can be enabled to generate a service request (SRQ) when set. The computer can in turn be set up to generate an interrupt on SRQ.

To be able to generate an SRQ, a bit in the status byte has to be enabled using *SRE *n*. A one in a bit position enables that bit in the status byte. Therefore, *SRE 8 enables an SRQ on bit 3, check error queue, since 8 equals 0000 1000 in binary representation. That means that whenever an error is put into the error queue and bit 3 is set, and the SRQ line is asserted. The only way to clear the SRQ is to disable bit 3, re-enable bit 3, or read out all the errors from the queue.

A bit in the event status register can be enabled so that it is summarized by bit 5 of the status byte. If any bit is enabled in the event status register, bit 5 of the status byte will also be set. For example, *ESE 66 enables bits 1 and 6 of the event status register, since 66 equals 0100 0010 in binary representation. Therefore, whenever active control is requested or a front panel key is pressed, bit 5 of the status byte will be set. Similarly, ESNB *n* enables bits in event status register B so that they will be summarized by bit 2 in the status byte.

To generate an SRQ from an event status register, enable the desired event status register bit. Then enable the status byte to generate an SRQ. For instance, *ESE 32 and *SRE 32 enable the syntax error bit, so that when the syntax error bit is set, the summary bit in the status byte will be set, and it enables an SRQ on bit 5 of the status byte.

During the sample program (Figure 2-18) is running, you can try get into the subroutine "Err_report:" when this program is executed in an external controller and Instrument BASIC is installed in your HP 87510A.

Type a command in command line on the HP 87510A from the keyboard to occur an error:

For example :

```
OUTPUT 800;"HELLO"
```

Because HELLO is not the command of HP 87510A, an error will occur.

```

10      !
20      ! Generating Interrupts
30      !
40      ASSIGN @Hp87510 TO 717
50      !
60      OUTPUT @Hp87510;"*CLS"      ! Clear status reporting system
70      OUTPUT @Hp87510;"*ESE 32"  ! Enable bit-5 of ESR
80      OUTPUT @Hp87510;"*SRE 32"  ! Enable bit-5 or status byte
90      !
100     ON INTR 7 GOSUB Err_report
110     ENABLE INTR 7;2
120     !
130     LOOP
140     END LOOP
150     STOP
160     !
170     Err_report: !
180     Stat=SPOLL(@Hp87510)
190     OUTPUT @Hp87510;"*ESR?"
200     ENTER @Hp87510;Estat
210     PRINT "Syntax error detected."
220     !
230     OUTPUT @Hp87510;"OUTPERRO?" ! Ask error
240     ENTER @Hp87510;Err,Err$      ! Enter error number and message
250     PRINT Err,Err$
260     !
270     ENABLE INTR 7
280     RETURN
290     END

```

Figure 2-18. Sample Program: Generating Interrupts

Line 60	Clear the status reporting system.
Line 70	Enable bit 5 of the event status register.
Line 80	Enable bit 5 of the status byte so that an SRQ will generated when a syntax error occurs.
Line 100	Tell the computer where to branch on an interrupt.
Line 110	Tell the computer to enable an interrupt from interface 7 (HP-IB) when value 2 (bit 1: SRQ bit) of the interrupt register is set. A branch to Err_report will disable the interrupt, so the return from Err_report re-enables it. If there is more than one instrument on the bus capable of generating an SRQ, it is necessary to use serial poll to determine which device has issued the SRQ. In this case, we assume the HP 87510A issued it. A branch to Err_report will disable the interrupt, so the return from Err_report re-enable it.
Line 130 and 140	Do nothing loop.
Line 180	Clear the SRQ bit of the status byte.
Lines 190 and 200	Read the register to clear the bit.
Lines 230 through 250	Instruct the HP 87510A to output the error number and the error message, and print them.

HP-IB Programming Reference

This chapter provides a reference for HP-IB operation of the HP 87510A. Use this information as a reference to the syntax requirements and general function of the individual commands.

This chapter lists the commands in alphabetical order. Refer to Appendix A for a functional list of the commands.

Refer to the *Reference Manual* for the details of each function, or to the *Service Manual* for the details of the service related functions.

HP-IB Command Syntax

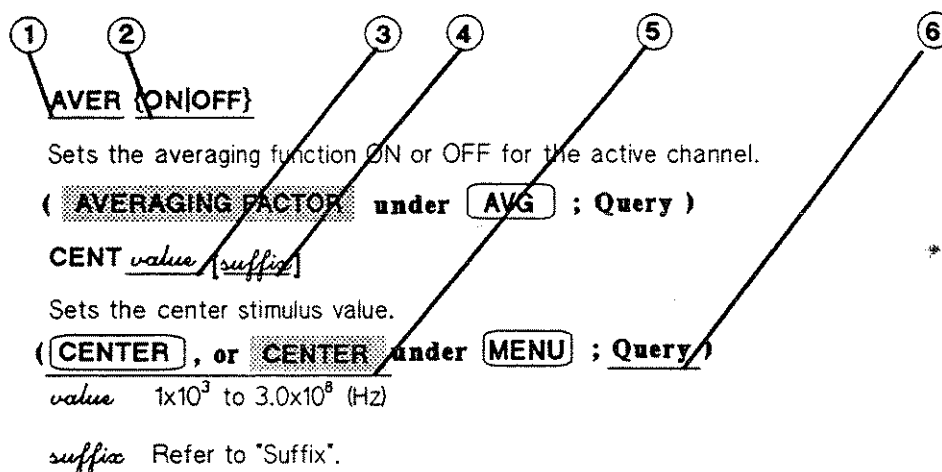

- ① Upper case bold characters represent the program codes which must appear exactly as shown with no embedded spaces. Upper and lower case characters are equivalent.
- ② Characters enclosed in the { } brackets are qualifiers attached to the root mnemonic. There can be no spaces or symbols between the root mnemonic and its appendage.

For example:

{ON|OFF} shows that either ON or OFF can be attached to the root mnemonic. AVER{ON|OFF} means AVERON or AVEROFF.

{1-4} shows that the numeral 1, 2, 3, or 4 can be attached to the root mnemonic. DELR{1-4} means DELR1, DELR2, DELR3, or DELR4.

- ③ A constant or a pre-assigned simple or complex numeric or string variable transferred to the HP 87510A. There must be a space between it and the code.
- ④ Square brackets indicate that the enclosed information is optional.

- ⑤ Key or softkey which has the same function.
- ⑥ "Query" indicates that the command can be queried. Refer to "Query Commands".

Note

A semicolon (;) is required as a separator for each program command except for the last command.

For example, either of the following is acceptable.

```
OUTPUT Hp87510;"CHAN1; AR; LOGM;"  
OUTPUT Hp87510;"CHAN1; AR; LOGM"
```

Query Commands

All instrument functions can be interrogated to find the current On/Off state or value.

For instrument state commands, append the question mark (?) character instead of {ON|OFF} to interrogate the state of the functions. The HP 87510A re to the next controller ENTER operation with a "1" or a "0" to indicate ON or OFF, respectively.

For setting functions such as SCAL *value*, using SCAL? causes the HP 87510A to respond to the next controller ENTER operation by the current function value output then clearing the instrument entry area.

If a command that does not have a defined response is interrogated, the instrument outputs a zero.

■ Example 1

AR

```
OUTPUT Hp87510;"AR?;"  
ENTER Hp87510;Reply  
PRINT "Input port is AR?",  
IF Reply THEN PRINT "Yes"  
IF NOT Reply THEN PRINT "No"
```

■ Example 2

CLASS11{A|B|C}

```
OUTPUT Hp87510;"CLASS11?;"  
ENTER Hp87510;Reply$  
PRINT "3 TERM calibration standard class is ";Reply$
```

■ Example 3

ADDRCONT *value*

```
OUTPUT Hp87510;"ADDRCONT?;"  
ENTER Hp87510;Reply  
PRINT "Controller HP-IB address is ";Reply
```

Suffix

The following suffixes can be used as the units of the command parameter:

Frequency:	Hz (default)
Power:	dBm (default)
Log mag:	dB (default)
Delay time:	s (default)
Phase:	deg (default)
Capacitance:	F (default)
Inductance:	H (default)
Impedance:	ohm (default)

If no suffix is used, the HP 87510A assumes the default values for the instruction. Upper and lower case characters are equivalent.

Code Naming Conventions

The HP-IB Commands of HP 87510A are derived from their front panel key titles (where possible), according to the naming conventions below.

Some codes require additional parameters (on, off, 1, 2, etc.). Codes that have no front panel equivalent are HP-IB only commands, and use a similar convention based on the common name of the function. Where possible, HP 87510A codes are compatible with HP 8751A, HP 8753 and HP 8510 codes.

Table 3-1. HP-IB Code Naming Conventions

Convention	For HP-IB Code Use	Example	
		Key Title	HP-IB Code
One word	First four letters	POWER START	POWE STAR
Two words	First three letters of first word and first letter of second word	ELECTRICAL DELAY SEARCH RIGHT	ELED SEAR
Two words in a group	First four letters of both	MARKER → CENTER	MARKCENT
Three Words	First three letters of first word, first letter of second word, and first four letters of third word	CAL KIT: 7MM SEARCH RNG STORE	CALK7MM SEARSTOR

HP 87510A Instrument Command Reference

ADDRCONT *value*

Sets the HP-IB address which the HP 87510A will use to communicate with an external controller.

(**ADDRESS: CONTROLLER** under **LOCAL**); Query)

value 0 to 30

ADDRPLOT *value*

Sets the HP-IB address which the HP 87510A will use to communicate with the plotter.

(**ADDRESS: PLOTTER** under **LOCAL**); Query)

value 0 to 30

ADDRPRIN *value*

Sets the HP-IB address which the HP 87510A will use to communicate with the printer.

(**ADDRESS: PRINTER** under **LOCAL**); Query)

value 0 to 30

ANA0CH1

Selects channel 1 for waveform analysis. For details, refer to Appendix E. (Query)

ANA0CH2

Selects channel 2 for waveform analysis. For details, refer to Appendix E. (Query)

ANA0DATA

Selects a data trace for waveform analysis. For details, refer to Appendix E. (Query)

ANA0MEMO

Selects a memory trace for waveform analysis. For details, refer to Appendix E. (Query)

ANARANG *value[suffix],value[suffix]*

Sets the waveform analysis stimulus range by entering the START and STOP values. For details, refer to Appendix E. (Query)

value 1 (kHz) to 3.0 (MHz)

suffix refer to "Suffix"

ANARFULL

Sets the analysis range equal to the full stimulus range. For details, refer to Appendix E.

AR

Calculates and displays the complex ratio of input A to input R.

(**A/R** under **MEAS**); Query)

ASCE string

Sets user defined extension for ASCII save file in MS-DOS format. Default setting is ".TXT". Modified extension is kept in SRAM even if power is OFF.

(**DEFINE EXTENSION ASCII DATA** under **SAVE**): Query)

string Extension name. Up to 3 characters

AUTO

Selects the scale/div value automatically to fit the trace data to the display.

(**AUTO SCALE** under **SCALE REF**)

AVER {ON|OFF}

Sets the averaging function ON or OFF for the active channel.

(**AVERAGING on off** under **AVG**); Query)

AVERFACT value

Sets the averaging factor.

(**AVERAGING FACTOR** under **AVG**); Query)

value 1 to 999

AVERREST

Resets and restarts averaging.

(**AVERAGING RESTART** under **AVG**)

BEEPDONE {ON|OFF}

Sets the operation completion beeper ON or OFF.

(**BEEP DONE on off** under **DISPLAY**); Query)

BEEPFAIL {ON|OFF}

Sets the limit fail beeper ON or OFF.

(**BEEP FAIL on off** under **(SYSTEM)**; Query)

BEEPWARN {ON|OFF}

Sets the warning beeper ON or OFF.

(**BEEP WARN on off** under **(DISPLAY)**; Query)

BINCLEL

Clears BIN sort table of active channel.

(**CLEAR LIST YES no** under **(SYSTEM)**)

BINEDONE

Completes editing the BIN sorting table.

(**DONE** under **(SYSTEM)**)

BINESB value

Sets to write a bit to the Event Status resistor B (ESB) if the result is sorted into the specified BIN.

value 0: Out of BIN
 1 to 16: BIN Number
 17: Not Write to ESB

BINL value

Sets lower limit of the BIN.

(**LOWER LIMIT** under **(SYSTEM)**)

value -5.0×10^5 to 5.0×10^5 (dB) (Log mag format)
 -5.0×10^5 to 5.0×10^5 (deg) (Phase and Expanded phase formats)
 -5.0×10^5 to 5.0×10^5 (s) (Delay format)
 -5.0×10^5 to 5.0×10^5 (Units) (Polar, Lin mag, Real, and Imaginary formats)

suffix refer to "Suffix"

BINO value

Sets the out of limit pattern (8 bit) of BIN sorting in decimal value.

value 0 to 255 (integer, decimal)

BINOA

Sets the output port of a BIN result to A port of 24-bit I/O port. (OUTPUT TO [A] under SYSTEM)

BINOB

Sets the output port of a BIN result to B port of 24-bit I/O port.

(OUTPUT TO [B] under SYSTEM)

BINP *value*

Sets the output pattern (8 bit) of BIN sorting as a decimal value.

value 0 to 255 (integer, decimal)

BINS {ON|OFF}

Sets BIN sorting test on or off.

(BIN SORT ON off under SYSTEM)

BINSADD

Adds a new BIN to the BIN sort table.

(ADD under SYSTEM)

BINSDEL

Deletes a selected BIN from the BIN sort table.

(DELETE under SYSTEM)

BINSDON

Complete editing a BIN.

(DONE under SYSTEM)

BINSEDI *value*

Selects BIN to edit.

(BIN under SYSTEM)

value BIN number. 1 to 16

BINSLINE {ON|OFF}

Sets BIN line display on or off.

(**BIN LINE on off** under **(SYSTEM)**)

BINU value[suffix]

Sets upper limit of the BIN.

(**UPPER LIMIT** under **(SYSTEM)**)

value -5.0×10^5 to 5.0×10^5 (dB) (Log mag format)
 -5.0×10^5 to 5.0×10^5 (deg) (Phase and Expanded phase formats)
 -5.0×10^5 to 5.0×10^5 (s) (Delay format)
 -5.0×10^5 to 5.0×10^5 (Units) (Polar, Lin mag, Real, and Imaginary formats)

suffix refer to "Suffix"

C0 value

Enters the constant term of the open circuit capacitor model value, C_0 .

(**C0** under **(CAL)**)

value 0 to 1,000 ($\times 10^{-15}$ F)

C1 value

Enters the constant term of the open circuit capacitor model value, C_1 .

(**C1** under **(CAL)**)

value 0 to 1,000 ($\times 10^{-27}$ F/Hz)

C2 value

Enters the constant term of the open circuit capacitor model value, C_2 .

(**C2** under **(CAL)**)

value 0 to 1,000 ($\times 10^{-36}$ F/Hz²)

CALCASSI

Shows the tabular listing of the calibration kit class assignment.

(**CLASS ASSIGNMENT** under **(COPY)**)

CALI parameter

Selects the measurement calibration type. (Query)

<i>parameter</i>	<i>description</i>
NONE	No calibration
RESP	Response measurement calibration
RAI	Response and isolation measurement calibration
S111	1-Port measurement calibration at port 1

CALIRAI

Selects the response and isolation measurement calibration.

(**RESPONSE & ISOL'N** under **CAL**); Query)

CALIRESP

Selects the response measurement calibration.

(**RESPONSE** under **CAL**); Query)

CALIS111

Selects the 1-port measurement calibration at port 1.

(**S11 1-PORT** under **CAL**); Query)

CALK parameter

Selects the calibration kit. (Query)

<i>parameter</i>	<i>description</i>
APC7	7 mm
N50	Type-N 50 Ω
N75	Type-N 75 Ω
USED	User-defined

CALK7MM

Selects the 7 mm calibration kit.

(**CAL KIT: 7mm** under **CAL**); Query)

CALKN50

Selects the 50 Ω type-N calibration kit.

(**N 50 Ω** under **CAL**); Query)

CALKN75

Selects the 75 Ω type-N calibration kit.

(**N 75 Ω** under **(CAL)**; Query)

CALKUSED

Selects a calibration kit model defined or modified by the user.

(**USER KIT** under **(CAL)**; Query)

CALN

Selects using no calibration.

(**CALIBRATE: NONE** under **(CAL)**; Query)

CALS value

Provides the tabular listing of the standard setting.

(**STD NO. 1** to **STD NO. 8** under **(COPY)**)

value 1 to 8

CENS value1 [suffix], value2 [suffix]

Sets center and span stimulus value.

(**(CENTER)** and **(SPAN)**; Query)

value1 Center stimulus; 1 (kHz) to 300 (MHz)
value2 Span stimulus; 0 (Hz) to 299.999 (MHz)
suffix refer to "Suffix"

CENT value [suffix]

Sets the center stimulus value.

(**(CENTER)**, or **CENTER** under **(MENU)**; Query)

value 1 (kHz) to 300 (MHz)
suffix refer to "Suffix"

CHAD string

Changes the current directory (only MS-DOS format).

(**CHANGE DIRECTORY** under **(SAVE)**)

string Directory path

CHAN1

Selects channel 1 as the active measurement channel. (CH 1); Query)

CHAN2

Selects channel 2 as the active measurement channel. (CH 2); Query)

CIN

Set port C of the 24-bit I/O port to be an input port.

CLAD

Completes specifying a class.

(CLASS DONE (SPE'D) under (CAL))

CLASS11 {A|B|C}

Selects port 1 (S11) one-port calibration standard class: S11A (open), S11B (short), or S11C (load).

([S11] : OPEN, SHORT, or LOAD under (CAL))

CLEL

Clears the current frequency list.

(CLEAR LIST YES under (MENU))

CLEM {1-8}

Clears the marker.

(MARKER 1 to MARKER 8 under (MKR))

CLES

Clears the status byte, the event status register, the event status register B, and the operational status register.

CONT

Continuous trigger.

(CONTINUOUS under (MENU); Query)

CONV parameter

Selects the measurement data conversion setting(impedance, admittance, or multiple phase).
(Query)

<i>parameter</i>	<i>description</i>
OFF	Conversion OFF
ZTRA	Z:transmission
YTRA	Y:transmission
ONEDS	Reciprocal (1/S)
MP4	Multiply phase by 4
MP8	Multiply phase by 8
MP16	Multiply phase by 16

CONV1DS

Expresses the data in inverse measured parameter values.

(1/S under MEAS); Query)

CONVMP {4|8|16}

Multiplies the current phase trace by a multiplier factor specified by a qualifier (4, 8, or 16).

(4 * Phase, 8 * Phase, 16 * Phase under MEAS); Query)

CONVOFF

Turns off all parameter conversion operations.

(OFF under MEAS); Query)

CONVYTRA

Converts transmission data to its equivalent admittance values.

(Y: Trans under MEAS); Query)

CONVZTRA

Converts transmission data to its equivalent impedance values.

(Z: Trans under MEAS); Query)

COPA

Aborts printing or plotting in progress.

(COPY ABORT under COPY)