

Hewlett-Packard Company  
3404 East Harmony Road, Fort Collins, Colorado 80525



HP Part Number 98561-90000

HP 9000 Series 300 Computers

# Installation Reference





# Installing Your System



## Introduction

This manual covers the installation of all Series 300 computers, as well as their monitors and keyboards.

For the purpose of consistency, the computers will be referred to by their product number only. The term, "the computer" will be used when referring to any of the various models.

## Getting Started

Your new computer has just arrived. You're looking for some easy instructions to get it set up and running, and you've turned to this reference for help. You've come to the right place.

Before you proceed, we want to address a few preconceptions you may have about computer documentation. Yes, we know that you may be less than enthusiastic about reading this reference. You're concerned that you'll have to read for hours before you can finally put the book down and actually *do something* with your computer. Or perhaps you're afraid that we'll presume you have a Ph.D. in electrical engineering, give you a schematic of the computer, and tell you to figure it out for yourself.

Forget it. That's not going to happen here. This reference tells you how to put your computer system together and turn it on. When you're finished with this manual, you'll be ready to load and use your operating system or applications program.

## **How This Reference Is Organized**

---

This reference has two chapters. Please read them in order, performing the installation procedures as you go.

**Chapter 1 – Installing Your System.** The section you're now reading tells you how your installation guide is organized. The rest of the chapter explains how to install your system. It expands on the procedure in the Installation Card, and deals with any problems.

**Chapter 2 – Reading The Self-Test.** This chapter tells you how to turn on your computer system and read and interpret the self-test messages.

**Reference.** This section contains information that you don't normally need for installation, but that may be valuable at a later date or for tutorial purposes. You are referred to this section from the main body of the guide where appropriate.

**Glossary.** This section contains definitions of terms used in this reference.

**Add-on Accessories.** If you purchase add-on accessories after your system is installed, you will install them yourself. Store the installation instructions in this section. Those accessories which you purchase with the system will be installed at the factory.

Your Computer's Parts

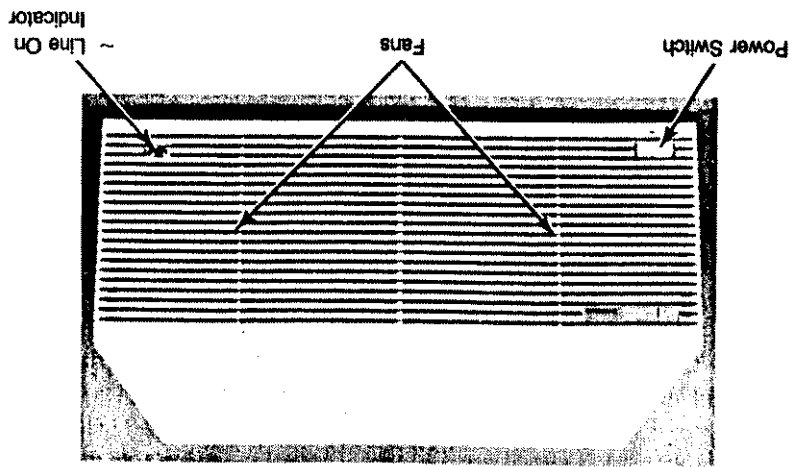
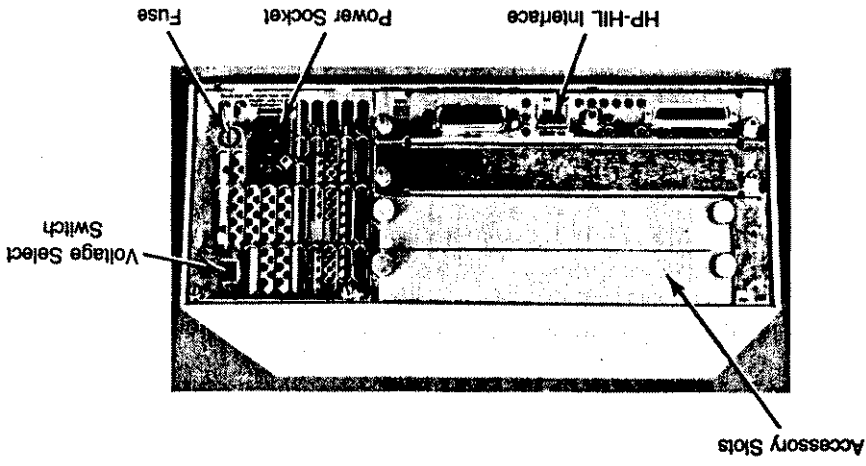

## Your Computer's Parts

The Figures on the facing page show the various parts of the computer which are referred to in this Reference. Note that due to the large number of different configurations, some of the items pointed out may be in a different place than in these Figures. They will, however, look the same.

**Power Switch** - This is the switch you use to turn power on and off. When power is on, the switch is "in" or flush with the front of the computer; the switch is "out" when power is off.

**LINE ON Indicator** - This green indicator is lit when power is turned on. When power is off, the indicator is off.

**Fans** - The computer has two small built-in fans to keep it cool. The fans should always be running when the computer is on. If either fan ever goes off while the computer is powered on, switch the computer off and call your HP Service Representative.

**Accessory Slots** - Remove these covers to install memory cards, interface cards, and other accessories.

**Power Socket** - The three-pronged power socket is especially designed for an HP power cord. The power cord is shipped in the carton this reference came in.

**Voltage Select Switch** - The computer is designed to run at either 85-129 Vac or 187-250 Vac. The line frequency range is 48-66 Hz. The voltage select switch sets the computer to run at the lower (120 Vac) or upper (240 Vac) range.

**Fuse** - A fuse rated at 250V, 8A, must be in place for your computer to run safely.

**HP-HIL Interface** - You will plug your HP-HIL cable into this receptacle.

## Installing Your Computer

---

This section explains how to install your system. It expands on the procedure presented in the *Installation Picture-guide*, and deals with any problems which you may encounter. The computer comes in several versions. Each version has a different *Installation Picture-guide* due to differences in the hardware. However, the versions will be covered together here except for the monitors, which are quite different.

Before you move on to the first step, look at the photo at the beginning of this chapter and familiarize yourself with the computer parts. Find each part on your own computer as you look over the list.

There are four sections to the installation procedure: the Computer section, the Monitor section, the Keyboard section and the Video Display section.

### The Computer Section

This section covers unpacking and installing the computer mainframe.

#### Remove the computer from this carton.

The computer is packed in a large carton together with a box containing accessory items. Go ahead and remove the computer from the large box.

#### Place it on your desk.

Place the computer on any convenient surface. It need not be at your work area, as the computer is designed for remote operation. Be sure that there is at least 50mm (2 inches) of space at the front and back for ventilation. The fans draw cooling air through the grill in the front panel and out the back. Do not operate the computer in areas with excessive dust or smoke.

The best way to check for correct setting is to determine whether you have the correct power cord, then use the furnished chart to determine the correct setting for the power cord.

The computer can be damaged if set for 120 Vac and plugged into a higher voltage.

**CAUTION**

**Compare the voltage setting to the power cord.** Your computer can be set to operate at nominal line voltages of 120 or 240 Vac. It was set at the factory to the line voltage in your area. However, it is a good idea to check the setting and change it if it is incorrect.

**Open the long box and remove the power cord.** The long box is called the Localization Kit, and contains items such as power cords, keyboard cables, and this manual.

Leave enough clearance at the back of the computer for any cables that will be connected. If pressure is exerted against the computer-end of these cables, the connector could be damaged.

**Position the Computer to Allow Free Air Flow**

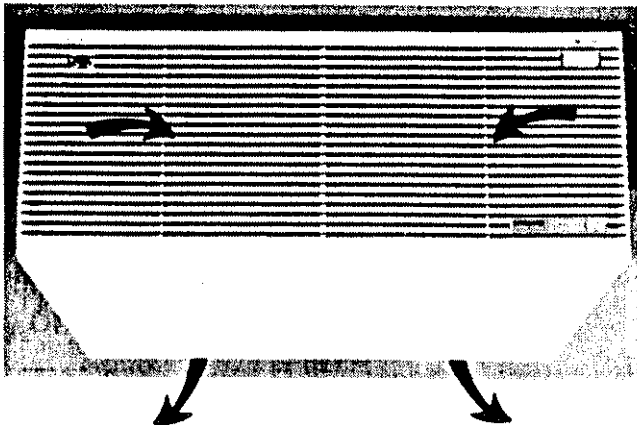



The switch should be in the up position if you have a United States 120V power cord, and in the down position otherwise.

Voltage Select Switch

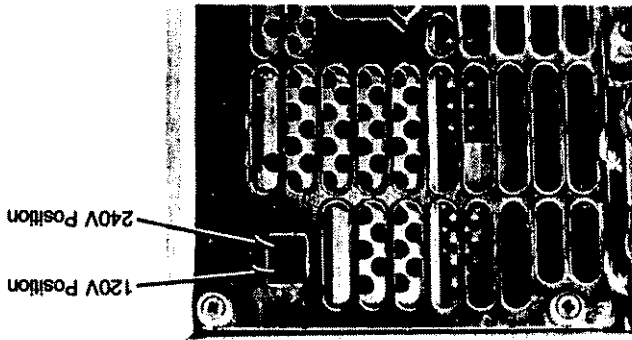

Check the voltage setting. Now compare the voltage figure from the previous step with the setting on the rear panel of the computer.

Available Power Cords

NOTE: Plugs are viewed from connector end. Shape of molded plug may vary within country.

- E = Earth or Safety Ground
  - N = Neutral or Identified Conductor ("hot")
  - L = Line or Active Conductor (also called "live" or "hot")
- Power-cords supplied by HP have polarities matched to the power-input socket on the computer.

Country	Part Number	Opt. Voltage
Australia	8120-1369	250V, 6A
Denmark	8120-2956	250V, 6A
Europe	8120-1659	250V, 6A
Great Britain	8120-1351	250V, 6A
South Africa	8120-4211	250V, 10A
Switzerland	8120-2104	250V, 6A
United States	8120-1378	120V, 10A
United States	8120-0696	240V, 10A

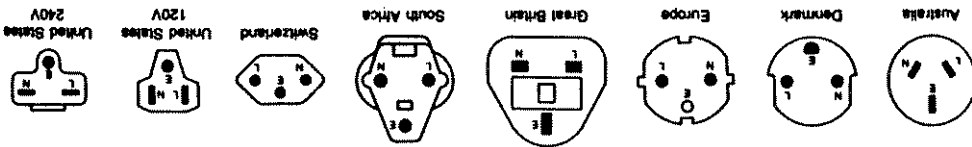

Note: These drawings represent the wall connector end of the cord.

**Find the video board in the computer.** The video board must be installed in the bottom slot in the computer. If a board is already located there, it must be removed and positioned elsewhere.

**Find the video display monitor carton.** The monitor furnished with your computer is the HP 35731A/B 12-inch Monochrome Video Monitor.

Find the carton containing your monitor. It will have HP 35731 printed on it. Go ahead and unpack the monitor and place it on a convenient surface at your work area.

**Medium-resolution Monochrome**

This section covers installing a medium-resolution monochrome monitor.

**Find and unpack the video board.** If you ordered an unbundled system or are upgrading your system, the video board may have come separately. Locate the video board carton. It will have the number 98542A stamped on it.

**The Monitor Section**

This section covers installing your video display monitor and connecting it to the computer mainframe. The monitors are not similar enough to cover together, so they are separated by resolution and whether monochrome or color, and covered individually.

---

**WARNING**

---

If a replacement power cord is needed, make sure you order an HP power cord that is identical to the original. Otherwise, electrical shock or equipment damage may result.

**Connect power to the computer.** Locate the power switch and press it in and out a few times to get the feel of it. Now set it to the off position (that is, the switch is "out").

Connect the power cord to the Computer's power socket. Then connect the other end to the wall socket.

**Check the voltage select setting to be the same as the computer.** Your monitor has a voltage select switch. Make sure that the monitor is set to the same voltage range as the computer.

**Find the audio/video cable.** A two-conductor cable is furnished for audio and video. One conductor is marked "Video" at each end and the other is marked "SPKR".

**Connect the audio/video cable.** Connect one end of the "Video" cable to the Video Out connector on the computer. Connect one end of the "SPKR" cable to the Audio Out connector on the computer. Then connect the other ends to the monitor.

**Install the HP-HIL cable.** The HP-HIL cable is keyed. It has a black dot at one end and two black dots at the other.

Locate the two-dot end of the HP-HIL cable. It is marked with two black dots.

Connect the two-dot end of the HP-HIL cable to the computer. The computer socket is also coded with two dots.

Connect the one-dot end of the HP-HIL cable to the monitor. The monitor receptacle is also coded with one dot.

---

Do not obstruct the air vents at the top and sides of the monitor.

**CAUTION**

---

Turn your computer OFF before installing the monitor.

**CAUTION**

---

Find the carton containing your monitor. It will have HP 35741 printed on it. Go ahead and unpack the monitor and place it on a convenient surface at your work area.

Monitor.

The monitor furnished with your computer is the HP 35741A 12-inch Color Video Monitor.

**Install the video board in the computer.** The video board must be installed in the bottom slot in the computer. If a board is already located there, it must be removed and positioned elsewhere.

**Find and unpack the video board.** If you ordered an unbundled system or are upgrading your system, the video board may have come separately. Locate the video board carton. It will have the number 98543A stamped on it.

This section covers installing a medium-resolution color monitor.

### Computer with Medium-resolution Monochrome Monitor

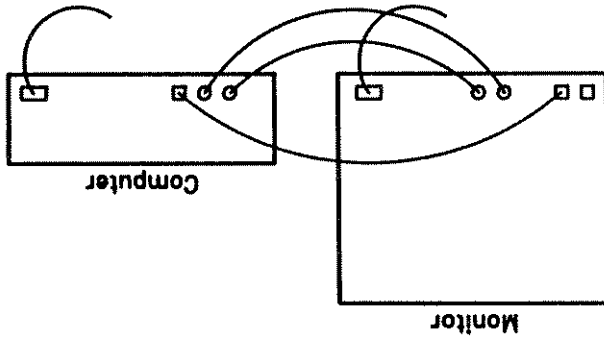

Your system should now look like this:

Turn the monitor ON. This allows the monitor to warm up while you are installing the keyboard.

**Connect power to the monitor.** The power cord is located in the carton containing the monitor. Connect it to the power socket. Then connect the other end to the wall socket.

Connect the one-dot end of the HP-HIL cable to the monitor. The monitor receptacle is also coded with one dot.

Connect the two-dot end of the HP-HIL cable to the computer. The computer socket is also coded with two dots.

Locate the two-dot end of the HP-HIL cable. It is marked with two black dots.

The HP-HIL cable is keyed. It has a black dot at one end and two black dots at the other.  
**Install the HP-HIL cable.**

Now find and install the audio cable. It has an RCA connector on each end. Install it between the computer and the monitor.  
**Install the audio cable.**

The video cables are color-coded Red, Blue and Green. The monitor output connectors are labelled R, B and G. Connect each video cable connector to the appropriate video connector on the computer. Then connect the other ends of the cables to the Monitor.  
**Connect the video cables.**

The video cable carries video signals from the computer to the monitor. Your monitor has three separate video cables for red, blue and green. The cables are identical and may be used for any color.  
**Find the video cables.**

Your monitor has a voltage select switch. Make sure that the monitor is set to the same voltage range as the computer.  
**Check the voltage select setting.**

---

Do not obstruct the air vents at the top and sides of the monitor.

**CAUTION**

---

Turn your computer OFF before installing the monitor.

**CAUTION**

---

## 12 Installing Your System

Find the carton containing your monitor. It will have HP 98786 printed on it. Go ahead and unpack the monitor and place it on a convenient surface at your work area.

**Find the video display monitor carton.**  
The monitor furnished with your computer is an HP 98786A 17-inch high-resolution monochrome Video Monitor.

**Install the video board in the computer.**  
The video board must be installed in the bottom slot in the computer. If a board is already located there, it must be removed and positioned elsewhere.

**Find and unpack the video board.**  
If you ordered an unbundled system or are upgrading your system, the video board may have come separately. Locate the video board carton. It will have the number 98544A stamped on it.

**High-resolution Monochrome**  
This section covers installing a high-resolution monochrome monitor.

**Computer with Medium-resolution Color Monitor**

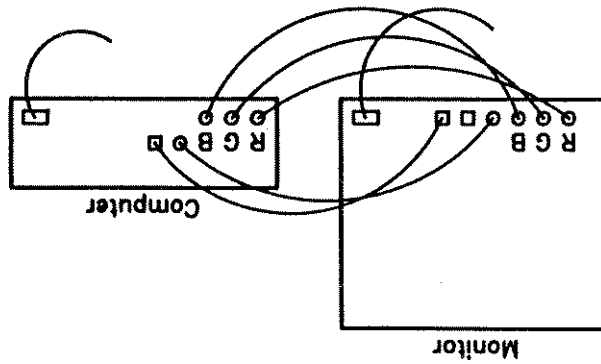

Your system should now look like this:

Turn the monitor ON. This allows the monitor to warm up while you are installing the keyboard.

**Connect power to the monitor.**  
The power cord is located in the carton containing the monitor. Connect it to the power socket. Then connect the other end to the wall socket.

Select a suitable mounting location and remove the paper covering from the back of the fastener pad. Place the pad at the location and press firmly for a few seconds. Now attach the module to the fastener pad.

Suggested locations are the back or side of the monitor or the edge of a desk. Avoid any location which interferes with equipment ventilation grilles.

The fastener pad has a pressure-sensitive adhesive backing. The backing must be placed on a clean, dry and oil-free surface. It should be flat, smooth and non-porous.

Installation involves selecting a location for the module, installing a fastener pad and attaching the module to the pad.

HP 98786A monitor does not have an internal speaker or HP-HIL circuitry, so you will need to install a Speaker Module.

Connect the end with the RCA connector to the video output jack on the computer and the other end to the monitor.

The video cable is black and has an RCA connector on one end and a BNC connector on the other.

Your monitor has a voltage select switch. Make sure that the monitor is set to the same voltage range as the computer.

**Check the voltage select setting.**

---

Do not obstruct the air vents at the top or sides of the monitor.

**CAUTION**

---

Turn your computer OFF before installing the monitor.

**CAUTION**

---



Computer with High-resolution Monochrome Monitor

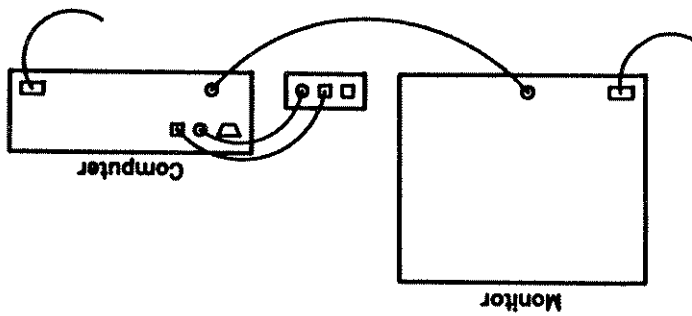

Your system should now look like this:

**Connect power to the monitor.** The power cord is located in the carton containing the monitor. Connect it to the power socket. Then connect the other end to the wall socket.

Connect the one-dot end of the HP-HIL cable to the speaker module. The speaker module receptacle is also coded with one dot. Connect the two-dot end of the HP-HIL cable to the computer. The computer socket is also coded with two dots.

Locate the two-dot end of the HP-HIL cable. It is marked with two black dots.

**Install the HP-HIL cable.** The HP-HIL cable is keyed. It has a black dot at one end and two black dots at the other.

Now locate the phono-to-RCA adapter and connect it to the other end of the audio cable. Then connect it to the RCA connector on the computer.

**Install the audio cable.** Now find the audio cable and connect one end to the speaker module.



**High-resolution Color**  
This section covers installing a high-resolution color monitor.

**Find and unpack the video board.**

If you ordered an unbundled system or are upgrading your system, the video board may have come separately. Locate the video board carton. It will have the number 98547A stamped on it.

**Install the video board in the computer.**

The video board must be installed in the bottom slot in the computer. If a board is already located there, it must be removed and positioned elsewhere.

**Find the video display monitor carton.**

The monitor furnished with your computer is an HP 98751 or an HP 98752A 19-inch high-resolution Color Video Monitor. Find the carton containing your monitor. It will have HP 98751 or HP 98752 printed on it. Go ahead and unpack the monitor and place it on a convenient surface at your work area.

**CAUTION**

Turn your computer OFF before installing the monitor.

**CAUTION**

Do not obstruct the air vents at the top and sides of the monitor.

**Check the voltage select setting.**

Your monitor has a voltage select switch. Make sure that the monitor is set to the same voltage range as the computer.

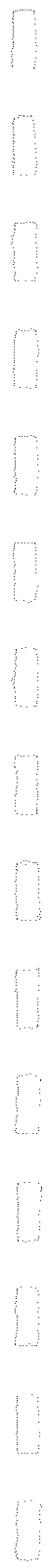

Connect the one-dot end of the HP-HIL cable to the speaker module. The speaker module receptacle is also coded with **one dot**.

Connect the two-dot end of the HP-HIL cable to the computer. The computer socket is also coded with **two dots**.

Locate the two-dot end of the HP-HIL cable. It is marked with two black dots.

The HP-HIL cable is keyed. It has a black dot at one end and two black dots at the other.

**Install the HP-HIL cable.**

Now locate the phono-to-RCA adapter and connect it to the other end of the audio cable. Then connect it to the RCA connector on the computer.

Now find the audio cable and connect one end to the speaker module.

**Install the audio cable.**

Now attach the module to the fastener pad. Select a suitable mounting location and remove the paper covering from the back of the fastener pad. Place the pad at the location and press down firmly for a few seconds.

Suggested locations are the back or side of the monitor or the edge of a desk. Avoid any location which interferes with equipment ventilation grilles.

The fastener pad has a pressure-sensitive adhesive backing. The backing must be placed on a clean, dry and oil-free surface. It should be flat, smooth and non-porous.

Installation involves selecting a location for the module, installing a fastener pad and attaching the module to the pad.

install a Speaker Module.

These monitors do not have an internal speaker or HP-HIL circuitry, so you will need to **Install the Speaker Module.**

The video cables are color-coded Red, Blue and Green. The video output connectors are labelled R, B and G. Connect each video cable connector to the appropriate video connector on the computer. Then connect the other ends of the cables to the monitor.

**Connect the video cables.**

The video cables carry video signals from the computer to the monitor. Your monitor has a three-conductor video cable—one conductor for red, blue and green.

**Locate the video cables.**

The keyboard cable plugs and sockets are not alike. If you force a plug into the wrong socket on the computer or keyboard, you can damage the equipment. Carefully follow installation instructions.

**CAUTION**

The keyboard is packed in a flat box with a picture of a keyboard on the top. Find and unpack the keyboard.

This section covers installing the keyboard.

### The Keyboard Section

#### Computer with High-resolution Color Monitor

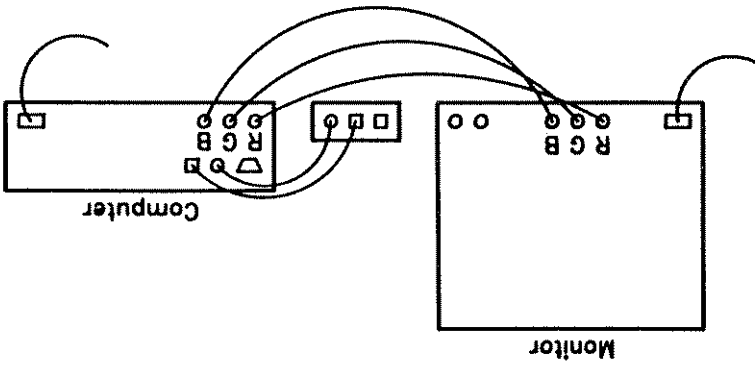

Your system should now look like this:

This allows the monitor to warm up while you are installing the keyboard. Turn the monitor on.

The power cord is located in the carton containing the monitor. Connect it to the power socket. Then connect the other end to the wall socket.

#### Connect power to the monitor.

**Locate the keyboard cable.** The keyboard cable is similar to the HP-HIL cable, except that it is coiled. It is keyed like the HP-HIL cable, with the one-dot end going to the keyboard and the two-dot end going to the speaker module. It is located in the small box in the large, outer carton containing the computer.

**Connect the two-dot end of the keyboard cable.** Find the two black dot end of HP-HIL keyboard cable. The socket on the speaker module also has two dots. Install the two dot end of the HP-HIL cable into the two-dot socket on the speaker module.

**Connect the one-dot end of the keyboard cable.** Install the keyboard cable plug with one dot in the right-hand socket of the keyboard (as viewed from the back). The right-hand keyboard socket is also coded with one dot.

Slide the keyboard cable into the cable run on the keyboard. Fold the keyboard stand up or down as you like.

Computer with High-resolution Monochrome Monitor and Keyboard

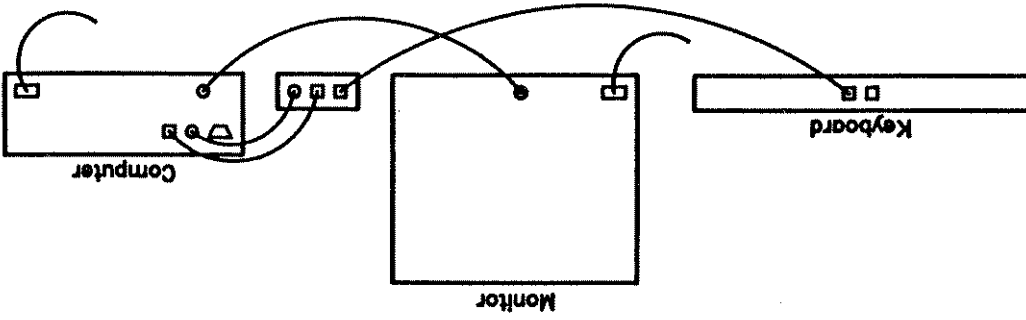

Computer with Medium-resolution Color Monitor and Keyboard

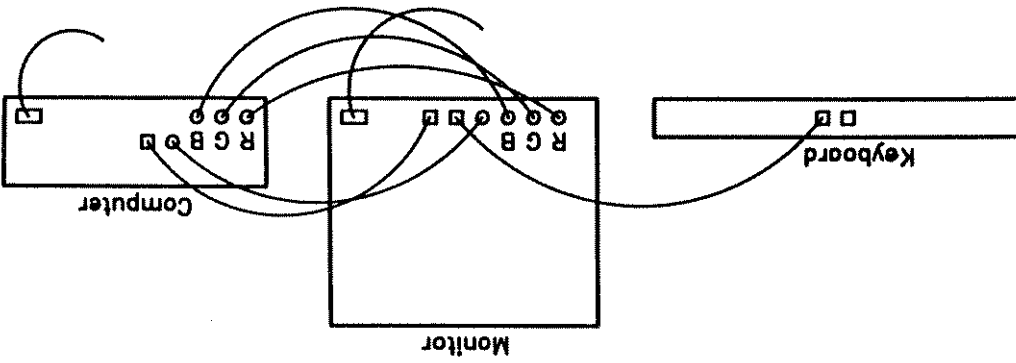

Computer with Medium-resolution Monochrome Monitor and Keyboard

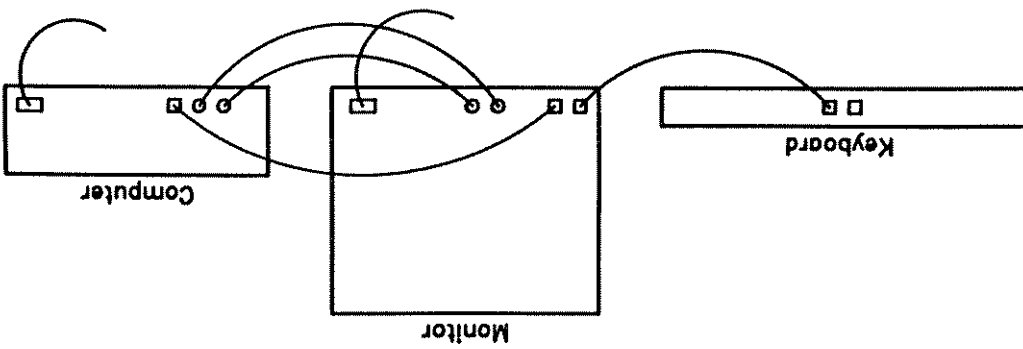

Your system should now look like this:



If you answered "yes" to all three questions, replace the fuse according to the instructions in the Reference section at the back of this guide and again try to turn on your computer. If it still doesn't turn on, call your HP Service Representative.

3. Is power present at the power outlet?
2. Is the power cord firmly plugged into the computer's power socket and into the power outlet?
1. Is the power switch on the front of the computer set to the "on" position? The switch should be "in", flush with the front of the computer.

If your computer does not turn on, check the following:

Any problems?

Turn the computer on. Press in the power switch at the left front of the computer. You should immediately hear the fans running. The green "LINE ON" indicator should light.

computer is functioning properly.

This section covers turning the computer on and checking the video display to see if the

### The Video Display Section

Computer with High-resolution Color Monitor and Keyboard

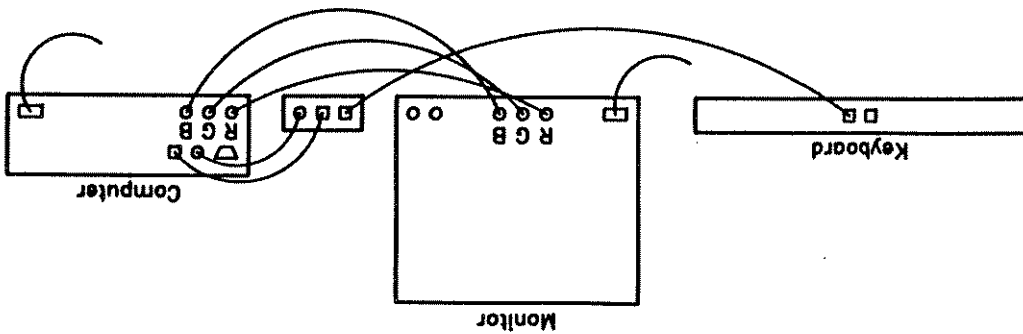

**Compare the display to this picture.**  
If the display is incorrect, proceed to Chapter 2.

If you do not see a display, but hear a series of beeps, make sure that you have correctly installed your system. If you have, refer the problem to your HP Service Representative. A list of HP Sales and Support Offices is packed with your computer.

If you do not see a display and don't hear any beeps either, make sure that you have correctly installed the video display monitor.

Areas to check are:

- Is the monitor plugged in and turned on?
- Are the video cables correctly installed?

If the display is correct, you have installed your computer. If you have an HP 98568A or an HP 98570A eight-slot backplane expander to install, do so now. Use the instructions included with the expander or those in the *Peripheral Installation Guide*.

If you do not have an expander to install, proceed to the *Peripheral Installation Guide* to install your peripherals.

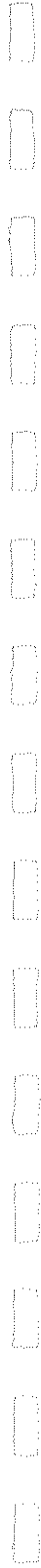

**22** Installing Your System



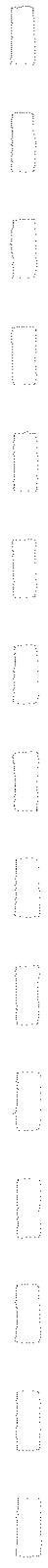

Computers can be valuable time-savers, but only if they are operating reliably. If a problem goes undetected and your computer fails in the middle of a job, data can be lost and hours of your labor may be wasted.

Your computer minimizes this risk by performing a self-test every time you turn it on. In this way, most problems are caught before you start to work, sparing you the frustration of a mid-session failure.

In this chapter, we describe how to interpret the self-test messages and suggest what you should do in case of a failure.

---

## Reading the Self-Test

# 2

## Self-Test Messages

Turn your monitor on, and turn your computer on or press **Shift-Reset** if it is already on. If you have one or more operating systems on-line, tap the space bar a couple times after the word keyboard appears. This inhibits the boot ROM from loading a system. Notice the messages appearing along the left-hand side of the screen. Compare your display to the appropriate one below. Adjust your monitor if necessary.

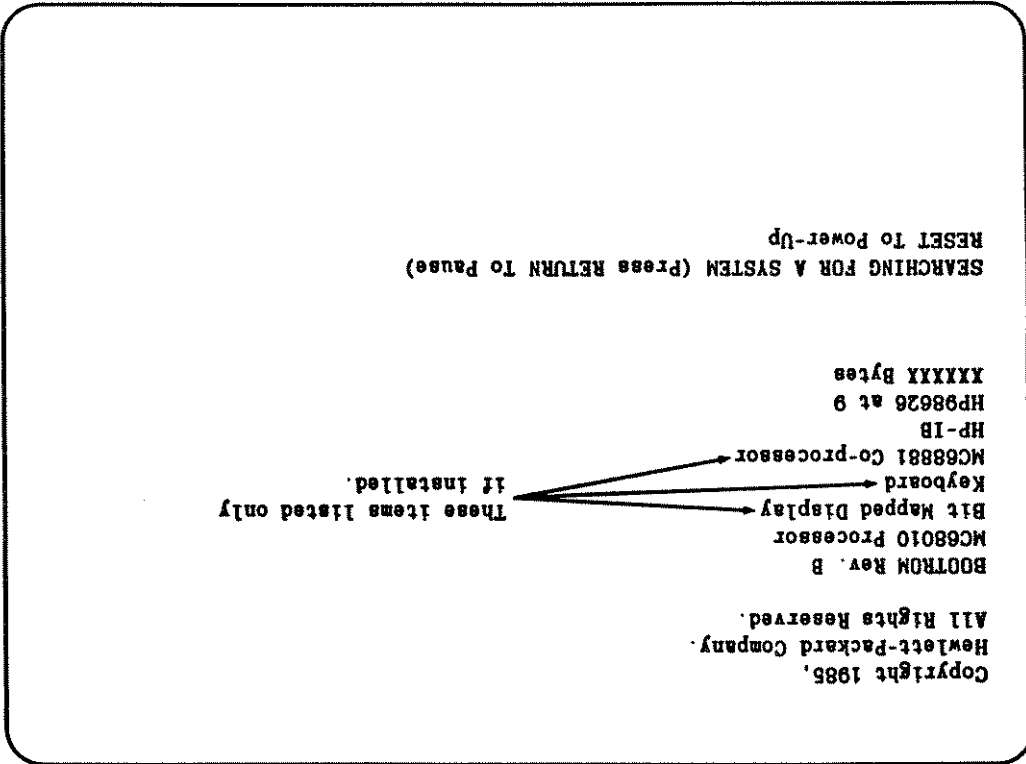

Model 310 Display

Model 320 Display

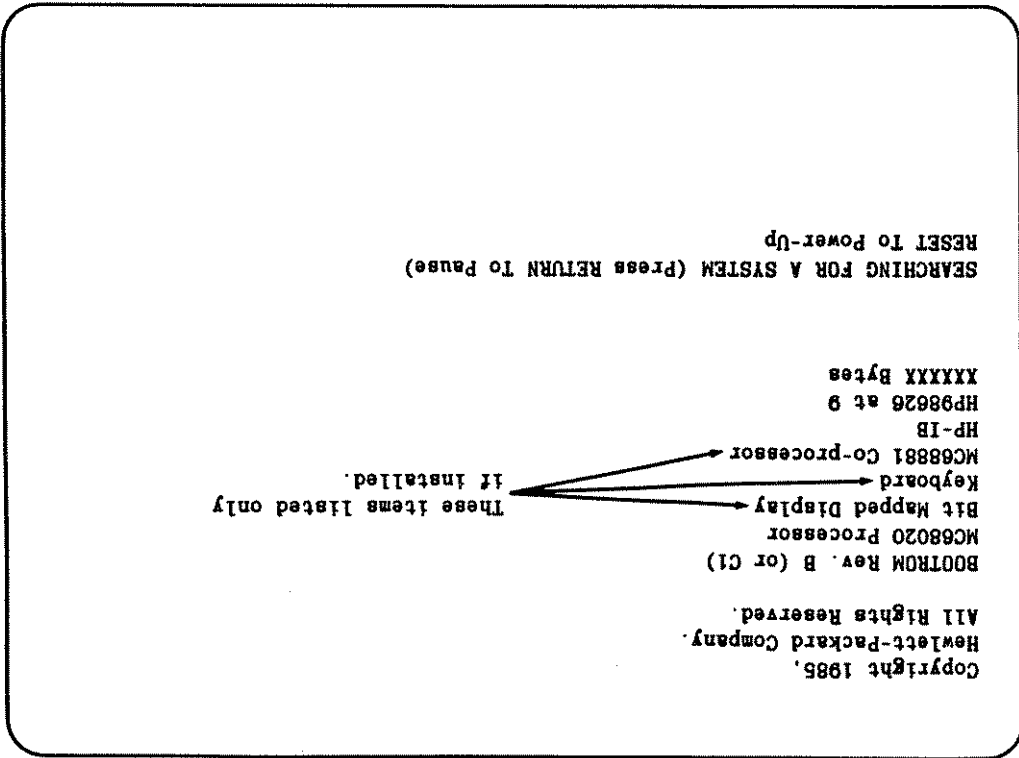

The lines under the **BOOTROM Rev.** A message tell you that each major component in your computer has just been tested. If the component passed the test, a status message is displayed; if the component failed the test, an error message will appear.

### Models 330 and 350 Display

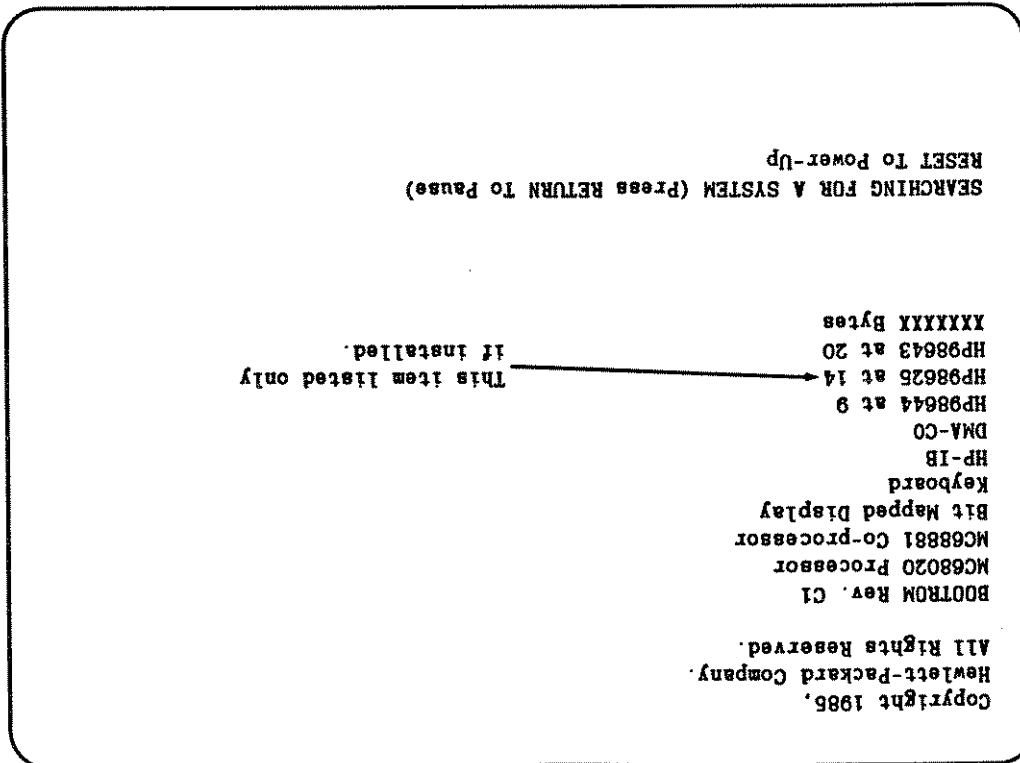

You have completed the installation of your computer, keyboard and monitor. You are now ready to install peripheral devices, such as printers and mass storage devices. The *Peripheral Installation Guide* (part number 97005-90000) is the place to go for this information. It is located in the carton containing your software or operating system.

### Where to Go Next

appears at the bottom of the screen. Press **Shift**—**Reset** if you want to re-start the self-test and see this message. When the memory test is finished, the number of bytes of RAM is reported in the self-test list (e.g., 524114 Bytes).

### TESTING MEMORY

While the memory test is in progress, the message:

The final status message in the self-test list (XXXXXX Bytes) shows that memory has passed its test. This figure will be different for the various models. You may check it by adding up your amount of RAM and subtracting 174 bytes.

The next message reports that your computer's built-in HP-IB interface is functional. Below that is the message HP98644 at 9, which indicates that your built-in Data Communications interface is working. The message, HP98643 at 20, indicates that your built-in Local Area Net interface is working. If you have another interface in your computer, its name and select code would be listed, also.

The next three status messages, Bit Mapped Display, Keyboard, and MC68881 Co-processor, tell you that the monitor's bit-mapped display, the keyboard and the floating-point coprocessor, respectively, are working properly.

The first status message is either MC68010 or 68020 Processor, and tells you that the computer's central processor is functioning properly.

### Status Messages

After the error pattern has sounded, the boot ROM searches for a system to load. If you want to cancel the one-minute delay and the beeps, you can press **Return**. The boot ROM will then display any operating systems found and wait for you to specify which system you want loaded.

In addition to displaying an error and waiting a minute, the boot ROM sounds a pattern of beeps. The boot ROM is actually sending an error message to a service person. If this error pattern is sounded, check the display for an error message. Refer to the Boot ROM Error Messages list which follows in this chapter. If the message indicates something you cannot correct, or if the display is not working, you should call HP for service. Your service representative may ask you to restart the self-test so he can listen to the error code sounded.

### Boot ROM Beeper

This message tells you that the computer found at least one error and it's giving you a minute to read the error message(s) on the screen. You can press **Return** to terminate the waiting period.

WAITING 1 MINUTE (Press RETURN to Abort wait)

After displaying an error message, the computer moves on to the next component in the self-test list. After all components are tested, the computer either looks for software to load, or displays the message:

should look at.

This means that the computer found the keyboard's electronics, but it wasn't happy with what it found. This message indicates a problem that an HP Service Representative

Keyboard Failed

You might get the message:

If a component fails its test, an error message is displayed in place of the usual status message. There are a few types of error messages; we'll discuss one of them here and list the rest in the Boot ROM Error Messages list which follows in this chapter.

### Error Messages

## Boot ROM Errors

If the computer detects a problem with the boot ROM (that is, it failed checksum), it displays the message:

**BOOTROM Rev. X Failed**

instead of the **BOOTROM Rev. X** message displayed when powerup is successful. It also displays the message:

**CONTINUE AT OWN RISK (Press RETURN To Continue)**

The computer will do nothing further until you press the **Return** key. Your computer is somewhat unpredictable in this state and could alter the programs that you want to load from a disk. Therefore, if you decide to continue, make sure you have extra copies of any disks or programs that the boot ROM might access.

If the same error is reported a second time, look up the message in the Boot ROM Error Messages list which follows. You can often correct the problem yourself. Make the recommended adjustment and run the self-test again. If the same error is reported, or if the error message you get doesn't appear in the Boot ROM Error Messages list, call your HP Service Representative for help.

Very few self-test errors are serious enough to require service. When an error is reported, always run the self-test again and see if the error is repeated.

## What To Do When Errors Occur

---

The boot ROM will restart the self-test and run a longer RAM test. This test may catch intermittent problems not seen by the power-up self-test.

**T**

When the Configure menu appears, press:

**CTRL**—**C**

If you wish to run a more complete test of all RAM in the computer, turn on the computer or press **Shift**—**Reset** while the computer is self-testing:

## Running an Extended Memory Test

---



You have completed the installation of your computer, keyboard and monitor. You are now ready to install peripheral devices, such as printers and mass storage devices. The *Peripheral Installation Guide* is the place to go for this information. It is located in the carton containing your software or operating system.

### Where to Go Next

Error Message	Description and Recovery Action
UNEXPECTED USE OF xxxxxx	Indicates a system failure. Call HP for service.
CONTINUE AT OWN RISK	Errors detected in the boot ROM. Press <b>Return</b> to continue the self-test. Ensure you have a copy of every file the boot ROM may access. If the error persists, call HP for service.
HP-IB failed	Errors detected in the boot ROM. Press <b>Return</b> to continue the self-test. Ensure you have a copy of every file the boot ROM may access. If the error persists, call HP for service.
WAITING 1 MINUTE	Either more than half of the devices on the HP-IB interface are turned OFF or a device on the HP-IB has failed the self-test. First turn each device on or disconnect it. Then run the self-test again. If the message is repeated, call for service.
	The self-test found a failure. After evaluating the message, either press <b>Return</b> to begin the booting process or call HP for service.

This section lists error messages sent by the boot ROM. The boot ROM stores instructions that tell the computer to test the computer, display status messages, and search for a system program. We have tried to anticipate some errors you might receive that indicate a hardware mis-configuration rather than a failure. If you still receive the error after making the recommended adjustment, it means that there is a real problem; call HP for service.

### Boot ROM Error Messages

When your computer develops a problem that you cannot correct yourself, call your HP Service Representative. A number of service contracts are available. Refer to the Sales and Support Offices list which was packed with your computer.

### Where To Get Help

**Notes**

---



## Reference

---

This section contains the following reference and tutorial information:

- Replacing the Fuse
- Processor Board Switches
- Human Interface Card Switches
- System Interface Board Switches

## Replacing the Fuse

---

New fuses are available at Hewlett-Packard Sales and Service Centers.

1. Turn off the computer's power switch.
2. Unplug the power cord from the outlet and then unplug it from the power socket on the computer.
3. The fuse is located just beside the power cord.

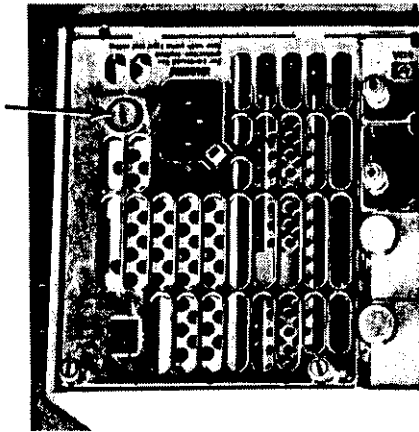

Fuse Location

4. Open the fuse cover by turning it counter-clockwise with a screwdriver.
5. Remove the fuse cover. It should contain a 250V, 8A fuse. Remove the fuse.
6. Install the replacement fuse that was shipped with your computer into the fuse cover, and slide the cover into the computer.
7. Close the cover by turning it clockwise with a screwdriver.
8. Plug the power cord into the computer's power socket and into the power outlet.
9. Press in the power switch on the computer.

## Processor Board Switches

Processor boards contain communications functions with switch-selected attributes. This section tells how to set the switches for desired operation. Processor boards with the part number 98561-66519 and 98561-66521 do not contain switches.

The following tables list and describe processor boards used in the Series 300 computers.

### Processor Boards for Model 310

Processor Board	Features	Used In	Replaced By
98561-66511	<ul style="list-style-type: none"> <li>• MC 68010 at 10MHz</li> <li>• 0.5M RAM</li> <li>• Rev. A bootROM</li> <li>• 512x400x1 Mono Video</li> </ul>	HP 98561A Opt 002	98561-69525
98561-66512	<ul style="list-style-type: none"> <li>• MC 68010 at 10MHz</li> <li>• 1.0M RAM</li> <li>• Rev. A bootROM</li> <li>• 512x400x1 Mono Video</li> </ul>	HP 98561A	98561-69525
98561-66513	<ul style="list-style-type: none"> <li>• MC 68010 at 10MHz</li> <li>• 1.0M RAM</li> <li>• Rev. A bootROM</li> <li>• No Video</li> </ul>	HP 98561A Opt 003	98561-69526
98561-66514	<ul style="list-style-type: none"> <li>• MC 68010 at 10MHz</li> <li>• 0.5M RAM</li> <li>• Rev. A bootROM</li> <li>• 512x400x1 Mono Video</li> <li>• Upgrade to Rev B bootROM<sup>1</sup></li> </ul>	HP 98561A Opt 002	98561-69525
98561-66515	<ul style="list-style-type: none"> <li>• MC 68010 at 10MHz</li> <li>• 1.0M RAM</li> <li>• Rev. A bootROM</li> <li>• 512x400x1 Mono Video</li> <li>• Upgrade to Rev B bootROM<sup>1</sup></li> </ul>	HP 98561A	98561-69525

<sup>1</sup> Upgrade to Rev B bootROM with 98563-67001

Processor Board	Features	Used In	Replaced By
98561-66516	<ul style="list-style-type: none"> <li>• MC 68010 at 10MHz</li> <li>• 1.0M RAM</li> <li>• Rev. A bootROM</li> <li>• No Video</li> <li>• Upgrade to Rev B bootROM<sup>1</sup></li> </ul>	HP 98561A Opt 003 and 98563-83500 Repair Kit	98561-69526
98561-66524	<ul style="list-style-type: none"> <li>• MC 68010 at 10MHz</li> <li>• 0.5M RAM</li> <li>• Rev. B bootROM</li> <li>• 512x400x1 Mono Video</li> </ul>	HP 98561A Opt 002	98561-69525
98561-66525	<ul style="list-style-type: none"> <li>• MC 68010 at 10MHz</li> <li>• 1.0M RAM</li> <li>• Rev. B bootROM</li> <li>• 512x400x1 Mono Video</li> </ul>	HP 98561A	98561-69525
98561-66526	<ul style="list-style-type: none"> <li>• MC 68010 at 10MHz</li> <li>• 1.0M RAM</li> <li>• Rev. B bootROM</li> <li>• No Video</li> </ul>	HP 98561A Opt 003	98561-69526

Processor Boards for Model 310 (continued)

**Processor Boards for Model 320**

Processor Board	Features	Used In	Replaced By
98561-66519	<ul style="list-style-type: none"> <li>• MC 68020 at 16.67MHz</li> <li>• No RAM 16K Cache</li> <li>• MC 68881 Flot. Pt. Coproc.</li> <li>• at 12.5MHz</li> <li>• Rev. A bootROM</li> <li>• 512x400x1 Mono Video</li> <li>• Upgrade to Rev B bootROM<sup>1</sup></li> </ul>	HP 98561B	98561-69521
98561-66520	<ul style="list-style-type: none"> <li>• MC 68020 at 16.67MHz</li> <li>• No RAM 16K Cache</li> <li>• MC 68881 Flot. Pt. Coproc.</li> <li>• at 16.67MHz</li> <li>• Rev. A bootROM</li> <li>• 512x400x1 Mono Video</li> <li>• Upgrade to Rev B bootROM<sup>1</sup></li> </ul>	HP 98561B	98561-69522
98561-66521	<ul style="list-style-type: none"> <li>• MC 68020 at 16.67</li> <li>• No RAM 16K Cache</li> <li>• MC 68881 Flot. Pt. Coproc.</li> <li>• at 12.5MHz</li> <li>• Rev. B bootROM</li> <li>• No Video</li> </ul>	HP 98561B	98561-69521
98561-66522	<ul style="list-style-type: none"> <li>• MC 68020 at 16.67MHz</li> <li>• No RAM 16K Cache</li> <li>• MC 68881 Flot. Pt. Coproc.</li> <li>• at 16.67MHz</li> <li>• Rev. B bootROM</li> <li>• 512x400x1 Mono Video</li> </ul>	HP 98561B	98561-69522

<sup>1</sup> Upgrade to Rev B bootROM with 98563-67001

Processor Board	Features	Used In	Replaced By
98562-66516	<ul style="list-style-type: none"> <li>• MC 68020 at 25MHz</li> <li>• 4M RAM</li> <li>• MC 68881 Co-FPU</li> <li>• Custom MMU</li> <li>• Rev A2 bootROM</li> <li>• No Video</li> </ul>	HP 98562B	98562-66517
98562-66512	<ul style="list-style-type: none"> <li>• MC 68020 at 25MHz</li> <li>• 4M RAM</li> <li>• MC 68881 Co-FPU</li> <li>• Custom MMU</li> <li>• Rev C bootROM</li> <li>• No Video</li> </ul>	HP 98562B	98562-69512

**Processor Boards for Model 350**

Processor Board	Features	Used In	Replaced By
98562-66511	<ul style="list-style-type: none"> <li>• MC 68020 at 16MHz</li> <li>• 4M RAM</li> <li>• MC 68881 Co-FPU</li> <li>• MC 68851 MMU</li> <li>• Rev A2 bootROM</li> <li>• No Video</li> </ul>	• HP 98562A	98562-66513
98562-66513	<ul style="list-style-type: none"> <li>• MC 68020 at 16MHz</li> <li>• 4M RAM</li> <li>• MC 68881 Co-FPU</li> <li>• MC 68851 MMU</li> <li>• Rev C bootROM</li> <li>• No Video</li> </ul>	HP 98562A	98562-69013

**Processor Boards for Model 330**



**Processor Board for Model 318**

Processor Board	98571-66510	<ul style="list-style-type: none"> <li>• MC 68030 at 16MHz</li> <li>• No RAM</li> <li>• MC 68882 Co-FPU</li> <li>• MC 68851 MMU</li> <li>• Rev CI bootROM</li> <li>• No Video</li> </ul>	Used In	HP 98563E HP 98563G HP 98564C HP 98564G HP 98573C	Replaced By	98571-69510
-----------------	-------------	--	---------	---	-------------	-------------

**Processor Board for Model 319**

Processor Board	98564-66510	<ul style="list-style-type: none"> <li>• MC 68020 at 16MHz</li> <li>• 4M RAM</li> <li>• MC 68881 Co-FPU</li> <li>• MC 68851 MMU</li> <li>• Rev CI bootROM</li> <li>• No Video</li> </ul>	Used In	HP 98564A	Replaced By	98564-69510
	98564-66511	<ul style="list-style-type: none"> <li>• MC 68020 at 16MHz</li> <li>• 8M RAM</li> <li>• MC 68881 Co-FPU</li> <li>• MC 68851 MMU</li> <li>• Rev CI bootROM</li> <li>• No Video</li> </ul>		HP 98564A		98564-69511

Processor Board	98579-66515	<ul style="list-style-type: none"> <li>• MC 68020 at 33MHz</li> <li>• MC 68882 Co-FPU</li> <li>• Rev CI bootROM</li> <li>• No Video</li> </ul>	HP 98579B and HP 98247B and HP 98247C	98579-69515	Replaced By
-----------------	-------------	--	---	-------------	-------------

**Processor Boards for Model 370**

Processor Board	98579-66510	<ul style="list-style-type: none"> <li>• MC 68030 at 16MHz</li> <li>• 4M RAM</li> <li>• MC 68881 Co-FPU</li> <li>• MC 68851 MMU</li> <li>• Rev CI bootROM</li> <li>• No Video</li> </ul>	HP 98579A and HP 98247A Upgrade kit	98579-69510	Replaced By
-----------------	-------------	--	--	-------------	-------------

**Processor Boards for Model 360**

Processor Board	98571-66510	<ul style="list-style-type: none"> <li>• MC 68030 at 16MHz</li> <li>• No RAM</li> <li>• MC 68882 Co-FPU</li> <li>• MC 68851 MMU</li> <li>• Rev CI bootROM</li> <li>• No Video</li> </ul>	HP 98563E HP 98563G HP 98564C HP 98564G HP 98573C	98571-69510	Replaced By
-----------------	-------------	--	---	-------------	-------------

**Processor Board for Model 340**

The following illustration shows the processor board switches. Switch descriptions follow the illustration. Check the switches in their default positions. Switch descriptions follow the illustration. Check the switches and change them as required.

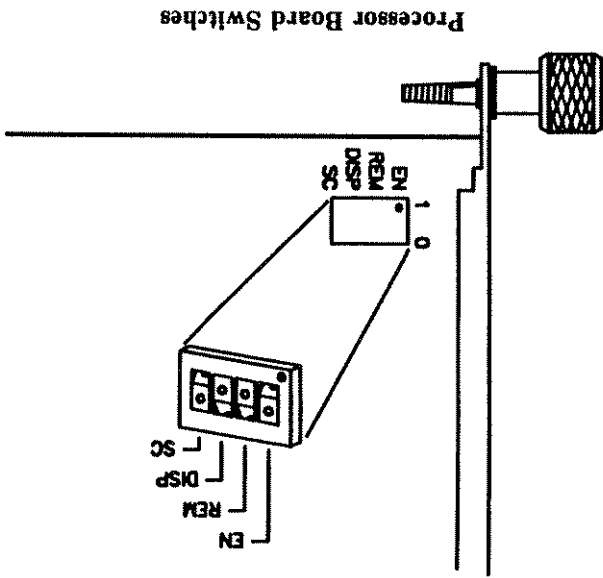

Processor Board Switches

## Setting Processor Board Switches

Switch Label	Function/How It's Used
SC	Internal HP-IB System Controller 1 = System Controller (Shipped setting) 0 = Not System Controller
DIS	Display Disable 0 = Enabled(Shipped setting) 1 = Disabled
REM	Remote Terminal Enable 0 = Local Mode (Shipped setting) 1 = Remote Mode
EN	RS-232 Control Line Defeat 0 = Control Lines Defeated 1 = Control Lines Defeated (Shipped setting)



## Human Interface Card Switches

The 98561-66530 and 98561-66531 human interface cards contains communications functions with switch-selected attributes. This section tells how to set the switches for desired operation.

The following illustration shows the interface card switches. All switches are shown in their default positions. Switch descriptions follow the illustration. Check the switches and change them as required.

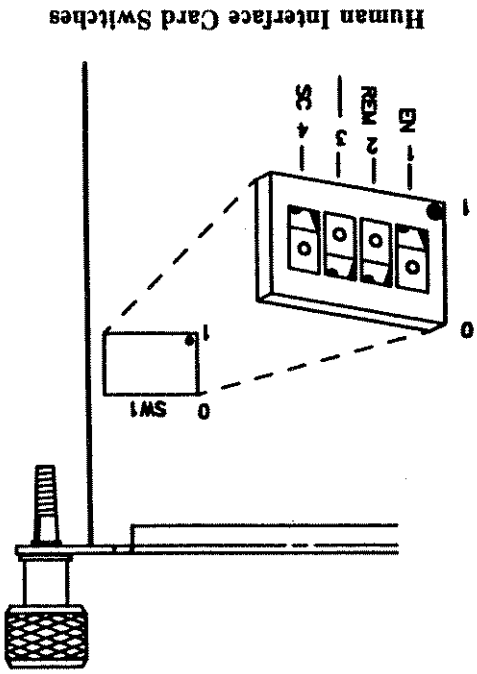

Human Interface Card Switches

### Human Interface Card Switches

Switch Label	Function/How It's Used
SC	Internal HP-IB System Controller 1 = System Controller (Shipped setting) 0 = Not System Controller
REM	Remote Terminal Enable 0 = Local Mode (Shipped setting) 1 = Remote Mode
EN	RS-232 Control Line Defeat 0 = Control Lines Defeated 1 = Control Lines Defeated (Shipped setting)



## System Interface Board Switches

The 98237-66530, 98237-66533, and 98561-66534 system interface boards contain communications functions with switch-selected attributes. This section tells how to set the switches for desired operation.

The following illustration shows the system interface board switches. Switch descriptions follow the illustration. Check the switches and change them as required. All switches are shown in their default positions.

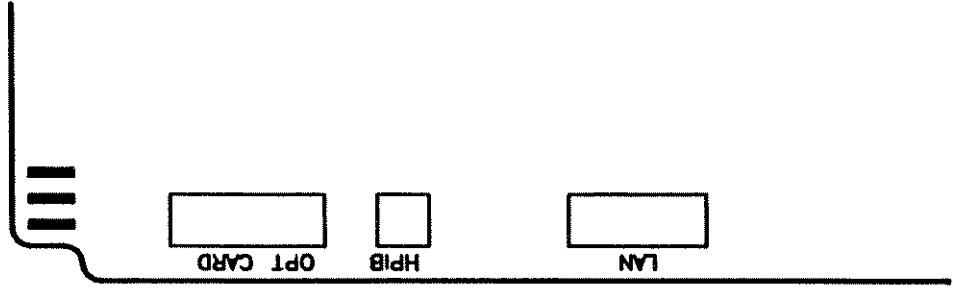

System Interface Board Switches

Switch Label	Function/How It's Used
SC	Internal HP-IB System Controller 1 = System Controller (Shipped setting) 0 = Not System Controller
DIS	RS-232 Disable 0 = Enabled (Shipped setting) 1 = Disabled
REM	Remote Terminal Enable 1 = Remote Mode 0 = Local Mode (Shipped setting)
MEN	Modem Enable 1 = Modem lines enabled (Shipped setting) 0 = Modem lines disabled

HP-IB and RS-232 Configuration Switches

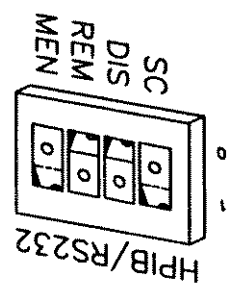

HP-IB and RS-232 Switches



### Optional Disc Interface Switches

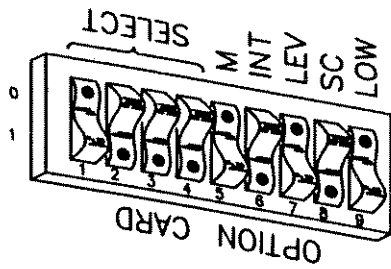

Optional Disc Interface Configuration Switches

Switch Label	Function/How It's Used
LOW (9)	Low/High Speed 0 = High Speed (Shipped setting) 1 = Low Speed
SC (8)	System Controller 1 = System Controller (Shipped setting) 0 = Not System Controller
INT (6) LEV (7)	Interrupt Level: LEV (7) is MSB 7 6 -- 0 0 = Level 3 0 1 = Level 4 (Shipped setting) 1 0 = Level 5 1 1 = Level 6
SELECT (1 - 5)	Select Code: 5 (M) is MSB. Shipped set at Select Code 14 (01110)

Switch Label	Function/How It's Used
REM (8)	Local/Remote 0 = Local (Shipped setting) 1 = Remote
INT (6) LEV (7)	Interrupt Level: LEV (7) is MSB 7 6 -- 0 0 = Level 3 0 1 = Level 4 1 1 = Level 6
SELECT (1 - 5)	Select Code: 5 (M) is MSB. Shipped set at Select Code 20 (10100)

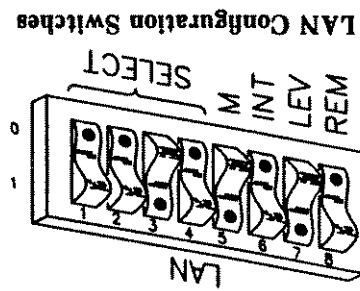

LAN Configuration Switches

LAN Switches

# Glossary

**Bit:** A binary digit (1 or 0).

**Boot ROM:** The boot ROM stores instructions that tell the computer how to search for a system program. They basically keep the computer running until a system program can take over.

**Byte:** The unit of memory used on your computer. One byte equals eight bits and is generally equivalent to one character, like "A".

**Character Code:** A numeric code which is used to represent a character inside the computer.

**CRT:** The computer's screen (cathode ray tube).

**Cursor:** The blinking underline character that marks the position on the screen where the next character will be typed.

**Disk:** Similar to a phonograph record, except that it stores programs and data instead of music.

**Disk Drive:** An input/output device that transfers programs and data between a disk and the computer's memory.

**Hardware:** All of the electrical and mechanical components of the computer.

**K bytes:** 1 024 bytes.

**Language System:** A large program which performs all of the functions of a system program, plus supports a programming language like BASIC or Pascal.

**Language-dependent Program:** A program which requires a language system in order to run. Language-dependent programs are always loaded into memory *after* a language system has been booted.

**M bytes:** 1 048 576 bytes.

**Memory:** The area of the computer where programs and data are stored. The processor cannot run a program unless the program is in memory.

**Memory Address:** A number which uniquely identifies one byte of memory.

**Processor:** This is the "brain" of the computer that runs programs and regulates most other computer functions.

**Program:** A set of instructions that tell the processor how to perform a particular task. Most programs are written in a high-level programming language like BASIC or Pascal.

**RAM: Random Access Memory.** This is erasable program memory. Programs and data are usually copied into RAM from a disk drive or other mass storage device, executed by the processor, and then erased from RAM. When the power is turned off, RAM is erased.

**ROM: Read-Only Memory.** This is permanent program memory, used primarily for storing essential programs. Programs in ROM are never erased, so ROM is not reusable.

**Software:** Programs, languages, or routines that control the operations of a computer in solving a given problem.

**System Program:** A program which handles all of the overhead functions of computing, such as defining the keyboard, managing the peripherals, refreshing the display, etc. When the computer is turned on and passes its self-test, it immediately begins searching for a system program to boot.

**Stand-alone Program:** A program that has a "built-in" system program and can run without any underlying language support.



---

## Installing Add-on Accessories

Add-on accessories are devices that attach to your computer. They include backplane expanders, interfaces, video output cards, and other enhancements. If you ordered any at the time you purchased the computer, they will be assembled at the factory. If you purchased an accessory at a later date, you will have to install it yourself.

When finished with the installation of an accessory, place the *Installation Note* behind this page.

**52 Installing Add-on Accessories**

# HP 9000 System Support Log

## Introduction

Hello—Let me tell you a few things about this document.

Place this document behind the installation document that came with your system and keep the binder close to the system it is associated with. Use the spine that came with this system support log for the binder title. It contains information that will make your system more useful and productive with less down time if your system should ever require service.

This document has information about where and how to obtain service for hardware and/or software problems. It also contains information about your systems configuration, options, modifications, and repair/maintenance required. In other words, this is an historical document that contains information about the system it is prepared for and no other system.

Certain entries are left for you to make and maintain. Careful and accurate entries will save you time and frustration if service is required.

A system information page is shipped with the Computer for your system. Its color is blue and has some white labels affixed to it. These labels record the model and serial number for the computer and/or expander, plus it identifies the boards that were installed in the backplane at the factory. Be sure to enter the HP Maintenance Agreement Numbers on this page if you have an agreement with Hewlett-Packard. Place this page in the LOG book in front of the blue Peripheral page at the front of the Installation section.

The Peripheral page has spaces for you to enter some important information. Record the model number and serial number for each:

- Monitor
- Disc drive
- Graphics Hardware

And other Accessories that make up your system.

**2 HP 9000 Support Log**

**Notes**



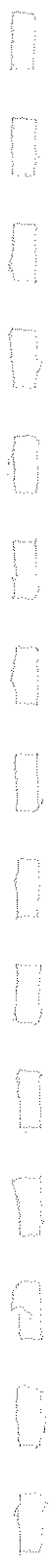

# Available Services

---

## Introduction

Available Services provides you, in one section, information that you will require if your system ever needs service, or you need assistance with your operating system software. This section has information about where and how to obtain service for hardware and/or software problems. The Local HEWLETT-PACKARD Representative card page has been cut so you can insert business cards in an appropriate slot. You then have a ready reference in case of need.

4 Services

Notes

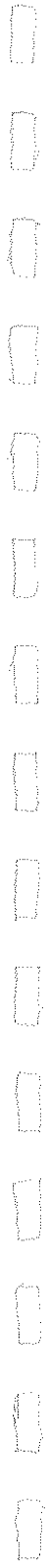

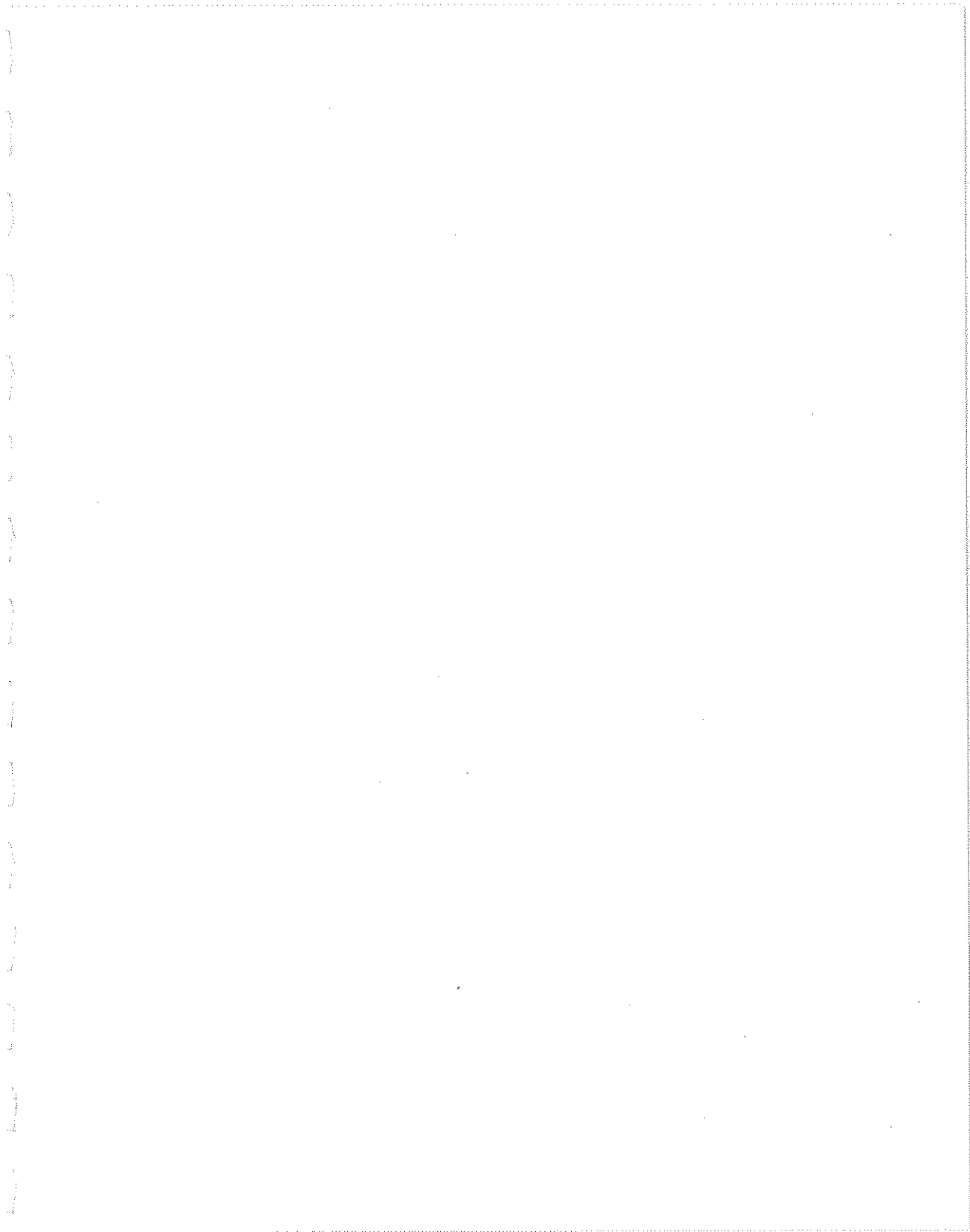

# Installation Record

## Introduction

Installation Records contain the information about your computer system configuration and options at time of installation. Certain entries are left for you to make and maintain. Careful and accurate entries will save you time and frustration if service is required.

A system information page is shipped with the Computer for your system. Its color is blue and has some white labels affixed to it. These labels record:

- The model and serial number for the computer and/or expander, plus
- The boards that were installed at the factory.

Be sure to enter the HP Maintenance Agreement Numbers on this page if you have an agreement with Hewlett-Packard. Place this page in the LOG book in front of the blue Accessory and Peripheral page and behind the Introduction page for the Available Services section.

The Accessory and Peripheral page has spaces for you to enter some important information. Record the model number and serial number for each:

- Monitor
- Disc drive
- Graphics Hardware

And other Accessories that make up your system.

**6 Installation Record**

**Notes**



# Peripheral Information

## Introduction

This page contains space for you to document additional information about the Computer system that you have just received. We at Hewlett-Packard believe this information will assist you if you ever require service or assistance.

Here are spaces for you to record the Model and Serial numbers of the peripherals that make up your system.

### Monitor

Model Number \_\_\_\_\_

Serial Number \_\_\_\_\_

### Peripherals

Keyboard: \_\_\_\_\_ Graphics Device: \_\_\_\_\_

Printer: \_\_\_\_\_ Device: \_\_\_\_\_

HP-HIL Device: \_\_\_\_\_ Device: \_\_\_\_\_

Disc Drive: \_\_\_\_\_ Device: \_\_\_\_\_

**8 Peripheral Information**

**Notes**





# Software Information

## Introduction

This page contains space for you to document additional information about your computer system. This information will be helpful if your computer system requires service or you need assistance.

### Software

HP Operating System: \_\_\_\_\_

HP Application Program: \_\_\_\_\_

Third Party Software: \_\_\_\_\_

• Supported By: \_\_\_\_\_

Locally Developed Software: \_\_\_\_\_

• Supported By: \_\_\_\_\_

### Additional

\_\_\_\_\_  
\_\_\_\_\_

## 10 Software Information

Notes

# Maintenance Record

## Introduction

Maintenance records are an important link in the maintenance and troubleshooting of computer products. Time and effort are saved whenever service or repair are required if records are kept of up-dates, modifications, and service performed. Careful Log entries will maintain the usefulness of this section.

Periodic Maintenance is not required on HP 9000 series computers, however, peripherals such as disc drives, printers, and plotters may need to be serviced periodically. With the help of your Hewlett-Packard CE, you can establish a periodic maintenance program using the Field Preventive Maintenance Procedure included here.

Included in this section is an instruction page that explains how to use the system historical record. Also included are several copies of the historical record sheet. This record sheet may be copied as needed.

Another form included here is the HP PICS Historical Record. Use this when you need assistance with a problem. Briefly describe the problem on the upper half of the form and call your nearest HP Sales and Service Office for assistance. The lower half will be filled out by your Hewlett-Packard CE. This will be a permanent record of that service. Again, you may copy this page as often as required.

## FIELD PREVENTIVE MAINTENANCE PROCEDURE

### INTRODUCTION

Often, the most common denominator associated with poorly performing systems is the lack of a sound preventive maintenance program. This section provides a convenient means of scheduling and logging P.M. activities.

"P.M.'s" are essential in obtaining a high on-the-air yield from complex systems and should be performed on a regularly scheduled basis. Specific instructions and methods of preventive maintenance may be found in the installation and service manual of each device. Blank "worksheets" have been provided that will enable you to consolidate each P.M. procedure into a yearly schedule of system maintenance. Your local HP Customer Engineer will assist you in planning and performing a P.M. program suited to your system.

Preventive Maintenance schedules must take into consideration the hours of operation and the environment of the system. Where conditions are more harsh, maintenance must be performed more frequently.

### MATERIALS COMMONLY NEEDED FOR PM

HP Products	
HP Part No.	Description
8500-0232	1 Aerosol Degreaser
6040-0222	2 Andoro Gear Lubricant
8520-0023	3 Applicators, Cotton Tipped
8520-0015	4 Brush, Acid
8500-1251	5 Freon Head Cleaner
8500-0039	6 Glass Cleaner, Anti Static
9301-0171	7 Hypodermic Syringe
9301-0172	8 Hypodermic Needle
8500-0559	9 Isopropyl Alcohol, Filtered
560A-95N-3	10 Lubricating Oil, Light
5080-3605	11 Slidewire Cleaner
5080-3635	12 Slidewire Lubricant
Commercial (Non-HP) Products	
Mfg. No. or Address	Description
	1. Cleaner Degreaser
Harrell Corp. "A" Div. So. Norwalk, Conn.	"Chemisol Formula 409"
Kelite Chemical Corp. 261 Hamilton Avenue Palo Alto, Calif.	"Spray-White"
Miller Stevenson Co. 1001 East 1st Street Los Angeles, Calif.	"Aero Dust" (MS-220)
Kimberly-Clark Corp. Nenah, Wisconsin	"Kim Wipe" (900-S) SN 3115
Crown Zellerbach Corp. 1 Bush Street San Francisco, Calif.	"Crown Chiffon" (No. 482)
	4. Tissues
	5. Tissues, Soft Facial

MONTH		1	2	3	4	5	6	7	8	9	10	11	12
PRODUCT													
TOTAL REQ'D. HRS.													
SCHEDULED DATE													
SCHEDULED TIME													
CE INITIAL													

PREVENTIVE MAINTENANCE TIMETABLE WORK SHEET



**On Site** Enter Date and Time of arrival on site.  
**CE/Tech** Enter initials of Person performing the repair.  
**CSO#** Enter Customer Service Order number.  
**Product#** Enter Product number.  
**Serial#** Enter Serial number of product.  
**Completed** Enter Date and Time repair is accomplished. If not accomplished, enter a note, or indicate time of next visit.  
**Problem** Give a description of the problem(s) found. Be as specific as Possible. Include what action was taken to eliminate problem(s). If not able to complete repair this visit, make a note of it.  
**Parts** Enter part numbers of all parts used in accomplishing the repair.

### Hewlett-Packard Entry

---

**HP notified** Enter date and time Hewlett-Packard was notified of the problem.  
**Found By** Enter name of person observing the symptom(s).  
**HP Contact** Enter the name of HP person contacted.  
**Symptom** Enter the symptom(s) observed. Be as specific as possible. If only happened once, so state. If a reoccurring problem give times and dates.

### Filling Out The System Maintenance Record Customer Entry

---

# System Maintenance Record

Customer Entry		H.P. Entry	
HP Notified	_____	On Site	Time
Found by	_____	CE/Tech#	GSO #
HP Contact	_____	Product	S/N
Symptom	_____	Completed	Problem
_____	_____	_____	_____
_____	_____	_____	_____
_____	_____	_____	_____
_____	_____	Parts	P/N
_____	_____	_____	P/N
_____	_____	_____	P/N
_____	_____	_____	P/N

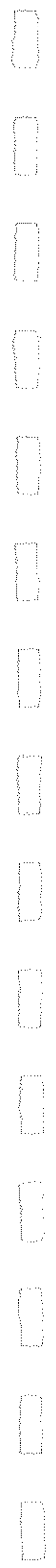







# System Maintenance Record

Customer Entry	H.P. Entry
HP Notified _____	On Site _____ Time _____
Found by _____	CE/Tech# _____ CSO # _____
HP Contact _____	Product _____ S/N _____
Symptom _____	Completed _____ Problem _____
_____	_____
_____	_____
_____	_____
_____	_____
_____	_____
_____	Parts _____
_____	P/N _____
_____	P/N _____
_____	P/N _____



**System Maintenance Record**

Customer Entry		H.P. Entry	
HP Notified	_____	On Site	_____ Time
Found by	_____	CE/Tech#	_____ CSO #
HP Contact	_____	Product	_____ S/N
Symptom	_____	Completed	_____ Problem
_____	_____	_____	_____
_____	_____	_____	_____
_____	_____	_____	_____
_____	_____	Parts	_____
_____	_____	P/N	_____ P/N
_____	_____	P/N	_____ P/N
_____	_____	P/N	_____ P/N



# System Maintenance Record

Customer Entry	H.P. Entry
HP Notified	On Site
Found by	CE/Tech#
HP Contact	Product
Symptom	Completed
_____	Problem
_____	_____
_____	_____
_____	_____
_____	_____
_____	_____
_____	Parts
_____	P/N
_____	P/N
_____	P/N



# System Maintenance Record

Customer Entry	H.P. Entry
HP Notified _____	On Site _____ Time _____
Found by _____	CE/Tech# _____ OSO # _____
HP Contact _____	Product _____ S/N _____
Symptom _____	Completed _____ Problem _____
_____	_____
_____	_____
_____	_____
_____	_____
_____	Parts _____
_____	P/N _____
_____	P/N _____
_____	P/N _____



# HP Pics Historical Record

Date \_\_\_\_\_ Time \_\_\_\_\_ Pics ID # \_\_\_\_\_

Problem Description: \_\_\_\_\_

\_\_\_\_\_

\_\_\_\_\_

\_\_\_\_\_

\_\_\_\_\_

HP Response: Date \_\_\_\_\_ Time \_\_\_\_\_ HP Contact \_\_\_\_\_

Problem Resolution: \_\_\_\_\_

\_\_\_\_\_

\_\_\_\_\_

\_\_\_\_\_

\_\_\_\_\_



## HP PICS Historical Record

Date \_\_\_\_\_ Time \_\_\_\_\_ PICS ID # \_\_\_\_\_

Problem Description: \_\_\_\_\_

\_\_\_\_\_

\_\_\_\_\_

\_\_\_\_\_

\_\_\_\_\_

HP Response: Date \_\_\_\_\_ Time \_\_\_\_\_ HP Contact \_\_\_\_\_

Problem Resolution: \_\_\_\_\_

\_\_\_\_\_

\_\_\_\_\_

\_\_\_\_\_

\_\_\_\_\_

# HP Pics Historical Record

Date \_\_\_\_\_ Time \_\_\_\_\_ Pics ID # \_\_\_\_\_

Problem Description: \_\_\_\_\_

\_\_\_\_\_

\_\_\_\_\_

\_\_\_\_\_

HP Response: Date \_\_\_\_\_ Time \_\_\_\_\_ HP Contact \_\_\_\_\_

Problem Resolution: \_\_\_\_\_

\_\_\_\_\_

\_\_\_\_\_

\_\_\_\_\_

\_\_\_\_\_

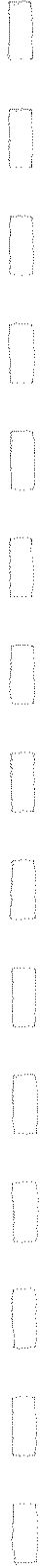

## HP PICS Historical Record

Date \_\_\_\_\_ Time \_\_\_\_\_ PICS ID # \_\_\_\_\_

Problem Description: \_\_\_\_\_

---

---

---

---

---

---

---

---

---

---

HP Response: Date \_\_\_\_\_ Time \_\_\_\_\_ HP Contact \_\_\_\_\_

Problem Resolution: \_\_\_\_\_

---

---

---

---

---

---

---

---

---

---



# Appendix

---

## Introduction

An appendix is a place to add supplementary or additional information that is useful. Use this section for keeping notes about this computer system, update notes, and other useful information.

Notes