



Agilent Technologies

Innovating the HP Way

June 8, 2000

Dear Customer,

As of November 1, 1999, four of Hewlett-Packard's businesses, test and measurement, semiconductor products, health care solutions, and chemical analysis became a new company, Agilent Technologies. Now, many of your Hewlett-Packard products and services are in the care of Agilent Technologies.

At Agilent Technologies, we are working diligently to make this transition as smooth as possible for you. However, as a result of this transition, the products and related documentation contained in this shipment may be labeled with either the Hewlett-Packard name and logo, the Agilent Technologies name and logo, or a combination of both. Information in this package may refer to Hewlett-Packard (HP), but applies to your Agilent Technologies product. Hewlett-Packard and Agilent branded products with the same model number are interchangeable.

Whatever logo you see, the information, products, and services come from the same reliable source.

If you have questions about Agilent Technologies products and services, please visit our website at <http://www.agilent.com>.

Sincerely,

Rebranding Team

HP E8285A CDMA Mobile Station Test Set

Application Guide

HP Part No. E8285-90019

Printed in U. S. A.

September 1999

Rev. B

Copyright © Hewlett-Packard Company 1999

Notice

Information contained in this document is subject to change without notice.

All Rights Reserved. Reproduction, adaptation, or translation without prior written permission is prohibited, except as allowed under the copyright laws.

This material may be reproduced by or for the U.S. Government pursuant to the Copyright License under the clause at DFARS 52.227-7013 (APR 1988).

Hewlett-Packard Company
Learning Products Department
24001 E. Mission
Liberty Lake, WA 99019-9599
U.S.A.

Manufacturer's Declaration

This statement is provided to comply with the requirements of the German Sound Emission Directive, from 18 January 1991. This product has a sound pressure emission (at the operator position) < 70 dB(A).

- Sound Pressure $L_p < 70$ dB(A).
- At Operator Position.
- Normal Operation.
- According to ISO 7779:1988/EN 27779:1991 (Type Test).

Herstellerbescheinigung

Diese Information steht im Zusammenhang mit den Anforderungen der Maschinenlärminformationsverordnung vom 18 Januar 1991.

- Schalldruckpegel $L_p < 70$ dB(A).
- Am Arbeitsplatz.
- Normaler Betrieb.
- Nach ISO 7779:1988/EN 27779:1991 (Typprüfung).

**Safety
Considerations**

GENERAL

This product and related documentation must be reviewed for familiarization with safety markings and instructions before operation.

This product has been designed and tested in accordance with *IEC Publication 1010*, "Safety Requirements for Electronic Measuring Apparatus," and has been supplied in a safe condition. This instruction documentation contains information and warnings which must be followed by the user to ensure safe operation and to maintain the product in a safe condition.

SAFETY EARTH GROUND

A uninterruptible safety earth ground must be provided from the main power source to the product input wiring terminals, power cord, or supplied power cord set.

CHASSIS GROUND TERMINAL

To prevent a potential shock hazard, always connect the rear-panel chassis ground terminal to earth ground when operating this instrument from a dc power source.

SAFETY SYMBOLS



Indicates instrument damage can occur if indicated operating limits are exceeded.



Indicates hazardous voltages.



Indicates earth (ground) terminal

WARNING

A WARNING note denotes a hazard. It calls attention to a procedure, practice, or the like, which, if not correctly performed or adhered to, could result in personal injury. Do not proceed beyond a WARNING sign until the indicated conditions are fully understood and met.

CAUTION

A CAUTION note denotes a hazard. It calls attention to an operation procedure, practice, or the like, which, if not correctly performed or adhered to, could result in damage to or destruction of part or all of the product. Do not proceed beyond a CAUTION note until the indicated conditions are fully understood and met.

Safety Considerations for this Instrument

WARNING

This product is a Safety Class I instrument (provided with a protective earthing ground incorporated in the power cord). The mains plug shall only be inserted in a socket outlet provided with a protective earth contact. Any interruption of the protective conductor inside or outside of the product is likely to make the product dangerous. Intentional interruption is prohibited..

Whenever it is likely that the protection has been impaired, the instrument must be made inoperative and be secured against any unintended operation.

If this instrument is to be energized via an autotransformer (for voltage reduction), make sure the common terminal is connected to the earth terminal of the power source.

If this product is not used as specified, the protection provided by the equipment could be impaired. This product must be used in a normal condition (in which all means for protection are intact) only.

No operator serviceable parts in this product. Refer servicing to qualified personnel. To prevent electrical shock, do not remove covers.

Servicing instructions are for use by qualified personnel only. To avoid electrical shock, do not perform any servicing unless you are qualified to do so.

The opening of covers or removal of parts is likely to expose dangerous voltages. Disconnect the product from all voltage sources while it is being opened.

Adjustments described in the manual are performed with power supplied to the instrument while protective covers are removed. Energy available at many points may, if contacted, result in personal injury.

The power cord is connected to internal capacitors that may remain live for 5 seconds after disconnecting the plug from its power supply.

For Continued protection against fire hazard, replace the line fuse(s) only with 250 V fuse(s) or the same current rating and type (for example, normal blow or time delay). Do not use repaired fuses or short circuited fuseholders.

WARNING:

Always use the three-prong ac power cord supplied with this product. Failure to ensure adequate earth grounding by not using this cord may cause product damage.

This product is designed for use in Installation Category II and Pollution Degree 2 per *IEC 1010* and *IEC 664* respectively. **FOR INDOOR USE ONLY.**

This product has autoranging line voltage input, be sure the supply voltage is within the specified range.

To prevent electrical shock, disconnect instrument from mains (line) before cleaning. Use a dry cloth or one slightly dampened with water to clean the external case parts. Do not attempt to clean internally.

WARNING:

Ventilation Requirements: When installing the product in a cabinet, the convection into and out of the product must not be restricted. The ambient temperature (outside the cabinet) must be less than the maximum operating temperature of the product by 4° C for every 100 watts dissipated in the cabinet. If the total power dissipated in the cabinet is greater than 800 watts, then forced convection must be used.

Product Markings

CE - the CE mark is a registered trademark of the European Community. A CE mark accompanied by a year indicated the year the design was proven.

CSA - the CSA mark is a registered trademark of the Canadian Standards Association.

Hewlett-Packard Warranty Statement for Commercial Products

HP E8285A CDMA
Mobile Station
Test Set

**Duration of
Warranty: 1 year**

1. HP warrants HP hardware, accessories and supplies against defects in materials and workmanship for the period specified above. If HP receives notice of such defects during the warranty period, HP will, at its option, either repair or replace products which prove to be defective. Replacement products may be either new or like-new.
2. HP warrants that HP software will not fail to execute its programming instructions, for the period specified above, due to defects in material and workmanship when properly installed and used. If HP receives notice of such defects during the warranty period, HP will replace software media which does not execute its programming instructions due to such defects.
3. HP does not warrant that the operation of HP products will be uninterrupted or error free. If HP is unable, within a reasonable time, to repair or replace any product to a condition as warranted, customer will be entitled to a refund of the purchase price upon prompt return of the product.
4. HP products may contain remanufactured parts equivalent to new in performance or may have been subject to incidental use.
5. The warranty period begins on the date of delivery or on the date of installation if installed by HP. If customer schedules or delays HP installation more than 30 days after delivery, warranty begins on the 31st day from delivery.
6. Warranty does not apply to defects resulting from (a) improper or inadequate maintenance or calibration, (b) software, interfacing, parts or supplies not supplied by HP, (c) unauthorized modification or misuse, (d) operation outside of the published environmental specifications for the product, or (e) improper site preparation or maintenance.
7. TO THE EXTENT ALLOWED BY LOCAL LAW, THE ABOVE WARRANTIES ARE EXCLUSIVE AND NO OTHER WARRANTY OR CONDITION, WHETHER WRITTEN OR ORAL IS EXPRESSED OR IMPLIED AND HP SPECIFICALLY DISCLAIMS ANY IMPLIED WARRANTIES OR CONDITIONS OR MERCHANTABILITY, SATISFACTORY QUALITY, AND FITNESS FOR A PARTICULAR PURPOSE.
8. HP will be liable for damage to tangible property per incident up to the greater of \$300,000 or the actual amount paid for the product that is the subject of the claim, and for damages for bodily injury or death, to the extent that all such damages are determined by a court of competent jurisdiction to have been directly caused by a defective HP product.

9. TO THE EXTENT ALLOWED BY LOCAL LAW, THE REMEDIES IN THIS WARRANTY STATEMENT ARE CUSTOMER'S SOLE AND EXCLUSIVE REMEDIES. EXCEPT AS INDICATED ABOVE, IN NO EVENT WILL HP OR ITS SUPPLIERS BE LIABLE FOR LOSS OF DATA OR FOR DIRECT, SPECIAL, INCIDENTAL, CONSEQUENTIAL (INCLUDING LOST PROFIT OR DATA), OR OTHER DAMAGE, WHETHER BASED IN CONTRACT, TORT, OR OTHERWISE.

FOR CONSUMER TRANSACTIONS IN AUSTRALIA AND NEW ZEALAND: THE WARRANTY TERMS CONTAINED IN THIS STATEMENT, EXCEPT TO THE EXTENT LAWFULLY PERMITTED, DO NOT EXCLUDE RESTRICT OR MODIFY AND ARE IN ADDITION TO THE MANDATORY STATUTORY RIGHTS APPLICABLE TO THE SALE OF THIS PRODUCT TO YOU.

ASSISTANCE

Product maintenance agreements and other customer assistance agreements are available for Hewlett-Packard products. For any assistance, contact your nearest Hewlett-Packard Sales and Service Office.

DECLARATION OF CONFORMITY

according to ISO/IEC Guide 22 and EN 45014

Manufacturer's Name: **Hewlett-Packard Co.**

Manufacturer's Address: **Spokane Division
24001 E. Mission Avenue
Liberty Lake, Washington 99019-9599
USA**

declares that the product

Product Name: CDMA Mobile Station Test Set

Model Number: HP E8285A

Product Options: All

conforms to the following Product specifications:

Safety: IEC 61010-1:1990+A1+A2 / EN 61010-1:1993+A2

EMC: CISPR 11:1990 / EN 55011:1991- Group 1, Class A
IEC 61000-3-2:1995 / EN 61000-3-2:1995
IEC 61000-3-3:1995 / EN 61000-3-3:1994

EN 50082-1 : 1992

IEC 801-2:1991 - 4kV CD, 8kV AD

IEC 801-3:1984 - 3 V/m

IEC 801-4:1988 - 0.5 kV Signal Lines,
1 kV Power Lines

Supplementary Information:

This product herewith complies with the requirements of the Low Voltage Directive 73/23/EEC and the EMC Directive 89/336/EEC and carries the CE-marking accordingly.

Spokane, Washington USA June 16, 1999



Vince Roland
Reliability & Regulatory
Engineering Manager

European Contact: Your local Hewlett-Packard Sales and Service Office or Hewlett-Packard GmbH
Department ZO/Standards Europe, Herrenberger Strasse 130, D-71034 Böblingen, Germany (FAX+49-7031-14-3143)

Contents

Calibrating the Test Set

Calibration Procedures	14
Calibrating CDMA Channel Levels (PCB Cal)	16
Calibrating Channel Power Measurements	20
Zeroing Average Power Measurements	24
Correcting for RF Path Loss.....	29
Determining RF Path Loss	33

Setting Up a Call

Steps for Setting Up a Call.....	46
Problem Solving	55

CDMA Receiver Tests

Measuring Demodulation of Forward Traffic Channel with AWGN.....	60
Measuring Receiver Sensitivity and Dynamic Range.....	75
Measuring Single Tone Desensitization.....	88
Measuring Intermodulation Spurious Response Attenuation.....	105
Measuring Demodulation of Non-Slotted Mode Paging Channel in AWGN.....	118

CDMA Transmitter Tests

Measuring Waveform Quality	130
Measuring Minimum/Maximum Power.....	139
Measuring Maximum RF Output Power	143
Measuring Minimum Controlled Output Power	153
Measuring the Range of Open Loop Output Power	164
Measuring Access Probe Output Power.....	175

CDMA to Analog Handoff

Performing a CDMA to Analog Handoff.....	190
--	-----

Authentication Tests

Initializing SSD to Zero	201
Updating SSD.....	209

Contents

Performing a Unique Challenge-Response	216
Short Message Service Tests	
Sending Short Messages on the Paging/Access Channels	225
Sending Short Messages on the Traffic Channels.....	233
Establishing HP-IB Communication	
Setting Up HP-IB Control.....	242
Using the Analog Call Processing Subsystem	
Description of the Analog Call Processing Subsystem.....	248
Using Manual (Front-Panel) Control	252
Description of the Call Processing Subsystem's Remote User Interface.....	258
Using Remote (HP-IB) Control	260
Using the CALL CONTROL Screen to Test Call Processing Functions	267
Using the CALL CONTROL Screen to test AMPS Authentication.....	277
Using the CALL DATA Screen.....	289
Using the CALL BIT Screen	296
Using the ANALOG MEAS Screen	301
Protocol Logging	
Hardware and Software Requirements	307
Connecting the Test Set to the Computer.....	309
Setting Up the Communications Package.....	311
Logging Protocol Messages	314
Control Commands for Protocol Logging	317
Increasing Measurement Throughput	
Paging un-registered mobile stations	322
Performing Transmitter and Receiver testing concurrently	331
Minimizing bus configuration time.....	334
Reducing delays caused by unused measurements	336
Reducing delays caused by screen changes	337
Reducing measurement setup time	338

Calibrating the Test Set

Calibration Procedures

The list below shows all of the calibration procedures that must be performed periodically when testing CDMA mobile stations with the Test Set.

"Calibrating CDMA Channel Levels (PCB Cal)" on page 16

"Calibrating Channel Power Measurements" on page 20.

"Zeroing Average Power Measurements" on page 24.

"Correcting for RF Path Loss" on page 29.

"Determining RF Path Loss" on page 33.

Guidelines:

"Recommended Periodic Calibration Procedures:" on page 15 provides a checklist of calibration procedures for various events that could affect the performance of the Test Set.

Guidelines include:

- After **"Calibrating CDMA Channel Levels (PCB Cal)" on page 16** (also known as "PCB CAL") is performed, you must then perform **"Calibrating Channel Power Measurements" on page 20.**
- It is *highly* recommended that **"Correcting for RF Path Loss" on page 29**, for both the forward and reverse channels, be performed before using the Test Set to make measurements. This procedure eliminates the need for adding level offsets to your test code, and extends the Test Set's operating range with some mobile stations.
- A 30-minute warm-up period is recommended to allow the Test Set to reach a stable operating temperature.

Recommended Periodic Calibration Procedures:

	"Calibrating CDMA Channel Levels (PCB Cal)" on page 16	"Calibrating Channel Power Measurements" on page 20	"Zeroing Average Power Measurements" on page 24
When Test Set is being used for the first time (allow 30-minute warmup period).	✓	✓	✓
After extended power off cycle (allow 30-minute warmup period).		✓	
After firmware is upgraded	✓	✓	
When the "Uncal" light is flashing			
Before making an Average Power measurement			✓
If the RF connections to the PCS interface are adjusted.		✓	
If the ambient temperature changes more than 5 degrees C since latest calibration	✓	✓	
Ram Initialization	✓	✓	✓
Every month	✓		

Calibrating CDMA Channel Levels (PCB Cal)

Approximate time: 8 minutes

The Test Set optimizes the level accuracy of CDMA code channels and the AWGN (Additive White Gaussian Noise) generator by measuring the analog I/Q signals on an internal DSP-based voltmeter. Level correction factors are generated by a ROM-based program named PCB_CAL and are applied to gain control DACs, which control the fine level adjustment in the amplitude scaling path.

Calibrated channel power provides accurate values for E_b/N_t , the ratio between Traffic channel power and AWGN. It is critical that these levels remain accurate. A level accuracy error of 0.8 dB could alter FER from 0.5% to 5%.

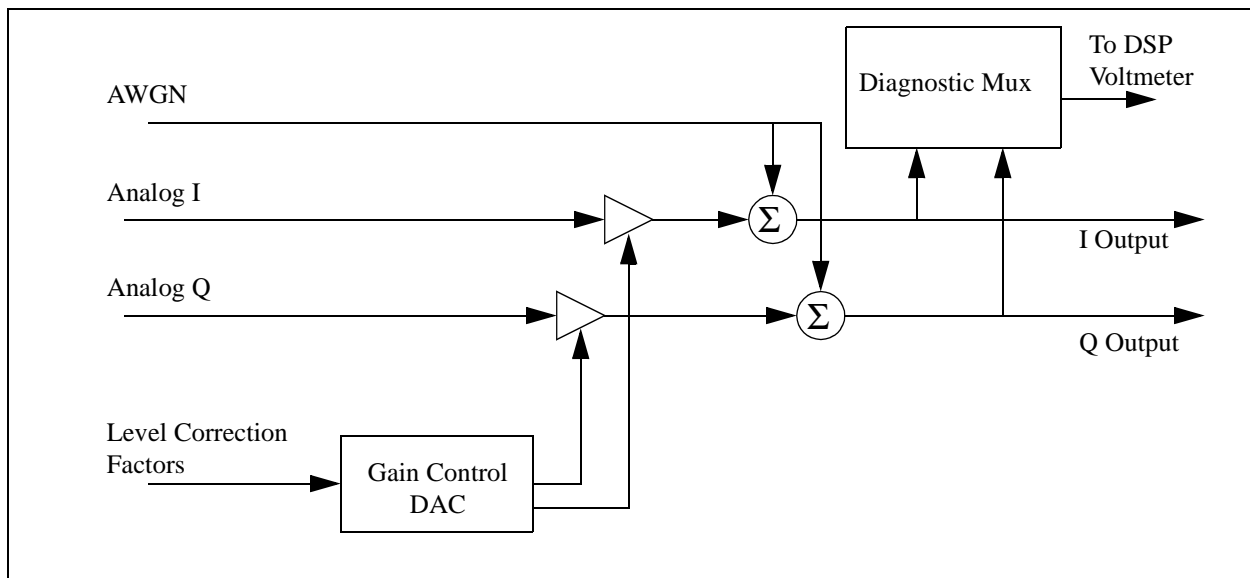

Procedure Overview

For detailed step-by-step explanation see the page associated with the step.

1. "Load the PCB_CAL procedure." on page 17.
2. "Lower the Test Set's output power if necessary." on page 26.
3. "Select the Average Power measurement." on page 27.

1. Load the PCB_CAL procedure.

Manual Operation:

1. Press the Tests key.
2. Select ROM from the list of choices for the Select Procedure Location field.
3. Select PCB_CAL from the list of choices for the Select Procedure Filename field.

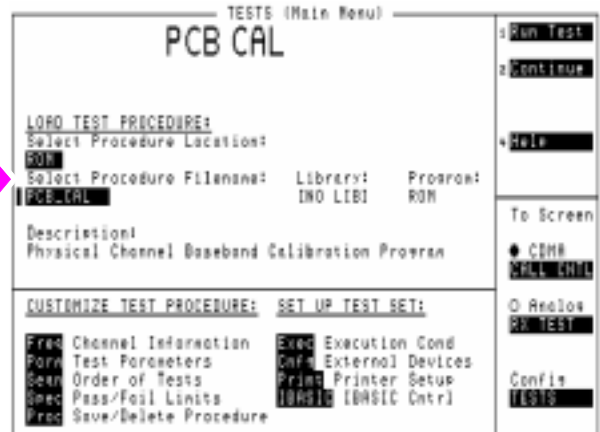

The TESTS (Main Menu) screen provides access to the Test Set's internal IBASIC controller. You can load, run, and customize procedures on this screen.

HP-IB Syntax

"DISP TEST" ! displays the TESTS (Main Menu) screen.

"TEST:PROC:LOC 'ROM'" ! selects ROM as the test procedure location.

"TEST:PROC:NAME 'PCB_CAL'" !selects the file named "PCB_CAL"

2. Remove power from the ANTENNA IN port.

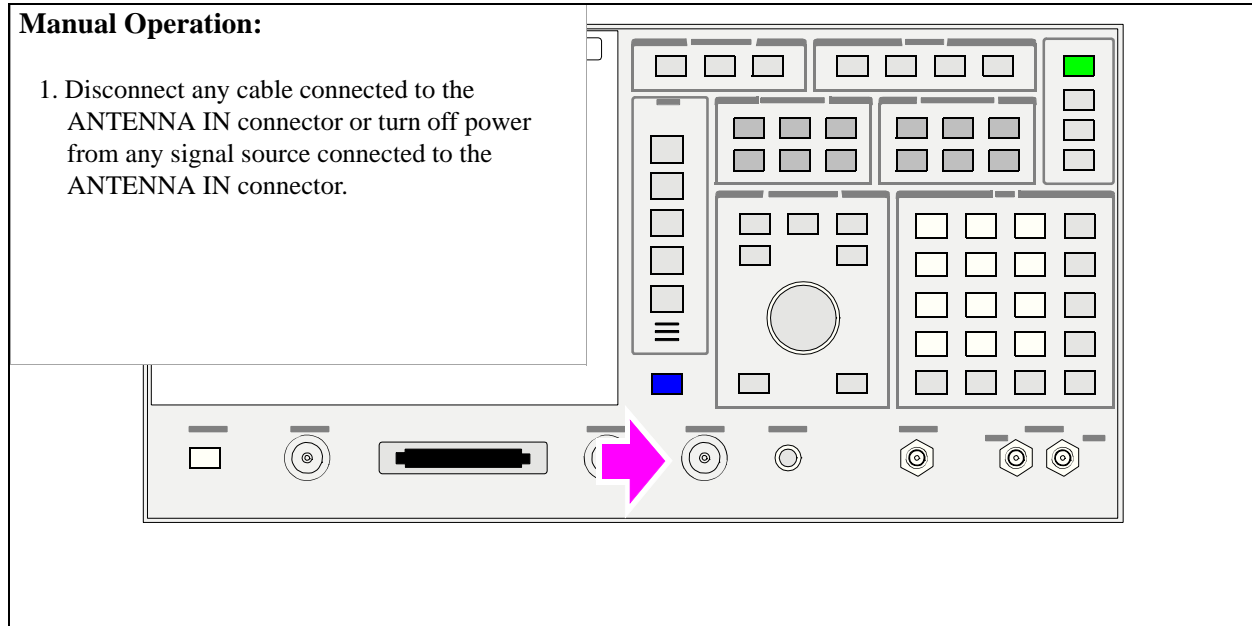

3. Run the PCB_CAL Procedure.

Manual Operation:

1. Position the cursor next to the Run Test field.
2. Press the knob.
3. When the PCB_CAL procedure has completed, cycle power.

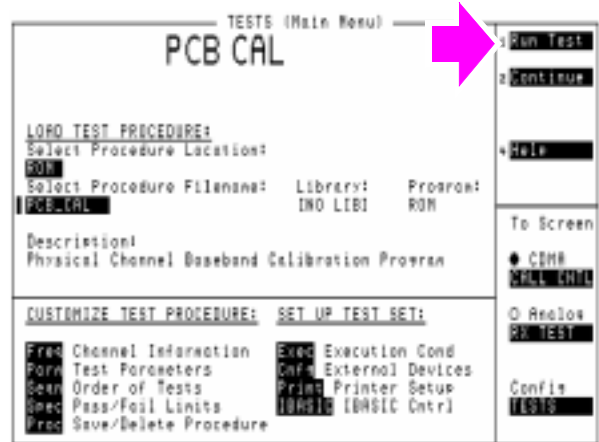

At the beginning of the procedure, the Test Set will beep and the message "Direct latch write occurred. Cycle power when done servicing" will appear. This is normal.

During this procedure the display will show cal factors for I and Q channels on the screen. When the calibration procedure has completed, the message "Cycle instrument power to restore test set to normal operating conditions" will be displayed at the top of the screen. Cycle power using the front panel POWER key, or send the `SYSTEM:REStart` command shown below.

The PCB_CAL procedure will run for about 8 minutes unless a failure occurs. If a failure occurs, the program will stop, bit 8 in the Calibration Status Register will be set true, and the Test Set will display "PCB CAL UNSUCCESSFUL".

HP-IB Syntax

`"TEST:PROC:RUN"` !starts the PCB Cal routine

`"STATus:OPERation:CONDition"` !queries the Operation Status Register. If the PCB Cal procedure is still running, bit 14 (IBASIC Program Running) will be set true.

`"STATus:CALibration:EVENT?"` !queries the Calibration Status Register. If the PCB Cal procedure failed, bit 8 will be set true.

`"SYSTEM:REStart"` !re-boots the Test Set (can be performed in place of cycling power)

Calibrating Channel Power Measurements

The time period for calibrating channel power measurements depends on the span of frequencies selected. A message will be displayed to let the user know how long the procedure will take.

The Test Set can be configured to limit calibration to specific bands, calibrate all bands, or calibrate the frequency range corresponding with designated RF channel standards (for example, Japan CDMA).

Average Power measurements are zeroed as part of the Channel Power calibration process.

Procedure Overview

For detailed step-by-step explanation see the page associated with the step.

1. **"Configure the Test Set to calibrate alternate frequency bands. (Optional)" on page 21**
2. **"Select the Channel Power or Access Probe Power measurement." on page 22.**
3. **"Calibrate the Channel Power measurement." on page 23.**

1. Configure the Test Set to calibrate alternate frequency bands. (Optional)

Manual Operation:

1. Press the Config key to display the CONFIGURE screen.
2. Position the cursor in front of Alt Pwr Ms Cal Bands field. Press the knob and select the additional channel standard or complete cellular band for channel power measurement calibration.

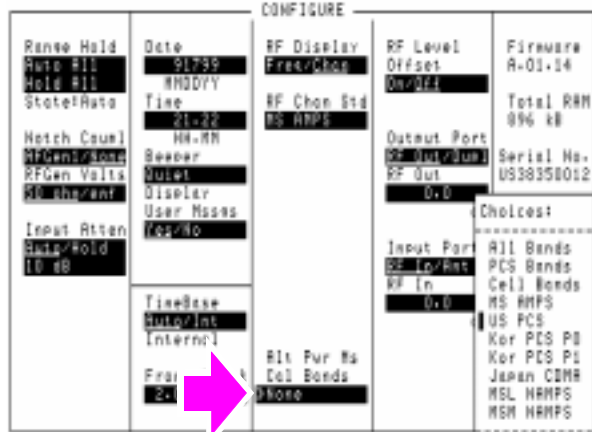

Channel Power Calibration will be performed over the frequency bands included in the RF Chan Std and the Alt Pwr Ms Cal Bands field selections. Adding an alternate channel standard or band will increase the time required for the Test Set to perform Channel Power Calibration.

2. Select the Channel Power or Access Probe Power measurement.

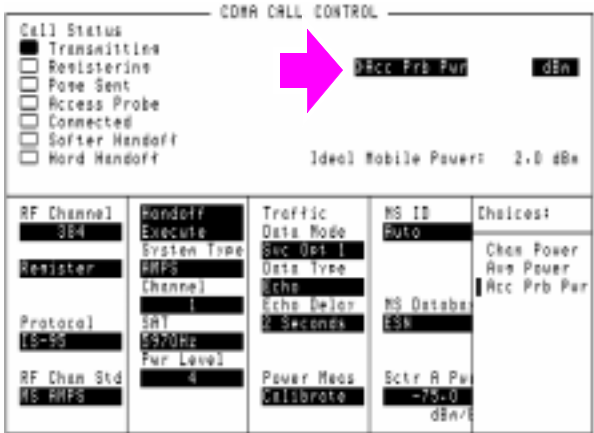
<p>Manual Operation:</p> <ol style="list-style-type: none"> 1. Position the cursor next to the field that displays Avg Power, Acc Prb Pwr, or Chan Power. This field is found on the CDMA CALL CONTROL, CDMA CELLULAR MOBILE TRANSMITTER TEST, and CDMA TRANSMITTER POWER RANGE TEST screens. 2. Make sure Chan Power or Acc Prb Pwr is selected. 		
--	---	--

HP-IB Syntax

"CDMA:TX:POW:MEAS 'Chan Power'" selects Channel Power measurements.

3. Calibrate the Channel Power measurement.

Manual Operation:

1. Position the cursor next to the Power Meas field.
2. Press the knob.

The Test Set will display "Cal takes about X minutes. Continue?"

3. Press the Yes key.

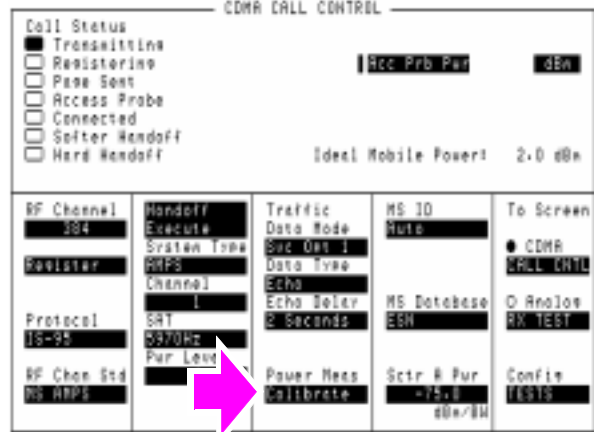

Calibration may take a minute or longer, depending on the RF Channel Std and Alt Chn Std field settings. If you are performing calibration using the HP-IB command below, be aware that the Test Set will accept (handshake) HP-IB commands during the calibration routine, but none of these "buffered" HP-IB command functions will be executed until channel power calibration is complete.

HP-IB Help

During the channel power calibration firmware routine, the Test Set will not respond to HP-IB queries. To determine when this procedure is done, query the Calibrating status register. When calibration has completed, the Test Set will return a value with bit 0 and bit 1 set true.

If your controlling application has an I/O timeout enabled make sure that sufficient time is given for the Test Set to complete calibration and provide a query response in its output queue. Or, disable the timeout during channel power calibration.

HP-IB Syntax

"MEAS:CDM:CHAN:CAL" !calibrates Channel Power measurements.

"STAT:OPER:CAL:EVENT?" !queries the Calibrating Status Event Register. Bit 1 is the channel power calibration bit.

Zeroing Average Power Measurements

Approximate length of time: 2 seconds

Average Power measurements should be zeroed before each measurement or series of measurements.

NOTE:

*A misleading Average Power measurement may appear when low (or no) signal power is applied to the RF Input! When the RF generator's output port selection is **RF IN/OUT**, some of the signal energy from the Test Set's generator is detected by the Test Set's broadband average power meter. This condition does not affect typical CDMA measurements for two reasons: 1) During Average Power measurements CDMA generator levels are too low to introduce significant energy to the power detector. 2) When the generator level is high enough to introduce significant energy to the power detector, the mobile station's signal power should be within the range of Channel Power measurements. Channel power measurements are frequency-selective, and do not detect significant energy from the Test Set's generator, which is tuned 45 MHz away from the analyzer.*

Procedure Overview

For detailed step-by-step explanation see the page associated with the step.

1. ["Remove power from the RF IN/OUT connector." on page 25.](#)
2. ["Lower the Test Set's output power if necessary." on page 26.](#)
3. ["Select the Average Power measurement." on page 27.](#)
4. ["Zero the Average Power measurement." on page 28.](#)

1. Remove power from the RF IN/OUT connector.

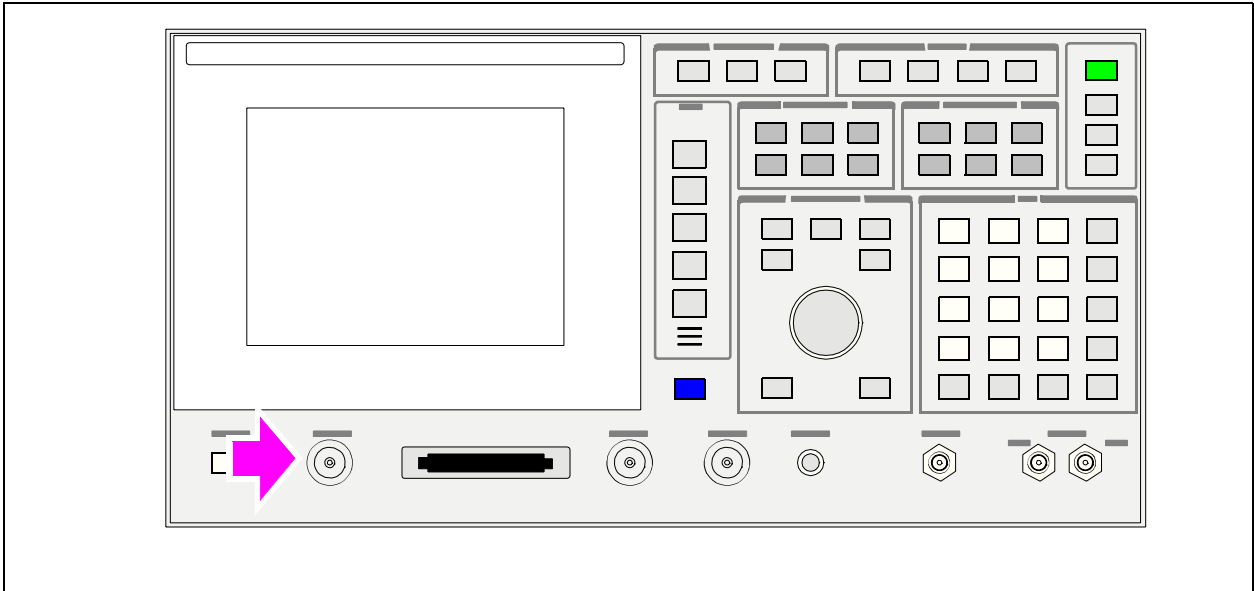

2. Lower the Test Set's output power if necessary.

Manual Operation:

1. Press the Preset key, which will set RF Power to a level that will not degrade Average Power zeroing, or turn off all sources as follows:
 - 1a. Press the Gen Control key to display the CDMA GENERATOR CONTROL screen.
 - 1b. Turn off Sector A Power, Sector B Power, and AWGN (by pressing the ON/OFF key on the Test Set's front panel).

Turning off power from the CDMA generators will prevent power from cross-coupling internally to the RF IN/OUT path during Average Power measurement zeroing.

*Presetting the test Set (*RST HP-IB command) will turn off Sector B and AWGN, and will lower Sector A Power to a level that will not affect zeroing the Average Power measurement, making it unnecessary to turn Sector A Power off.*

HP-IB Syntax

```
"CDMA:CELL:ASEC:STAT OFF" !turns off Sector A Power
"CDMA:CELL:BSEC:STAT OFF" !turns off Sector B Power
"CDMA:AWGN:STAT OFF" !turns off AWGN
```

3. Select the Average Power measurement.

Manual Operation:

1. Press the CDMA SCREENS - Tx test key to display the CDMA CELLULAR MOBILE TRANSMITTER TEST screen.
2. Position the cursor next to the field as shown.
3. Press the knob to select the Choices menu.
4. Select Avg Power from the list.

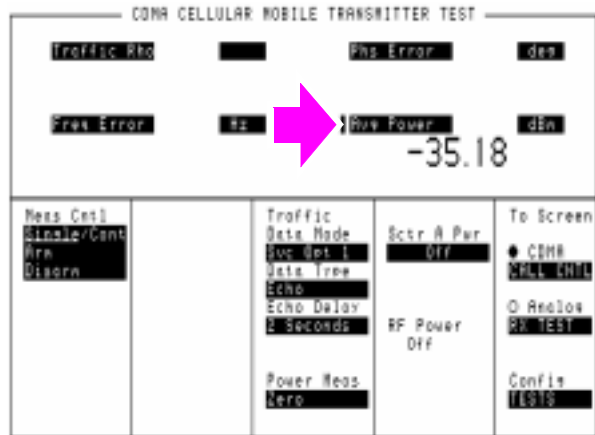

HP-IB Syntax

"CDMA:TX:POW:MEAS 'Avg Power'" selects Average Power measurements.

4. Zero the Average Power measurement.

Manual Operation:

1. Press the CDMA SCREENS - Tx test key to display the CDMA CELLULAR MOBILE TRANSMITTER TEST screen.
2. Position the cursor next to the Zero field.
3. Press the knob.

Zeroing Average Power takes approximately two seconds.

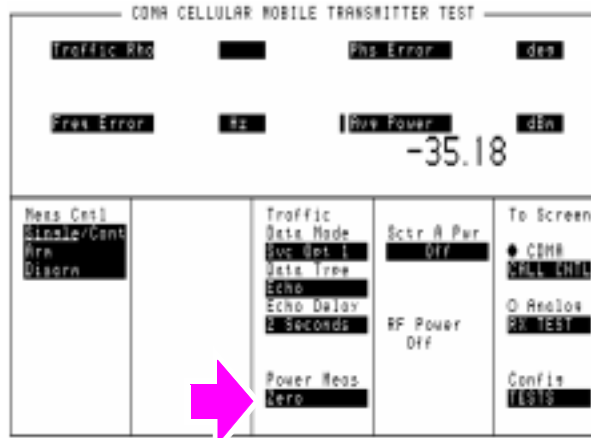

If RF power was not lowered as shown in step 2, the Test Set will display "Zero degraded. Reduce generator level for best results".

HP-IB Syntax

"MEAS:CDM:AVGP:ZERO" ! zeroes the average power meter.

Correcting for RF Path Loss

Approximate time: N/A (this procedure is simply a field entry).

The Test Set provides fields to enter independent path loss values for the forward and reverse channels to compensate for the differences in frequency response.

The settings you make in the following procedure must be re-entered after a power-cycle, instrument preset, or HP-IB reset (*RST).

It is *highly* recommended that RF path loss is corrected for in the following manner.

NOTE:

The Test Set's attenuator auto-ranging algorithm, used for adjusting gain in the RF analyzer path, estimates the expected power level from the phone using the open loop power control formula. External path loss, entered in the procedure below, is used by the auto-ranging algorithm to ensure the analyzer is not overdriven or underdriven.

Procedure Overview

For detailed step-by-step explanation see the page associated with the step.

1. **"Enter the forward channel path loss from the Test Set to the MSUT." on page 30.**
2. **"Enter the reverse channel path loss from the Test Set to the MSUT." on page 31.**
3. **"Turn on RF Level Offset." on page 32.**

1. Enter the forward channel path loss from the Test Set to the MSUT.

If you do not know the path loss for your connecting hardware, see "[Determining RF Path Loss](#)" on page 33

<p>Manual Operation:</p> <ol style="list-style-type: none"> 1. Press the Config key to display the CONFIGURE screen. 2. Position the cursor in front of the selected Output Port field (Duplex Out or RF Out) and enter a value for RF path loss. 	
--	--

Example: If the measured loss is 2 dB, and RF Out is selected in the Output Port field, enter -2 dB in the RF Out field. When the RF Level Offset is turned on, the displayed Sector A, Sector B, AWGN, and RF Power outputs will be decreased by 2 dB. No actual level changes occur as a result of turning on RF Level Offset.

2. Enter the reverse channel path loss from the Test Set to the MSUT.

If you do not know the path loss for your connecting hardware, see "[Determining RF Path Loss](#)" on page 33

Manual Operation:

1. Position the cursor in front of the selected Input Port field (RF In or Antenna In) and enter a value for RF path loss.

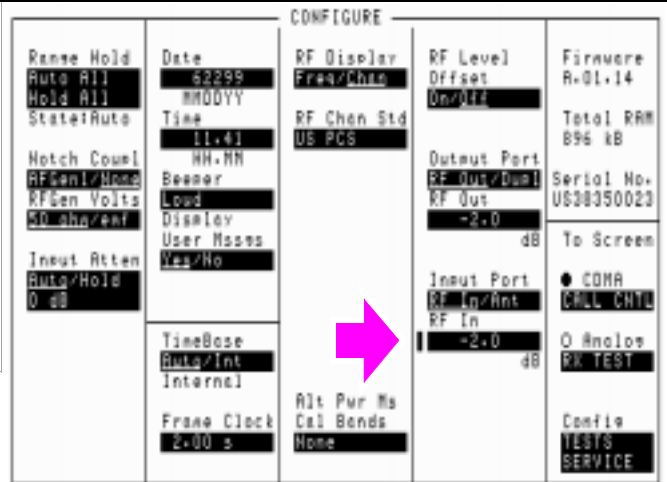

Example: If the measured loss is 2 dB, and RF In is selected in the Input Port field, enter -2 dB in the RF In field. When the RF Level Offset is turned on, the displayed Average, Access Probe, or Channel Power measurement will be increased by 2 dB.

3. Turn on RF Level Offset.

Manual Operation:

1. Position the cursor at the RF Level Offset field.
2. Select "On" to correct for RF path loss.

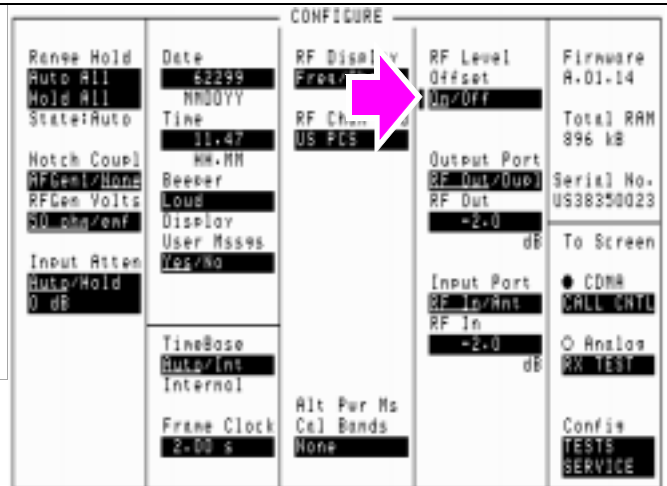

Determining RF Path Loss

The following procedure describes how to use the Test Set's signal generator and analyzer to determine path loss.

NOTE:

The Test Set's attenuator auto-ranging algorithm, used for adjusting gain in the RF analyzer path, estimates the expected power level from the phone using the open loop power control formula. External path loss, entered in the procedure below, is applied to the auto-ranging algorithm to ensure the analyzer is not overdriven or underdriven.

Procedure Overview

For detailed step-by-step explanation see the page associated with the step.

1. **"Procedure Prerequisites" on page 34.**
2. **"Configure the Test Set to be tuned to a frequency." on page 35.**
3. **"Configure the Test Set for RF loopback." on page 36.**
4. **"Connect a reference cable." on page 37.**
5. **"Enter a forward or reverse channel frequency value." on page 38.**
6. **"Set a 0 dBm reference for the path loss measurement." on page 39.**
7. **"Enter the CDMA forward or reverse channel path loss." on page 42.**

1. Procedure Prerequisites

User-supplied reference cabling, including:

- (2) 3 dB Attenuators
- (2) Cable Adapters
- (1) Low-loss cable

The reference cabling will connect the Test Set's RF output to RF input for the purpose of making a reference measurement. The addition of the 3 dB attenuators minimizes the effects of VSWR during the path loss measurement.

Zero the Tx Power measurement

1. Remove power from the RF IN/OUT and ANTENNA IN connectors.
2. Press the ANALOG SCREENS TX test key to display the TX TEST screen.
3. Position the cursor in front of the TX Pwr Zero field.
4. Press the knob.

2. Configure the Test Set to be tuned to a frequency.

Manual Operation:

1. Press the UTILITIES Config key to display the CONFIGURE screen.
2. Position the cursor at the RF Display field.
3. Select Freq by pressing the knob to toggle the underlined selection.
4. Position the cursor at the RF Offset field.
5. Select Off by pressing the knob to toggle the underlined selection.

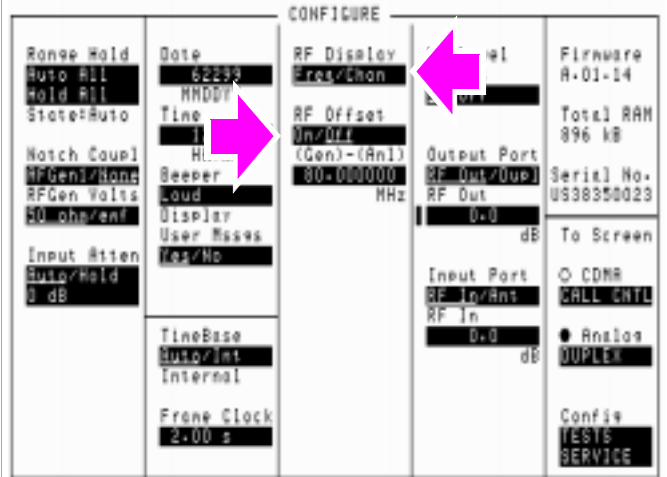

3. Configure the Test Set for RF loopback.

<p>Manual Operation:</p> <ol style="list-style-type: none">1. Position the cursor at the Output Port field.2. Select <u>Dupl</u> by pressing the knob to toggle the underlined selection.3. Position the cursor at the Input Port field.4. Select <u>RF In</u>.	<table border="1"><thead><tr><th colspan="5">CONFIGURE</th></tr></thead><tbody><tr><td>Range Hold Auto All Hold All State:Auto</td><td>Date 52299 MMDDYY Time 12.58 HH:MM</td><td>RF Display Erag/Chan</td><td>RF Level Offset On/Off</td><td>Firmware A-01.14</td></tr><tr><td>Notch Coupl RFGen/None RFGen Volts 50.0ah/ent</td><td>Beeper Low</td><td>RF Offset On/Off</td><td>Output Port RF Out/Dupl</td><td>Total RAM 896 kB</td></tr><tr><td>Input Atten Auto/Hold 0 dB</td><td>Display User Names Yes/No</td><td>IGen 00.</td><td>Duplex Out 0.0 dB</td><td>Serial No. US38350023</td></tr><tr><td></td><td>TimeBase Auto/Int Internal</td><td></td><td>Input Port RF In/Ant RF In 0.0 dB</td><td>To Screen O COMA CALL CNTL</td></tr><tr><td></td><td>Frame Clock 2.00 s</td><td></td><td></td><td>• Analog DUPLX</td></tr><tr><td></td><td></td><td></td><td></td><td>Cont'd TESTS SERVICE</td></tr></tbody></table>	CONFIGURE					Range Hold Auto All Hold All State:Auto	Date 52299 MMDDYY Time 12.58 HH:MM	RF Display Erag/Chan	RF Level Offset On/Off	Firmware A-01.14	Notch Coupl RFGen/None RFGen Volts 50.0ah/ent	Beeper Low	RF Offset On/Off	Output Port RF Out/Dupl	Total RAM 896 kB	Input Atten Auto/Hold 0 dB	Display User Names Yes/No	IGen 00.	Duplex Out 0.0 dB	Serial No. US38350023		TimeBase Auto/Int Internal		Input Port RF In/Ant RF In 0.0 dB	To Screen O COMA CALL CNTL		Frame Clock 2.00 s			• Analog DUPLX					Cont'd TESTS SERVICE
CONFIGURE																																				
Range Hold Auto All Hold All State:Auto	Date 52299 MMDDYY Time 12.58 HH:MM	RF Display Erag/Chan	RF Level Offset On/Off	Firmware A-01.14																																
Notch Coupl RFGen/None RFGen Volts 50.0ah/ent	Beeper Low	RF Offset On/Off	Output Port RF Out/Dupl	Total RAM 896 kB																																
Input Atten Auto/Hold 0 dB	Display User Names Yes/No	IGen 00.	Duplex Out 0.0 dB	Serial No. US38350023																																
	TimeBase Auto/Int Internal		Input Port RF In/Ant RF In 0.0 dB	To Screen O COMA CALL CNTL																																
	Frame Clock 2.00 s			• Analog DUPLX																																
				Cont'd TESTS SERVICE																																



4. Connect a reference cable.

Manual Operation:

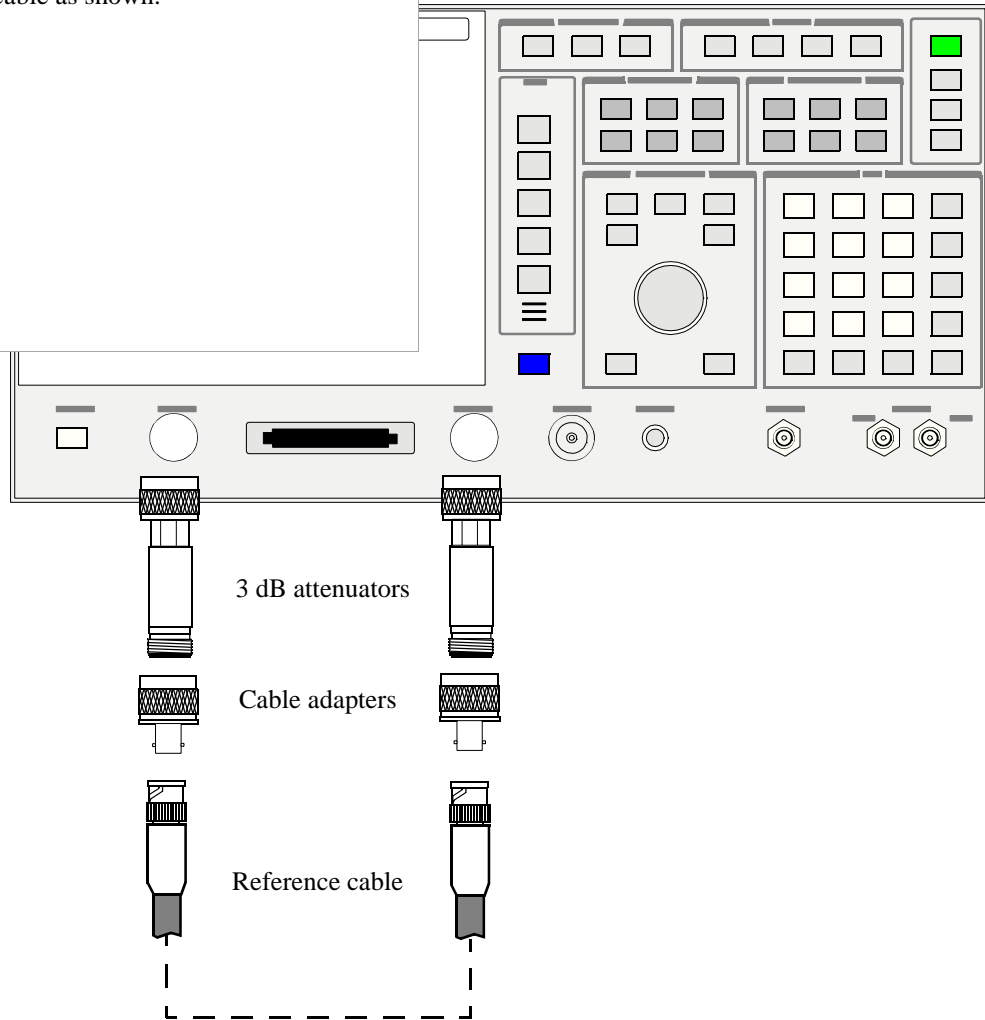
1. Connect cable as shown.



5. Enter a forward or reverse channel frequency value.

<p>Manual Operation:</p> <ol style="list-style-type: none"> 1. Press the ANALOG SCREENS - Duplex key to display the DUPLEX TEST screen. 2. Position the cursor at the Tune Freq field. 3. Set the value to the CDMA mobile station's forward or reverse channel frequency.  4. Position the cursor at the RF Gen Freq field.  5. Set the value to the CDMA mobile station's forward or reverse channel frequency. <p>The Tune Freq and RF Gen Freq fields should now be set to the same frequency.</p>	DUPLEX TEST				
	Freq Error kHz -----		AC Level V 0.00058		
	TX Power W 0.00000		SINAD dB 8 0.17 24		
	Tune Freq MHz 881.520000	RF Gen Freq MHz 881.520000	Freq kHz 00	RF Anl In Audio In	To Screen <input type="radio"/> CDMA <input type="radio"/> CALL CTRL <input checked="" type="radio"/> Analog DUPLEX
	Input Port RF In/Ant	Amplitude dBm -30.0	Anl To FM Off	Filter 1 50Hz HPF	<input type="radio"/> Confir <input type="radio"/> TESTS
IF Filter 15 kHz	Atten Hold On/Off	FM Coupling AC/DC	Filter 2 15kHz LFP		
	Output Port RF Out/Quasi	Audio Out AC/DC	De-Emphasis 750 us/Off		
		Detector RMS			

6. Set a 0 dBm reference for the path loss measurement.

- Manual Operation:**
1. Position the cursor at the Amplitude field.
 2. Set the value to 0 dBm with the DATA keys.
 3. Position the cursor at the Tx Power units-of-measure field.
 4. Turn on the Tx Power measurement.
 5. With the cursor positioned at the units-of-measure field for the TX power measurement, press the dBm key.
 6. Press SHIFT and release the SHIFT key, followed by the $\text{INCR} \div 10$ key (Ref set).
 8. Press the knob. The "Ref" annunciator should appear, indicating that a reference value has been set. The TX Power measurement should be close to 0.01 dBm.

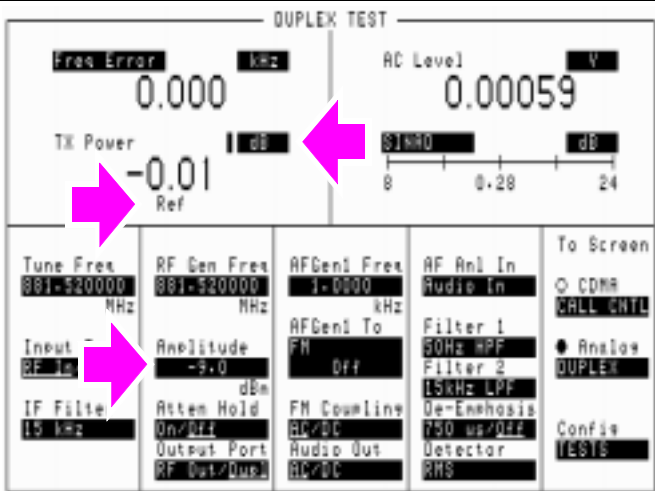

7. Connect the cable and hardware being measured for path loss.

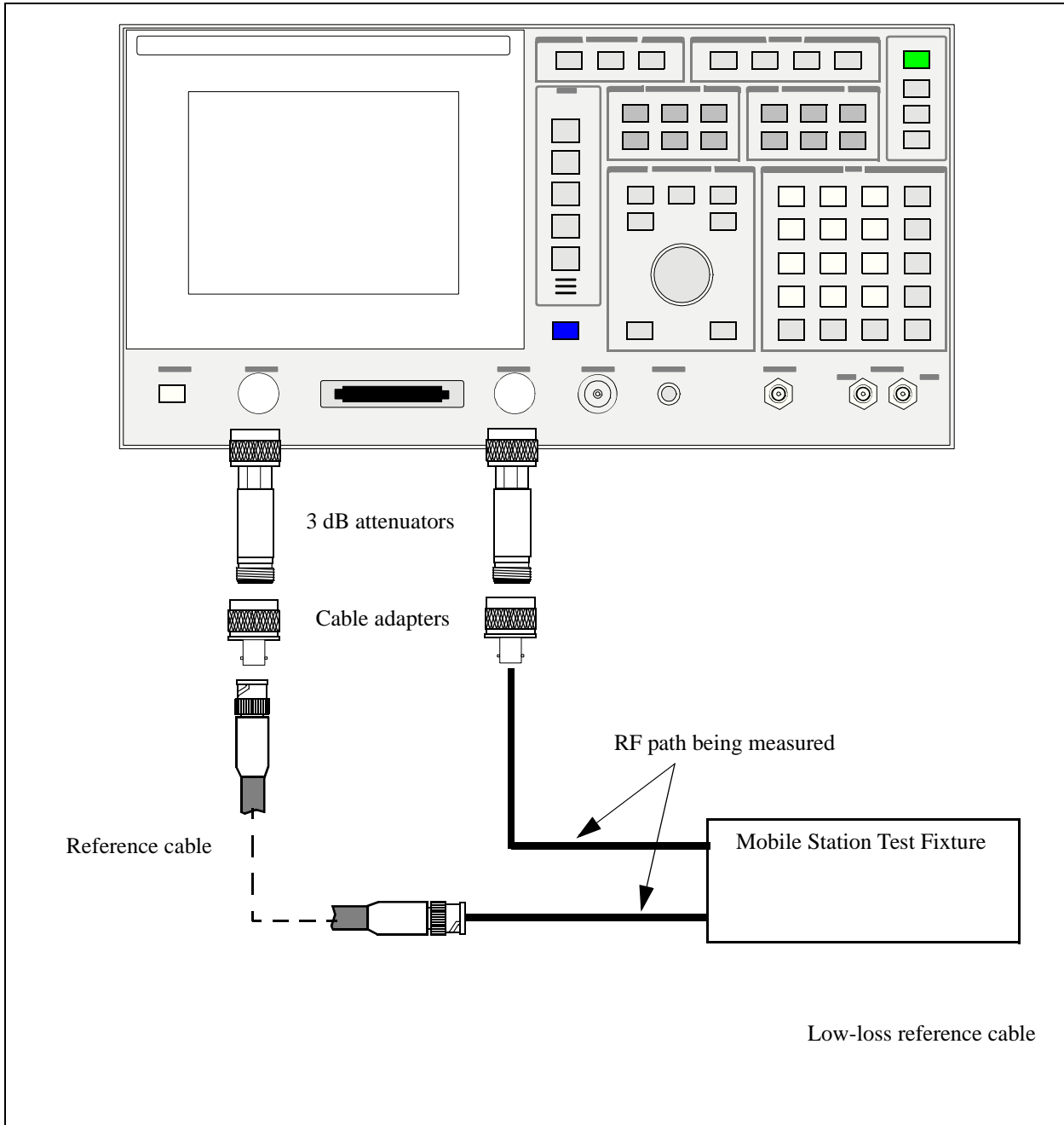

8. Obtain the value of the RF path loss.

Manual Operation:

1. Look at the display for the value.



9. Enter the CDMA forward or reverse channel path loss.

The TX Power measurement obtained from the previous step is the measured RF path loss for the forward or reverse channel, and should be entered in the Test Set's RF Out or Duplex Out field (if the measurement was on a forward channel frequency) or the RF In or Antenna In field (if the measurement was on a reverse channel frequency). See "Correcting for RF Path Loss" on page 29.

<p>Manual Operation:</p> <ol style="list-style-type: none"> 1. Press the UTILITIES Config key to display the CONFIGURE screen. 2. Select the Output Port and Input Port settings you will use during mobile station testing. 3. If the frequency setting was for the forward CDMA channel, position the cursor at the Output Port field and enter the value obtained from the previous step. you will use during mobile station testing. 4. If the frequency setting was for the reverse CDMA channel, position the cursor at the Input Port field and enter the value obtained from the previous step. 5. Turn the RF Level Offset field On. 	<p>The screenshot shows the CONFIGURE screen with the following fields and values:</p> <table border="1"> <tr> <td>Range Hold</td> <td>Date</td> <td>RF Display</td> <td>RF Level Offset</td> <td>Firmware</td> </tr> <tr> <td>Auto All</td> <td>62299</td> <td>Freq</td> <td>On/Off</td> <td>A-01-14</td> </tr> <tr> <td>Hold All</td> <td>MMDDYY</td> <td></td> <td></td> <td>Total RAM</td> </tr> <tr> <td>State:Auto</td> <td>Time</td> <td>RF Off</td> <td></td> <td>896 kB</td> </tr> <tr> <td></td> <td>14.56</td> <td>On/Off</td> <td></td> <td>Serial No.</td> </tr> <tr> <td>Match Count</td> <td>HH:MM</td> <td>(Gen)-(Ant)</td> <td>Output Port</td> <td>US38350023</td> </tr> <tr> <td>RFGen/Mod</td> <td>Beamer</td> <td>45.0000</td> <td>RF Out/Duplex</td> <td>To Screen</td> </tr> <tr> <td>RFGen Volts</td> <td>Load</td> <td></td> <td>RF Out</td> <td>● CDMA</td> </tr> <tr> <td>RF ohm/res</td> <td>Display</td> <td></td> <td>-0.7 dB</td> <td>CALL CHNL</td> </tr> <tr> <td>Input Atten</td> <td>User Msses</td> <td></td> <td></td> <td>○ Analog</td> </tr> <tr> <td>Auto/Hold</td> <td>Yes/No</td> <td></td> <td>Input Port</td> <td>DUPLER</td> </tr> <tr> <td>10 dB</td> <td></td> <td></td> <td>RF In/Ant</td> <td></td> </tr> <tr> <td></td> <td>TimeBase</td> <td></td> <td>RF In</td> <td></td> </tr> <tr> <td></td> <td>Auto/Int</td> <td></td> <td>-0.5 dB</td> <td></td> </tr> <tr> <td></td> <td>Internal</td> <td></td> <td></td> <td></td> </tr> <tr> <td></td> <td>Frame Clock</td> <td></td> <td></td> <td></td> </tr> <tr> <td></td> <td>2.00 s</td> <td></td> <td></td> <td></td> </tr> </table> <p>Three pink arrows point to the RF Level Offset field (On/Off), the Output Port field (-0.7 dB), and the Input Port field (RF In/Ant, -0.5 dB).</p>	Range Hold	Date	RF Display	RF Level Offset	Firmware	Auto All	62299	Freq	On/Off	A-01-14	Hold All	MMDDYY			Total RAM	State:Auto	Time	RF Off		896 kB		14.56	On/Off		Serial No.	Match Count	HH:MM	(Gen)-(Ant)	Output Port	US38350023	RFGen/Mod	Beamer	45.0000	RF Out/Duplex	To Screen	RFGen Volts	Load		RF Out	● CDMA	RF ohm/res	Display		-0.7 dB	CALL CHNL	Input Atten	User Msses			○ Analog	Auto/Hold	Yes/No		Input Port	DUPLER	10 dB			RF In/Ant			TimeBase		RF In			Auto/Int		-0.5 dB			Internal					Frame Clock					2.00 s			
Range Hold	Date	RF Display	RF Level Offset	Firmware																																																																																		
Auto All	62299	Freq	On/Off	A-01-14																																																																																		
Hold All	MMDDYY			Total RAM																																																																																		
State:Auto	Time	RF Off		896 kB																																																																																		
	14.56	On/Off		Serial No.																																																																																		
Match Count	HH:MM	(Gen)-(Ant)	Output Port	US38350023																																																																																		
RFGen/Mod	Beamer	45.0000	RF Out/Duplex	To Screen																																																																																		
RFGen Volts	Load		RF Out	● CDMA																																																																																		
RF ohm/res	Display		-0.7 dB	CALL CHNL																																																																																		
Input Atten	User Msses			○ Analog																																																																																		
Auto/Hold	Yes/No		Input Port	DUPLER																																																																																		
10 dB			RF In/Ant																																																																																			
	TimeBase		RF In																																																																																			
	Auto/Int		-0.5 dB																																																																																			
	Internal																																																																																					
	Frame Clock																																																																																					
	2.00 s																																																																																					

10. Return the Test Set to display RF channels.

Manual Operation:

1. Position the cursor at the RF Display field.
2. Select Chan by pressing the knob to toggle the underlined selection.

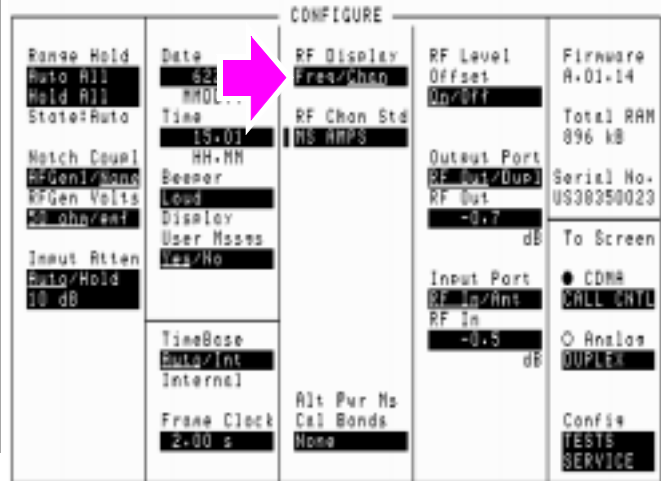

Setting Up a Call

Steps for Setting Up a Call

Procedure Overview

For detailed step-by-step explanation see the page associated with the step.

1. "Connect the MSUT to the Test Set." on page 47.
2. "Turn on power to the MSUT and wait for the MSUT to find digital service." on page 48.
3. "Select the desired Service Option." on page 49.
4. "Register the MSUT (Optional)." on page 50.
5. "Make a call." on page 52.
 - "MSUT-Terminated Call" on page 52
 - "MSUT-Originated Call ." on page 53

1. Connect the MSUT to the Test Set.

Manual Operation:

1. Connect the MSUT to the Test Set's RF IN/OUT connector.

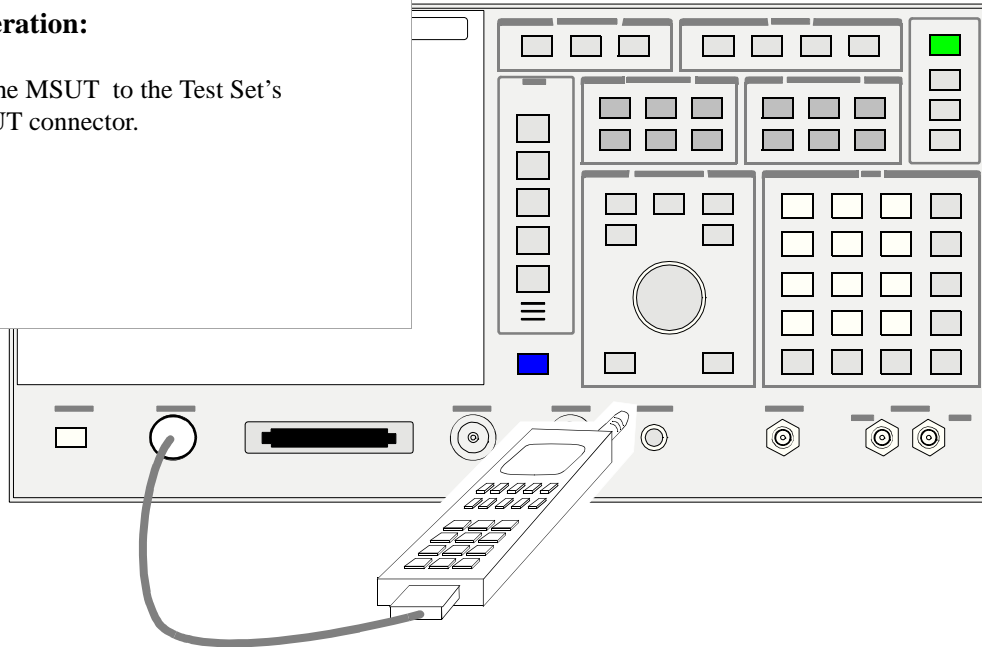

Make sure all connections to the MSUT, including dc power, are made.

Some MSUT's do not have an RF connection. The MSUT manufacturer will usually make a fixture, such as a car adapter, that will provide an RF cable connection to the Test Set. The MSUT is then snapped into the fixture and an RF connection is made through an electromagnetic coupler near the MSUT antenna. When setting up a call with these type of MSUT's, the MSUT may need to be isolated from interfering signals.

2. Turn on power to the MSUT and wait for the MSUT to find digital service.

Manual Operation:

Wait until the MSUT has found digital service (this should take no longer than about 30 seconds).

If the MSUT does not find service, refer to ["Checklist 1. MSUT did not find service" on page 55.](#)

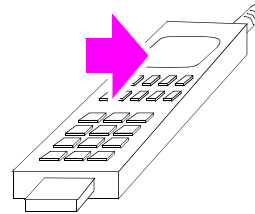

Most MSUT's have a NO SERVICE annunciator that will go out when the mobile station has found service. Other MSUT's use an LED that indicates when service has been found. If the MSUT is programmed to prefer analog service, and a strong signal from an analog base station is present, the MSUT may not find digital service. If this condition exists, re-program the phone or isolate it from the competing analog signal.

Caution: Do not exceed 6 W continuous power into the Test Set's RF IN/OUT connector with any transmitter.

3. Select the desired Service Option.

Manual Operation:

1. Position the cursor at the Traffic Data Mode field.
2. Press the knob to select the field.
3. Select a Service Option.

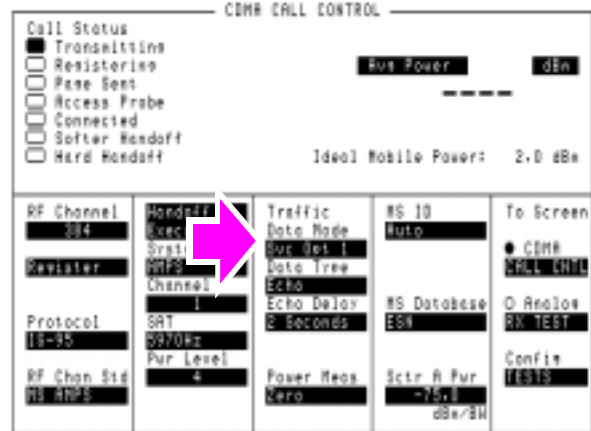

Service Option 1 and 9 select voice loopback (normal traffic) mode. When a Service Option 1 or 9 call is connected, the Test Set will echo voice information back to the MSUT with a settable delay.

Service Option 2 and 32768 select data loopback mode specified by IS-98 for MSUT receiver testing.

HP-IB Syntax:

```
"DISP CCNT;CDMA:CALL:TRAF:DATA:MODE 'SVC OPT 2'"
!selects service option 2 (data loopback mode)
```

4. Register the MSUT (Optional).

If you are going to make a call *from* the MSUT, or if you allow the MSUT to perform a power-up registration, you can skip this step and continue with "**MSUT-Originated Call .**" on page 53.

Manual Operation:

1. Optional: Select *Clr All* in the MS Database list of choices to remove any data from previous registrations.
2. Press the Register key. The **Registering** annunciator will light.
3. Watch for the **Registering** annunciator to go out. If the registration attempt times out, refer to "**Checklist 2. Registration failed**" on page 57.

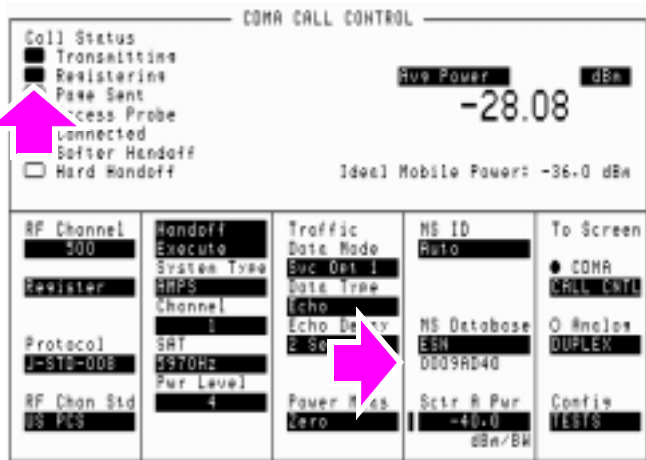

Registration provides the Test Set with the MSUT's identification, enabling the Test Set to correctly address pages to the MSUT. (An alternative method for providing the Test Set with the MSUT's identification is to enter Phone Number, MIN, or IMSI directly into the MS ID field on the CDMA Call Control screen. This alternative method could result in significant time savings in a production test environment but the numbers you enter must precisely match the internal NAM (Numeric Assignment Module) settings in the MSUT and the MSUT must be non-slotted).

When the Register field is selected, values entered in the CDMA Cell Site Configuration screen's Rgstr SID and Rgstr NID fields are sent to the MSUT in a message called the System Parameters message. This SID/NID pair causes the MSUT to perform a "zone-based" registration. The Rgstr SID and Rgstr NID fields are set by default to 12. These values do not need to be changed unless the MSUT is programmed to not recognize them as valid, or the MSUT recognizes them as its home SID/NID. If either of these conditions exist, change Rgstr SID and Rgstr NID to arbitrary values that are both valid for the MSUT and do not match the MSUT's home SID/NID.

HP-IB Help: The Call Status Registering annunciator is assigned to bit 11 in the CDMA Status Register Group. The following program example polls the CDMA Status Event Register until bit 11, Mobile Station Registered, goes true.

HP-IB Syntax:

DISP CCNT;CDMA:MOB:REG !causes the mobile station to register.

HP BASIC Example

```
1 RE-SAVE "C:\HPBASIC\REG"
10 OUTPUT 714;"CDMA:MOB:DAT '*Clr All*'" !Clears MS Database values
20 OUTPUT 714;"CDMA:MOB:REG"!Begins the zone-based registration process
30 T=TIMEDATE
40 REPEAT
50 OUTPUT 714;"stat:cdma:even?" !Queries CDMA Status Event Register
60 ENTER 714;Reg
70 IF TIMEDATE-T>=25 THEN
80 PRINT "ERROR"
90 STOP
100 ELSE
110 WAIT .1 !Prevents HP-IB commands from dominating Test Set processes
120 END IF
130 UNTIL BIT(Reg,11)
140 END
```

5. Make a call.

The Test Set supports both the following MSUT-terminated (originated from the Test Set), or **MSUT-originated calls**. The following section describes both types of calls.

MSUT-Terminated Call

<p>Manual Operation:</p> <ol style="list-style-type: none"> 1. Press the Test Set's Call/Page key. (The phone will not ring if you have selected a service option 2 or 9 call). 2. If the service option 1 or 32768 is selected, press the SEND key on the MSUT's keypad to connect the call. 3. Verify that the Connected annunciator is lit. <p>Optional: Speak into the phone to test voice quality if service option 1 or 32768 is selected.</p>	<p>The screenshot shows the 'CDMA CALL CONTROL' interface. On the left, 'Call Status' includes indicators for Transmitting, Registering, Page Sent (highlighted with a pink arrow), Access Probe, Connected, and Soft Handoff. On the right, 'Avg Power' is -29.37 dBm and 'Ideal Mobile Power' is -36.0 dBm. Below are various call parameters in a grid format.</p> <table border="1"> <tr> <td>RF Channel: 500</td> <td>Handoff: Execute</td> <td>Traffic: Data Mode</td> <td>MS ID: Auto</td> <td>To Screen: CDMA</td> </tr> <tr> <td>Register: Register</td> <td>System Type: WAP3</td> <td>Svc Opt 1: Data Type</td> <td>MS Database: ESN</td> <td>CALL CHIE: DUMPLEX</td> </tr> <tr> <td>Protocol: U-STD-003</td> <td>Channel: 1</td> <td>Echo: 2 Seconds</td> <td>0009AD40</td> <td>O Analog: DUMPLEX</td> </tr> <tr> <td>RF Chan Std: US PCS</td> <td>SAT: 5970Hz</td> <td>Power Mecs: Zero</td> <td>Sct'r A Pwr: -40.0</td> <td>Config: VESTS</td> </tr> <tr> <td></td> <td>Pwr Level: 4</td> <td></td> <td>dBm/BW</td> <td></td> </tr> </table>	RF Channel: 500	Handoff: Execute	Traffic: Data Mode	MS ID: Auto	To Screen: CDMA	Register: Register	System Type: WAP3	Svc Opt 1: Data Type	MS Database: ESN	CALL CHIE: DUMPLEX	Protocol: U-STD-003	Channel: 1	Echo: 2 Seconds	0009AD40	O Analog: DUMPLEX	RF Chan Std: US PCS	SAT: 5970Hz	Power Mecs: Zero	Sct'r A Pwr: -40.0	Config: VESTS		Pwr Level: 4		dBm/BW	
RF Channel: 500	Handoff: Execute	Traffic: Data Mode	MS ID: Auto	To Screen: CDMA																						
Register: Register	System Type: WAP3	Svc Opt 1: Data Type	MS Database: ESN	CALL CHIE: DUMPLEX																						
Protocol: U-STD-003	Channel: 1	Echo: 2 Seconds	0009AD40	O Analog: DUMPLEX																						
RF Chan Std: US PCS	SAT: 5970Hz	Power Mecs: Zero	Sct'r A Pwr: -40.0	Config: VESTS																						
	Pwr Level: 4		dBm/BW																							

After the CALL key is pressed on the Test Set, the Page Sent annunciator will light to indicate that a paging message was sent to the MSUT. The Access Probe annunciator will then light to indicate that the mobile station transmitted an access probe sequence in an attempt to gain system access. The MSUT should ring if the Traffic Data Mode is set to service option 1 or

HP-IB Help:

The following CDMA Status Register Group bits monitor the call processing states:

- Page Sent (BCD 2)
- Access Probe (BCD 1)
- Alerting (BCD 16)
- Connected (BCD 8)

Condition registers are implemented for these bits, allowing HP-IB operation to mirror the way they work on the display.

HP-IB Syntax:

"CDMA:CALL:MAKE" !makes a call from the Test Set (mobile terminated).

MSUT-Originated Call .

Manual Operation:

Enter any phone number on the MSUT's keypad and press the SEND key.

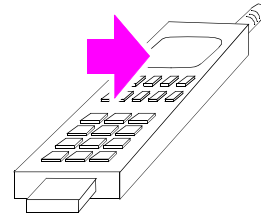

After Send is pressed on the MSUT, the Access Probe annunciator on the Test Set will light to indicate that the mobile station sent an access probe sequence in an attempt to gain system access.

The Test Set's Connected annunciator will light indicating that the MSUT is in the "Mobile Station Control on the Traffic Channel State."

If the Test Set's Answer Mode field is set to Manual, you must press the Test Set's ANS key to manually answer the phone.

HP-IB Help: Refer to "[MSUT-Terminated Call](#)" on page 52"

HP-IB Syntax:

"CDMA:CALL:ANSW" !answers a call from the MSUT.

(This command is only necessary when the Test Set's **Answer Mode** field is **Manual**).

HP-IB Example:

The following [HP BASIC example](#) uses service requests to detect when the following call-processing events occur:

- Page Sent
- Alerting (not included as a front-panel display annunciator)
- Connected

See "CDMA Status Register Group" in the Status Reporting chapter of the *HP E8285A User's Guide*.

Chapter 2, Setting Up a Call

Steps for Setting Up a Call

```
10     Status_byte = SPOLL(714)    !clears the Status Byte Register
20     OUTPUT 714;"*CLS" !clears all event registers
30     CALL Cdma_register_enable 31    !calls subprogram to enable selected bits in
31     !the CDMA Status Register Group
40     CALL Operation_register_enable !calls subprogram to enable selected bit in
41     !the Operation Status Register Group.
50     ALL Status_register_enable    !calls subprogram to enable bit in
51     !the Status Byte Register.
60     ON INTR 7,15 CALL Interrupt    !specifies a program branch to Interrupt
61     !subprogram when an interrupt occurs.
70     ENABLE INTR 7;3    !enables the SRQ interrupt (Decimal 2 enables bit 1 of the
    !HP-IB interrupt enable register "SRQ Received").
80     PRINT "WHEN MOBILE STATION IS REGISTERED, PRESS CONTINUE"
90     PAUSE
100    OUTPUT 714;"DISP CCNT;CDMA:CALL:MAKE"
110    LOOP
120    DISP "WAITING FOR A SERVICE REQUEST INTERRUPT"
130    END LOOP
140    END !End of program
150    SUB Cdma_register_enable
160    OUTPUT 714;"STATUS:CDMA:PTR 26;NTR 0"
161    !enables the CDMA Status Register Group positive
162    !transition register for the following bits:
163    !Page Sent (1), Alerting (4), and Connected (3)
170    OUTPUT 714;"STATUS:CDMA:ENAB 26"
171    !enables the CDMA Status Register Group event
171    !register to send a summary message
172    !bit for the selected events.
180    SUBEND
190    SUB Operation_register_enable
200    OUTPUT 714;"STAT:OPER:PTR 256;NTR 0;ENAB 256"
201    !enables the Operation Status Register Group positive transition register for
    !the CDMA Status Register Group summary message bit (8), and enables the event
    register to send a summary message bit for the selected events.
210    SUBEND
220    SUB Status_register_enable
240    OUTPUT 714;"*SRE 128"!enables bit 7 of the Status Register, the summary
241    !message bit from the Operation Status Register Group.
260    SUBEND
280    SUB Interrupt
300    Status_byte=SPOLL(714)
310    OUTPUT 714;"STAT:CDMA:EVEN?"
311    !queries the CDMA Status Register Group event register
320    ENTER 714;Event_reg
330    SELECT
340    CASE=2
360    PRINT "PAGE SENT"
380    CASE=16
400    PRINT "ALERTING...ANSWER PHONE"
410    CASE=8
420    PRINT "CALL IS CONNECTED"
440    STOP
460    END SELECT
480    OUTPUT 714;STAT:OPER:EVEN?
481    !query the Operation Status Register Group event register to clear bit 8,
482    !the CDMA Status Register Group summary message bit.
500    ENTER 714;Oper_event !terminates query
510    ENABLE INTR 7    !re-enables the SRQ interrupt
520    SUBEND
```

Problem Solving

Checklist 1. MSUT did not find service

If the MSUT won't find service, refer to this checklist. If the MSUT has found service but won't register, refer to "[Checklist 2. Registration failed](#)" on page 57.

- Is the RF cable connected?*
- Is the RF Channel number correct? (Set the RF Channel on the CDMA Call Control screen.) Refer to [table 1](#) and [table 2](#).*
- Is Sector A Power adequate? If interference from other cellular band sites are present, Sector A Power may need to be set to a level greater than the instrument preset value of -75 dBm/BW. (Set Sector A Power on the CDMA Call Control screen.) Example: If the MSUT is finding analog service, adjust Sector A Power to -25 dBm/BW, then cycle power on the MSUT. Isolating the MSUT may be necessary.*
- Is the AWGN generator (CDMA Gen Control screen) off?*
- Is the MSUT programmed to "Home Only"? If so, set the SID field on the CDMA CELL SITE CONFIGURATION screen to the mobile station's home SID, then cycle power on the phone. If you don't know the mobile station's home SID, set the Esc Mode field on the CDMA Cell Site Configuration screen to "On".*

Refer to [table 1](#). for SID (System ID) and RF Channel requirements.

Table 1 SID and RF Channel Settings for Call Setup

If MSUT is programmed to...	the System ID field entry (on the Cell Configuration screen) must be...	The RF Channel field entry (on the Call Control screen) must be...
Prefer System A	Don't Care	set to the System A or System B Primary or Secondary channel.
Prefer System B	Don't Care	set to the System B or System A Primary or Secondary channel.
System A Only	Don't Care	set to the System A Primary or Secondary channel
System B Only	Don't Care	set to the System B Primary or Secondary channel
Home Only	Same as MSUT Home_SID	set to either System A or System B Primary Channels. Try both.

Table 2 CDMA Channel Numbers (from EIA/TIA IS-95)

System	Range (CDMA)	Primary Channels	Secondary Channels
A	1 to 311, 689 to 694	283 ^a	691 ^a
B	356 to 644, 739 to 777	384 ^a	777 ^a

a. This channel number, although specified in the IS-95 standard as a primary or secondary channel, can be changed in the MSUT by re-programming the NAM. Trying these values *might* allow the MSUT to find service, but the only way to be certain of the correct channel numbers is to gain access to the NAM program menu in the MSUT.

Checklist 2. Registration failed

If the MSUT has found service but won't register, refer to this checklist.

- Is the MSUT programmed to "Home Only"? (To use the CDMA Call Control screen's Register field, the MSUT must be programmed to allow roaming.)*
- Are the entries in the Rgstr SID and Rgstr NID fields valid entries for the MSUT? (The Rgstr SID and Rgstr NID field entries, found on the CDMA Cell Site Configuration screen, must be recognized as a valid SID/NID pair by the MSUT).*
- Do the entries in the Rgstr SID and Rgstr NID fields match the MSUT's Home SID/NID? (The Rgstr SID and Rgstr NID fields, found on the CDMA Cell Site Configuration screen, must be different than the MSUT Home SID/NID).*
- Is the power supply providing adequate current? (Make sure the MSUT's power supply duplicates the voltage, impedance, and ampere hours of the manufacturers recommended power supply).*

NOTE:

If all attempts to register the MSUT using the CDMA Call Control screen's Register field fail, perform the procedure, "**MSUT-Originated Call.**" on page 53. When the Call Status Connected annunciator is lit, the Test Set will acquire the MSUT's phone number and MIN without performing a registration.

CDMA Receiver Tests

"Measuring Demodulation of Forward Traffic Channel with AWGN" on page 60.

"Measuring Receiver Sensitivity and Dynamic Range" on page 75.

"Measuring Single Tone Desensitization" on page 88.

"Measuring Intermodulation Spurious Response Attenuation" on page 105.

"Measuring Demodulation of Non-Slotted Mode Paging Channel in AWGN" on page 118.

Measuring Demodulation of Forward Traffic Channel with AWGN

The Test Set performs "Demodulation of Forward Traffic Channel in Additive White Gaussian Noise" as described in TIA IS-98, "CDMA Receiver Minimum Standards."

During this test, FER is measured as the Test Set provides various data rates to the mobile-station-under-test (MSUT) with the Test Set's AWGN generator turned on.

An ["HPBASIC Programming Example" on page 72](#) is provided.

Measurement Overview

For detailed step-by-step explanation see the page associated with the step.

1. ["Perform initial setup." on page 61.](#)
2. ["Make a Service Option 2 or 9 call." on page 61.](#)
3. ["Set the Traffic channel level \(test parameter Traffic Ec/Ior \)." on page 62.](#)
4. ["Set the Sector A Power level." on page 63.](#)
5. ["Set the AWGN level \(test parameter Ioc\) ." on page 64.](#)
6. ["Verify that the Eb/Nt reading is correct." on page 65.](#)
7. ["Set the data rate." on page 66.](#)
8. ["Set the FER specification." on page 67.](#)
9. ["Setup the display to show interim results \(Optional\)." on page 68.](#)
10. ["Arm a single measurement." on page 69.](#)
11. ["Monitor the annunciators to determine test status." on page 70.](#)

1. Perform initial setup.

- "Preset the Test Set." on page 49
- "Correct for RF Path Loss." on page 50
- "Enter the MSUT's Protocol and RF Channel Standard." on page 51
- "Enter the MSUT's primary CDMA channel." on page 52
- "Adjust Sector A Power. (Optional)" on page 53
- "Save initial settings (Optional)" on page 54

2. Make a Service Option 2 or 9 call.

- "Connect the MSUT to the Test Set." on page 47
- "Turn on power to the MSUT and wait for the MSUT to find digital service." on page 48
- "Select the desired Service Option." on page 49
- "Register the MSUT (Optional)." on page 50
- "Make a call." on page 52

3. Set the Traffic channel level (test parameter Traffic E_c/I_{or}).

<p>Manual Operation:</p> <ol style="list-style-type: none"> 1. Press the CDMA SCREENS - RX test key to display the CDMA CELLULAR MOBILE RECEIVER TEST screen. 2. Position the cursor at the Traffic field. 3. Set the Traffic E_c/I_{or} value with the DATA keys. (Refer to the applicable standard for test parameters). 4. Press the ENTER key or the knob to enter the value. 	
---	--

Sector A Pilot E_c/I_{or} has a factory preset value of -7 dB. If it is necessary to change this setting, access the CDMA GENERATOR CONTROL screen. The CDMA GENERATOR CONTROL screen also displays total RF Power.

Traffic E_c/I_{or} is defined as the ratio of the average transmit energy per PN chip for the Forward Traffic Channel to the total transmitted power spectral density. Values in this field are expressed in dB, relative to Sector A Power. Energy from the power control sub-channel is not included in Traffic E_c/I_{or} .

HP-IB Help When the CDMA CELLULAR MOBILE RECEIVER TEST screen is accessed over the HP-IB, continuous FER measurements are automatically armed.

Unless the **Display Interim Results** field is set to **Yes**, you will not see any results.

HP-IB Syntax

"DISP CRXT" !accesses the CDMA CELLULAR MOBILE RECEIVER TEST screen.

"CDMA:CELL:ASEC:TRAF -16.3" !sets Sector A Traffic E_c/I_{or} to -16.3 dB.

4. Set the Sector A Power level.

<p>Manual Operation:</p> <ol style="list-style-type: none"> 1. Position the cursor at the Sctr A Pwr field. 2. Enter a value 1 dB lower in power than the recommended level for the test parameter I_{oc} (AWGN). 	
<p><i>To obtain an \hat{I}_{or}/I_{oc} ratio of -1, set Sctr A Pwr 1 dB lower in power than AWGN.</i></p>	

HP-IB Syntax

"CDMA:CELL:ASEctor:STATE ON" !turns Sctr A Pwr on.

"CDMA:CELL:ASEctor -55" !sets Sctr A Pwr to -55 dBm/BW.

5. Set the AWGN level (test parameter I_{oc}).

Manual Operation:

1. Position the cursor at the AWGN field.
2. Press the ON/OFF key.
3. Enter the value recommended by the appropriate test standards.

Note: If the AWGN value is more than 1 dB higher in power than the current Sctr A Pwr setting, the call may drop.

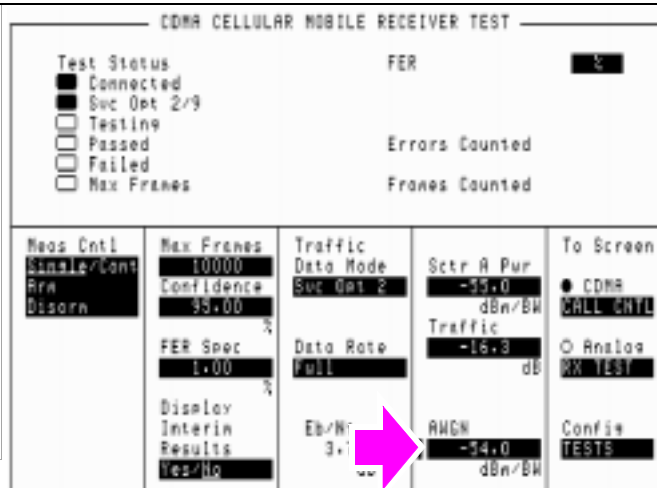

I_{oc} is defined as the power spectral density of a band-limited white noise source (simulating interference from other cells).

HP-IB Syntax

"CDMA:AWGN:STAT ON" !turns the Test Set's AWGN generator on.

"CDMA:AWGN -54" !sets AWGN to -54 dBM/BW.

6. Verify that the E_b/N_t reading is correct.

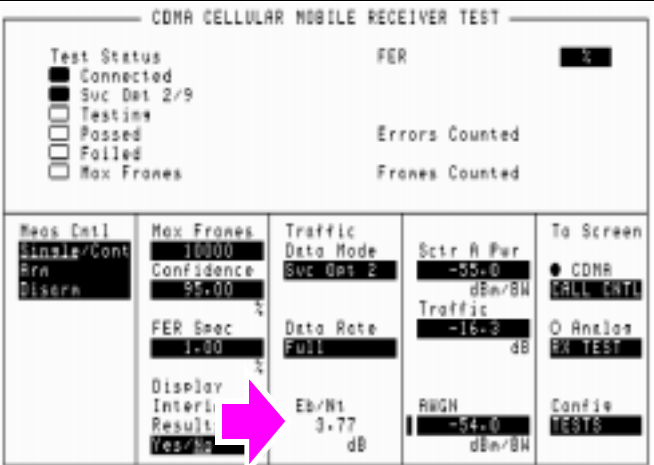
<p>Manual Operation:</p> <p>Refer to the applicable standard for correct E_b/N_t values.</p> <p>E_b/N_t is not a user-settable field.</p>	
--	--

E_b/N_t is calculated from Sector A Power, AWGN, and the Data Rate. Refer to TIA IS-98 for values.

The resolution of E_b/N_t as displayed on the Test Set is in hundredths of a dB. TIA IS-98 expresses this value in tenths of a dB.

HP-IB Syntax

"CDMA:STN?" !queries the E_b/N_t field.

7. Set the data rate.

<p>Manual Operation:</p> <ol style="list-style-type: none"> 1. Position the cursor at the Data Rate field. 2. Press the knob to display a list of choices. 3. Position the cursor at the desired data rate. (Refer to the applicable standard for recommended data rate specifications). 4. Press the knob to set the data rate. 	
---	--

Service Option 2 data rate choices are: Full=9600 bps, Half=4800 bps, Quarter=2400 bps, Eighth=1200 bps
Service Option 9 data rate choices are: Full=14400 bps, Half=7200 bps, Quarter=3600 bps, Eighth=1800 bps

When the traffic channel's data rate is reduced the amount of processing gain is also reduced. To compensate for this reduction, Traffic E_c/I_{or} is increased (refer to tables in applicable test standards such as IS-98).

HP-IB Syntax

"MEAS:CDMA:CALL:TRAF:DATA:RATE 'FULL'" !sets the Data Rate to 9600 or 14400 bps, depending on Traffic Data Mode.

8. Set the FER specification.

<p>Manual Operation:</p> <ol style="list-style-type: none"> 1. Position the cursor at the FER Spec field. 2. Set the value with the DATA keys. (Refer to the applicable standard for the recommended FER specification.) 3. Press the ENTER key or the knob to enter the value. 	
---	--

In the FER Spec field, FER is expressed in percent. In the applicable standard, FER is expressed without units. Example: If the required FER is 0.03, enter 3 in this field. This will set the maximum number of frame errors allowed for a passing result at 3%.

Frame errors result when the Test Set determines that the frame data it received from the MSUT does not match the frame data sent.

HP-IB Syntax

"MEAS:CDM:FER:CONF:LIM 3" !sets the FER to 0.03.

9. Setup the display to show interim results (Optional).

<p>Manual Operation:</p> <ol style="list-style-type: none"> 1. Position the cursor at the Display Interim Results field. 2. Press the knob to toggle the selection to <u>Yes</u>. 	<p>The screenshot shows the 'CDMA CELLULAR MOBILE RECEIVER TEST' interface. At the top, 'Test Status' is 'FER' with a percentage indicator. Below it are 'Errors Counted' and 'Frames Counted'. The main display is divided into several sections: 'Max Frames' (10000), 'Confidence' (95.00), 'FER Spec' (3.00), 'Display Interim Results' (Yes/No), 'Traffic Data Mode' (Suc Oct 2), 'Data Rate' (Full), 'Eb/Nt' (3.77 dB), 'Scnr R Pur' (-55.0 dBm/BW), 'Traffic' (-16.3 dB), 'AWGN' (-54.0 dBm/BW), and 'To Screen' (CDMA, CALL CHNL, Q Anclos, W TEST, Config TESTS).</p>
<p><i>Setting up the display to show interim results allows real time observation of FER test results. If you are interested in observing the progress of an FER test or the point at which frame errors occur, you must select Yes in the Display Interim Results field.</i></p>	

HP-IB Syntax

"DISP:FER:INT:RES `YES`"

10. Arm a single measurement.

Manual Operation:

1. Position the cursor at the Arm field.
2. Press the knob to arm a measurement.

CDMA CELLULAR MOBILE RECEIVER TEST

Test Status <input checked="" type="checkbox"/> Connected <input checked="" type="checkbox"/> Svc Opt 2/3 <input checked="" type="checkbox"/> Testing <input type="checkbox"/> Passed <input type="checkbox"/> Failed <input type="checkbox"/> Max Frames		FER 0.00 Errors Counted 0 Frames Counted 81	
Meas Cntl Single/Cont Arm Discrn	Max Frames 10000 Confidence 95.00 FER Spec 3.00 Display Interim Results Yes/No	Traffic Data Mode Svc Opt 2 Data Rate Full Eb/Ns 3.77 dB	Sctr A Pur -35.0 dBn/BW Traffic -16.3 dB AWGN -34.0 dBn/BW
		To Screen <input checked="" type="radio"/> CDMA CALL CNTL <input type="radio"/> Analog RX TEST Confis TESTS	

When a measurement is running, the Testing annunciator will be lit.

HP-IB Syntax

"TRIG:MODE:RETR SING" !selects Single measurement mode.

"TRIG:AST 'ARM'" !arms the measurement.

11. Monitor the annunciators to determine test status.

Manual Operation:

The measurement will end when either the Passed, the Failed, or the Max Frames annunciator lights.

The Confidence and FER Spec field settings determine pass/fail criteria. The measurement will end when either the Passed, the Failed, or the Max Frames annunciator lights.

Turning the Confidence field Off causes the FER test to continue until the number of frames entered in the Max Frames field are counted. The Max Frames annunciator will light when Frames Counted equals Max Frames.

HP-IB Help

Querying the Measuring Status Register condition register bit 0 will indicate when the FER test is done.

The following CDMA Status Register event register bits indicate whether a passed, failed, or max frames result was obtained from an FER test:

- Test Passed (Bit 10, BCD 1024)
- Test Failed (Bit 9, BCD 512)
- Max Frames (Bit 8, BCD 256)

These bits are "event" bits only. No condition registers are implemented. Since event bits "stick", it is important to clear the register before starting FER test. Refer to "CDMA Status Register Group" in the Status Reporting chapter of the *HP E8285A User's Guide* for information about using status bits.

HP-IB Syntax

"STATus:MEASuring:CONDition" !queries the Measuring Status Register condition register. This query can be used to determine if an FER test is running.

"CDMA:STATus:EVENT?" !queries the CDMA Status Register event register. This query can be used to determine whether the FER test passed, failed, or reached max frames.

HPBASIC Programming Example

The following programming example was developed using HPBASIC for Windows. It was tested on an HP E8285A.

```
10 ! re-save "c:\hpbasic\app_note\FER_AWGN"
20 ! This program implements CDMA FER test with AWGN.
30 ! This closely follows T38 from the 83217A Software.
40 CLEAR SCREEN
50 OUTPUT 714;"CDMA:CALL:END" !End any call currently connected
60 WAIT 1
70 OUTPUT 714;"*RST"
90 Page_phone
100 CLEAR SCREEN
110 Fer_with_awgn
120 DISP "PROGRAM DONE"
130 END
140 Fer_with_awgn: SUB Fer_with_awgn
150 OUTPUT 714;"CDMA:CELL:ASEC:TRAF -16.3dB;PIL -7dB;SYNC -16dB;PAG -12dB"
160 OUTPUT 714;"CDMA:CELL:ASEC:BWP -75 dBm"
170 OUTPUT 714;"CDMA:AWGN:BWP -74 dBm;STAT ON"
180 OUTPUT 714;"TRIG:MODE:RETR SINGLE "
190 OUTPUT 714;"DISP CRXT"
200 OUTPUT 714;"MEAS:CDM:FER:MAX:FRAM 5000"
210 OUTPUT 714;"DISP:FER:INT:RES 'YES' "
220 OUTPUT 714;"MEAS:CDM:FER:CONF:INT 95;INT:STAT ON"
230 OUTPUT 714;"MEAS:CDM:FER:CONF:LIMIT .5"
240 OUTPUT 714;"TRIG:AST 'ARM' "
250 FOR Test=1 TO 6
260 SELECT Test
270 CASE 1
280 OUTPUT 714;"CDMA:CELL:ASEC:TRAF -16.3 DB"
290 OUTPUT 714;"CDMA:CALL:TRAF:DATA:RATE 'FULL' "
300 OUTPUT 714;"MEAS:CDM:FER:CONF:LIM 3"
310 CASE 2
320 OUTPUT 714;"CDMA:CELL:ASEC:TRAF -15.8 DB"
330 OUTPUT 714;"CDMA:CALL:TRAF:DATA:RATE 'FULL' "
340 OUTPUT 714;"MEAS:CDM:FER:CONF:LIM 1"
```

```
350 CASE 3
360 OUTPUT 714;"CDMA:CELL:ASEC:TRAF -15.6 DB"
370 OUTPUT 714;"CDMA:CALL:TRAF:DATA:RATE 'FULL'"
380 OUTPUT 714;"MEAS:CDM:FER:CONF:LIM .5"
390 CASE 4
400 OUTPUT 714;"CDMA:CELL:ASEC:TRAF -19.1 DB"
410 OUTPUT 714;"CDMA:CALL:TRAF:DATA:RATE 'HALF'"
420 OUTPUT 714;"MEAS:CDM:FER:CONF:LIM 1"
430 CASE 5
440 OUTPUT 714;"CDMA:CELL:ASEC:TRAF -21.6 DB"
450 OUTPUT 714;"CDMA:CALL:TRAF:DATA:RATE 'QUARTER'"
460 OUTPUT 714;"MEAS:CDM:FER:CONF:LIM 1"
470 CASE 6
480 OUTPUT 714;"CDMA:CELL:ASEC:TRAF -24.5 DB"
490 OUTPUT 714;"CDMA:CALL:TRAF:DATA:RATE 'EIGHTH'"
500 OUTPUT 714;"MEAS:CDM:FER:CONF:LIM 1"
510 END SELECT
520 GOSUB Meas
530 NEXT Test
540 SUBEXIT
550 !
560 Meas:!
570 WAIT 2
580 OUTPUT 714;"TRIG:AST 'ARM'"
590 REPEAT
600 DISP "Measuring FER..."
610 UNTIL FNFer_done
620 OUTPUT 714;"MEAS:CDM:FER?"
630 ENTER 714;Mv
640 Mv=PROUND(Mv,-2) ! Set to 2 significant digits
650 PRINT "Test ";Test;" RXD Traffic Ch FER% is ";Mv
660 RETURN
670 SUBEND
680 Fer_done: DEF FNFer_done
690 WAIT 1
700 OUTPUT 714;"STATUS:CDMA:EVEN?"
710 ENTER 714;Stat
```

Chapter 3, CDMA Receiver Tests

Measuring Demodulation of Forward Traffic Channel with AWGN

```
720 IF BIT(Stat,8) THEN RETURN 1
730 IF BIT(Stat,9) THEN RETURN 2
740 IF BIT(Stat,10) THEN RETURN 3
750 RETURN 0
760 FNEND
770 Page_phone: SUB Page_phone
780 OUTPUT 714;"CDMA:CELL:ASEC:BWP -50 dBm;STAT ON"
790 OUTPUT 714;"CDMA:RFCH 384" !
800 PRINT "WHEN THE MOBILE FINDS SERVICE, PRESS THE CONTINUE SOFTKEY (F2)"
810 DISP "Waiting..."
820 PAUSE
830 OUTPUT 714;"CDMA:CALL:TRAF:DATA:MODE 'SVC OPT 2'"
840 OUTPUT 714;"CDMA:CALL:MAKE"
850 DISP "Mobile is being paged..."
860 REPEAT
870 WAIT .1 !100 mS wait to allow Test Set to handle other tasks
880 OUTPUT 714;"STAT:CDMA:EVENT?"
890 ENTER 714;Event_reg
900 UNTIL BIT(Event_reg,3)! Monitoring "Connected" annunciator bit
910 CLEAR SCREEN
920 PRINT "Page successful, mobile is connected"
930 SUBEND
```

Measuring Receiver Sensitivity and Dynamic Range

The Test Set performs "Receiver Sensitivity and Dynamic Range" as described in TIA IS-98, "CDMA Receiver Minimum Standards."

During this test, FER is measured with the Test Set first providing a low level signal, then a high level signal in rapid transition. The objective of this test is to determine if the MSUT can continue to successfully demodulate the forward traffic channel despite a large change in received power.

NOTE:

The following procedure assumes that an instrument PRESET will be performed as part of setting up a call. This clears all settings from other tests that may affect the accuracy of this test, and allows the procedure to begin from a known instrument state.

A ["HPBASIC Programming Example" on page 85](#) is provided.

Measurement Overview

For detailed step-by-step explanation see the page associated with the step.

1. ["Perform initial setup." on page 76.](#)
2. ["Make a Service Option 2 or 9 call." on page 76.](#)
3. ["Set the Traffic level \(test parameter Traffic Ec/Ior\)." on page 77.](#)
4. ["Adjust Sector A Power \(test parameter \$\hat{I}or\$ \)." on page 78.](#)
5. ["Set the FER specification." on page 79.](#)
6. ["Set the data rate." on page 80.](#)
7. ["Setup the display to show interim results \(Optional\)." on page 81.](#)
8. ["Arm a single measurement." on page 82.](#)
9. ["Monitor the annunciators to determine test status." on page 83.](#)

1. Perform initial setup.

- "Preset the Test Set." on page 49
- "Correct for RF Path Loss." on page 50
- "Enter the MSUT's Protocol and RF Channel Standard." on page 51
- "Enter the MSUT's primary CDMA channel." on page 52
- "Adjust Sector A Power. (Optional)" on page 53
- "Save initial settings (Optional)" on page 54

2. Make a Service Option 2 or 9 call.

- "Connect the MSUT to the Test Set." on page 47
- "Turn on power to the MSUT and wait for the MSUT to find digital service." on page 48
- "Select the desired Service Option." on page 49
- "Register the MSUT (Optional)." on page 50
- "Make a call." on page 52

3. Set the Traffic level (test parameter Traffic E_c/I_{or}).

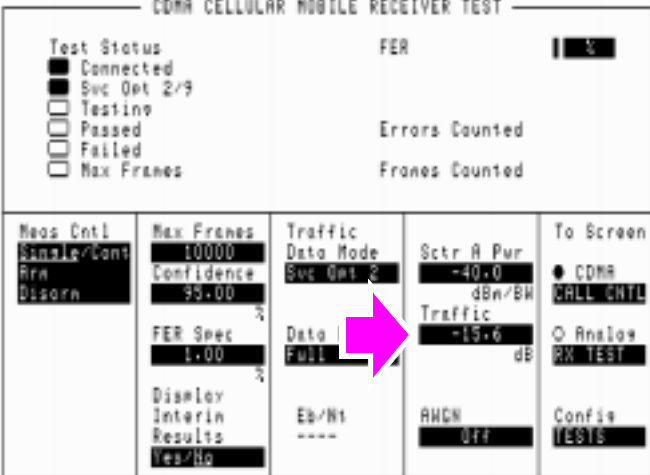
<p>Manual Operation:</p> <ol style="list-style-type: none"> 1. Press the CDMA SCREENS - RX test key to display the CDMA CELLULAR MOBILE RECEIVER TEST screen. 2. Position the cursor at the Traffic field. 3. Set the value with the DATA keys. (Refer to the applicable standard for test parameters). 4. Press the ENTER key or the knob to enter the value. 	
<p><i>Sector A Pilot E_c/I_{or} has a factory preset value of -7 dB. If it is necessary to change this setting, access the CDMA GENERATOR CONTROL screen.</i></p> <p><i>Traffic E_c/I_{or} is defined as the ratio of the average transmit energy per PN chip for the Forward Traffic Channel to the total transmit power spectral density. Values in this field are expressed in dB, relative to Sctr A Pwr. Energy from the power control sub-channel is not included in Traffic E_c/I_{or}.</i></p>	

HP-IB Help

When the CDMA CELLULAR MOBILE RECEIVER TEST screen is accessed over the HP-IB, continuous FER measurements are automatically armed.

Unless the **Display Interim Results** field is set to **Yes**, you will not see any results.

HP-IB Syntax

```
"CDMA:CELL:ASEC:TRAF -15.6" !sets Sctr A Traffic to -15.6 dB.
```

4. Adjust Sector A Power (test parameter \hat{I}_{or}).

Manual Operation:

1. Position the cursor at the Sctr A Pwr field.
2. Set the value with the DATA keys. (Refer to the applicable standard for recommended test parameters).
3. Press the ENTER key or the knob to enter the value.

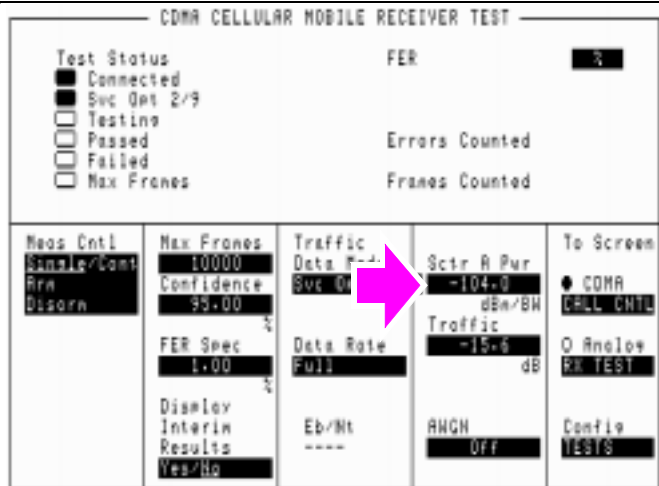

The value for I_{or} is referred to as Sector A Power.

HP-IB Syntax

"CDMA:CELL:ASEC -104" !sets Sctr A Power to -104 dBm/BW.

5. Set the FER specification.

Manual Operation:

1. Position the cursor at the FER Spec field.
2. Set the value with the DATA keys. (Refer to the applicable standard for recommended FER specification.)
3. Press the ENTER key or the knob to enter the value.

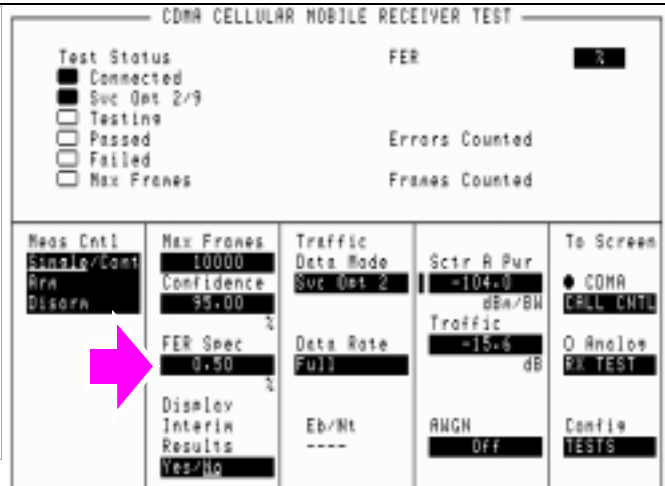

In the FER Spec field, FER is expressed in percent.

In the TIA IS-98 standards, FER is expressed without units. Example: If the TIA IS-98 required FER is 0.005, enter 0.5 in this field.

Frame errors result when the Test Set determines that the frame data it received from the MSUT does not match the frame data sent.

HP-IB Syntax

"MEAS:CDM:FER:CONF:LIM 0.5"

6. Set the data rate.

Manual Operation:

1. Position the cursor at the Data Rate field.
2. Press the knob to display a list of choices.
3. Position the cursor at the desired data rate.
 (Refer to the applicable standard for recommended data rate specifications.)
4. Press the knob to set the data rate.

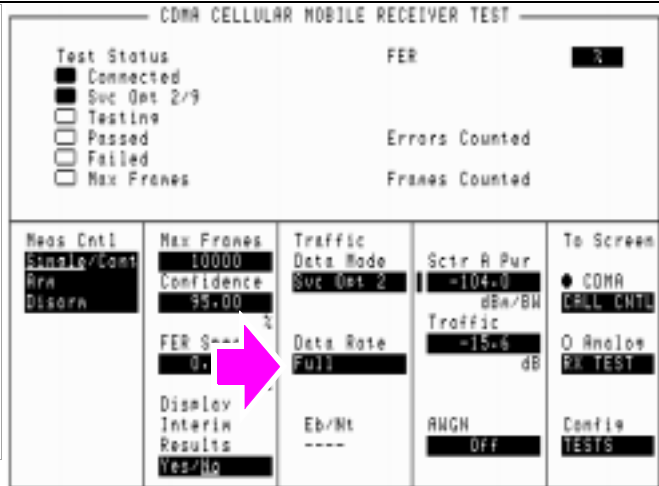

Service Option 2 data rate choices are: Full=9600 bps, Half=4800 bps, Quarter=2400 bps, Eighth=1200 bps

Service Option 9 data rate choices are: Full=14400 bps, Half=7200 bps, Quarter=3600 bps, Eighth=1800 bps

When the traffic channel's data rate is reduced the amount of processing gain is also reduced. To compensate for this reduction, Traffic E_c/I_{or} is increased (refer to tables in applicable test standards such as IS-98).

HP-IB Syntax

"MEAS : CDMA : CALL : TRAF : DATA : RATE `FULL` "

7. Setup the display to show interim results (Optional).

<p>Manual Operation:</p> <ol style="list-style-type: none"> 1. Position the cursor at the Display Interim Results field. 2. Press the knob to toggle the selection to <u>Yes</u>. 	<p>The screenshot shows the 'CDMA CELLULAR MOBILE RECEIVER TEST' menu. At the top, 'Test Status' is 'FER' with a 'Y' indicator. Below it are 'Errors Counted' and 'Frames Counted'. The main menu is divided into five columns: 'Meas Cntl', 'Max Frames', 'Traffic Data Mode', 'Scir R Pur', and 'To Screen'. The 'Display Interim Results' field in the 'Meas Cntl' column is highlighted with a pink arrow pointing to the 'Yes/No' option.</p>
<p><i>Setting up the display to show interim results allows real time observation of FER test results. If you are interested in observing the progress of an FER test or the point at which frame errors occur, you must select Yes in the Display Interim Results field.</i></p>	

HP-IB Syntax

"DISP:FER:INT:RES `YES`"

8. Arm a single measurement.

Manual Operation:

1. Position the cursor at the Arm field.
2. Press the knob to arm a test.

When a measurement is running, the Testing annunciator will be lit.

HP-IB Syntax

"TRIG:MODE:RETR SING" !selects Single measurement mode.

"TRIG:AST 'ARM'" !starts the FER measurement.

"TRIG" !starts the FER measurement and other "active" measurements.

9. Monitor the annunciators to determine test status.

Manual Operation:

The measurement will end when either the Passed, the Failed, or the Max Frames annunciator lights.

The Confidence and FER Spec field settings determine pass/fail criteria. The measurement will end when either the Passed, Failed, or Max Frames annunciator lights.

Turning the Confidence field off will force the measurement to continue until the number of frames entered in the

HP-IB Help

Querying the Measuring Status Register condition register bit 0 will indicate when the FER test is done.

The following CDMA Status Register event register bits indicate whether a passed, failed, or max frames result was obtained from an FER test:

- Test Passed (Bit 10, BCD 1024)
- Test Failed (Bit 9, BCD 512)
- Max Frames (Bit 8, BCD 256)

These bits are "event" bits only. No condition registers are implemented. Since event bits "stick", it is important to clear the register before starting FER test. Refer to "CDMA Status Register Group" in the Status Reporting chapter of the *HP E8285A User's Guide* for information about using status bits.

HP-IB Syntax

"STATus:MEASuring:CONDition" !queries the Measuring Status Register condition register. This query can be used to determine if an FER test is running.

"CDMA:STATus:EVENT?" !queries the CDMA Status Register event register. This query can be used to determine whether the FER test passed, failed, or reached max frames.

HPBASIC Programming Example

The following programming example was developed using HPBASIC for Windows. It was tested on an HP E8285A with firmware rev A.02.26.

```
10 ! re-save "c:\hpbasic\Sens_rng"
20 ! This program implements CDMA RX Sensitivity and Dynamic Range"
30 This closely follows T39 from the 83217A Software.
40 Initialize_ts
50 OUTPUT 714;"TRIG:MODE:RETR SINGLE"
60 Page_phone
70 CLEAR SCREEN
80 Sensitivity_rng
90 OUTPUT 714;"CDMA:CALL:END"
100 DISP "PROGRAM DONE"
110 END
120 Sensitivity_rng: SUB Sensitivity_rng
130 DISP "Measuring mobile sensitivity"
140 OUTPUT 714;"CDMA:CELL:ASEC:PIL -7dB;SYNC -16dB"
145 OUTPUT 714;"CDMA:CELL:ASEC:PAG -12dB;TRAF -15.6dB"
150 OUTPUT 714;"CDMA:CELL:ASEC:BWP -90 dBm"
160 OUTPUT 714;"CDMA:CELL:ASEC:BWP -104 dBm"
170 OUTPUT 714;"DISP CRXT"
180 OUTPUT 714;"MEAS:CDM:FER:MAX:FRAM 5000"
190 OUTPUT 714;"MEAS:CDM:FER:STAT ON"
200 OUTPUT 714;"MEAS:CDM:FER:CONF:INT 95;INT:STAT ON"
210 OUTPUT 714;"MEAS:CDM:FER:CONF:LIMIT .5"
220 GOSUB Meas ! Sensitivity test
230 Lvl=-25
240 OUTPUT 714;"CDMA:CELL:ASEC:BWP -25 dBm"
250 GOSUB Meas
260 SUBEXIT
270 Meas: !
280 Arm_fer
290 Max_f=0
300 P_f=0
310 Cnt=0
320 REPEAT
```

Chapter 3, CDMA Receiver Tests

Measuring Receiver Sensitivity and Dynamic Range

```
330 Cnt=Cnt+1340      UNTIL FNFer_done(Mv,P_f,Max_f) OR Cnt>125
350 IF Cnt>125 THEN
360 PRINT "Sensitivity test timed out"
370 ELSE
380 Mv=PROUND(Mv,-2)
390 PRINT "RXD Sensitivity FER% = ";Mv
400 END IF
410 RETURN
420 SUBEND
430 Fer_done: DEF FNFer_done(Mv,P_f,Max_f)
440 WAIT 1
450 OUTPUT 714;"STATUS:MEAS:CONDITION?"
460 ENTER 714;Meas
470 OUTPUT 714;"MEAS:CDM:FER?"
480 ENTER 714;Mv
490 IF BIT(Meas,0) THEN RETURN 0 ! Not done
500 OUTPUT 714;"STATUS:CDMA?"
510 ENTER 714;Stat
520 IF BIT(Stat,8) THEN Max_f=1
530 IF BIT(Stat,10) THEN P_f=1
540 RETURN 1
550 FNEND
560 Arm_fer: SUB Arm_fer
570 OUTPUT 714;"TRIG"
580 REPEAT
590 WAIT .1
600 OUTPUT 714;"STATUS:MEAS:CONDITION?"
610 ENTER 714;Meas
620 UNTIL BIT(Meas,0)
630 SUBEND
640 Page_phone: SUB Page_phone
650 OUTPUT 714;"CDMA:CELL:ASEC:BWP -50 dBm;STAT ON"
660 OUTPUT 714;"CDMA:RFCH 384" !
670 PRINT "WHEN THE MOBILE FINDS SERVICE, PRESS"
675 PRINT "THE CONTINUE SOFTKEY (F2)"
680 DISP "Waiting..."
690 PAUSE
```

```
700 OUTPUT 714;"CDMA:CALL:TRAF:DATA:MODE 'SVC OPT 2'"
710 OUTPUT 714;"CDMA:CALL:MAKE"
720 DISP "Mobile is being paged..."
730 REPEAT
740 WAIT .1 !100 mS wait to allow Test Set to handle other tasks
750 OUTPUT 714;"STAT:CDMA:EVENT?"
760 ENTER 714;Event_reg
770 UNTIL BIT(Event_reg,3)! Monitoring "Connected" annunciator bit
780 CLEAR SCREEN
790 PRINT "Page successful, mobile is connected"
800 SUBEND
810 Initialize_ts: SUB Initialize_ts
820 CLEAR 714
830 CLEAR SCREEN
840 DISP "Initializing...."
850 OUTPUT 714;"*RST"! Reset
860 WAIT 5
870 OUTPUT 714;"CONF:OFL:MODE 'ON';RFIN -2"! External Path Loss
880 SUBEND
```

Measuring Single Tone Desensitization

The Test Set performs the necessary call processing and FER measurements for "Single Tone Desensitization," but requires a single external continuous wave (CW) signal generator to perform this test as described in TIA IS-98, "CDMA Receiver Minimum Standards."

During this test, an interfering signal (tone) is summed with the Test Set's output and the FER is measured. The objective of this test is to measure the MSUT receiver's ability to perform when adjacent channel interference is present.

A **"Programming Example" on page 102** is provided.

Measurement Overview

1. **"Perform initial setup." on page 89.**
2. **"Connect the test equipment as shown." on page 90.**
3. **"Make a Service Option 2 or 9 call." on page 91.**
4. **"Set the signal generator's interfering tone to the required frequency and amplitude." on page 92.**
5. **"Turn the Signal Generators amplitude On." on page 93.**
6. **"Set the Traffic level (test parameter Traffic Ec/Ior)." on page 94.**
7. **"Adjust Sector A Power (test parameter Ior)." on page 95.**
8. **"Set the FER specification." on page 96.**
9. **"Set the data rate." on page 97.**
10. **"Set up display to show interim results (Optional)." on page 98.**
11. **"Arm a single measurement." on page 99.**
12. **"Monitor the annunciators to determine test status." on page 100.**

Recommended Equipment

CW Generator

Specifications for the CW signal generator are provided in TIA IS-98, "CDMA Standard Test Conditions." At the time of this printing, the following signal generators meet these specifications:

- HP 8657D
- HP 8656B
- HP 8647A

Combiner

The Combiner used in this test must provide adequate isolation between the Signal Generator output and the signals generated by the MSUT and the Test Set. At least 15 dB isolation is recommended.

1. Perform initial setup.

- "Preset the Test Set." on page 49
- "Correct for RF Path Loss." on page 50
- "Enter the MSUT's Protocol and RF Channel Standard." on page 51
- "Enter the MSUT's primary CDMA channel." on page 52
- "Adjust Sector A Power. (Optional)" on page 53
- "Save initial settings (Optional)" on page 54

2. Connect the test equipment as shown.

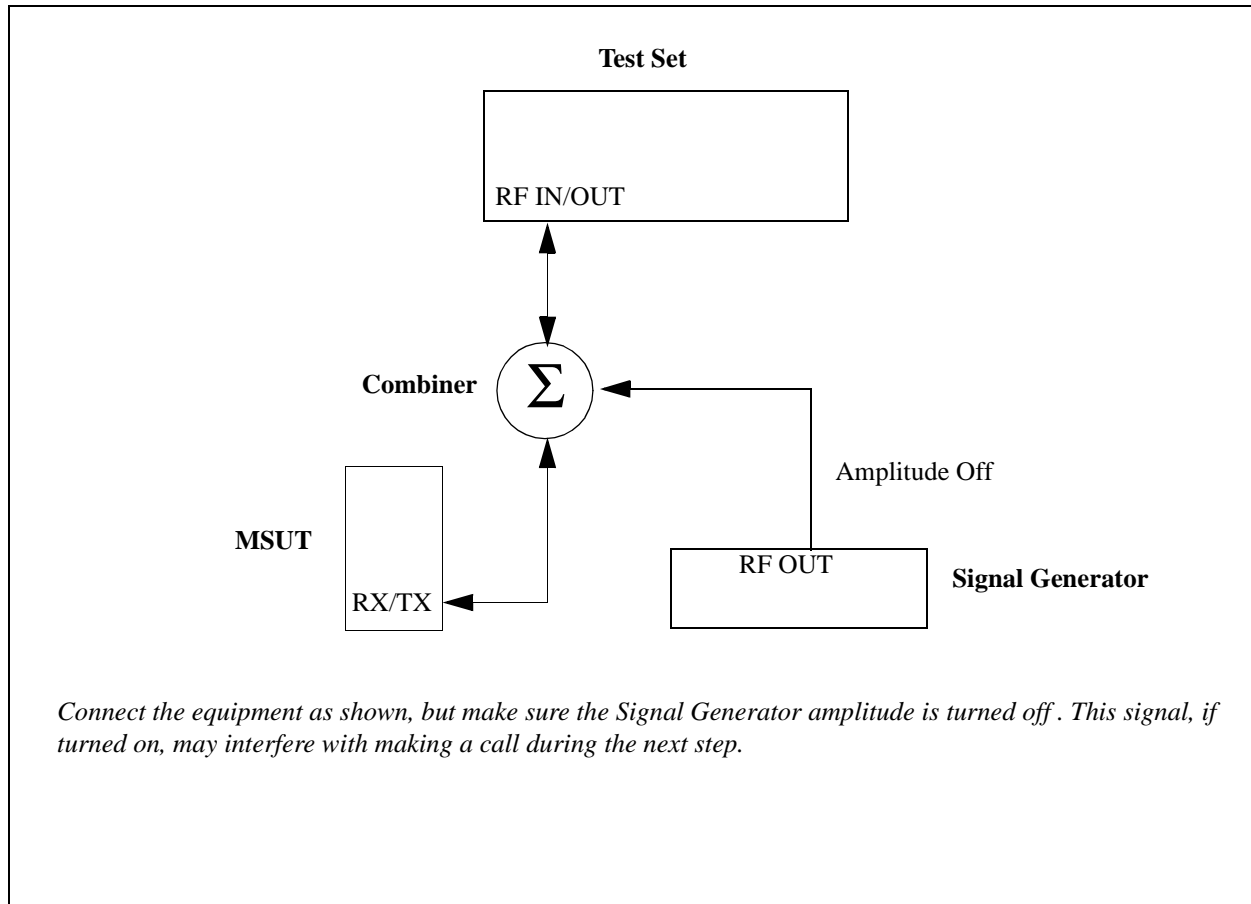

3. Make a Service Option 2 or 9 call.

- "Connect the MSUT to the Test Set." on page 47
- "Turn on power to the MSUT and wait for the MSUT to find digital service." on page 48
- "Select the desired Service Option." on page 49
- "Register the MSUT (Optional)." on page 50
- "Make a call." on page 52

4. Set the signal generator's interfering tone to the required frequency and amplitude.

Manual Operation:

Refer to applicable standard for test parameters.

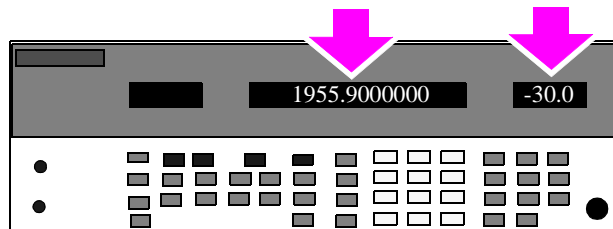

To display the forward link carrier frequency that the mobile station is assigned to receive,

- 1. Press the Config key to select the CONFIGURE screen.*
- 2. Select Freq in the RF Display field.*
- 3. Press the CDMA SCREENS Call control key.*

The forward link (from the Test Set) carrier frequency will be displayed in the RF Gen Freq field.

5. Turn the Signal Generators amplitude On.

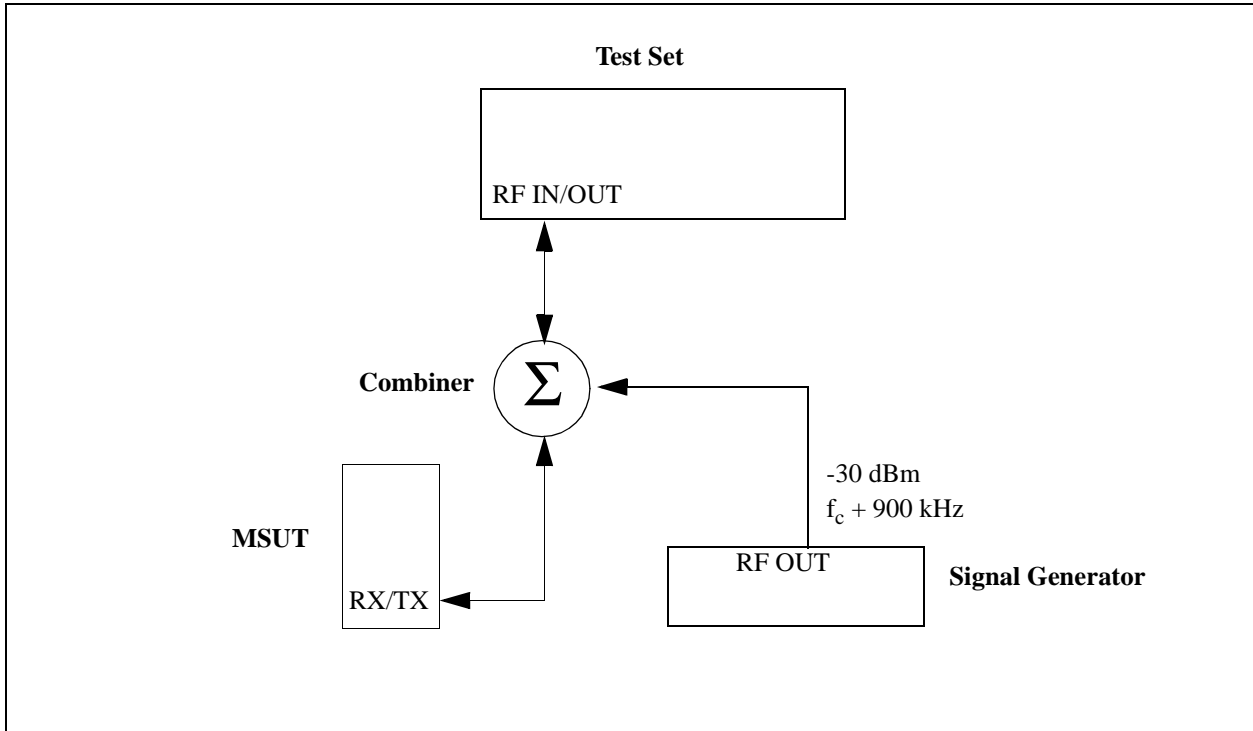

6. Set the Traffic level (test parameter Traffic E_c/I_{or}).

<p>Manual Operation:</p> <ol style="list-style-type: none"> 1. Press the CDMA SCREENS - RX Test key to display the CDMA CELLULAR MOBILE RECEIVER TEST screen. 2. Position the cursor at the Traffic field. 3. Set the value with the DATA keys. (Refer to the applicable standard for test parameters). 4. Press the ENTER key or knob to enter the value. 	
<p><i>Values in this field are expressed in dB, relative to Sctr A Pwr.</i></p> <p><i>Sctr A Pilot E_c/I_{or} has a factory preset value of -7 dB. If it is necessary to change this setting, access the CDMA GENERATOR CONTROL screen.</i></p>	

HP-IB Help

When the CDMA CELLULAR MOBILE RECEIVER TEST screen is accessed over the HP-IB, continuous FER measurements are automatically armed.

Unless the **Display Interim Results** field is set to **Yes**, you will not see any results.

HP-IB Syntax

"DISP CRXT" !displays the CDMA CELLULAR MOBILE RECEIVER TEST screen.
 "CDMA:CELL:ASEC:TRAF -15.6" !sets Sctr A Traffic E_c/I_{or} to -15.6 dB

7. Adjust Sector A Power (test parameter \hat{I}_{or}).

Manual Operation:

1. Position the cursor at the Sctr A Pwr field.
2. Set the value with the DATA keys. (Refer to the applicable standard for test parameters).
3. Press the ENTER key or the knob to enter the value.

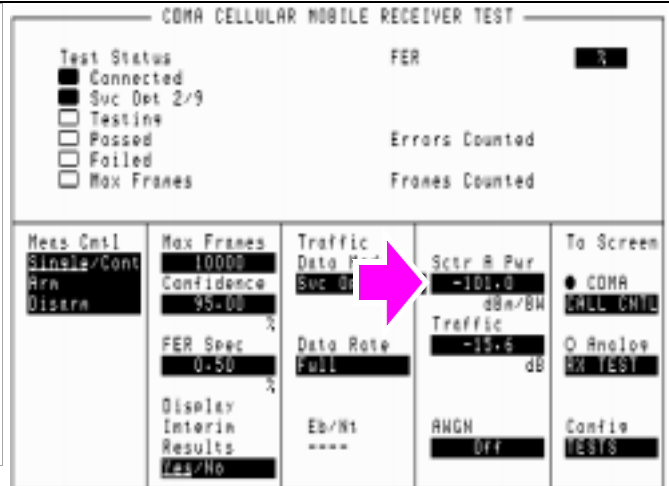

The value for Sector A Power is referred to as I_{or} .

HP-IB Syntax

```
"CDMA:CELL:ASEC -101" !sets Sctr A Ior to -101 dBm/BW
```

8. Set the FER specification.

<p>Manual Operation:</p> <ol style="list-style-type: none"> 1. Position the cursor at the FER Spec field. 2. Set the value with the DATA keys. (Refer to the applicable standard for the recommended FER specification.) 3. Press the ENTER key or the knob to enter the value. 	
---	--

In the FER Spec field, FER is expressed in percent. In the TIA IS-98 standards, FER is expressed without units. Example: If the TIA IS-98 required FER is 0.01, enter a value of 1.00 in this field.

Frame errors result when the Test Set determines that the frame data it received from the MSUT does not match the frame data sent.

HP-IB Syntax

"MEAS:CDM:FER:CONF:LIM 1" !sets the FER specification to 1%.

9. Set the data rate.

Manual Operation:

1. Position the cursor at the Data Rate field.
2. Press the knob to display a list of choices.
3. Position the cursor at the desired data rate.
(Refer to the applicable standard for recommended data rate specifications.)
4. Press the knob to set the data rate.

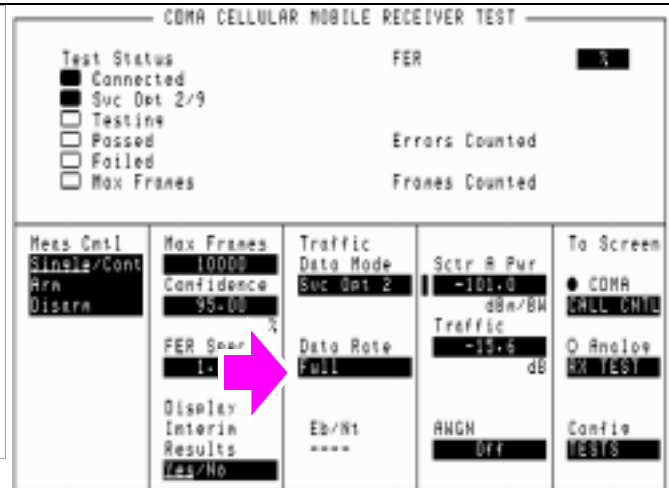

Service Option 2 data rate choices are: Full=9600 bps, Half=4800 bps, Quarter=2400 bps, Eighth=1200 bps
Service Option 9 data rate choices are: Full=14400 bps, Half=7200 bps, Quarter=3600 bps, Eighth=1800 bps

When the traffic channel's data rate is reduced the amount of processing gain is also reduced. To compensate for this reduction, Traffic E_c/I_{or} is increased (refer to tables in applicable test standards such as IS-98).

HP-IB Syntax

"MEAS:CDMA:CALL:TRAF:DATA:RATE 'FULL'" !sets the data rate to 9600 bps (for Svc Opt 2) or 14400 bps (for Svc Opt 9).

10. Set up display to show interim results (Optional).

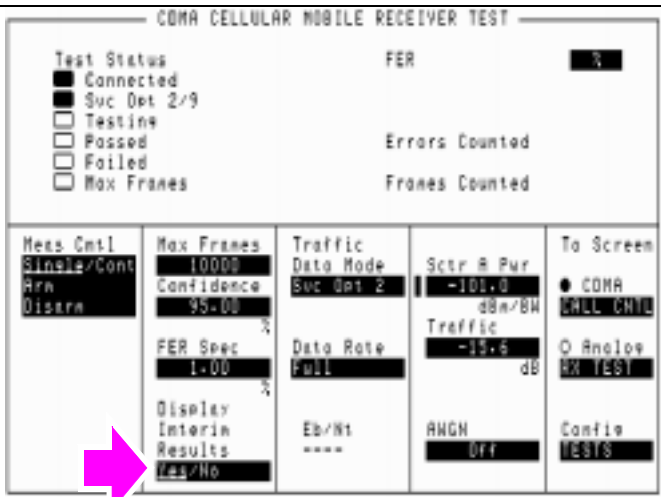
<p>Manual Operation:</p> <ol style="list-style-type: none">1. Position the cursor at the Display Interim Results field.2. Press the knob to toggle the selection to <u>Yes</u>.	 <p>CDMA CELLULAR MOBILE RECEIVER TEST</p> <p>Test Status FER 7</p> <p>Connected Suc Det 2/9 Testline Passed Failed Max Frames</p> <p>Errors Counted Frames Counted</p> <table border="1"><tr><td>Meas Cntl</td><td>Max Frames</td><td>Traffic</td><td>Sctr A Par</td><td>To Screen</td></tr><tr><td>Single/Cont</td><td>10000</td><td>Data Mode</td><td>-101.0</td><td>CDMA</td></tr><tr><td>Arr</td><td>Confidence</td><td>Suc Det 2</td><td>dBm/BW</td><td>CALL CHG</td></tr><tr><td>Disarn</td><td>95.00</td><td>Data Rate</td><td>Traffic</td><td>0 Anolog</td></tr><tr><td></td><td>FER Spec %</td><td>FULL</td><td>-15.6</td><td>RX TEST</td></tr><tr><td></td><td>1.00</td><td>Eb/Nt</td><td>dB</td><td>Confie</td></tr><tr><td></td><td>Display Interim Results</td><td>----</td><td>RNGN</td><td>TESTS</td></tr><tr><td></td><td>Yes/No</td><td></td><td>Off</td><td></td></tr></table>	Meas Cntl	Max Frames	Traffic	Sctr A Par	To Screen	Single/Cont	10000	Data Mode	-101.0	CDMA	Arr	Confidence	Suc Det 2	dBm/BW	CALL CHG	Disarn	95.00	Data Rate	Traffic	0 Anolog		FER Spec %	FULL	-15.6	RX TEST		1.00	Eb/Nt	dB	Confie		Display Interim Results	----	RNGN	TESTS		Yes/No		Off	
Meas Cntl	Max Frames	Traffic	Sctr A Par	To Screen																																					
Single/Cont	10000	Data Mode	-101.0	CDMA																																					
Arr	Confidence	Suc Det 2	dBm/BW	CALL CHG																																					
Disarn	95.00	Data Rate	Traffic	0 Anolog																																					
	FER Spec %	FULL	-15.6	RX TEST																																					
	1.00	Eb/Nt	dB	Confie																																					
	Display Interim Results	----	RNGN	TESTS																																					
	Yes/No		Off																																						

Setting up the display to show interim results allows real time observation of FER test results. If you are interested in observing the progress of an FER test or the point at which frame errors occur, you must select Yes in the Display Interim Results field.

HP-IB Syntax

"DISP:FER:INT:RES 'YES'" !displays interim FER test results.

11. Arm a single measurement.

<p>Manual Operation:</p> <ol style="list-style-type: none"> 1. Position the cursor at the Arm field. 2. Press the knob to arm a measurement. 	

HP-IB Syntax

"TRIG:MODE:RETR SING" !selects Single measurement mode.

"TRIG:AST 'ARM'" !arms the measurement.

12. Monitor the annunciators to determine test status.

Manual Operation:

The measurement will end when either the Passed, Failed, or the Frames annunciator lights.

The Confidence and FER Spec field settings determine pass/fail criteria.

Turning the Confidence field off will force the measurement to continue until the number of frames entered in the Max Frames field is counted.

HP-IB Help

Querying the Measuring Status Register condition register bit 0 will indicate when the FER test is done.

The following CDMA Status Register event register bits indicate whether a passed, failed, or max frames result was obtained from an FER test:

- Test Passed (Bit 10, BCD 1024)
- Test Failed (Bit 9, BCD 512)
- Max Frames (Bit 8, BCD 256)

These bits are "event" bits only. No condition registers are implemented. Since event bits "stick", it is important to clear the register before starting FER test. Refer to "CDMA Status Register Group" in the Status Reporting chapter of the *HP E8285A User's Guide* for information about using status bits.

HP-IB Syntax

"STATus:MEASuring:CONDition" !queries the Measuring Status Register condition register. This query can be used to determine if an FER test is running.

"CDMA:STATus:EVENT?" !queries the CDMA Status Register event register. This query can be used to determine whether the FER test passed, failed, or reached max frames.

Programming Example

The following programming example illustrates the IS-98 recommended procedure for measuring Single Tone Desensitization.

```
10 ! RE-STORE "c:\hpbasic\setrain\single_tone"
20 ! This program measures Single Tone Desensitization
26 Test=1
27 Loss=1.5 !Path loss
30 OUTPUT 714;"*CLS"
40 CLEAR SCREEN
50 CLEAR 714
60 OUTPUT 714;"CDMA:CALL:END"
70 WAIT 1
80 OUTPUT 714;"*RST"
90 WAIT 5
100 OUTPUT 714;"MEAS:CDM:RHO:STAT OFF" !Rho is not needed
110 Page_phone!Makes the call
120 !
130 Meas(900,Test,Loss) !Makes FER measurement with 900 kHz offset
140 CLEAR SCREEN
150 Meas(-900,Test,Loss) !Makes FER measurement with -900 kHz offset
160 !
170 DISP "Program Done"
180 END
190 Page_phone: SUB Page_phone
200 OUTPUT 714;"CDMA:CELL:ASEC:BWP -50 dBm;STAT ON"
210 OUTPUT 714;"CDMA:RFCH 384"
220 PRINT "WHEN THE MOBILE FINDS SERVICE, "
225 PRINT "PRESS THE CONTINUE SOFTKEY (F2)"
230 DISP "Waiting..."
240 PAUSE
250 OUTPUT 714;"CDMA:CALL:TRAF:DATA:MODE 'SVC OPT 2'"
260 OUTPUT 714;"CDMA:CALL:MAKE"
270 DISP "Mobile is being paged..."
280 REPEAT
290 WAIT .1 !100 mS wait to allow Test Set to handle other tasks
300 OUTPUT 714;"STAT:CDMA:PTR 8"
```

```
310 OUTPUT 714;"STAT:CDMA:EVENT?"
320 ENTER 714;Event_reg
330 UNTIL BIT(Event_reg,3)! Monitoring "Connected" annunciator bit
340 CLEAR SCREEN
350 PRINT "Page successful, mobile is connected"
360 SUBEND
370 Meas: SUB Meas(Tone1,Test,Loss)
380 OUTPUT 714;"RFG:FREQ?"
390 ENTER 714;Rf_freq
400 CLEAR SCREEN
410 PRINT "TEST ";VAL$(Test)&":"
411 PRINT
414 PRINT USING "K,4D.2D,K";"1. SET UP SIG GEN FREQUENCY TO", (Rf_freq+Tone1*1.E+3)/
1.E+6, " MHZ"
423 IF Test=1 THEN
430 PRINT "2. SET UP SIG GEN AMPLITUDE TO -30 dBm"
440 PRINT "3. CONNECT SIG GEN TO MOBILE INPUT THROUGH COMBINER"
441END IF
450 PRINT
460 PRINT "PRESS CONTINUE TO RUN FER TEST ";VAL$(Test)
470 PRINT
480 PAUSE
490 CLEAR SCREEN
500 OUTPUT 714;"TRIG:MODE:RETR SINGLE"
520 OUTPUT 714;"CONF:OFL:MODE 'ON' "
530 OUTPUT 714;"CONF:OFL:RFIN ";Loss
535 OUTPUT 714;"DISP CRXT;CDMA:CELL:ASEC:PIL -7"
540 OUTPUT 714;"DISP CRXT;CDMA:CELL:ASEC:TRAF -15.6"
550 OUTPUT 714;"CDMA:CELL:ASEC -90"
560 OUTPUT 714;"MEAS:CDM:FER:CONF:LIM 1"
570 OUTPUT 714;"CDMA:CALL:TRAF:DATA:RATE 'FULL' "
580 OUTPUT 714;"DISP:FER:INT:RES 'YES' "
590 OUTPUT 714;"TRIG"
600 REPEAT
610 WAIT 1
620 DISP "FER Test ";VAL$(Test);" is running..."
630 OUTPUT 714;"STAT:CDMA:EVEN?"
```

Chapter 3, CDMA Receiver Tests

Measuring Single Tone Desensitization

```
640 ENTER 714;Evt
660 UNTIL Evt<>0
661 DISP "FER Test ";VAL$(Test);" is done"
662 OUTPUT 714;"MEAS:CDM:FER?"
663 ENTER 714;Fer
670 SELECT Evt
680 CASE 256
685     PRINT "FER TEST ";VAL$(Test);" REACHED MAX FRAMES WITH FER =";Fer
690 CASE 512
695 PRINT "FER TEST ";VAL$(Test);" FAILED WITH FER =";Fer
700 CASE 1024
705 PRINT "FER TEST ";VAL$(Test);" PASSED WITH FER =";Fer
710 END SELECT
711 IF Test=1 THEN
712 Test=Test+1
714 PRINT
720 PRINT "PRESS CONTINUE TO RUN FER TEST ";VAL$(Test)
730 PAUSE
731 END IF
740 SUBEND
```

Measuring Intermodulation Spurious Response Attenuation

The Test Set performs the necessary call processing and FER measurements for "Intermodulation Spurious Response Attenuation," but requires two external continuous wave (CW) signal generators to perform this test as described in TIA IS-98, "CDMA Receiver Minimum Standards."

During this test, two interfering signals (tones) are summed with the Test Set's output during a Rate Set 1 (Service Option 2) call. The interfering tones are tuned to frequencies that could produce interference in the mobile station's receiver due to third order mixing. An FER measurement is performed to test the mobile station's response to this type of interference.

Measurement Overview

1. "Perform initial setup." on page 106.
2. "Connect test equipment as shown." on page 107.
3. "Make a Service Option 2 or 9 call." on page 108.
4. "Tune the signal generators to the required frequencies and power levels (amplitudes)." on page 109.
5. "Set the Traffic channel level (test parameter Traffic Ec/Ior)." on page 110.
6. "Adjust Sector A Power (test parameter Ior)." on page 111.
7. "Set the FER specification." on page 112.
8. "Set the data rate." on page 113.
9. "Set up the display to show interim results (Optional)." on page 114.
10. "Arm a single measurement." on page 115.
11. "Monitor the annunciators to determine test status." on page 116.

Recommended Equipment

CW Generators (2)

Specifications for the two CW signal generators are provided in TIA IS-98, "CDMA Standard Test Conditions." At the time of this printing, the following equipment meets these specifications:

- HP 8657D
- HP 8656B
- HP 8647A

Combiners (2)

The combiners should provide at least 15 dB of isolation between sources.

1. Perform initial setup.

- "Preset the Test Set." on page 49
- "Correct for RF Path Loss." on page 50
- "Enter the MSUT's Protocol and RF Channel Standard." on page 51
- "Enter the MSUT's primary CDMA channel." on page 52
- "Adjust Sector A Power. (Optional)" on page 53
- "Save initial settings (Optional)" on page 54

2. Connect test equipment as shown.

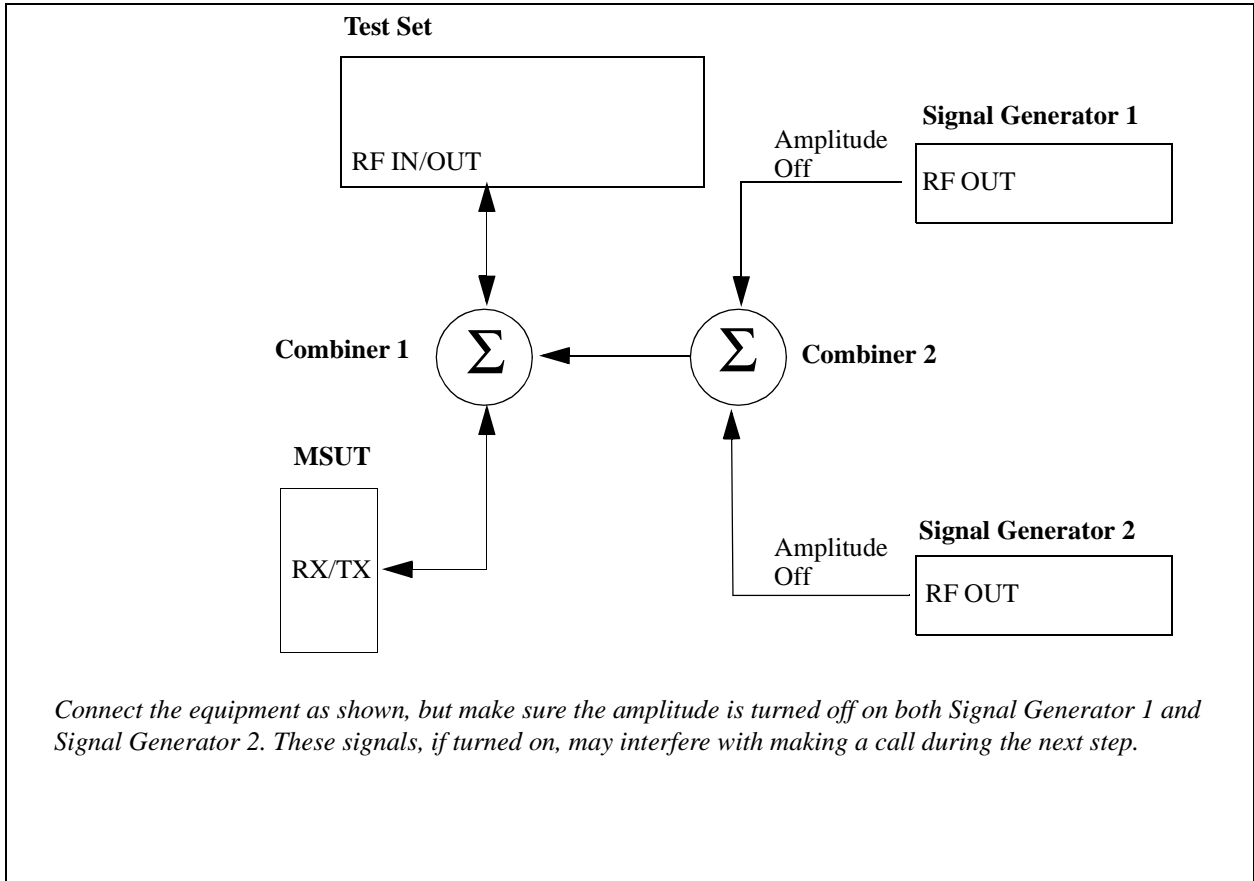

3. Make a Service Option 2 or 9 call.

- "Connect the MSUT to the Test Set." on page 47
- "Turn on power to the MSUT and wait for the MSUT to find digital service." on page 48
- "Select the desired Service Option." on page 49
- "Register the MSUT (Optional)." on page 50
- "Make a call." on page 52

4. Tune the signal generators to the required frequencies and power levels (amplitudes).

Manual Operation:

Refer to the applicable standard for test parameters.

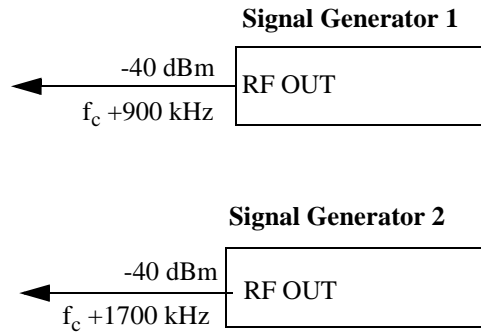

To display the carrier frequency that the mobile station is assigned to receive:

- 1. Press the Config key to select the CONFIGURE screen.*
- 2. Select Freq in the RF Display field.*
- 3. Press the CDMA SCREENS Call control key.*

The carrier frequency will be displayed in the RF Channel field.

5. Set the Traffic channel level (test parameter Traffic E_c/I_{or}).

<p>Manual Operation:</p> <ol style="list-style-type: none"> 1. Press the CDMA SCREENS - RX test key to display the CDMA CELLULAR MOBILE RECEIVER TEST screen. 2. Position the cursor at the Traffic field. 3. Set the value with the DATA keys. (Refer to the applicable standard for test parameters.) 4. Press the ENTER key or the knob to enter the value. 	
<p><i>Sector A Pilot E_c/I_{or} has a factory preset value of -7 dB. If it is necessary to change this setting, access the CDMA GENERATOR CONTROL screen. The CDMA GENERATOR CONTROL screen also displays total RF Power.</i></p>	
<p><i>Traffic E_c/I_{or} is defined as the ratio of the average transmit energy per PN chip for the Forward Traffic Channel to the total transmitted power spectral density. Values in this field are expressed in dB, relative to Sector A Power. Energy from the power control sub-channel is not included in Traffic E_c/I_{or}.</i></p>	

HP-IB Help When the CDMA CELLULAR MOBILE RECEIVER TEST screen is accessed over the HP-IB, continuous FER measurements are automatically armed. Unless the **Display Interim Results** field is set to **Yes**, you will not see any results until the first test completes.

HP-IB Syntax
 "DISP CRXT "
 "CDMA:CELL:ASEC:TRAF -15.6 "

6. Adjust Sector A Power (test parameter \hat{I}_{or}).

<p>Manual Operation:</p> <ol style="list-style-type: none"> 1. Position the cursor at the Sctr A Pwr field. 2. Set the value with the DATA keys. (Refer to the applicable standard for test parameters.) 3. Press the ENTER key or the knob to enter the value. 	
---	--

The value for Sector A Power is referred to as I_{or} .

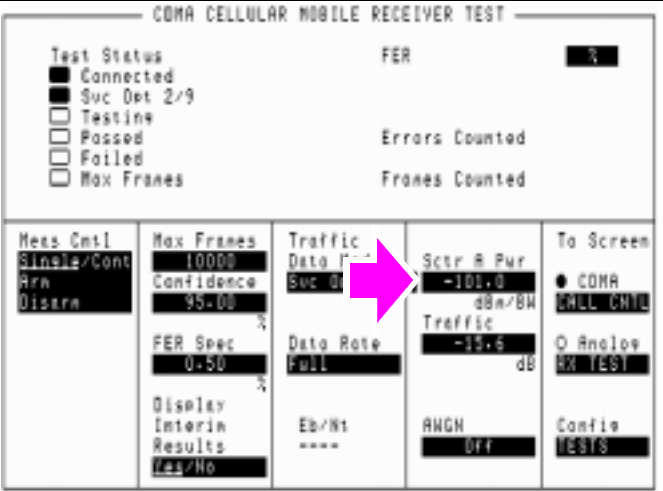

HP-IB Syntax

"CDMA:CELL:ASEC -101"

7. Set the FER specification.

<p>Manual Operation:</p> <ol style="list-style-type: none"> 1. Position the cursor at the FER Spec field. 2. Set the value with the DATA keys. (Refer to the applicable standard for the recommended FER specification.) 3. Press the ENTER key or the knob to select the value. 	<p>The screenshot shows the 'CDMA CELLULAR MOBILE RECEIVER TEST' menu. At the top, 'Test Status' is 'Connected' and 'FER' is set to '1'. Below this, 'Errors Counted' and 'Frames Counted' are shown. The main menu is divided into several sections: 'Mess Cntl' (Single/Cont, Arr, Discrn), 'Max Frames' (10000), 'Confidence' (95.00), 'FER Spec' (1.00), 'Display Interim Results' (Yes/No), 'Traffic Data Mode' (Suc Dat 2), 'Data Rate' (Full), 'Eb/Nt' (----), 'Scrr B Pur' (-101.0), 'Traffic' (-15.5), 'ANGN' (Off), and 'To Screen' (CDMA, CALL CHNL, O Aneloe, WX TEST, Confie, TESTS). A red arrow points to the 'FER Spec' field.</p>
<p><i>In the FER Spec field, FER is expressed in percent. In the TIA IS-98 standards, FER is expressed without units. Example: If the TIA IS-98 required FER is 0.01, enter 1 in this field.</i></p> <p><i>Frame errors result when the Test Set determines that the frame data it received from the MSUT does not match the frame data sent.</i></p>	

HP-IB Syntax

"MEAS : CDM : FER : CONF : LIM 1"

8. Set the data rate.

Manual Operation:

1. Position the cursor at the Data Rate field.
2. Press the knob to display a list of choices.
3. Position the cursor at the desired data rate.
(Refer to the applicable standard for recommended data rate specifications.)
4. Press the knob to set the data rate.

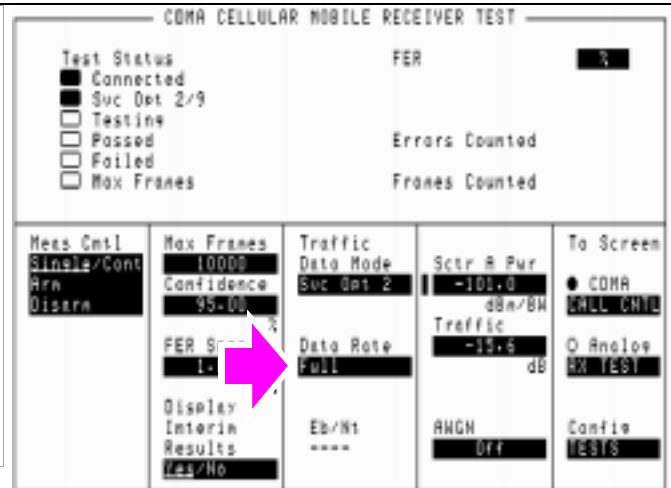

Service Option 2 data rate choices: Full=9600 bps, Half=4800 bps, Quarter=2400 bps, Eighth=1200 bps

Service Option 9 data rate choices: Full=14400 bps, Half=7200 bps, Quarter=3600 bps, Eighth=1800 bps

When the traffic channel's data rate is reduced the amount of processing gain is also reduced. To compensate for this reduction, Traffic E_c/I_{or} is increased (refer to tables in applicable test standards such as IS-98).

HP-IB Syntax

"MEAS:CDMA:CALL:TRAF:DATA:RATE `FULL`"



9. Set up the display to show interim results (Optional).

<p>Manual Operation:</p> <ol style="list-style-type: none"> 1. Position the cursor at the Display Interim Results field. 2. Press the knob to toggle the selection to <u>Yes</u>. 	<p>The screenshot shows the 'CDMA CELLULAR MOBILE RECEIVER TEST' menu. At the top, 'Test Status' is 'FER' with a 'Y' indicator. Below are checkboxes for 'Connected', 'Svc Det 2/9', 'Testing', 'Passed', 'Failed', and 'Max Frames'. The bottom section is a grid of settings: 'Max Frames' (10000), 'Confidence' (95.00), 'FER Spec' (1.00), 'Display Interim Results' (Yes/No), 'Traffic Data Mode' (Svc Det 2), 'Data Rate' (Full), 'Eb/Nt' (----), 'Sctr A Par' (-101.0), 'Traffic' (-15.6), 'ANCH' (Off), and 'To Screen' (CALL CNT, O Anlos, RX TEST, Confie, TESTS).</p>
<p><i>Setting up the display to show interim results allows real time observation of FER test results. If you are interested in observing the progress of an FER test or the point at which frame errors occur, you must select Yes in the Display Interim Results field.</i></p>	

HP-IB Syntax

"DISP:FER:INT:RES `YES`"

10. Arm a single measurement.

<p>Manual Operation:</p> <ol style="list-style-type: none"> 1. Position the cursor at the Arm field. 2. Press the knob to arm a measurement. 		
---	---	--

When a measurement is running, the Testing annunciator will be lit.

HP-IB Syntax

"TRIG:MODE:RETR SING" !selects Single measurement mode.

"TRIG:AST 'ARM'" !arms the measurement.

11. Monitor the annunciators to determine test status.

Manual Operation:

The measurement will end when either the Passed, Failed, or Max Frames annunciator lights.

The Confidence and FER Spec field settings determine pass/fail criteria.

Turning the Confidence field off will force the measurement to continue until the number of frames entered in the Max Frames field are counted.

HP-IB Help

Querying the Measuring Status Register condition register bit 0 will indicate when the FER test is done.

The following CDMA Status Register event register bits indicate whether a passed, failed, or max frames result was obtained from an FER test:

- Test Passed (Bit 10, BCD 1024)
- Test Failed (Bit 9, BCD 512)
- Max Frames (Bit 8, BCD 256)

These bits are "event" bits only. No condition registers are implemented. Since event bits "stick", it is important to clear the register before starting FER test. Refer to "CDMA Status Register Group" in the Status Reporting chapter of the *HP E8285A User's Guide* for information about using status bits.

HP-IB Syntax

"STATus:MEASuring:CONDition" !queries the Measuring Status Register condition register. This query can be used to determine if an FER test is running.

"CDMA:STATus:EVENT?" !queries the CDMA Status Register event register. This query can be used to determine whether the FER test passed, failed, or reached max frames.

Measuring Demodulation of Non-Slotted Mode Paging Channel in AWGN

During this measurement, the Test Set retrieves parameters from the mobile station that are used to calculate MER (Message Error Rate). MER indicates the mobile station's ability to receive messages on the Paging Channel while operating in the Mobile Station Idle State. This test is performed in the presence of AWGN (noise) which simulates noise created by interfering pilot signals.

The Test Set performs "Demodulation of Non-Slotted Mode Paging Channel in Additive White Gaussian Noise" as described in TIA/EIA IS-98A and ANSI J-STD 018. This test is only for phones that operate in non-slotted mode.

Measurement Overview

1. "Perform initial setup." on page 119.
2. "Make a Service Option 2 or 9 call." on page 119.
3. "Change the Paging Channel Data Rate to "Full"." on page 120.
4. "Set the Sector A Power and AWGN (test parameter \hat{I}_or / I_{oc})." on page 121.
5. "Set the test parameter Paging E_c/I_{or} ." on page 122.
6. "Cycle power to the mobile station." on page 123.
7. "Retrieve the mobile station parameters PAG_1 and PAG_2." on page 124.
8. "End the call and let the test run for 5 seconds or longer." on page 125.
9. "Once again, retrieve the mobile station parameters PAG_1 and PAG_2." on page 126.
10. "Calculate MER." on page 127.

1. Perform initial setup.

- "Preset the Test Set." on page 49
- "Correct for RF Path Loss." on page 50
- "Enter the MSUT's Protocol and RF Channel Standard." on page 51
- "Enter the MSUT's primary CDMA channel." on page 52
- "Adjust Sector A Power. (Optional)" on page 53
- "Save initial settings (Optional)" on page 54

2. Make a Service Option 2 or 9 call.

- "Connect the MSUT to the Test Set." on page 47
- "Turn on power to the MSUT and wait for the MSUT to find digital service." on page 48
- "Select the desired Service Option." on page 49
- "Register the MSUT (Optional)." on page 50
- "Make a call." on page 52

3. Change the Paging Channel Data Rate to "Full".

<p>Manual Operation:</p> <ol style="list-style-type: none"> 1. Press and release the SHIFT key and then press the CDMA SCREENS Call control key to display the CDMA CELL SITE CONFIGURATION screen. 2. Position the cursor at the Page Rate field. 3. Use the knob to select "Full" from the list of Choices. 		<table border="1"> <thead> <tr> <th colspan="4">CDMA CELL SITE CONFIGURATION</th> </tr> </thead> <tbody> <tr> <td>Protocol N-STD-008</td> <td>Non Power 0</td> <td>Pur Up Res On/Off</td> <td>Answer Auto</td> </tr> <tr> <td>Network ID 1</td> <td>Non Pur Ext 0</td> <td>Timer Res On/Off</td> <td>Coll L None/Pas</td> </tr> <tr> <td>System ID 4108</td> <td>Inst Power 0</td> <td>Res Period 29</td> <td>Pilot Inc 12</td> </tr> <tr> <td>Base ID 39</td> <td>Power Step 3</td> <td></td> <td>3rch Wm A 8</td> </tr> <tr> <td>Esc Mode On/Off</td> <td>Psm Size 10</td> <td></td> <td>3rch Wm N 8</td> </tr> <tr> <td>Entry Code 310</td> <td>Hum Step 5</td> <td></td> <td>3rch Wm R 8</td> </tr> <tr> <td>Network Code 0</td> <td>Max Ren Seq 342805F</td> <td>Authen On/Off</td> <td>To Screen CDMA CALL CHNL</td> </tr> <tr> <td>Restr NID 12</td> <td>Max Rsp Seq RAND50</td> <td></td> <td>0 Anclos PK TEST</td> </tr> <tr> <td>Restr SID 12</td> <td>Max Slot RANDU</td> <td></td> <td>Confir TESTS</td> </tr> <tr> <td></td> <td>Cycle Index 33750F</td> <td></td> <td></td> </tr> </tbody> </table>	CDMA CELL SITE CONFIGURATION				Protocol N-STD-008	Non Power 0	Pur Up Res On/Off	Answer Auto	Network ID 1	Non Pur Ext 0	Timer Res On/Off	Coll L None/Pas	System ID 4108	Inst Power 0	Res Period 29	Pilot Inc 12	Base ID 39	Power Step 3		3rch Wm A 8	Esc Mode On/Off	Psm Size 10		3rch Wm N 8	Entry Code 310	Hum Step 5		3rch Wm R 8	Network Code 0	Max Ren Seq 342805F	Authen On/Off	To Screen CDMA CALL CHNL	Restr NID 12	Max Rsp Seq RAND50		0 Anclos PK TEST	Restr SID 12	Max Slot RANDU		Confir TESTS		Cycle Index 33750F		
CDMA CELL SITE CONFIGURATION																																														
Protocol N-STD-008	Non Power 0	Pur Up Res On/Off	Answer Auto																																											
Network ID 1	Non Pur Ext 0	Timer Res On/Off	Coll L None/Pas																																											
System ID 4108	Inst Power 0	Res Period 29	Pilot Inc 12																																											
Base ID 39	Power Step 3		3rch Wm A 8																																											
Esc Mode On/Off	Psm Size 10		3rch Wm N 8																																											
Entry Code 310	Hum Step 5		3rch Wm R 8																																											
Network Code 0	Max Ren Seq 342805F	Authen On/Off	To Screen CDMA CALL CHNL																																											
Restr NID 12	Max Rsp Seq RAND50		0 Anclos PK TEST																																											
Restr SID 12	Max Slot RANDU		Confir TESTS																																											
	Cycle Index 33750F																																													

HP-IB Syntax

"DISP CCON;CDMA:CELL:CONF:PAGE:RATE 'Full'" !sets the Paging Channel data rate to 9600 bps (Full).

4. Set the Sector A Power and AWGN (test parameter \hat{I}_{or} / I_{oc}).

<p>Manual Operation:</p> <ol style="list-style-type: none"> 1. Press the GEN CTRL key to display the CDMA GENERATOR CONTROL screen. 2. Position the cursor at the AWGN field. 3. Set the value using the DATA keys. (Refer to the applicable standards for test parameters.) 4. Position the cursor at the Sctr A Pwr field. 5. Set the value using the DATA keys. (Refer to the applicable standards for test parameters.) 		
<p><i>The term used for AWGN in the applicable standard is I_{oc}.</i> <i>The term used for Sctr A Power in the applicable standard is I_{or}.</i></p>		

HP-IB Syntax

"CDMA:AWGN:STAT ON" !turns the Test Set's AWGN generator on.

"CDMA:AWGN -54" !sets AWGN to -54 dBm/BW.

"CDMA:CELL:ASEC -55" !sets Sctr A I_{or} to -55 dBm/BW

5. Set the test parameter Paging E_c/I_{or} .

<p>Manual Operation:</p> <ol style="list-style-type: none"> 1. Position the cursor at the Paging field. 2. Set the value with the DATA keys. (Refer to the applicable standard for test parameters.) 3. Press the ENTER key or the knob to select the value. 	CDMA GENERATOR CONTROL				
	Sctr A Pwr -75.0 dBm/BW	Sctr B Pwr Off	AWGN -74.0 dBm/BW		
	Pilot -7.0 dB	Walsh 0	Pilot -7.0 dB	Walsh 0	RF Power -71.46 dBm/BW
Sync -16.0 dB	32				
Paging -16.2 dB	0				
Traffic -15.6 dB	0	Traffic -16.0 dB	12		
DCNS -1.4107 dB	17	DCNS -1.1170 dB	42		
PN Offset 12		PN Offset 36			
				To Screen CDMA CALL CNTRL O Anelox RX TEST Confir TESTS	

HP-IB Syntax

"CDMA:CELL:ASEC:PAG:POW -16.2 !sets the Sector A Paging channel to -16.2 dB.

6. Cycle power to the mobile station.

Manual Operation:

Wait until the mobile station has found digital service (this should take no longer than about 30 seconds).

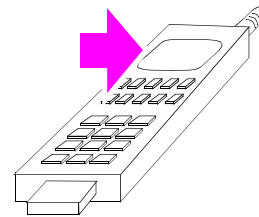

When the mobile station finds CDMA service, it enters the Mobile Station Idle State and initializes the following counters to zero:

PAG_1 - Paging Channel message CRC's (Cyclic Redundancy Check's)

PAG_2 - Invalid Paging Channel messages

PAG_4 - Paging Channel half-frames

The values of these counters are continually updated in the mobile station's table of Retrievable and Settable Parameters.

7. Retrieve the mobile station parameters PAG_1 and PAG_2.

Manual Operation:

1. Press the Call/Page key. When the call has connected, (watch the mobile station's display for an indication of "Loopback", "SO2", etc.) continue with the next step.
2. Press then release the blue Shift key, then press the TX test key to display the CDMA MOBILE REPORTED FER screen.
3. Position the cursor in front of the Mobile Parm field, and press the knob to display the list of Choices.
4. Position the cursor in front of mobile parameter PAG_1 in the list of choices and press the knob. When PAG_1 appears in the Mobile Parm field, the mobile station's current value for this parameter is displayed in the field below. Print and record the results using [table 3, "Mobile Station Parameters" on page 127](#).
5. Retrieve parameter PAG_2 using the same method described in step 4.

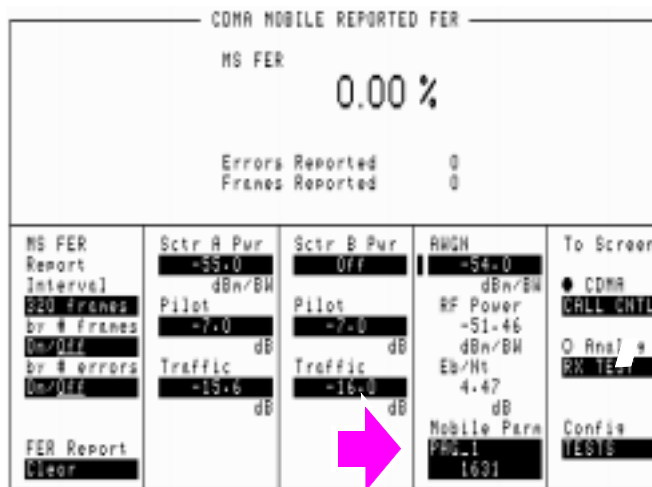

Each time a Mobile Parm field parameter is selected, a Retrieve Parameters Message is sent to the mobile station and the field below the parameter is updated.

The Mobile Parm field must be queried each time a parameter is required in order to obtain the most recently updated value.

8. End the call and let the test run for 5 seconds or longer.

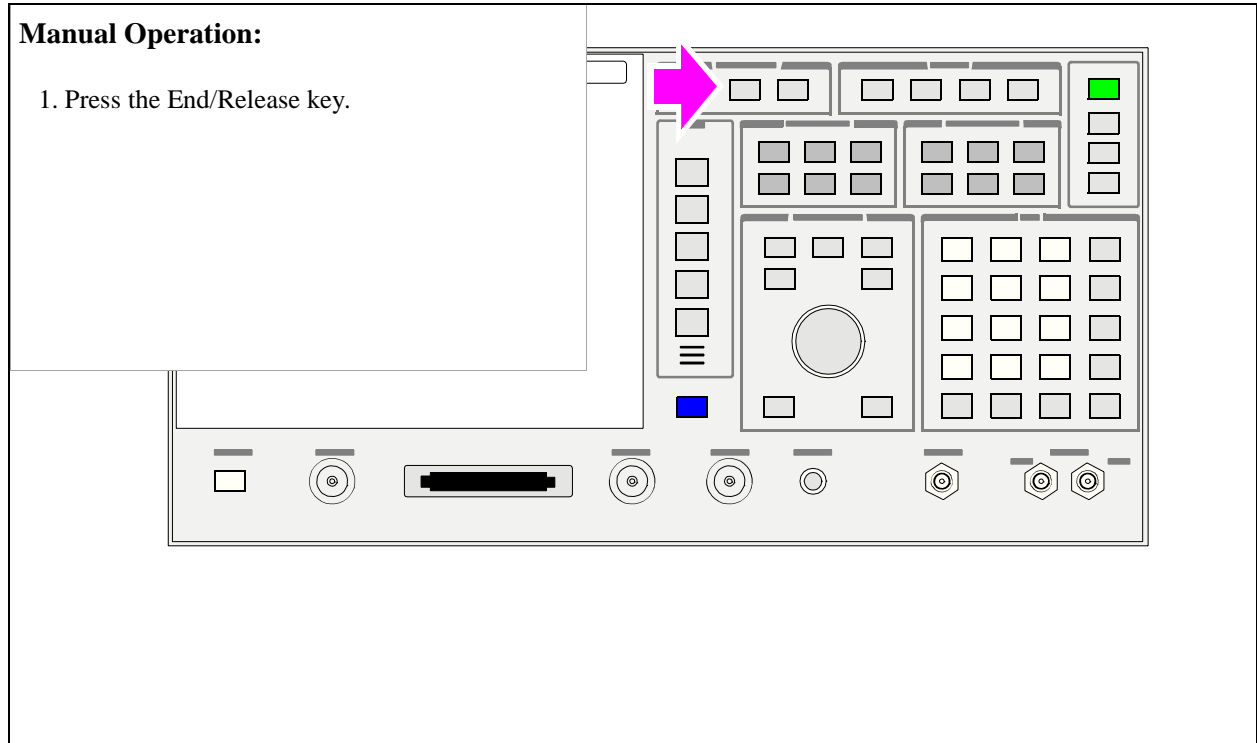

9. Once again, retrieve the mobile station parameters PAG_1 and PAG_2.

Manual Operation:

1. Press the Call/Page key. When the call has connected, continue with the next step.
2. Retrieve parameters PAG_1, PAG_2 and PAG_4. Print and record the results using [table 3, "Mobile Station Parameters" on page 127](#).

CDMA MOBILE REPORTED FER				
MS FER		0.00 %		
Errors Reported		0		
Frames Reported		0		
MS FER Report Interval	Sctr A Pwr	Sctr B Pwr	AWGN	To Screen
320 frames	-55.0 dBm/BW	Off	-54.0 dBm/BW	CDMA
On/Off	Pilot	Pilot	RF Power	CALL CNTL
by # frames	-7.0 dB	-7.0 dB	-51.46 dBm/BW	Q Analog
by # errors	Traffic	Traffic	Eb/Nt	RX TEST
On/Off	-15.6 dB	-16.0 dB	4.47 dB	Config
FER Report			Mobile Parm	TESTS
Clear			PAG_1	
			1631	

Each time a Mobile Parm field parameter is selected, a Retrieve Parameters Message is sent to the mobile station and the field below the parameter is updated.

The Mobile Parm field must be queried each time a parameter is required in order to obtain the most recently updated value.

10. Calculate MER.

$$MER = 1 - \left(\frac{(\Delta PAG1 - \Delta PAG2)}{\Delta PAG1} \right)$$

Table 3 Mobile Station Parameters

	Initial Values ^a	Test Values ^b	Delta
PAG_1			
PAG_2			

- a. Value is obtained by performing [Step 7](#).
- b. Value is obtained by performing [Step 9](#).

CDMA Transmitter Tests

"Measuring Waveform Quality" on page 130.

"Measuring Minimum/Maximum Power" on page 139.

"Measuring Maximum RF Output Power" on page 143.

"Measuring Minimum Controlled Output Power" on page 153.

"Measuring the Range of Open Loop Output Power" on page 164.

"Measuring Access Probe Output Power" on page 175.

Measuring Waveform Quality

The Test Set measures waveform quality using the correlated power method recommended in TIA/EIA IS-95. This measurement, called rho, is important because CDMA receivers use cross-correlation to demodulate signals. If a mobile station's waveform quality is low, it is necessary for the system to increase the mobile station's power level until the correlated power reaches the necessary level. The excess power represents interference to the system and could decrease capacity.

When a waveform quality measurement is made, the following measurements will be available:

- Rho (waveform quality)
- Frequency Error
- Phase Error
- Amplitude Error
- Time Offset
- Carrier Feedthrough

An **"HPBASIC Program Example" on page 137** is provided.

Measurement Overview

NOTE:

The following procedure covers all steps necessary to make the measurement from an instrument preset condition. Some steps may not be necessary if a measurement has already been made and, for example, a call is already connected.

For detailed step-by-step explanation see the page associated with the step.

1. **"Perform initial setup." on page 131.**
2. **"Make a Service Option 2 or 9 call." on page 131.**
3. **"Set the Traffic channel level (test parameter Traffic Ec/Ior)." on page 132.**
4. **"Set Sector A Power (test parameter $\hat{I}or$)." on page 133.**
5. **"Arm a single measurement." on page 134.**
6. **"Measure Rho." on page 135.**

1. Perform initial setup.

- "Preset the Test Set." on page 49
- "Correct for RF Path Loss." on page 50
- "Enter the MSUT's Protocol and RF Channel Standard." on page 51
- "Enter the MSUT's primary CDMA channel." on page 52
- "Adjust Sector A Power. (Optional)" on page 53
- "Save initial settings (Optional)" on page 54

2. Make a Service Option 2 or 9 call.

- "Connect the MSUT to the Test Set." on page 47
- "Turn on power to the MSUT and wait for the MSUT to find digital service." on page 48
- "Select the desired Service Option." on page 49
- "Register the MSUT (Optional)." on page 50
- "Make a call." on page 52

3. Set the Traffic channel level (test parameter Traffic E_c/I_{or}).

<p>Manual Operation:</p> <ol style="list-style-type: none"> 1. Press the CDMA SCREENS - Gen control key to display the CDMA GENERATOR CONTROL screen. 2. Position the cursor at the Traffic field. 3. Set the Traffic E_c/I_{or} value with the DATA keys. (Refer to the applicable standard for recommended test parameters). 4. Press the ENTER key or the knob to enter the value. 	CDMA GENERATOR CONTROL					
	Sctr A Pwr -75.0 dBm/BW		Sctr B Pwr Off		ANCH Off	
	Pilot -7.0 dB	Walsh 0	Pilot -7.0 dB	Walsh 0	RF Power -75.00 dBm/BW	Eb/Nt ----
	Sync -16.0 dB	32			To Screen CDMA CELL CTRL Q Analog RX TEST Config TESTS	
Paging -12.0 dB	1	Traffic -16.0 dB	12			
Traffic -7.4 dB	17	DCNS -1.1178 dB	42			
DCNS -2.8925 dB		PH Offset 12	36			

Values in this field are expressed in dB, relative to Sctr A Pwr.

HP-IB Syntax

"DISP CGEN;CDMA:CELL:ASEC:TRAF -7.4" ! Displays the CDMA GENERATOR CONTROL screen and sets the Traffic field to -7.4 dB.

4. Set Sector A Power (test parameter \hat{I}_{or}).

Manual Operation:

1. Position the cursor at the Sctr A Pwr field.
2. Set the value with the DATA keys. (Refer to the applicable standard for test parameters).
3. Press the ENTER key or the knob to enter the value.

Note: Sector A Power can be set from several other screens, including the CDMA CALL CONTROL screen.

The value for Sector A Power is referred to as I_{or} .

CDMA GENERATOR CONTROL					
Sctr A Pwr -75.0 dBm/BW		Sctr B Pwr Off		AWGN Off	
Pilot -7.0 dB	Walsh 0	Pilot -7.0 dB	Walsh 0	RF Power -75.00 dBm/BW	Eb/Hs ----
Sync -16.0 dB	32			To Screen ● CDMA CALL CNTL ○ Analog RX TEST Cont'd TESTS	
Paging -12.0 dB	1				
Traffic -7.4 dB	8	Traffic -16.0 dB	12		
DCNS -2.8925 dB	17	DCNS -1.1178 dB	42		
PN Offset 12		PN Offset 36			

HP-IB Syntax

"CDMA:CELL:ASEC -75" ! Sets the Sector A power field to -75 dBm/BW

5. Arm a single measurement.

<p>Manual Operation:</p> <ol style="list-style-type: none"> 1. Press the CDMA SCREENS - TX test key to display the CDMA CELLULAR MOBILE TRANSMITTER TEST screen. 2. Position the cursor at the Arm field. 3. Press the knob to arm a measurement. 	<p>CDMA CELLULAR MOBILE TRANSMITTER TEST</p> <p>Traffic Rhd Phs Error dBm</p> <p>Freq Error Hz Ave Power dBm</p> <p style="text-align: center;">-0.34</p> <table border="1"> <tr> <td>Meas Cntl</td> <td>Traffic</td> <td>Scitr A Par</td> <td>To Screen</td> </tr> <tr> <td>Single/Cont</td> <td>Data Mode</td> <td>-75.0</td> <td>CDMA</td> </tr> <tr> <td>Arm</td> <td>Svc Opt 2</td> <td>dBm/BW</td> <td>CTRL CNTL</td> </tr> <tr> <td>Disarm</td> <td>Data Rate</td> <td>RF Power</td> <td>O Anolog</td> </tr> <tr> <td></td> <td>Full</td> <td>-75.00</td> <td>RX TEST</td> </tr> <tr> <td></td> <td>Power Meas</td> <td>dBm/BW</td> <td>Config</td> </tr> <tr> <td></td> <td>Zero</td> <td></td> <td>TESTS</td> </tr> </table>	Meas Cntl	Traffic	Scitr A Par	To Screen	Single/Cont	Data Mode	-75.0	CDMA	Arm	Svc Opt 2	dBm/BW	CTRL CNTL	Disarm	Data Rate	RF Power	O Anolog		Full	-75.00	RX TEST		Power Meas	dBm/BW	Config		Zero		TESTS
Meas Cntl	Traffic	Scitr A Par	To Screen																										
Single/Cont	Data Mode	-75.0	CDMA																										
Arm	Svc Opt 2	dBm/BW	CTRL CNTL																										
Disarm	Data Rate	RF Power	O Anolog																										
	Full	-75.00	RX TEST																										
	Power Meas	dBm/BW	Config																										
	Zero		TESTS																										
<p>The default trigger mode is <u>Single</u> for local operation. If <u>Cont</u> is selected (local operation), the Arm and Disarm fields are removed from the display and measurements trigger continuously.</p> <p>The default trigger mode is Repetitive for remote operation. Repetitive mode operates identically to <u>Cont</u>. The HP-IB command shown below is used to set the remote operation trigger mode to single.</p>																													

HP-IB Syntax

"TRIG:MODE:RETR SING" !selects Single measurement mode.
 "TRIG" ! Arms and triggers the waveform quality measurement.

6. Measure Rho.

Manual Operation:

1. Read the Traffic Rho measurement, Frequency Error, and Phase Error on the front panel display.
2. Position the cursor in front of the Freq Error field and select it. Selecting from the list of Choices, read Ampl Error (amplitude error) and Time Offset.
3. Position the cursor in front of the Phs Error field and select it. Selecting from the list of Choices, read Carrier (carrier feedthrough).

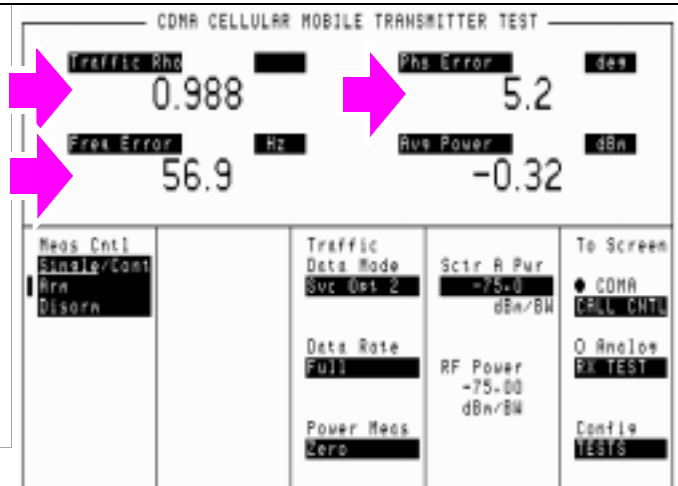

Several measurements are multiplexed with the Frequency Error and Phase Error measurements. By positioning the cursor next to the Freq Error or Phs Error fields shown in the figure above, then pressing the knob, the following measurements can be displayed by selecting them from the list of choices; Amplitude Error, Time Offset, and Carrier feedthrough.

All of the measurements, whether displayed or not, are available through the HP-IB query commands listed below providing a call is connected and measurement results are available.

By default, all of the measurements on the CDMA CELLULAR MOBILE TRANSMITTER TEST screen are on. The :STATe ON or :STATe OFF commands can be appended to any of the commands to turn them on or off.

HP-IB Help

If a valid measurement result is not available when one of the following measurement queries is sent, the Test Set will return 1.79 e+308.

HP-IB Syntax

"DISP CTXT;MEAS:CDM:RHO?" !queries the Rho measurement results
"DISP CTXT;MEAS:CDM:FREQ:ERR?" !queries the Frequency Error measurement results
"DISP CTXT;MEAS:CDM:AMPL:ERR?" !queries the Amplitude Error measurement results
"DISP CTXT;MEAS:CDM:PHAS:ERR?" !queries the Phase Error measurement results
"CDMA:RHO:MEAS:PERR 'Carrier'" !displays the Carrier feedthrough measurement, which is multiplexed with the phase error measurement

HPBASIC Program Example

The following programming example was developed using HPBASIC for Windows. It was tested on an HP E8285A.

```

10 ! re-save "c:\hpbasic\TX_QUAL"
20 ! This program implements CDMA TX quality measurement.
30 ! This closely follows T33 from the 83217A Software.
40 CLEAR 714 !Clear interface
50 CLEAR SCREEN
60 OUTPUT 714;"CDMA:CALL:END" !End any previous call
70 WAIT .1
80 OUTPUT 714;"*RST"
90 WAIT 2
100 Page_phone
110 CLEAR SCREEN
120 Meas_tx_quality
130 DISP "PROGRAM DONE"
140 END
150 Meas_tx_quality: SUB Meas_tx_quality
160 DISP "Measuring Rho (Transmitted waveform quality)"
170 OUTPUT 714;"CDMA:CELL:ASEC -75"
180 OUTPUT 714;"CDMA:CELL:ASEC:PIL -7;TRAF -7.4"
190 OUTPUT 714;"TRIG:MODE:RETR SINGLE"
200 OUTPUT 714;"DISP CTXT"
210 OUTPUT 714;"TRIG:AST 'ARM'"
220 OUTPUT 714;"MEAS:CDM:RHO?"
230 ENTER 714;Rho
240 OUTPUT 714;"MEAS:CDM:FREQ:ERR?;ERR:UNIT?"
250 ENTER 714;Freq_err,Freq_unit$
260 PRINT Freq_err,Freq_unit$
270 OUTPUT 714;"MEAS:CDM:AMPL:ERR?"
280 ENTER 714;Ampl
290 OUTPUT 714;"MEAS:CDM:TIME:OFFS?"
300 ENTER 714;Time_off
310 OUTPUT 714;"MEAS:CDM:PHAS:ERR?"
320 ENTER 714;Phase_err
330 OUTPUT 714;"MEAS:CDM:CAR:FEED?"

```

Chapter 4, CDMA Transmitter Tests

Measuring Waveform Quality

```
340 ENTER 714;Carrier_feed
350 PRINT "Rho = ";Rho
360 PRINT "Frequency Err = ";Freq_err;Freq_unit$
370 PRINT "Amplitude Err = ";Ampl
380 PRINT "Time Offset Err = ";Time_off
390 PRINT "Phase Err = ";Phase_err
400 PRINT "Carrier Feedthrough = ";Carrier_feed
410 SUBEND
420 Page_phone: SUB Page_phone
430 OUTPUT 714;"CDMA:CELL:ASEC:BWP -50 dBm;STAT ON"
440 OUTPUT 714;"CDMA:RFCH 384"
450 PRINT "WHEN THE MOBILE FINDS SERVICE, PRESS THE"
455 PRINT "CONTINUE SOFTKEY (F2)"
460 DISP "Waiting..."
470 PAUSE
480 OUTPUT 714;"CDMA:CALL:TRAF:DATA:MODE 'SVC OPT 2'"
490 OUTPUT 714;"CDMA:CALL:MAKE"
500 DISP "Mobile is being paged..."
510 REPEAT
520 WAIT .1
530 OUTPUT 714;"STAT:CDMA:EVENT?"
540 ENTER 714;Event_reg
550 UNTIL BIT(Event_reg,3)! Monitoring "Connected" annunciator bit
560 CLEAR SCREEN
570 PRINT "Page successful, mobile is connected"
580 DISP "SO2 Call is connected:"
590 SUBEND
```

Measuring Minimum/Maximum Power

This measurement, which is actually a firmware routine programmed into the Test Set, provides a quick way to determine an MSUT's minimum power and maximum power. Both open loop and closed loop power control drive the mobile station's power level up and down. Two power measurements will be displayed at the end of this procedure, which takes several seconds to complete.

The Minimum/Maximum Power measurement is described in the *HP E8285A Reference Guide*, Fields chapter.

Measurement Overview

NOTE:

The following procedure covers all steps necessary to make the measurement from an instrument preset condition. Some steps may not be necessary if a measurement has already been made and, for example, a call is already connected.

For detailed step-by-step explanation see the page associated with the step.

1. **"Perform initial setup." on page 140.**
2. **"Make a Service Option 2 or 9 call." on page 140.**
3. **"Select the Min/Max Power, Execute field ." on page 141.**
4. **"Measure Min/Max power." on page 142.**

1. Perform initial setup.

- "Preset the Test Set." on page 49
- "Correct for RF Path Loss." on page 50
- "Enter the MSUT's Protocol and RF Channel Standard." on page 51
- "Enter the MSUT's primary CDMA channel." on page 52
- "Adjust Sector A Power. (Optional)" on page 53
- "Save initial settings (Optional)" on page 54

2. Make a Service Option 2 or 9 call.

- "Connect the MSUT to the Test Set." on page 47
- "Turn on power to the MSUT and wait for the MSUT to find digital service." on page 48
- "Select the desired Service Option." on page 49
- "Register the MSUT (Optional)." on page 50
- "Make a call." on page 52

3. Select the Min/Max Power, Execute field .

<p>Manual Operation:</p> <ol style="list-style-type: none"> 1. Press then release the blue SHIFT key, then press the Authentication key to select the CDMA TRANSMITTER POWER RANGE TEST screen. 2. Position the cursor at the Min/Max Pwr, Execute field.  3. Press the knob to begin the Min/Max measurement. 	<p style="text-align: center;">CDMA TRANSMITTER POWER RANGE TEST</p> <p>Max Power 22.46 dBm Avg Power dBm -----</p> <p>Min Power -54.73 dBm Ideal Mobile Power: 2.0 dBm</p>				
	Min/Max Pwr	Closed Loop Pwr Cntl	Traffic Data Mode	Scir A Pwr	To Screen
	Execute	Closed Loop Change n down	Svc Opt 2	-78.0 dBm/BW	CDMA CALL CTRL
Mobile Power Mode	Steps 50	Data Rate Full	Traffic -15.6 dB	0 Analog Rx TEST	
Manual/User	Execute	Power Meas	Output Atten Hold On/Off	Config TESTS	
	Drop Timer On/Off	Power Meas Zero			

HP-IB Syntax

"MEAS:CDM:MMP" !executes the Min/Max power measurement

4. Measure Min/Max power.

Manual Operation:

Read the Min Power and Max Power fields.

CDMA TRANSMITTER POWER RANGE TEST

Max Power
 22.46
 dBm

Avg Power

dBm

Min Power
 -54.73
 dBm

Ideal Mobile Power: 2.0 dBm

Min/Max Pwr	Closed Loop Pwr Cntl	Traffic Data Mode	Scrr R Pwr	To Screen
Execute	Closed Loop Change	Svc Opt 2	-18.0 dBm/dB	CDMA CALL CNTL
Mobile Power Mode	Steps 50	Data Rate Full	Traffic -15.6 dB	0 Analog RX TEST
Normal/User	Execute	Power Mess Zero	Output Atten Hold On/Off	Config TESTS
	Drop Tiner On/Off			

HP-IB Syntax

"DISP CTXR;CDMA:MOB:POW:MIN?" !displays the CDMA TRANSMITTER POWER RANGE TEST screen and queries the last Min power value

"DISP CTXR;CDMA:MOB:POW:MAX?" !displays the CDMA TRANSMITTER POWER RANGE TEST screen and queries the last Max power value

Measuring Maximum RF Output Power

The Test Set measures mobile-station-under-test (MSUT) power using an average power meter. This test is performed according to TIA/EIA IS-98.

An ["HPBASIC Programming Example" on page 151](#) is provided.

Measurement Overview

NOTE:

The following procedure covers all steps necessary to make the measurement from an instrument preset condition. Some steps may not be necessary if a measurement has already been made and, for example, a call is already connected.

For detailed step-by-step explanation see the page associated with the step.

1. ["Perform initial setup." on page 144.](#)
2. ["Enter the parameters for the Access Parameters message \(optional\)." on page 145.](#)
3. ["Make a Service Option 2 or 9 call." on page 146.](#)
4. ["Set the Traffic channel level \(test parameter Traffic Ec/Ior\)." on page 147.](#)
5. ["Set Sector A Power \(test parameter \$\hat{I}or\$ \)." on page 148.](#)
6. ["Send continuous '0' power control bits to increase MSUT power." on page 149.](#)
7. ["Measure average power." on page 150.](#)

1. Perform initial setup.

- "Preset the Test Set." on page 49
- "Correct for RF Path Loss." on page 50
- "Enter the MSUT's Protocol and RF Channel Standard." on page 51
- "Enter the MSUT's primary CDMA channel." on page 52
- "Adjust Sector A Power. (Optional)" on page 53
- "Save initial settings (Optional)" on page 54

2. Enter the parameters for the Access Parameters message (optional).

Manual Operation:

1. Press then release the blue SHIFT key, then press the Call Control key to select the CDMA CELL SITE CONFIGURATION screen.
2. Set the parameter values for the following fields:
 Nom Power - 7
 Init Power - 15
 Power Step - 7
 Num Step - 15
 Max Req Seq/Max Rsp Seq - 15

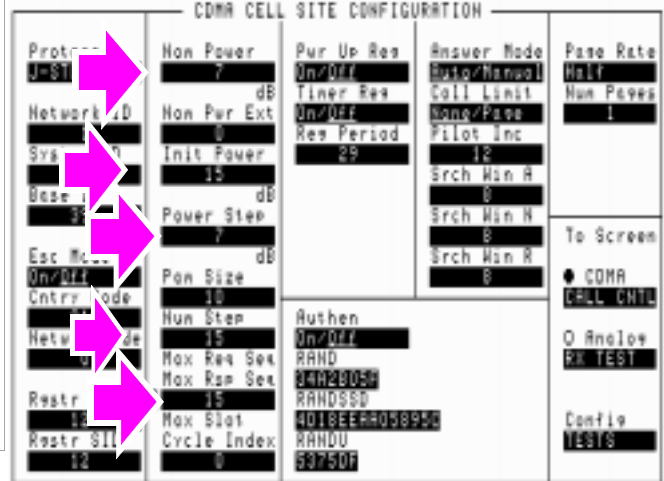

This step is optional because the Test Set will drive the mobile station to its maximum power level by sending "all up" power control bits regardless of these settings.

Refer to TIA/EIA/IS-98-A for a reference to these settings.

HP-IB Syntax

- "DISP CCON" ! displays the CDMA CELL CONFIGURATION screen.
- "CDMA:CELL:CONF:NOM:POW 7" !sets the Nom Power field to 7.
- "CDMA:CELL:CONF:INIT:POW 15" !sets the Init Power field to 15.
- "CDMA:CELL:CONF:STEP:POW 7" !sets the Power Step field to 7.
- "CDMA:CELL:CONF:NUMS 15" !sets the Num Step field to 15.
- "CDMA:CELL:CONF:MAXR 15" !sets the Max Req Seq/Max Rsp Seq field to 15.

3. Make a Service Option 2 or 9 call.

- "Connect the MSUT to the Test Set." on page 47
- "Turn on power to the MSUT and wait for the MSUT to find digital service." on page 48
- "Select the desired Service Option." on page 49
- "Register the MSUT (Optional)." on page 50
- "Make a call." on page 52

4. Set the Traffic channel level (test parameter Traffic E_c/I_{or}).

<p>Manual Operation:</p> <ol style="list-style-type: none"> 1. Press the CDMA SCREENS - Gen control key to display the CDMA GENERATOR CONTROL screen. 2. Position the cursor at the Traffic field. 3. Set the Traffic E_c/I_{or} value with the DATA keys. (Refer to the applicable standard for recommended test parameters). 4. Press the ENTER key or the knob to enter the value. 	CDMA GENERATOR CONTROL				
	Sctr A Pwr -75.0 dBm/BW	Sctr B Pwr Off	AWGN Off		
	Pilot -7.0 dB	Walsh 0	Pilot -7.0 dB	Walsh 0	RF Power -75.00 dBm/BW
	Sync -16.0 dB	32			To Screen CDMA CELL CNTL O Anclos PR TEST Config TESTS
Pasine -12.0 dB	1				
Traffic -7.4 dB	17	Traffic -16.0 dB	12		
DCNS -2.0925 dB		DCNS -1.1178 dB	42		
PN Offset 12		PN Offset 36			

Values in this field are expressed in dB, relative to Sector A Power.

HP-IB Syntax

```
"DISP CGEN;CDMA:CELL:ASEC:TRAF -7.4"
! displays the CDMA GENERATOR CONTROL screen
! and sets Traffic  $E_c/I_{or}$  to -7.4 dB.
```

5. Set Sector A Power (test parameter I_{or}).

<p>Manual Operation:</p> <p>1. Position the cursor at the Sctr A Pwr field.</p> <p>2. <i>Gradually</i> adjust power to the required value for this test using the Cursor Control knob. The call may drop if Sector A Power is lowered too abruptly. Isolating the mobile station from outside RF interference will help eliminate this problem.</p> <p>(Refer to the applicable standard for test parameters).</p>	CDMA GENERATOR CONTROL										
	Sctr A Pwr -104.0 dBm/BW		Sctr B Pwr Off		AWGN Off						
Pilot -7.0 dB		Walsh 0		Pilot -7.0 dB		Walsh 0		RF Power -104.00 dBm/BW		Eb/Nt ----	
Sync -16.0 dB		32								To Screen	
Pilot -12.0 dB		1								CDMA CALL CHNL	
Traffic -7.4 dB		8		Traffic -16.0 dB		12				O Aneloc W TEST	
DCNS -2.8925 dB		17		DCNS -3.1178 dB		42				Confir TESTS	
PN Offset 12				PN Offset 36							

The value for Sector A Power is referred to as I_{or} .

HP-IB Help If the call drops, you may need to decrement power to -105 dBm/BW more gradually.

HP-IB Syntax
 "CDMA:CELL:ASEC -104" !sets I_{or} to -104 dBm/BW.

6. Send continuous '0' power control bits to increase MSUT power.

<p>Manual Operation:</p> <ol style="list-style-type: none"> 1. Press then release the blue SHIFT key, then press the Authentication key to select the CDMA TRANSMITTER POWER RANGE TEST screen. 2. Position the cursor at the Closed Loop Power Control field and select Always Up. 	
<p><i>The Closed Loop Power Control selection 'Always Up' causes the Test Set to send '0' power control bits which increase the MSUT's output power.</i></p>	

HP-IB Syntax

"CDMA:PCON:MODE 'Always Up'" !selects continuous '0' power control bits.

7. Measure average power.

<p>Manual Operation:</p> <p>Read the average power measurement.</p>	
--	--

HP-IB Syntax

"MEAS:CDM:AVGP?" !queries the Average Power measurement.

HPBASIC Programming Example

The following programming example was developed using HPBASIC for Windows. It was tested on an HP E8285A.

```
10 ! re-save "c:\hpbasic\MAX_POW"
20 ! This program implements CDMA Max Output Power test.
30 ! This closely follows T36 from the 83217A Software.
40 !
50 Initialize_ts ! Initialize test set routine
60 Page_phone ! Requires the phone to have been previously registered
70 Max_output_pow ! Measure max power
80 OUTPUT 714;"CDMA:CALL:END"
90 DISP "PROGRAM DONE"
100 END
110 Max_output_pow: SUB Max_output_pow
120 CLEAR SCREEN
130 DISP "Measuring the mobiles' maximum output power..."
140 OUTPUT 714;"CDMA:TX:POW:MEAS 'Avg Power';:MEAS:CDM:AVG:STAT ON"
150 !The following 5 lines set up parameters that
160 !help drive the phone to its maximum power
170 OUTPUT 714;"CDMA:CELL:CONF:NOM:POW 7"
175 OUTPUT 714;"CDMA:CELL:CONF:INIT:POW 15"
180 OUTPUT 714;"CDMA:CELL:CONF:STEP:POW 7"
185 OUTPUT 714;"CDMA:CELL:CONF:NUMS 15"
185 OUTPUT 714;"CDMA:CELL:CONF:MAXR 15"
190 OUTPUT 714;"CDMA:CELL:ASEC:PIL -7dB;SYNC -16dB;PAG -12dB;TRAF -7.4dB"
200 OUTPUT 714;"MEAS:CDM:AVGP:UNITS DBM"
210 !Lower Ior to increase mobile power
220 ! Do this in short steps to prevent dropping a call. Also, the IS-98
230 ! specifies -104 dBm/BW, but most mobiles will output max power at
240 ! -90 dBm/BW (forward). The test may be more reliable at -90 dBm/BW if the mobile
250 ! receiver has difficulty at -104 dBm/BW.
260 OUTPUT 714;"CDMA:CELL:ASEC:BWP -90 dBm"
270 WAIT .5
280 OUTPUT 714;"CDMA:CELL:ASEC:BWP -104 dBm"
290 WAIT .5
300 Select 'Always Up' to send a continues stream of 'Up' power control bits
```

Chapter 4, CDMA Transmitter Tests

Measuring Maximum RF Output Power

```
310 OUTPUT 714;"CDMA:PCON:MODE 'Always Up'"
320 WAIT 3 ! Give the phone a little time to get to max output.
330 OUTPUT 714;"MEAS:CDM:AVGP?;AVGP:UNIT?" ! Measure while still sending up bits
340 ENTER 714;Measured_val,Pwr_unit$
350 PRINT "Maximum Output Power is ";PROUND(Measured_val,-1);Pwr_unit$
360 SUBEND
370 Page_phone: SUB Page_phone
380 OUTPUT 714;"CDMA:CELL:ASEC:BWP -50 dBm;STAT ON"
390 OUTPUT 714;"CDMA:RFCH 384"
400 PRINT "WHEN THE MOBILE FINDS SERVICE, PRESS THE"
405 PRINT "CONTINUE SOFTKEY (F2)"
410 DISP "Waiting..."
420 PAUSE
430 OUTPUT 714;"CDMA:CALL:TRAF:DATA:MODE 'SVC OPT 2'"
440 OUTPUT 714;"CDMA:CALL:MAKE"
450 CLEAR SCREEN
460 DISP "Mobile is being paged..."
470 REPEAT
480 WAIT .1 !100 mS wait to allow Test Set to handle other tasks
490 OUTPUT 714;"STAT:CDMA:EVENT?"
500 ENTER 714;Event_reg
510 UNTIL BIT(Event_reg,3)! Monitoring "Connected" annunciator bit
520 CLEAR SCREEN
530 PRINT "Page successful, mobile is connected"
540 SUBEND
550 Initialize_ts: SUB Initialize_ts
560 CLEAR 714
570 CLEAR SCREEN
580 DISP "Initializing...."
590 OUTPUT 714;"*RST"! Reset
600 WAIT 3
610 OUTPUT 714;"*CLS" ! Clear event status registers
620 OUTPUT 714;"CONF:OFL:MODE 'ON';RFIN -2"! External Path Loss
630 SUBEND
```

Measuring Minimum Controlled Output Power

The Test Set measures the mobile-station-under-test (MSUT) power level using a calibrated Channel Power measurement. The Test Set performs this test as described in EIA/TIA IS-98.

An ["HPBASIC Programming Example" on page 161](#) is provided.

Measurement Overview

NOTE:

The following procedure covers all steps necessary to make the measurement from an instrument preset condition. Some steps may not be necessary if a measurement has already been made and, for example, a call is already connected.

For detailed step-by-step explanation see the page associated with the step.

1. ["Perform initial setup." on page 154.](#)
2. ["Make a Service Option 2 or 9 call." on page 155.](#)
3. ["Set the Traffic channel level \(test parameter Traffic Ec/Ior\)." on page 156.](#)
4. ["Set Sector A Power \(test parameter \$\hat{I}_or\$ \)." on page 157.](#)
5. ["Disable the Call Drop timer." on page 158.](#)
6. ["Send continuous "1" power control bits to decrease MSUT power." on page 159.](#)
7. ["Measure channel power." on page 160.](#)

1. Perform initial setup.

- "Preset the Test Set." on page 49
- "Correct for RF Path Loss." on page 50
- "Enter the MSUT's Protocol and RF Channel Standard." on page 51
- "Enter the MSUT's primary CDMA channel." on page 52
- "Adjust Sector A Power. (Optional)" on page 53
- "Save initial settings (Optional)" on page 54

2. Make a Service Option 2 or 9 call.

- "Connect the MSUT to the Test Set." on page 47
- "Turn on power to the MSUT and wait for the MSUT to find digital service." on page 48
- "Select the desired Service Option." on page 49
- "Register the MSUT (Optional)." on page 50
- "Make a call." on page 52

3. Set the Traffic channel level (test parameter Traffic E_c/I_{or}).

<p>Manual Operation:</p> <ol style="list-style-type: none"> 1. Press the CDMA SCREENS - Gen control key to display the CDMA GENERATOR CONTROL screen. 2. Position the cursor at the Traffic field. 3. Set the Traffic E_c/I_{or} value with the DATA keys. (Refer to the applicable standard for recommended test parameters). 4. Press the ENTER key or the knob to enter the value. 	CDMA GENERATOR CONTROL					
	Sctr A Pwr -25.0 dBm/BW		Sctr B Pwr Off		AMGN Off	
	Pilot -7.0 dB	Walsh 0	Pilot -7.0 dB	Walsh 0	RF Power -25.00 dBm/BW	Eb/Nt ---
	Sinc -16.0 dB	32			To Screen CDMA CALL CNTL O Anclos PK TEST Confis TESTS	
Pasins -12.0 dB	1	Traffic -16.0 dB	12			
Traffic -7.4 dB		DCNS -1.1178 dB	42			
DCNS -2.8925 dB	17	PN Offset 12	36			

Values in this field are expressed in dB, relative to Sctr A Pwr.

HP-IB Syntax

"DISP CGEN;CDMA:CELL:ASEC:TRAF -7.4" ! Sets the Sctr A Pwr field to -7.4 dB.

4. Set Sector A Power (test parameter I_{or}).

Manual Operation:

1. Position the cursor at the Sctr A Pwr field.
2. Set the value with the DATA keys. (Refer to the applicable standard for test parameters).
3. Press the ENTER key or the knob to select the value.



CDMA GENERATOR CONTROL					
Sctr A Pwr		Sctr B Pwr		AMGN	
-25.0 dBm/BW		Off		Off	
Pilot	Walsh	Pilot	Walsh	RF Power	Eb/Nt
-7.0	0	-7.0	0	-25.00	----
	dB		dB	dBm/BW	
Sync					
-16.0	32				
	dB				
Passing					
-12.0	1				
	dB				
Traffic		Traffic			
-7.4	8	-16.0	12		
	dB		dB		
DCNS		DCNS			
-2.8925	17	-1.1178	42		
	dB		dB		
PN Offset		PN Offset			
12		36			
					To Screen
					CDMA
					CALL CNTL
					O Analog
					Rx TEST
					Config
					TESTS

The value for Sector A Power is referred to as I_{or}

HP-IB Syntax

"CDMA:CELL:ASEC -25" !sets Sector A I_{or} to -25 dBm/BW.

5. Disable the Call Drop timer.

<p>Manual Operation:</p> <ol style="list-style-type: none"> 1. Press then release the blue SHIFT key, then press the Authentication key to select the CDMA TRANSMITTER POWER RANGE TEST screen. 2. Position the cursor at the Drop Timer field. 3. Press the knob to underline the word "Off". 	<p>The screenshot shows the 'CDMA TRANSMITTER POWER RANGE TEST' screen. At the top, it displays 'Chan Power' as 20.67 dBm and 'Ideal Mobile Power' as -29.0 dBm. Below this is a grid of settings:</p> <table border="1"> <tr> <td>Min/Max Pwr Execute</td> <td>Closed Loop Pwr Ctrl Always Up Change n down Steps 50 Execute</td> <td>Traffic Data Mode Suc Opt 2</td> <td>Sctr A Pwr -25.0 dBm/dB</td> <td>To Screen CDMA CALL CHNL</td> </tr> <tr> <td>Mobile Power Mode Normal/User</td> <td>Drop Timer On/Off</td> <td>Data Rate Full</td> <td>Traffic -7.4 dB</td> <td>O Anolog XX TEST</td> </tr> <tr> <td></td> <td></td> <td>Power Meas Calibrate</td> <td>Output Atten Hold On/Off</td> <td>Confie TESTS</td> </tr> </table> <p>A red arrow points to the 'Drop Timer' field, which is currently set to 'On/Off'.</p>	Min/Max Pwr Execute	Closed Loop Pwr Ctrl Always Up Change n down Steps 50 Execute	Traffic Data Mode Suc Opt 2	Sctr A Pwr -25.0 dBm/dB	To Screen CDMA CALL CHNL	Mobile Power Mode Normal/User	Drop Timer On/Off	Data Rate Full	Traffic -7.4 dB	O Anolog XX TEST			Power Meas Calibrate	Output Atten Hold On/Off	Confie TESTS
Min/Max Pwr Execute	Closed Loop Pwr Ctrl Always Up Change n down Steps 50 Execute	Traffic Data Mode Suc Opt 2	Sctr A Pwr -25.0 dBm/dB	To Screen CDMA CALL CHNL												
Mobile Power Mode Normal/User	Drop Timer On/Off	Data Rate Full	Traffic -7.4 dB	O Anolog XX TEST												
		Power Meas Calibrate	Output Atten Hold On/Off	Confie TESTS												
<p>When the Call Drop timer is "<u>On</u>", the Test Set ends the call any time a continuous sequence of 256 sequential frames is missed.</p> <p>Setting the call drop timer <u>Off</u> causes the Test Set to maintain the call regardless of missed frames. Missed frames are likely to occur during this test at the low power levels the MSUT will be operating under.</p>																

HP-IB Syntax

"CDMA:CALL:DTIMER 'Off' " ! Disables the call drop timer off

6. Send continuous "1" power control bits to decrease MSUT power.

Manual Operation:

Position the cursor at the Closed Loop Pwr Control field and select Always Down.

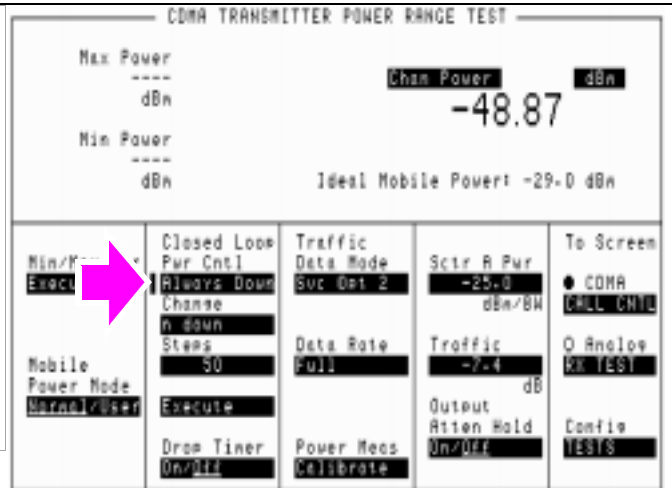

The Closed Loop Power Control selection 'Always Down' causes the Test Set to send '1' power control bits which decreases the MSUT's output power.

HP-IB Syntax

"CDMA:PCON:MODE 'Always Down'" !selects continuous '1' power control bits.

7. Measure channel power.

<p>Manual Operation:</p> <ol style="list-style-type: none"> 1. Position the cursor in front of the field shown and select Chan Power. 2. Read the channel power measurement. 	<p>CDMA TRANSMITTER POWER RANGE TEST</p> <p>Max Power ---- dBm</p> <p>Min Power ---- dBm</p> <p>Ideal Mobile Power: -29.0 dBm</p> <p>Chan Power: -48.87 dBm</p> <table border="1"> <tr> <td>Min/Max Pwr Execute</td> <td>Closed Loop Pwr Cntl Always Down Change n down Steps 50 Execute</td> <td>Traffic Data Mode Suc Oct 2</td> <td>Sctr A Pwr -25.6 dBm/BW</td> <td>To Screen CDMA CMML CHNL</td> </tr> <tr> <td>Mobile Power Mode Normal/User</td> <td>Drop Timer On/Off</td> <td>Data Rate Full</td> <td>Traffic -7.4 dB</td> <td>Q Aneloc OK TEST</td> </tr> <tr> <td></td> <td>Power Meas Calibrate</td> <td></td> <td>Output Atten Hold On/Off</td> <td>Confir TESTS</td> </tr> </table>	Min/Max Pwr Execute	Closed Loop Pwr Cntl Always Down Change n down Steps 50 Execute	Traffic Data Mode Suc Oct 2	Sctr A Pwr -25.6 dBm/BW	To Screen CDMA CMML CHNL	Mobile Power Mode Normal/User	Drop Timer On/Off	Data Rate Full	Traffic -7.4 dB	Q Aneloc OK TEST		Power Meas Calibrate		Output Atten Hold On/Off	Confir TESTS
Min/Max Pwr Execute	Closed Loop Pwr Cntl Always Down Change n down Steps 50 Execute	Traffic Data Mode Suc Oct 2	Sctr A Pwr -25.6 dBm/BW	To Screen CDMA CMML CHNL												
Mobile Power Mode Normal/User	Drop Timer On/Off	Data Rate Full	Traffic -7.4 dB	Q Aneloc OK TEST												
	Power Meas Calibrate		Output Atten Hold On/Off	Confir TESTS												

HP-IB Syntax

"CDMA:TX:POW:MEAS 'Chan Power'" !selects the Channel Power measurement.

"DISP CTRX;MEAS:CDM:CHAN?" !displays the CDMA TRANSMITTER POWER RANGE TEST screen and queries the Channel Power measurement.

HPBASIC Programming Example

The following programming example was developed using HPBASIC for Windows. It was tested on an HP E8285A with firmware rev A.02.26.

```
10 ! re-save "c:\e8285a\ex_progs\min_pwr.txt"
20 ! This program implements CDMA Minimum Power test.
30 ! This closely follows T37 from the 83217A Software.
40 ON TIMEOUT 7,5 GOTO End_of_program
50 Prot$="'J-STD-008'" !Enter mobile's protocol stack
60 Rfcs$="'KOR PCS P0'" !Enter mobile's RF channel standard
70 Rfch=525 !Enter mobile's primary CDMA RF Channel number
80 Sid$="2222"
90 Mcc$="241"
100 Mnc$="10"
110 Initialize_ts(Rfch,Prot$,Rfcs$,Sid$,Mcc$,Mnc$)!Preset and initialize test set
120 Reg_phone! Register the phone (Power-up registration must be off)
130 Page_phone ! Require mobile to have been previously registered
140 Min_pow ! Measure minimum output power
150 STOP
160 OUTPUT 714;"CDMA:CALL:END" ! Release the call
170 DISP "PROGRAM DONE"
180 End_of_program: !A timeout on the HP-IB will cause the program to branch here
190 END
200 Page_phone: SUB Page_phone
210 OUTPUT 714;"CDMA:CALL:TRAF:DATA:MODE 'SVC OPT 2'"
220 DISP "Mobile is being paged..."
240 REPEAT
250 WAIT .1 !100 mS wait to allow Test Set to handle other tasks
260 OUTPUT 714;"STAT:CDMA:EVENT?"
270 ENTER 714;Event_reg
280 UNTIL BIT(Event_reg,3)! Monitoring "Connected" annunciator bit
290 DISP ""
300 PRINT "Page successful, mobile is connected"
310 SUBEND
320 Min_pow: SUB Min_pow
330 DISP "Measuring Minimum Power ...."
340 OUTPUT 714;"CDMA:CELL:ASEC:BWP -25" ! Sector A power
```

Chapter 4, CDMA Transmitter Tests

Measuring Minimum Controlled Output Power

```
350 OUTPUT 714;"CDMA:CELL:ASEC:TRAF -7.4" ! Sector A traffic level
360 WAIT .3
370 OUTPUT 714;"CDMA:CALL:DTIMER 'Off'" ! Disable drop timer
380 OUTPUT 714;"CDMA:PCON:MODE 'Always Down'" ! Send all down power control bits
390 OUTPUT 714;"CDMA:TX:POW:MEAS 'Chan Power'" ! Select Channel Power Measurement
400 OUTPUT 714;"MEAS:CDM:CHAN:UNITS DBM;STAT ON"
410 WAIT 2! Give the phone a little time to get settled at Minimum Power
420 OUTPUT 714;"MEAS:CDM:CHAN?"
430 ENTER 714;Mv
440 PRINT ""
450 PRINT "Minimum Power is ";PROUND(Mv,-1);" dB"
460 !Return the Test Set to Closed Loop Power Control Mode
470 OUTPUT 714;"CDMA:PCON:MODE 'Closed Loop'"
480 PRINT
490 SUBEND
500 Initialize_ts: SUB Initialize_ts(Rfch,Prot$,Rfcs$,Sid$,Mcc$,Mnc$)
510 CLEAR 714 ! Clear the HP-IB
520 CLEAR SCREEN
530 DISP "Initializing...."
540 OUTPUT 714;"*RST"! Reset
550 WAIT 5
560 OUTPUT 714;"*CLS" ! Clear event status registers
570 OUTPUT 714;"CONF:OFL:MODE 'ON';RFIN -2"! External Path Loss
580 OUTPUT 714;"CDMA:CELL:CONF:PUR 'Off'" !Turn off Power Up
Registration field
590 OUTPUT 714;"CDMA:CELL:ASEC:BWP -25 dBm;STAT ON" !Sector A
power setting
600 OUTPUT 714;"CDMA:CELL:PROT ";Prot$ !Protocol stack
610 OUTPUT 714;"CONF:RFCS ";Rfcs$ !Rf channel standard
620 OUTPUT 714;"CDMA:CELL:CONF:SID ";Sid$
630 OUTPUT 714;"CDMA:CELL:CONF:BCC ";Mcc$
640 OUTPUT 714;"CDMA:CELL:CONF:BNC ";Mnc$
650 OUTPUT 714;"CDMA:RFCH ";Rfch ! RF channel
660 DISP "waiting for service"
670 PAUSE
680 SUBEND
690 Reg_phone: SUB Reg_phone
```

```
700 OUTPUT 714;"CDMA:MOB:REG" !Initiate a zone-based
      registration
710 DISP "Test Set is registering the phone..."
720 T=TIMEDATE
730 REPEAT
740 OUTPUT 714;"STAT:CDMA:EVEN?"    !Query the CDMA Status
      Event Register
750 ENTER 714;Reg
760 IF TIMEDATE-T>25 THEN
770 DISP "Registration error, program stopped"
780 STOP
790 ELSE
800   WAIT .1 !Mandatory 100 ms wait to allow other Test Set processes
810 END IF
820 UNTIL BIT(Reg,11) !Bit 11 is the "Registered" bit
830 DISP ""
840 PRINT "Registration successful"
850 WAIT .2 !Wait for phone to prepare for page
860 SUBEND
```

Measuring the Range of Open Loop Output Power

The Test Set measures the range over which the mobile-station-under-test (MSUT) can adjust its Effective Radiated Power (ERP) in response to the power level it receives from the Test Set. This test is performed according to TIA IS-98 standards, except that \hat{I}_{or} is set to -35 dBm/BW instead of the recommended value of -25 dBm/BW for the first test.

A "HPBASIC Programming Example" on page 173 is provided.

Measurement Overview

NOTE:

The following procedure covers all steps necessary to make the measurement from an instrument preset condition. Some steps may not be necessary if a measurement has already been made and, for example, a call is already connected.

For detailed step-by-step explanation see the page associated with the step.

1. "Perform initial setup." on page 165.
2. "Make a Service Option 2 or 9 call." on page 166.
3. "Set the Traffic channel level (test parameter Traffic Ec/Ior)." on page 167.
4. "Set Sector A Power (test parameter \hat{I}_{or})." on page 168.
5. "Select alternating closed loop power control bits." on page 169.
6. "Measure the MSUT's power level." on page 170.
7. "Lower Sector A Power level, and measure power." on page 171.
8. "Lower Sector A Power level again, and measure power." on page 172.

1. Perform initial setup.

- "Preset the Test Set." on page 49
- "Correct for RF Path Loss." on page 50
- "Enter the MSUT's Protocol and RF Channel Standard." on page 51
- "Enter the MSUT's primary CDMA channel." on page 52
- "Adjust Sector A Power. (Optional)" on page 53
- "Save initial settings (Optional)" on page 54

2. Make a Service Option 2 or 9 call.

- "Connect the MSUT to the Test Set." on page 47
- "Turn on power to the MSUT and wait for the MSUT to find digital service." on page 48
- "Select the desired Service Option." on page 49
- "Register the MSUT (Optional)." on page 50
- "Make a call." on page 52

3. Set the Traffic channel level (test parameter Traffic E_c/I_{or}).

<p>Manual Operation:</p> <ol style="list-style-type: none"> 1. Press the CDMA SCREENS Gen control key to display the CDMA GENERATOR CONTROL screen. 2. Position the cursor at the Traffic field. 3. Set the value to -7.4 dB with the DATA keys. 3. Press the ENTER key or the knob to select the value. 	CDMA GENERATOR CONTROL				
	Sctr. A Pwr -25.0 dBm/BW	Sctr. B Pwr Off		RNGM Off	
	Pilot -7.0 dB	Walsh 0	Pilot -7.0 dB	Walsh 0	RF Power -25.00 dBm/BW
	Sync -16.0 dB	32			To Screen CDMA CALL CNTL O Anolog RX TEST Contis TESTS
Paging -12.0 dB	1	Traffic -16.0 dB	12		
Traffic -7.4 dB		Traffic -16.0 dB	42		
DCNS -2.8925 dB	17	DCNS -1.1178 dB	36		
PN Offset 12		PN Offset 36			

HP-IB Syntax

"CDMA:CELL:ASEC:TRAF -7.4" !sets Traffic E_c/I_{or} to -7.4 dB.

4. Set Sector A Power (test parameter \hat{I}_{or}).

<p>Manual Operation:</p> <ol style="list-style-type: none"> 1. Position the cursor next to the Sctr A Pwr field. 2. Set the value to -25 dBm/BW with the knob or DATA keys. 	CDMA GENERATOR CONTROL			
	Sctr A Pwr -25.0 dBm/BW	Sctr B Pwr Off	ANGN Off	
Pilot -7.0 dB	Walsh 0	Pilot -7.0 dB	Walsh 0	RF Power -25.00 dBm/BW
Sync -16.0 dB	32			To Screen ● CDMA CALL CNTL ○ Anclos PK TEST Cont'g TESTS
Pacing -12.0 dB	1			
Traffic -7.4 dB	8	Traffic -16.0 dB	12	
DCNS -2.8925 dB	17	DCNS -1.1178 dB	42	
PN Offset 12		PN Offset 36		

HP-IB Syntax

"CDMA:CELL:ASEC -25" Sets the Sctr A Pwr field to -25 dBm/BW.

5. Select alternating closed loop power control bits.

Manual Operation:

1. Press the CDMA SCREENS TX range key to display the CDMA TRANSMITTER POWER RANGE TEST screen.
2. Position the cursor at the Closed Loop Pwr Cntl field and press the knob to display the Choices menu.
3. Select Open Loop from the list of choices.

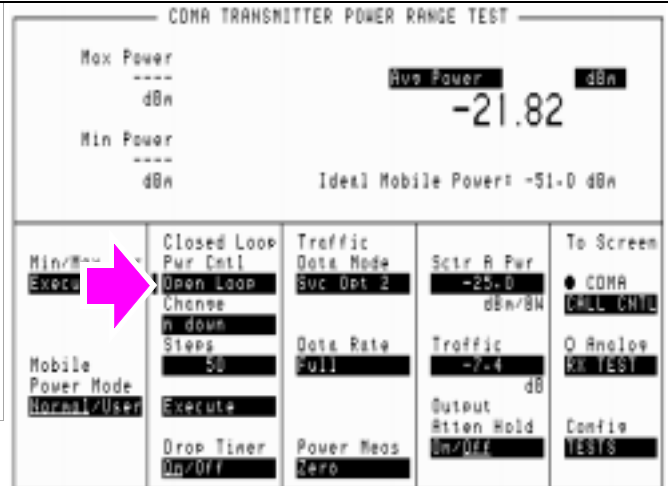

When Open Loop is selected, the Test Set sends alternating up/down power control bits on the Forward Traffic Channel.

HP-IB Syntax

- "DISP CTXR" !displays the CDMA TRANSMITTER CLOSED LOOP RANGE TEST screen.
- "CDMA:PCON:MODE 'Open Loop'" !selects Closed Loop power control mode.

6. Measure the MSUT's power level.

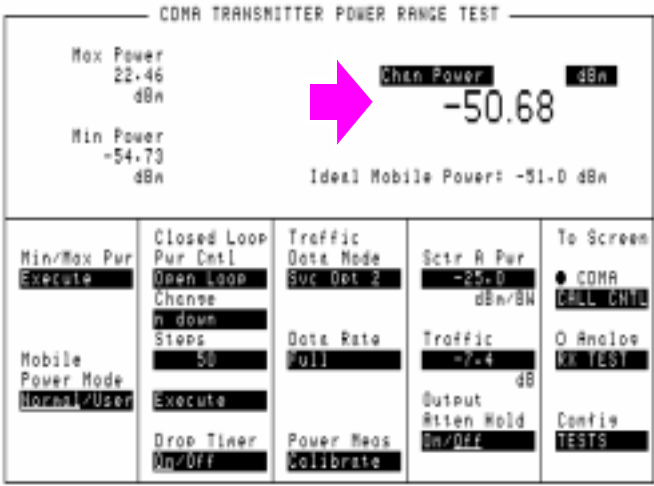
<p>Manual Operation:</p> <ol style="list-style-type: none"> 1. Position the cursor next to the field shown in the figure. 3. Press the knob to display the Choices menu. 4. Select Chan Power from the list of choices. 5. Read the power level. 	
---	--

HP-IB Syntax

"CDMA:TX:POW:MEAS 'Chan Power'" !selects the Channel Power measurement.

"MEAS:CDM:CHAN?" !queries the channel power measurement.

7. Lower Sector A Power level, and measure power.

Manual Operation:

1. Position the cursor next to the Sctr A Pwr field as shown in the figure.
2. Adjust the Sctr A Pwr field to -65 dBm/BW.

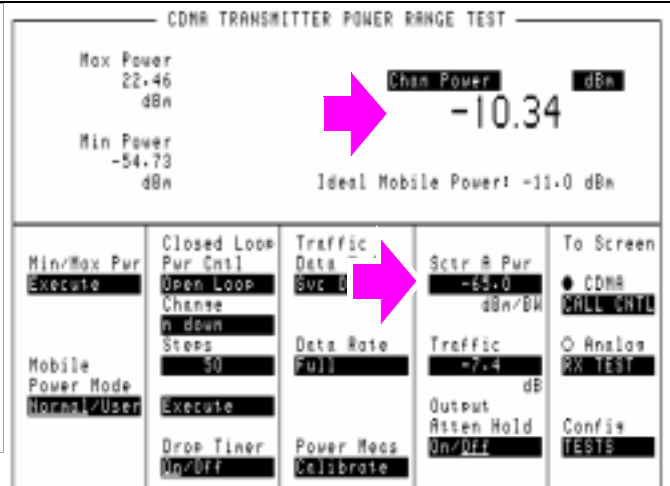

HP-IB Syntax

"CDMA:CELL:ASEC -65" !Sets the Sctr A Pwr field to -65 dBm/BW.

"MEAS:CDM:CHAN?" !queries the channel power measurement.

8. Lower Sector A Power level again, and measure power.

<p>Manual Operation:</p> <ol style="list-style-type: none"> 1. Position the cursor next to the Sctr A Pwr field as shown in the figure. 2. Adjust the field to the next \hat{f}or value. 	<p>CDMA TRANSMITTER POWER RANGE TEST</p> <p>Max Power ---- dBm</p> <p>Chan Power 24.54 dBm</p> <p>Min Power ---- dBm</p> <p>Ideal Mobile Power: 23.0 dBm</p> <table border="1"> <tr> <td>Min/Max Pwr Execute</td> <td>Closed Loop Pwr Cntl Open Loop Change n down Steps 50 Execute</td> <td>Traffic Data Svc 0 Data Rate Full Power Meas Calibrate</td> <td>Sctr A Pwr -104.0 dBm/BW</td> <td>To Screen CDMA CALL CNTL</td> </tr> <tr> <td>Mobile Power Mode Normal/User</td> <td>Drop Timer On/Off</td> <td></td> <td>Traffic -7.4 dB</td> <td>O Anolog Rx TEST</td> </tr> <tr> <td></td> <td></td> <td></td> <td>Output Atten Hold On/Off</td> <td>Config TESTS</td> </tr> </table>	Min/Max Pwr Execute	Closed Loop Pwr Cntl Open Loop Change n down Steps 50 Execute	Traffic Data Svc 0 Data Rate Full Power Meas Calibrate	Sctr A Pwr -104.0 dBm/BW	To Screen CDMA CALL CNTL	Mobile Power Mode Normal/User	Drop Timer On/Off		Traffic -7.4 dB	O Anolog Rx TEST				Output Atten Hold On/Off	Config TESTS
Min/Max Pwr Execute	Closed Loop Pwr Cntl Open Loop Change n down Steps 50 Execute	Traffic Data Svc 0 Data Rate Full Power Meas Calibrate	Sctr A Pwr -104.0 dBm/BW	To Screen CDMA CALL CNTL												
Mobile Power Mode Normal/User	Drop Timer On/Off		Traffic -7.4 dB	O Anolog Rx TEST												
			Output Atten Hold On/Off	Config TESTS												
<p><i>If the mobile station under test is power class 1, adjust Sector A Power to -104 dBm/BW.</i></p> <p><i>If the mobile station under test is power class 2, adjust Sector A Power to -98 dBm/BW.</i></p> <p><i>If the mobile station under test is power class 3, adjust Sector A Power to -93 dBm/BW.</i></p>																

HP-IB Syntax

"CDMA:CELL:ASEC -104" !Sets the Sctr A Pwr field to -104 dBm/BW.

"MEAS:CDM:CHAN?" !queries the average power measurement.

HPBASIC Programming Example

The following programming example was developed using HPBASIC for Windows. It was tested on an HP E8285A with firmware rev A.02.26.

```
10 ! re-store "c:\hpbasic\setrain\OPEN_RNG"
20 ! This program implements CDMA Open Loop Range test.
30 ! This closely follows T34 from the 83217A Software.
40 CLEAR SCREEN
50 OUTPUT 714;"*CLS"
60 OUTPUT 714;"CDMA:CALL:END"
70 WAIT 1
80 OUTPUT 714;"*RST" ! Good reset technique
90 WAIT 3
100 Page_phone
110 Open_loop_range
120 DISP "PROGRAM DONE"
130 END
140 Open_loop_range: SUB Open_loop_range
150 CLEAR SCREEN
160 DISP "TESTING OPEN LOOP RANGE"
170 OUTPUT 714;"CDMA:CELL:ASEC:BWP -25 dBm"
180 OUTPUT 714;"CDMA:PCON:MODE 'Open Loop'"
190 OUTPUT 714;"MEAS:CDM:CHAN:STAT ON"
195 OUTPUT 714;"MEAS:CDM:AVGP:STAT ON"
200 OUTPUT 714;"CDMA:TX:POW:MEAS 'Chan Power'"210 OUTPUT 714;"MEAS:CDM:CHAN:UNIT
DBM"
220 OUTPUT 714;"MEAS:CDM:AVGP:UNIT DBM"
220 !The following code tests mobile at -25, -65, and -105 dBm
230 FOR I=-25 TO -105 STEP -5
240 OUTPUT 714;"CDMA:CELL:ASEC:BWP "&VAL$(I)&" dBm"
250 WAIT 1 ! Let mobile settle
260 SELECT I
270 CASE -25,-65
280 OUTPUT 714;"MEAS:CDM:CHAN?"
290 ENTER 714;Measured_val
300 PRINT "Measured Power at ";VAL$(I)&" dbm = ";Measured_val;" dBm"
310 CASE -105
```

Chapter 4, CDMA Transmitter Tests

Measuring the Range of Open Loop Output Power

```
320 OUTPUT 714;"CDMA:TX:POW:MEAS 'Avg Power'"
330 OUTPUT 714;"MEAS:CDM:AVGP?"
340 ENTER 714;Measured_val
350 PRINT "Measured Power at ";VAL$(I)&" dbm = ";Measured_val;" dBm"
360 END SELECT
370 NEXT I
380 OUTPUT 714;"CDMA:CELL:ASEC:BWP -60" !So call doesn't drop
390 OUTPUT 714;"CDMA:PCON:MODE 'CLOSED LOOP'"
400 SUBEND
410 Page_phone: SUB Page_phone
420 OUTPUT 714;"CDMA:CELL:ASEC:BWP -50 dBm;STAT ON"
430 OUTPUT 714;"CDMA:RFCH 384"
440 PRINT "WHEN THE MOBILE FINDS SERVICE, PRESS CONTINUE (F2)"
450 DISP "Waiting..."
460 PAUSE
470 OUTPUT 714;"CDMA:CALL:TRAF:DATA:MODE 'SVC OPT 2'"
480 OUTPUT 714;"CDMA:CALL:MAKE"
490 DISP "Mobile is being paged..."
500 REPEAT
510 WAIT .1 !100 mS wait to allow Test Set to handle other tasks
520 OUTPUT 714;"STAT:CDMA:EVENT?"
530 ENTER 714;Event_reg
540 UNTIL BIT(Event_reg,3)! Monitoring "Connected" annunciator bit
550 CLEAR SCREEN
560 PRINT "Page successful, mobile is connected"
570 SUBEND
```

Measuring Access Probe Output Power

There are two methods available for measuring access probe power with the Test Set:

- Select the Acc Prb Pwr field.

The Acc Prb Pwr field, located on the CDMA CALL CONTROL, CDMA CELLULAR MOBILE TRANSMITTER TEST, and CDMA TRANSMITTER POWER RANGE TEST screens, automatically senses when the mobile station power level crosses a threshold (approximately -55 dBm/BW) and measures access probe power during each sequence. When an access attempt has completed, the last access probe power measurement is displayed.

Access probe power can be measured by the Test Set during registration, call setup, or when SMS or Authentication testing is performed on paging channels. This method requires no additional equipment or setup procedures beyond what is required for channel power measurements. Refer to the *Reference Guide*, Fields chapter for a complete description of the Acc Prb Pwr field.

- Use a Spectrum Analyzer as described in the procedure described below.

When using a spectrum analyzer, which allows each individual access probe to be displayed, the Test Set provides call setup only while the HP 859XE provides measurements. The Test Set is put in a mode that limits the progression of call processing states, allowing the MSUT to transmit the maximum number of access probe sequences.

An **"HPBASIC Programming Example" on page 186** is provided at the end of this section.

Measurement Overview

NOTE:

The following procedure covers all steps necessary to make the measurement from an instrument preset condition. Some steps may not be necessary if a measurement has already been made and, for example, a call is already connected.

For detailed step-by-step explanation see the page associated with the step.

1. "Perform initial setup." on page 177.
2. "Connect the test instruments as shown." on page 178.
3. "Set the Test Set to ignore all access attempts." on page 179.
4. "Set MAX_RSP_SEQ to 1." on page 180.
5. "Set the test parameter for ." on page 181.
6. "Register the MSUT." on page 182.
7. "Measure access probe power." on page 183.
8. "Change the access parameters message." on page 184.
9. "Measure access probe power." on page 185.

Recommended Equipment

Test Set.....HP E8285A
Spectrum Analyzer.....HP 8593E
Combiner.....Mini-Circuits ZFRSC-2050
Cabling.....Low-loss shielded RF cables

1. Perform initial setup.

- "Preset the Test Set." on page 49
- "Correct for RF Path Loss." on page 50
- "Enter the MSUT's Protocol and RF Channel Standard." on page 51
- "Enter the MSUT's primary CDMA channel." on page 52
- "Adjust Sector A Power. (Optional)" on page 53
- "Save initial settings (Optional)" on page 54

2. Connect the test instruments as shown.

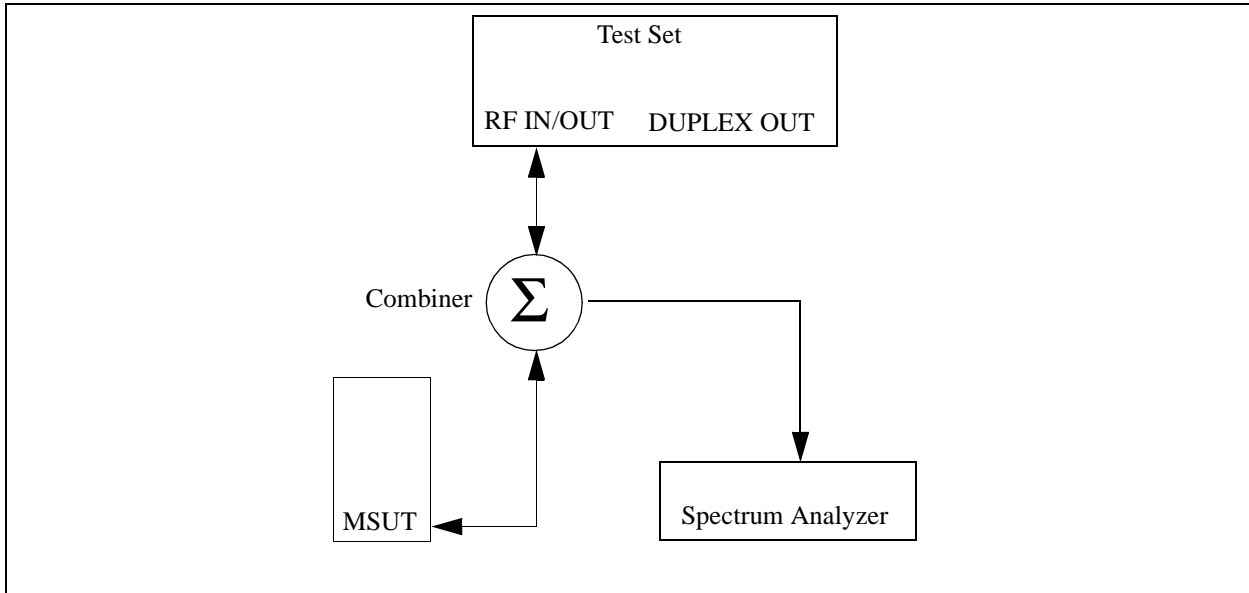

3. Set the Test Set to ignore all access attempts.

<p>Manual Operation:</p> <ol style="list-style-type: none"> 1. Press then release the blue SHIFT key then press the Call Control key to display the CDMA CELL SITE CONFIGURATION screen. 2. Position the cursor at the Call Limit field. 2. Press the knob to toggle the selection to <u>Page</u>. 	<p style="text-align: center;">CDMA CELL SITE CONFIGURATION</p> <table border="1"> <tr> <td>Protocol J-STD-008</td> <td>Non Power 0</td> <td>Pur Up Res On/Off</td> <td>Answer Mode Auto/Manual</td> <td>Page Rate Half</td> </tr> <tr> <td>Network ID 1</td> <td>Non Pur Ext 0</td> <td>Timer On/Off</td> <td>Call Limit None/Pass</td> <td>Non Power 1</td> </tr> <tr> <td>System ID 418B</td> <td>Init Power 0</td> <td>Rep Freq 29</td> <td>Pilot Inc 12</td> <td></td> </tr> <tr> <td>Base ID 39</td> <td>Power Step 3</td> <td></td> <td>srch Wm A 8</td> <td></td> </tr> <tr> <td>Esc Mode On/Off</td> <td>Power Step 3</td> <td></td> <td>srch Wm H 8</td> <td></td> </tr> <tr> <td>Entry Code 310</td> <td>Power Step 3</td> <td></td> <td>srch Wm R 8</td> <td>To Screen CDMA CALL CHNL</td> </tr> <tr> <td>Network Code 0</td> <td>Power Step 3</td> <td></td> <td></td> <td>O Anclos Vx TEST</td> </tr> <tr> <td>Restr NID 12</td> <td>Power Step 3</td> <td></td> <td></td> <td>Contia TESTS</td> </tr> <tr> <td>Restr SID 12</td> <td>Power Step 3</td> <td></td> <td></td> <td></td> </tr> </table>	Protocol J-STD-008	Non Power 0	Pur Up Res On/Off	Answer Mode Auto/Manual	Page Rate Half	Network ID 1	Non Pur Ext 0	Timer On/Off	Call Limit None/Pass	Non Power 1	System ID 418B	Init Power 0	Rep Freq 29	Pilot Inc 12		Base ID 39	Power Step 3		srch Wm A 8		Esc Mode On/Off	Power Step 3		srch Wm H 8		Entry Code 310	Power Step 3		srch Wm R 8	To Screen CDMA CALL CHNL	Network Code 0	Power Step 3			O Anclos Vx TEST	Restr NID 12	Power Step 3			Contia TESTS	Restr SID 12	Power Step 3			
Protocol J-STD-008	Non Power 0	Pur Up Res On/Off	Answer Mode Auto/Manual	Page Rate Half																																										
Network ID 1	Non Pur Ext 0	Timer On/Off	Call Limit None/Pass	Non Power 1																																										
System ID 418B	Init Power 0	Rep Freq 29	Pilot Inc 12																																											
Base ID 39	Power Step 3		srch Wm A 8																																											
Esc Mode On/Off	Power Step 3		srch Wm H 8																																											
Entry Code 310	Power Step 3		srch Wm R 8	To Screen CDMA CALL CHNL																																										
Network Code 0	Power Step 3			O Anclos Vx TEST																																										
Restr NID 12	Power Step 3			Contia TESTS																																										
Restr SID 12	Power Step 3																																													

Selecting Page in the Call Limit field will inhibit the Test Set from connecting a call, allowing the MSUT to transmit all of the access probe sequences.

HP-IB Syntax

```
"CDMA:CALL:LIM 'Page'"
!sets the Test Set to not complete the call when the MSUT transmits
!access probes.
```

4. Set MAX_RSP_SEQ to 1.

Manual Operation:

1. Position the cursor at the Max Req Seq
Max Rsp Seq field.
2. Use the knob to increment or decrement the
value to 1.

CDMA CELL SITE CONFIGURATION				
Protocol	Non Power	Pur Up Res	Answer Mode	Page Rate
U-STD-008	0	On/Off	Auto/Manual	HALT
Network ID	Non Pur Ext	Timer Res	Coll Limit	Non Pages
1	0	On/Off	None/Pass	1
System ID	Inst Power	Res Period	Pilot Inc	
4188	0	29	12	
Base ID	Power Step		Srch Wm A	
39	3		8	
Esc Mode	dB		Srch Wm H	
On/Off	dB		8	
Entry Code	Psm Size		Srch Wm R	
310	10		8	To Screen
Network Code	Num Step	Authen		CDMA
0	5	On/Off		CALL CHNL
Restr	Max Req Seq	RAND		O Anclos
1	Max Rsp Seq	84A2B05F		OK TEST
Restr S1	Max Slot	RAND550		
12	Cycle Index	401EEEA058950		Confie
		RANDU		TESTS
		837504		

The MAX_RSP_SEQ field determines how many power step sequences will be transmitted by the mobile station.

HP-IB Syntax

"DISP CCNF" !displays the CELL SITE CONFIGURATION screen"

"CDMA:CELL:CONF:MAXR 1"

5. Set the test parameter I_{or} .

<p>Manual Operation:</p> <ol style="list-style-type: none"> 1. Press the CDMA SCREENS Call control key to display the CDMA CALL CONTROL screen. 2. Position the cursor at the Sctr A Pwr field. 3. Set the value with the DATA keys. (Refer to the applicable standard for test parameters). 4. Press the ENTER key or the knob to enter the value. 	
--	--

HP-IB Syntax

"DISP CCNT" !displays the CDMA CALL CONTROL screen.
 "CDMA:CELL:ASEC -75" !sets I_{or} to -75 dBm/BW.

6. Register the MSUT.

See "**Register the MSUT (Optional).**" on page 50

Registering the MSUT provides the Test Set with the ESN (Electronic Serial Number), which is needed for the Test Set to perform a page.

When the mobile station registers with a base station, it responds with an access probe.

7. Measure access probe power.

Manual Operation:

1. Press the Call/Page key on the Test Set's front panel to page the MSUT.

Nominal settings for the Spectrum Analyzer are shown below.

Spectrum Analyzer settings:

Sweep Time: 5 s
Ref: -15.0 dBm
Vertical: 1 dB/Div
Span: 0 Hz

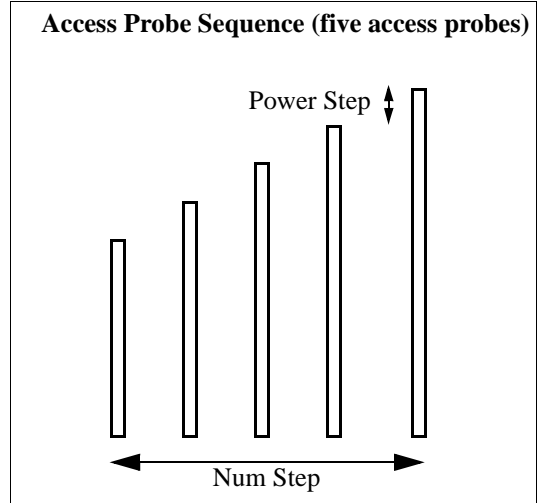

The figure above shows one access probe sequence, consisting of five access probes.

After the Call/Page key is pressed on the Test Set, the Page Sent annunciator will light to indicate that a paging message was sent to the MSUT.

The Access Probe annunciator will light to indicate that the mobile station has transmitted at least one access probe sequence in an attempt to gain system access.

HP-IB Syntax

"CDMA:CALL:MAKE" !pages the MSUT

8. Change the access parameters message.

<p>Manual Operation:</p> <ol style="list-style-type: none"> 1. Press the Previous key to select the CDMA CELL SITE CONFIGURATION screen. 2. Set the values for the following fields: Nom Power: 3 Init Power: 3 Power Step: 1 Num Step: 4 Max Rsp Seq: 3 		<table border="1"> <thead> <tr> <th colspan="5">CDMA CELL SITE CONFIGURATION</th> </tr> </thead> <tbody> <tr> <td>Proto</td><td>Non Power</td><td>Pur Up Res</td><td>Answer Mode</td><td>Page Rate</td> </tr> <tr> <td>U-STD</td><td>3</td><td>On/Off</td><td>Auto/Manual</td><td>Half</td> </tr> <tr> <td>Network Id</td><td>Non Pur Ext</td><td>Timer Res</td><td>Call Limit</td><td>Num Pages</td> </tr> <tr> <td>1</td><td>0</td><td>On/Off</td><td>None/Pass</td><td>1</td> </tr> <tr> <td>Srvt</td><td>Init Power</td><td>Res Period</td><td>Pilot Inc</td><td></td> </tr> <tr> <td>4</td><td>3</td><td>29</td><td>12</td><td></td> </tr> <tr> <td>Base Id</td><td>Power Step</td><td></td><td>Srch Win A</td><td></td> </tr> <tr> <td></td><td>1</td><td></td><td>8</td><td></td> </tr> <tr> <td>Ecd</td><td>Pen Size</td><td></td><td>Srch Win H</td><td></td> </tr> <tr> <td>On/Off</td><td>10</td><td></td><td>8</td><td></td> </tr> <tr> <td>Entry Lte</td><td>Num Step</td><td></td><td>Srch Win R</td><td></td> </tr> <tr> <td>1</td><td>4</td><td></td><td>8</td><td></td> </tr> <tr> <td>Net</td><td>Max Res Seq</td><td>Authn</td><td></td><td>To Screen</td> </tr> <tr> <td></td><td>Max Rsp Seq</td><td>On/Off</td><td></td><td>CDMA</td> </tr> <tr> <td>Rest</td><td>3</td><td>KAND</td><td></td><td>CALL CHIL</td> </tr> <tr> <td>Rest Sd</td><td>Max Slot</td><td>04A2B05F</td><td></td><td>O Anolog</td> </tr> <tr> <td>12</td><td>Cycle Index</td><td>PAND50</td><td></td><td>WR TEST</td> </tr> <tr> <td></td><td></td><td>4D18E8A058950</td><td></td><td>Confie</td> </tr> <tr> <td></td><td></td><td>KANDU</td><td></td><td>TESTS</td> </tr> <tr> <td></td><td></td><td>93750F</td><td></td><td></td> </tr> </tbody> </table>	CDMA CELL SITE CONFIGURATION					Proto	Non Power	Pur Up Res	Answer Mode	Page Rate	U-STD	3	On/Off	Auto/Manual	Half	Network Id	Non Pur Ext	Timer Res	Call Limit	Num Pages	1	0	On/Off	None/Pass	1	Srvt	Init Power	Res Period	Pilot Inc		4	3	29	12		Base Id	Power Step		Srch Win A			1		8		Ecd	Pen Size		Srch Win H		On/Off	10		8		Entry Lte	Num Step		Srch Win R		1	4		8		Net	Max Res Seq	Authn		To Screen		Max Rsp Seq	On/Off		CDMA	Rest	3	KAND		CALL CHIL	Rest Sd	Max Slot	04A2B05F		O Anolog	12	Cycle Index	PAND50		WR TEST			4D18E8A058950		Confie			KANDU		TESTS			93750F		
CDMA CELL SITE CONFIGURATION																																																																																																											
Proto	Non Power	Pur Up Res	Answer Mode	Page Rate																																																																																																							
U-STD	3	On/Off	Auto/Manual	Half																																																																																																							
Network Id	Non Pur Ext	Timer Res	Call Limit	Num Pages																																																																																																							
1	0	On/Off	None/Pass	1																																																																																																							
Srvt	Init Power	Res Period	Pilot Inc																																																																																																								
4	3	29	12																																																																																																								
Base Id	Power Step		Srch Win A																																																																																																								
	1		8																																																																																																								
Ecd	Pen Size		Srch Win H																																																																																																								
On/Off	10		8																																																																																																								
Entry Lte	Num Step		Srch Win R																																																																																																								
1	4		8																																																																																																								
Net	Max Res Seq	Authn		To Screen																																																																																																							
	Max Rsp Seq	On/Off		CDMA																																																																																																							
Rest	3	KAND		CALL CHIL																																																																																																							
Rest Sd	Max Slot	04A2B05F		O Anolog																																																																																																							
12	Cycle Index	PAND50		WR TEST																																																																																																							
		4D18E8A058950		Confie																																																																																																							
		KANDU		TESTS																																																																																																							
		93750F																																																																																																									

HP-IB Syntax

- "DISP CCON" ! displays the CDMA CELL CONFIGURATION screen.
- "CDMA:CELL:CONF:NOM:POW 3" !sets the Nom Power field to 3.
- "CDMA:CELL:CONF:INIT:POW 3" !sets the Init Power field to 3.
- "CDMA:CELL:CONF:STEP:POW 1" !sets the Power Step field to 1.
- "CDMA:CELL:CONF:NUMS 4" !sets the Num Step field to 4.
- "CDMA:CELL:CONF:MAXR 3" !sets the Max Rsp Seq field to 3.

9. Measure access probe power.

Manual Operation:

Press the Call/Page key on the Test Set's front panel to page the MSUT.

Nominal settings for the Spectrum Analyzer are shown.

Spectrum Analyzer settings:

Sweep Time: 5 s
Ref: -15.0 dBm
Vertical: 1 dB/Div
Span: 0 Hz

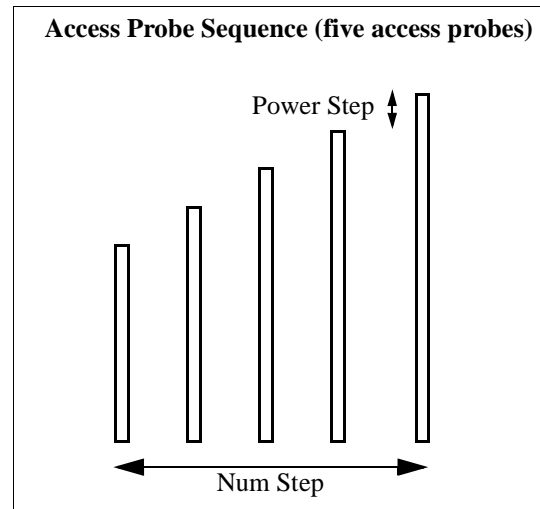

The figure above shows one access probe sequence, consisting of five access probes. During this test, the MSUT will transmit three access probe sequences.

After the Call/Page key is pressed on the Test Set, the Page Sent annunciator will light to indicate that a paging message was sent to the MSUT.

The Access Probe annunciator will light to indicate that the mobile station has transmitted at least one access probe sequence in an attempt to gain system access.

HP-IB Syntax

"CDMA:CALL:MAKE" !pages the MSUT

HPBASIC Programming Example

The following programming example was developed using HPBASIC for Windows. It was tested on an HP E8285A with firmware rev A.02.26.

```
10 ! RE-STORE "c:\hpbasic\setrain\access_probe"
20 ! This program measures Access Probe Output Power
30 Loss=-1.5
40 CLEAR 714
50 OUTPUT 714;"*CLS"
60 CLEAR SCREEN
70 OUTPUT 714;"CDMA:CALL:END"
80 WAIT 1
90 OUTPUT 714;"*RST;"
100 WAIT 3
110 OUTPUT 714;"CDMA:RFCH 384"
115 !Measure access probe power during 1 access probe sequence
120 Meas(1,1,Loss)
130 CLEAR SCREEN
135 !Measure access probe power during 3 access probe sequences
140 Meas(2,3,Loss)
150 !
160 DISP "Program Done"
170 END
180 Meas: SUB Meas(Test,Max_seq,Loss)
190 IF Test=1 THEN
200 OUTPUT 714;"CONF:OFL:RFIN ";Loss
210 OUTPUT 714;"CONF:OFL:MODE 'ON'"
220 !
230 OUTPUT 714;"CDMA:CALL:LIM 'PAGE'"!Limit call processing to page
240 !Mobile station will transmit its maximum number of access probes
250 !as defined by settings on the Cell Configuration screen
260 OUTPUT 714;"CDMA:CELL:ASEC:BWP -75"
270 OUTPUT 714;"CDMA:CELL:CONF:MAXR";Max_seq
280 OUTPUT 714;"CDMA:CELL:CONF:STEP:POW 0"!Power Step = 0
290 ELSE
300 OUTPUT 714;"CDMA:CELL:CONF:MAXR";Max_seq
310 OUTPUT 714;"CDMA:CELL:CONF:NOM:POW 3"!Nominal power = 3
```

```
320 OUTPUT 714;"CDMA:CELL:CONF:INIT:POW 3"!Initial power = 3
330 OUTPUT 714;"CDMA:CELL:CONF:STEP:POW 1"!Power Step = 1
340 OUTPUT 714;"CDMA:CELL:CONF:NUMS 4"!Number of steps = 4
350 END IF
360 Spec_an1(Test) !Set up Spectrum Analyzer
370 PRINT
380 PRINT "PRESS CONTINUE AND COUNT THE NUMBER OF"
390 PRINT "ACCESS PROBES AS THEY APPEAR ON THE DISPLAY"
400 PAUSE
410 CLEAR SCREEN
420 WAIT 1
430 PRINT "TOTAL ACCESS PROBES SHOULD BE ";Max_seq*5
440 OUTPUT 714;"CDMA:CALL:MAKE"
450 DISP "Call attempt made"
460 IF Test=1 THEN
470 WAIT 10
480 PRINT
490 CLEAR SCREEN
500 END IF
510 SUBEND
520 Spec_an1: SUB Spec_an1(Test)
530 IF Test=1 THEN
540 PRINT "1. CONNECT THE MOBILE OUTPUT TO A SPECTRUM"
545 PRINT "ANALYZER USING A POWER SPLITTER OR COMBINER"
550 PRINT " (ISOLATION IS NOT IMPORTANT)"
560 PRINT
570 PRINT
580 PRINT "2. SET UP THE SPECTRUM ANALYZER AS FOLLOWS:"
590 PRINT " Reference level: 20 dBm"
600 PRINT " Span 0 Hz"
610 PRINT " Vertical scale: 5 dB/DIV"
620 PRINT " Sweep Time: 5 seconds"
625 !OUTPUT 714;"RFG:FREQ:UNIT MHZ"
630 OUTPUT 714;"RFG:FREQ?"
640 ENTER 714;Freq
650 PRINT " Center Frequency: ";Freq
660 END IF670 SUBEND
```

5

CDMA to Analog Handoff

Performing a CDMA to Analog Handoff

The HP E8285A has the capability to perform a handoff from a CDMA traffic channel to an analog voice channel. The following conditions are required for a successful handoff:

- The MSUT must be programmed to allow analog operation.
- A CDMA phone call must be active (Connected annunciator lit).
- The MSUT may require the audio to be muted if the environment is noisy. If the audio mute feature does not exist in the mobile station, a field called SAT Tolerance can be set to "Wide" to allow SAT to be detected in the presence of noise.

A ["HP BASIC Example" on page 198](#) is provided.

Procedure Overview

For detailed step-by-step explanation see the page associated with the step.

1. ["Make sure the MSUT will allow analog operation." on page 191.](#)
2. ["Specify "Wide" SAT Tolerance. \(Optional\)" on page 192.](#)
3. ["Make a CDMA call." on page 193.](#)
4. ["Select an analog system for handoffs." on page 194.](#)
5. ["Set up handoff parameters. \(Optional\)" on page 195.](#)
6. ["Select the Execute field." on page 196.](#)
7. ["Verify that the handoff was successful." on page 197.](#)

1. Make sure the MSUT will allow analog operation.

Manual Operation:

Program the MSUT to “prefer digital” or “prefer analog” operation.

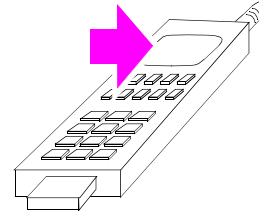

Refer to the MSUT manufacturers procedure for setting the MSUT to the correct mode.

2. Specify “Wide” SAT Tolerance. (Optional)

Manual Operation:

1. Press the ANALOG SCREENS Call Control key to display the CALL CONTROL screen.
2. Select the CALL CNFG screen from To Screens menu.
3. Position the cursor next to the Sat Tol field.
4. Select Wide.
5. Press the CDMA SCREENS Call Control key to display the CDMA CALL CONTROL screen.

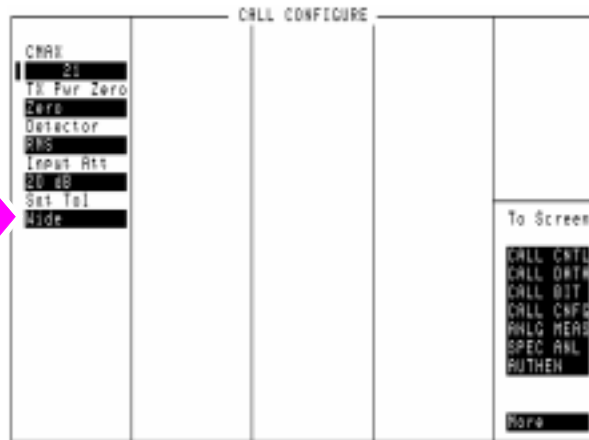

In some applications, such as when a mobile station's audio section cannot be muted, and background noise is present, the Test Set will not respond to the SAT tone transponded by the mobile station unless a wider filter is applied in the Test Set's audio demodulation path.

HP-IB Syntax:

`"CALLP:STOL 'Wide'"!selects a wider filter for demodulating the selected SAT.`

3. Make a CDMA call.

See "[Steps for Setting Up a Call](#)" on page 46 if you are not familiar with how this procedure is performed with the Test Set. Any service option can be used.

After setting up the CDMA call, return to this procedure.

4. Select an analog system for handoffs.

<p>Manual Operation:</p> <ol style="list-style-type: none"> 1. Position the cursor next to the System Type field as shown in the figure. 2. Select the analog system supported by the MSUT. 	
--	--

HP-IB Syntax:

"CDMA:CALL:AHANdoff:STYPe 'AMPS'!" selects the AMPS analog system for CDMA to analog hand-offs.

5. Set up handoff parameters. (Optional)

Manual Operation:

1. Position the cursor next to the Channel, SAT, or Pwr Level fields as needed to specify handoff parameters.
2. Select the analog parameters in each of these three fields.

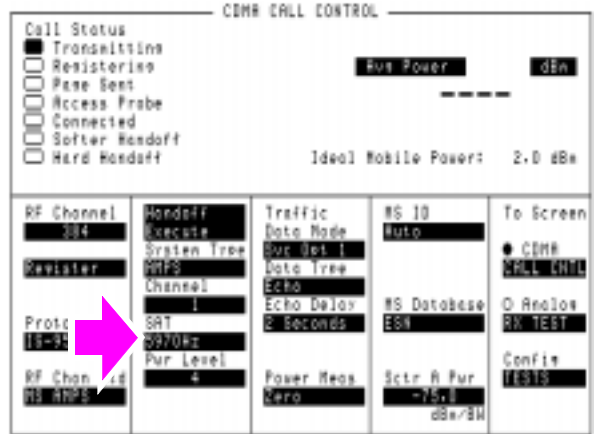

These three fields provide the Test Set with information about how to set up the simulated analog cell site for the handoff to an analog voice channel. The three fields are:

Channel: The analog voice channel that will be allocated for CDMA to analog handoffs.

SAT: The supervisory audio tone that the Test Set will transmit, and the MSUT will transpond.

Pwr Level: The power level to be transmitted by the mobile station after the handoff is successful, referred to as VMAC (voice mobile attenuation code).

HP-IB Syntax:

"CDMA:CALL:AHAN:CHAN 1"!sets the Channel (analog voice channel) field to 1.

"CDMA:CALL:AHAN:SAT '6000Hz'"!sets the SAT (supervisory audio tone to 6000 Hz.

"CDMA:CALL:AHAN:PLEV 4"! sets the Pwr Level (voice mobile attenuation code) to 4.

6. Select the Execute field.

Manual Operation:

1. Position the cursor next to the Execute field as shown in the figure.
2. Press the knob to execute a CDMA to analog handoff.

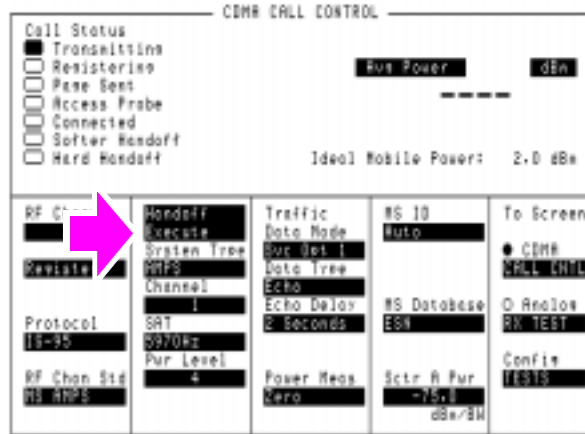

When a CDMA to analog handoff is attempted, the Test Set switches to analog mode, configures itself as an analog cell site, and displays the CALL CONTROL screen. This is the screen that controls analog call processing. If the handoff is successful, the Connected annunciator will be lit.

See "Using the Analog Call Processing Subsystem" on page 247 to make measurements and perform other operations in analog mode.

HP-IB Syntax:

"CDMA:CALL:AHAN:EXEC"!executes the CDMA to analog handoff.

7. Verify that the handoff was successful.

Manual Operation:

Check the Connect annunciator.



The screenshot shows the 'CALL CONTROL' screen with the 'Connect' annunciator lit. The screen is divided into several sections: 'Display' (Data/Rec), a list of annunciators (Active, Register, Page, Access, Connect), a table of call parameters, and a 'To Screen' menu.

	System Type	Voice Channel Assignment	To Screen
Active	AMPS	Chan: - 212	CALL CTRL
Register	Ctrl Chan	Per Lvl: - 4	CALL DATA
Page	321	SATS - 5970Hz	CALL BIT
Handoff	Amplitude		CALL CFG
Release	-50.0		ANLG MEAS
Order	dBm		SPEC ANL
Chns PL 8	SID		AUTHEN
NS Id	231		
Phone Num			
11111111			

When a CDMA to analog handoff is attempted, the Test Set switches to analog mode, configures itself as an analog cell site, and displays the CALL CONTROL screen. This is the screen that controls analog call processing. If the handoff is successful, the Connect annunciator will be lit.

See "Using the Analog Call Processing Subsystem" on page 247 to make measurements and perform other operations in analog mode.

HP BASIC Example

The following example executes a CDMA to analog handoff, then polls bit 5 in the Call Processing status register group until the handoff to the analog voice channel is connected, or the handoff attempt times out.

```
10 RE-SAVE "C:\HPBASIC\HANDOFF"
20 OUTPUT 714;"CDMA:CALL:AHAN:EXEC"!executes the CDMA to analog handoff
30 T=TIMEDATE
40 REPEAT
50 OUTPUT 714;"STAT:CALLP:EVENT?" !Queries Call Processing Status Event Register
60 ENTER 714;Connected
70 IF TIMEDATE-T>=25 THEN
80 PRINT "ERROR"
90 STOP
100 ELSE
110 WAIT .1 !Prevents HP-IB commands from dominating TesFlkt Set processes
120 END IF
130 UNTIL BIT(Connected,5)
140 PRINT "Handoff complete, mobile is connected to analog voice channel"
140 END
```

Authentication Tests

The following Authentication tests verify that the Mobile Station Under Test (MSUT) is able to use the Cellular Authentication and Voice Encryption (CAVE) algorithm correctly.

"Initializing SSD to Zero" on page 201.

"Updating SSD" on page 209.

"Performing a Unique Challenge-Response" on page 216.

For Authentication tests to pass, the MSUT and Test Set must possess identical sets of Shared Secret Data (SSD). SSD consists of two subsets:

- SSD_A (used for Authentication procedures) and
- SSD_B (used to support voice privacy)

NOTE:

In this section, the acronym SSD will be used to refer to SSD_A.

Authentication test results are displayed in a portion of the CDMA AUTHENTICATION screen referred to as the Authentication Data Table. Press the CDMA SCREENS Authentication key to display this screen.

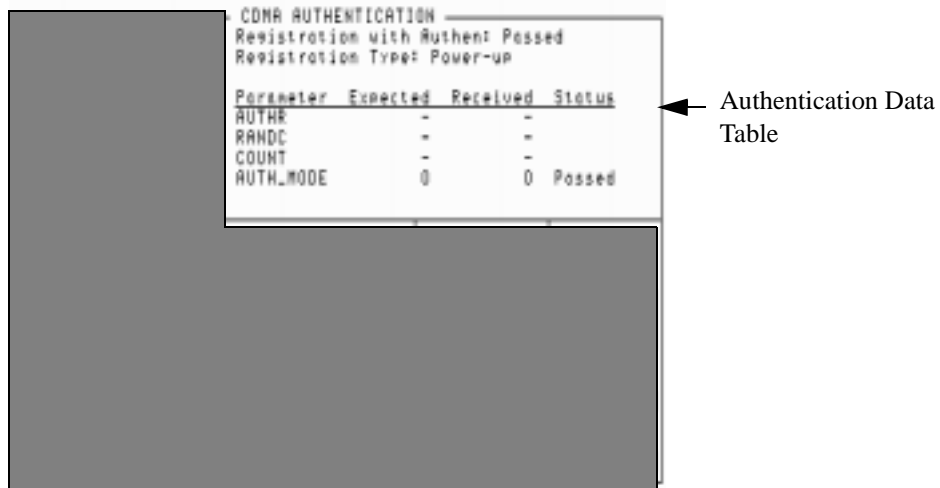

Initializing SSD to Zero

This procedure tests the MSUT's ability to respond to a timer-based registration with authentication parameters that match the values expected by the Test Set.

This procedure is performed after SSD has been initialized to zero in both the Test Set and MSUT. SSD is initialized to zero by changing the A-Keys. *If you cannot change the A-Key in the MSUT, you cannot perform this test.*

NOTE: SSD is not directly accessible in any fields on the Test Set's display.

Measurement Overview

For detailed step-by-step explanation see the page associated with the step.

1. ["Register the MSUT." on page 202.](#)
2. ["Initialize the Test Set's SSD to zero." on page 203.](#)
3. ["Initialize the MSUT's SSD to zero." on page 204.](#)
4. ["Turn on Authentication." on page 205.](#)
5. ["Perform a timer-based registration." on page 206.](#)
6. ["Disable timer-based registration." on page 208.](#)

It is recommend these additional procedures be performed after initializing SSD to zero to further verify correct MSUT performance:

- ["MSUT-Originated Call ." on page 53](#)
- ["MSUT-Terminated Call" on page 52](#)
- ["Performing a Unique Challenge-Response" on page 216](#)

1. Register the MSUT.

If the MSUT is already registered, this step is not necessary.

See "[Steps for Setting Up a Call](#)" on page 46 if you are not familiar with how this procedure is performed with the Test Set.

Setting up a call registers the MSUT.

Registration provides the Test Set with the MSUT's ESN (Electronic Serial Number).

ESN is displayed in the MS Database field.

Authentication procedures rely on ESN to generate valid A-Keys and generate other values used to check for possession of identical SSD between the MSUT and Test Set.

2. Initialize the Test Set's SSD to zero.

Manual Operation:

1. Select Authen in the To Screen, CDMA list.
 If the SSD_A=0 annunciator is lit, performing the rest of this step is not necessary.
2. Position the cursor in front of the A-Key field.
3. Enter any number within the allowable range of A-Key values, using the DATA keys. Press the ENTER key when the number has been entered.

The SSD_A=0 annunciator should be lit.

The Check Digits field should display a six-digit number.¹



Entering an A-Key initializes SSD to zero.

The range of values allowed in the A-Key field is 0 to 18446744073709551615.

The number you entered in the A-Key field, along with the MSUT's ESN acquired during registration, are used by the Test Set to generate the six digits displayed in the Check Digits field. If no Check Digits appear, make sure an ESN value is displayed in the MS Database field.¹

The Check Digits are part of the A-Key, and provide a method for checking A-Key validity.

If the ESN changes (for instance when another MSUT is connected to the Test Set and registers) or is cleared, the Check Digits field will be cleared.

1. If Kor PCS is selected in the Protocol field, the Check Digits field should be blank.

HP-IB Syntax

"CDMA:AUTH:AKEY '0'" enters all zeroes in the A-Key field.

3. Initialize the MSUT's SSD to zero.

1. Access the MSUT's A-Key register and enter the identical sequence of digits displayed in the A-Key field, followed by the six Check Digits (if protocol is not Kor PCS).

The MSUT should confirm the entry of a valid A-Key.

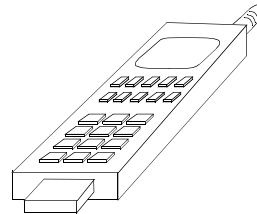

This step instructs you to enter the A-Key displayed in the A-Key field because it is assumed to be valid (the Test Set calculated Check Digits based on the 20 A-Key digits and MSUT's ESN acquired during registration). This procedure, however, will work with any valid A-Key, since any valid A-Key will initialize the MSUT's SSD to zero.

*If you cannot change the MSUT's A-Key but you know what it is, enter it in the A-Key field on the Test Set (as described in the previous step), then skip to **"Updating SSD" on page 209**.*

4. Turn on Authentication.

Manual Operation:

1. Position the cursor at the Authen field.
2. Press the knob to select On.



Selecting "On" in this field results in the Test Set signaling the MSUT to include authentication parameters in messages requiring authentication (AUTH_MODE =1).

HP-IB Syntax

"CDMA:CELL:CONF:AUTH:MODE 'ON'" turns authentication on.
 "CDMA:AUTH:DATA:CLE" clears the Authentication Data Table.

5. Perform a timer-based registration.

Manual Operation:

1. Position the cursor at the Timer Reg field.
2. Press the knob to select On.
3. Wait for the first registration to complete (about 20 seconds).

Read the Registration with Authen: message in the Authentication Data Table. It will indicate whether the registration passed or failed.

If the test failed, check the passed or failed status of each the following parameters: AUTHR, RANDC, COUNT, and AUTH_MODE to see which parameters did not match expected values.

After the first timer-based registration is performed, the expected COUNT parameter will be "Unknown." The Status of COUNT will be "Failed," until the next registration when an Expected COUNT parameter is available.

Registrations should occur at about 20 second intervals.

The MSUT and Test Set combine SSD with a random number and the ESN of the phone when computing AUTHR. This value is transmitted by the MSUT, then compared (along with other Authentication parameters) with the expected value by the Test Set to determine Pass/Fail status.

CDMA AUTHENTICATION

Registration with Authen: Failed
 Registration Type: Timer

Parameter	Expected	Received	Status
AUTHR	250E8	250E8	Passed
RANDC	34	34	Passed
COUNT	Unknown	3	Failed
AUTH_MODE	1	1	Passed

A.KEY XXXXXXXXXXXXXXXXXXXX	Check Digits 139763	MS ID Auto	To Screen
Authen No/Off	Traffic Data Mode	MS Database ESN	CDMA CALL CTRL
Timer Reg No/Off	Sec Del 1 Data Trace	Echo 80000000	SMS AUTHEN
SSD Update Execute	Echo Selcr 8 Seconds		O Analyze RX TEST
Unia Chall Execute	Authen Data Clear		Config VLSIS

HP-IB Syntax

"CDMA:CELL:CONF:TREG:MODE 'ON'" turns timer-based registration on.
 "CDMA:AUTH:DATA?" queries the results displayed in the Authentication Data Table.

NOTE: Querying the results displayed in the Authentication Data Table returns a series of 18 numeric values separated by commas. Refer to the *HP E8285A Reference Guide, Description of Fields, Authentication Data Table* for a description of each value and a programming example.

HP-IB Help

The CDMA Authentication Status Register provides status bits that can simplify remote operation.

Below is a program example that queries the CDMA Authentication Event Register to determine if authentication is in progress, and if an authentication procedure passed. This program assumes that the MSUT has found service, and that the Test Set and MSUT possess identical shared secret data. It will run until a timer-based registration passes.

For a full description of CDMA Authentication Status Register bits, refer to the *HP E8285A User's Guide*, Status Reporting.

```

10 !   RE-SAVE "c:\e8285a\authentic\auth_status3"
20   ON TIMEOUT 7,10 GOTO 240
30   CLEAR 714
40   CLEAR SCREEN
45   OUTPUT 714;"*CLS" !Clear Event registers
50   OUTPUT 714;"DISP Caut"
60   OUTPUT 714;"*CLS" !Clear out event bit registers
70   OUTPUT 714;"CDMA:CELL:CONF:AUTH:MODE 'ON'" !Turn authentication on
80   OUTPUT 714;"CDMA:CELL:CONF:TREG:MODE 'ON'" !Enable timer-based registration
90   LOOP
100  WAIT .5
110  OUTPUT 714;"STAT:CAUT:EVEN?"!Read CDMA Authentication Event Register
120  ENTER 714;Auth
130  !*****
140  IF BIT(Auth,0) THEN !Bit 0 is latched high when Authentication begins
150    PRINT "Authentication in Progress..."
160  END IF
170  !
180  IF BIT(Auth,7) THEN !Bit 7 is latched high when Registration passes
190    PRINT "Registration with authentication passed"
200  END IF
210  !*****
220  EXIT IF Auth>=128 !Stop program when Registration passes
230  END LOOP
240  STOP
250  END

```

6. Disable timer-based registration.

Manual Operation:

1. Position the cursor at the Timer Reg field.
2. Press the knob to select Off.



HP-IB Syntax

"CDMA:CELL:CONF:TREG:MODE 'OFF'" turns timer-based registration off.

Updating SSD

SSD Update tests the MSUT's ability to synchronize SSD with the Test Set.

This procedure will show you how to perform SSD Update on the Paging/Access channels. SSD Updates can also be performed on the Traffic channels by making a call as described in **"MSUT-Terminated Call" on page 52**, then performing this procedure.

During the SSD update, the Test Set and MSUT acquire new sets of SSD using their current A-Keys. The Test Set and the MSUT then compare the new SSD values and the MSUT sends a message to the Test Set confirming or rejecting the new value.

No authentication parameters are displayed in the CDMA Authentication table during this test.

Measurement Overview

For detailed step-by-step explanation see the page associated with the step.

1. **"Register the MSUT." on page 210.**
2. **"Enter the MSUT's A-Key into the Test Set." on page 211.**
3. **"Turn Authentication On." on page 212.**
4. **"Perform an SSD Update." on page 213.**
5. **"Check the message displayed for test results." on page 214.**

It is recommend the following procedures be performed after Updating SSD to further verify correct MSUT performance:

- **"Performing a Unique Challenge-Response" on page 216**

1. Register the MSUT.

See "[Steps for Setting Up a Call](#)" on page 46 if you are not familiar with how this procedure is performed.

Registration provides the Test Set with the MSUT's ESN (Electronic Serial Number).

ESN is displayed in the MS Database field.

Authentication procedures rely on ESN to generate valid A-Keys and generate other values used to check for possession of identical SSD between the MSUT and Test Set.

2. Enter the MSUT's A-Key into the Test Set.

If you performed "Initializing SSD to Zero" on page 201, this step is not necessary.

Manual Operation:

1. Enter the most significant 20 digits (non-check-digits) of the MSUT's A-Key into the Test Set's A-Key field using the DATA keys. Press the ENTER key when you are done.

The SSD_A=0 annunciator should be lit.

2. Compare the numbers in the Check Digits field with the last 6 digits in the MSUT's A-Key. If they do not match, one of the A-Keys is not valid. Check the 20-digit sequence entered in the Test Set to be sure it matches the MSUT's A-Key.



If you do not know the MSUT's A-Key, and have no way of finding out what it is, try entering zero in the A-KEY field. The A-Key in many MSUT's is initially programmed to zero until re-programmed by the service provider.

HP-IB Syntax

"CDMA:AUTH:AKEY '0'" enters all zeroes in the A-Key field.

3. Turn Authentication On.

Manual Operation:

1. Position the cursor at the Authen field
2. Press the knob to select On.

CDMA AUTHENTICATION			
Pass with Authen Passed			
Call Status	Parameter	Expected	Received Status
<input checked="" type="checkbox"/> Transmitting	AUTHR	SCEE	SCEE Passed
<input type="checkbox"/> Registering	RANDC	34	34 Passed
<input checked="" type="checkbox"/> Page Sent	COUNT	10	10 Passed
<input checked="" type="checkbox"/> Access Probe	AUTH.MODE	1	1 Passed
<input checked="" type="checkbox"/> Connected			
<input type="checkbox"/> SSD Update			
<input type="checkbox"/> Uns Chall			
<input checked="" type="checkbox"/> SSD_R=0			

R_KEY XXXXXXXXXXXXXXXXXXXX	Check Digits 174518	MS ID Auto	To Screen
Authen On/Off	Traffic Data Mode	MS Database ESN	CDMA CALL CTL
Timer Exp On/Off	Sec Get 1 Data Type	808197F4	SW
SSD Update Execute	Echa Echa Delay	2 Seconds	AUTHEN
Uns Chall Execute	Authen Data Clear		O Analog
			PK TEST
			Config
			TEST

Turning Authentication "On" sets the AUTH_MODE bit to "01" in signaling messages and causes the MSUT to send Auth parameters AUTHR, RANDC, and COUNT to the Test Set.

HP-IB Syntax

"CDMA:CELL:CONF:AUTH:MODE 'ON'" turns authentication on.

212

S:\HPe8285A\APPMOD\BOOK\CHAPTERS\lamauth.fb

4. Perform an SSD Update.

Manual Operation:

- Select the SSD Update Execute field.

The SSD Update annunciator will light, but this may be only momentarily.

The screenshot shows the 'CDMA AUTHENTICATION' screen. At the top, there are several status indicators: 'Cell Status' with checkboxes for Transmitting, Registering, Power Sent, Access Probe, Connected, SSD Update, and Uu1 Challenged. Below this is a table with columns 'Parameter', 'Expected', 'Received', and 'Status'. The 'A-KEY' field is highlighted with a pink arrow pointing to the 'Execute' option in the 'Authen' menu.

During the SSD Update, the MSUT and Test Set combine the A-Key with a common random number, RANDSSD, and then compare results to determine if SSD matches. RANDSSD is a settable value (see RANDSSD field on the CDMA CELL SITE CONFIGURATION screen) sent from the Test Set to the MSUT.

HP-IB Syntax

"CDMA:AUTH:SSD" initiates an SSD Update.

5. Check the message displayed for test results.

Manual Operation:

Read the SSD Update on Paging (or Traffic): message. It will indicate whether SSD Update passed or failed.

After a successful SSD Update, the SSD_A=0 annunciator should no longer be lit.

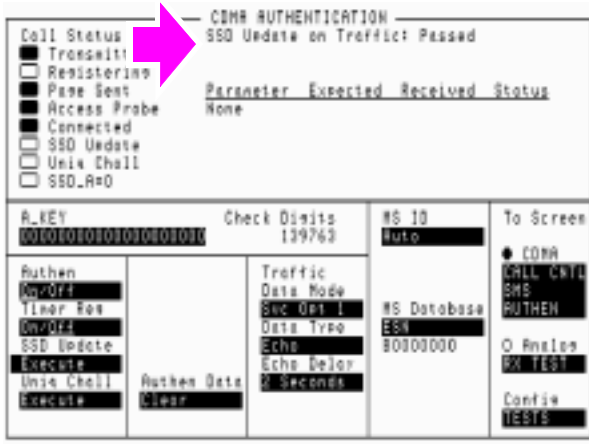

After new values for SSD are computed and compared between the MSUT and Test Set, the MSUT transmits a message to the Test Set indicating the status of the SSD Update (passed or failed).

HP-IB Syntax

"CDMA:AUTH:DATA?" queries the results displayed in the Authentication Data Table.

NOTE: Querying the Authentication Data Table returns a series of 18 numeric values separated by commas. Each numeric value represents data displayed in the Authentication Data Table. Refer to the *HP E8285A Reference Guide, Description of Fields, Authentication Data Table* for description of each value and a programming example.

HP-IB Help

The CDMA Authentication Status Register provides status bits that can simplify remote operation.

Below is a program example that queries the CDMA Authentication Event Register to determine if an SSD Update is in progress, and if an SSD Update passed. This program assumes that the MSUT has registered or is on a call, and that the Test Set's A-Key field and the MSUT's A-Key match.

For a full description of CDMA Authentication Status Register bits, refer to the *HP E8285A User's Guide*, Status Reporting.

```

10 ! RE-SAVE "c:\e8285a\authentic\auth_status4"
20 ON TIMEOUT 7,10 GOTO 240
30 CLEAR 714
40 CLEAR SCREEN
50 OUTPUT 714;"DISP CAUT"
60 OUTPUT 714;"*CLS" !Clear out event bit registers
70 OUTPUT 714;"CDMA:CELL:CONF:AUTH:MODE 'ON'" !Turn authentication on
80 OUTPUT 714;"CDMA:AUTH:SSD" !Initiate SSD Update
90 LOOP
100 WAIT .5
110 OUTPUT 714;"STAT:CAUT:EVEN?"!Read CDMA Authent Event Register
120 ENTER 714;Auth
130 !*****
140 IF BIT(Auth,1) THEN !Bit 1 is latched high when an SSD Update begins
150 PRINT "SSD Update in Progress..."
160 END IF
170 !
180 IF BIT(Auth,11) THEN !Bit 11 is latched high when SSD Update passes
190 PRINT "SSD Update with authentication passed"
200 END IF
210 !*****
220 EXIT IF Auth>=256 !Stop program when SSD Update passes
230 END LOOP
240 STOP
250 END

```

Performing a Unique Challenge-Response

Unique Challenge-Response tests the MSUT's ability to send the Test Set a parameter that indicates it has SSD identical to the Test Set's.

This procedure will show you how to perform a Unique Challenge-Response procedure on the Paging/Access and Traffic channels. The MSUT should respond with a computed value for AUTHU, which the Test Set will compare with an expected value to determine Pass/Fail status.

Measurement Overview

For detailed step-by-step explanation see the page associated with the step.

1. **"Prerequisite." on page 217.**
2. **"Select Unique Challenge." on page 218.**
3. **"Check the Authentication Data Table for results." on page 219.**
4. **"Perform an MSUT-originated call." on page 221.**
5. **"Select Unique Challenge." on page 222.**

It is recommended that you perform a Unique Challenge-Response after **"Initializing SSD to Zero" on page 201** and after **"Updating SSD" on page 209**.

1. Prerequisite.

SSD synchronization between the Test Set and MSUT must be done by either performing a **"Initializing SSD to Zero" on page 201** or **"Updating SSD" on page 209**.

Performing either of these procedures synchronizes the SSD value stored in the Test Set with the SSD value stored in the MSUT.

2. Select Unique Challenge.

Manual Operation:

1. End a call if Call Status is Connected
2. Select the Uniq Chall field.

The Uniq Chall annunciator should light momentarily.

CDMA AUTHENTICATION

Cell Status <input checked="" type="checkbox"/> Transmitting <input type="checkbox"/> Receiving <input type="checkbox"/> Power Sent <input type="checkbox"/> Access Probe <input type="checkbox"/> Connected <input type="checkbox"/> SSN Update <input type="checkbox"/> Uniq Chall <input checked="" type="checkbox"/> SSN_#0	<table style="width: 100%; border-collapse: collapse;"> <thead> <tr> <th style="border-bottom: 1px solid black;">Parameter</th> <th style="border-bottom: 1px solid black;">Expected</th> <th style="border-bottom: 1px solid black;">Received</th> <th style="border-bottom: 1px solid black;">Status</th> </tr> </thead> <tbody> <tr> <td style="border-right: 1px solid black;">A_KEY</td> <td style="border-right: 1px solid black;">Check Delta</td> <td style="border-right: 1px solid black;">MS ID</td> <td>To Screen</td> </tr> <tr> <td style="border-right: 1px solid black;">0000000000000000</td> <td style="border-right: 1px solid black;">174518</td> <td style="border-right: 1px solid black;">Auto</td> <td> <input checked="" type="checkbox"/> CDMA <input type="checkbox"/> CALL CHNL <input type="checkbox"/> SMS <input type="checkbox"/> AUTHEN <input type="checkbox"/> O Anon <input type="checkbox"/> BY TEST Confir TESTS </td> </tr> <tr> <td style="border-right: 1px solid black;">Authen</td> <td style="border-right: 1px solid black;"></td> <td style="border-right: 1px solid black;">Traffic</td> <td></td> </tr> <tr> <td style="border-right: 1px solid black;">On/Off</td> <td style="border-right: 1px solid black;"></td> <td style="border-right: 1px solid black;">Data Mode</td> <td></td> </tr> <tr> <td style="border-right: 1px solid black;">Timer Res</td> <td style="border-right: 1px solid black;"></td> <td style="border-right: 1px solid black;">Data Len 2</td> <td>MS Database</td> </tr> <tr> <td style="border-right: 1px solid black;">Max/Gr</td> <td style="border-right: 1px solid black;"></td> <td style="border-right: 1px solid black;">Data Type</td> <td>ESN</td> </tr> <tr> <td style="border-right: 1px solid black;">SSN Update</td> <td style="border-right: 1px solid black;"></td> <td style="border-right: 1px solid black;">Echo</td> <td>B08197F4</td> </tr> <tr> <td style="border-right: 1px solid black;">Execute</td> <td style="border-right: 1px solid black;"></td> <td style="border-right: 1px solid black;">Echo Delay</td> <td></td> </tr> <tr> <td style="border-right: 1px solid black;">Uniq Chall</td> <td style="border-right: 1px solid black;">Authen Data</td> <td style="border-right: 1px solid black;">2 seconds</td> <td></td> </tr> <tr> <td style="border-right: 1px solid black;">Execute</td> <td style="border-right: 1px solid black;">Clear</td> <td></td> <td></td> </tr> </tbody> </table>	Parameter	Expected	Received	Status	A_KEY	Check Delta	MS ID	To Screen	0000000000000000	174518	Auto	<input checked="" type="checkbox"/> CDMA <input type="checkbox"/> CALL CHNL <input type="checkbox"/> SMS <input type="checkbox"/> AUTHEN <input type="checkbox"/> O Anon <input type="checkbox"/> BY TEST Confir TESTS	Authen		Traffic		On/Off		Data Mode		Timer Res		Data Len 2	MS Database	Max/Gr		Data Type	ESN	SSN Update		Echo	B08197F4	Execute		Echo Delay		Uniq Chall	Authen Data	2 seconds		Execute	Clear		
Parameter	Expected	Received	Status																																										
A_KEY	Check Delta	MS ID	To Screen																																										
0000000000000000	174518	Auto	<input checked="" type="checkbox"/> CDMA <input type="checkbox"/> CALL CHNL <input type="checkbox"/> SMS <input type="checkbox"/> AUTHEN <input type="checkbox"/> O Anon <input type="checkbox"/> BY TEST Confir TESTS																																										
Authen		Traffic																																											
On/Off		Data Mode																																											
Timer Res		Data Len 2	MS Database																																										
Max/Gr		Data Type	ESN																																										
SSN Update		Echo	B08197F4																																										
Execute		Echo Delay																																											
Uniq Chall	Authen Data	2 seconds																																											
Execute	Clear																																												



This step performs a Unique Challenge on the Paging/Access channels.

HP-IB Syntax

"CDMA:AUTH:UCH" !initiates the Unique Challenge procedure

3. Check the Authentication Data Table for results.

Manual Operation:

1. End a call if Call Status is Connected
2. Select the Uniq Chall field.

Read the Unique Challenge on Paging (or Traffic): message. It will indicate whether the Unique Challenge passed or failed.

Check the Authentication Data Table for AUTHU Pass/Fail results.

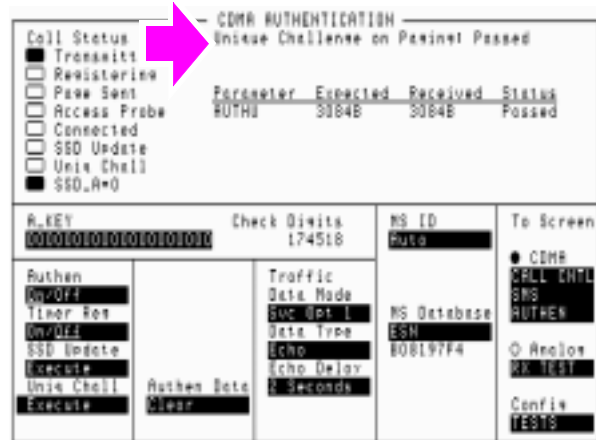

If the Unique Challenge on Paging (or Traffic): Failed message appears, it means that AUTHU did not match the expected value.

HP-IB Syntax

"CDMA:AUTH:DATA?" queries the results displayed in the Authentication Data Table.

NOTE:

Querying the Authentication Data Table returns a series of 18 numeric values separated by commas. Each numeric value represents data displayed in the Authentication Data Table. Refer to the *HP E8285A Reference Guide*, Description of Fields, Authentication Data Table for description of each value and a programming example.

HP-IB Help

The CDMA Authentication Status Register provides status bits that can simplify remote operation.

For a full description of CDMA Authentication Status Register bits, refer to the *HP E8285A User's Guide*, Status Reporting.

HP-IB BASIC Programming Example Below is a program example that queries the CDMA Authentication Event Register to determine if a Unique Challenge is in progress, and if a Unique Challenge passed. This program assumes that the MSUT has registered or is on a call, and that the Test Set's SSD and the MSUT's SSD match.

For a full description of CDMA Authentication Status Register bits, refer to the *HP E8285A User's Guide*, Status Reporting.

```
10 ! RE-SAVE "c:\e8285a\authentic\auth_status5"
20 ON TIMEOUT 7,10 GOTO 240
30 CLEAR 714
40 CLEAR SCREEN
50 OUTPUT 714;"DISP Caut"
60 OUTPUT 714;"*cls" !Clear out event bit registers
70 OUTPUT 714;"cdma:cell:conf:authenticate:mode 'on'" !Turn authentication on
80 OUTPUT 714;"cdma:auth:uch" !Initiate Unique Challenge-Response
90 LOOP
100 WAIT .5
110 OUTPUT 714;"stat:caut:even?"!Read CDMA Authentication Event Register
120 ENTER 714;Auth
130 !*****
140 IF BIT(Auth,2) THEN !Bit 1 is latched high when a Unique Challenge-Response begins
150 PRINT "Unique Challenge-Response in Progress..."
160 END IF
170 !
180 IF BIT(Auth,10) THEN !Bit 10 is latched high when a Unique Challenge passes
190 PRINT "Unique Challenge-Response passed"
200 END IF
210 !*****
220 EXIT IF Auth>=256 !Stop program when Unique Challenge passes
230 END LOOP
240 STOP
250 END
```

4. Perform an MSUT-originated call.

Manual Operation:

1. Enter any phone number on the MSUT's keypad and press the SEND (or green) key.

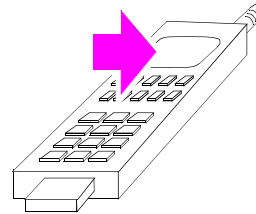

After Send (or green) is pressed on the MSUT, the Access Probe annunciator on the Test Set, will light to indicate that the mobile station sent an access probe sequence in an attempt to gain system access.

Some MSUT's require the number entered to be at least six digits long.

5. Select Unique Challenge.

Manual Operation:

- Select the Uniq Chall field.

Read the Unique Challenge on Traffic: message. It will indicate whether the unique challenge passed or failed.

Check the Authentication Data Table (refer to step 3) for AUTHU Pass/Fail results.

If the Unique Challenge on Paging (or Traffic): Failed message appears, it means that AUTHU did not match the expected value.

HP-IB Syntax

"CDMA:AUTH:DATA?" queries the results displayed in the Authentication Data Table.

HP-IB Help

Refer to **"HP-IB Help"** on page 219.

Short Message Service Tests

The following SMS tests verify that the Mobile Station Under Test (MSUT) is capable of receiving short messages.

"Sending Short Messages on the Paging/Access Channels" on page 225.

"Sending Short Messages on the Traffic Channels" on page 233.

Short messages can be sent:

- on the Paging/Access channels (phone has registered but is not on a traffic channel)
- on the Traffic channels (Service Option 6 or 14)
- on the Traffic channels (Service Option 1 or 32768)

All SMS procedures performed by the Test Set are mobile station terminated, meaning that the Test Set is sending messages to the MSUT.

The short message feature for the MSUT must be activated to perform these tests.

Sending Short Messages on the Paging/Access Channels

This procedure sends a short message to the MSUT on the Paging channel. The Test Set verifies that the MSUT acknowledged receiving the SMS message.

Measurement Overview

For detailed step-by-step explanation see the page associated with the step.

1. "Register the MSUT." on page 226.
2. "Optional: Clear (erase) old messages in the MSUT." on page 227.
3. "Enter a short message in the Test Set's data field." on page 229.
4. "Set the Page Rate." on page 230.
5. "Send the message." on page 231.

1. Register the MSUT.

If the MSUT is already registered, this step is not necessary.

See "[Steps for Setting Up a Call](#)" on page 46 if you are not familiar with how this procedure is performed with the Test Set.

.Registering the MSUT will ensure that it is monitoring the Test Set's Paging channel.

2. Optional: Clear (erase) old messages in the MSUT.

1. Access the message list and follow prompts on the MSUT to erase current messages.

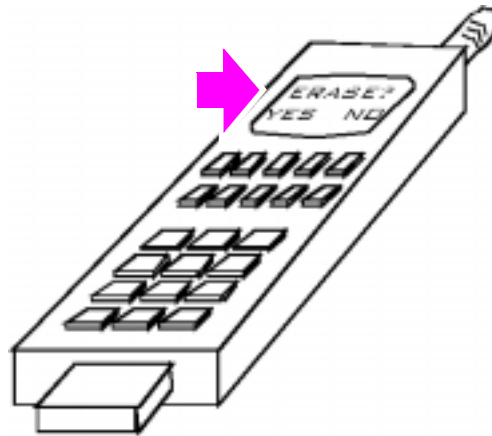

3. Select the data format for the SMS message.

<p>Manual Operation:</p> <ol style="list-style-type: none"> 1. Select SMS from the To Screen, CDMA list to display the CDMA SHORT MESSAGE SERVICE screen. 2. Position the cursor in front of the Data Mode field. Select the data format. 3. Position the cursor in front of the Encoding field. Select an encoding type. 	
---	--

The choice you make in the Data Mode field determines what type of characters you will enter in the User Data field, ASCII or hexadecimal. If you select ASCII, the Test Set translates User Data according to the ASCII code chart. If you select Hex, no translation is applied.

The Encoding field will determine if character data is encoded as either 7-bit or byte format.

HP-IB Syntax

"CDMA:SMS:MDM 'Hex' "

selects Hex in the Data Mode field.

"CDMA:SMS:ENC 'Octet' "

selects Octet in the Encoding field.

4. Enter a short message in the Test Set's data field.

Manual Operation:

1. Position the cursor in front of the data field shown.
2. Press the knob and enter a message. Select Done when done.



HP-IB Syntax

"CDMA:SMS:TERM:DATA:ASC 'http://www.hp.com/go/tmdir'"

Enters a message in the User Data (ASCII) field.

5. Set the Page Rate.

Manual Operation:

1. Set the Page Rate field to Full.

CDMA SHORT MESSAGE SERVICE

Cell Status		User Data (ASCII):		
<input checked="" type="checkbox"/> Transmitting		[ABCDEFGHIJKLMNOPQRSTUVWXYZ]		
<input type="checkbox"/> Page Sent				
<input type="checkbox"/> Access Probe				
<input type="checkbox"/> Connected				
<input type="checkbox"/> SMS In Progress				
<input type="checkbox"/> MS Ack Rcvd		MS Rck Cause Code:		

Send Msg	Alert	Data Mode	Traffic	To Screen
Execute	On/Off	ASCII	Data Mode	CDMA
	Priority	Encoding	Enc Del: 1	CALL CTRL
	None	7-bit ASCII	Data Type	O #/Analy
	Privacy	Duplicate	Echo Delay	EX TEST
	None	User Data	3 seconds	ESN
	Orig Addr	1	MS Database	Page Rate
	9214001	lines	ESN	Half
		Length		
		25 cl/s		



Setting the Page Rate field to Full provides more Paging Channel slots to send the Data Burst Message in.

HP-IB Syntax

```
"CDMA:CELL:CONF:PAGE:RATE 'Full' "
```

enters "Full" in the Page Rate field.

6. Send the message.

Manual Operation:

1. Select the Send Msg Execute.
 The SMS in Progress annunciator will light when the message is sent, and remain lit until an acknowledgment is received or SMS times out.



The MS Ack Rcvd will light when the Test Set has received an SMS Acknowledgment message from the MSUT.



HP-IB Syntax

"CDMA:SMS:TERM:SEND"

selects the Send Msg Execute field, which sends the message contained in the User Data field to the MSUT.

"STAT:CSMS:COND?"

queries the CDMA SMS Status Condition Register. Bit 0, (BCD 1) will be true while the SMS In Progress annunciator is lit.

"STAT:CSMS:EVEN?"

queries the CDMA SMS Status Event Register. Bit 1, (BCD 2) will be true after the MS Ack Rcvd light is lit.

Sending Short Messages on the Traffic Channels

This procedure sends a short message to the MSUT on the Traffic channels. The first message will be sent without setting up a call (Service Option 6 or 14), and the second message will be sent while the MSUT is on a call (Service Option 1 or 32768).

Measurement Overview

For detailed step-by-step explanation see the page associated with the step.

1. "Register the MSUT." on page 234.
2. "Optional: Clear (erase) old messages in the MSUT." on page 235.
3. "Enter a short message in the Test Set's data field." on page 236.
4. "Send the message." on page 237.
5. "Enter another short message in the Test Set's data field." on page 238.
6. "Make a call." on page 239.
7. "Send the message." on page 240.

1. Register the MSUT.

If the MSUT is already registered, this step is not necessary.

See "[Steps for Setting Up a Call](#)" on page 46 if you are not familiar with how this procedure is performed with the Test Set.

Registering the MSUT will ensure that it is monitoring the Test Set's Paging channel.

2. Optional: Clear (erase) old messages in the MSUT.

1. Access the message list and follow prompts on the MSUT to erase current messages.

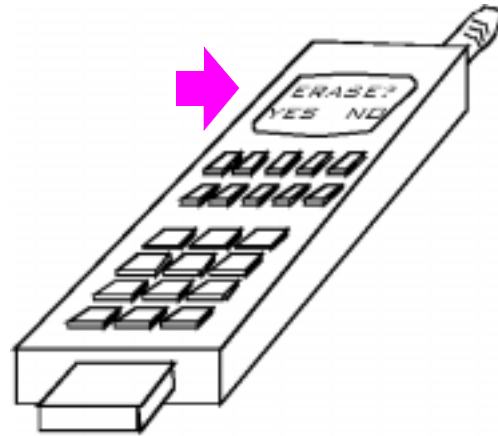

3. Enter a short message in the Test Set's data field.

<p>Manual Operation:</p> <ol style="list-style-type: none"> 1. Select SMS from the To Screen, CDMA list. 2. Position the cursor in front of the data field shown. 3. Press the knob and enter a message. Select Done when done. 	
---	--

HP-IB Syntax

"CDMA:SMS:TERM:DATA:ASC 'HP TEST & MEASUREMENT http://www.hp.com/go/tmdir'"

Enters a message in the User Data (ASCII) field.

4. Send the message.

Manual Operation:

1. Select Svc Opt 6 or 14.
2. Press the CALL key.

The MS Ack Rcvd will light when the MSUT has sent an acknowledgment that it received the message.

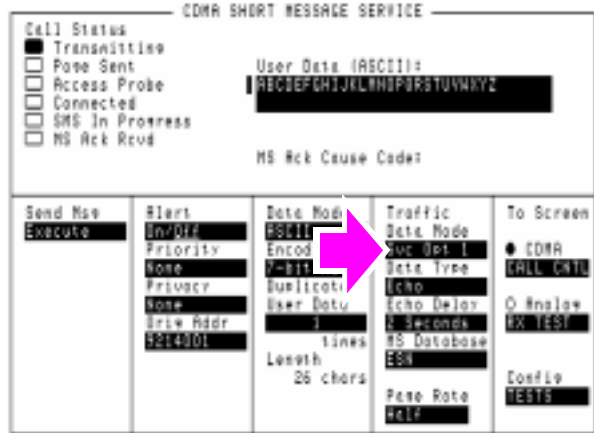

Selecting Service Option 6 will select Rate Set 1 (9600 bps full rate).

Selecting Service Option 14 will select Rate Set 2 (14400 bps full rate).

HP-IB Syntax

"CDMA:CALL:TRAF:DATA:MODE 'Svc Opt 6'"

selects Service Option 6 in the Traffic Data Mode field.

"CDMA:SMS:TERM:SEND"

selects the Send Msg Execute field, which sends the message contained in the User Data field to the MSUT.

"STAT:CSMS:COND?"

queries the CDMA SMS Status Condition Register. Bit 0, (BCD 1) will be true while the SMS In Progress annunciator is lit.

"STAT:CSMS:EVEN?"

queries the CDMA SMS Status Event Register. Bit 1, (BCD 2) will be true after the MS Ack Rcvd light is lit.

5. Enter another short message in the Test Set's data field.

<p>Manual Operation:</p> <ol style="list-style-type: none"> 1. Position the cursor in front of the data field shown. 2. Press the knob and enter the second message. Select Done when done. 	<p>The screenshot shows the 'CDMA SHORT MESSAGE SERVICE' menu. At the top, there are several status indicators: 'Cell Status', 'Transmitted', 'Page Sent', 'Access Probe', 'Connected', 'SMS In Progress', and 'MS Ack Rcvd'. Below these is the 'User Data (ASCII)' field, which is currently empty and highlighted with a black bar. A pink arrow points to this field. Below the 'User Data' field is the 'MS Act Cause Code' field. The bottom section of the menu is divided into five columns: 'Send Msg' (with 'Execute' selected), 'Alert' (with 'In/Dtx', 'Priority', 'None', 'Privacy', 'None', 'Orig Addr', and '9214001' listed), 'Data Mode' (with 'ASCII', 'Encoding', '7-bit ASCII', 'Duplicate', 'User Data', 'Length', and '25 chars' listed), 'Traffic' (with 'Data Mode', 'Sup Det L', 'Data Type', 'Echo', 'Echo Delay', '5 Seconds', 'ES Database', 'ESN', 'Page Rate', and 'Act' listed), and 'To Screen' (with 'CDMA', 'CALL CNTL', 'O Anslew', 'EX TEST', and 'Conflg TESTS' listed).</p>
--	---

HP-IB Syntax

"CDMA:SMS:TERM:DATA:ASC 'HP TEST & MEASUREMENT WEB SITE <http://www.hp.com/go/tmdir>' "

Enters a message in the User Data (ASCII) field.

6. Make a call.

Manual Operation:

1. Select Svc Opt 1 or 32768.
2. Press the **CALL** key.
3. When the MSUT rings, press the **SEND** (or green) key on the MSUT's keypad to connect the call.

The **Connected** annunciator must be lit before proceeding to the next step.



HP-IB Syntax

"CDMA:CALL:TRAF:DATA:MODE 'Svc Opt 1'"

selects Service Option 1 in the Traffic Data Mode field.

"CDMA:CALL:MAKE"

Attempts a call by paging the MSUT. This is the same function performed by pressing the **CALL** key on the Test Set's front panel.

7. Send the message.

Manual Operation:

1. Select the Send Msg Execute field.

The SMS in Progress annunciator will light when the message is sent, and remain lit until an acknowledgment is received or SMS times out.

The MS Ack Rcvd will light when the MSUT has sent an SMS Acknowledgment message.

HP-IB Syntax
 "CDMA : SMS : TERM : SEND"

selects the Send Msg Execute field, which sends the message contained in the User Data field to the MSUT.

Establishing HP-IB Communication

Setting Up HP-IB Control

The Test Set should have power turned on.

Procedure Overview

For detailed step-by-step explanation see the page associated with the step.

1. ["Connect the HP-IB Cable if you are using an external controller." on page 243.](#)
2. ["Check the Test Set's HP-IB address if you are using an external controller." on page 244.](#)
3. ["Change the Test Set's HP-IB Address if necessary." on page 245.](#)

1. Connect the HP-IB Cable if you are using an external controller.

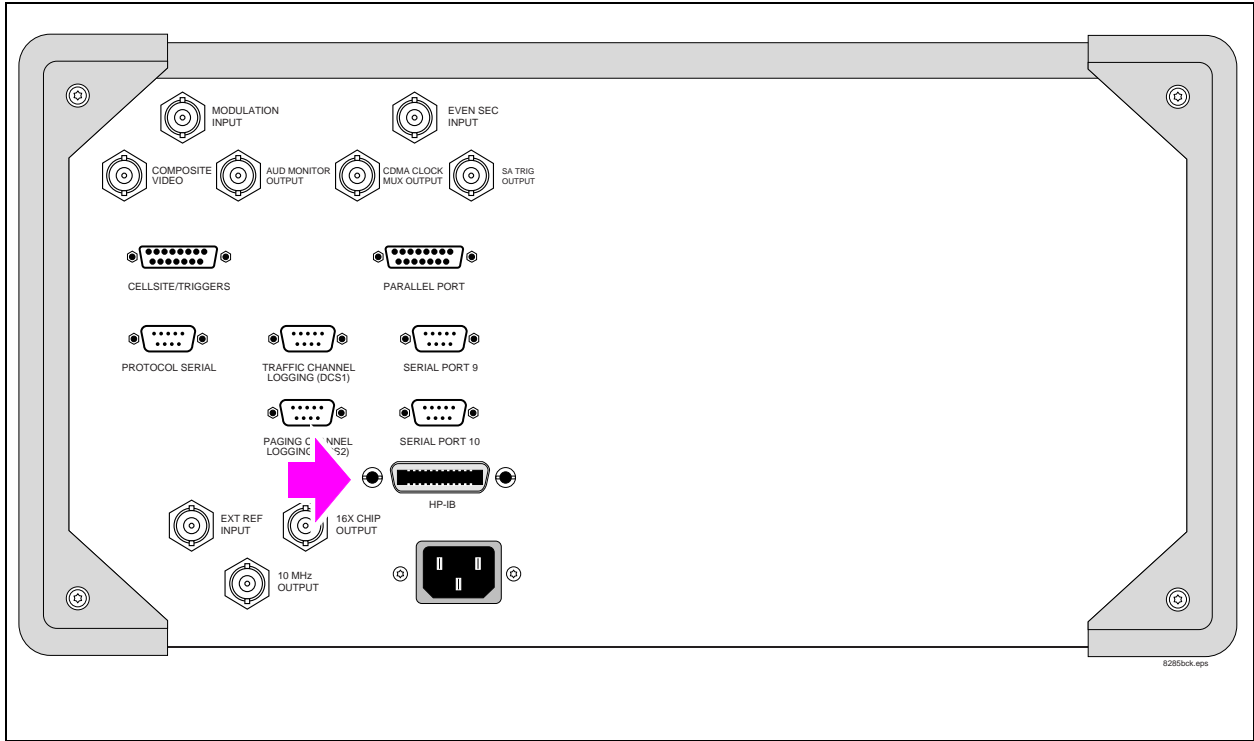

2. Check the Test Set's HP-IB address if you are using an external controller.

Manual Operation:

1. Press and release the **SHIFT** key, and then the **Local** key to display the Test Set's current HP-IB address setting. The address will display at the top of the CRT.

If the address needs to be changed, proceed with the next step.

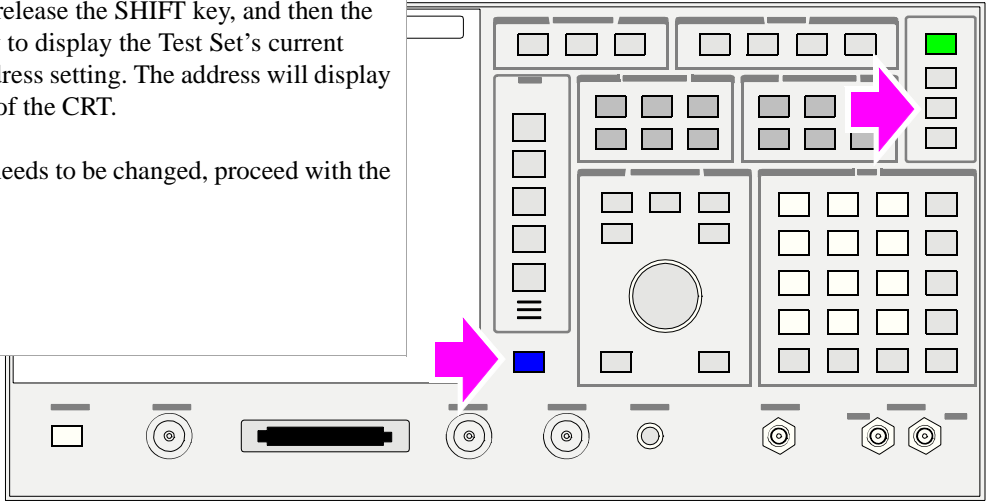

The diagram shows a control panel with a grid of buttons and a central knob. A text box on the left contains instructions. A blue arrow points to a button labeled 'SHIFT' on the left side of the panel. A pink arrow points to a button labeled 'LOCAL' in the top right corner of the button grid. A green light is visible in the top right corner of the panel.

3. Change the Test Set's HP-IB Address if necessary.

Manual Operation:

1. Press and release the SHIFT key, and then the Previous key to display the I/O CONFIGURE screen.
2. Position cursors at HP-IB Adrs field.
3. Use the DATA keys to enter the address.



I/O CONFIGURE				
HP-IB Adrs	Serial_9 In	Serial Port	PCMCIA	
15	Inst/IBASIC	Port 9	Format Card	
Mode	IBASIC Echo	Serial Baud	Card Status	
Talk&Lstn	On/Off	9600	No Card	
	Inst Echo	Parity		
	On/Off	None		
Save/Recall		Data Length		
Internal		8 bits		
		Stop Length		
		1 bit		
		Flow Cntl		
		Non/Xoff		
				To Screen
				CDMA
				CALL CNTL
				Analog
				RX TEST
				Confis
				TESTS

Using the Analog Call Processing Subsystem

Description of the Analog Call Processing Subsystem

The Analog Call Processing Subsystem, which comprises six call processing screens, simulates an analog cellular base station. The Analog Call Processing Subsystem provides, through host firmware control, the specific signals and protocol messages necessary to automatically establish and maintain a cellular link between the Test Set (simulated base station) and a cellular phone (mobile station).

Once the link is established the operator can exercise the call processing functionality of the mobile station, such as

- decoding orders from the base station, such as orders to retune the transceiver to a new channel, to alert the mobile station user to an incoming call, to adjust the transceiver output power level, or to release the mobile station upon completion of a call.
- encoding signaling information for transmission to the base station, such as dialed digits for call origination, disconnect signal at the completion of a call, or mobile identification number.

In addition to exercising the mobile station's call processing functions, the Test Set automatically

- measures some of the basic RF characteristics of the mobile station's transmitted carrier, such as; transmitter power, frequency accuracy and modulation deviation
- decodes and displays various reverse control channel and reverse voice channel signaling messages

For forward control channel and forward voice channel signaling messages, the operator has the option of sending messages whose contents are built using the rules and regulations specified in the applicable industry standard, or the operator can define the message contents as desired. Having the capability to set the bit patterns of the signaling messages sent to the mobile station gives the operator the capability to test the robustness of the mobile station by introducing known errors into the signaling message.

Operational Overview

The Test Set is able to simulate a cellular base station by using its hardware and firmware resources to initiate and maintain a link with only one mobile station. Unlike a real base station, which has many transceivers and can support many mobile stations simultaneously, the Test Set has only one transceiver (it's signal generator and RF/AF analyzer) and can support only one mobile station at a time. This means that the Test Set's transceiver can be configured as either a control channel or a voice channel, but not both simultaneously.

To establish a link with a mobile station the Test Set's transceiver is configured as a control channel. Once a link has been established and the user wishes to test the mobile station on a voice channel, the Test Set sends the appropriate information to the mobile station on the control channel and then automatically re-configures it's transceiver to the voice channel assigned to the mobile station. Once the voice channel link is terminated the Test Set automatically re-configures it's transceiver back to being a control channel.

Analog to analog handoffs are accomplished in a similar manner. When a handoff is initiated while on a voice channel, the Test Set sends the necessary information to the mobile station on the current voice channel. At the proper time the Test Set then automatically re-configures it's transceiver to the new voice channel.

Figure 1, "Call Processing State Diagram," on page 250 illustrates the primary call processing functions available in the Analog Call Processing Subsystem. Each box represents a call processing state and includes the measurement information available while in that state. The events which trigger transitions between the various states are shown on the diagram. Events which are initiated from the Test Set are shown in solid lines and events which are initiated from the mobile station are shown in dashed lines. The annunciators on the call processing screens will be lit while in that call processing state.

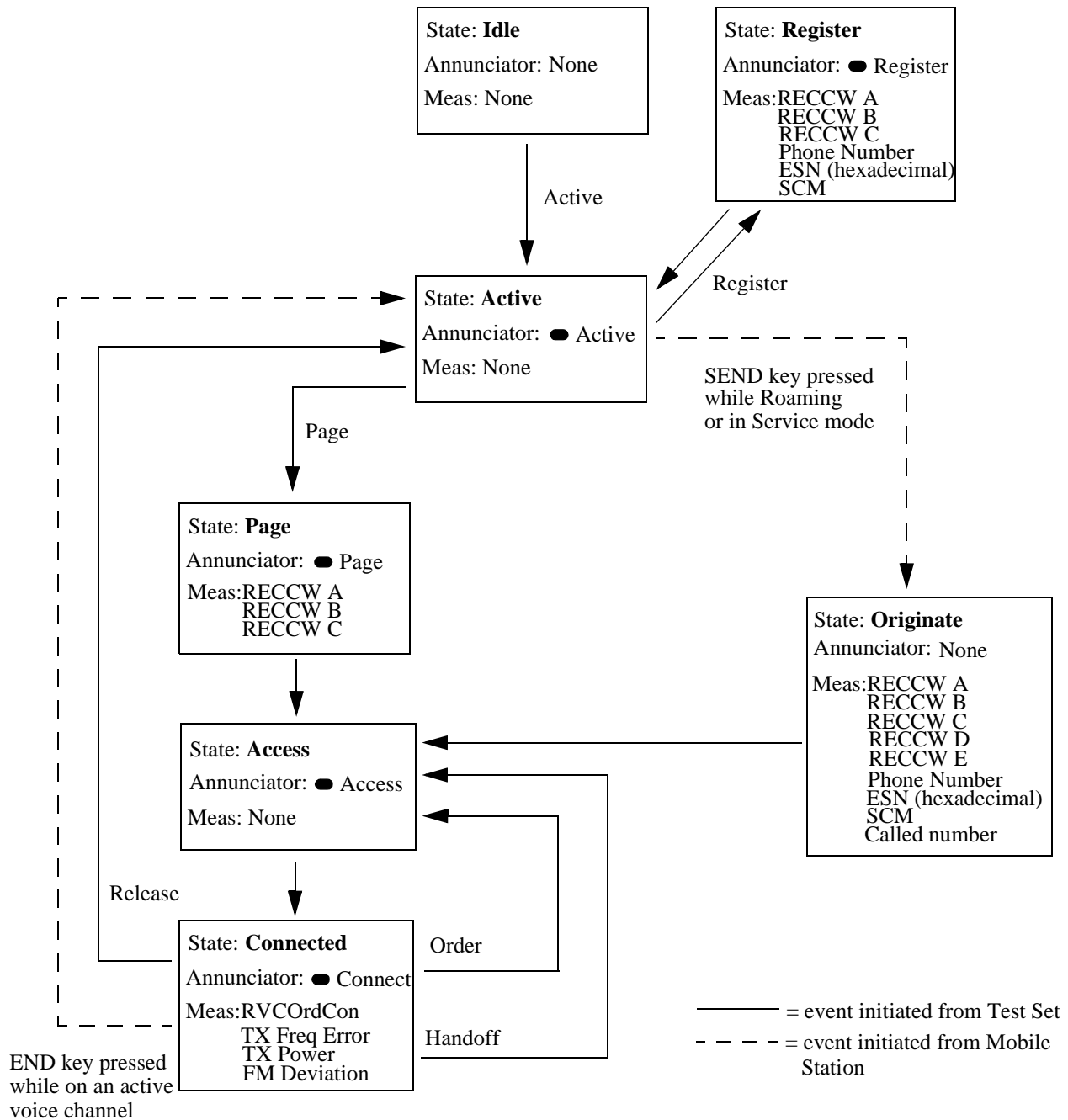

Figure 1 Call Processing State Diagram

Accessing the Analog Call Processing Subsystem Screens

The Analog Call Processing Subsystem screens are accessed by pressing the ANALOG SCREENS Call control key.

Analog Call Processing Subsystem Screens

The Analog Call Processing Subsystem consists of six screens.

- CALL CONTROL is the primary Analog Call Processing Subsystem screen. This screen contains the fields used to configure the simulated base station parameters such as SAT Tone frequency, control channel number, system identification number, etc. Call processing functions such as registration, page, handoff, etc. can be activated from this screen. The transmit power of the mobile station can be set from this screen. Data messages received from the mobile station are displayed on this screen.
- CALL DATA screen displays the decoded signaling messages received from the mobile station on the reverse control channel and the reverse voice channel. Call processing functions such as registration, page, handoff, etc. can also be activated from this screen. The transmit power of the mobile station can be set from this screen.
- CALL BIT screen allows the advanced user to modify the contents of the forward control channel and forward voice channel messages used in a call processing messaging protocol (that is - the sequence of messages sent from the simulated base station to the mobile station to perform a desired action).
- CALL CONFIGURE screen contains the fields used to configure various parameters related to the Analog Call Processing Subsystem.
- ANALOG MEAS screen is used to make analog RF and audio measurements on the mobile station while a link is active.

Using Manual (Front-Panel) Control

In order to use the Analog Call Processing Subsystem a mobile station must be connected to the Test Set and be powered on.

Connecting A Mobile Station

Figure 2, "Connecting a Mobile Station to the Test Set," on page 253 shows a typical example of connecting a mobile station to the Test Set. Many of today's small, handheld mobile stations require special fixtures, available from the mobile station manufacturer, to access the antenna, audio in and audio out on the mobile station.

If any audio testing is to be done on the mobile station, the audio input (microphone input) to the mobile station and the audio output (speaker output) from the mobile station must be connected to the Test Set. If no audio testing is to be done only the antenna needs to be connected to the Test Set.

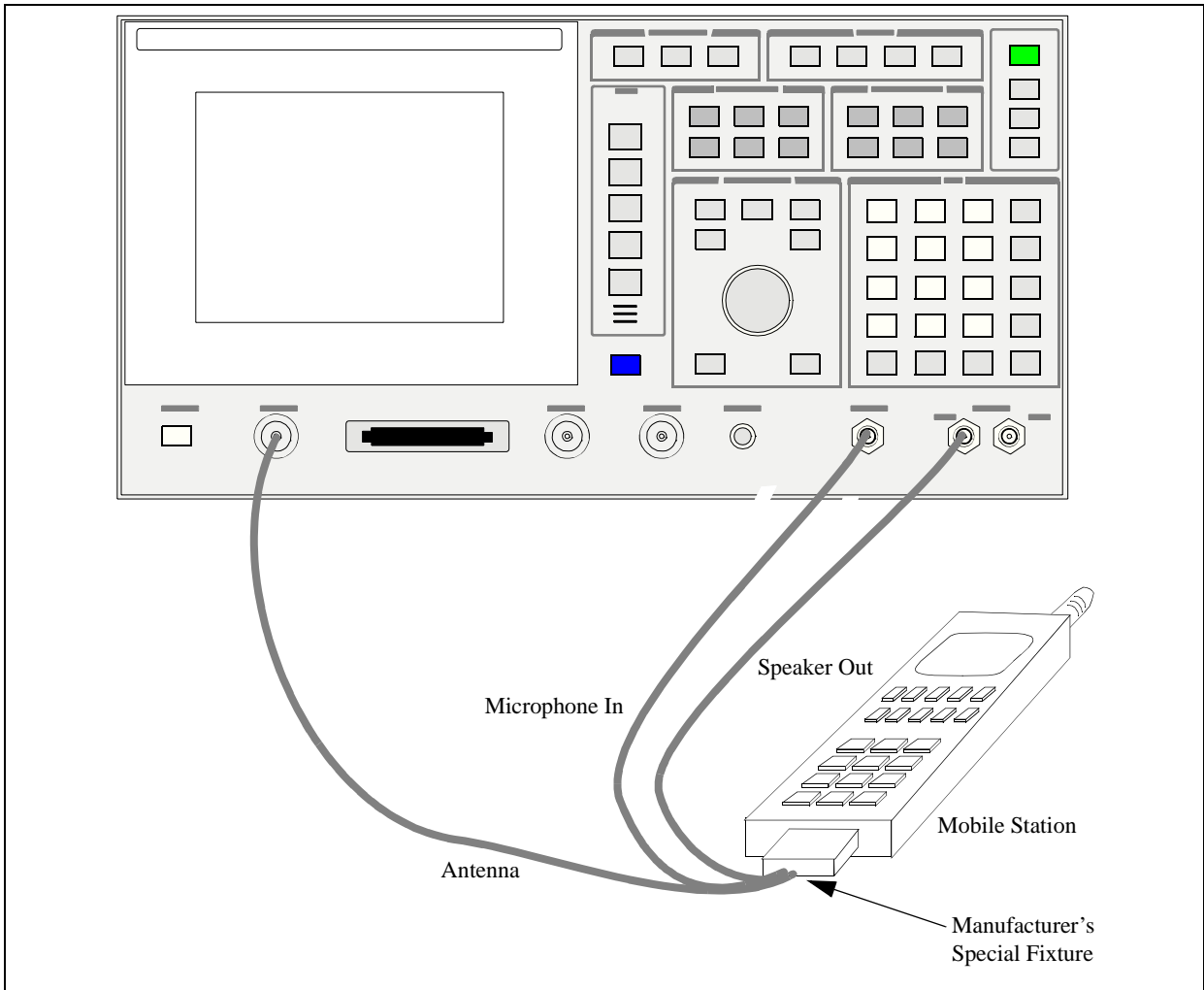

Figure 2 Connecting a Mobile Station to the Test Set

NOTE:

Do not connect the antenna of the mobile station to the ANT IN port on the front panel of the Test Set; this will cause the overpower protection circuitry to trip when the mobile station is transmitting.

Mobile Station Audio Out Impedance

If the mobile station's speaker is disconnected when using the manufacturer's special fixture, the user must ensure that the proper load impedance is present at the audio output of the mobile station. The special fixtures supplied by the manufacturer of the mobile station may or may not terminate the audio output in its proper load impedance. Refer to the manufacturer's documentation for information on the termination supplied by the special fixture.

If a load impedance must be supplied then it can be placed across the AUDIO IN connector.

600 Ohm Impedance Some industry standards require the audio out of the mobile station to be terminated in 600 ohms for testing purposes. The AUDIO IN connector of the Test Set can be terminated in 600 ohms internally.

Generalized Test Procedure

This section presents a generalized which can be followed to successfully use the Analog Call Processing Subsystem. This procedure does not exercise all the functionality of the Analog Call Processing Subsystem. The procedure exercises the mobile station as follows:

- registers the mobile station
 - pages the mobile station
 - brings the mobile station up on a voice channel
 - hands the mobile station off to a new voice channel
 - makes a 12 dB SINAD measurement on the mobile station while on a voice channel (if the mobile station's audio in/out connections are available)
 - releases the mobile station
1. Press the PRESET key to preset the Test Set.
 2. Press the ANALOG SCREENS Call control key to display the CALL CONTROL screen.
 3. Select **CALL CNFG** from the **To Screen** menu.
 4. Disconnect any cables from the RF IN/OUT port on the front panel of the Test Set.

5. Select the **TX Pwr Zero** field.

When any Analog Call Processing Subsystem screen is displayed (except the ANALOG MEAS screen) and the Analog Call Processing Subsystem is in the connected state (**Connect** annunciator is lit), the host firmware constantly monitors the mobile station's transmitted carrier power. If the power falls below 0.0005 Watts the error message **RF Power Loss indicates loss of Voice Channel** will be displayed and the simulated base station will terminate the call and return to the active state (**Active** annunciator is lit). Zeroing the power meter cancels any inherent dc offsets that may be present within the power meter under zero power conditions. This ensures that the host firmware makes the correct decisions regarding the presence of the mobile stations's RF carrier.

6. Press the UTILITIES Config key to display the CONFIGURE screen.
7. Position the cursor on the **Notch Coupl** field and select **AFGen1**.

This couples the variable frequency notch filter to the output frequency of **AFGen1** (audio frequency generator #1). The notch filter is used when making the SINAD measurement. **AFGen1** is used to generate the audio tone for the SINAD measurement. Coupling the notch filter to the audio source ensures the most accurate measurement.

8. Connect the mobile station to the Test Set as shown in [figure 2 on page 253](#).
9. Turn the mobile station on.
10. Press the UTILITIES Previous key. The CALL CONTROL screen will be displayed.
11. Verify that the simulated base station configuration information is correct for the mobile station to be tested. Check the following fields:
 - a. **System Type**
 - b. **Cntl Channel**
 - c. **SID**
 - d. **Chan:** (right-hand subfield)
 - e. **Pwr Lvl:** (right-hand subfield)
 - f. **SAT:** (right-hand subfield)
12. Position the cursor next to the **Active** field and select it. The **Active** annunciator will light when the control channel is turned on.

NOTE:

If the **Cntrl Channel** field or the **System Type** field were modified in step 11.a. or b. the control channel will already be active since modifying these fields automatically activates the control channel.

13. Position the cursor next to the **Register** field and select it. The **Register** annunciator will light while the registration is in process. If the mobile station responds properly on the reverse control channel the message **RECC Return** will flash momentarily in the upper right-hand corner of the CALL CONTROL screen and the mobile station phone number, ESN and decoded SCM will be displayed in the upper right-hand portion of the CALL CONTROL screen. The information in the **MS Id** field will be updated. The **Active** annunciator will light when the registration has successfully completed.

14. Position the cursor next to the **Page** field and select it. The **Page** annunciator will light while the simulated base station pages the mobile on the forward control channel. If the mobile station responds properly on the reverse control channel the message **RECC Return** will flash momentarily in the upper right-hand corner of the CALL CONTROL screen. The **Access** annunciator will then light while the simulated base station sends the mobile station an alert order on the assigned voice channel. The mobile station should ring. Press the SEND key on the mobile station. The **Connect** annunciator will light if the mobile station properly signals the simulated base station when the SEND key is pressed. The mobile station is now connected to the simulated base station on the assigned voice channel. The left-hand subfields in the **Voice Channel Assignment** section will be updated with the voice channel assignment information (that is - the “-” will be replaced with appropriate information).
15. Position the cursor on the **Display** field and select the **Meas** display. The upper right-hand portion of the CALL CONTROL screen will display modulation quality measurements of the mobile station’s RF carrier. The Test Set’s data functions, such as the average (**AVG**) function, can be used with any of the measurements. Measurement units can also be changed as desired.
16. Position the cursor on the **Order** field and select it. A **Choices:** menu is displayed showing the various power levels which the mobile station can be set to. Position the cursor next to the desired power level and select it. The simulated base station will then signal the mobile station with an order to set it’s power level. If the mobile responds properly the measured value in the **TX Power** field will change.
17. Position the cursor on the **Display** field and select the **Data** display.
18. Position the cursor on the **Order** field and select it. A **Choices:** menu is displayed showing the various power levels which the mobile station can be set to. Position the cursor next to the desired power level and select it. The **Access** annunciator will light while the simulated base station signals the mobile station with an order to set it’s power level. If the mobile responds properly the message **REVC Return** will flash momentarily in the upper right-hand corner of the CALL CONTROL screen and the decoded order confirmation message received from the mobile station will be displayed in the upper right-hand portion of the CALL CONTROL screen. The left-hand **Pwr Lvl:** subfield in the **Voice Channel Assignment** section will be updated with the new power level information.
19. Position the cursor on the **Chan:** field in the **Voice Channel Assignment** section and select it. Enter a new, valid voice channel number.
20. Position the cursor on the **Pwr Lvl:** field in the **Voice Channel Assignment** section and select it. Enter a new, valid mobile station power level.
21. Position the cursor on the **SAT:** field in the **Voice Channel Assignment** section and select it. Enter a new, valid SAT frequency.

22. Position the cursor on the **Handoff** field and select it. The **Access** annunciator will light while the simulated base station signals the mobile station with the handoff information. If the mobile responds properly it will stop transmitting on the current voice channel, switch to the new voice channel assignment and transpond the new SAT frequency assignment. When the simulated base station detects that this has happened, the **Connect** annunciator is lit indicating that the handoff was successful. The left-hand subfields in the **Voice Channel Assignment** section will be updated with the new voice channel assignment information.
23. Position the cursor on the **ANLG MEAS** field under the **To Screen** menu and select it. The ANALOG MEAS screen will be displayed.

NOTE:

The mobile station's speaker output must be connected to the Test Set's AUDIO IN connector and the mobile station's microphone input must be connected to the Test Set's AUDIO OUT connector in order to use the ANALOG MEAS screen. If the mobile station does not have audio connections go to 24.

24. There are many measurements which can be made on the mobile station from the ANALOG MEAS screen. The following example illustrates how to make a SINAD measurement.
 - a. Position the cursor on the **AFGen1 To** lower subfield and set it to 8 kHz.
 - b. Position the cursor on the **AF An1 In** field and select **Audio In**.
 - c. Position the cursor on the **Filter 1** field and select **C MESSAGE**.
 - d. Position the cursor on the **Filter 2** field and select **>99kHz LP**.
 - e. Position the cursor on the **Detector** field and select **PK+**.
 - f. Position the cursor on the **AF Freq** measurement field and select **SINAD**.
 - g. Position the cursor on the **Amplitude** field and begin to lower the transmitted base station voice channel power until 12 dB SINAD is reached.

NOTE:

The mobile station might mute or drop off the air before a 12 dB SINAD is reached. The performance of the mobile station at low RF levels is dependent upon the characteristics of the mobile station (that is - what type of system it is designed for). Unlike a real base station, the simulated base station does not perform any protocol functions on the voice channel.

25. Position the cursor on the **CALL CNTL** field under the **To Screen** menu and select it. The CALL CONTROL screen will be displayed.
26. Position the cursor on the **Release** field and select it. The simulated base station will signal the mobile station with a release order. The mobile station will respond to the release order and cease transmission. The simulated base station will terminate transmission on the forward voice channel and the **Connect** annunciator will turn off. The simulated base station will then reconfigure itself for transmission on the forward control channel, begin to transmit system parameter overhead messages and the **Active** annunciator will light.

Description of the Call Processing Subsystem's Remote User Interface

The Call Processing Subsystem's Remote User Interface consists of the following items:

- a set of programming commands which access all available fields on the six Call Processing Subsystem screens
- a status register group whose condition register reflects the current state of the Call Processing Subsystem annunciator state indicators
- a set of error messages, available through HP-IB, which provide information about error conditions encountered while in the Call Processing Subsystem

The programming commands provide the capability to generate control programs which can establish a cellular link between the Test Set (simulated Base Station) and a cellular phone (mobile station). The status register group and the error messages provide the control program with the information necessary to make program flow decisions.

Once a link is established the control program can exercise the call processing functionality of the mobile station, such as:

- the decoding of orders from the Base Station, such as; orders to retune the transceiver to a new frequency, to alert the mobile station user to an incoming call, to adjust the transceiver output power level, or to release the mobile station upon completion of a call.
- the encoding of signaling information for transmission to the base station, such as; dialed digits for call origination, disconnect signal at the completion of a call, or mobile identification number.
- the authentication signaling associated with AMPS (IS-54) call processing such as shared secret data update, unique challenge, origination with authentication and page with authentication.

In addition to the mobile station's call processing functions, the control program can utilize the RF and audio instruments in the Test Set to characterize the overall performance of the mobile station while on an active voice channel by making such measurements as; receiver sensitivity, FM Hum & Noise, transmitter carrier power, carrier frequency accuracy, SAT tone deviation, etc.

The Call Processing Subsystem decodes various reverse control channel and reverse voice channel signaling messages. The remote user interface provides commands which allow the control program access to the contents of the decoded messages.

For forward control channel and forward voice channel signaling messages, the Call Processing Subsystem provides the option of sending messages whose contents are built using the rules and regulations specified in the applicable industry standard, or the control program can define the message contents as desired. Having the capability to set the bit patterns of the signaling messages sent to the mobile station gives the control program the capability to test the robustness of the mobile station by introducing known errors into the signaling messages. Once an error has been introduced the control program can monitor the response of the mobile station.

Using Remote (HP-IB) Control

In order to use the Analog Call Processing Subsystem remotely, a mobile station must be connected to the Test Set and be powered on.

Accessing the Call Processing Subsystem Screens

The Call Processing Subsystem screens are accessed by selecting the **CALL CONTROL**, **CALL DATA**, **CALL BIT**, **CALL CONFIGURE**, **ANALOG MEAS**, or **AUTHENTICATION** screens using the :DISPlay command. The mnemonics used to select a particular screen with the DISPlay command are shown in HP-IB Command Syntax chapter of the *HP E8285A Condensed Programming Reference Guide*.

The Call Processing Subsystem screens are accessed by selecting the **CALL CONTROL**, **CALL DATA**, **CALL BIT**, **CALL CONFIGURE**, or **ANALOG MEAS** screens using the :DISPlay command. The mnemonics used to select a particular screen with the DISPlay command are shown in [table 4](#).

The query form of the :DISPlay command (that is, :DISPlay?) can be used to determine which screen is currently displayed.

Table 4

Call Processing Screen Mnemonics

Screens	Mnemonic
CALL CONTROL	ACNT
CALL DATA	CDAT
CALL BIT	CBIT
CALL CONFIGURE	CCNF
ANALOG MEAS	CME
AUTHENTICATION	AUTH

Syntax

```
:DISPlay <screen mnemonic>  
:DISPlay?
```

Example

```
OUTPUT 714;"DISP ACNT"  
OUTPUT 714;"DISP?"  
ENTER 714;Screen$
```

Command Syntax

The Analog Call Processing Subsystem programming commands and command syntax are detailed in HP-IB Command Syntax chapter of the *HP E8285A Condensed Programming Reference Guide*.

Examples of command usage are found in this section.

CAUTION:

The *OPC, *OPC? and *WAI commands should *not* be used for determining if a Call Processing Subsystem state command has completed successfully. Call Processing Subsystem states do not complete, a state is either active or not active. Using the *OPC, *OPC? or *WAI commands with a Call Processing Subsystem state command results in a deadlock condition.

CAUTION:

Refer to the descriptions of the deadlock conditions for *OPC, *OPC? and *WAI commands are provided in HP-IB Common Commands chapter of the *HP E8285A Condensed Programming Reference Guide*.

The *OPC, *OPC? or *WAI commands should not be used with any of the following Call Processing Subsystem commands: :ACTive, :REGister, :PAGE, :HANDoff, :RELease.

The Call Processing Subsystem Status Register Group should be used to control program flow.

Conditioning the Test Set for Call Processing

It is recommended that the control program perform the following steps when first entering the Analog Call Processing Subsystem (that is - the first time the **CALL CONTROL** screen is selected during a measurement session).

- Zero the RF Power meter.

There are two reasons for zeroing the RF power meter:

- a. When any Analog Call Processing Subsystem screen is displayed (except the ANALOG MEAS screen) and the Analog Call Processing Subsystem is in the **Connect** state, the host firmware constantly monitors the mobile station's transmitted carrier power. If the power falls below 0.0005 Watts the error message **RF Power Loss indicates loss of Voice Channel** will be displayed and the simulated base station will terminate the call and return to the **Active** state. Zeroing the power meter cancels any inherent dc offsets that may be present within the power meter under zero power conditions. This ensures that the host firmware makes the correct decisions regarding the presence of the mobile stations's RF carrier.
- b. Zeroing the power meter establishes a 0.0000 W reference for measuring the mobile station's RF power at the RF IN/OUT port. This ensures the most accurate RF power measurements of the mobile stations's RF carrier at different power levels.

Example

```
OUTPUT 714; "RFG:AMPL:STATE OFF"  
OUTPUT 714; "DISP RFAN;:RFAN:PME:ZERO"  
OUTPUT 714; "RFG:AMPL:STATE ON"
```

NOTE:

Ensure that no RF power is applied to the **RF IN/OUT** port when the power meter is being zeroed.

- Couple the variable frequency notch filter to AFGen1.

This step is only required if audio testing is to be done on the mobile station. This step couples the variable frequency notch filter to the output frequency of AFGen1 (audio frequency generator #1). The notch filter is used when making SINAD measurements. AFGen1 is used to generate the audio tone for the SINAD measurement. Coupling the notch filter to the audio source ensures the most accurate measurement.

Commands:

```
OUTPUT 714; "DISP CONF;:CONF:NOTC 'AFGEN1' "
```

Analog Call Processing Subsystem HP-IB Error Messages

The Analog Call Processing Subsystem HP-IB error messages are numbered 1300 through 1317. See the “Error Messages” chapter in the *HP E8285A User’s Guide* for details.

Reading Analog Call Processing Subsystem HP-IB Error Messages

If an error occurs while in the Analog Call Processing Subsystem, an appropriate error message will be placed in the Error Message Queue. The control program can read the Error Message Queue to retrieve the error message.

See “Error Message Queue” in the Status Reporting chapter of the *HP E8285A User’s Guide* for detailed information.

If an error occurred while attempting to decode data messages received from the mobile station on the reverse control channel or reverse voice channel, the raw data message bits are displayed in hexadecimal format in the upper right hand portion of the CALL CONTROL screen.

Figure 3 on page 263 shows layout of the CALL CONTROL screen when a decoding error has occurred. The raw data bits can be read by the control program.

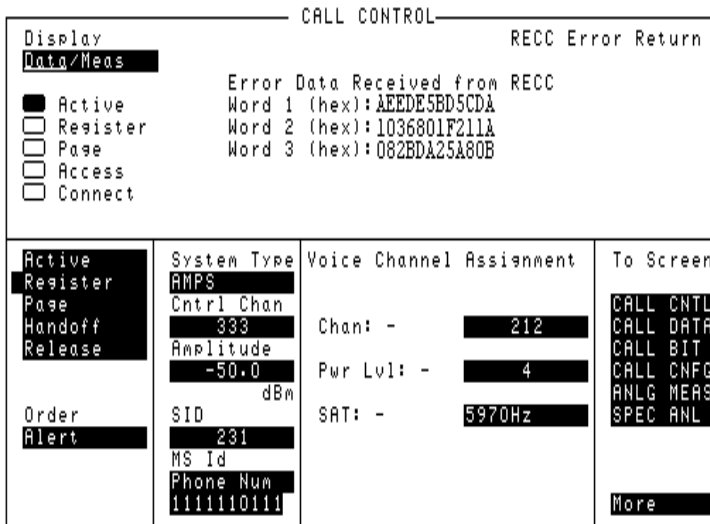

Figure 3

CALL CONTROL Screen with Decoding Error Message Display

Call Processing Status Register Group

See “Analog Call Processing Subsystem Status Register Group” in the Status Reporting chapter of the *HP E8285A User’s Guide* for a detailed description.

Using the Call Processing Status Register Group To Control Program Flow

The Analog Call Processing Subsystem uses annunciators to indicate its current state. That is - if the Analog Call Processing Subsystem is in the connected state, the **Connect** annunciator will be lit.

Bits 0 through 5 of the Condition register in the Call Processing Status Register Group mirror the condition of the annunciators. That is - if the **Connect** annunciator is lit, bit 5 of the Condition register will be TRUE, logic 1, and all other bits will be FALSE, logic 0.

Under most circumstances a control program will need some means of determining the state of an interaction between itself (the control program), the Analog Call Processing Subsystem and the mobile station.

For example - if the control program wishes to register a mobile station, it (the control program) will have to send a command to put the Analog Call Processing Subsystem into the **Active** state, then, once in the **Active** state, send a registration message by putting the Analog Call Processing Subsystem into the **Register** state and then determine when to read the mobile station’s registration information in order to make a determination as to whether the mobile station registered correctly.

In the manual user interface, the annunciators supply this state information to the operator. In the remote user interface, the Call Processing Status Register Group supplies the state information to the control program.

The control program can access this information in one of two ways; by polling the status registers or by using the service request feature of the HP-IB. If properly implemented, either method can be used to obtain the information. Refer to Status Reporting chapter of the *HP E8285A User’s Guide*.

When To Query Data Messages Received From The Mobile Station

The Analog Call Processing Subsystem makes available to the control program many data messages received from the mobile station. For example - if the simulated Base Station sends a registration message to the mobile station, the registration information (MIN, ESN, SCM) received from the mobile station can be read by the control program.

The data messages are displayed on the CRT *after* the successful completion of the call processing function (registration, page, origination, etc.). When call processing functions complete, state changes occur within the Analog Call Processing Subsystem. For example - when a registration completes the Analog Call Processing Subsystem exits the register state (the **Register** annunciator is turned off) and returns to the active state (the **Active** annunciator is turned on).

The control program should only query the Test Set for the data messages *after* all the state transitions are complete. For example - the control program should not attempt to read the MIN, ESN or SCM until after the **Register** annunciator is turned off and the **Active** annunciator is turned on.

This is because the Test Set has a multi-tasking architecture wherein multiple processes execute on a priority driven and an event driven basis. Each process is given a timeslice on the CPU depending upon its priority, the priority of other processes and the nature of the events occurring within the Test Set.

Upon completion, processes within the Analog Call Processing Subsystem pass data messages received from the mobile station to the Measurement Display Process which displays the information on the CRT during its next CPU timeslice. If the control program attempts to query the data fields before the Measurement Display Process has posted the information to the CRT, it is possible that the fields will be blank or contain data from a previous call processing function.

Waiting to read the data messages until after all state transitions have occurred ensures that the data from the most recent call processing function will have been posted. [Table 5, "Analog Call Processing Subsystem State Transitions" on page 266](#) lists the possible state transitions within the Analog Call Processing Subsystem.

Table 5 Analog Call Processing Subsystem State Transitions

Starting State	Command	State Transitions	Final State
Idle	Active	Idle - Active	Active
Active	Register	Active - Register - Active	Active
Active	Page	Active -Page - Access - Connect	Connect
Connect	Handoff	Connect - Access - Connect	Connect
Connect	Release	Connect - Active	Active
Connect	Order	Connect - Access - Connect	Connect
Any state	Active	Current state - Active	Active

NOTE:

The **Access** state may occur more than once during state transitions. For example: Connect - Access - Access - Connect. The number of times the **Access** state occurs is situation and system dependent.

If, for some specific application need, it is necessary to query the data messages before all state transitions have occurred, the control program may have to wait some finite amount of time before requesting the data or request the data multiple time (checking for the presence of data each time) or some combination of the two.

Analog Call Processing Subsystem state changes can be monitored by the control program through the Call Processing Status Register Group.

See “Call Processing Status Register Group” in Status Reporting chapter of the *HP E8285A User’s Guide* for a detailed description of the Analog Call Processing Subsystem Status Register Group.

Using the CALL CONTROL Screen to Test Call Processing Functions

Conditioning the Test Set for Call Processing

Perform the following steps when first entering the Call Processing Subsystem (that is, the first time the CALL CONTROL screen is selected during a measurement session).

1. Zero the RF Power Meter.
 - a. Select the **RF GEN** from the **To Screen** menu.
 - b. Set the **Amplitude** field to off (use the ON/OFF key). This prevent cross-coupling into the power detector while zeroing the power meter.
 - c. Press the ANALOG SCREENS Call control key.
 - d. Select **CALL CNFG** from the **To Screen** menu.
 - e. Disconnect any cables from the RF IN/OUT port on the front panel of the Test Set.
 - f. Select the **TX Pwr Zero** field.
 - g. Select the **RF Gen** from the To Screen menu.
 - h. Set the **Amplitude** field to On.

There are two reasons for zeroing the RF power meter:

- When any Call Processing Subsystem screen is displayed (except the ANALOG MEAS screen) and the Call Processing Subsystem is in the connected state (**Connect** annunciator is lit), the Test Set constantly monitors the mobile station's transmitted carrier power. If the power falls below 0.0005 Watts, the error message **RF Power Loss indicates loss of Voice Channel** will be displayed and the Test Set will terminate the call and return to the active state. Zeroing the power meter cancels any inherent dc offsets that may be present within the power meter under zero-power conditions. This ensures that the Test Set makes the correct decisions regarding the presence of the mobile stations's RF carrier.
- Zeroing the power meter establishes a 0.0000 W reference for measuring the mobile station's RF power at the RF IN/OUT port. This ensures the most accurate RF power measurements of the mobile station's RF carrier at different power levels.

2. Couple the variable-frequency notch filter to AFGen1.

This step is only required if audio testing is to be done on the mobile station. This step couples the variable-frequency notch filter to the output frequency of AFGen1 (audio frequency generator1). The notch filter is used when making SINAD measurements. AFGen1 is used to generate the audio tone for the SINAD measurement. Coupling the notch filter to the audio source ensures the most accurate measurement.

- a. Press the Config key to display the CONFIGURE screen.
- b. Position the cursor on the **Notch Coup1** field and select **AFGen1**.

Configure the Test Set

1. Press the ANALOG SCREENS Call control key. The CALL CONTROL screen will be displayed.
2. Verify that the Test Set configuration information is appropriate for the mobile station to be tested. Check the following fields:
 - a. **System Type** - Select the type of cellular system to be simulated (AMPS, NAMPS, TACS, JTACS).

NOTE:

If the **System Type** field was modified in step 2.a. the control channel will become active since modifying this field automatically activates the control channel. Refer to the "Call Control Screen" chapter in the *HP E8285A Reference Guide*.

- b. **System Type** - Select the type of cellular system to be simulated (AMPS, TACS, JTACS).

NOTE:

If the **System Type** field was modified in step 2. a. the control channel will become active since modifying this field automatically activates the control channel. Refer to the "Call Control Screen" chapter in the *HP E8285A Reference Guide*.

- c. **Cntl Channel** - Set the control channel number to be used by the Test Set.

NOTE:

If the **Cntl Channel** field was modified in step 2. c the control channel will become active since modifying this field automatically activates the control channel. Refer to the "Call Control Screen" chapter in the *HP E8285A Reference Guide*.

- d. **Amplitude** - Set the output power of the Test Set's transmitter (that is, the output power of the Test Set's RF Generator).
 - e. **SID** - Enter the system identification number of the Test Set as a decimal number.
 - f. **Chan:** (right-hand field) - Enter the voice channel number which will be assigned to the mobile station by the Test Set as either an initial voice channel assignment or as a handoff voice channel assignment.

- g. **Ch Loc:** (right-hand field, **NAMPS** system type only) - Select the narrow analog channel location which will be assigned to the mobile station by the Test Set as either an initial channel location assignment or as a handoff channel location assignment. The choices are Lower (10 kHz below standard wide analog channels), Middle (centered at the wide analog channel), Upper (10 kHz above the standard analog channel) or Wide Chan.
 - h. **Pwr Lvl:** (right-hand field) - Enter the Voice Mobile Attenuation Code (VMAC). The VMAC determines the mobile station power level to be used on the voice channel.
 - i. **DSAT:** (right-hand field, **NAMPS** system type only) - Select the DSAT Color Code (DSCC) to be used on the voice channel
 - j. **SAT:** (right-hand field) - Enter the SAT frequency to be used on the voice channel.
3. Select **CALL CNFG** from the **To Screen** menu. The CALL CONFIGURATION screen will be displayed.
 4. Verify that the Test Set's configuration information is appropriate for the mobile station to be tested. Check the following fields:
 - a. **CMAx** - Set the number of access channels in the system. This will determine how many channels must be scanned by the mobile station when trying to access the Test Set. The value of this field will affect the time required for the mobile station to connect with the Test Set.

Turn On The Test Set's Control Channel

1. If not already done, condition the Test Set. See "[Conditioning the Test Set for Call Processing](#)" on page 262 for further information.
2. If not already done, configure the Test Set. See "[Configure the Test Set](#)" on page 268 for further information.
3. If the CALL CONTROL screen is not displayed, select **CALL CNTL** from the **To screen** menu. The CALL CONTROL screen will be displayed.
4. Select the **Active** field. The **Active** annunciator will light when the control channel is turned on.

Register a Mobile Station

1. Ensure that the Test Set is in the active state. See "[Turn On The Test Set's Control Channel](#)" on page 270 for information on how to activate the Test Set.
2. Connect the mobile station to the Test Set as shown in [Figure 2, "Connecting a Mobile Station to the Test Set,"](#) on page 253.
3. Turn on the mobile station.
4. If the CALL CONTROL screen is not displayed, select **CALL CNTL** from the **To screen** menu. The CALL CONTROL screen will be displayed.
5. Position the cursor on the **Display** field and select **Data**.
6. Select the **Register** field. The **Register** annunciator will light while the registration is in process. If the mobile station responds properly on the reverse control channel, the message **RECC Return** will flash momentarily in the upper right-hand corner of the CALL CONTROL screen and the mobile station phone number, ESN and decoded SCM will be displayed in the upper right-hand portion of the CALL CONTROL screen. The information in the **MS Id** field will be updated. The **Active** annunciator will light when the registration has successfully completed.

Page a Mobile Station

There are two methods that can be used to page a mobile station:

- Page a mobile station that [has registered](#) with the Test Set.
- Page a mobile station that [has not registered](#) with the Test Set.

Paging a Mobile Station that has Registered with the Test Set

1. Ensure that the Test Set is in the active state. See "[Turn On The Test Set's Control Channel](#)" on page 270 for information on how to activate the Test Set.
2. Connect the mobile station to the Test Set as shown in [figure 2, "Connecting a Mobile Station to the Test Set,"](#) on page 253.
3. Turn on the mobile station.
4. If the CALL CONTROL screen is not displayed, select **CALL CNTL** from the **To Screen** menu. The CALL CONTROL screen will be displayed.
5. Position the cursor on the **Display** field and select **Data**.
6. Ensure that the mobile station has registered with the Test Set. See "[Register a Mobile Station](#)" on page 270 for information on how to register the mobile station.
7. Select the **Page** field. The **Page** annunciator will light while the Test Set pages the mobile on the forward control channel. If the mobile station responds properly on the reverse control channel, the message **RECC Return** will flash momentarily in the upper right-hand corner of the CALL CONTROL screen. The **Access** annunciator will then light while the Test Set sends the mobile station an alert order on the assigned voice channel. The mobile station should ring.
8. Press the SEND key on the mobile station. The **Connect** annunciator will light if the mobile station properly signals the Test Set when the SEND key is pressed. The mobile station is now connected to the Test Set on the assigned voice channel. The voice channel assignment section will be updated: that is, any "-" in the left-hand fields will be replaced with appropriate information.

- Paging a Mobile Station That Has Not Registered with the Test Set**
1. Ensure that the Test Set is in the active state. See "**Turn On The Test Set's Control Channel**" on page 270 for information on how to activate the Test Set.
 2. Connect the mobile station to the Test Set as shown in **Figure 2, "Connecting a Mobile Station to the Test Set,"** on page 253
 3. Turn on the mobile station.
 4. If the CALL CONTROL screen is not displayed, select **CALL CNTL** under the **To Screen** menu. The CALL CONTROL screen will be displayed.
 5. Position the cursor on the **Display** field and select **Data**.
 6. Select the lower **MS Id** field. Enter the mobile station identification number, either the phone number or the MIN number depending upon what the upper **MS Id** field is set to.
 7. Select the **Page** field. The **Page** annunciator will light while the Test Set pages the mobile on the forward control channel. If the mobile station responds properly on the reverse control channel, the message **RECC Return** will flash momentarily in the upper right-hand corner of the CALL CONTROL screen. The **Access** annunciator will then light while the Test Set sends the mobile station an alert order on the assigned voice channel. The mobile station should ring.
 8. Press the SEND key on the mobile station. The **Connect** annunciator will light if the mobile station properly signals the Test Set when the SEND key is pressed. The mobile station is now connected to the Test Set on the assigned voice channel. The **Voice Channel Assignment** fields will be updated: that is, any "-" in the left-hand fields will be replaced with appropriate information.

Handoff a Mobile Station to a New Voice Channel

1. Ensure that the Test Set is in the connect state. See "Page a Mobile Station" on page 271 for information on how to bring a mobile station up on a voice channel.
2. If the CALL CONTROL screen is not displayed, select **CALL CNTL** from the **To Screen** menu. The CALL CONTROL screen will be displayed.
3. Position the cursor on the **Display** field and select **Data**.
4. Select the **Chan:** field. Enter a new, valid voice channel number.
5. Select the **Ch Loc:** field (**NAMPS** system type only). Enter a new, valid channel location from the **Choices:** menu.
6. Select the **Pwr Lvl:** field. Enter a new, valid mobile station power level.
7. Select the **DSAT:** field (**NAMPS** system type only). Enter a new, valid DSAT from the **Choices:** menu.
8. Select the **SAT:** field. Enter a new, valid SAT frequency.
9. Select the **Handoff** field. The **Access** annunciator will light while the Test Set signals the mobile station with the handoff information. If the mobile responds properly, it will stop transmitting on the current voice channel, switch to the new voice channel, and transpond the newly assigned SAT frequency. When the Test Set detects this has happened the **Connect** annunciator is lit indicating that the handoff was successful. The **Voice Channel Assignment** section will be updated; that is, any "—" in the left-hand fields will be replaced with appropriate information.

Release A Mobile Station

1. Ensure that the Test Set is in the connected state. See "Page a Mobile Station" on page 271 for information on how to bring a mobile station up on a voice channel.
2. If the CALL CONTROL screen is not displayed, select **CALL CNTL** from the **To Screen** menu. The CALL CONTROL screen will be displayed.
3. Select the **Release** field. The Test Set will signal the mobile station with a release order. The mobile station will respond to the release order and cease transmission. The Test Set will terminate transmission on the forward voice channel, and the **Connect** annunciator will turn off. The Test Set will then reconfigure itself for transmission on the forward control channel, begin to transmit system parameter overhead messages, and the **Active** annunciator will light.

Change the Transmit Power Level of a Mobile Station

1. Ensure that the Test Set is in the connected state. See "Page a Mobile Station" on page 271 for information on how to bring a mobile station up on a voice channel.
2. If the CALL CONTROL screen is not displayed, select **CALL CNTL** from the **To Screen** menu. The CALL CONTROL screen will be displayed.
3. Position the cursor on the **Display** field and select **Meas**. The upper right-hand portion of the CALL CONTROL screen will display modulation quality measurements of the mobile station's RF carrier. The Test Set's data functions, such as the average (AVG) function, can be used with any of the measurements. Measurement units can also be changed as desired.
4. Select the **Order** field and select it. A **Choices:** menu is displayed showing the various power levels which the mobile station can be set to. Select the desired power level from the **Choices:** menu. The Test Set will then signal the mobile station with an order to set its power level. If the mobile responds properly, the measured value in the **TX Power** field will change.
5. Position the cursor on the **Display** field and select **Data**.
6. Select the **Order** field. Select the desired power level from the **Choices:** menu. The **Access** annunciator will light while the Test Set signals the mobile station with an order to set its power level. If the mobile responds properly, the message **REVC Return** will flash momentarily in the upper right-hand corner of the CALL CONTROL screen and then the decoded order confirmation message received from the mobile station will be displayed. The left-hand **Pwr Lvl:** field will be updated with the new power level information. The **Connect** annunciator will light when signaling is complete.

Originate a Call from a Mobile Station

1. Ensure that the Test Set is in the active state. See "[Turn On The Test Set's Control Channel](#)" on page 270 for information on how to activate the Test Set.
2. Connect the mobile station to the Test Set as shown in [Figure 2, "Connecting a Mobile Station to the Test Set,"](#) on page 253
3. Turn on the mobile station.
4. If the CALL CONTROL screen is not displayed, select **CALL CNTL** from the **To Screen** menu. The CALL CONTROL screen will be displayed.
5. Position the cursor on the **Display** field and select **Data**.
6. Dial the desired phone number on the mobile station and press the SEND key on the mobile station's handset. The mobile station signals the Test Set on the reverse control channel with an origination message which includes the dialed phone number, the mobile station's MIN number and the mobile station's ESN. If the mobile station transmitted properly on the reverse control channel, the message **RECC Return** will flash momentarily in the upper right-hand corner of the CALL CONTROL screen and then the mobile station phone number, ESN, decoded SCM, and the called phone number will be displayed. The Test Set will then reconfigure itself to the voice channel assignments set up in the **Voice Channel Assignment** section of the CALL CONTROL screen. The **Access** annunciator will then light while the Test Set signals the mobile station on the assigned voice channel. The **Connect** annunciator will light if the mobile station properly signals the Test Set on the reverse voice channel. The mobile station is now connected to the Test Set on the assigned voice channel. The left-hand fields will be replaced with appropriate information.

Send an Alert Order to a Mobile Station

1. Ensure that the Test Set is in the connected state. See "Page a Mobile Station" on page 271 for information on how to bring a mobile station up on a voice channel.
2. If the CALL CONTROL screen is not displayed, select **CALL CNTL** under the **To Screen** menu. The CALL CONTROL screen will be displayed.
3. Select the **Order** field. A **Choices:** menu is displayed showing the various orders which can be sent to the mobile station. Select the **Mainten** order from the list of choices. The Test Set will then go into the **Access** state and signal the mobile station with a maintenance order. If the mobile station is responding properly it will go into its maintenance state as defined by the applicable cellular system standard. The left-hand fields in the **Voice Channel Assignment** section will display a '-' while the Test Set is in the access state.
4. Select the **Order** field. A **Choices:** menu is displayed showing the various orders which can be sent to the mobile station. Position the cursor next to the **Alert** order and select it. The Test Set will then signal the mobile station with an alert order. If the mobile station is responding properly it will alert (that is, it will ring). Press the SEND key on the mobile station to respond to the alert order. The mobile station should exit the maintenance state. The Test Set, upon detecting that the mobile station has exited the maintenance state, will return to the **Connect** state and the left-hand subfields in the **Voice Channel Assignment** section will be updated with the current voice channel assignment information.

NOTE:

Applicable cellular system standards may specify a time-out period for the maintenance state. If an Alert order is not received during this time-out period the mobile station may take some action as defined by the standard. One such action might be to terminate the voice channel connection. Refer to the applicable cellular system standard for specific information

Using the CALL CONTROL Screen to test AMPS Authentication

The process of testing AMPS authentication (IS-54) through the Call Processing Subsystem requires the user to synchronize the base station and mobile station. This synchronization requires that the base station and the mobile station possess two pieces of shared secret data (SSD) to confirm a valid call. The first piece is the **ESN** of the mobile station and the second piece is the mobile station's **A-key**. The A-key is a secret 26-digit number stored in the mobile station's semi-permanent memory. The following sections describe how to:

- Condition the Test Set for Call Processing with Authentication
- Configure the Test Set for authentication
- Turn On The Test Set's Control Channel
- Initialize Call Processing with Authentication
- Page a Mobile Station with Authentication
- Originate a Call with Authentication
- Perform an SSD Update
- Perform a Unique Challenge

Condition the Test Set for Call Processing

Perform the following steps when first entering the Call Processing Subsystem (that is, the first time the CALL CONTROL screen is selected during a measurement session).

1. Zero the RF Power Meter.
 - a. Select the **RF Gen** from the **To Screen** menu.
 - b. Set the **Amplitude** field to off (use the ON/OFF key) This prevents cross-coupling into the power detector while zeroing the power meter.
 - c. Select **CALL CNTL** from the **To Screen** menu.
 - d. Select **CALL CNFG** from the **To Screen** menu.
 - e. Disconnect any cables from the RF IN/OUT port on the front panel of the Test Set.
 - f. Select the **TX Pwr Zero** field.

There are two reasons for zeroing the RF power meter:

- When any Call Processing Subsystem screen is displayed (except the ANALOG MEAS screen) and the Call Processing Subsystem is in the connected state (**Connect** annunciator is lit), the Test Set constantly monitors the mobile station's transmitted carrier power. If the power falls below 0.0005 Watts, the error message **RF Power Loss indicates loss of Voice Channel** will be displayed and the Test Set will terminate the call and return to the active state. Zeroing the power meter cancels any inherent dc offsets that may be present within the power meter under zero-power conditions. This ensures that the Test Set makes the correct decisions regarding the presence of the mobile stations's RF carrier.
 - Zeroing the power meter establishes a 0.0000 W reference for measuring the mobile station's RF power at the RF IN/OUT port. This ensures the most accurate RF power measurements of the mobile station's RF carrier at different power levels.
2. Couple the variable-frequency notch filter to AFGen1.

This step is only required if audio testing is to be done on the mobile station. This step couples the variable-frequency notch filter to the output frequency of AFGen1 (audio frequency generator 1). The notch filter is used when making SINAD measurements. AFGen1 is used to generate the audio tone for the SINAD measurement. Coupling the notch filter to the audio source ensures the most accurate measurement.

- a. Press and release the blue SHIFT key and then the DUPLEX key to display the CONFIGURE screen.
- b. Position the cursor on the **Notch Coupl** field and select **AFGen1**.

Configure the Test Set

1. Select **CALL CNTL** from the **To Screen** menu. The CALL CONTROL screen will be displayed.
2. Verify that the Test Set configuration information is appropriate for the mobile station to be tested. Check the following fields:
 - a. **System Type** - Select AMPS. At this time, only AMPS is supported for authentication.

NOTE:

If the **System Type** field was modified in step 2. a. the control channel will become active since modifying this field automatically activates the control channel. Refer to the “Call Control Screen” chapter in the *HP E8285A Reference Guide*.

- b. **Cntl Channel** - Set the control channel number to be used by the Test Set.

NOTE:

If the **Cntl Channel** field was modified in step 2. b. the control channel will become active since modifying this field automatically activates the control channel. Refer to the “Call Control Screen” chapter in the *HP E8285A Reference Guide*.

- c. **Amplitude** - Set the output power of the Test Sets’s transmitter (that is, the output power of the Test Set’s RF Generator).
 - d. **SID** - Enter the system identification number of the Test Set as a decimal number.
 - e. **Chan:** (right-hand field) - Enter the voice channel number which will be assigned to the mobile station by the Test Set as either an initial voice channel assignment or as a handoff voice channel assignment.
 - f. **Pwr Lvl:** (right-hand field) - Enter the Voice Mobile Attenuation Code (VMAC). The VMAC determines the mobile station power level to be used on the voice channel.
 - g. **SAT:** (right-hand field) - Enter the SAT frequency to be used on the designated voice-channel.
3. Select **CALL CNFG** under the **To Screen** menu. The CALL CONFIGURATION screen will be displayed.
 4. Verify that the Test Set’s configuration information is appropriate for the mobile station to be tested. Check the following field:
 - a. **CMAx** - Set the number of access channels in the system. This will determine how many channels must be scanned by the mobile station when trying to access the Test Set. The value of this field will affect the time required for the mobile station to connect with the Test Set.

Turn on the Test Set's Control Channel

1. If not already done, condition the Test Set. See "[Conditioning the Test Set for Call Processing](#)" on page 262 for further information.
2. If not already done, configure the Test Set. See "[Configure the Test Set](#)" on page 268. for further information.
3. If the CALL CONTROL screen is not displayed, select **CALL CNTL** from the **To screen** menu. The CALL CONTROL screen will be displayed.
4. Select **Active** field. The **Active** annunciator will light when the control channel is turned on.

Initialize Call Processing with Authentication

There are two methods to initialize Call Processing with authentication.

- Initializing Call Processing with Authentication [through registration](#) with the Test Set.
- Initializing Call Processing with Authentication [without registration](#) with the Test Set.

Initialize Call Processing through Registration

1. Ensure that the Test Set is in the active state. See "[Turn On The Test Set's Control Channel](#)" on page 270 .
 1. for information on how to activate the Test Set.
 2. Connect the mobile station to the Test Set as shown in [figure 2, "Connecting a Mobile Station to the Test Set,"](#) on page 253.
 3. Turn on the mobile station.
 4. If the CALL CONTROL screen is not displayed, select **CALL CNTL** under the **To Screen** menu. The CALL CONTROL screen will be displayed.
 5. Position the cursor on the **Display** field and select **Data**.
 6. Select the **Register** field. The **Register** annunciator will light while the registration is in process. If the mobile station responds properly on the reverse control channel, the message **RECC Return** will flash momentarily in the upper right-hand corner of the CALL CONTROL screen and then the mobile station's phone number, ESN and decoded SCM will be displayed in the upper right-hand portion of the CALL CONTROL screen. The information in the **MS Id** field will be updated. The **Active** annunciator will light when the registration has successfully completed.
 7. Select **AUTHEN** on the To Screen field. The AUTHENTICATION screen will be displayed.
 8. Select the **A_KEY** field and enter a valid A_KEY in decimal format.
 9. Position the cursor on the **Off/On** field and select **On**.
 10. Select **CALL CNTL** from the **To Screen** menu. The CALL CONTROL screen will be displayed.
 11. Select **SSD Upd** in the **CC Order** field. The Access annunciator light will light while the SSD Update order is in progress. If the mobile station responds properly on the reverse control-channel, "**SSD Update Order Successful**" will be displayed in the upper right-hand portion of the CALL CONTROL screen. The test set and the mobile station now share common secret data and further call processing functions with authentication can be tested. If the order failed, then "**SSD Update Order Failed**" will appear on the upper right-hand portion of the CALL CONTROL screen.

**Initializing
Authentication without
Registration**

1. Ensure that the Test Set is in the active state. See "**Turn On The Test Set's Control Channel**" on page 270 for information on how to activate the Test Set.
2. Connect the mobile station to the Test Set as shown in **figure 2, "Connecting a Mobile Station to the Test Set,"** on page 253.
3. Turn on the mobile station.
4. If the CALL CONTROL screen is not displayed, select **CALL CNTL** from the **To Screen** menu. The CALL CONTROL screen will be displayed.
5. Position the cursor on the **Display** field and select **Data**.
6. Select the upper **MS ID** field and then select **MIN2 MIN1** from the Choices: menu.
7. Select the lower **MS ID** field and enter the information in hexadecimal format.
8. Select **AUTHEN** from the To Screen menu. The AUTHENTICATION screen will be displayed.
9. Select the **A_KEY** field and enter a valid **A_KEY** in decimal format.
10. Select the **ESN** field and enter the mobile station's electronic serial number in a hexadecimal format.
11. Position the cursor on the **Off/On** field and select **On**.
12. Select **CALL CNTL** from the **To Screen** menu. The CALL CONTROL screen will be displayed.
13. Select **SSD Upd** from the **CC Order** field. The Access annunciator light will light while the SSD Update order is in progress. If the mobile station responds properly on the reverse control-channel, "**SSD Update Order Successful**" will be displayed in the upper right-hand portion of the CALL CONTROL screen. The test set and the mobile station now share common secret data and further call processing functions with authentication can be tested. If the order failed, then "**SSD Update Order Failed**" will appear on the upper right-hand portion of the CALL CONTROL screen.

Page a Mobile Station with Authentication

Paging A Mobile Station That Has Registered With The Test Set

1. Ensure that the Test Set is in the active state. See "[Turn On The Test Set's Control Channel](#)" on page 270 for information on how to activate the Test Set.
2. Connect the mobile station to the Test Set as shown in [Figure 2, "Connecting a Mobile Station to the Test Set,"](#) on page 253.
3. Turn on the mobile station.
4. If the CALL CONTROL screen is not displayed, select **CALL CNTL** from the **To Screen** menu. The CALL CONTROL screen will be displayed.
5. Position the cursor on the **Display** field and select **Data**.
6. Ensure that the mobile station has registered with the Test Set. See "[Initialize Call Processing with Authentication](#)".
7. for information on how to register the mobile station.
8. Select the **Page** field. The **Page** annunciator will light while the Test Set pages the mobile on the forward control channel. If the mobile station responds properly on the reverse control-channel the message **RECC Return** will flash momentarily in the upper right-hand corner of the CALL CONTROL screen. The **Access** annunciator will then light while the Test Set sends the mobile station an alert order on the assigned voice channel. The mobile station should ring.
9. Press the SEND key on the mobile station. The **Connect** annunciator will light if the mobile station properly signals the Test Set. The mobile station is now connected to the Test Set on the assigned voice channel. The **Voice Channel Assignment** fields will be updated, that is, any "-" in the left-hand fields will be replaced with appropriate information. If page with authentication was successful, "**Page w/Auth successful**" will be displayed in the upper right-hand portion of the CALL CONTROL screen. If page with authentication failed, then "**Page w/Auth failed**" will be displayed in the upper right-hand portion of the CALL CONTROL Screen.

Originate a Call with Authentication

1. Ensure that the Test Set is in the active state. See "[Turn on the Test Set's Control Channel](#)".
2. Connect the mobile station to the Test Set as shown in [Figure 2, "Connecting a Mobile Station to the Test Set," on page 253](#).
3. Turn on the mobile station.
4. If the CALL CONTROL screen is not displayed, select **CALL CNTL** under the **To Screen** menu. The CALL CONTROL screen will be displayed.
5. Position the cursor on the **Display** field and select **Data**.
6. Ensure that the mobile station has registered with the Test Set. See "[Initialize Call Processing with Authentication](#)" for information on how to register the mobile station.
7. Dial the desired phone number on the mobile station and press the SEND key on the mobile station's handset. The mobile station signals the Test Set on the reverse control channel with an origination message which includes the dialed phone number, the mobile station's MIN number and the mobile station's ESN. If the mobile station transmitted properly on the reverse control channel, the message **RECC Return** will flash momentarily in the upper right-hand corner of the CALL CONTROL screen and then the mobile station's phone number, ESN, decoded SCM, and called phone number will be displayed. The Test Set will then reconfigure itself to the voice channel assignments set up in the **Voice Channel Assignment** section of the CALL CONTROL screen. The **Access** annunciator will then light while the Test Set signals the mobile station on the assigned voice channel. The **Connect** annunciator will light if the mobile station properly signals the Test Set on the reverse voice channel. The mobile station is now connected to the Test Set on the assigned voice channel. The **Voice Channel Assignment** fields will be replaced with appropriate information. If origination with authentication was successful, then "**Origination w/Auth successful**" will be displayed in the upper right-hand portion of the CALL CONTROL screen. If origination with authentication failed, then "**Origination w/Auth failed**" will be displayed in the upper right-hand portion of the CALL CONTROL Screen.

Perform an SSD Update

There are two methods that can be used to perform an SSD Update:

- SSD Update on the [Control Channel](#)
- SSD Update on the [Voice Channel](#)

Performing an SSD Update on the Control Channel

1. Ensure that the Test Set is in the active state. See "[Turn On The Test Set's Control Channel](#)" on page 270 for information on how to activate the Test Set.
2. Connect the mobile station to the Test Set as shown in [Figure 2, "Connecting a Mobile Station to the Test Set,"](#) on page 253.
3. Turn on the mobile station.
4. If the CALL CONTROL screen is not displayed, select **CALL CNTL** from the **To Screen** menu. The CALL CONTROL screen will be displayed.
5. Position the cursor on the **Display** field and select **Date**.
6. Ensure that the Test Set has Initialized Call Processing with Authentication. See "[Initialize Call Processing with Authentication](#)" on page 281 for information on how to register the mobile station and activate Authentication.
7. Select **AUTHEN** on the To Screen menu. The AUTHENTICATION screen will be displayed.
8. Select **RANDSSD_1** field. Enter a new, valid RANDSSD_1 value (6-digit hexadecimal).
9. Select **RANDSSD_2** field. Enter a new, valid RANDSSD_2 value (6-digit hexadecimal).
10. Select **RANDSSD_3** field. Enter a new, valid RANDSSD_3 value (2-digit hexadecimal).
11. Select **CALL CNTL** under the **To Screen** menu. The CALL CONTROL screen will be displayed.
12. Select **SSD Upd** on the **CC Order** field. The **Access** annunciator light will light while the SSD Update order is in progress. If the mobile station responds properly on the reverse control channel, "**SSD Update Order Successful**" will be displayed in the upper right-hand portion of the CALL CONTROL screen. The Test Set and the mobile station are now linked and further call processing functions with authentication can be tested. If the order failed, then "**SSD Update Order Failed**" will appear on the upper right-hand portion of the CALL CONTROL screen.

Performing an SSD Update on the Voice Channel

1. Ensure that the Test Set is in the active state. See ["Turn On The Test Set's Control Channel" on page 270](#) for information on how to active the Test Set.
2. Connect the mobile station to the Test Set as shown in [Figure 2, "Connecting a Mobile Station to the Test Set," on page 253](#).
3. Turn on the mobile station.
4. If the CALL CONTROL screen is not displayed, select **CALL CNTL** from the **To Screen** menu. The CALL CONTROL screen will be displayed.
5. Position the cursor on the **Display** field and select **Data**.
6. Ensure that the Test Set has Initialized Call Processing with Authentication. See ["Initialize Call Processing with Authentication" on page 281](#) for information on how to register the mobile station and activate Authentication.
7. Ensure that the mobile station is on a voice channel. See ["Page a Mobile Station with Authentication" on page 283](#).
8. Select **AUTHEN** from the To Screen menu. The AUTHENTICATION screen will be displayed.
9. Select the **RANDSSD_1** field. Enter a new, valid RANDSSD_1 value (6-digit hexadecimal).
10. Select the **RANDSSD_2** field. Enter a new, valid RANDSSD_2 value (6-digit hexadecimal).
11. Select the **RANDSSD_3** field. Enter a new, valid RANDSSD_3 value (2-digit hexadecimal).
12. Select **CALL CNTL** under the **To Screen** menu. The CALL CONTROL screen will be displayed.
13. Select **SSD Upd** on the **VC Order** field. The **Access** annunciator light will light while the SSD Update order is in progress. If the mobile station responds properly on the reverse control channel, **"SSD Update Order Successful"** will be displayed in the upper right-hand portion of the CALL CONTROL screen. If the order failed then **"SSD Update Order Failed"** will appear on the upper right-hand portion of the CALL CONTROL screen.

Perform a Unique Challenge

There are two methods that can be used to perform a Unique Challenge-Response procedure:

- Unique Challenge on the [Control Channel](#)
- Unique Challenge on the [Voice Channel](#)

Performing a Unique Challenge on the Control Channel

1. Ensure that the Test Set is in the active state. See "[Turn On The Test Set's Control Channel](#)" on page 270 for information on how to activate the Test Set.
2. Connect the mobile station to the Test Set as shown in [Figure 2, "Connecting a Mobile Station to the Test Set,"](#) on page 253.
3. Turn on the mobile station.
4. If the CALL CONTROL screen is not displayed, select **CALL CNTL** under the **To Screen** menu. The CALL CONTROL screen will be displayed.
5. Position the cursor on the **Display** field and select **Data**.
6. Ensure that the Test Set has Initialized Call Processing with Authentication. See "[Initialize Call Processing with Authentication](#)" on page 281 for information on how to register the mobile station and activate Authentication.
7. Select **AUTHEN** on the To Screen menu. The AUTENTICATION will be displayed.
8. Select **RAND_U** field. Enter a new, valid RAND_U value (6-digit hexadecimal).
9. Select **CALL CNTL** under the **To Screen** menu. The CALL CONTROL screen will be displayed.
10. Select **Uniq Chal** from the **CC Order** field. The **Access** annunciator light will light while the Unique Challenge order is in progress. If the mobile station responds properly on the reverse control channel, "**Unique Challenge Successful**" will be displayed in the upper right-hand portion of the CALL CONTROL screen. If the order failed, then "**Unique Challenge Failed**" will appear on the upper right-hand portion of the CALL CONTROL screen.

Performing a Unique Challenge on the Voice Channel

1. Ensure that the Test Set is in the active state. See "[Turn On The Test Set's Control Channel](#)" on page 270 for information on how to activate the Test Set.
2. Connect the mobile station to the Test Set as shown in [Figure 2, "Connecting a Mobile Station to the Test Set,"](#) on page 253.
3. Turn on the mobile station.
4. If the CALL CONTROL screen is not displayed, select **CALL CNTL** from the **To Screen** menu. The CALL CONTROL screen will be displayed.
5. Position the cursor on the **Display** field and select **Data**.
6. Ensure that the Test Set has Initialized Call Processing with Authentication. See "[Initialize Call Processing with Authentication](#)" on page 281 for information on how to register the mobile station and activate Authentication.
7. Ensure that the mobile station is assigned an active voice channel. See "[Page a Mobile Station with Authentication](#)" on page 283.
8. Select **AUTHEN** from the To Screen menu. The AUTHENTICATION screen will be displayed.
9. Select the **RAND_U** field. Enter a new, valid RAND_U value (6-digit hexadecimal).
10. Select **CALL CNTL** from the **To Screen** menu. The CALL CONTROL screen will be displayed.
11. Select **Uniq Ch** from the **VC Order** field. The **Access** annunciator light will light while the Unique Challenge order is in progress. If the mobile station responds properly on the reverse control channel, "**Unique Challenge Successful**" will be displayed in the upper right-hand portion of the CALL CONTROL screen. If the order failed, then "**Unique Challenge Failed**" will appear on the upper right-hand portion of the CALL CONTROL screen.

Using the CALL DATA Screen

To View the Decoded Reverse Channel Words from a Mobile Station Registration

1. If not already done, condition the Test Set. See "[Conditioning the Test Set for Call Processing](#)" on page 262 for further information.
2. If not already done, ensure that the Test Set is properly configured. See "[Configure the Test Set](#)" on page 268 for further information.
3. Connect the mobile station to the Test Set as shown in [Figure 2, "Connecting a Mobile Station to the Test Set,"](#) on page 253.
4. Turn on the mobile station.
5. If the CALL DATA screen is not displayed, select **CALL DATA** from the **To Screen** menu. The CALL DATA screen will be displayed.
6. Select the **Active** field. The **Active** annunciator will light when the control channel is turned on.
7. Select the **Register** field. The **Register** annunciator will light while the registration is in process. If the mobile station responds properly on the reverse control channel, the message **RECC Return** will flash momentarily in the upper right-hand corner of the CALL CONTROL screen. The **Active** annunciator will light when the registration has successfully completed.
8. Select the **Display Word** field. A list of reverse channel words which can be displayed will appear in a **Choices:** menu. Select the desired word from the list of choices. The decoded contents for each of the fields in the selected word will be displayed in the lower portion of the display.

NOTE:

If a word is chosen which was not part of the decoded reverse channel message stream, all the fields will be blank when it is displayed.

Steps 7 and Step 8 in the above procedure can be reversed, that is, the desired word can be selected first, then the mobile station can be registered. If the registration is successful, the contents of each display word contained in the reverse control channel's message stream will be updated when the decoding is complete.

The registration does not have to happen while you are viewing the CALL DATA screen. When the CALL DATA screen is viewed, the contents of the display words will be the decoded data from the last successful call processing function (registration, origination, page, release, order).

To View the Decoded Reverse Channel Words from a Mobile Station Page

There are two methods that can be used to view the decoded RVCC words from a mobile station page:

- View the decoded RVCC words from a page for a mobile station that [has registered](#) with the Test Set
- View the decoded RVCC words from a page for a mobile station that [has not registered](#) with the Test Set

Viewing the Decoded Reverse Channel Words from a Page to a Mobile Station that has Registered with the Test Set

1. If not already done, condition the Test Set. [See "Conditioning the Test Set for Call Processing" on page 262](#) for further information.
2. If not already done, ensure that the Test Set is properly configured. [See "Configure the Test Set" on page 279](#) for further information.
3. Connect the mobile station to the Test Set as shown in [Figure 2, "Connecting a Mobile Station to the Test Set," on page 253](#).
4. Turn on the mobile station.
5. If the CALL DATA screen is not displayed, select **CALL DATA** under the **To Screen** menu. The CALL DATA screen will be displayed.
6. Select the **Active** field. The **Active** annunciator will light when the control channel is turned on.
7. Ensure that the mobile station has registered with the Test Set. [See "Register a Mobile Station" on page 270](#) for information on how to register the mobile station.
8. Select the **Page** field. The **Page** annunciator will light while the Test Set pages the mobile on the forward control channel. If the mobile station responds properly on the reverse control channel, the message **RECC Return** will flash momentarily in the upper right-hand corner of the CALL CONTROL screen. The **Access** annunciator will then light while the Test Set sends the mobile station an alert order on the assigned voice channel. The mobile station should ring.
9. Press the SEND key on the mobile station. The **Connect** annunciator will light if the mobile station properly signals the Test Set when the SEND key is pressed. The mobile station is now connected to the Test Set on the assigned voice channel.
10. Select the **Display Word** field. A list of reverse channel words appears in a **Choices:** menu. Select the desired word from the list of choices. The decoded contents for each of the fields in the selected word will be displayed in the lower portion of the display.

NOTE:

If a word is chosen which was not part of the decoded reverse channel's message stream, all the fields will be blank when it is displayed.

Steps 8 and 10 in the above procedure can be reversed, that is, the desired word can be selected first, then the mobile station can be paged. If the page is successful, the contents of each display word contained in the reverse control channel's message stream will be updated when the decoding is complete.

The page does not have to happen while you are viewing the CALL DATA screen. When the CALL DATA screen is viewed, the contents of the display words will be the decoded data from the last successful call processing function (registration, origination, page, release, order).

Viewing the Decoded Reverse Channel Words from a Page to a Mobile Station That Has Not Registered with the Test Set

1. If not already done, condition the Test Set. See "[Conditioning the Test Set for Call Processing](#)" on page 262 for further information.
2. If not already done, configure the Test Set. See "[Configure the Test Set](#)" on page 268
3. Connect the mobile station to the Test Set as shown in [Figure 2, "Connecting a Mobile Station to the Test Set,"](#) on page 253.
4. Turn on the mobile station.
5. If the CALL CONTROL screen is not displayed, select **CALL CNTL** under the **To Screen** menu. The CALL CONTROL screen will be displayed.
6. Select the lower **MS Id** field. Enter the mobile station identification number, either the phone number or the MIN number depending upon what the upper **MS Id** field is set to.
7. Select **CALL DATA** from the **To Screen** menu. The CALL DATA screen will be displayed.
8. Select the **Active** field. The **Active** annunciator will light when the control channel is turned on.
9. Select the **Page** field. The **Page** annunciator will light while the Test Set pages the mobile on the forward control channel. If the mobile station responds properly on the reverse control channel, the message **RECC Return** will flash momentarily in the upper right-hand corner of the CALL CONTROL screen. The **Access** annunciator will then light while the Test Set sends the mobile station an alert order on the assigned voice channel. The mobile station should ring.
10. Press the SEND key on the mobile station. The **Connect** annunciator will light if the mobile station properly signals the Test Set when the SEND key is pressed. The mobile station is now connected to the Test Set on the assigned voice channel.
11. Select the **Display Word** field. A list of reverse channel words which can be displayed will appear in a **Choices:** menu. Select the desired word from the list of choices. The decoded contents for each of the fields in the selected word will be displayed in the lower portion of the display.

NOTE:

If a word is chosen which was not part of the decoded reverse channel's message stream, all the fields will be blank when it is displayed.

Step 9 and step 11 in the above procedure can be reversed, that is - the desired word can be selected first, then the mobile station can be paged. If the page is successful, the contents of each display word contained in the reverse control channel's message stream will be updated when the decoding is complete.

The page does not have to happen while you are viewing the CALL DATA screen. When the CALL DATA screen is viewed, the contents of the display words will be the decoded data from the last successful call processing function (registration, origination, page, release, order).

To View the Decoded Reverse Channel Words From a Mobile Station Handoff

1. If not already done, condition the Test Set. See "[Conditioning the Test Set for Call Processing](#)" on page 262 for further information.
2. If not already done, configure the Test Set. See "[Configure the Test Set](#)" on page 279 for further information.
3. Connect the mobile station to the Test Set as shown in [Figure 2, "Connecting a Mobile Station to the Test Set,"](#) on page 253.
4. Turn on the mobile station.
5. Ensure that the Test Set is in the **Connect** state. See "[Page a Mobile Station](#)" on page 271 for information on how to bring a mobile station up on a voice channel.
6. If the CALL CONTROL screen is not displayed, Select **CALL CNTL** from the **To Screen** menu. The CALL CONTROL screen will be displayed.
7. Select the **Chan:** field and enter a new, valid voice channel number from the choices provided.
8. Select the **Ch Loc:** field (**NAMPS System Type** only) and enter a new, valid channel location from the choices provided.
9. Select the **Pwr Lvl:** field and enter a new, valid mobile station power level.
10. Select the **DSAT:** field (**NAMPS System Type** only) and enter a new, valid DSAT from the choices menu.
11. Select the **SAT:** field and enter a new, valid SAT frequency.
12. Select **CALL DATA** from the **To Screen** menu. The CALL DATA screen will be displayed.
13. Select the **Handoff** field. The **Access** annunciator will light while the Test Set signals the mobile station with the handoff information. If the mobile responds properly, it will stop transmitting on the current voice channel, switch to the new voice channel assignment, and transpond the new SAT frequency assignment. When the Test Set detects this has happened, the **Connect** annunciator lights indicating the handoff was successful.
14. Select the **Display Word** field. A list of reverse channel words which can be displayed will appear in a **Choices:** menu. Select the desired word from the list of choices. The decoded contents for each of the fields in the selected word will be displayed in the lower portion of the display.

NOTE:

If a word is chosen which was not part of the decoded reverse channel's message stream, all the fields will be blank when it is displayed.

Step 14 and step 15 in the above procedure can be reversed, that is - the desired word can be selected first, then the mobile station can be handed off. If the handoff is successful, the contents of each display word contained in the reverse control channel's message stream will be updated when the decoding is complete.

The handoff does not have to happen while you are viewing the CALL DATA screen. When the CALL DATA screen is viewed, the contents of the display words will contain the decoded data from the last successful call processing function (registration, origination, page, release, order).

To View the Decoded Reverse Channel Words from a Mobile Station Release

1. If not already done, condition the Test Set. See "[Conditioning the Test Set for Call Processing](#)" on page 262 for further information.
2. If not already done, configure the Test Set. See "[Configure the Test Set](#)" on page 268 for further information.
3. Connect the mobile station to the Test Set as shown in [Figure 2, "Connecting a Mobile Station to the Test Set,"](#) on page 253.
4. Turn on the mobile station.
5. Ensure that the Test Set is in the **Connect** state. See "[Page a Mobile Station](#)" on page 271 for information on how to bring a mobile station up on a voice channel.
6. Select **CALL DATA** under the **To Screen** menu. The CALL DATA screen will be displayed.
7. Select the **Release** field. The Test Set will signal the mobile station with a release order. The mobile station will respond to the release order and cease transmission. The Test Set will terminate transmission on the forward voice channel and the **Connect** annunciator will turn off. The Test Set will then reconfigure itself for transmission on the forward control channel, begin to transmit system parameter overhead messages and the **Active** annunciator will light.
8. Select the **Display Word** field. A list of reverse channel words which can be displayed will appear in a Choices: menu. Select the desired word from the list of choices. The decoded contents for each of the fields in the selected word will be displayed in the lower portion of the display.

NOTE:

If a word is chosen which was not part of the decoded reverse channel's message stream, all the fields will be blank when it is displayed.

Step 7 and step 8 in the above procedure can be reversed, that is, the desired word can be selected first, then the mobile station can be released. If the release is successful, the contents of each display word contained in the reverse control channel's message stream will be updated when the decoding is complete.

The release does not have to happen while you are viewing the CALL DATA screen. When the CALL DATA screen is viewed, the contents of the display words will contain the decoded data from the last successful call processing function (registration, origination, page, release, order).

To View the Decoded Reverse Channel Words from an Order to Change the Transmit Power Level of a Mobile Station

1. If not already done, condition the Test Set. See "[Conditioning the Test Set for Call Processing](#)" on page 262 for further information.
2. If not already done, configure the Test Set. See "[Configure the Test Set](#)" on page 268 for further information.
3. Connect the mobile station to the Test Set as shown in [Figure 2, "Connecting a Mobile Station to the Test Set,"](#) on page 253.
4. Turn on the mobile station.
5. Ensure that the Test Set is in the **Connect** state. See "[Page a Mobile Station](#)" on page 271 for information on how to bring a mobile station up on a voice channel.
6. If the CALL DATA screen is not displayed, select **CALL DATA** under the **To Screen** menu. The CALL DATA screen will be displayed.
7. Select the **Order** field and select it. A **Choices:** menu is displayed showing the various power levels which the mobile station can be set to. Select the desired power level. The **Access** annunciator will light while the Test Set signals the mobile station with an order to set its power level. If the mobile responds properly, the message **REVC Return** will flash momentarily in the upper right-hand corner of the CALL CONTROL screen. The **Connect** annunciator will light when signaling is complete.
8. Select the **Display Word** field. A list of reverse channel words which can be displayed will be presented. Position the cursor on the desired word and select it. The decoded contents for each of the fields in the selected word will be displayed in the lower portion of the display.

NOTE:

If a word is chosen which was not part of the decoded reverse channel's message stream, all the fields will be blank when it is displayed.

Step 7 and step 8 in the above procedure can be reversed, that is, the desired word can be selected first, then the mobile station can be sent an order to change transmit power level. If the order is successful, the contents of each display word contained in the reverse control channel's message stream will be updated when the decoding is complete.

The ordered to change transmit power does not have to happen while you are viewing the CALL CONTROL screen. When the CALL DATA screen is viewed, the contents of the display words will be the decoded data from the last successful call processing function (registration, origination, page, release, order).

To View The Reverse Channel Words From a Mobile Station Origination

1. If not already done, condition the Test Set. See "[Conditioning the Test Set for Call Processing](#)" on page 262 for further information.
2. If not already done, configure the Test Set. See "[Configure the Test Set](#)" on page 279 for further information.
3. Connect the mobile station to the Test Set as shown in [Figure 2, "Connecting a Mobile Station to the Test Set,"](#) on page 253
4. Turn on the mobile station.
5. Ensure that the Test Set is in the **Connect** state. See "[Page a Mobile Station](#)" on page 271 for information on how to bring a mobile station up on a voice channel.
6. Select the **Active** field. The **Active** annunciator will light when the control channel is turned on.
7. Dial the desired phone number on the mobile station and press the SEND key on the mobile station's handset. The mobile station signals the Test Set on the reverse control channel with an origination message which includes the dialed phone number, the mobile station's MIN number and the mobile station's ESN. If the mobile station transmitted properly on the reverse control channel, the message **RECC Return** will flash momentarily in the upper right-hand corner of the CALL CONTROL screen. The Test Set will then reconfigure itself to the voice channel assignments set up in the **Voice Channel Assignment** section of the CALL CONTROL screen. The **Access** annunciator will then light while the Test Set signals the mobile station on the assigned voice channel. The **Connect** annunciator will light if the mobile station properly signals the Test Set on the reverse voice channel. The mobile station is now connected to the Test Set on the assigned voice channel.
8. Select the **Display Word** field. A list of reverse channel words which can be displayed will be presented. Position the cursor on the desired word and select it. The decoded contents for each of the fields in the selected word will be displayed in the lower portion of the display.

NOTE:

If a word is chosen which was not part of the decoded reverse channel's message stream, all the fields will be blank when it is displayed.

Step 7 and step 8 in the above procedure can be reversed, that is, the desired word can be selected first, then a mobile station origination can be performed. If the origination is successful, the contents of each display word contained in the reverse control channel's message stream will be updated when the decoding is complete.

The origination does not have to happen while you are viewing the CALL DATA screen. When the CALL DATA screen is viewed, the contents of the display words will contain the decoded data from the last successful call processing function (registration, origination, page, release, order).

Using the CALL BIT Screen

Selecting The Message Content Generation Method

The contents (i.e. bit patterns) of the signaling messages sent to the mobile station on the forward control channel and the forward voice channel are generated using one of two methods. Method 1 uses the formats defined in the applicable industry standard to build the contents of the signaling messages. Method 2 uses the bit patterns which the user defines on the CALL BIT screen to build the contents of the signaling messages.

The **Data Spec** field on the CALL BIT screen determines which method will be used to build the contents of the signaling messages.

- **std** -The Test Set will use the signaling formats defined in the applicable industry standard to build the forward control channel and forward voice channel signaling messages. The Test Set will use the contents of the applicable fields on the CALL CONTROL screen and the CALL CONFIGURE screen to obtain information necessary to build the messages. Whenever a signaling message is used, the Test Set will update the contents of all fields in that message on the CALL BIT screen.
- **bits** -Use the bit patterns as set on the CALL BIT screen to build *all* forward control channel and forward voice channel signaling messages. For any call processing function (that is, setting the message stream on the active control channel, registering the mobile station, paging the mobile station, handing off the mobile station or releasing the mobile station) the user is responsible for setting the contents of all signaling messages used in that function. The Call Processing Subsystem uses the messaging protocol as defined in the applicable industry standard.

NOTE:

The contents of the applicable fields on the CALL CONTROL screen and the CALL CONFIGURE screen are *not* updated to reflect any changes made while in the Bits mode. There is no coupling between the Bits mode and the Test Set. For example: if a mobile station was actively connected to the Test Set on a voice channel and the user changed the **CHAN** field on the forward voice channel mobile station control message (FVC V Mes) and sent that message to the mobile station, the mobile station would change its voice channel assignment. However, the Test Set will stay on the voice channel assignment specified in the **Chan:** field on the CALL CONTROL screen. This situation will result in a dropped call. The Bits mode should not be used to change any parameter that can be set on any other Call Processing Subsystem screen.

System Operation When Data Spec Field Set to Std

When the **Data Spec** field is set to **std** the Test Set builds the signaling messages by first examining the fields which contain the information needed to build the messages (i.e. SID, BIS, SAT Tone, VMAC, etc.). After obtaining the necessary information the Test Set builds the bit patterns according to the signaling formats specified in the applicable industry standard.

For example: if the type of cellular system being emulated is AMPS and the **SID** field on the CALL PROC screen was set to 231, the SID1 field in the System Parameter Overhead Message (SPC WORD1) would be set to 00000001110011 (the 14 most significant bits of the system identification number) as defined by the *EIA/TIA-553 Mobile Station - Land Station Compatibility Specification*.

When the **Data Spec** field is set to **std**, the contents of the applicable message(s) on the CALL BIT screen are updated with the bit patterns generated using the signaling formats defined in the applicable industry standard whenever that signaling message is sent to the mobile station. This feature allows a user to set the **Data Spec** field to **std**, select a message of interest, perform a call processing function, and view the bit patterns generated using the signaling formats defined in the applicable industry standard.

It is important to note individual messages can be used more than once during a messaging protocol. The contents of any message viewed on the CALL BIT screen when the **Data Spec** field is set to **std** will reflect the message contents for the last time the message was used in a messaging protocol.

For example: if the Call Processing Subsystem is in the active state and the user selects the **Register** field, a registration message will be sent to the mobile station. When the registration completes the Call Processing Subsystem returns to the active state. The contents of some messages (such as the System Parameter Overhead Message Word 1) will reflect the correct settings for the active state, not the register state, since the messages are currently being used in the active state.

System Operation When Data Spec Field Set to Bits

When the **Data Spec** field is set to **Bits**, the Test Set builds the signaling messages using *only* the bit patterns set on the CALL BIT screen whenever a call processing function is executed which uses any of the available messages. The Test Set calculates the contents of the **Parity** field using the coding algorithms specified in the industry standard for the selected system (that is, the system specified in the **System Type** field on the CALL CONTROL screen).

By definition, the Test Set must meet the timing requirements of the industry standard for the selected system. Therefore, depending upon the state of the Call Processing Subsystem (i.e. Active, Register, Page, Access, or Connect) and the frequency with which a particular call processing protocol uses a particular message, it may not be possible to modify the contents of more than one field in a message before it is sent to the mobile station.

For example: in the AMPS system, the system parameter overhead message must be sent every 0.8 +/- 0.3 seconds on the forward control channel. Given this timing requirement it is highly unlikely that, while in the active state, a user could modify more than one field before the message was sent to the mobile station.

There is no functionality in the Test Set to allow an entire message to be modified and then inserted into a messaging protocol at a specific location at a specific time. This functionality requires a protocol analyzer.

When in the **Bits** mode the Test Set provides the messaging protocol for the user (that is, for a desired call processing function the correct message(s) will be sent at the correct time(s) according to the standard). It is the responsibility of the user to generate the contents of all the messages which will be used in a particular call processing function.

For example: if the Call Processing Subsystem was in the active state and the operator wished to register the mobile station from the **Bits** mode, the user would have to set the contents of all the messages used in the registration before selecting the **Register** field to start the registration process.

NOTE:

No error checking is done on the bit patterns. The bit patterns are used but are not checked against any industry standard. It is the responsibility of the user to ensure that the bit patterns set in the CALL BIT screen are correct when the **Data Spec** field is set to **Bits**. Unexpected operation of the mobile station can occur if the contents of the signaling messages are incorrect.

Changing the Content of a Message Field

Perform the following steps to change the contents of a message field:

1. Position the cursor on the **Data Spec** field and select **Bits**.
2. Select the **Set Message** field. A **Choices:** menu is displayed listing the available messages. Select the desired message. The message fields will be displayed on the screen.
3. Select the desired bit field. A **Choices:** menu will be displayed. Using the **Choices:** menu enter the desired bit pattern. Select **Done** from the **Choices:** menu when the desired bit pattern has been entered.

When a message field is being modified the original contents of the field (that is - the contents of the field before modification was started) is sent whenever the message is used in a messaging protocol. The new contents are not used until **Done** is selected from the **Choices:** menu. Use the CANCEL key to abort a modification. If the CANCEL key is selected the original field contents are restored.

NOTE:

If a message field is modified while the **Data Spec** field is set to **Std** the modified contents will be overwritten with the bit patterns generated using the signaling formats defined in the applicable industry standard immediately after **Done** is selected from the **Choices:** menu.

Typical Example

The following example illustrates the use of the CALL BIT screen. In this example an AMPS mobile station is brought up on a voice channel and then handed off to a new voice channel assignment. The contents of the **FVC V Msg** message, which was set when the first handoff occurred, is then modified from the CALL BIT screen. The mobile station is then handed off again by sending the modified message to the mobile station from the CALL BIT screen.

1. Ensure that the Test Set is in the connected state. See "[Page a Mobile Station](#)" on [page 271](#) for information on how to bring a mobile station up on a voice channel.
2. If the CALL CONTROL screen is not displayed, select **CALL CNTL** under the **To Screen** menu. The CALL CONTROL screen will be displayed.
3. Position the cursor on the **Display** field and select **Data**.
4. Select the **Chan:** field and enter a new, valid voice channel number.
5. Select the **Pwr Lvl:** field enter a new, valid mobile station power level.
6. Select the **SAT:** field and enter a new, valid SAT frequency.
7. Select the **Handoff** field. The **Access** annunciator will light while the Test Set signals the mobile station with the handoff information. If the mobile responds properly, it will stop transmitting on the current voice channel, switch to the new voice channel assignment, and transpond the new SAT frequency assignment. When the Test Set detects that this has happened the **Connect** annunciator is lit indicating that the handoff was successful. The left-hand fields in the **Voice Channel Assignment** section will be updated with the new voice channel assignment information.
8. Select **CALL BIT** from the **To Screen** menu. The CALL BIT screen will be displayed.
9. Position the cursor on the **Data Spec** field and select **Bits**.
10. Select the **Set Message** field and select **FVC V Msg**.
11. Select the **VMAC** field in the **FVC V Msg** and set it to 101 (this corresponds to a mobile station power level of 5 - reference *EIA/TIA-553 Mobile Station - Land Station Compatibility Specification*, September 1989, page 2-2, Table 2.1.2-1).
12. Select the **Handoff** field. The **Access** annunciator will light while the Test Set signals the mobile station with the handoff information. If the mobile responds properly, it will stop transmitting on the current voice channel, and start transmitting on the same channel with a power level of 5 (note that the channel assignment and SAT assignment were not modified in this example, the mobile station simply switched to the same channel with the same SAT assignment). When the Test Set detects that this has happened, the **Connect** annunciator is lit indicating that the handoff was successful. The mobile station power level after the handoff should be power level 5.
13. Position the cursor on the **Data Spec** field and select **Std**.

Using the ANALOG MEAS Screen

The ANALOG MEAS screen combines some of the Test Set's **Audio Analyzer** fields and some of the Test Set's RF Generator fields onto one screen for the purpose of testing the audio characteristics of the mobile station. Only those fields which are pertinent to testing the mobile stations audio characteristics have been combined onto the ANALOG MEAS screen. The Test Set must be in the connected state (that is, the **Connect** annunciator is lit) in order to use the ANALOG MEAS screen.

The mobile station's speaker output must be connected to the Test Set's AUDIO IN connector and the mobile station's microphone input must be connected to the Test Set's AUDIO OUT connector in order to use the ANALOG MEAS screen. Refer to **Figure 2, "Connecting a Mobile Station to the Test Set," on page 253** for connection information. If the mobile station does not have audio connections the ANALOG MEAS screen cannot be used.

There are a wide variety of audio measurements which can be made from the ANALOG MEAS screen. The following examples illustrate how to make a typical mobile station receiver measurement (RF Sensitivity) and a typical mobile station transmitter measurement (FM Hum and Noise).

To Make an RF Sensitivity Measurement

1. If not already done, condition the Test Set. See "[Conditioning the Test Set for Call Processing](#)" on page 262 for further information.
2. If not already done, configure the Test Set. See "[Configure the Test Set](#)" on page 268 for further information.
3. Connect the mobile station to the Test Set as shown in [Figure 2, "Connecting a Mobile Station to the Test Set,"](#) on page 253.

NOTE:

The mobile station's speaker output must be connected to the Test Set's AUDIO IN and the mobile station's microphone input must be connected to the Test Set's AUDIO OUT in order to use the ANALOG MEAS screen.

4. Turn on the mobile station.
5. Ensure that the Test Set is in the connected state. See "[Page a Mobile Station](#)" on page 271 for information on how to bring a mobile station up on a voice channel.
6. If the ANALOG MEAS screen is not displayed, select the **ANLG MEAS** field from the **To Screen** menu. The ANALOG MEAS screen will be displayed.
7. The following example illustrates how to make a 12 dB SINAD Receiver Sensitivity measurement:
 - a. Select the **AFGen1 Freq** field and set it to 1 kHz.
 - b. Select the upper **AFGen1 To** field and set it to **FM**.
 - c. Select the lower **AFGen1 To** field and set it to 8 kHz.
 - d. Select the **AF Anl In** field and select **Audio In**.
 - e. Select the **Filter 1** field and select **C MESSAGE**.
 - f. Select the **Filter 2** field and select **>99kHz LP**.
 - g. Position the cursor on the **De-Emphasis** field and select **Off**.
 - h. Select the **Detector** field and select **RMS**.
 - i. Select the **AF Freq** measurement field and select **SINAD**.
 - j. Select the **Amplitude** field and begin to lower the transmitted base station voice channel power until 12 dB SINAD is reached.

NOTE:

The mobile station might mute or drop off the air before a 12 dB SINAD is reached. The performance of the mobile station at low RF levels is dependent upon the characteristics of the mobile station (that is, what type of system it is designed for). Unlike a real base station, the Test Set does not perform any protocol functions on the voice channel.

To Make an FM Hum and Noise Measurement

1. If not already done, condition the Test Set. See "[Conditioning the Test Set for Call Processing](#)" on page 267 for further information.
2. If not already done, configure the Test Set. See "[Configure the Test Set](#)" on page 268 for further information.
3. Connect the mobile station to the Test Set as shown in [Figure 2, "Connecting a Mobile Station to the Test Set,"](#) on page 253.

NOTE:

The mobile station's speaker output must be connected to the Test Set's AUDIO IN and the mobile station's microphone input must be connected to the Test Set's AUDIO OUT in order to use the ANALOG MEAS screen.

4. Turn on the mobile station.
5. Ensure that the Test Set is in the connected state. See "[Page a Mobile Station](#)" on page 271 for information on how to bring a mobile station up on a voice channel.
6. If the ANALOG MEAS screen is not displayed, select the **ANLG MEAS** field from the **To Screen** menu. The ANALOG MEAS screen will be displayed.

NOTE:

It is recommended that the mobile station's microphone be muted, if possible, when making measurements on the mobile stations RF carrier. If the microphone is not muted it is possible for extraneous noise to be picked up by the microphone and adversely affect the measurements.

7. The following example illustrates how to make a FM Hum and Noise measurement:
 - a. Select the **Amplitude** field and set it to -47 dBm.
 - b. Select the **AFGen1 Freq** field and set it to 1 kHz.
 - c. Select the upper **AFGen1 To** field and set it to **Audio Out**.
 - d. Select the **AF An1 In** field and select **FM Demod**.
 - e. Select the **Filter 1** field and select **C MESSAGE**.
 - f. Select the **Filter 2** field and select **>99kHz LP**.
 - g. Position the cursor on the **De-Emphasis** field and select **750 us**.
 - h. Select the **Detector** field and select **PK+**.
 - i. Select the measurement field and select **AF Freq**.
 - j. Select the lower **AFGen1 To** field and adjust the signal level until the **FM Deviation** field on the upper portion of the CRT reads 8 kHz.
 - k. Select the **Detector** field and select **RMS**.
 - l. Select the **FM Deviation** field.
 - m. Press the blue SHIFT key, the INCR $\div 10$ key, then the ENTER key. This sets a zero reference point.
 - n. Select the lower **AFGen1 To** field and press the ON/OFF key. This turns off the modulating signal to the mobile station transmitter.
 - o. The FM Hum and Noise figure is displayed in the **FM Deviation** field.

10

Protocol Logging

The CDMA protocol logging feature allows the capture of over-the-air forward and reverse IS-95A messages on the traffic channel or paging/access channel.

This logging feature is intended to be used as a low-level tool to aid the advanced user in debugging new phone designs or qualifying the operation of new mobile stations.

CAUTION:

Operation and setting changes made using the information contained in this module can negatively affect system operation. Hewlett-Packard makes no claim or warranty of proper operation or fitness of use when the user has altered the operation of the unit using these techniques.

Hardware and Software Requirements

Using the protocol logging functions of the Test Set requires a number of specific hardware and software items not supplied directly by Hewlett-Packard. It is the user's responsibility to acquire those items not provided by Hewlett-Packard.

CAUTION:

Attempting to use hardware and software items other than those specified in this module may result in unsatisfactory performance. Hewlett-Packard does not make any claims of suitability as to the form and/or function of such substitutions.

Hardware Requirements

Three pieces of hardware, besides the Test Set and mobile station, are required to use the protocol logging functions of the Test Set.

- An industry standard PC compatible computer¹
- A null-modem cable, no more than six feet in length.

The null-modem cable is not provided by Hewlett-Packard, but is a readily available standard serial cable. The end of the null-modem cable that mates to the Test Set (break-out adapter) will be a nine-pin male sub-miniature "D". The end that connects to the computer will be a nine-pin female male sub-miniature "D" or a 25-pin sub-miniature "D", depending on the computer. The User Manual for PROCOMM PLUS² (see ["Software Requirements" on page 308](#)) shows diagrams for making a null-modem cable from an RS-232 cable.

1. The computer should be equipped with a buffered 16550 UART (Universal Asynchronous Receiver/Transmitter). This will allow serial communication even if the processor is busy and cannot immediately handle the serial port interrupt requests. A 486 33MHz class microprocessor is adequate, but a 586 100 MHz class processor will reduce the likelihood of missed characters sent from the Test Set.
2. PROCOMM PLUS is a product of Datastorm Technologies, Inc.

Software Requirements

The computer must have a communications software package installed that is capable of the following:

- Handling a null modem serial connection
- Supporting a baud rate of 115 kbps
- Emulating a VT 100 terminal.

The following communications packages have been tested and verified to work for protocol logging:

- PROCOMM PLUS version 2.01 for MS-DOS from Datastorm Technologies, Inc. running with MS-DOS version 2.0 or later (Hewlett-Packard recommends MS-DOS version 6.22).
- HyperTerminal (comes with Windows 95). Hewlett-Packard recommends a 486 66 MHz class microprocessor and 16 MBytes of RAM for Windows 95.

Connecting the Test Set to the Computer

CAUTION:

Be sure that a null-modem cable connected to the Test Set is never left unterminated. It must remain connected to the computer's serial port. Because data on the protocol logging connectors is transferred at a very high speed, an unterminated or poor quality null-modem cable could generate internal cross talk, causing the Test Set to behave erratically and possibly crash. See "[Connection Diagram](#)" on page 310.

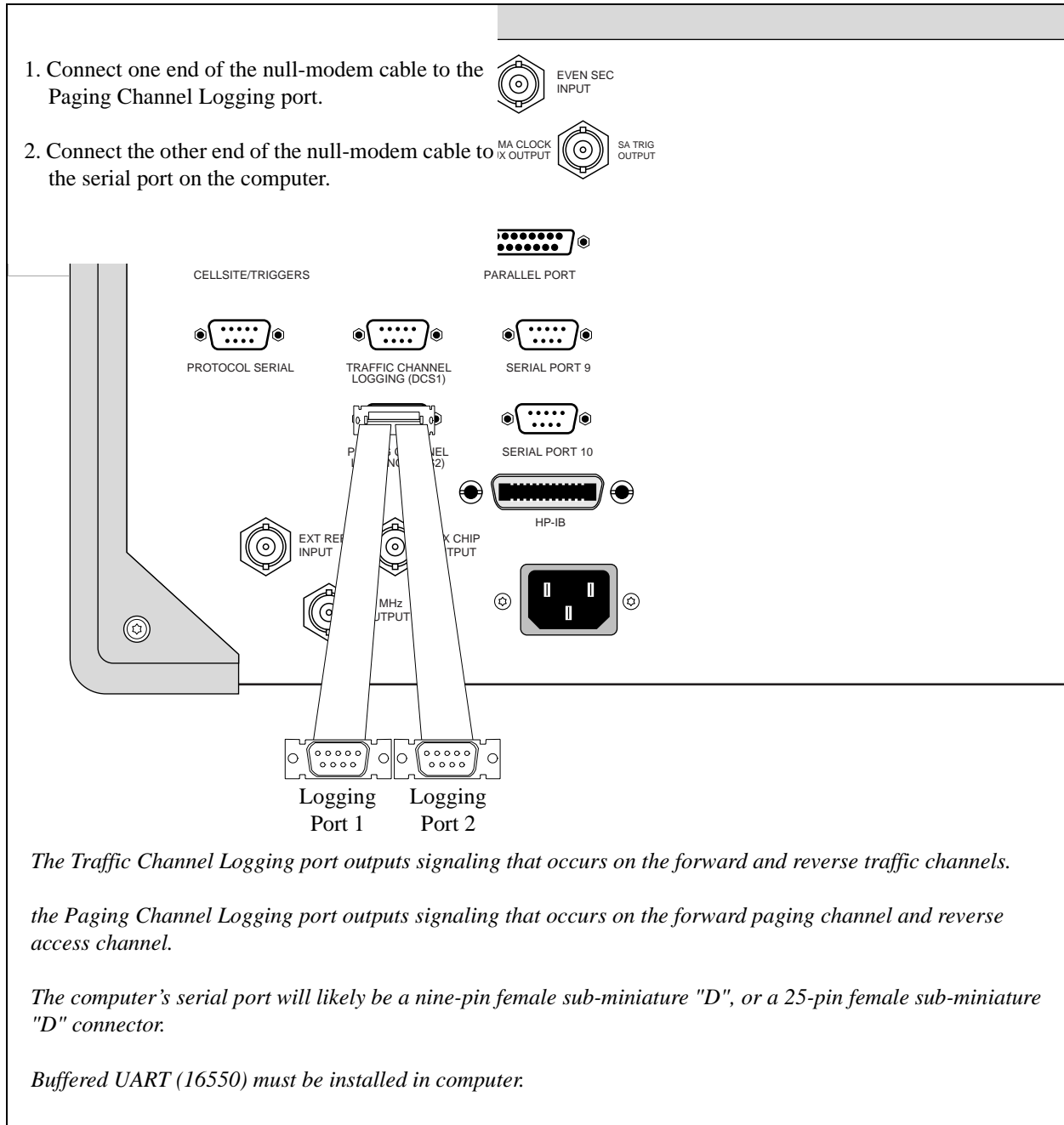

Figure 4 Connection Diagram

Setting Up the Communications Package

This section will provide the general settings for configuring a communications package for protocol logging with the Test Set. If you are using PROCOMM PLUS, detailed setup information for installing or reconfiguring PROCOMM PLUS is provided.

General Setup Parameters

- *Baud Rate.....115,200*
- *Parity.....None*
- *Data Bits.....8*
- *Stop Bits.....1*
- *Terminal Emulation...VT100*

Installing PROCOMM PLUS

The following list includes the setup information that PROCOMM PLUS version 2.01 for MS-DOS from Datastorm Technologies, Inc. will prompt you for during installation.

PROCOMM PLUS Prompt Settings

- Prompt: How will you use PROCOMM PLUS?
Choose: With a Direct Connection Only
- Prompt: COM Ports
Choose: Available serial port
- Prompt: Baud Rates
Choose: 115200
- Prompt: Communication Settings
Choose: No Parity, 8 data bits (Required for Test Set)
- Prompt: TERMINAL FAMILY
Choose: VT/ANSI (Required for Test Set)
- Prompt: DEFAULT TERMINAL EMULATION
VT100 (Required for Test Set)
- DEFAULT DOWNLOAD PROTOCOL
XMODEM (Required for Test Set)

Reconfiguring PROCOMM PLUS

If you already have PROCOMM PLUS installed on your computer, use the settings listed in the following steps to insure proper setup.

1. Start PROCOMM PLUS

- At the DOS prompt change directories to where you installed PROCOMM PLUS.
- Type pplus, and press ENTER.
- Press any key to enter PROCOMM PLUS terminal mode.

2. Set Up "TERMINAL OPTIONS".

- While holding down the ALT key, press the S key.
This displays the PROCOMM PLUS SETUP UTILITY...MAIN MENU.
- Select "TERMINAL OPTIONS" from the list of choices.
This displays the PROCOMM PLUS SETUP UTILITY...TERMINAL OPTIONS.
- Follow the on screen directions for changing the settings.
A-Terminal emulation..... VT100
B- Duplex..... FULL
- Esc: Exit back to PROCOMM PLUS SETUP UTILITY...MAIN MENU.

3. Set Up "HOST MODE OPTIONS".

- Select "HOST MODE OPTIONS" from the list of choices.
- Follow the on screen directions for changing the setting for D- Connection Type to "DIRECT".
- Esc: Exit back to PROCOMM PLUS SETUP UTILITY...MAIN MENU.

4. Save the current settings to the PROCOMM PLUS Software.

- Select "SAVE SETUP OPTIONS" from the list of choices.
- Esc: Exit back to PROCOMM PLUS SETUP UTILITY...MAIN MENU.

5. Configure the computer's serial port.

- While holding down the ALT key, press the P key.

This displays the LINE/PORT SETUP screen.

- Type, next to the prompt "YOUR CHOICE", the characters that correspond to the following parameters:

BAUD RATE= 115200

PARITY = None

DATA BITS = 8

STOP BITS = 1

PORT = Available serial port

- Save the current settings to the PROCOMM PLUS Software (ALT S keys).

6. Verify serial communication with the Test Set.

- Apply power to the Test Set.

As the Test Set is going through its power-up cycle, messages should appear.

- Press the Enter key on your computer.
- If setup is correct, a prompt will be echoed back from the Test Set to the computer's screen.

DCS1> If serial port COM1 1 is selected

DCS2> If serial port COM2 is selected

Logging Protocol Messages

With PROCOMM PLUS configured correctly, the Test Set will display protocol messages on the computer display through the serial null-modem cable, which may be connected to Paging Channel Logging port or the Traffic Channel Logging port.

The Traffic Channel Logging port will provide all over-the-air messages sent by the Test Set on the Sync Channel and traffic channel messages sent and received by the Test Set on the forward and reverse traffic channels.

The Paging Channel Logging port will provide all over-the-air messages sent on the paging channel and received by the Test Set on the access channel. By system default, certain paging channel messages that are continuously repeated (those which are not intended for a specific mobile station) are not displayed. These include the System Parameters Message, Access Channel Parameters Message, Channel List Message, Extended System Parameters Message, and the Extended Neighbor List Message. The "o" command, (see "[Paging Channel Logging Port Commands](#)" on page 319) allows you to turn on or turn off these messages.

Along with protocol messages, PROCOMM PLUS (in its default mode) will also display:

- Internal control messages from the Test Set
- Frame-rate indicators for forward and reverse traffic channels

The following [example log](#) shows typical data that might be logged from the Traffic Channel Logging port.

Table 6 Forward Channel Frame Rate Characters

	Frame Rate Indicators for Forward Channel (to mobile station)			
8 kbps*	'1' = full	'2' = half	'3' = quarter	'4' = eighth
13 kbps	'5' = full	'6' = half	'7' = quarter	'8' = eighth
* '0' = Corrupt frame				

Table 7 Reverse Channel Frame Rate Characters

	Frame Rate Indicators for Reverse Channel (to mobile station)			
8 kbps *	'F' = full 'f' = full rate likely	'-' = half	'_' = quarter	'.' = eighth
13 kbps	'S' = full 's' = full rate likely	' ' = half	'^' = quarter	':' = eighth
* ' ' = corrupt frame				

Capturing a Log to a File on the Computer

PROCOMM PLUS provides a capture mode that, when activated, stores all data to a file of your choice for further evaluation.

1. To begin logging, hold down the Alt key on the computer, press F1.
You will be prompted to provide a filename.
2. Type in a filename for the captured log.
3. When you have completed logging, hold down the ALT key and press F1.
The status bar at the bottom of the computer's display will indicate that the log has been closed.
4. You can evaluate the contents of your file now with any text editor.

Control Commands for Protocol Logging

Control commands allow modification to the protocol logging feature through the computer running the communications package (see ["Software Requirements" on page 308](#)). All commands are sent by typing a single character on the computer keyboard.

The menu of commands is displayed by typing a "?" (SHIFT, \).

Traffic Channel Logging port Commands

NOTE:

A list of these commands can be displayed by pressing "?" on the computer keyboard.

"a" Pressing the "a" key on the computer keyboard causes the Test Set to display the active parameters for the access channel.

"b" For internal Hewlett-Packard use only.

"c" Pressing the "c" key on the computer keyboard causes the Test Set to display its current CDMA channel parameters, such as Walsh code assignments and PN offsets. This information is settable on the CDMA GENERATOR CONTROL screen.

"d" Pressing the "d" key on the computer keyboard causes the computer to display compressed forward and reverse traffic channel data in hexadecimal format. Data is preceded by a code that indicates the frame data rate, and whether it was received (Rx) or transmitted (Tx). Refer to ["Forward Channel Frame Rate Characters" on page 316](#) and ["Reverse Channel Frame Rate Characters" on page 316](#) for the meaning of each code.

CAUTION:

During a call, traffic data is continually sent and received by the Test Set. Pressing the "d" key will cause the computer to log a tremendous amount of data. Pressing the "d" key again stops the display of data.

"e" For internal Hewlett-Packard use only.

"f" For internal Hewlett-Packard use only.

"i" For internal Hewlett-Packard use only.

"l" It is not recommended that you use this command. This command toggles power control mode. A field on the CDMA TRANSMITTER POWER RANGE TEST screen, Closed Loop Pwr Cntl, should be used to perform this function.

"m" For internal Hewlett-Packard use only.

"o" Pressing the "o" key will toggle a command mode that logs all sync channel overhead messages. Sync channel messages are continually sent by the Test Set, so be prepared for a large amount of data. Press "o" again to disable.

"p" Pressing the "p" key will toggle a command mode that logs a "D" for each down power control bit, and a "U" for each up power control bit. A power control bit is transmitted every 1.25 mS, so be prepared for a large amount of data. Press "p" again to disable.

"q" For internal Hewlett-Packard use only.

"r" For internal Hewlett-Packard use only.

"s" Pressing the "s" key will display the current parameters being used on the Sync Channel.

"t" Pressing the "t" key will display the current parameters being used on the Traffic Channel.

"u" For internal Hewlett-Packard use only.

"v" For internal Hewlett-Packard use only.

"w" For internal Hewlett-Packard use only.

"y" Pressing the "y" key will display the current parameters used on the system overhead messages.

"+" For internal Hewlett-Packard use only.

"-" For internal Hewlett-Packard use only.

", " Pressing the ", " key will toggle a command mode that displays the Frame Rate Characters (see **"Forward Channel Frame Rate Characters" on page 316** and **"Reverse Channel Frame Rate Characters" on page 316**). Toggling frame rate indicators off greatly reduces the amount of data logged.

". " Pressing the ". " key will toggle a command mode that displays a subset of the the Test Set's internal control messages, called Status Request Messages. Turning Status Request Messages off makes it easier to analyze protocol-related data.

Paging Channel Logging Port Commands

NOTE:

A list of these commands can be displayed by pressing "?" on the computer keyboard.

"a" Pressing the "a" key on the computer keyboard causes the Test Set to display the active parameters for the access channel.

"b" For internal Hewlett-Packard use only.

"c" Pressing the "c" key on the computer keyboard causes the Test Set to display its current CDMA channel parameters, such as Walsh code assignments and PN offsets. This information is settable on the CDMA GENERATOR CONTROL screen.

"f" For internal Hewlett-Packard use only.

"i" For internal Hewlett-Packard use only.

"m" Pressing the "m" key on the computer keyboard causes the Test Set to display the monitored parameters on the Access Channel. If the Test Set has detected access probes, this command will show if the information was good or bad via the message CRC counters.

"o" Pressing the "o" key will toggle a command mode that logs all sync channel overhead messages. Sync channel messages are continually sent by the Test Set, so be prepared for a large amount of data. Press "o" again to disable.

"p" Pressing the "p" key will display the current parameters being used on the Paging Channel.

"q" For internal Hewlett-Packard use only.

"s" Pressing the "s" key will display the current parameters being used on the System Overhead Message.

"t" Pressing the "t" key will display System Time.

"u" For internal Hewlett-Packard use only.

"v" For internal Hewlett-Packard use only.

"w" For internal Hewlett-Packard use only.

" ." Pressing the "." key will toggle a command mode that displays a subset of the the Test Set's internal control messages, called Status Request Messages. Turning Status Request Messages off makes it easier to analyze protocol-related data.

Increasing Measurement Throughput

This information contains a number of techniques for increasing measurement throughput. These techniques include:

- "Paging un-registered mobile stations" on page 322**
- "Performing Transmitter and Receiver testing concurrently" on page 331**
- "Minimizing bus configuration time" on page 334**
- "Reducing delays caused by screen changes" on page 337**
- "Reducing delays caused by unused measurements" on page 336**
- "Reducing measurement setup time" on page 338**

Paging un-registered mobile stations

The Test Set provides fields for entering paging information the Test Set requires to page a mobile station that has not yet registered. This feature allows a mobile station-terminated call to be made as soon as the mobile station has locked onto the Test Set's pilot signal.

If the mobile station under test is identified by an IMSI (International Mobile Station Identification) number, the IMSI structure must include the subfields MSIN, MNC, and MCC. This type of mobile station is referred to as IMSI Class 0 type 3 (binary 11).

1. Perform initial setup.

- "Preset the Test Set." on page 49
- "Correct for RF Path Loss." on page 50
- "Enter the MSUT's Protocol and RF Channel Standard." on page 51
- "Enter the MSUT's primary CDMA channel." on page 52
- "Adjust Sector A Power. (Optional)" on page 53
- "Save initial settings (Optional)" on page 54

2. Turn off power-up registration and timer-based registration.

Manual Operation:

1. Press then release the SHIFT key then press the Call control key to access the CDMA CELL SITE CONFIGURATION screen.
2. Position the cursor at the Pwr Up Reg field.
3. Press the knob to select Off.

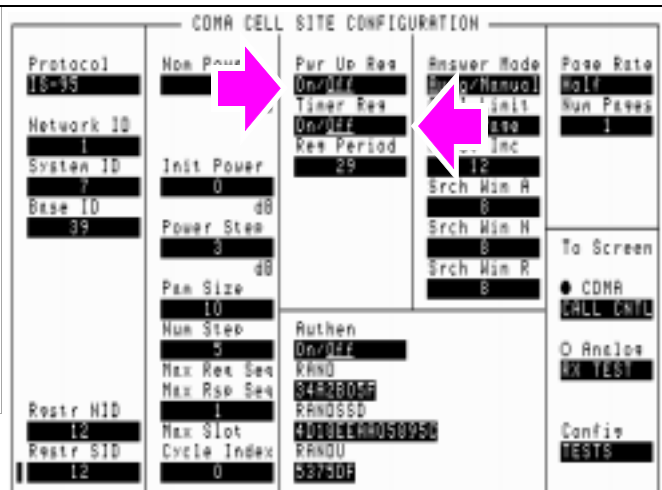

Turning off power-up and timer-based registrations eliminates the possibility that the mobile station will begin the process of registering autonomously before the Test Set sends the paging message.

3. Connect the mobile-station-under-test (MSUT).

See "Connect the mobile-station-under-test (MSUT)." on page 325

4. Select the desired Service Option.

See "Select the desired Service Option." on page 325

5. Enter the mobile station's identification numbers.

The identifying numbers required by the Test Set to page a mobile station may include phone number and MIN (Mobile Identification Number), or a group of three IMSI (International Mobile Subscriber Identification) subfields.

The method used to identify mobile station depends on the signaling protocol used by the wireless system they are designed to operate on.

Manual Operation:

1. Position the cursor at the MS ID field.
2. Press the knob to select the field.
3. Select a choice other than Auto.

If IMSI is selected, position the cursor at the field below IMSI and press the knob to enter values in the IMSI subfields MCC, MNC, and MSIN. *All three of these fields must be correctly filled in.*

4. Enter the identifying numbers. All subfields (not just the one displayed) must contain the mobile station's correct identification.

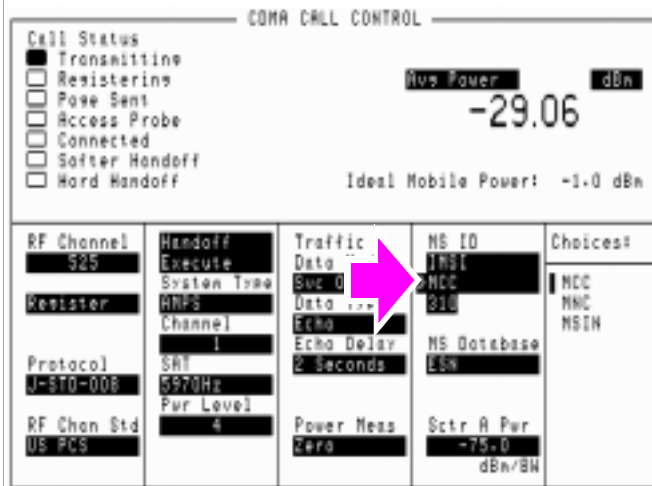

The choices of mobile station identification numbers depends on your selection in the Protocol field. For example, if IS-95 was selected you will have fields to enter the phone number and MIN (mobile identification number). However, if IS-95A (or other) protocols are selected, you will enter the IMSI subfields MCC (mobile country code), MNC (mobile network code), and MSIN (mobile station identification number).

NOTE:

If you do not know the mobile station under test's identification, the Test Set can be used to display it. Perform a registration (see "[Register the MSUT \(Optional\)](#)," on page 50). After the mobile station has registered the identification can be read from the MS Database field. Subsequent testing on mobile stations with the same identifying numbers can then be performed without registration. If you performed a registration to find out what the mobile station's identification is, but no numbers are displayed in the MS Database field when you select MCC or MNC, this means the mobile country code and mobile network codes of the mobile station and Test Set match. Access the CDMA Cell Site Configuration screen and record the numbers from the Cntry Code and Netwrk Code fields. Return to the CDMA CALL CONTROL screen and enter the Cntry Code value in the IMSI MCC subfield, and enter the Netwrk Code value in the IMSI MNC subfield

HP-IB Syntax:

```
"DISP CCNT;CDMA:MOBILE:MSID 'IMSI';MSID:IMSI 'MSIN';MCC '310';MNC '0';MSIN '0'"
!displays the CDMA CALL CONTROL screen and enters values into the MCC, MNC, and MSIN IMSI
!subfields. The Protocol field must have a protocol selected that provides IMSI in the
!MS ID field.
```

6. Turn on power to the MSUT and wait for the MSUT to find digital service.

See "Turn on power to the MSUT and wait for the MSUT to find digital service." on page 328

7. Page the mobile station.

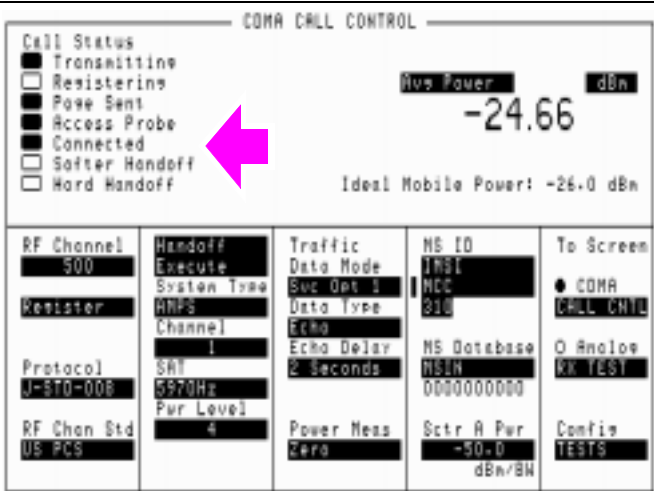
<p>Manual Operation:</p> <ol style="list-style-type: none"> 1. Press the Test Set's Call/Page key. 2. If service option 1 or 32768 is selected, press the SEND key on the MSUT's keypad to connect the call (unless this is done remotely). 3. Verify that the Connected annunciator is lit. 	
<p><i>After the CALL key is pressed on the Test Set, the Page Sent annunciator will light to indicate that a paging message was sent to the MSUT. The Access Probe annunciator will then light to indicate that the mobile station transmitted an access probe sequence in an attempt to gain system access. The MSUT should ring if the Traffic Data Mode is set to service option 1 or 32768.</i></p>	

HP-IB Syntax:

"CDMA:CALL:MAKE" !pages the mobile station (performs the same function as Call/Page key)

HP-IB Help:

The following CDMA Status Register Group bits monitor the call processing states:

- Page Sent (BCD 2)
- Access Probe (BCD 1)
- Alerting (BCD 16)
- Connected (BCD 8)

Condition registers are implemented for these bits, allowing HP-IB operation to mirror the way they work on the display.

HP-IB Example: The following HP BASIC example uses service requests to detect when the following call-processing events occur:

- Page Sent
- Alerting (not included as a front-panel display annunciator)
- Connected

```

10   Status_byte = SPOLL(714)   !clears the Status Byte Register
20   OUTPUT 714;"*CLS" !clears all event registers
30   CALL Cdma_register_enable 31   !calls subprogram to enable selected bits in
31   !the CDMA Status Register Group
40   CALL Operation_register_enable !calls subprogram to enable selected bit in
41   !the Operation Status Register Group.
50   ALL Status_register_enable !calls subprogram to enable bit in
51   !the Status Byte Register.
60   ON INTR 7,15 CALL Interrupt !specifies a program branch to Interrupt
61   !subprogram when an interrupt occurs.
70   ENABLE INTR 7;3 !enables the SRQ interrupt (Decimal 2 enables bit 1 of the
!HP-IB interrupt enable register "SRQ Received").
80   PRINT "WHEN MOBILE STATION IS REGISTERED, PRESS CONTINUE"
90   PAUSE
100  OUTPUT 714;"DISP CCNT;CDMA:CALL:MAKE"
110  LOOP
120  DISP "WAITING FOR A SERVICE REQUEST INTERRUPT"
130  END LOOP
140  END !End of program
150  SUB Cdma_register_enable
160  OUTPUT 714;"STATUS:CDMA:PTR 26;NTR 0"
161  !enables the CDMA Status Register Group positive
162  !transition register for the following bits:
163  !Page Sent (1), Alerting (4), and Connected (3)
170  OUTPUT 714;"STATUS:CDMA:ENAB 26"
171  !enables the CDMA Status Register Group event
171  !register to send a summary message
172  !bit for the selected events.
180  SUBEND
190  SUB Operation_register_enable
200  OUTPUT 714;"STAT:OPER:PTR 256;NTR 0;ENAB 256"
201  !enables the Operation Status Register Group positive transition register for
!the CDMA Status Register Group summary message bit (8), and enables the event
register to send a summary message bit for the selected events.
210  SUBEND
220  SUB Status_register_enable
240  OUTPUT 714;"*SRE 128"!enables bit 7 of the Status Register, the summary
241  !message bit from the Operation Status Register Group.
260  SUBEND
280  SUB Interrupt
300  Status_byte=SPOLL(714)
310  OUTPUT 714;"STAT:CDMA:EVEN?"
311  !queries the CDMA Status Register Group event register
320  ENTER 714;Event_reg
330  SELECT
340  CASE=2
360  PRINT "PAGE SENT"
380  CASE=16
400  PRINT "ALERTING...ANSWER PHONE"
410  CASE=8

```

Chapter 11, Increasing Measurement Throughput

Paging un-registered mobile stations

```
420 PRINT "CALL IS CONNECTED"
440 STOP
460 END SELECT
480 OUTPUT 714;STAT:OPER:EVEN?
481 !query the Operation Status Register Group event register to clear bit 8,
482 !the CDMA Status Register Group summary message bit.
500 ENTER 714;Oper_event !terminates query
510 ENABLE INTR 7 !re-enables the SRQ interrupt
520 SUBEND
```

See "CDMA Status Register Group" in the Status Reporting chapter of the *HP E8285A User's Guide*.

Performing Transmitter and Receiver testing concurrently

During an FER test, the Test Set is capable of executing HP-IB commands and returning measurement results from other measurement functions, such as Rho.

Programming Example

The following example assumes a Service Option 2 call is Connected. The program begins an FER measurement and allows an operator to query rho while the FER frame count continues.

```

10  ! re-save "i:\dept\cdma\ex_progs\simultan"
20  ! REV A.01.00
30  !
40  ! This program demonstrates simultaneous FER (receiver sensitivity)
50  ! and rho (transmitter modulation quality) testing. After an FER
60  ! test is started, a softkey interrupt branches program execution
70  ! to a subprogram that queries rho and prints a test result without
80  ! interrupting the FER test.
90  !
100 Loss=-3
110 CLEAR SCREEN
120 ! Set up a timeout to regain control of the bus in the event an error
130 ! such as "Query unterminated" occurs.
140 ON TIMEOUT 7,5 GOTO End_of_prog
150 Initialize_ts(Loss) !Preset the Test Set
160 Page_phone !Attempt a call (the mobile must be registered)
170 ! Set triggering mode to continuous. THIS IS REQUIRED FOR
180 ! SIMULTANEOUS MEASUREMENTS.
190 OUTPUT 714;"TRIG:MODE:RETR REPETITIVE"
200 Start_fer !Start an FER test
210 ! Set up a softkey to query rho measurement
220 USER 1 KEYS !Selects User 1 softkey definitions on ITF keyboard, normal mode
230 ON KEY 1 LABEL "rho",15 CALL Measure_tx_qual
240 PRINT ""
250 PRINT "Press softkey F1 to make a rho measurement"
260 PRINT ""
    
```

Chapter 11, Increasing Measurement Throughput

Performing Transmitter and Receiver testing concurrently

```
270 LOOP
280     DISABLE !Disables interrupt while output/enter
290     OUTPUT 714;"meas:cdm:fer:fram?:err?"
300     ENTER 714;Frames_counted,Errors_counted
310     ENABLE !Enables keyboard interrupt allowing branch to rho meas
320     DISP "Frames Counted = ";Frames_counted;"Errors Counted = ";Errors_counted
330 END LOOP
340 OUTPUT 714;"CDMA:CALL:END"
350 OUTPUT 714;"TRIG:MODE:RETR SINGLE"
360 Clear_bus:    ! Clears the bus in case of query unterminated or query interrupted
370 CLEAR 714
380 ERROR RETURN
390 DISP "PROGRAM DONE"
400 End_of_prog:  !Branch here if timeout occurs
410 END
420 !
430 Page_phone: SUB Page_phone
440     OUTPUT 714;"CDMA:CELL:ASEC:BWP -50 dBm;STAT ON"
450     OUTPUT 714;"CDMA:RFCH 384" !
460     PRINT "WHEN THE MOBILE FINDS SERVICE AND HAS REGISTERED, PRESS THE CONTINUE
             SOFTKEY (F2)"
470     DISP "Waiting..."
480     PAUSE
490     OUTPUT 714;"CDMA:CALL:TRAF:DATA:MODE 'SVC OPT 2'"
530     OUTPUT 714;"CDMA:CALL:MAKE"
540     DISP "Mobile is being paged..."
550     ! The following loop will continue until the CDMA Event register
560     ! indicates that the phone has 'Connected'
590     REPEAT
600         WAIT .1 !100 mS wait to allow Test Set to handle other tasks
610         OUTPUT 714;"STAT:CDMA:EVENT?"
620         ENTER 714;Event_reg
690         UNTIL BIT(Event_reg,3)! Monitoring "Connected" annunciator bit
700         CLEAR SCREEN
710         PRINT "Page successful, mobile is connected"
720     SUBEND
73         0             Initialize_ts: SUB Initialize_ts(Loss)
```

```
740 CLEAR 714
750 CLEAR SCREEN
760 DISP "Initializing..."
770 OUTPUT 714;"*RST"! Reset
780 WAIT 5
790 OUTPUT 714;"CONF:OFL:MODE 'ON';RFIN ";Loss! External Path Loss
800 SUBEND
810 Measure_tx_qual: SUB Measure_tx_qual
820 ! This routine measures transmitter rho while FER is running
830 PRINT ""
840 PRINT "Measuring rho..."
850 OUTPUT 714;"MEAS:CDM:RHO?"
860 ENTER 714;Rho

870 PRINT "Rho is ";Rho
880 ! At this point, program execution will return to the loop
890 ! in the main program that displays FER results.
900 SUBEND-
910 Start_fer: SUB Start_fer ! Frame Error Rate Test
920 ! This sets up the parameters and arms the FER test.
950 OUTPUT 714;"DISP CRXTEST"
960 OUTPUT 714;"MEAS:CDM:FER:STAT ON"
980 OUTPUT 714;"DISPLAY:FER:INTERIM:RESULTS 'Yes'"
990 SUBEND
```

Minimizing bus configuration time

Every time a BASIC or IBASIC OUTPUT or ENTER statement is executed, the bus (HP-IB) has to be configured for data transfer. Using compound HP-IB statements minimizes bus configuration time by combining several operations into one HP-IB OUTPUT or ENTER statement.

To combine multiple HP-IB commands into one OUTPUT statement, use the ; (semicolon) separator and/or the ;; (semicolon colon) separator.

Example 1. Using the semicolon in compound OUTPUT statements

The following example sets the Traffic Data Mode to Service Option 2 and the Data Rate to Full. The semicolon separator causes the HP-IB command parser to back up one level in the command hierarchy.

The following example...

- 10 OUTPUT 714;"CDMA:CALL:TRAFFIC:DATA:MODE 'Svc Opt 2'", and
- 20 OUTPUT 714;"CDMA:CALL:TRAFFIC:DATA:RATE 'Full'"

...could be replaced with:

```
OUTPUT 714;"CDMA:CALL:TRAFFIC:DATA:MODE 'Svc Opt 2';RATE 'Full'"
```

Example 2. Using the semicolon-colon in compound OUTPUT statements

The following example sets the Sctr A Pwr level to -70 dBm, then attempts to make a call. The semicolon-colon separator causes the HP-IB command parser to back up to the top level in the command hierarchy.

```
OUTPUT 714;"CDMA:CELL:ASECTOR:BWPOWER -70 DBM;;CDMA:CALL:MAKE"
```

The following example...

- 10 OUTPUT 714;"CDMA:CELL:ASECTOR:BWPOWER -70 DBM", and
- 20 OUTPUT 714;"CDMA:CALL:MAKE"

...could be replaced with:

```
OUTPUT 714;"CDMA:CELL:ASECTOR:BWPOWER -70  
DBM;;CDMA:CALL:MAKE"
```

Example 3. Reading multiple values using one ENTER statement

The following four lines of code query the Test Set for an Average Power measurement and the Average Power HP-IB units, then read both of these values into the two variables Average_power and Units\$.

The following example...

- 10 OUTPUT 714;"MEAS:CDMANALYZER:AVGPOWER?",
- 20 ENTER 714;Average_power
- 30 OUTPUT 714;"MEAS:CDMANALYZER:AVGPOWER:UNITS?",
- 40 ENTER 714;Units\$

...could be replaced by:

```
10 OUTPUT 714;"MEAS:CDMANALYZER:AVGPOWER?;AVGPOWER:UNITS?"  
20 ENTER 714;Average_power,Units$
```

Reducing delays caused by unused measurements

When a measurement cycle is triggered, the Test Set will attempt to obtain a value for all active measurements.

For instance, in CDMA mode (which is invoked when any CDMA screen is selected) the power measurement that is currently selected (Average Power, Access Probe Power, or Channel Power) is active by default. However, let's assume you are making a rho measurement and do not intend to query the power measurement. You can greatly speed up the availability of a rho measurement by turning off the currently selected power measurement.

Example 1. Turning off Average Power and Channel Power measurements

The following example turns off the Average Power measurement:

```
OUTPUT 714: "MEAS:CDM:AVGP:STATE OFF"
```

Example 2. Turning off the Rho suite of measurements

Conversely, let's assume you are making a power measurement and do not need rho or any of the rho suite of measurements.

The following example turns off the rho measurements:

```
OUTPUT 714: "MEAS:CDM:RHO:STATE OFF"
```

Reducing delays caused by screen changes

Each time the screen being displayed on the Test Set (active screen) is changed, it takes approximately 250 ms to access and draw the new screen. Additionally, each time a field on the active screen is changed it takes a finite amount of time to update the field. This update time depends on the length and type of field.

When the Test Set is operated remotely, it is possible to display a special “remote screen.” When the remote screen is displayed, the active screen is never changed.

When the remote screen is being displayed, the Test Set’s display is in the “locked” state. When the control program on the external controller unlocks the display, the screen is returned to the last remote screen requested. The *RST Common Command will place the Test Set’s display screen in the “unlocked” state. Pressing the [LOCAL] key causes a locked Test Set display session to end and causes the Test Set’s display screen to return to the unlocked state.

To Lock the Test Set’s Display Screen.

Use the :SPECial:DISPlay 'LOCKED'|'UNLOCKED' commands to lock and unlock the Test Set’s display screen.

Syntax

```
:SPECial:DISPlay 'LOCKED'  
:SPECial:DISPlay 'UNLOCKED'
```

Example

```
OUTPUT 714;"SPEC:DISP 'LOCKED' "
```

locks the Test Set’s display screen.

NOTE:

SPECial:DISPlay 'LOCKED'|'UNLOCKED' must not be invoked from the Test Set’s built-in IBASIC Controller. Executing these commands from an IBASIC program can produce unexpected results and is not supported.

Reducing measurement setup time

Measurement setup time can be minimized by specifying POWERON settings and specifying BASE settings in the Test Set's Save/Recall registers. Refer to Saving and Recalling Instrument Setups in Chapter 3, Operating Overview, *HP E8285A Users Guide*.

Symbols

"Enable timer-based registration."
on page 148, 201

Numerics

32768, 49, 324, 326
600 ohm impedance, 254

A

access attempts, ignoring, 179
access parameters message, 145, 184
access probe output power measurements, 175
programming example, 187
address, HP-IB, 244
alert order, 276
amplitude error measurements, 130
programming example, 137
analog system type, 194
arm measurement, 69
authentication, 283
list of tests, 199, 223
authentication tests
initializing shared secret data to zero, 201
performing a unique challenge-response, 216
shared secret data update on a traffic channel, 214, 219, 221, 222
updating shared secret data, 209
average power measurements
selecting, 27
zeroing procedure, 24

C

cable loss
correcting for, 29
measuring, 33
calibrating
See also zeroing
calibration
recommendations, for zeroing average power, 24
recommendations, overall, 15
call
mobile originated, 53, 221
mobile terminated, 52, 328
origination (analog call processing), 275
Call Processing (analog)
Status Register Group, program flow control, 264

call processing (analog)
general procedure, 254
overview, 249
screen, description of, 251
state diagram, 250
Call Processing Subsystem (analog)
accessing, 260
command syntax, 261
error messages, reading, 263
first-time setup, 262
querying data messages, 265
screen mnemonics, 260
carrier feedthrough measurements, 130
programming example, 137
carrier frequency, 109
CDMA to analog handoff, 190
programming example, 198
channel level calibration
programming example, 17, 18
channel numbers
EIA/TIA IS-95A, 56
channel power measurements
programming example, 23
concurrent measurements
cdma transmitter and receiver, 331
configuration
analog call processing, 279
for analog call processing, 268
continuous 0 power control bits, 149
continuous 1 power control bits, 159
control channel
turning on for analog call processing, 270
control channel (analog)
turning on, 280
controlled output power measurements, 153

D

data rate
paging channel, 120
Service Option 2, 66
Service Option 9, 66
demodulation
forward traffic channel, 60
slotted mode paging channel in AWGN, 118
desensitization, single tone, 88
dynamic range measurement, 75
programming example, 85

E

Eb/Nt
resolution of reading, 65
Ec/Ior
Sector A Power, default value, 62
external controller, 242

F

FER
specification, 67
status bits, 70, 83, 100, 116
frame rate characters
forward channel, 316
reverse channel, 316
frequency error measurements, 130
programming example, 137

H

handoff
CDMA to analog, 190
mobile station to new voice channel (analog call processing), 273
parameters, 195
verification, 197
HP-IB
address, 244
external control, 242
hum and noise measurement, 303

I

ignore access attempts, 179
impedance
600 ohms, 254
input, for analog call processing, 254
output, for call analog processing, 254
Increasing measurement speed
screen display time, 337
increasing measurement throughput, 321
Init Power parameter, 145, 184
intemodulation spurious response
attenuation measurement, 105
interim test results, 68
Ioc
definition, 63, 64
Ior/Ioc
definition, 121
IS-95A
CDMA channel numbers, 56

L

load impedance, 254
loading ROM program
 HP-IB syntax for, 17, 18
logging, CDMA protocol, 305
loopback mode
 data, 49, 324, 326
 voice, 49, 324, 326

M

Max Req Seq parameter, 145
Max Rsp Seq parameter, 145, 184
maximum power measurements, 139
 RF output power, 143
maximum RF output power measurements
 programming example, 151
measurements
 amplitude error, 130
 carrier feedthrough, 130
 demodulation of forward traffic channel with AWGN, 60
 demodulation of slotted mode paging channel in AWGN, 118
 dynamic range, 75
 frequency error, 130
 hum and noise, 303
 intermodulation spurious response attenuation, 105
 phase error, 130
 power, access probe, 175
 power, maximum, 139
 power, maximum RF output, 143
 power, minimum, 139
 power, minimum controlled output, 153
 power, range of open loop output, 164
 receiver sensitivity (CDMA), 75
 RF sensitivity (analog), 302
 rho, 130
 single tone desensitization, 88
 time offset, 130
 waveform quality, 130
MER
 definition, 118
MER (message error rate)
 calculation, 127
message
 changing contents, 299
 logging, CDMA protocol, 305
 viewing decoded words from mobile station handoff, 292

 viewing decoded words from mobile station origination, 295
 viewing decoded words from mobile station page, 290
 viewing decoded words from mobile station registration, 289
 viewing decoded words from mobile station release, 293
 viewing decoded words from order to change TX power of mobile, 294
message error rate. *See* MER.
MIN
 MS id, 282
minimum controlled output power measurements
 programming example, 161
minimum power measurements, 139
 controlled output power, 153

N

no service
 troubleshooting, 55
Nom Power parameter, 145, 184
Num Step parameter, 145, 184

O

open loop output power (range) measurements
 programming example, 173
open loop output power range, 164
origination, call (analog), 275

P

PAG_1 parameter, 124
PAG_2 parameter, 124
PAG_4 parameter, 124
paging
 mobile station (analog), 283
 mobile station for analog call processing, 271
paging channel
 data rate, 120
PCB_CAL, 17, 18
phase error measurements, 130
 programming example, 137
phone number
 MS Id, 282
pilot Ec/Ior
 factory preset value, 62
power
 mobile station transmitted, 274
power control bits

 continuous 0, 149
 continuous 1, 159
power measurements
 access probe output power, 175
 maximum closed/open loop, 139
 maximum RF output, 143
 minimum closed/open loop, 139
 minimum, controlled output, 153
 range of open loop output power, 164
power meter
 RF, zeroing for analog call processing, 267
Power Step parameter, 145, 184
power-up registration, 50
programming example
 access probe output power measurement, 187
 amplitude error measurements, 137
 carrier feedthrough measurements, 137
 CDMA channel level calibration, 17, 18
 CDMA to analog handoff, 198
 channel power calibration, 23
 demodulation of forward traffic channel with AWGN measurement, 72
 dynamic range measurement, 85
 frequency error measurements, 137
 maximum RF output power measurements, 151
 minimum controlled output power measurements, 161
 open loop output power (range) measurements, 173
 phase error measurements, 137
 receiver sensitivity measurement, 85
 rho measurements, 137
 single tone desensitization measurement, 102
 time offset measurements, 137
 waveform quality measurements, 137
protocol logging, 305
 commands, 317
 example log, 315

Q

querying
 amplitude error measurement, 136

- calibrating status event register, 23
 - carrier feedthrough measurement, 136
 - CDMA status event register, 51
 - Eb/Nt, 65
 - frequency error measurement, 136
 - phase error measurement, 136
 - rho measurement, 136
 - time offset measurement, 136
- R**
- range of open loop output power measurements, 164
 - programming example, 173
 - receiver sensitivity measurement programming example, 85
 - receiver sensitivity measurement (CDMA), 75
 - receiver tests
 - demodulation of forward traffic channel with AWGN, 60
 - demodulation of slotted mode paging channel in AWGN, 118
 - dynamic range, 75
 - intemodulation spurious response attenuation, 105
 - list of, 59
 - receiver sensitivity (CDMA), 75
 - single tone desensitization, 88
 - registration
 - of mobile station, 50
 - of mobile station for analog call processing, 270
 - power up, 51
 - troubleshooting failures, 57
 - release
 - mobile station, 273
 - RF channel
 - setting for home system, 56
 - setting for system A, 56
 - setting for system B, 56
 - RF output power measurements, 143
 - RF path loss
 - correcting for, 29
 - measuring, 33
 - rho measurements, 130
 - programming example, 137
 - running ROM program, 19
 - HP-IB syntax for, 19
- S**
- SAT tolerance, wide, 192
 - Sector A Power
 - Ec/Ior, default value, 62
 - sensitivity
 - RF, measuring (analog), 302
 - sensitivity, receiver (CDMA), 75
 - service option
 - selecting, 49, 324, 326
 - Service Option 2
 - data rate, 66
 - Service Option 9
 - data rate, 66
 - shared secret data
 - initializing to zero, 201
 - updating, 209
 - shared secret data update traffic channel, 214, 219, 221, 222
 - short message service
 - Sending short messages on the Paging/Access channels, 225
 - sending short messages on the Traffic channels, 233
 - SID, 56
 - single tone desensitization measurement, 88
 - programming example, 102
 - slotted mode paging channel demodulation, 118
 - SMS tests
 - sending short messages on the Paging/Access channels, 225
 - sending short messages on the Traffic channels, 233
 - spurs, 105
 - SSD
 - see shared secret data, 201, 209, 214, 219, 221, 222
 - system type, analog, 194
- T**
- time offset measurements, 130
 - programming example, 137
 - tolerance, SAT, 192
 - Traffic Ec/Ior
 - definition, 62
 - transmitter tests
 - list of, 129
 - waveform quality, 130
 - troubleshooting
 - no service found, 55
 - registration failures, 57
- U**
- unique challenge-response, 216
- W**
- waveform quality measurements
 - list of, 130
 - programming example, 137
 - wide SAT tolerance, 192
 - word
 - decoded from mobile station handoff, 292
 - decoded from mobile station origination, 295
 - decoded from mobile station page, 290
 - decoded from mobile station registration, 289
 - decoded from mobile station release, 293
 - to view, from order to change TX power of mobile, 294
- Z**
- zeroing
 - average power measurements, 24
 - recommendations, for average power, 24
 - RF power meter for analog call processing, 267, 278