



Agilent M9361A PXI Downconverter 2.75 GHz to 26.5 GHz



Service Guide

Version 1.1.0



Notices

© Agilent Technologies, Inc. 2010-2013

No part of this manual may be reproduced in any form or by any means (including electronic storage and retrieval or translation into a foreign language) without prior agreement and written consent from Agilent Technologies, Inc. as governed by United States and international copyright laws.

Manual Part Number

M9361-90009

Edition

Version 1.1.0

January 2013, build 2013.01.18.1320

Printed in USA

Agilent Technologies, Inc.

Sales and Technical Support

To contact Agilent for sales and technical support, refer to the “support” links on the following Agilent web resources:

- www.agilent.com/find/M9361A (product-specific information and support, software and documentation updates)
- www.agilent.com/find/M9392A (product-specific information and support, software and documentation updates)
- www.agilent.com/find/assist (worldwide contact information for repair and service)

Information on preventing damage to your Agilent equipment can be found at www.agilent.com/find/tips.

Regulatory Compliance

This product has been designed and tested in accordance with accepted industry standards, and has been supplied in a safe condition. To review the Declaration of Conformity, go to <http://regulations.corporate.agilent.com/DoC/search.htm>.

Warranty

The material contained in this document is provided “as is,” and is subject to being changed, without notice, in future editions. Further, to the maximum extent permitted by applicable law, Agilent disclaims all warranties, either express or implied, with regard to this manual and any information contained herein, including but not limited to the implied warranties of merchantability and fitness for a particular purpose. Agilent shall not be liable for errors or for incidental or consequential damages in connection with the furnishing, use, or performance of this document or of any information contained herein. Should Agilent and the user have a separate written agreement with warranty terms covering the material in this document that conflict with these terms, the warranty terms in the separate agreement shall control.

Technology Licenses

The hardware and/or software described in this document are furnished under a license and may be used or copied only in accordance with the terms of such license.

Restricted Rights Legend

If software is for use in the performance of a U.S. Government prime contract or sub-contract, Software is delivered and licensed as “Commercial computer software” as defined in DFAR 252.227-7014 (June 1995), or as a “commercial item” as defined in FAR 2.101(a) or as “Restricted computer software” as defined in FAR 52.227-19 (June 1987) or any equivalent agency regulation or contract clause. Use, duplication or disclosure of Software is subject to Agilent Technologies’ standard commercial license terms, and non-DOD Departments and Agencies of the U.S. Government will receive no greater than Restricted Rights as defined in FAR 52.227-19(c)(1-2) (June 1987). U.S. Government users will receive no greater than Limited Rights as defined in FAR 52.227-14 (June 1987) or DFAR 252.227-7015 (b)(2) (November 1995), as applicable in any technical data.

Safety Notices

The following safety precautions should be observed before using this product and any associated instrumentation.

This product is intended for use by qualified personnel who recognize shock hazards and are familiar with the safety precautions required to avoid possible injury. Read and follow all installation, operation, and maintenance information carefully before using the product.

WARNING

If this product is not used as specified, the protection provided by the equipment could be impaired. This product must be used in a normal condition (in which all means for protection are intact) only.

The types of product users are:

- **Responsible body** is the individual or group responsible for the use and maintenance of equipment, for ensuring that the equipment is operated within its specifications and operating limits, and for ensuring operators are adequately trained.
- **Operators** use the product for its intended function. They must be trained in electrical safety procedures and proper use of the instrument. They must be protected from electric shock and contact with hazardous live circuits.
- **Maintenance personnel** perform routine procedures on the product to keep it operating properly (for example, setting the line voltage or replacing consumable materials). Maintenance procedures are described in the user documentation. The procedures explicitly state if the operator may perform them. Otherwise, they should be performed only by service personnel.
- **Service personnel** are trained to work on live circuits, perform safe installations, and repair products. Only properly trained service personnel may perform installation and service procedures.

Agilent products are designed for use with electrical signals that are rated Measurement Category I and Measurement Category II, as described in the International Electrotechnical Commission (IEC) Standard IEC 60664. Most measurement, control, and data I/O signals are Measurement Category I and must not be directly connected to mains voltage or to voltage sources with high transient over-voltages. Measurement Category II connections require protection for high transient over-voltages often associated with local AC mains connections. Assume all measurement, control, and data I/O connections are for connection to Category I sources unless otherwise marked or described in the user documentation.

Exercise extreme caution when a shock hazard is present. Lethal voltage may be present on cable connector jacks or test fixtures. The American National Standards Institute (ANSI) states that a shock hazard exists when voltage levels greater than 30V RMS, 42.4V peak, or 60VDC are present. A good safety practice is to expect that hazardous voltage is present in any unknown circuit before measuring.

Operators of this product must be protected from electric shock at all times. The responsible body must ensure that operators are prevented access and/or insulated from every connection point. In some cases, connections must be exposed to potential human contact. Product operators in these circumstances must be trained to protect themselves from the risk of electric shock. If the circuit is capable of operating at or above 1000V, no conductive part of the circuit may be exposed.

Do not connect switching cards directly to unlimited power circuits. They are intended to be used with impedance-limited sources. NEVER connect switching cards directly to AC mains. When connecting sources to switching cards, install protective devices to limit fault current and voltage to the card.

Before operating an instrument, ensure that the line cord is connected to a properly-grounded power receptacle. Inspect the connecting cables, test leads, and jumpers for

possible wear, cracks, or breaks before each use.

When installing equipment where access to the main power cord is restricted, such as rack mounting, a separate main input power disconnect device must be provided in close proximity to the equipment and within easy reach of the operator.

For maximum safety, do not touch the product, test cables, or any other instruments while power is applied to the circuit under test. ALWAYS remove power from the entire test system and discharge any capacitors before: connecting or disconnecting cables or jumpers, installing or removing switching cards, or making internal changes, such as installing or removing jumpers.

Do not touch any object that could provide a current path to the common side of the circuit under test or power line (earth) ground. Always make measurements with dry hands while standing on a dry, insulated surface capable of withstanding the voltage being measured.

The instrument and accessories must be used in accordance with its specifications and operating instructions, or the safety of the equipment may be impaired.

Do not exceed the maximum signal levels of the instruments and accessories, as defined in the specifications and operating information, and as shown on the instrument or test fixture panels, or switching card.

When fuses are used in a product, replace with the same type and rating for continued protection against fire hazard.

Chassis connections must only be used as shield connections for measuring circuits, NOT as safety earth ground connections.

If you are using a test fixture, keep the lid closed while power is applied to the device under test. Safe operation requires the use of a lid interlock.

CAUTION

A **CAUTION** notice denotes a hazard. It calls attention to an operating procedure, practice, or the like that, if not correctly performed or adhered to, could result in damage to the product or loss of important data. Do not proceed beyond a **CAUTION** notice until the indicated conditions are fully understood and met.

WARNING

A **WARNING** notice denotes a hazard. It calls attention to an operating procedure, practice, or the like that, if not correctly performed or adhered to, could result in personal injury or death. Do not proceed beyond a **WARNING** notice until the indicated conditions are fully understood and met.

Instrumentation and accessories shall not be connected to humans.

Before performing any maintenance, disconnect the line cord and all test cables.

To maintain protection from electric shock and fire, replacement components in mains circuits – including the power transformer, test leads, and input jacks – must be purchased from Agilent. Standard fuses with applicable national safety approvals may be used if the rating and type are the same. Other components that are not safety-related may be purchased from other suppliers as long as they are equivalent to the original component (note that selected parts should be purchased only through Agilent to maintain accuracy and functionality of the product). If you are unsure about the applicability of a replacement component, call an Agilent office for information.

WARNING

No operator serviceable parts inside. Refer servicing to qualified personnel. To prevent electrical shock do not remove covers. For continued protection against fire hazard, replace fuse with same type and rating.

PRODUCT MARKINGS:



The CE mark is a registered trademark of the European Community.



The C-Tick mark is a registered trademark of the Australian Spectrum Management Agency.



This symbol indicates product compliance with the Canadian Interference-Causing Equipment Standard (ICES-001). It also identifies the product is an Industrial Scientific and Medical Group 1 Class A product (CISPR 11, Clause 4).



This symbol indicates separate collection for electrical and electronic equipment, mandated under EU law as of August 13, 2005. All electric and electronic equipment are required to be separated from normal waste for disposal (Reference WEEE Directive, 2002/96/EC).



This symbol on an instrument means caution, risk of danger. You should refer to the operating instructions located in the user documentation in all cases where the symbol is marked on the instrument.



This symbol indicates the time period during which no hazardous or toxic substance elements are expected to leak or deteriorate during normal use. Forty years is the expected useful life of the product.



This symbol indicates the instrument is sensitive to electrostatic discharge (ESD). ESD can damage the highly sensitive components in your instrument. ESD damage is most likely to occur as the module is being installed or when cables are connected or disconnected. Protect the circuits from ESD damage by wearing a grounding strap that provides a high resistance path to ground. Alternatively, ground yourself to discharge any built-up static charge by touching the outer shell of any grounded instrument chassis before touching the port connectors.

CLEANING PRECAUTIONS:

WARNING

To prevent electrical shock, disconnect the Agilent Technologies instrument from mains before cleaning. Use a dry cloth or one slightly dampened with water to clean the external case parts. Do not attempt to clean internally. To clean the connectors, use alcohol in a well-ventilated area. Allow all residual alcohol moisture to evaporate, and the fumes to dissipate prior to energizing the instrument.

Table of Contents

Service Guide Introduction	7
Structure of This Document	7
Related Documentation	7
Documentation Map	8
Getting Started	9
Follow the Startup Sequence	9
Step 1: Unpack and Inspect the Module	10
ESD	10
Step 2: Install the Software	10
System Requirements	10
Hardware Requirements	11
Power up the Controller	11
Software Installation Overview	11
Software Installation Procedure	12
Step 3: Install the Module	13
Recommended Practices for Temperature Control	13
Module Installation Procedure	13
Agilent M9361A PXI Downconverter Front Panel Features	15
Front Panel Connectors	15
Front Panel LEDs	15
High-Level Diagnostic Tools, Processes and References	16
Specifications	16
Self Test	16
Hardware Status Display	16
Front Panel LEDs	17
Block Diagram	18
Operational Check	18
Performance Verification Tests	21
Gain Compression Test	21
IF 3 dB Bandwidth Test	25
IF Video Test	28
LO Leakage at IF Port Test	33
Third Order Intercept (TOI) Test	37
Service	43
Replaceable Parts	43
Module Core Replacement	44
Test Record Card	48

Service Guide Introduction

This document is intended for use by Agilent Service Centers and by self-maintaining customers.

Structure of This Document

- [Getting Started](#) (page 9): Use this section to make sure you have the module installed (software and hardware) as a prerequisite for conducting diagnostic tests.
- [High-Level Diagnostic Tools, Processes and References](#) (page 16): This section provides high-level tools, processes, and references to help you diagnose problems with your module.
- [Performance Verification Tests](#) (page 21): These tests are designed to provide the highest level of confidence that the module being tested conforms to published, factory-set [specifications](#). If the module is unable to pass any one of the performance tests, you may need to exchange the defective module (see [Module Core Replacement](#) on page 44).
- [Service](#) (page 43): This section provides reference information and procedures to help you service your Agilent M9361A, including the replaceable parts list, module core replacement instructions, and a [Test Record Card](#) (page 48) you can use to record your performance test findings.

Related Documentation

In addition to this Service Guide, the related documentation for the M9361A module includes:

- **Startup Guide:** Provides instructions to unpack, inspect, install (software and hardware), perform instrument connections, verify operability, and troubleshoot problems. The key elements from the Startup Guide are duplicated in this Service Guide's [Getting Started](#) material (see page 9) for your convenience.
- **Data Sheet:** Provides a detailed product introduction and full product specifications.
- **Soft Front Panel (SFP) help system:** Provides product introduction, tour of the SFP user interface, how-to procedures (for example, configuration, self test, operational check), and troubleshooting.
- **IVI Driver reference (help system):** Provides documentation of the IVI-COM and IVI-C driver API functions, and information to help you start using the drivers in your application development environment.
- **LabVIEW Driver reference (help system):** Provides documentation of the LabVIEW G driver API.

If you ran the product software installer on your PC, you can access the related documentation (startup guide, data sheet, SFP help, and LabVIEW help) from **Start > Programs > Agilent > M9392 > M9361**. For IVI driver help, see **Start > Programs > Agilent IVI Drivers > AgM9361**.

All the product documentation noted above is provided on the product CD. To find the latest versions of the documentation, go to the product web site (www.agilent.com/find/M9361A) and download the files from the Manuals list (go to **Document Library > Manuals**).

Documentation Map

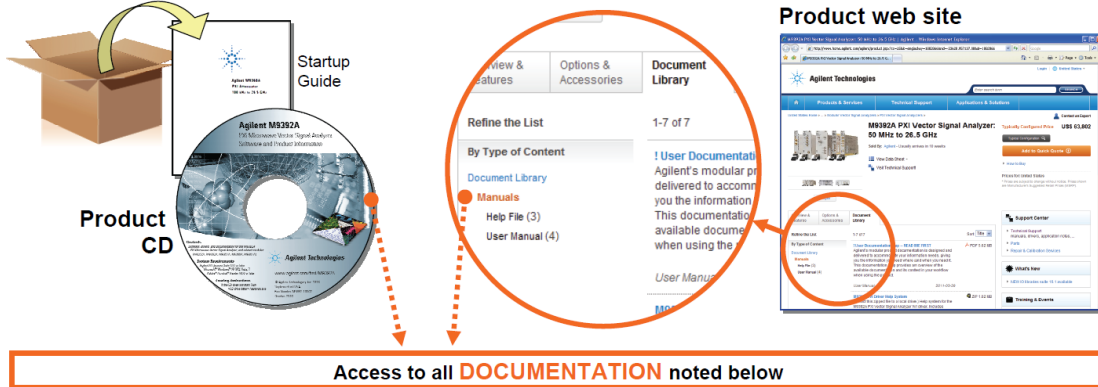

Startup Guide



- Unpack product
- Verify shipment
- Install software
- Install & connect hardware
- Verify operation
- Troubleshooting

Data Sheet



- Product description
- Technical specifications

Service Guide



- Diagnostic tools, troubleshooting
- Replaceable parts
- Assembly/disassembly
- Performance verification tests
- Test results form

Soft Front Panel (SFP) user interface

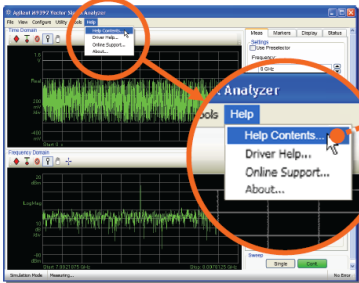

SFP help system

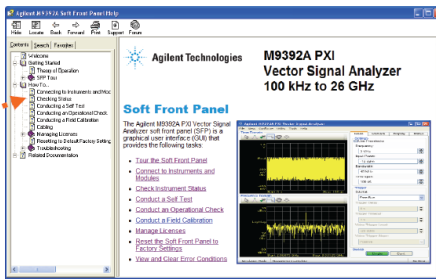

- Theory of operation
- Block diagram
- Configuration
- Self test
- Operational check
- Field calibration
- Troubleshooting

Visual Studio

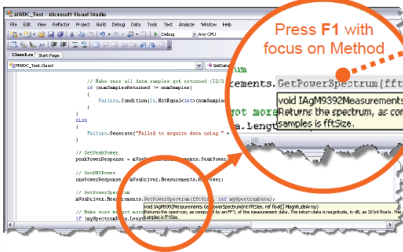

IVI Driver help system



- IVI-COM and IVI-C driver programmer's reference
- Sample programs

LabVIEW

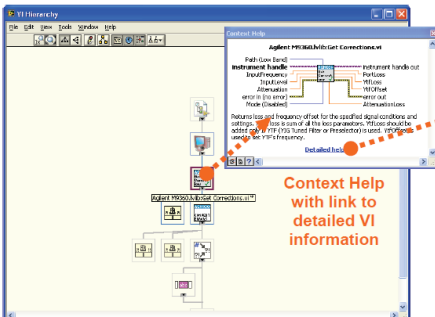

LabVIEW Driver help system

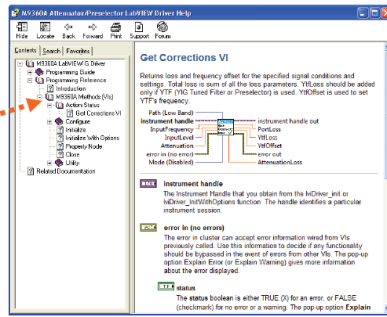

- LabVIEW driver programmer's reference
- Sample programs

Getting Started

NOTE

Much of this material, although found in the Startup Guide, is available for your convenience to make sure the module and software are properly installed as a prerequisite for conducting diagnostic procedures. If you are familiar with this material, proceed to [High-Level Diagnostic Tools, Processes and References](#) (page 16).

In this section:

- [Follow the Startup Sequence](#) (page 9)
- [Step 1: Unpack and Inspect the Module](#) (page 10)
- [Step 2: Install the Software](#) (page 10)
- [Step 3: Install the Module](#) (page 13)

Follow the Startup Sequence

WARNING

Closely follow the startup process flow in this document. Deviating from the sequence can cause unpredictable system behavior, damage your system, and may cause personal injury.

Step 1: Unpack and Inspect

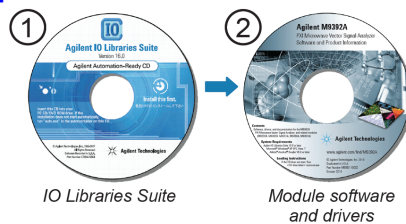
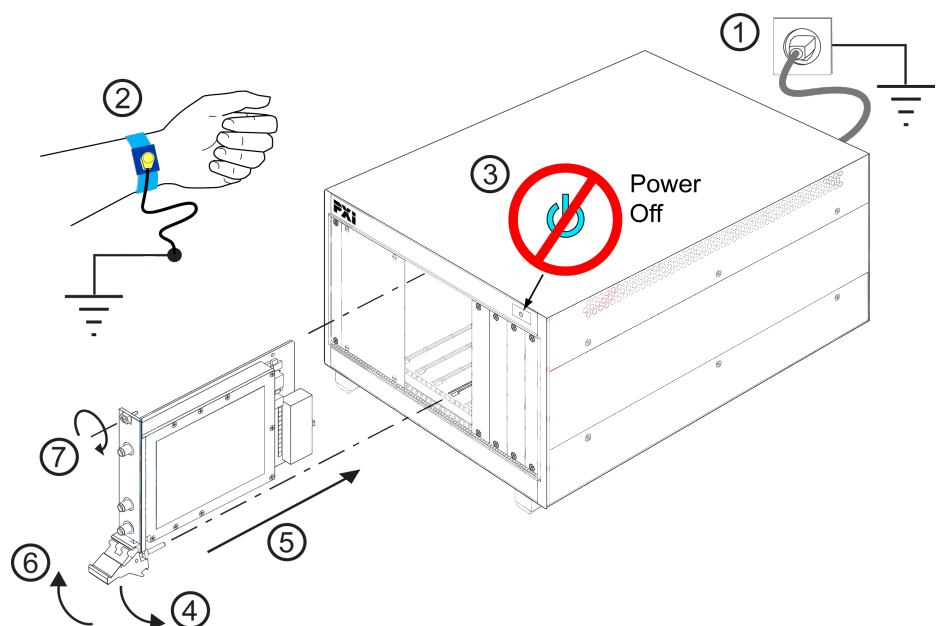
Step 2: Install Drivers and Software

Step 3: Install Module

Step 1: Unpack and Inspect the Module

CAUTION The module is shipped in materials which prevent damage from static. The modules should only be removed from the packaging in an anti-static area ensuring that correct anti-static precautions are taken. Store all modules in anti-static envelopes when not in use.

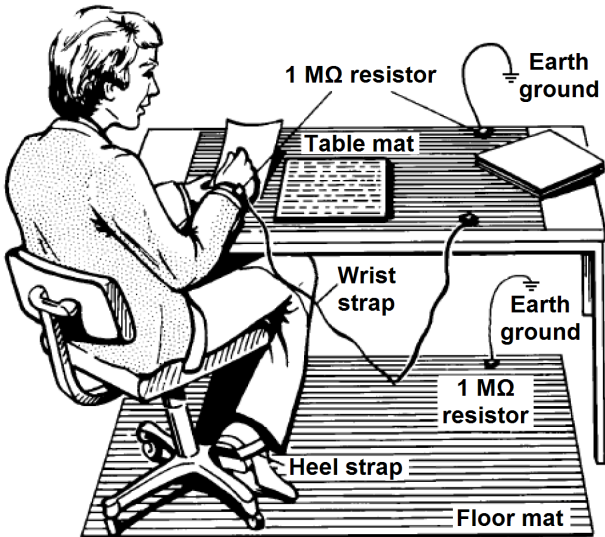
ESD



Electrostatic discharge (ESD) can damage or destroy electronic components. Use a static-safe work station to perform all work on electronic assemblies. The figure (left) shows a static-safe work station using two types of ESD protection: conductive table-mat and wrist-strap combination, and conductive floor-mat and heel-strap combination. Both types, when used together, provide a significant level of ESD protection. Of the two, only the table-mat and wrist-strap combination provides adequate ESD protection when used alone. To ensure user safety, the static-safe accessories must provide at least 1 MΩ of isolation from ground.

WARNING DO NOT use these techniques for a static-safe work station when working on circuitry with a voltage potential greater than 500 volts.

Step 2: Install the Software

System Requirements

Topic	Windows® 7 and Vista Requirements	Windows® XP Requirements
Operating system	Windows 7 (32 bit and 64 bit); Windows® Vista, SP1 and SP2 (32-bit and 64-bit)	Window® XP, Service Pack 3
Processor speed	1 GHz 32-bit (x86), 1 GHz 64-bit (x64), no support for Itanium64	600 MHz or higher required 800 MHz recommended
Available memory		256 MB minimum (1 GB or greater recommended)
Available disk space	1.5 GB available hard disk space, includes: <ul style="list-style-type: none"> • 1 GB available for Microsoft .NET Framework 3.5 SP1 ² • 100 MB for Agilent IO Libraries Suite 	
Video	Support for DirectX 9 graphics with 128 MB graphics memory recommended (Super VGA graphics is supported)	Super VGA (800x600) 256 colors or more
Browser	Microsoft® Internet Explorer 7.0 or greater	Microsoft® Internet Explorer 6.0 or greater

¹ This is the required disk space for installation. Typically, less disk space is required for operation than is required for installation.

² .NET Framework Runtime Components are installed by default with Windows 7 and Vista. Therefore, you may not need this amount of disk space.

Hardware Requirements

Topic	Requirements
Chassis	cPCI(J1), PXI-1, or PXIe hybrid chassis slot
Host controller	A PXI or PXI Express embedded controller or remote controller (external PC connected to the chassis by a PCI-to-PXI interface) is required.
Embedded controller	Agilent M9036A or an embedded controller that meets the following requirements: <ul style="list-style-type: none"> • PXIe system controller (PXI-1 embedded controllers are not compatible) • Utilize a 2x8, 4x4, or 1x4 PXIe system slot link configuration. • Run one of the operating systems listed in System Requirements (above).
Remote controller	(for Agilent M9018A chassis use only) Agilent M9021 Cable Interface x8 with one of the following PC interface options: <ul style="list-style-type: none"> • Agilent M9045B PCIe ExpressCard Adaptor x1, with cable (for a laptop PC) • Agilent M9048A PCIe Desktop Adaptor x8, with cable (for desktop PCs) Or an equivalent remote controller using a PC running one of the operating systems listed in System Requirements (above).

Power up the Controller

CAUTION

If you are using a remote controller and you have installed the interface cable, you must power up the chassis **BEFORE** you power up the PC. When you power down your chassis, Shut Down the PC **BEFORE** you power down the chassis.

If you are using an embedded controller, complete the following steps:

1. Install the embedded controller module into the compatible chassis. The Agilent M9036A PXIe Embedded Controller and Agilent M9018A PXIe Chassis are recommended. Please refer to the embedded controller and chassis documentation for further details.
2. Connect peripherals (mouse, keyboard, monitor).
3. Power up the chassis.

Software Installation Overview

This installation includes the following:

- Agilent IO Libraries Suite (IOLS), which includes the Agilent Connections Expert. This software is included with your shipment (CD part number E2094-60003), and is also available at www.agilent.com/find/iosuite. This software must be installed first.

NOTE

Version 16.3.16603.3 (or newer) of the Agilent IO Libraries Suite is required.

- Instrument software, which includes the SFP, device drivers (IVI-C, IVI-COM, and LabVIEW G) and documentation for the M9392A Vector Signal Analyzer. This software is included with your shipment (CD part number , and is also available at www.agilent.com/find/M9392A.

Software Installation Procedure

1. Install the Agilent IO Libraries Suite from the Agilent IO Libraries Suite CD (E2094-60003) provided in your ship kit. Follow the installer prompts to install the IO libraries.
2. Install the M9361A product software:
 - a. Using the Agilent M9392A PXI Vector Signal Analyzer Software and Product Information CD (M9392-10002), launch the installer.
 - b. Follow the installer prompts. Choose a "Complete" installation to install all software and documentation, or a "Custom" installation to select from a listing of modules and other features.

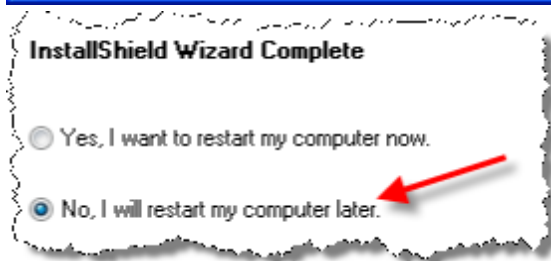
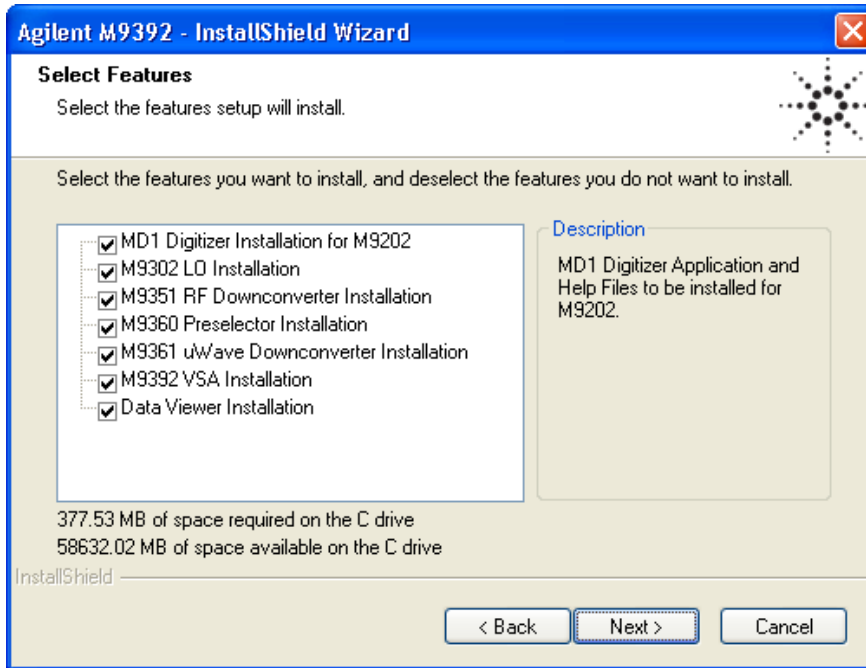

3. Power down the host PC.

CAUTION

If you are using a remote controller, Shut Down the PC BEFORE you power down the chassis. When you restore power, power up the chassis BEFORE you power up the PC.

Step 3: Install the Module

CAUTION

PXI hardware does not support "hot-swap" (changing modules while power is applied to the chassis) capabilities. Before installing or removing a module to/from the chassis, power off the chassis to prevent damage to the module.

NOTE

This module can be used in a chassis with cPCI(J1), PXI-1, or PXIe hybrid slots.

Recommended Practices for Temperature Control

- Use slot blockers and EMC filler panels in empty module slots to assure proper operating temperatures.
- At ambient temperatures above 45° C (113° F) set the chassis fan to High.
- The use of an Agilent M9018A Chassis and slot blockers optimizes module temperature performance.

Module Installation Procedure

3

The module can be installed in any standard PXI slot marked with a peripheral slot compatibility image (a circle containing the slot number).

7^H

The module can also be installed in any hybrid PXI slot marked with a peripheral slot compatibility image (the letter "H" and a solid circle containing the slot number).

1. Make sure that the line cord is plugged in to establish earth ground and that the chassis power switch is Off.
2. If the chassis has multiple fan speed settings, ensure that the fan switch is set to **AUTO**.
3. Position the chassis to provide ample space between the chassis fan intake and exhaust vents. Blockage by walls or obstructions affects the air flow needed for cooling. (Refer to the chassis documentation for more information about cooling).
4. Before inserting the module into the chassis, back the mounting screws out to ensure that there is no interference between the screws and the mounting rails.
5. Holding the module by the injector/ejector handle, slide it into an available PXI (or hybrid) slot, as shown in the figure below.

Getting Started

- a. Install the module into the slot of the chassis by placing the module card edges into the front module guides (top and bottom).
- b. Slide the module to the rear of the chassis and ensure that the injector/ejector handle is pushed down in the unlatched (downward) position.
- c. Slide the module completely into the chassis. When you begin to feel resistance, pull up on the injector/ejector handle to fully inject the module into the chassis.

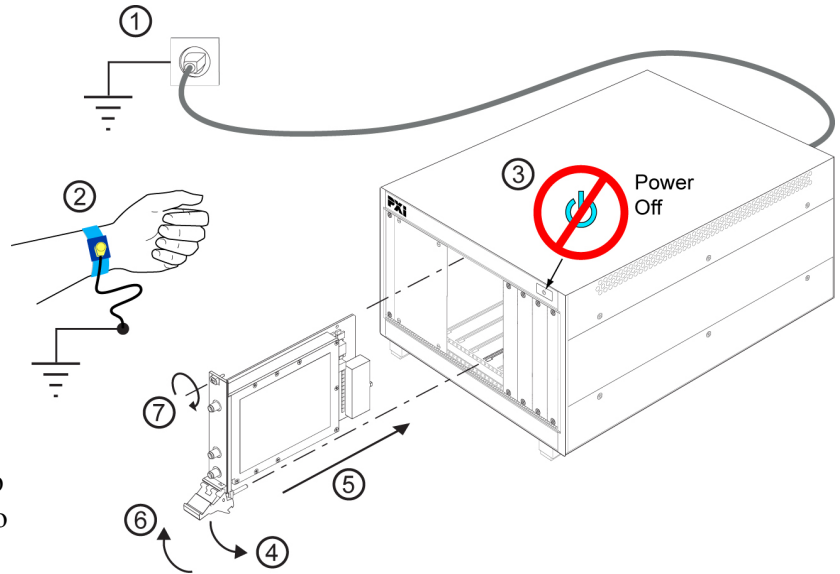

7. Secure the front panel to the chassis using the two module front-panel mounting screws. Performance may suffer if the screws are not tightened properly.
8. Verify that the PXI chassis fans are operable and free of dust and other contaminants that may restrict airflow.
9. Install filler panels and slot blockers after installing the module. Missing filler panels or slot blockers may disrupt air circulation in the chassis.
10. Use the Cabling Diagram plus the Cable and Module Table on the next page to attach the cables to the instrument. The torque specification for SMA connectors is 8 Lb-In (0.904 Nm).
11. If you are using a PCIe Cable Interface, such as the Agilent M9021, connect the Cable Interface in the chassis to the PC host per the instructions that came with the Cable Interface.
12. Power up the PXI chassis.
13. Reboot the PC host.

Agilent M9361A PXI Downconverter Front Panel Features

CAUTION

The maximum input to the RF input connector (RF IN) must not exceed +10 dBm.

CAUTION

When using an M9360A with an M9361A, caution must be exercised. Although the M9360A can accept input power levels of +10 dBm without damage, the operating range of the M9361A is -30 dBm to -160 dBm. Attenuation is required so that the power coming out of the M9360A does not exceed the maximum power that can be applied to the M9361A RF IN connector.

CAUTION

The maximum input to the AUX IN connector must not exceed +10 dBm.

CAUTION

The maximum output of the IF OUT connector can exceed +20 dBm.



Front Panel Connectors

Connector	Description
RF IN	This SMA female connector inputs a signal (2.75 GHz to 26.5 GHz) from the Agilent M9360A PXI Attenuator/Preselector to be downconverted. The operating range is -30 dBm to -160 dBm. Damage occurs above +10 dBm.
LO IN	This SMA female connector receives the LO signal from the M9360A. This LO signal is used to downconvert the RF signal that is input to the RF IN connector and produce a 500 MHz IF OUT.
VIDEO OUT	This SMB male connector is used to deliver the video output signal which is enabled at all times. This video output is a DC level which is representative of the total signal power contained within the IF passband of the instrument.
AUX IN	This SMB male connector is used to switch an external IF signal (100 kHz to 500 MHz) directly to the M9361A IF OUT and bypassing the downconversion process of the M9361A; this IF signal is directly available from the IF OUT connector.
IF OUT	This SMB male connector is used to output an IF signal from the M9351A or the M9361A to the INPUT 1 connector of the Agilent M9202A PXIe IF Digitizer. This signal frequency is approximately 500 MHz.

Front Panel LEDs

LED	Description
STATUS	<p>This LED indicates the overall health of the M9361A and is a summary of the following LEDs, covering the power supplies and other hardware operations. The M9361A has extensive built-in-tests (BIT) and specific issues can be identified by observing the status indicator on the front panel.</p> <p>This LED has four possible states:</p> <ul style="list-style-type: none"> • Green = Power supplies are operational and in specification. It also indicates that all module hardware is operational. • Amber = Power supplies are operational and in specification, but there is a hardware failure. • Red = Power supply failure and a hardware failure. • Off = Power supply failure, but the other module hardware appears to be functional. Since a power supply failure can mask other hardware problems, this is not an indication that only a power supply could be at fault.
ACCESS	Each time the module is written to, or read from, this amber LED blinks.

NOTE

The front panel LED behavior is valid only when the soft front panel (SFP) is running or when the Initialize function/method has been called..

High-Level Diagnostic Tools, Processes and References

This section provides high-level tools, processes, and references to help you diagnose problems with your module.

NOTE

Before attempting to diagnose the Agilent M9361A, make sure you have followed the necessary startup instructions (see "[Getting Started](#)" on page 1).

In this section:

- [Specifications](#) (page 16)
- [Self Test](#) (page 16)
- [Front Panel LEDs](#) (page 17)
- [Block Diagram](#) (page 18)
- [Operational Check](#) (page 18)

Specifications

The Data Sheet for the M9361A is included on the Agilent M9392A VSA Software and Product Information CD that came with your module. This document contains specification information. To find the latest update, go to <http://cp.literature.agilent.com/litweb/pdf/5990-6059EN.pdf>.

Self Test

The Soft Front Panel (SFP) provides a self test utility to verify power and perform an internal check of module sub-components. To access the SFP, go to **Start > All Programs > Agilent > M9392 > M9361 SFP**. To conduct the self test from the SFP, go to **Utility > Self Test...**, and then click the Run Self Test button.

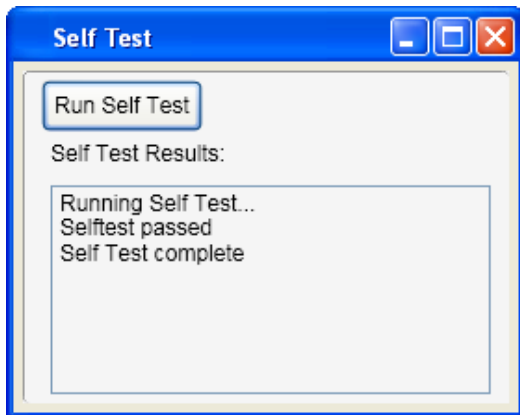

Hardware Status Display

The Soft Front Panel (SFP) displays the module's hardware status. To access the SFP, go to **Start > All Programs > Agilent > M9392 > M9361 SFP**. The status is automatically updated once every five seconds. The status can also be manually updated by a refresh (**View > Refresh**).

- **Temperature** – the temperature value that is displayed indicates the internal real-time ambient temperature of the module in degrees Celsius.
- **Voltage** – the +12 V, +5 V, +3.3 V, and -12 V power supplies display as green when they are functioning and within tolerance.
- **Overload** – the word "Normal" along with a green background color indicates that the module's IF power is at a normal level. If the normal operating range of IF output power is exceeded, the word "Overload" is displayed and the background color turns red.

Hardware Status			
IF Path:	Normal	Temperature:	37.8
Attenuation1:	3 dB	Voltage:	+12 +5 +3.3 -12
Attenuation2:	10 dB	Overload:	Normal
Gain:	37.800 dB	Self Test:	Pass
		Serial #:	12345678

The normal operating range of IF output power can be exceeded and indicate an overload when either the RF signal applied at RF A IN exceeds +10 dBm or the IF attenuation setting is too low. If the IF attenuation setting is too low, the power going through the IF is too high and triggers the overload indicator when power above +4 dBm is detected before the Video Out connector.

- **Self Test** – the word "Pass" along with a green background color indicates that the module's self test passed. If the self test fails, the word "Fail" is displayed and the background color turns red.
- **Serial #** – the module's serial number is displayed.
- The values for **IF Path**, **Attenuation1**, **Attenuation2**, and **Gain** reflect the settings you've made in the SFP interface. For reference, refer also to the [Block Diagram](#) (page 18).

Front Panel LEDs

NOTE

The front panel LED behavior is valid only when the soft front panel (SFP) is running or when the `Initialize` function/method has been called, using the application programming interface (API).



LED	Description
STATUS	<p>This LED indicates the overall health of the M9361A and is a summary of the following LEDs, covering the power supplies and other hardware operations. The M9361A has extensive built-in-tests (BIT) and specific issues can be identified by observing the status indicator on the front panel.</p> <p>This LED has four possible states:</p> <ul style="list-style-type: none"> • Green = Power supplies are operational and in specification. It also indicates that all module hardware is operational. • Amber = Power supplies are operational and in specification, but there is a hardware failure. • Red = Power supply failure and a hardware failure. • Off = Power supply failure, but the other module hardware appears to be functional. Since a power supply failure can mask other hardware problems, this is not an indication that only a power supply could be at fault.
ACCESS	Each time the module is written to, or read from, this amber LED blinks.

Block Diagram

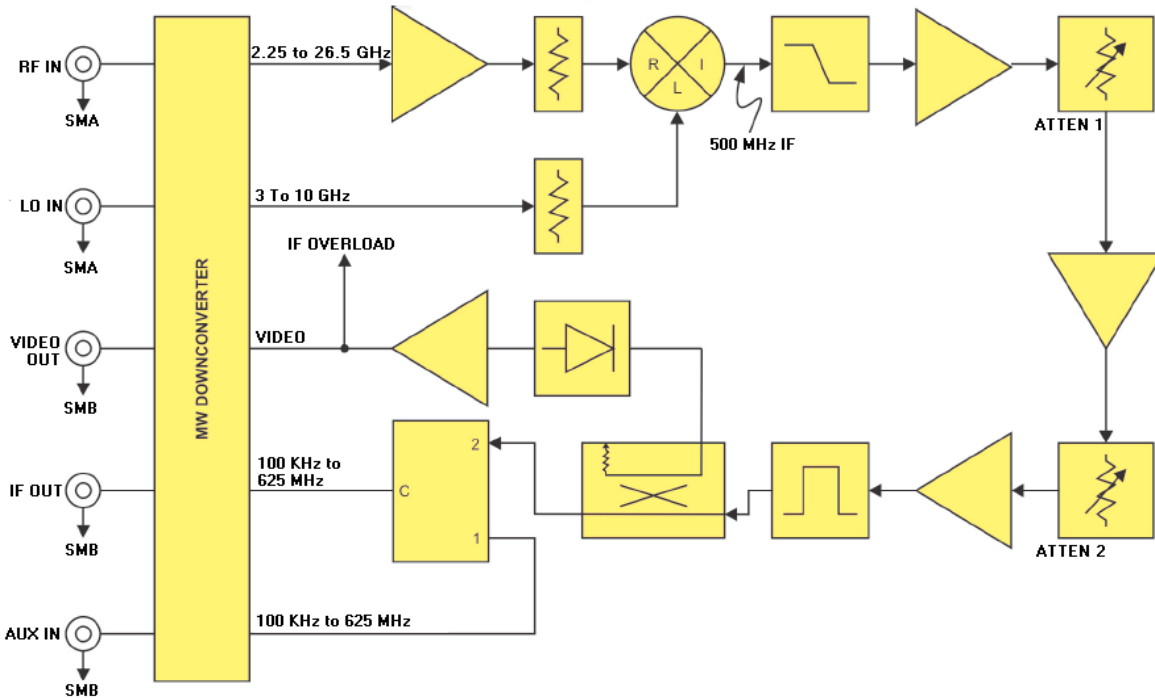

Operational Check

NOTE This operational check procedure is used for high-level troubleshooting – a rough diagnostic to ascertain if the module is functioning properly. You do not have to conduct the operational check if you conduct the [Performance Verification Tests](#) (see page 21).

Requirements for Operational Check

The Agilent M9361A PXI Downconverter operational check measures the signal paths from the LO IN and RF IN connectors to the IF OUT connector. The following process demonstrates that all associated switches, connectors, cables and circuitry are operational.

Required Hardware

To demonstrate that the module functions properly requires external equipment. This includes a precision microwave source and a power meter. You will not be using the module interconnect cables, so some high-quality flexible 3.5 mm cables will be required, plus adaptors to connect the PSG (precision signal generator) and power meter to 3.5 mm connectors. Please refer to the following table for recommended hardware.

Hardware	Description
Agilent E8257D-532 or E8267D-532	Precision Signal Generator 31.8 GHz
Agilent N1913A or N1914A	Single / Dual Channel Power Meter
Agilent N8485A, Option 100	10 MHz to 26.5 GHz Power Sensor
Agilent 11730A	Power Sensor Cable

M9361A Operational Check Procedure

NOTE

First run the Agilent M9302A PXI Local Oscillator operational check to ensure that it is operating correctly. If an M9302A LO is not available, a second PSG can be substituted for the LO and the output power set to +15 dBm \pm 2 dBm.

CAUTION

Make sure that the IF OUT connector of the M9351A is not routed to the AUX IN connector of the M9361A.

- Run the M9361A soft front panel (SFP).
- Conduct a Self Test (**Utility > Self Test... > Run Self Test**).
 - If self test passes, go to next step.
 - If the self test fails, the module needs repair.
- On the M9361A SFP Primary Settings:
 - Set the Input Frequency to 2.25 GHz.
 - Set the Input Level to -40 dBm (-40 dBm is the default).
- Using the M9302A LO SFP:
 - Set the M9302A LO Frequency to 2.75 GHz
 - Connect the M9302A LO OUT to the M9361A LO IN
- On the PSG:
 - Set the frequency to 2.25 GHz.
 - Set the amplitude to -40 dBm.
 - Connect the PSG RF OUT to the M9361A RF IN.
- Connect the power meter to the M9361A IF OUT. The power should be between -1 and -6 dBm.
- Repeat steps 5 and 6 with the source set to 8.45 GHz, 17.4 GHz and 26.35 GHz and the M9302A LO set to 8.95 GHz, 5.97 GHz and 8.95 GHz (M9302A LO 500 MHz above the source). LO frequencies of 5.97 GHz and 8.95 GHz generate third order harmonics of 17.9 GHz and 26.85 GHz, used to downconvert 17.4 GHz and 26.35 GHz to 500 MHz.
- Using the M9361A SFP:
 - Select Custom Settings (click inside the small square and a check mark appears).
 - Select AUX IN.
- Remove the cable from RF IN.
- Set the PSG to 500 MHz, -2 dBm.
- Connect the cable from the PSG RF OUT to AUX IN.
- The delta in power between AUX IN and IF OUT should be \leq 3 dB.
- If all measurements are correct the module is working properly, if not the module requires servicing.

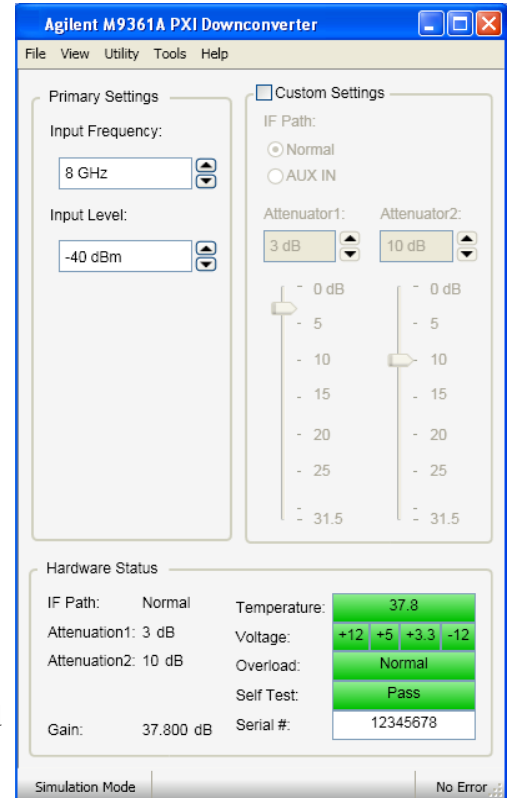

If a Problem is Found

If a problem is found, do the following checks:

- Verify that all relevant hardware is turned on.

High-Level Diagnostic Tools, Processes and References

2. Verify that the M9302A and M9361A paths are correctly set from the SFPs and that the signal generator is set to the proper power/frequency and that all cables are properly connected. All SMA connector are torqued to 8 Lb-In (0.904 Nm).
3. Check that the Status LED is green.
4. Verify that the ACCESS LED flashes each time that the module is written to.
5. See [Performance Verification Tests](#) (page 21) to verify the module is performing according to published, factory-set specifications.

If you need to swap a defective module with a core replacement module from Agilent, see [Module Core Replacement](#) (page 44).

Performance Verification Tests

The performance verification tests are designed to provide the highest level of confidence that the module being tested conforms to published, factory-set [specifications](#). The tests are designed to test a module operating within the temperature range defined by the module [specifications](#). If the module is unable to pass any of the performance tests, you may need to exchange the defective module for a new one – see [Module Core Replacement](#) (page [44](#)). Use the provided [Test Record Card](#) (page [48](#)) to record your findings.

NOTE

Before attempting to conduct performance tests with the Agilent M9361A, make sure you have followed the necessary startup instructions (see "[Getting Started](#)" on page [9](#)).

Performance verification tests:

- [Gain Compression Test](#) (page [21](#))
- [IF 3 dB Bandwidth Test](#) (page [25](#))
- [IF Video Test](#) (page [28](#))
- [LO Leakage at IF Port Test](#) (page [33](#))
- [Third Order Intercept \(TOI\) Test](#) (page [37](#))

Gain Compression Test

Test Method

Gain compression describes the decrease in the gain of the downconverter in the presence of large signals at the input.

This test measures the change in gain of the M9361A in the presence of a large input signal compared with the gain with a much lower signal level. The measurement procedure inputs two signals into the downconverter at two different powers and two different frequencies while noting the amplitude of the low power signal at the IF output. Initially with the high power level signal turned off, a low level input signal is applied such that the downconverter is operating in its linear region. The signal at the IF is measured by a signal analyzer and the power level is noted as the reference. The high power signal is then applied while the low power signal input level remains unchanged. The high power signal level is adjusted until the low power signal measured by the signal analyzer decreases by 1 dB. The input level of the high level signal is measured and reported as the 1 dB compression point.

Limitations and Considerations

Nomenclature

This document refers to 1 dB compression where the 1 dB is a positive number. However, this represents a reduction in the gain of the downconverter of 1 dB. In the analysis, it is assumed that the gain decreases. Therefore, it may appear at times that the sign of the gain, in dB, is inconsistent. Keep in mind that when referring to 1 dB compression, the text appears as a positive number, but for the evaluation of all the equations, the compression value is assumed a negative dB value.

Spectrum Analyzer Compression

For this test, a spectrum analyzer measures the signals from the downconverter IF output. It is important that the signal levels measured by the spectrum analyzer are low enough that the spectrum analyzer does not itself

experience compression.

1 dB Compression Point

It is necessary to find the 1 dB compression point and measure the input power. The exact 1 dB compression point cannot be found due to errors while making relative power measurements with the signal analyzer and due to a finite tolerance in setting powers. The change in absolute power at the input of the downconverter results in a dB per dB change in the measured compression when the downconverter is near the 1 dB compression point. Therefore, the absolute power reading is adjusted by an amount, in dB, equal to the difference in the measured compression and the desired compression of 1 dB.

Signal Analyzer Assumptions

The signal analyzer is used to measure the change in gain by making relative power measurements. For this test, the relative power measurement is made at a single frequency without changing the signal analyzer configuration. In this, the mismatch error cancels, flatness errors, error due to resolution bandwidth switching, reference level switching, and internal attenuation cancel out of the measurement equation.

Specification

Table 1

Compression	Conditions	Source
≥ -25 dBm	1 dB compression point	M9361A Data Sheet

Equipment

Table 2

Equipment	Supported Models
Signal Source (3 each)	Agilent E8267D
Signal Analyzer	Agilent E4440A; N9030A
Power Meter	Agilent N1914A; N1912A; E4419B
Hybrid Power Divider	Agilent 87302C
Power Sensor	Agilent N8485A; 8485A
Two resistor power splitter	Agilent 11667B/C
Adaptor, 3.5 mm (m) to Type-N (m)	1250-1743
Adaptor, 3.5 mm (m) to Type-N (f)	1250-1750
Cable, APC 3.5 (3 each)	8120-4921

Test Configuration

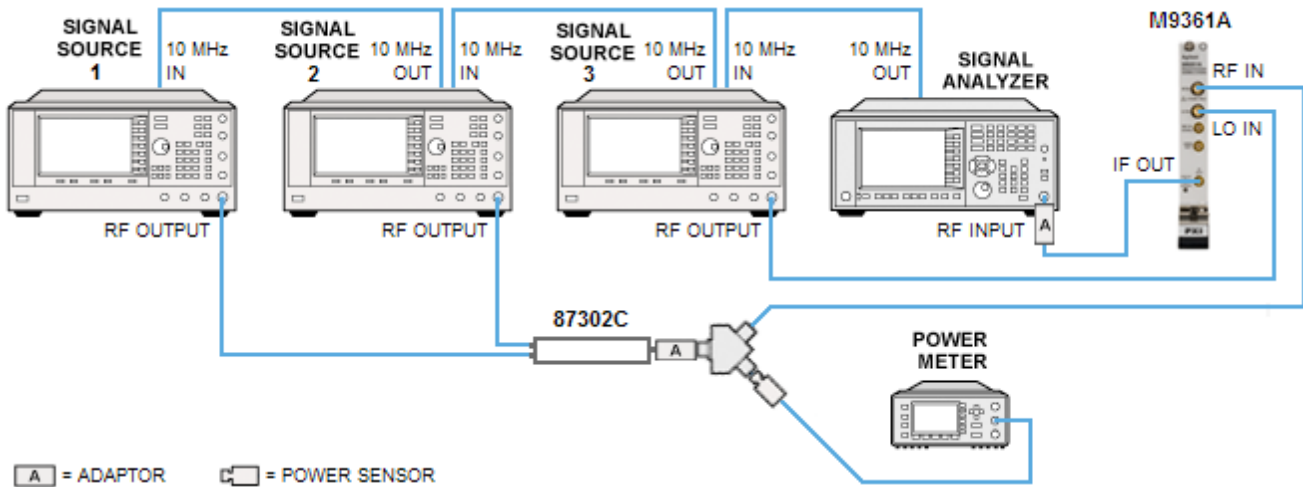

Test Procedure

Test Setup

1. Turn on the power meter (with power sensor connected) and the signal sources and allow all instruments to warm up for 90 minutes.
2. Install the downconverter into the PXI chassis.
3. Turn on the PXI chassis and allow it to warm up for 15 minutes.
4. Preset all equipment.
5. Open the M9361A soft front panels (SFP) and use the default settings to configure the module.
6. Perform a zero and calibration on the power meter
7. Connect the -3 dB ports on the 87302C power divider to the RF OUTPUT ports on signal source 1 and signal source 2 .
8. Connect the RF OUTPUT of signal source 3 to the LO IN port of the downconverter.
9. Connect the signal analyzer RF INPUT to the IF OUT port of the downconverter.
10. Connect the IN port of 87302C power divider to the input of the two-resistor splitter. It is acceptable to make this connection using an RF cable.
11. Connect one output of the two-resistor power splitter to the power sensor.
12. Connect the other output of the two-resistor splitter to the RF IN of the downconverter.
13. Set the power of signal source 1 to -28 dBm and turn on the RF power.
14. Set the power of signal source 2 to -13 dBm and turn on the RF power.
15. Configure the power meter as shown in **Table 3**.

Table 3

Parameter	Value
Filter/Averaging	On
Filter Mode/Meas Avg	Auto
Resolution (display resolution)	4

Performance Verification Tests

- Configure the signal analyzer as shown in **Table 4**.

Table 4

Parameter	Value
Center Frequency	500 MHz
Span	10 Hz
Reference Level	20 dBm
Attenuation	30 dB
Scale	10 dB/div
Resolution Bandwidth	300 Hz
10 MHz Reference	External
Auto Align	Alert

Measurement (record your findings on the Test Record Card – see page 48)

- For each **Low Power Frequency** and **High Power Frequency** in **Table 5**:

Table 5 - Test Points M9361A

Low Power Frequency	High Power Frequency	LO Frequency
2.75 GHz	2.751 GHz	3.25 GHz @+15 dBm
5 GHz	5.001 GHz	5.5 GHz @+15 dBm
9.5 GHz	9.501 GHz	10.0 GHz @+15 dBm
10 GHz	10.001 GHz	3.5 GHz @+15 dBm
15.1 GHz	15.101 GHz	5.2 GHz @+15 dBm
26.497 GHz	26.498 GHz	8.999 GHz @+15 dBm

- Turn off the RF power of signal sources 1 and 2.
- Turn on the RF power of signal source 3.
- Use the signal analyzer to measure the low power signal at the IF OUT port of the downconverter.
- Perform a peak search and set the marker to **Delta Marker**.
- Turn on the RF power of signal source 2 and adjust the RF power level until the delta marker reading reads -1 dB ± 0.05 dB. Record the delta marker reading as P_{Δ} .
- Measure the input power level with the power meter and record as the 1 dB compression point. Record the measured power as P_{abs} .
- Set the power meter frequency to each signal source frequency in **Table 5**.
- Compute the 1 dB compression power level as

$$P_{comp} = (P_{abs} + P_{\Delta} + 1) \text{ dBm}$$

Measurement Uncertainty

The expanded uncertainty of measurement for this test (noted as the “Uncertainty” value provided in the [Test Record Card](#) -- see page 48) represents the standard uncertainty of measurement multiplied by the coverage factor $k=2$. For normal distribution, this corresponds to a coverage probability of approximately 95%.

IF 3 dB Bandwidth Test

Test Method

This test uses a spectrum analyzer to measure relative power to determine the 3 dB bandwidth of the M9361A 2.75 GHz to 26.5 GHz downconverter. For this test, 3 dB IF Bandwidth is defined as the bandwidth between the upper and lower frequencies where the gain is 3 dB lower than the gain measured at the IF center frequency.

Limitations and Considerations

Step Size

This test searches for the 3 dB point by stepping frequency in 1 MHz steps. This effectively sets the resolution of the measurement to 1 MHz. Better resolution is possible for this test, but not necessary. The 1 MHz step size allows for a fast test.

Specification

Table 1

Bandwidth	Conditions	Source
≥ 250 MHz	3 dB Bandwidth	M9361A Data Sheet

Equipment

Table 2

Equipment	Supported Models	Notes
Signal Analyzer	Agilent E4440A; N9030A	
RF signal source	Agilent E8257D; E8267D	
LO signal source	Agilent M9302A; E8257D	If a PSG is used, it must be different from the RF Signal Source
Adaptor, SMB (m) to SMA (f)	Agilent 1250-0674	If necessary
Adaptor, 3.5 mm (f) to Type-N (m)	Agilent 1250-1744	UUT to analyzer
Adaptor 3.5 mm (f) to Type-N (f)	1250-1745	If necessary
Adaptor 3.5 mm (f) to 3.5 mm (f)	1250-1749	If necessary
Cable (3 each)	Agilent 11500E/F, semi-rigid cables are acceptable also.	LO Source to UUT RF Source to UUT UUT IF OUT to Analyzer

Test Configuration

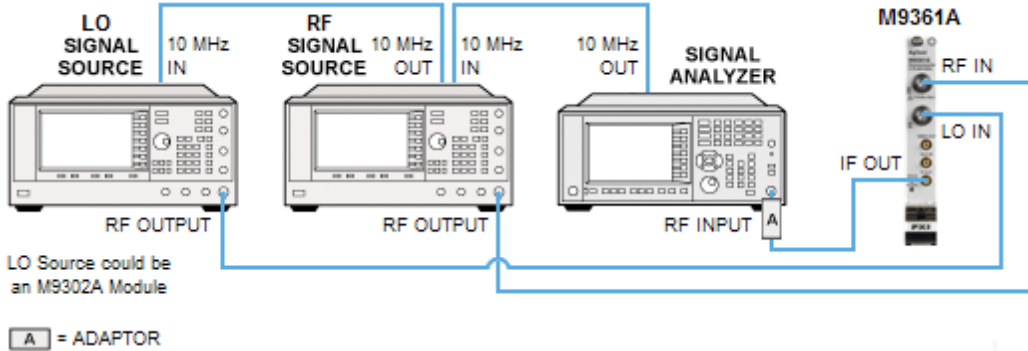

Test Procedure

Test Setup

1. Turn on the signal source and allow for a warm up of 15 minutes.
2. Install the M9361A into the PXI chassis.
3. Turn on the PXI chassis and allow it to warm up for 15 minutes.
4. Preset all equipment.
5. Connect the equipment as shown in Test Configuration diagram above.
 - a. Connect the signal analyzer 10 MHz OUT to the RF signal source 10 MHz IN. Connect the RF signal source 10 MHz OUT to the LO signal source 10 MHz IN.
 - b. Connect the RF OUTPUT of the LO signal source to the LO IN port of the M9361A downconverter.
 - c. Connect the RF OUTPUT of the RF signal source to the RF IN port of the M9361A downconverter.
 - d. Connect the spectrum analyzer to the IF OUT port of the M9361A downconverter.
6. Open the M9361A Soft Front Panel and configure as shown in **Table 3**.

Table 3

Parameter	Value
Center Frequency	2.50 GHz
Input Level	-40 dB
Custom Settings	Unchecked

7. Configure the LO signal source as shown in **Table 4**.

Table 4

Parameter	Value
Center Frequency	3.00 GHz
Amplitude	+16 dBm

8. Configure the RF signal source as shown in **Table 5**.

Table 5

Parameter	Value
Start Frequency	2.3 GHz
Stop Frequency	2.7 GHz
Dwell Time	10 ms
Points	1000
Amplitude	-40 dBm

9. Configure the signal analyzer as shown in **Table 6**.

Table 6

Parameter	Value
Continuous Sweep	Yes
Center Frequency	500 MHz
Input Attenuation	10 dB
Span	400 MHz
Sweep Time	10 ms
Sweep Points	1001
Reference Level	-2 dBm
Scale	1 dB/div
Trace	Max Hold

10. Turn on the RF OUTPUT for both the RF signal source and LO signal source.

Lower 3 dB Point Measurement

1. Wait until at least one source sweep has finished and the filter shape is present on the screen of the signal analyzer.
2. Turn on **Marker 1** and set it to the Center Frequency of the signal analyzer.
3. Set Marker Type as **Delta**.
4. Move the marker to the left until the marker delta displayed is just less than 3 dB.
 - a. Record the marker amplitude as y_1 .
 - b. Record the marker frequency as x_1 .

NOTE: The marker must be one marker step away from the above 3 dB point and the marker delta should be less than 3 dB.

5. Move the marker to the left one step.
 - a. Record the marker amplitude as y_2 .
 - b. Record the marker frequency as x_2 .
6. Calculate the lower 3 dB point frequency, x_{lower} (assuming amplitude of $y = -3$ dB).

Equation 1

$$\frac{y-y_1}{x-x_1} = \frac{y_2-y_1}{x_2-x_1} \quad \text{Solving for } x \text{ yields: (in dB)}$$

Equation 2

$$x = \frac{(y-y_1)}{\left(\frac{y_2-y_1}{x_2-x_1}\right)} + x_1$$

Upper 3 dB Point Measurement

1. Move the marker to the right until the marker delta displayed is just less than 3 dB.
 - a. Record the marker amplitude as y_1 .
 - b. Record the marker frequency as x_1 .

NOTE: The marker must be one marker step away from the above 3 dB point and the marker delta should be less than 3 dB.

2. Move the marker to the right one step.
 - a. Record the marker amplitude as y_2 .
 - b. Record the marker frequency as x_2 .
3. Calculate the upper 3 dB point frequency, x_{upper} (assuming amplitude of $y = -3$ dB).

$$x = x_{offset} + x_1$$

3 dB Bandwidth Calculation

1. Calculate the 3 dB bandwidth using the following equation.

$$B = [x]_{upper} - [x]_{lower}$$

2. Record the bandwidth in the Test Record Card (see page [48](#)).

Measurement Uncertainty

The expanded uncertainty of measurement for this test (noted as the “Uncertainty” value provided in the [Test Record Card](#) -- see page [48](#)) represents the standard uncertainty of measurement multiplied by the coverage factor $k=2$. For normal distribution, this corresponds to a coverage probability of approximately 95%.

IF Video Test

Test Method

This test uses an oscilloscope to measure the DC level of the VIDEO OUT port of the M9361A when -2 dBm is measured at the IF OUT port of the downconverter. Additionally, the input signal is pulse modulated and the rise and falls times are measured.

Limitations and Considerations

Rise Time

Rise time measurements are limited by the rise time of the source pulse modulation. If, in fact, the UUT has exceptionally good rise time, this measurement may actually be measuring the source pulse modulation rise time.

Rise and Fall Time Uncertainty

For this measurement, a good model for how the oscilloscope measures rise and fall time is not available. The measurement is impacted by DC accuracy errors, noise and the oscilloscope's rise and fall time. The oscilloscope rise and fall time exceeds that of the pulses that are measured and does not significantly affect the measurement. The DC accuracy errors for the 10% and 90% measurements are likely correlated, and to a large extent cancel out. Therefore, it is assumed that the most significant error for this measurement is noise. The uncertainty of this measurement is estimated by taking multiple readings. The oscilloscope measurements make available the minimum and maximum values obtained from multiple readings. The standard uncertainty is estimated by assuming that half the range of measured values represents a 3 sigma distribution.

Specification

Table 1

Rise Time	Conditions	Source
≤ 15 ns	IF signal at 500 MHz	M9361A Data Sheet

Table 2

Fall Time	Conditions	Source
≤ 35 ns	IF signal at 500 MHz	M9361A Data Sheet

Table 3

DC Level	Conditions	Source
≥ 1 Volt	-2 dBm IF signal level@ IF OUT port (without pulse modulation)	M9361A Data Sheet

Equipment

Table 4

Equipment	Supported Models
Signal Source (LO) (source 1)	Agilent E8257D; M9302A
Signal Source (RF) (source 2)	Agilent E8257D, Opt UNU or UNW
Oscilloscope	Agilent DSO80104A; DSO8064A
Power Meter	Agilent N1914A; N1912A; E4419B
Power Sensor	Agilent N8485A; 8485A

Test Configuration

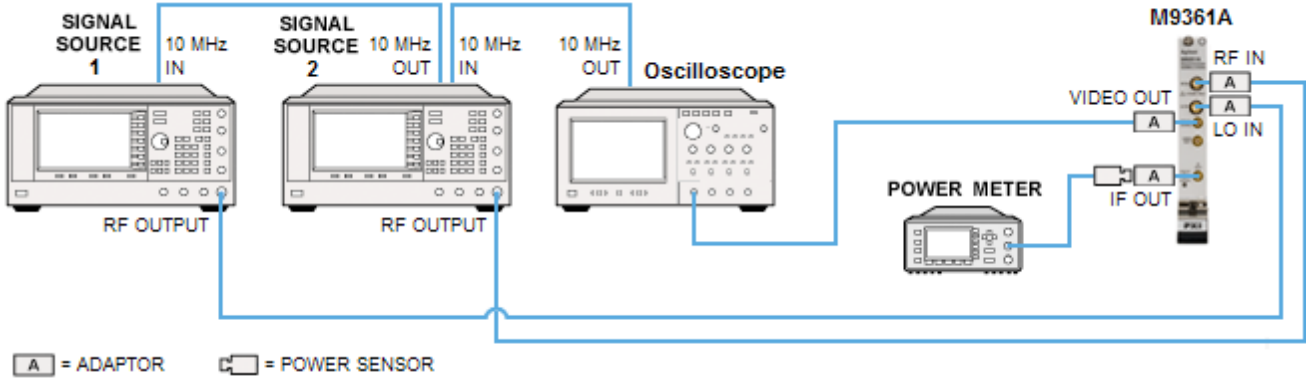

Test Procedure

Test Setup

1. Turn on the signal sources and allow for a warm up of 15 minutes.
2. Install the downconverter into the PXI chassis.
3. Turn on the PXI chassis and allow it to warm up for 15 minutes.
4. Preset all equipment.
5. Perform a zero and calibration on the power meter.
6. Route the 10 MHz REF OUT of signal source 1 to the 10 MHz REF IN ports of the signal analyzer and signal source 2.
7. Connect the RF Output of signal source 1 to the LO IN port of the downconverter.
8. Connect the RF Output of signal source 2 to the RF IN port of the downconverter.
9. Set the power and frequency of signal source 1 to the values for LO Frequency and LO Input Power in **Table 5 - Fixed Test Conditions**.

Table 5 - Fixed Test Conditions

Parameter	Value
RF Input Frequency	10 GHz
LO Frequency	3.5 GHz
LO Input Power	+16 dBm
RF Input Power	-40 dBm
Pulse Width	+250 ns
Pulse Period	500 ns

10. Set the power and frequency of signal source 2 to the values for RF Input Frequency and RF Input Power in **Table 5 - Fixed Test Conditions**.
11. Connect the power sensor to the IF OUT port of the downconverter.
12. Connect the VIDEO OUT port to Channel 1 of the oscilloscope.
13. Configure the power meter as shown in **Table 6**.

Table 6

Parameter	Value
Filter/Averaging	On
Filter Mode/Meas Avg	Auto
Resolution (display resolution)	4

14. Configure the oscilloscope as shown in **Table 7**.

Table 7

Parameter	Value
Vertical Scale	0.5 Volts/div
Vertical Offset	1.5 Volts
Horizontal Scale	20 ns/div
Trigger Mode	Edge
Trigger Source	Channel 1
Trigger Slope	Positive
Trigger Sweep	Auto
Rise Time Measurement	Enabled
Fall Time Measurement	Enabled
Marker A	On
Vrms Measurement	Enabled

15. Configure the oscilloscope Vrms measurement as shown in **Table 8**.

Table 8

Parameter	Value
Source	Channel 1
Measurement Area	Entire display
RMS Type	AC

16. Configure source 1 as shown in **Table 9**.

Table 9

Parameter	Value
Frequency	LO Frequency (Table 5)
Output Level	LO Input Power (Table 5)

17. Configure source 2 as shown in **Table 10**.

Table 10

Parameter	Value
Frequency	RF Frequency (Table 5)
Output Level	RF Input Power (Table 5)

Parameter	Value
Pulse Width	Pulse Width (Table 5)
Pulse Period	Pulse Period (Table 5)
Pulse Modulation	Off

18. Using the Soft Front Panel, configure the downconverter as shown in **Table 11**.

Table 11

Parameter	Value
RF Input Frequency	RF Input Frequency (Table 5)
Input Level	RF Input Level (Table 5)
Custom Settings	Unchecked

19. Turn on the RF Output for both source 1 and source 2.

Measurement (record your findings on the Test Record Card – see page 48)

- Adjust source 2 until the power meter displays $-2 \text{ dBm} \pm 0.25 \text{ dBm}$. Convert the power meter reading to watts:

$$(0.001 \cdot 10^{\frac{P_{dBm}}{10}}) \text{ and record as } P_{out}$$

- On the oscilloscope, press **Clear Display**.
- Measure the IF VIDEO port voltage level with the oscilloscope (using the marker). Record the measured value as V_{OutDC} .
- Using the oscilloscope’s V_{rms} measurement, read the rms voltage and record it as V_{noise} . (This value is used in the determination of the measurement uncertainty.)
- Compute IF VIDEO output voltage as:

$$V = 0.000631 \frac{V_{OutDC}}{P_{out}}$$

- Turn on the pulse modulation on source 2.
- On the oscilloscope, press **Clear Display** and allow the oscilloscope to measure for several seconds.
- Measure the average rise time using the oscilloscope’s rise time measurement. Record the rise time as T_{rise} . Also record the minimum and maximum rise times as $T_{rise.min}$ and $T_{rise.max}$.
- Set the oscilloscope Trigger Slope to Negative.
- On the oscilloscope, press **Clear Display** and allow the oscilloscope to measure for several seconds.
- Measure the average fall time using the oscilloscope’s fall time measurement. Record the fall time as T_{fall} . Also record the minimum and maximum fall times as $T_{fall.min}$ and $T_{fall.max}$.

Measurement Uncertainty

The expanded uncertainty of measurement for this test (noted as the “Uncertainty” value provided in the [Test Record Card](#) -- see page 48) represents the standard uncertainty of measurement multiplied by the coverage factor $k=2$. For normal distribution, this corresponds to a coverage probability of approximately 95%.

LO Leakage at IF Port Test

Test Method

This test measures the LO signal at the IF OUT port of the M9361A, using a signal analyzer. The procedure first measures the signal level of the signal source at each LO frequency. Then, the signal is put through the down-converter and measured again at each frequency. The LO leakage level is determined by adding the difference, in dBm, of the input and output signal levels to an assumed nominal input level of +15 dBm. LO Leakage is defined as:

Equation (1)

$$\text{Leakage} = P_{\text{nom}} + P_{\text{out}} - P_{\text{in}} \text{ (dBm)}$$

where,

P_{nom} = The specified LO input signal level (nominal value is 15 dBm).

P_{out} = The power measured at the IF OUT port.

P_{in} = The measured power applied to the LO IN port.

Limitations and Considerations

Nominal LO Input Level

The current LO input level specification is +15 dBm \pm 2 dB. This represents a significant intrinsic uncertainty associated with the P_{nom} in **Equation (1)**. Since the specification for LO leakage does not indicate a nominal LO input level, it must be assumed that the LO level can have a range of ± 2 dB. Rather than do that, the test will assume the specification is with +15 dBm applied at the LO IN port, rather than a level that can range from +13 dBm to +17 dBm. With this assumption, it will be assumed that the uncertainty of P_{nom} is zero. That is, P_{nom} is a constant value of 15. This assumption must be documented on the measurement report.

Signal Analyzer Assumptions

The signal analyzer is used to measure the gain of the downconverter by making relative power measurements. For this test, the relative power measurement is made at a single frequency without changing the signal analyzer configuration. In this case, flatness errors, error due to resolution bandwidth switching, reference level switching, and internal attenuation cancel out of the measurement equation. What remains are mismatch errors, resolution errors and scale fidelity errors.

Signal analyzer noise is not a significant source of measurement errors given the measured signal levels.

Attenuator Usage

The test uses a fixed 10 dB attenuator to improve the match looking into the signal analyzer. The equivalent match at the attenuator is determined using a worst case cascading mismatch model. For example:

Performance Verification Tests

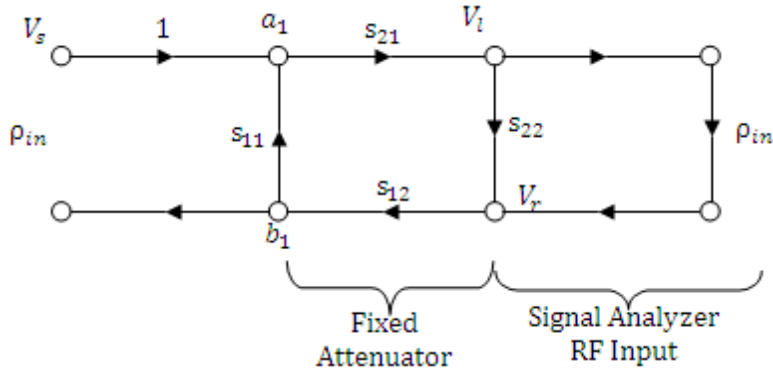

The worst case match looking into this network is evaluated using magnitude-only values.

Equation (2)

$$\rho = \frac{b_1}{a_1} = \frac{s_{11}(1 - s_{22}\rho_{in}) + s_{21}\rho_{in}s_{12}}{(1 - s_{22}\rho_{in})}$$

Specification

Table 1

LO Leakage at IF Output	Conditions	Source
-40 dBm, max	3 to 10 GHz	M9361A Data Sheet

Equipment

Table 2

Equipment	Supported Models
Spectrum Analyzer	Agilent E4440A with option 1DS, 219
RF Signal Source	Agilent E8257D, Opt 1EU; M9302A
Attenuator	Agilent 8493C Opt 010
Adaptor, SMB (m) to SMA (f)	Agilent 1250-0674
Adaptor, SMB (f) to SMB (f)	Agilent 1250-0672
Cable (2 each)	Agilent 8120-4921

Test Configuration

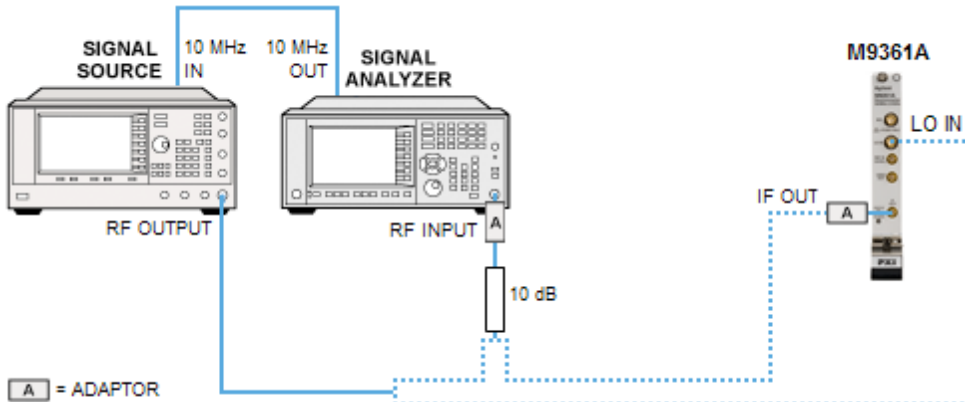

Test Procedure

Test Setup

1. Turn on the signal source and allow it to warm up of 15 minutes.
2. Install the downconverter into the PXI chassis.
3. Turn on the PXI chassis and allow it to warm up for 15 minutes.
4. Preset all equipment.
5. On the signal analyzer, perform an **Auto Align**.
6. Configure the spectrum analyzer as shown in **Table 3**.

Table 3

Parameter	Value	Notes
Center Frequency	3.55 GHz	
Span	5 kHz	
Reference Level	10 dBm	Internal attenuation at 20 dB
Scale	20 dB/div	
Video Bandwidth	3 Hz	
10 MHz Reference	External	
Center Frequency Step Size	500 MHz	Optional, convenient for manual measurements
Auto Align	Alert	

7. Connect the signal analyzer 10 MHz REF OUT port to the 10 MHz REF IN port of the signal source.
8. Connect an RF cable to the signal analyzer input and, on the other end of the cable, connect a 10 dB attenuator.
9. Using a second RF cable, connect the signal source RF OUT port to the 10 dB attenuator. Be sure to use the same RF cable that will later be used to connect the signal source to the downconverter LO IN port.
10. Set the signal source to 3.55 GHz.
11. Set the signal source power to +16 dBm.
Note: The M9302A power is not settable, but is nominally +16 dBm
12. Configure the downconverter as shown in **Table 4**.

Table 4

Parameter	Value	Notes
Input Frequency	2.75 GHz	Note: Downconverter internal gain settings are input frequency dependent.
Input Level	-40 dBm	This automatically sets the internal gain settings of the downconverter.
Custom Settings	Unchecked	

13. Turn on the signal source RF power.

Measurement (record your findings on the Test Record Card – see page 48)

1. For each **Source Frequency** in **Table 5**:

Table 5 - Test Points M9361A

Input Frequency	Source Frequency
2.75 GHz	3.0 GHz
3.5 GHz	4.0 GHz
5.5 GHz	6.0 GHz
7.5 GHz	8.0 GHz
9.5 GHz	10.0 GHz
14.5 GHz	5.0 GHz
20.5 GHz	7.0 GHz
26.5 GHz	9.0 GHz

- a. Turn off the signal analyzer microwave preselector.
 - b. Set the signal analyzer center frequency to the **Source Frequency**.
 - c. Set the signal source frequency to the **Source Frequency**.
 - d. On the signal analyzer, perform a peak search and record the measured value. The measured value corresponds to P_{in} in See "[Equation \(1\)](#)" on page [33](#).
2. Disconnect the 10 dB attenuator and the cable connected to the signal source from each other. Do not disconnect the 10 dB attenuator from the cable connected to the signal analyzer, nor either cable from the signal source or the signal analyzer.
 3. Connect the cable from the signal source to the LO IN port of the downconverter.
 4. Using the SMA and SMB adaptors, connect the 10 dB attenuator to the IF OUT port of the downconverter.
 5. For each row in **Table 5**:
 - a. Set the signal analyzer center frequency to the **Source Frequency**.
 - b. Set the signal source frequency to the **Source Frequency**.
 - c. Set the downconverter Input Frequency to **Input Frequency**.
 - d. On the signal analyzer, perform a peak search and record the measured value. The measured value corresponds to P_{out} in See "[Equation \(1\)](#)" on page [33](#).
 6. Determine the LO Leakage using See "[Equation \(1\)](#)" on page [33](#), assuming the value for P_{nom} is +15 dBm.

Measurement Uncertainty

The expanded uncertainty of measurement for this test (noted as the “Uncertainty” value provided in the [Test Record Card](#) -- see page [48](#)) represents the standard uncertainty of measurement multiplied by the coverage factor $k=2$. For normal distribution, this corresponds to a coverage probability of approximately 95%.

Third Order Intercept (TOI) Test

Test Method

This test characterizes the Agilent M9361A downconverter third order intermodulation characteristics. Two signals separated in frequency by 1 MHz, and at approximately -40 dBm (referred to as the reference power below) are applied to the downconverter input. A signal analyzer is used to measure the difference, in dB, between the signal measured at the output and the signal level of the third order intermodulation signal also measured at the output of the downconverter. The third order intercept is the theoretical point at which the third order intermodulation signal power level would equal the input signals as the two input signals power level is increased, referenced to the input signal levels.

The Third Order Intercept is defined as:

$$TOI = \frac{P_{\Delta}}{2} + P_{ref} \text{ dBm}$$

where:

P_{Δ} = the power difference, in dB, between the reference power level and the third order intermodulation power level.

P_{ref} = the reference power established by the downconverter specification.

Limitations and Considerations

Delta Powers

When measuring TOI, four signals are present in close proximity; the two input signals (f_1, f_2) and two signals due to third order intermodulation (f_3, f_4). All four signals are separated by 1 MHz.



The intermodulation signal results from one of the input signals mixing with the second harmonic of the other input signal. That is, $f_3 = 2f_1 - f_2$ and $f_4 = 2f_2 - f_1$. For small changes in power of an input signal, the second harmonic power level changes at two times the rate, on a dB scale. Therefore, for equally small changes in both input signals, the intermodulation signals change at 3 times the rate. This is due to a 2 dB per dB change of the second harmonic power level and an additional dB per dB change in the signal level that mixes with the second harmonic.

The TOI definition assumes the input signals to be precisely at the reference power level. Of course, when making the measurement, the input signals are always at slightly different power levels. Offset from the reference is not an issue for the signal that mixes with the second harmonic signal since the change in signal level of the intermodulation level changes 1 dB per dB with this mixing signal. Therefore, when determining TOI from f_3 (that is, TOI_{lower}) $P_{\Delta} = P_2 - P_3$. Likewise, when determining TOI from f_4 (that is, TOI_{upper}), then $P_{\Delta} = P_1 - P_4$. Because of the 1 dB per dB change, P_{Δ} is independent of the absolute power level.

Absolute Power Levels

TOI is a theoretical absolute power level. Therefore, one of the two input signal levels must be known relative to an absolute power. For this test, f_1 for the lower TOI and f_2 for the upper TOI is used. The absolute power setting is established using a power meter. The power level is set as close to the reference power (-40 dBm) as is practical. The difference between the set power (as measured by the power meter) and the reference power is referred to as P_{err} . That is, $P_{err} = P_m - P_{ref}$ where P_m is the measured power of the input signals (P_L for the lower frequency signal and P_U for the upper frequency signal). The effect of P_{err} is to cause a two-dB per dB error in P_{Δ} . Therefore, when calculating TOI, P_{err} is accounted for as:

$$TOI = \frac{P_{\Delta} + 2P_{err}}{2} + P_{ref} \text{ dBm}$$

Substituting P_{err} in the above equation, the upper and lower TOI measurements are:

$$TOI_{lower} = \frac{P_2 - P_3}{2} - (P_L + A) + 2P_{ref} \text{ dBm}$$

and

$$TOI_{upper} = \frac{P_1 - P_4}{2} - (P_U + A) + 2P_{ref} \text{ dBm}$$

where,

- P_1 Is the power level measured by the signal analyzer of input signal f_1 .
- P_2 Is the power level measured by the signal analyzer of input signal f_2 .
- P_3 Is the power level measured by the signal analyzer of the lower intermodulation signal.
- P_4 Is the power level measured by the signal analyzer of the upper intermodulation signal.
- P_L Is the measured input level of signal f_1 .
- P_U Is the measured input level of signal f_2 .
- P_{ref} Is the reference power established by the downconverter specification.

Attenuator Usage

The test uses two fixed attenuators. The 10 dB attenuator is used to improve the match looking back into the power divider. The 20 dB attenuator has two roles. First, the power (at -40 dBm) is too low to easily measure with a power meter. Instead the power measured at the power sensor is -20 dBm and that level is reduced by the 20 dB fixed attenuator to deliver -40 dBm to the downconverter. In addition, the 20 dB attenuator improves the match looking into the downconverter input port. The equivalent match at the attenuators is determined using a worst case cascading mismatch model. For example,

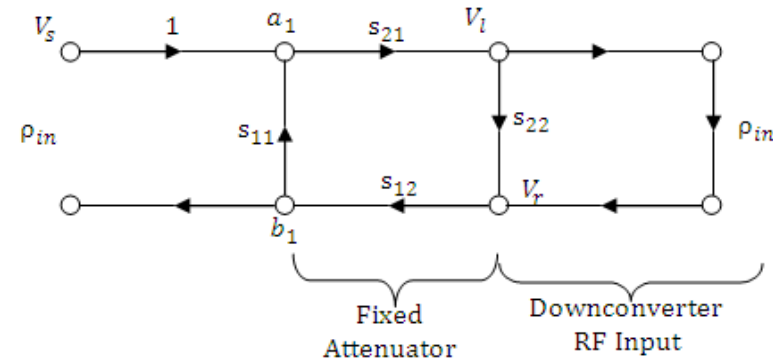

The worst case match for this network is,

$$\rho = \frac{b_1}{a_1} = \frac{s_{11}(1 - s_{22}\rho_{in}) + s_{21}\rho_{in}s_{12}}{(1 - s_{22}\rho_{in})}$$

evaluated using magnitude-only values.

Attenuator Accuracy

The dominate source of error in this measurement is the 20 dB attenuation accuracy. Implementing this test to use calibration data for the 20 dB fixed attenuator can result in a significantly lower measurement uncertainty.

Signal Analyzer Assumptions

The signal analyzer is used to make relative power measurements. For this test, it is assumed that because of the closeness of the measured signals (that is, 2 MHz) that mismatch and signal analyzer flatness are insignificant sources of measurement error. Specifically, the mismatch error cancels when taking the ratio of the two measurements as does the flatness error.

In addition, error due to resolution bandwidth switching, reference level switching, and internal attenuation cancel out of the measurement equation as all these settings remain constant between measurements.

Signal Analyzer TOI

The signal analyzer used to measure the third order intermodulation signals generated in the downconverter will also generate third order intermodulation signals. However, with 30 dB of internal input attenuation, the signal levels at the first mixer are low enough that the signal analyzer's contribution to TOI is insignificant.

Specification

Table 1

3rd Order Intercept Point (TOI)	Conditions	Source
≥ -10 dBm	Two -40 dBm RF input tones, 1 MHz apart referenced to the module input	M9361A Data Sheet

Equipment

Table 2

Equipment	Supported Models
Spectrum Analyzer	Agilent E4440A
RF Signal Source (3 each)	Agilent E8257D
Hybrid Power Divider	Agilent 87302C
Fixed Attenuator	Agilent 8493C Opt 20
Fixed Attenuator	Agilent 8493C Opt 10
Power Meter	Agilent N1914A; N1912A; E4419B
Power Sensor	Agilent N8485A; 8485A
Adaptor. 3.5 mm (m) to 3.5 mm (m)	Agilent 83059A

Test Configuration

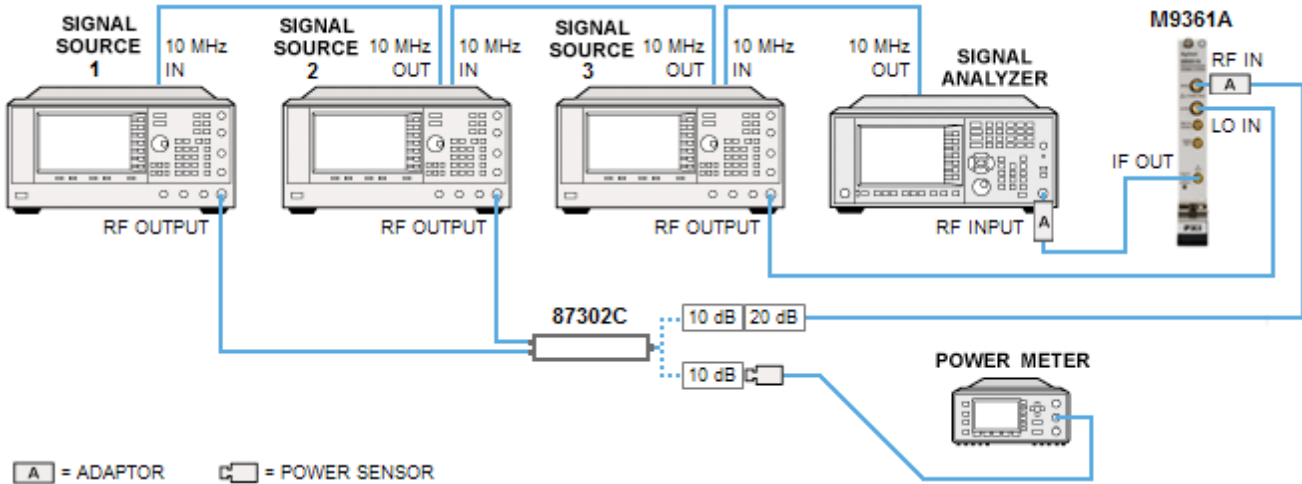

Test Procedure

Test Setup

1. Turn on the power meter (with power sensor connected) and the signal sources, and allow them to warm up for 90 minutes.
2. Install the downconverter into the PXI chassis.
3. Turn on the PXI chassis and allow it to warm up for 15 minutes.
4. Preset all equipment.
5. Configure the power meter as follows:

Table 3

Parameter	Value
Filter/Averaging	On
Filter Mode/Meas Avg	Auto
Resolution (display resolution)	4

6. Perform a zero and calibration on the power meter.
7. Connect both **-3 dB** ports of the power divider to the signal source 1 and signal source 2 RF OUTPUT.
8. Connect the RF OUTPUT of signal source 3 to the LO IN port of the downconverter.
9. Connect the signal analyzer RF INPUT to the IF OUT port of the downconverter.
10. Connect the 10 dB fixed attenuator to the **IN** port of the power divider.
11. Connect the power meter sensor to the open end of the 10 dB fixed attenuator.
12. Set the power of signal source 1 to -10 dBm and turn on the RF power.
13. Set the power of signal source 2 to -10 dBm and leave RF power off.
14. For each Lower Frequency listed in **Table 5**, adjust source 1 power until the power meter reads -20 dBm ±0.1 dBm. Record the output power setting of signal source 1 as “Source 1 Setting” and the measured power level (at the power meter) as “P_L” in the Power Readings table in the Test Record Card (see page 48).

15. Turn the RF power of signal source 1 off and turn the RF power of signal source 2 on.
16. For each Upper Frequency listed in **Table 5**, adjust source 2 power until the power meter reads $-20 \text{ dBm} \pm 0.1 \text{ dBm}$. Record the output power setting of signal source 2 as “Source 2 Setting” and the measured power level (at the power meter) as “ P_U ” in the Power Readings table in the Test Record Card (see page [48](#)).
17. Disconnect the power sensor from the 10 dB fixed attenuator connected to the power divider and connect the 20 dB attenuator to the open end of the 10 dB fixed attenuator.
18. Connect the open end of the 20 dB attenuator to the RF IN port of the downconverter using the 3.5 mm male-to-male adaptor.
19. Turn on the RF power output of signal sources 1 and 2.
20. Configure the signal analyzer as follows:

Table 4

Parameter	Value	Notes
Center Frequency	500 MHz	
Span	5 Hz	
Reference Level	0 dBm	
Attenuation	30 dB	Ensures low enough power to the signal analyzer mixer that the signal analyzer's own TOI does not affect the measurement.
Scale	10 dB/div	
Resolution Bandwidth	47 Hz	Auto-coupled
Video Bandwidth	3 Hz	
10 MHz Reference	External	
Center Frequency Step Size	1 MHz	Optional (convenient for manual measurements)
Auto Align	Alert	

21. If it has not been done in the previous 24 hours, perform an **Align All** on the signal analyzer.

Measurement (record your findings on the Test Record Card – see page [48](#))

1. For each set of frequencies listed in **Table 5**:

Table 5 - Test Points for M9361A

Lower Frequency	Upper Frequency	LO Frequency (at +16 dBm)
2.75 GHz	2.751 GHz	3.25 GHz
5 GHz	5.001 GHz	5.5 GHz
9.5 GHz	9.501 GHz	10.0 GHz
10 GHz	10.001 GHz	3.5 GHz
15.1 GHz	15.101 GHz	5.2 GHz
26.497 GHz	26.498 GHz	8.999 GHz

Performance Verification Tests

- a. Open the M9361A soft front panel (SFP) and set the Input Frequency to the Lower Frequency.
- b. Set source 1 to the Lower Frequency and set source 2 to the Upper Frequency.
- c. Set the power level of source 1 and source 2 to the power settings (“Source 1 Setting” and “Source 2 Setting”, as recorded in the Test Record Card during test setup steps 14 and 16) to deliver a -20 dBm signal at the output of the power divider and the 10 dB fixed attenuator.
- d. For each frequency in **Table 5** (Lower, Upper, and LO), set the signal analyzer center frequency to the following IF frequencies: f_3 (501 MHz), f_1 (500 MHz), f_2 (499 MHz), and f_4 (498 MHz). Record the respective signal levels (P_3 , P_1 , P_2 , and P_4) in the Power Readings table in the Test Record Card (see page 48).
- e. The lower and upper TOI points are calculated for you in the Test Record Card PDF. The equations for these values are as follows:

$$TOI_{lower} = \frac{P_2 - P_3}{2} - (P_L + A) + 2P_{ref} \text{ dBm}$$

and

$$TOI_{upper} = \frac{P_1 - P_4}{2} - (P_U + A) + 2P_{ref} \text{ dBm}$$

where P_{ref} is -40 dBm and A is the nominal attenuation (-20 dBm) of the fixed attenuator inserted at the signal analyzer input.

Measurement Uncertainty

The expanded uncertainty of measurement for this test (noted as the “Uncertainty” value provided in the [Test Record Card](#) -- see page 48) represents the standard uncertainty of measurement multiplied by the coverage factor $k=2$. For normal distribution, this corresponds to a coverage probability of approximately 95%.

Service

This section provides reference information and procedures to help you service your Agilent M9361A .

In this section:

- [Replaceable Parts](#) (page 43)
- [Module Core Replacement](#) (page 44)
- [Test Record Card](#) (page 48)

Replaceable Parts

Where Used	Cable Reference Designator	Agilent Part Number	Description
Accessory Hardware	n/a	5023-1450	Wrench, socket, 5/16 inch
Accessory Hardware	n/a	5002-3361	SMB/MMCX Removal Tool
All PXI Modules	n/a	1440-0655	Injector/Ejector assembly
M9361A IF OUT to M9202A INPUT 1	C3	8120-5531	Cable, SMB - SMA coaxial (190 mm)
M9302A REF 2 OUT to M9202A REF IN	C4	8121-2042	Cable, A06/A32 80G (SMB – MMCX)
M9351A REF IN to M9302A REF 2 OUT	B1	8120-5016	Cable, coaxial. SMB-SMB (160 mm)
M9351A IF OUT to M9361A AUX IN	B2	8121-2072	Cable, coaxial, SMB-SMB (75 mm)
M9302A LO OUT to M9360A LO IN	A1	M9360-20001	Cable, semi-rigid, Master LO
M9360A RF 1 OUT to M9351A RF IN	A2	M9351-20001	Cable, semi-rigid, SMA-SMA
M9360A RF 2 OUT to M9361A RF IN	A3	M9361-20001	Cable, semi-rigid SMA-SMA
M9360A LO 2 OUT to M9361A LO IN	A4	M9361-20002	Cable, semi-rigid SMA-SMA
M9360A LO 1 OUT to M9351A LO IN	A5	M9351-20002	Cable, semi-rigid SMA-SMA
M9361A PXI Downconverter 2.75 GHz to 26.5 GHz	n/a	M9361-60003	PXI Downconverter 2.75 GHz to 26.5 GHz replacement core assembly
M9361A PXI Downconverter 2.75 GHz to 26.5 GHz	n/a	M9361-69003	PXI Downconverter 2.75 GHz to 26.5 GHz replacement core assembly EXCHANGE

Module Core Replacement

Ordering a core replacement module

1. Contact Agilent (see www.agilent.com/find/assist).
2. Order a core replacement for your module (part number M9361-60003).
3. When the core replacement arrives, the package includes:
 - Entitlement Certificate
 - Replacement module
 - Calibration certificate for the replacement module
 - RMA number
 - Return instructions

Replacing the defective module

CAUTION Before opening a packaged module for troubleshooting, ensure that all ESD (electrostatic discharge) precautions are observed. Refer to [ESD](#) (page 10) for details.

1. Power down the chassis.
2. Remove the defective module from the chassis.
3. Write down the serial number shown on the side shield of the defective module. You will assign this serial number to the replacement module using the Agilent M9392A Serial Number Update Utility.

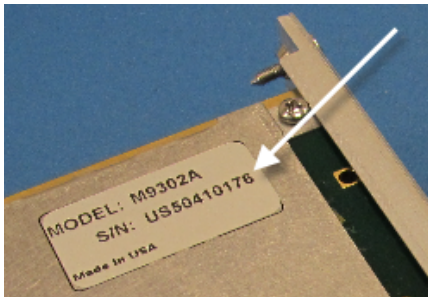

4. Remove the replacement module from the box and shipping material.

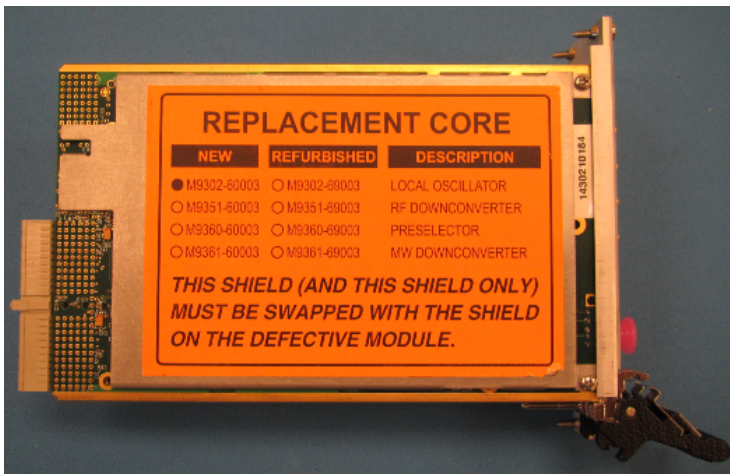

5. Remove the side shield from the defective module.
 - a. Using a Philips #1 (PH1) screwdriver, remove the two screws that secure the side shield to the module. **NOTE: Keep the screws**; extra screws are not included with the replacement module.

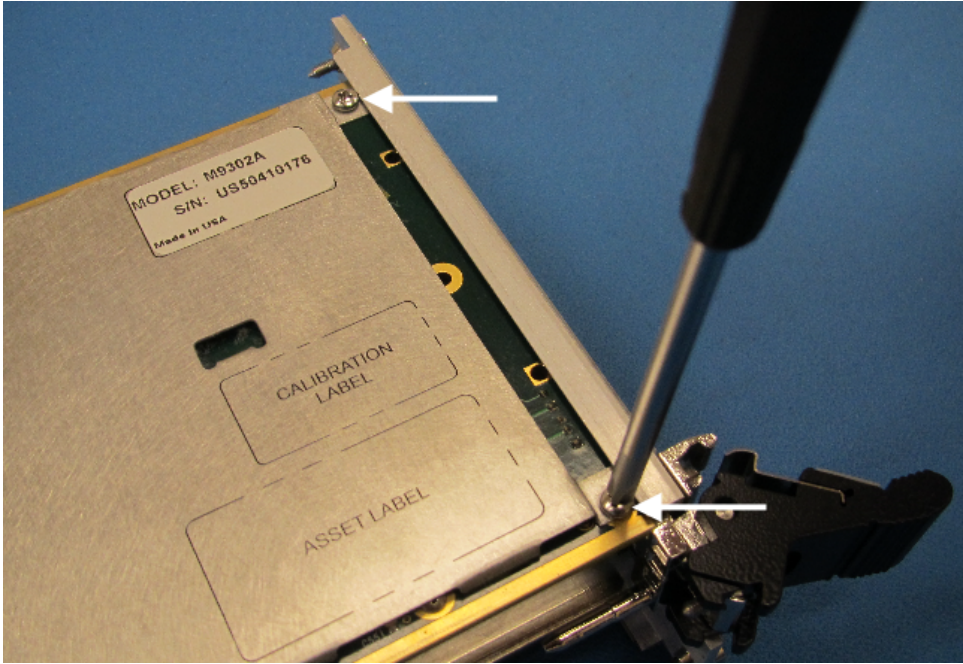

- b. Slide the shield toward the module's front panel. This aligns the engagement tabs so you can remove the shield.

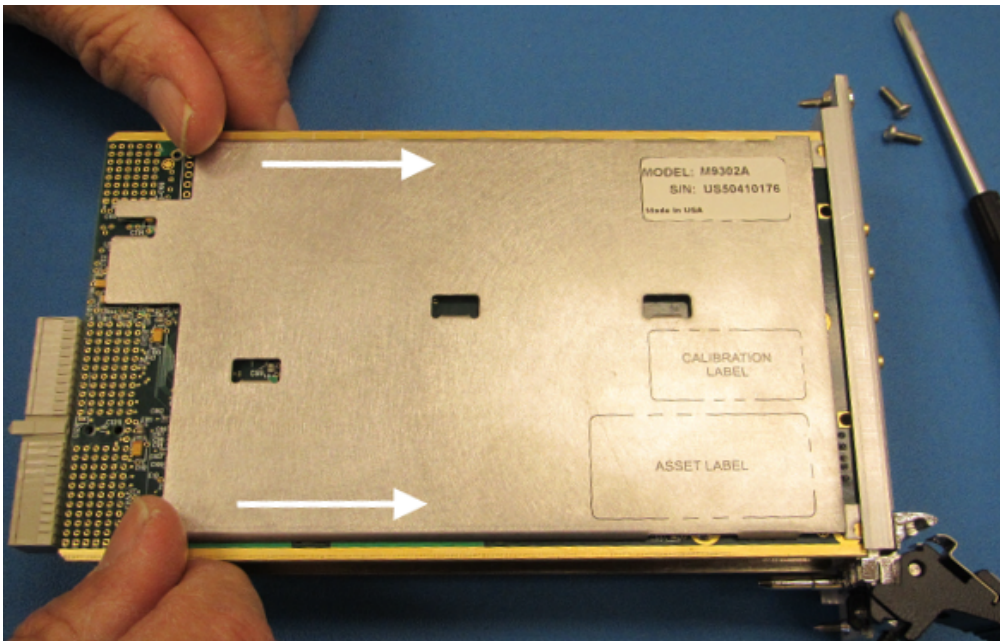

- c. Raise the side shield and lift it away from the module.

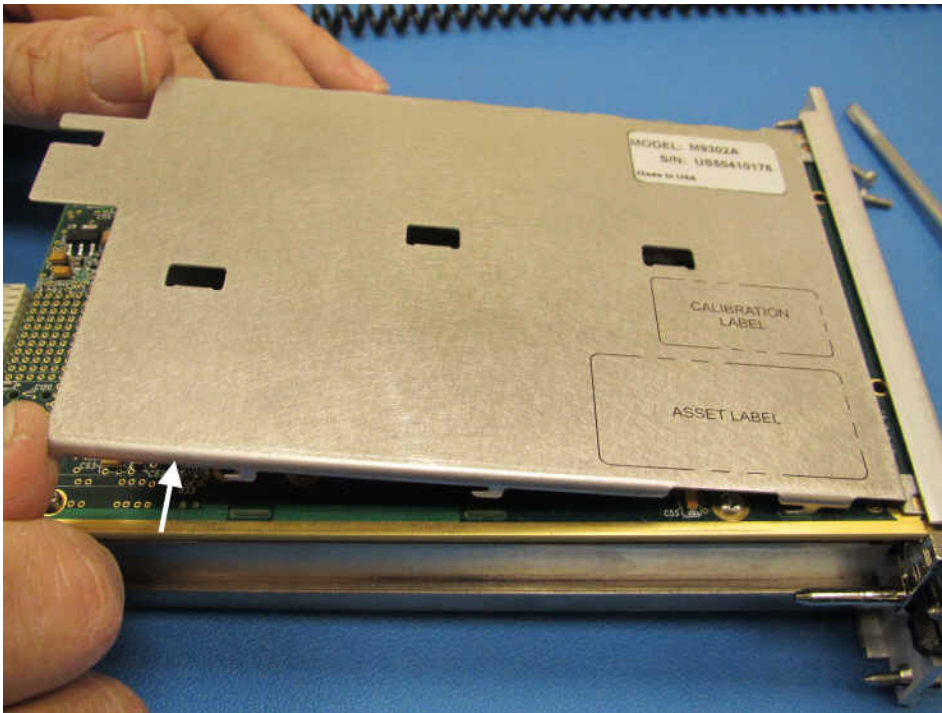

- 6. Remove the side shield from the replacement module, using the same process as in Step 5 above.
- 7. Attach the original side shield from the defective module to the replacement module.
 - a. Position the side shield so that the screw tabs align with the screw holes on the module, and then slide the side shield against the front panel.

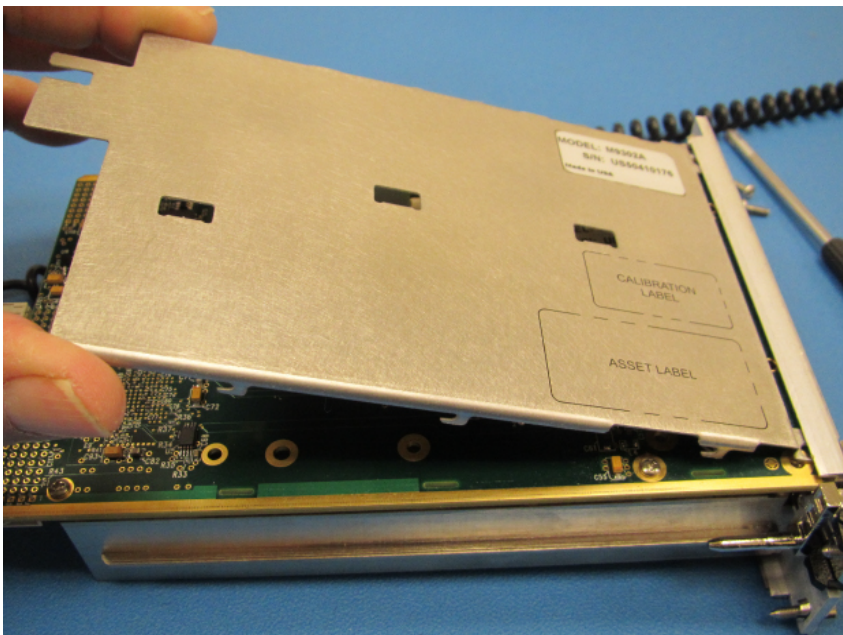

- b. Lower the side shield so the engagement tabs drop into the slots on the module's printed circuit board.

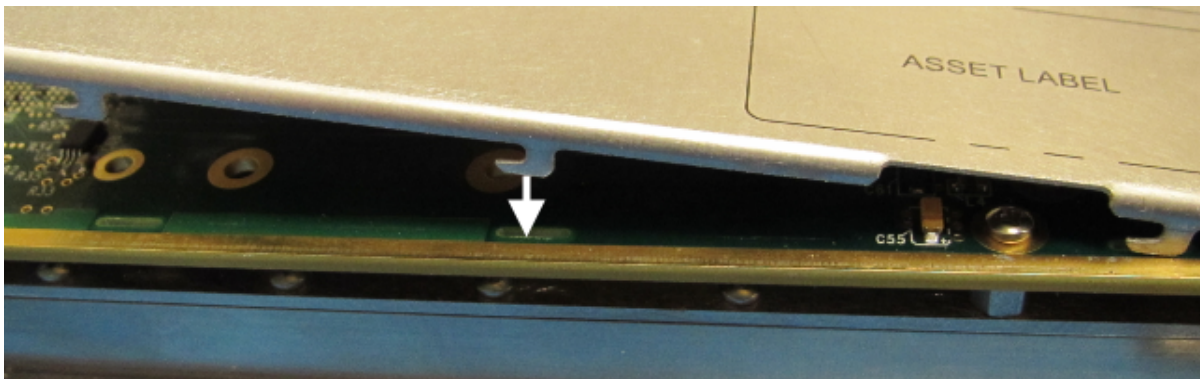

- c. Back the side shield away from the front panel to align the screw holes.

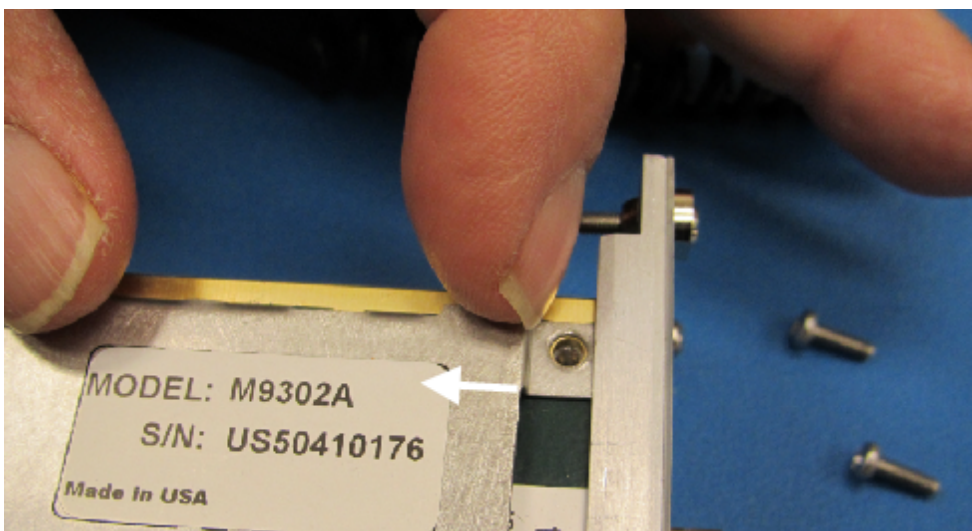

- d. Install the two screws to secure the side shield to the module.
8. Install the replacement module into the chassis.
 9. Power up the chassis.
 - a. If you are using a remote controller, power up the computer. (If you are using an embedded controller, skip to Step 10.)
 10. Program the replacement module with the serial number from the defective module.
 - a. If you don't already have the Agilent M9392A Serial Number Update Utility, download it from www.agilent.com/find/M9392A (from this site, select **Support Center > Drivers, Updates & Examples**), and install it on your computer or embedded controller.
 - b. Launch the Agilent M9392A Serial Update Utility (launch from the **Start menu** program group "**Agilent Utilities**") and follow the embedded instructions for programming the serial number.

11. Attach the side shield from the replacement module to the defective module, and return it to Agilent according to the following procedure:
 - a. Review the warranty information shipped with your product.
 - b. Write the following information on a tag and attach it to the malfunctioning equipment:
 - Name and address of owner. A P.O. box is not acceptable as a return address.
 - Product model number (for example, M9361A).
 - Product serial number. The serial number label is located on the side panel of the module. The serial number can also be read from the Soft Front Panel interface, but only after the hardware is installed.
 - Description of failure or service required.
 - Return Material Authorization (RMA) number.
 - c. Pack the module in its original ESD bag and packing carton. If the original carton is not available, use bubble wrap or packing peanuts and place the instrument in a sealed container and mark the container "FRAGILE".
 - d. On the shipping label, write ATTENTION REPAIR DEPARTMENT and the RMA number.

NOTE

If any correspondence is required, refer to the product by serial number and model number.

Test Record Card

Agilent has provided a Test Record Card you can use to record your findings as you conduct performance verification tests. Click the link below to open the Test Record Card (a PDF form). Save the file to your hard drive and fill in as needed to record your test results.

[Open Test Record Card](#)



TIP: Use Ctrl/click to open the Test Record Card as a separate document.



The Modular Tangram

The four-sided geometric symbol that appears in Agilent modular product literature is called a tangram. The goal of this seven-piece puzzle is to create shapes—from simple to complex. As with a tangram, the possibilities may seem infinite as you begin to create a new test system. With a set of clearly defined elements—hardware, software—Agilent can help you create the system you need, from simple to complex.

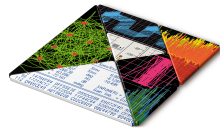

DISCOVER the Alternatives ...

... Agilent **MODULAR** Products



Agilent Advantage Services is committed to your success throughout your equipment's lifetime.
www.agilent.com/find/advantageservices



Agilent Email Updates keep you informed on the latest product, support and application information.
www.agilent.com/find/emailupdates



Agilent Channel Partners provide sales and solutions support. For details, see
www.agilent.com/find/channelpartners



ISO 9001:2008 certified. For details, see
www.agilent.com/quality



PICMG and the PICMG logo, CompactPCI and the CompactPCI logo, AdvancedTCA and the AdvancedTCA logo are US registered trademarks of the PCI Industrial Computers Manufacturers Group. "PCIe" and "PCI EXPRESS" are registered trademarks and/or service marks of PC-SIG. Microsoft, Windows, Visual Studio, Visual C++, Visual C#, and Visual Basic are either registered trademark or trademarks of Microsoft Corporation.

Product descriptions in this document are subject to change without notice.

© Agilent Technologies, Inc. 2010-2013

www.agilent.com

www.agilent.com/find/modular

www.agilent.com/find/M9361A

For more information on Agilent Technologies' products, applications or services, please contact your local Agilent office. (For additional listings, go to www.agilent.com/find/assist.)

Americas

Canada	(877) 894 4414
Brazil	(11) 4197 3500
Mexico	01800 5064 800
United States	(800) 829 4444

Asia Pacific

Australia	1 800 629 485
China	800 810 0189
Hong Kong	800 938 693
India	1 800 112 929
Japan	0120 (421) 345
Korea	080 769 0800
Malaysia	1 800 888 848
Singapore	1 800 375 8100
Taiwan	0800 047 866
Thailand	1 800 226 008

Europe & Middle East

Austria	43 (0) 1 360 277 1571
Belgium	32 (0) 2 404 93 40
Denmark	45 70 13 15 15
Finland	358 (0) 10 855 2100
France	0825 010 700 (0.125 €/minute)
Germany	49 (0) 7031 464 6333
Ireland	1890 924 204
Israel	972 3 9288 504 / 544
Italy	39 02 92 60 8484
Netherlands	31 (0) 20 547 2111
Spain	34 (91) 631 3300
Sweden	0200 88 22 55
Switzerland	0800 80 53 53
United Kingdom	44 (0) 118 9276201



Agilent Technologies